



Automation Organizer



Wind0/I-NV4

User's Manual

Confirm that the delivered product is what you have ordered. Read this manual to make sure of correct operation.

SAFETY PRECAUTIONS

- Be certain to read this manual carefully before performing installation, wiring, or maintenance work, or operating the HG2J-7U, HG5G/4G/3G/2G-V, HG4G/3G, HG2G-5F/-5T, HG1G/1P (Hereinafter referred to as "MICRO/I").
- The MICRO/I has been manufactured with careful regard to quality. However, if you intend to use this product in applications where failure of this equipment may result in damage to property or injury, ensure that it is used in conjunction with appropriate fail-safe backup equipment.
- Precautionary measure should be taken to avoid unauthorized access from the outside network to the MICRO/I. Please note that the Company shall not be liable for any loss, damage or other expenses incurred directly or indirectly by unauthorized access, etc.
- In this manual, safety precautions are categorized depending on the severity as Warning or Caution:

 WARNING	Warning notices are used to emphasize that improper operation may cause severe personal injury or death.
 CAUTION	Caution notices are used where inattention might cause personal injury or damage to equipment.

WARNING

MICRO/I (Common to all models):

- The MICRO/I is not designed for use in applications requiring a high degree of reliability and safety, such as applications for medical devices, nuclear power, railroads, aerospace, and automotive devices. The MICRO/I should not be used for such applications.
- Turn off the power of the MICRO/I before installation, removal, wiring, maintenance, and inspection of the MICRO/I. Failure to turn power off may cause electrical shock or fire hazard.
- Special expertise is required to install, wire, configure, and operate the MICRO/I. Person without such expertise must not use the MICRO/I.
- The MICRO/I uses an LCD (liquid crystal display) as a display device. The liquid inside the LCD is harmful to the skin. If the LCD is broken and the liquid attaches to your skin or clothing, wash the liquid off using soap, and consult a doctor immediately.
- An emergency circuit that uses emergency stop switch must be configured outside of the MICRO/I.
- Do not use touch switches, the function keys and selector switches for an emergency circuit or an interlocking circuit. If the MICRO/I fails, equipment connected to the MICRO/I will no longer be protected, and serious injury to operators and equipment damage may be caused.
- In case the MICRO/I is accidentally dropped or exposed to significant shock, stop using the MICRO/I, check the MICRO/I for damage, and confirm that its various functions work safely and correctly.
- Connect MICRO/I's FG wire to grounding resistance of 100 Ω or less. Otherwise, there is a risk of electric shock or malfunction.
- The screen will not be visible if the backlight of the MICRO/I burns out. However, the touch panel and the function keys will remain functional. Thus, Erroneous touch panel operation or function key operation may occur while controlling the touch panel. Because such erroneous operations could result in damage, the touch panel and the function key should not be used once the backlight is burned out.

HG5G/4G/3G/2G-V, HG4G/3G, HG2G-5F/-5T, HG1G/1P:

- When more than one panel spot is pressed at the same time, due to the detection mechanism of the analog type touch panel used in the main unit, the unit assumes that only the center of the pressed spots is sensed and the unit assumes that only one button is pressed. Therefore, do not operate the MICRO/I by pressing more than one button simultaneously.

HG1P:

- For the emergency stop switch and the enabling switch on the main unit, note the following points:
 - Connect the emergency stop switch to function as either a category 0 or category 1 stop in accordance with EN60204-1.
 - Perform regular checks to confirm that the emergency stop switch and enabling switch work properly. It is extremely dangerous if the enabling switch no longer returns to position 1 due to a foreign object getting stuck in the switch.
 - Do not, under any circumstances, hold the enabling switch in position 2 with tape, string, or deform the rubber cover. The function of the enabling switch will be lost, and the enabling switch may not work in an emergency.
 - Place your finger firmly on the enabling switch.
- The emergency stop function is disabled when main unit is removed from the machine. To eliminate the possibility of accidents caused by operating the disabled emergency stop switch, place the main unit, removed from the machine, in a location that is not visible to the operator. Install at least one emergency stop switch on the machine near the location where the HG1P is connected.

MICRO/I (Common to all models):

- Prevent the MICRO/I from falling while moving or transporting, otherwise it may cause damage or malfunction to the MICRO/I as a result.
- Use the product within the environmental limits given in the catalog and manual. Use of the product in high-temperature or high-humidity environments, or in locations where it is exposed to condensation, corrosive gas, or large shock loads can create the risk of electrocution and fire.
- The MICRO/I is designed for use in pollution degree 2. Use the MICRO/I in environments of pollution degree 2. (based on the IEC60664-1 rating)
- Install the MICRO/I according to the instructions. Improper installation will result in falling, failure, electrical shock, fire hazard, or malfunction of the MICRO/I.
- Prevent metal fragments or wire chips from dropping inside the MICRO/I housing. Ingress of such fragments and chips may cause fire hazard, damage, and malfunction.
- Use a power supply of the rated value. Using a wrong power supply may cause fire hazard.
- When exporting the MICRO/I to Europe, use an EN60127 (IEC60127) approved fuse on the power line outside the MICRO/I.
- When exporting the MICRO/I to Europe, use an EU-approved circuit protector.
- Make sure of safety before starting and stopping the MICRO/I. Incorrect operation of the MICRO/I may cause mechanical damage or accidents.
- The touch panel of the MICRO/I is made of glass, and will break if exposed to excessive shock. Take due care when handling it.
- The protective film attached to the display of the MICRO/I is to protect the product from scratches during transportation. Please remove the protective film before use. If the display is used with protective film, the film may become cloudy and stick to the display depending on the usage environment and may become unremovable.
- Do not push hard or scratch the touch panel and protection sheet with a hard object like hand tool. Touch panel and protection sheet can be easily damaged.
- Do not install the MICRO/I in areas subjected to strong ultraviolet rays, since ultraviolet rays may impair the quality of the LCD.
- Do not attempt to disassemble, repair or modify the MICRO/I. This can create the risk of fire or electrocution.
- When disposing of the MICRO/I, do so as an industrial waste.
- Do not switch off the power or pull out the SD Memory Card or the USB flash drive while it is being accessed, as this may result in destruction of the stored data. If the data on the SD Memory Card or the USB flash drive is corrupted, format the SD Memory Card or the USB flash drive.
- Turn off the power supply of the MICRO/I before connecting or disconnecting USB devices other than USB memory.

HG2J-7U:

- The main unit uses "PS2 of EN61131" as DC power supply. (based on the IEC/EN61131 rating)
- Use wire of a proper size to meet the voltage and current requirements.

HG5G/4G/3G/2G-V, HG4G/3G, HG2G-5F/-5T, HG1G/1P:

- There is no function to correct the time. Do not use device beyond the rated operating temperature, otherwise the clock accuracy will be affected.

HG5G/4G/3G/2G-V, HG4G/3G, HG2G-5F/-5T, HG1G:

- The main unit uses "PS2 of EN61131" as DC power supply. (based on the IEC/EN61131 rating) Use wire of a proper size to meet the voltage and current requirements, and tighten the terminal screws of the main unit to the specified tightening torque.

HG5G/4G/3G/2G-V, HG4G/3G, HG2G-5F:

- Be sure to confirm that the SD Memory Card Access lamp is not lit prior to turning the power off to the main unit or pulling out the SD memory card. Refer to this manual for details.

HG1P:

- Use the HG1P optional cable for proper wiring.
- The D-sub connector on the end of the HG1P optional cable is not water- or dust-proof. If protection against water and dust is required, the user must replace the D-sub connector with a water-proof connector.

Revision history

August 2015:	First Edition
May 2016:	Second Edition
July 2016:	Third Edition
November 2016:	Fourth Edition
March 2017:	Fifth Edition
June 2017:	Sixth Edition
August 2017:	Seventh Edition
December 2017:	Eighth Edition
March 2018:	Ninth Edition
June 2018:	Tenth Edition
March 2019:	Eleventh Edition
May 2019:	Twelfth Edition
December 2019:	Thirteenth Edition
July 2020:	Fourteenth Edition
December 2020:	Fifteenth Edition
March 2021:	Sixteenth Edition
January 2022:	Seventeenth Edition

Caution

- The contents of this manual and the WindO/I-NV4 application are copyright, and all rights are reserved by IDEC Corporation. Unauthorized reproduction is prohibited.
- The contents of this manual and the WindO/I-NV4 application are subject to change without notice.
- IDEC Corporation accepts no responsibility for circumstances arising from the use of this manual or the WindO/I-NV4 application.
- Please contact your vendor or IDEC Corporation with any problems regarding the operation of this product.
- This product cannot be directly connected to the communication lines (including public wireless LAN) of telecommunication carriers (mobile communication companies, fixed-line communication companies, Internet providers, etc.). When connecting this product to the Internet, be sure to connect via a device, such as a router.

Trademarks

WindO/I and MICRO/I are registered trademarks of IDEC CORPORATION in JAPAN. Microsoft and Windows are either registered trademarks or trademarks of Microsoft Corporation in the United States and/or other countries. Adobe is a trademark of Adobe Systems Incorporated.

All other company names and product names used in this manual or the WindO/I-NV4 application are trademarks of their respective owners.

This product adopts the font of Ryobi.

Preface

This manual describes MICRO/I operator interfaces (HG2J-7U, HG5G/4G/3G/2G-V, HG4G/3G, HG2G-5F/-5T, HG1G/1P) and WindO/I-NV4 general configuration software. The information includes drawing tools, setup procedures, and how to configure all MICRO/I operator interfaces.

This manual explains the operation and handling of the MICRO/I HG2J-7U, HG5G/4G/3G/2G-V, HG4G/3G, HG2G-5F/-5T, HG1G/1P. Please read it carefully and ensure that you fully understand the functions and performance of the MICRO/I HG2J-7U, HG5G/4G/3G/2G-V, HG4G/3G, HG2G-5F/-5T, HG1G/1P and the WindO/I-NV4 configuration software.





Read the following materials as necessary for your particular application.

References	Content
WindO/I-NV4 User's Manual (This document)	Describes the hardware specifications of the HG2J-7U, HG5G/4G/3G/2G-V, HG4G/3G, HG2G-5F/-5T, HG1G/1P.
WindO/I-NV4 External Device Setup Manual (PDF)	Describes the connection procedures and available device addresses for various communication including the Device Link Communication, O/I Link communication, and DM Link communication.
WindO/I-NV4 Help	Describes the operating procedures. The user is allowed to view all manuals via Help.
Character Table (PDF)	A list of fonts can be used with the HG2J-7U, HG5G/4G/3G/2G-V, HG4G/3G, HG2G-5F/-5T, HG1G/1P and WindO/I-NV4. For restrictions on using the HG2J-7U, HG5G/4G/3G/2G-V, HG4G/3G, HG2G-5F/-5T, HG1G/1P, refer to Chapter 2 "1.2 Available Text" on page 2-6.

Symbols Used in this Manual

This manual uses the following symbols to facilitate explanation.

Symbols

-  Information that requires special attention. Failure to operate the product in accordance with the information provided can lead to serious injury or damage.
-  Information relating to requests or material to reference in the use of a function
-  Useful information relating to a function
-  Indicates the chapter and page of related reference information.
- OK** Screen buttons are indicated by **bold** text or by using the actual graphic icon.
- SHIFT,  Keyboard keys are indicated by the keyboard inscription in capital letters or enclosed in square brackets.
- **** Controls are indicated by **bold** text.

Abbreviations, Generic Terms, and Terminology Used in this Manual

Item	Description
HG2J-7U	The name is short for MICRO/I HG2J-7UT22TF-B.
HG5G-V	The name is short for MICRO/I HG5G-VFXT22MF-B.
HG4G-V	The name is short for MICRO/I HG4G-VCXT22MF-B.
HG4G	The name is short for MICRO/I HG4G-CJT22*F-B.
HG3G-V	The name is short for MICRO/I HG3G-V*XT22MF-.*.
HG3G	The name is short for MICRO/I HG3G-*JT22*F-.*.
HG2G-V	The name is short for MICRO/I HG2G-V5FT22TF-.*.
HG2G-5F	The name is short for MICRO/I HG2G-5FT22TF-.*.
HG2G-5T	The name is short for MICRO/I HG2G-5T*22TF-.*.
HG1G	The name is short for MICRO/I HG1G-4VT22TF-.*.
HG1P	The name is short for MICRO/I HG1P-ST32*.
HG5G/4G/3G/2G-V	The format used to refer to HG5G-V, HG4G-V, HG3G-V and HG2G-V.
HG5G/4G/3G-V	The format used to refer to HG5G-V, HG4G-V and HG3G-V.
HG4G/3G	The format used to refer to HG4G and HG3G. HG4G-V and HG3G-V is not included.
HG2G-5F/-5T	The format used to refer to HG2G-5F and HG2G-5T.
HG1G/1P	The format used to refer to HG1G and HG1P.
MICRO/I	Generic term used to refer to the HG2J-7U, HG5G/4G/3G/2G-V, HG4G/3G, HG2G-5F/-5T, HG1G/1P.
External Device	Generic term used to refer to a PLC or micro computer that is connected to and communicates with the MICRO/I.
Device Address	Memory that is capable of storing values in unit of bits or words loaded on the MICRO/I and external device.
System Area	Device address area that is pre-allocated for exchanging screen management, error information, and clock data between the MICRO/I and an external device.
Device Link Communication	A communication method that performs communication with the external device according to the setting of the screen and without a program.
DM Link Communication	A communication method that reads to or writes value to external devices using the MICRO/I's dedicated DM Link memory.
User Communication	A communication method which performs communication with external devices such as barcode readers and inverters.
External Device Communication	Generic term used to refer to Device Link Communication and DM Link Communication.
Sub Host Communication	A communication method that performs communication with external device according to the set device address list and without a program.
BACnet Communication	A communication method for building management systems such as air conditioning, lighting and crime prevention.
O/I Link	A connection format that enables connections of up to 16 units of MICRO/I with high-speed communication of 115,200bps.
O/I Link Master	The MICRO/I unit that is directly connected to external device on the O/I Link network.
O/I Link Slave	The MICRO/I units that are not directly connected to external device on the O/I Link network.
WindO/I-NV4	Integrated configuration software application for creating projects of the MICRO/I.
Operating System	Software used to manage and control system software. Only HG2J-7U supports the update.
System Software	Software required for operating MICRO/I.
Project	Data including image data required for operating the MICRO/I, which is created with WindO/I-NV4.
Manager	WindO/I-NV4 provides tools to manage pictures, text and script etc. With the Managers, you can create and manage them in your project.
Setup	Generic term used to refer to the common settings in the project.

Item	Description
Project Settings	Basic settings of operation in the Setup settings.
Alarm Log	A function where the MICRO/I collects log data of alarms.
Data Log	A function where the MICRO/I collects value of device addresses.
Script	A script is an executable list of commands created by a simple programming language.
Text Group	A group of 32 texts maximum that is in order to dynamically switch the character displayed on the MICRO/I according to the value of the device address.
Windows Font	A character font that can be used on a computer running WindO/I-NV4.
Stroke Font	A glyph's outline is defined by the vertices of individual strokes and stroke's profile. Scalable fonts scale easily without jagged edges. Under font settings, "Stroke" is a stroke-based font.
Maintenance Communication	Communications between the WindO/I-NV4 and MICRO/I using a dedicated protocol.
Device Monitor	A special Popup Screen on the MICRO/I on which value of the device address can be displayed or changed.
Pass-Through	A function that enables maintenance of the external device via the MICRO/I.
System Screen	Pre-allocated screen dedicated for performing initial setting of the MICRO/I, self-diagnosis, and clearing the log data etc.
External Memory Device	The generic term for an SD memory card and a USB flash drive.
NV Metafile	A graphic data file that integrates drawings created on the WindO/I-NV4 edit screen.
Window	Screens that are loaded on to the Base Screen, including Popup Screen and Device Monitor.
Internal Device	The generic term for internal device addressing on the MICRO/I such as internal relays, registers, etc.
Keep Device	The generic term for internal device not initialized at the start of operation. Even after the power is turned off, the values are retained by the battery. <ul style="list-style-type: none"> • HMI Keep Registers (LKR) • HMI Keep Relays (LK)
Drawings	Define as as non functional content (i.e. shape, picture, text).
Parts	Define as functional content (i.e. button, pilot lamp, commands, etc.)
Object	Define as combination of Drawings and Parts placed on WindO/I-NV4 edit screen.
Touch Switch	A part that operates a function by pressing parts that have been placed on the screen.
Standard Keypad	Keypad that is displayed when operating Numerical and Character Input parts when Standard is selected under Type in the Keypad menu for Numerical and Character Input parts.
Movie File List	It is a list of movie files that have been registered in the Multimedia Function settings. You cannot change the order when you play files.

Contents

SAFETY PRECAUTIONS	Preface-1
Revision history	Preface-3
Caution	Preface-3
Trademarks.....	Preface-3
Preface	Preface-4
Symbols Used in this Manual	Preface-5
Abbreviations, Generic Terms, and Terminology Used in this Manual	Preface-6

Chapter 1 System Composition

1	System Composition.....	1-1
	1.1 System Composition for the RUN operation.....	1-1
	1.2 System Composition for Creating Screens	1-2
2	About the WindO/I-NV4	1-3
3	Operating Modes	1-4
4	Flow from Screen Creation and to Run Operation	1-5

Chapter 2 WindO/I-NV4 Features & Basic Operations

1	WindO/I-NV4 Specifications	2-1
	1.1 Available Data.....	2-1
	1.2 Available Text	2-6
	1.3 Available Number of Colors.....	2-20
	1.4 Available Image Files.....	2-20
	1.5 Available Sound Files.....	2-37
	1.6 Available Movie Files	2-37
2	Starting and Exiting WindO/I-NV4	2-38
	2.1 Starting WindO/I-NV4.....	2-38
	2.2 Exiting WindO/I-NV4	2-40
3	Configuration & Functions	2-41
	3.1 Application Menu Command List.....	2-42
	3.2 Quick Access Toolbar.....	2-43
	3.3 Ribbon Command List.....	2-46
	3.4 Windows Displayed in the Workspace	2-55
	3.5 Status Bar	2-58
4	Customizing WindO/I-NV4	2-61
	4.1 Configuring the Work Environment.....	2-61
	4.2 Customizing the Workspace	2-69
5	WindO/I-NV4 Common Operations and Settings.....	2-70
	5.1 Device Address Settings.....	2-70
	5.2 Setting Conditional Expressions.....	2-73

Chapter 3 Communication

1	Device Link Communication.....	3-1
	1.1 Overview	3-1
	1.2 Device Link Communication Settings.....	3-2
2	O/I Link Communication.....	3-3
	2.1 Overview	3-3
	2.2 O/I Link Communication Settings.....	3-3
3	DM Link Communication.....	3-4
	3.1 Overview	3-4
	3.2 DM Link Communication Settings.....	3-6
4	No External Devices.....	3-7
	4.1 Overview	3-7
	4.2 No External Devices Settings.....	3-7
5	User Communication.....	3-8
	5.1 Overview	3-8
	5.2 User Communication Settings Procedure	3-9
	5.3 Protocol Manager	3-32
	5.4 Example of User Communication Settings.....	3-80
	5.5 Connection Diagram for User Communication.....	3-86
6	Sub Host Communication	3-87
	6.1 Overview	3-87
	6.2 Supported Protocols and Communication Driver.....	3-87
	6.3 HMI Link Register (LLR) Assignment.....	3-88
	6.4 Sub Host Communication Configuration Procedure.....	3-89
	6.5 Error Information	3-92
7	BACnet Communication.....	3-94
	7.1 Overview	3-94
	7.2 BACnet Specifications	3-95
	7.3 About BACnet	3-96
	7.4 Function	3-98
	7.5 BACnet/IP Operation	3-104
	7.6 BACnet/IP Settings Procedure	3-105
	7.7 BACnet Settings Dialog Box.....	3-108
	7.8 Objects.....	3-124
	7.9 Key Properties.....	3-132

Chapter 4 Project Settings

1	Creating and Manipulating WindO/I-NV4 Project Data	4-1
	1.1 Creating New Project Data	4-1
	1.2 Opening Project Data	4-4
	1.3 Saving Project Data	4-5
	1.4 Printing Project Data	4-7
	1.5 Comparing Project Data	4-18
	1.6 Changing Project Settings	4-19
	1.7 Closing Project Data	4-23
2	Project Settings Configuration Procedure.....	4-24

3	Project Settings Dialog Box.....	4-25
3.1	System Tab	4-25
3.2	Communication Interface Tab	4-35
3.3	Communication Driver Tab.....	4-47
3.4	Communication Driver Network Tab	4-52
3.5	O/I Link Tab	4-55
3.6	User Communication Tab.....	4-56
3.7	Sub Host Communication Tab	4-60
3.8	Printer Tab	4-62
3.9	External Memory Device Tab.....	4-63
3.10	Autorun Tab	4-64
3.11	Expansion Module Tab.....	4-65
3.12	Web Server Tab	4-66
3.13	FTP Server Tab	4-68
3.14	E-mail Tab.....	4-70
3.15	Project Details Tab	4-75
3.16	Font/Kanji Dictionary Data Tab.....	4-76
3.17	Compatible Tab.....	4-77
3.18	BACnet/IP Settings Tab	4-80
3.19	Internal Clock Tab.....	4-81
4	Project Restrictions	4-83
4.1	Download Restrictions	4-83
4.2	Maximum Number of External Device Addresses.....	4-83

Chapter 5 Screen

1	Screen Overview.....	5-1
1.1	Screen Types.....	5-1
1.2	Screen Size.....	5-1
2	Creating and Manipulating WindO/I-NV4 Screens	5-2
2.1	Creating Screens.....	5-2
2.2	Opening Screens.....	5-3
2.3	Closing Screens.....	5-5
2.4	Duplicating Screens.....	5-7
2.5	Deleting Screens	5-9
2.6	Reusing Screens.....	5-11
2.7	Batch Editing of Multiple Screen Settings	5-13
3	Base Screen	5-14
3.1	Properties of Base Screen Dialog Box.....	5-14
3.2	Displaying Layered Base Screens.....	5-18
4	Popup Screen	5-20
4.1	Properties of Popup Screen Dialog Box	5-20
4.2	Popup Screen Configuration	5-24
4.3	Standard Keypad Popup Screen.....	5-25
5	Password Input Screen.....	5-26
5.1	Properties of Password Input Screen Dialog Box.....	5-26
5.2	Password Input Screen Configuration	5-28
5.3	Standard Password Input Screen.....	5-29

6	Screen Restrictions	5-30
6.1	Screen Number	5-30
6.2	Maximum Number of Parts.....	5-30
6.3	Maximum Number of External Device Addresses.....	5-31
6.4	Text and Messages.....	5-31
6.5	Vertical Installation.....	5-31

Chapter 6 Drawings and Parts

1	Overview	6-1
2	Drawing objects	6-2
2.1	Shapes	6-2
2.2	Picture.....	6-2
2.3	Text	6-2
3	Part Types	6-3
3.1	Buttons	6-3
3.2	Lamps	6-3
3.3	Data Displays.....	6-3
3.4	Charts	6-4
3.5	Commands	6-4
4	Drawings and Parts Overlapping	6-5
4.1	Overview	6-5
4.2	Displaying Overlapping Drawings and Parts.....	6-6
4.3	Restrictions.....	6-10
5	Part Library Function.....	6-11
5.1	What Can Be Done with the Part Library Function.....	6-11
5.2	How to use the Library Part in a project.....	6-12
5.3	How to register an object in the parts library.....	6-13
5.4	How to use a registered library part on another computer	6-14
5.5	Part Library.....	6-16

Chapter 7 Drawings

1	Shapes	7-1
1.1	Line.....	7-1
1.2	Polyline	7-3
1.3	Polygon	7-5
1.4	Rectangle	7-8
1.5	Circle/Ellipse	7-11
1.6	Arc.....	7-14
1.7	Pie	7-16
1.8	Equilateral Polygons	7-19
1.9	Fill.....	7-22
2	Picture.....	7-24
2.1	Picture Configuration Procedure	7-24
2.2	Properties of Picture Dialog Box.....	7-25
3	Text	7-26
3.1	Text Configuration Procedure.....	7-26
3.2	Properties of Text Dialog Box	7-27

Chapter 8 Buttons

1	Bit Button.....	8-1
	1.1 How the Bit Button is Used	8-1
	1.2 Bit Button Configuration Procedure.....	8-3
	1.3 Properties of Bit Button Dialog Box.....	8-4
2	Word Button.....	8-19
	2.1 How the Word Button is Used	8-19
	2.2 Word Button Configuration Procedure.....	8-22
	2.3 Properties of Word Button Dialog Box.....	8-23
3	Goto Screen Button.....	8-39
	3.1 How the Goto Screen Button is Used	8-39
	3.2 Goto Screen Button Configuration Procedure.....	8-40
	3.3 Properties of Goto Screen Button Dialog Box.....	8-41
4	Print Button.....	8-56
	4.1 How the Print Button is Used	8-56
	4.2 Print Button Configuration Procedure.....	8-57
	4.3 Properties of Print Button Dialog Box.....	8-58
5	Key Button	8-72
	5.1 How the Key Button is Used.....	8-72
	5.2 Key Button Configuration Procedure	8-74
	5.3 Properties of Key Button Dialog Box	8-75
	5.4 Key Buttons.....	8-94
	5.5 Key Browser	8-99
	5.6 Key Button Usage Examples.....	8-103
6	Multi-Button	8-110
	6.1 How the Multi-Button is Used.....	8-110
	6.2 Multi-Button Configuration Procedure	8-112
	6.3 Properties of Multi-Button Dialog Box.....	8-113
7	Keypad	8-142
	7.1 How the Keypad is Used.....	8-142
	7.2 Keypad Configuration Procedure	8-143
	7.3 Properties of Keypad Dialog Box.....	8-144
8	Selector Switch.....	8-146
	8.1 How the Selector Switch is Used	8-146
	8.2 Selector Switch Configuration Procedure.....	8-147
	8.3 Properties of Selector Switch Dialog Box.....	8-148
9	Potentiometer.....	8-163
	9.1 How the Potentiometer is Used	8-163
	9.2 Potentiometer Configuration Procedure.....	8-164
	9.3 Properties of Potentiometer Dialog Box.....	8-165

Chapter 9 Lamps

1	Pilot Lamp.....	9-1
	1.1 How the Pilot Lamp is Used	9-1
	1.2 Pilot Lamp Configuration Procedure.....	9-2
	1.3 Properties of Pilot Lamp Dialog Box	9-3

2	Multi-State Lamp	9-16
2.1	How the Multi-State Lamp is Used	9-16
2.2	Multi-State Lamp Configuration Procedure.....	9-18
2.3	Properties of Multi-State Lamp Dialog Box.....	9-19

Chapter 10 Data Displays

1	Numerical Input	10-1
1.1	How the Numerical Input is Used	10-1
1.2	Numerical Input Configuration Procedure.....	10-2
1.3	Properties of Numerical Input Dialog Box	10-3
1.4	How to Enter Values.....	10-25
1.5	Advanced Usage	10-26
2	Character Input.....	10-27
2.1	How the Character Input is Used	10-27
2.2	Character Input Configuration Procedure	10-28
2.3	Properties of Character Input Dialog Box.....	10-29
2.4	How to Enter Text.....	10-47
2.5	Character Input Usage Examples	10-49
2.6	String Data Storage Method	10-55
2.7	Advanced Usage	10-55
3	Picture Display	10-56
3.1	How the Picture Display is Used	10-56
3.2	Picture Display Configuration Procedure	10-59
3.3	Properties of Picture Display Dialog Box	10-60
3.4	Picture Display Usage Examples	10-76
4	Video Display	10-81
4.1	How the Video Display is Used	10-81
4.2	Video Display Configuration Procedure.....	10-83
4.3	Properties of Video Display Dialog Box	10-84
4.4	File Screen.....	10-92
5	Message Display.....	10-96
5.1	How the Message Display is Used.....	10-96
5.2	Message Display Configuration Procedure	10-98
5.3	Properties of Message Display Dialog Box.....	10-99
5.4	String Data Storage Method	10-116
6	Message Switching Display	10-117
6.1	How the Message Switching Display is Used.....	10-117
6.2	Message Switching Display Configuration Procedure	10-118
6.3	Properties of Message Switching Display Dialog Box.....	10-119
7	Alarm List Display	10-136
7.1	How the Alarm List Display is Used.....	10-136
7.2	Alarm List Display Configuration Procedure	10-137
7.3	Properties of Alarm List Display Dialog Box.....	10-138
8	Alarm Log Display.....	10-153
8.1	How the Alarm Log Display is Used.....	10-153
8.2	Alarm Log Display Configuration Procedure	10-154
8.3	Properties of Alarm Log Display Dialog Box	10-155

9	Data Log Display.....	10-171
9.1	How the Data Log Display is Used	10-171
9.2	Data Log Display Configuration Procedure.....	10-172
9.3	Properties of Data Log Display Dialog Box.....	10-173
10	Numerical Display	10-185
10.1	How the Numerical Display is Used.....	10-185
10.2	Numerical Display Configuration Procedure	10-186
10.3	Properties of Numerical Display Dialog Box	10-187
11	Calendar	10-205
11.1	How the Calendar is Used	10-205
11.2	Calendar Configuration Procedure	10-206
11.3	Properties of Calendar Dialog Box.....	10-207

Chapter 11 Charts

1	Bar Chart	11-1
1.1	How the Bar Chart is Used	11-1
1.2	Bar Chart Configuration Procedure	11-2
1.3	Properties of Bar Chart Dialog Box.....	11-3
2	Line Chart	11-21
2.1	How the Line Chart is Used.....	11-21
2.2	Line Chart Configuration Procedure	11-22
2.3	Properties of Line Chart Dialog Box	11-23
3	Pie Chart.....	11-53
3.1	How the Pie Chart is Used	11-53
3.2	Pie Chart Configuration Procedure.....	11-54
3.3	Properties of Pie Chart Dialog Box	11-55
4	Meter.....	11-64
4.1	How the Meter is Used	11-64
4.2	Meter Configuration Procedure.....	11-65
4.3	Properties of Meter Dialog Box	11-66

Chapter 12 Commands

1	Bit Write Command.....	12-1
1.1	How the Bit Write Command is Used	12-1
1.2	Bit Write Command Configuration Procedure.....	12-3
1.3	Properties of Bit Write Command Dialog Box.....	12-4
2	Word Write Command.....	12-9
2.1	How the Word Write Command is Used	12-9
2.2	Word Write Command Configuration Procedure.....	12-11
2.3	Properties of Word Write Command Dialog Box.....	12-12
3	Goto Screen Command.....	12-18
3.1	How the Goto Screen Command is Used	12-18
3.2	Goto Screen Command Configuration Procedure.....	12-19
3.3	Properties of Goto Screen Command Dialog Box.....	12-20

4	Print Command	12-25
4.1	How the Print Command is Used	12-25
4.2	Print Command Configuration Procedure	12-26
4.3	Properties of Print Command Dialog Box	12-27
5	Script Command	12-32
5.1	How the Script Command is Used	12-32
5.2	Script Command Configuration Procedure	12-33
5.3	Properties of Script Command Dialog Box	12-34
6	Multi-Command	12-38
6.1	How the Multi-Command is Used	12-38
6.2	Multi-Command Configuration Procedure	12-39
6.3	Properties of Multi-Command Dialog Box	12-40
7	Timer	12-60
7.1	How the Timer is Used	12-60
7.2	Timer Configuration Procedure	12-61
7.3	Properties of Timer Dialog Box	12-62

Chapter 13 Alarm Log Function

1	Overview	13-1
1.1	How the Alarm Log Function is Used	13-1
1.2	Alarm States	13-3
1.3	Sampling Data	13-4
1.4	Data Configuration	13-5
1.5	Saving and Deleting Data	13-7
1.6	Using Data and Detected Alarms	13-9
2	Alarm Log Function Configuration Procedure	13-10
2.1	Configuring the Device Addresses to Monitor and the Alarm Detection Condition	13-10
3	Alarm Log Settings Dialog Box	13-13
3.1	Alarm Log Settings Dialog Box	13-13
4	Using Data and Detected Alarms	13-31
4.1	Displaying Saved Data with the Alarm Log Display	13-31
4.2	Displaying Registered Messages with the Alarm List Display According to the Active Alarm	13-33
4.3	Make a Sound of the Buzzer and Flash the Screen when an Alarm has Occurred	13-36
4.4	Saving the Data as a CSV File	13-38

Chapter 14 Data Log Function

1	Overview	14-1
1.1	How the Data Log Function is Used	14-1
1.2	Sampling Values of Device Addresses	14-3
1.3	Data Configuration	14-5
1.4	Saving and Deleting Data	14-6
1.5	Using the Data	14-7
2	Data Log Function Configuration Procedure	14-8
2.1	Configuring the Data Log Function	14-8

3	Data Log Settings Dialog Box.....	14-13
3.1	Data Log Settings Dialog Box.....	14-13
3.2	Individual Settings Dialog Box.....	14-15
4	Using the Data	14-33
4.1	Displaying the Data in the Line Chart.....	14-33
4.2	Displaying Data on the Data Log Display.....	14-35
4.3	Displaying Data as Numerical Values	14-36
4.4	Saving the Data as a CSV File	14-45

Chapter 15 Operation Log Function

1	Overview.....	15-1
1.1	How the Operation Log Function is Used.....	15-1
1.2	Recorded Events	15-3
1.3	Data Configuration	15-4
1.4	Saving and Deleting Data	15-6
1.5	Using the Data.....	15-7
2	Operation Log Function Configuration Procedure.....	15-8
2.1	Configuring the Events and the Condition for Recording.....	15-8
3	Operation Log Settings Dialog Box	15-10
3.1	Operation Log Settings Dialog Box.....	15-10
4	Using the Data	15-21
4.1	Saving the Data as a CSV File	15-21

Chapter 16 Data Storage Area

1	Overview.....	16-1
1.1	What is the Data Storage Area?	16-1
1.2	Data Storage Area.....	16-2
2	Data Storage Area Configuration Procedure	16-3
3	Data Storage Area Management Dialog Box.....	16-4

Chapter 17 Preventive Maintenance Function

1	Overview.....	17-1
1.1	How the Preventive Maintenance Function is Used.....	17-1
1.2	Counting the Operation Time and Operation Count.....	17-2
1.3	Thresholds.....	17-3
2	Preventive Maintenance Function Configuration Procedure.....	17-4
2.1	Counting Operation Time and Operation Count	17-4
3	Preventive Maintenance Settings Dialog Box	17-6
3.1	Preventive Maintenance Settings Dialog Box.....	17-6
3.2	Individual Settings Dialog Box.....	17-8
4	Using the Data	17-11
4.1	Displaying the Counted Operation Count on a Numerical Display	17-11
4.2	Notifying with a Beep when the Counted Operation Time Reaches the Threshold	17-14

Chapter 18 Recipe Function

1	Overview	18-1
	1.1 How the Recipe Function is Used	18-1
	1.2 Data for Recipes.....	18-2
	1.3 Data Configuration	18-3
2	Recipe Function Configuration Procedure.....	18-4
	2.1 Configuring Recipe Function Operations and Device Addresses	18-4
3	Recipe Settings Dialog Box	18-8
	3.1 Recipe Settings Dialog Box.....	18-8
	3.2 Individual Settings Dialog Box	18-10
4	Creating and Deleting Data for Recipes	18-14
	4.1 Editing Recipe Data	18-14
	4.2 Creating Recipe Files	18-17
	4.3 Editing Recipe Files	18-21
	4.4 Deleting Recipe Files	18-22

Chapter 19 Text Group

1	Overview	19-1
	1.1 How to Create the Text Groups and Text Registrations	19-1
	1.2 Functions that Support Text Groups.....	19-2
2	Text Groups and Text Configuration Procedure	19-3
	2.1 How to Create the Text Groups and Text Registrations	19-3
	2.2 Switching the Displayed Language by Value of Device Address	19-9
3	Text Manager.....	19-11
	3.1 Text Manager.....	19-11

Chapter 20 Script

1	About the Script Function.....	20-1
	1.1 Overview of the Script Function.....	20-1
	1.2 Types and Trigger Conditions of the Script	20-2
	1.3 Data Type of the Script.....	20-3
	1.4 Script Error	20-4
2	Editing and Management of the Script.....	20-5
	2.1 Script Registration Procedure	20-5
	2.2 Script Manager.....	20-7
	2.3 Script Editor.....	20-12
3	Global Script	20-16
	3.1 Setting procedures for Global Script.....	20-16
	3.2 Global Script Settings Dialog Box	20-18
	3.3 Global Script Dialog Box.....	20-19
4	Script Definition Method.....	20-21
	4.1 Format List	20-21

5	Script Coding Examples	20-32
5.1	Control Statements	20-32
5.2	Relational Operators.....	20-38
5.3	Logical Operators.....	20-40
5.4	Arithmetic Operators	20-41
5.5	Bitwise Operators.....	20-42
5.6	Bit Functions.....	20-44
5.7	Word Functions.....	20-45
5.8	Data Type Designations.....	20-60
6	Important Notes	20-61
6.1	Important Notes Regarding the While Definition.....	20-61
6.2	Important Notes Regarding the Data Type Designations	20-61
6.3	Regarding Communication Error.....	20-61
6.4	Number of Device Addresses That Can Be Used	20-62
6.5	About the Priority of the Operator	20-62

Chapter 21 Sound Function

1	Function and Settings.....	21-1
1.1	Overview - How the Sound Function is Used	21-1
1.2	Supported Sound Files.....	21-1
2	Sound Function Configuration Procedure	21-2
2.1	Configuring Sound Files & Trigger Conditions	21-2
3	Sound Settings Dialog Box.....	21-6
3.1	Sound Settings Dialog Box	21-6
4	Operation.....	21-10

Chapter 22 Multimedia Function

1	Function and Settings.....	22-1
1.1	How the Multimedia Function is Used	22-1
1.2	Supported Movie Files	22-2
2	Multimedia Function Configuration Procedure.....	22-3
2.1	Registering Movie Files	22-3
2.2	Configuring the Event Recording Function.....	22-6
2.3	Configuring the Video Input.....	22-11
3	Multimedia Settings Dialog Box	22-12
3.1	Multimedia Settings Dialog Box	22-12
4	Checking the Status of the Function	22-16
5	Restrictions	22-17

Chapter 23 User Accounts and the Security Function

1	Overview.....	23-1
1.1	User Accounts.....	23-1
1.2	Protecting Data.....	23-3
1.3	Protecting Displays and Operations.....	23-8

2	Security Function Configuration Procedure.....	23-11
2.1	Creating and Editing User Accounts	23-11
2.2	Adding and Editing Security Groups	23-19
2.3	Protecting the Display and Operation of Screens and Parts	23-25
3	Security Dialog Box.....	23-37
3.1	Security Dialog Box	23-37
4	Password Input	23-47
4.1	Entering the Password on the MICRO/I	23-47
4.2	Entering the Password in WindO/I-NV4.....	23-49
5	Editing User Accounts on the MICRO/I	23-50
5.1	Opening the User Account Setting Screen	23-50
5.2	Editing a User Account.....	23-51
5.3	User Account Setting Screen Configuration.....	23-60

Chapter 24 Online Function

1	Communicating with the MICRO/I.....	24-1
1.1	How the Online Function is Used	24-1
1.2	Connect MICRO/I to a Computer	24-4
1.3	Change Communication Settings	24-5
2	Downloading	24-12
2.1	Downloading Project Data to the MICRO/I	24-12
2.2	Download Dialog Box.....	24-14
2.3	Downloading Files to an External Memory Device Inserted in the MICRO/I	24-18
2.4	Downloading the System Software of Expansion Modules.....	24-20
3	Uploading	24-21
3.1	Upload Project Data from the MICRO/I	24-21
3.2	Upload Dialog Box.....	24-23
3.3	Uploading Files from an External Memory Device Inserted in the MICRO/I.....	24-24
4	Clear	24-26
4.1	Clear Data from the MICRO/I	24-26
4.2	Deleting Data from an External Memory Device Inserted in the MICRO/I.....	24-27
5	Formatting	24-28
5.1	Formatting an External Memory Device Inserted in the MICRO/I.....	24-28
6	System Information	24-29
6.1	Displaying System Information	24-29
6.2	Target Information Dialog Box	24-31

Chapter 25 Monitor Function

1	Monitoring with WindO/I-NV4.....	25-1
1.1	How the Monitor Function in WindO/I-NV4 is Used	25-1
1.2	Debugging in WindO/I-NV4.....	25-4
1.3	Display the Value of Device Address in Popup.....	25-18
1.4	Highlighting Objects While Satisfying Conditions	25-18
1.5	Switching the Screen of the MICRO/I.....	25-19
1.6	Open Current Screens.....	25-19
1.7	Change Values of Device Addresses and Check the Operation of Project Data Offline	25-19

2	Monitoring on the MICRO/I.....	25-20
2.1	How the Monitoring Function is Used.....	25-20
2.2	Device Monitor.....	25-21
2.3	Change Values of Device Addresses and Check the Operation of Project Data Offline	25-27

Chapter 26 Simulator Function

1	Overview.....	26-1
1.1	How the Simulator Function is Used	26-1
2	Using the Simulator	26-3
2.1	Starting the Simulator	26-3
2.2	Debugging in Simulator	26-4
2.3	Saving the Displayed Screen as an Image.....	26-6
3	Simulator	26-7
3.1	Simulator.....	26-7
3.2	Screen Monitor	26-10
3.3	Custom Monitor	26-11
3.4	Batch Monitor	26-13
3.5	Script Debugger	26-15
4	Restrictions	26-17

Chapter 27 Pass-Through Function

1	Overview.....	27-1
1.1	How the Pass-Through Function is Used	27-1
1.2	Supported External Devices	27-2
1.3	How to Connect when Using the Pass-Through Function.....	27-3
1.4	Use the Pass-Through Function.....	27-3
2	Pass-Through Function Settings Procedure	27-4
2.1	How to Enable the Pass-Through Function in WindO/I-NV4.....	27-4
2.2	How to Enable the Pass-Through Function in MICRO/I System Mode	27-5
3	Important Notes	27-8

Chapter 28 Maintenance

1	Web Server Function.....	28-1
1.1	Web Server Function Overview.....	28-1
1.2	System Composition.....	28-1
1.3	Minimum System Requirements	28-2
1.4	Settings and Connection Method	28-2
1.5	System Web Page	28-5
1.6	Custom Web Page.....	28-12
2	FTP Server Function.....	28-16
2.1	What Can Be Done with the FTP Server Function.....	28-16
2.2	System Composition.....	28-16
2.3	Hierarchy of the FTP Server	28-17
2.4	Supported Commands and Transfer modes.....	28-17
2.5	Verified FTP Client.....	28-17
2.6	Settings and Connection Method	28-18

3	FTP Client Function.....	28-20
3.1	What Can Be Done with the FTP Client Function.....	28-20
3.2	System Composition.....	28-20
3.3	Supported Commands and Transfer modes.....	28-21
3.4	Verified FTP Server.....	28-21
3.5	FTP Client Function Configuration Procedure.....	28-21
3.6	FTP Server Manager.....	28-27
3.7	File Transfer Settings Dialog Box.....	28-31
4	E-mail Function.....	28-38
4.1	What Can Be Done with the E-mail Function.....	28-38
4.2	System Composition.....	28-38
4.3	Supported Protocols and Authentication methods.....	28-38
4.4	Verified SMTP Servers.....	28-39
4.5	E-mail Sending Operation.....	28-39
4.6	Operating E-mail function and checking sending status.....	28-40
4.7	Restrictions of each E-mail.....	28-41
4.8	E-mail Function Configuration Procedure.....	28-42
4.9	E-mail Settings Dialog Box.....	28-52
5	Social Media Function.....	28-64
5.1	What Can Be Done with the Social Media Function.....	28-64
5.2	System Composition.....	28-64
5.3	Social media message Sending Operation.....	28-65
5.4	Operating Social media function and checking sending status.....	28-66
5.5	Restrictions of each Tweet.....	28-66
5.6	Social Media Function Configuration Procedure.....	28-67
5.7	Social Media Settings Dialog Box.....	28-70

Chapter 29 Data Transfer Function

1	Project Transfer Function.....	29-1
1.1	What Can Be Done with the Project Transfer Function.....	29-1
1.2	Project Transfer Procedures.....	29-2
1.3	Converting Project for Transfer.....	29-3
1.4	Using Key Buttons, Multi-Buttons, or Multi-Commands to Transfer Project Data	29-6
1.5	Using File Manager on the MICRO/I to Transfer Project Data.....	29-7
1.6	Precautions.....	29-15
2	PLC Program Transfer Function.....	29-16
2.1	Supported PLCs.....	29-16
2.2	What Can Be Done using the PLC Program Transfer Function.....	29-17
2.3	PLC Program Transfer Procedures.....	29-17
2.4	Creating ZLD Project File.....	29-18
2.5	Using Key Buttons, Multi-Buttons, or Multi-Commands to Transfer PLC Programs	29-19
2.6	Using File Manager on the MICRO/I to Transfer PLC Programs.....	29-21
2.7	Precautions.....	29-29

3	File Copy Function	29-30
3.1	What Can Be Done with the File Copy Function	29-30
3.2	File Copy Operating Procedures.....	29-31
3.3	Using Key Buttons, Multi-Buttons, or Multi-Commands to Copy Files	29-32
3.4	Using File Manager on the MICRO/I to Transfer Project Data.....	29-33
3.5	Precautions.....	29-38

Chapter 30 Expansion Modules

1	Overview.....	30-1
1.1	Overview of Expansion Modules	30-1
1.2	Applicable Expansion Modules	30-2
1.3	The Expansion Module Operation	30-6
2	Digital I/O Modules	30-12
2.1	Using Digital I/O Modules	30-12
3	Analog I/O Modules	30-13
3.1	Using Analog I/O Modules.....	30-13
3.2	Analog I/O Module Parameter Settings	30-14
3.3	Device Allocation.....	30-25
4	Cyclic Script.....	30-29
4.1	Setting Procedures for Cyclic Script	30-29
5	Module Configuration Dialog Box.....	30-30
5.1	Overview	30-30
5.2	Basic Operations for Module Configuration Dialog Box	30-31

Chapter 31 External Memory Devices

1	External Memory Devices	31-1
1.1	Supported External Memory Devices.....	31-1
1.2	What Can Be Done Using an External Memory Device.....	31-1
1.3	Specifications of External Memory Devices	31-2
1.4	File structure	31-3
1.5	Reading/Writing Data	31-4
1.6	Setting the External Memory Device Folder	31-12
1.7	Deleting Files on the External Memory Device	31-13
1.8	Formatting the External Memory Device.....	31-14
1.9	Precautions.....	31-18
2	USB Autorun Function	31-19
2.1	Overview of the USB Autorun Function	31-19
2.2	USB Autorun Function Configuration Procedure	31-23
2.3	Creating a USB Autorun Definition File.....	31-26
2.4	USB Autorun Function Security.....	31-34
3	USB Popup Screen Function.....	31-35
3.1	Automatically Displaying a Popup Screen when a USB Flash Drive is Inserted ..	31-35

Chapter 32 Printer

1	Functions and Connections	32-1
1.1	Functions Available with the Printer	32-1
1.2	Connecting a Printer to MICRO/I	32-1
1.3	Supported Printers	32-1
2	Setting and Monitoring the Printer	32-2
2.1	Setting the Printer	32-2
2.2	Monitoring the Printer	32-2

Chapter 33 Internal Devices

1	Bit Devices	33-1
1.1	HMI Device Addresses	33-1
1.2	Control Device Addresses	33-6
2	Word Devices	33-7
2.1	HMI Device Addresses	33-7
2.2	Control Device Addresses	33-16

Chapter 34 MICRO/I Setup

1	Maintenance Screen	34-1
1.1	Maintenance Screen Overview	34-1
1.2	Displaying the Maintenance Screen	34-1
1.3	Adjusting Screen Brightness	34-2
2	System Mode Overview	34-3
2.1	System Mode Screens	34-3
2.2	Names and Layout of Setup Menus	34-5
3	Settings	34-7
3.1	Initial Setting (Initial Setting)	34-7
3.2	Clock Setting	34-11
3.3	Offline (Offline)	34-11
3.4	Run	34-11
3.5	System Information (System Info.)	34-12
3.6	File Manager	34-13
3.7	Ext.Mem.Device	34-13
3.8	Top Page	34-13
3.9	Self Diagnosis (Self Diag.)	34-13

Chapter 35 MICRO/I Specifications

1	HG2J-7U	35-1
	1.1 Packing content	35-1
	1.2 Type No.	35-1
	1.3 Part Names.....	35-2
	1.4 External Interfaces.....	35-3
	1.5 Specifications.....	35-4
	1.6 Dimensions.....	35-6
	1.7 Installation	35-7
	1.8 Wiring	35-10
	1.9 Maintenance and Inspection	35-12
	1.10 Software License Information.....	35-13
2	HG5G/4G/3G/2G-V.....	35-14
	2.1 Packing content	35-14
	2.2 Type No.	35-14
	2.3 Part Names.....	35-15
	2.4 External Interfaces.....	35-17
	2.5 Specifications.....	35-19
	2.6 Dimensions.....	35-21
	2.7 Installation	35-26
	2.8 Wiring	35-29
	2.9 USB Cable Lock Pin Attachment.....	35-30
	2.10 Maintenance and Inspection	35-31
3	HG4G/3G, HG2G-5F	35-35
	3.1 Packing content	35-35
	3.2 Type No.	35-35
	3.3 Part Names.....	35-36
	3.4 External Interfaces.....	35-38
	3.5 Specifications.....	35-40
	3.6 Dimensions.....	35-42
	3.7 Installation	35-46
	3.8 Wiring	35-48
	3.9 USB Cable Lock Pin Attachment.....	35-49
	3.10 Maintenance and Inspection	35-50
4	HG2G-5T, HG1G	35-54
	4.1 Packing content	35-54
	4.2 Type No.	35-54
	4.3 Part Names.....	35-55
	4.4 External Interfaces.....	35-57
	4.5 Specifications.....	35-58
	4.6 Dimensions.....	35-61
	4.7 Installation	35-63
	4.8 Wiring	35-64
	4.9 USB Cable Lock Pin Attachment.....	35-65
	4.10 Maintenance and Inspection	35-66

5	HG1P.....	35-70
	5.1 Packing content	35-70
	5.2 Part Numbers.....	35-70
	5.3 Part Names.....	35-71
	5.4 External Interfaces	35-72
	5.5 Specifications.....	35-73
	5.6 Dimensions.....	35-80
	5.7 Installation	35-81
	5.8 Wiring	35-84
	5.9 Maintenance and Inspection.....	35-86
6	Options.....	35-89
	6.1 Optional items.....	35-89
	6.2 Replacement Parts	35-95
7	About the Warranty of the products	35-96
	7.1 Warranty Period	35-96
	7.2 Extent of warranty.....	35-96
	7.3 Start.....	35-96
	7.4 Indemnification	35-96
	7.5 Extent of service	35-96

Chapter 36 Troubleshooting

1	Error Messages.....	36-1
	1.1 Errors Displayed on the Screen.....	36-1
	1.2 Low Battery Voltage	36-4
2	Handling Problems.....	36-5
	2.1 When You Cannot Download Project Data	36-5
	2.2 If the backlight is OFF and the buzzer sounds	36-5
	2.3 Touch Panel Does Not Respond Correctly.....	36-5
	2.4 Power LED light is OFF	36-6
	2.5 POWER LED is lit or flashing.....	36-6

Appendix

1	Color Number.....	A-1
2	View Browser	A-3
3	Color Palette	A-4
4	Pattern Palette	A-5
5	Text Alignment.....	A-7

Index

1 System Composition

There are two types of system compositions used in operating the MICRO/I: One that is configured for the operation, and the other that is used for creating projects required for performing operations. In creating projects, use the WindO/I-NV4, the dedicated configuration software application for the MICRO/I.

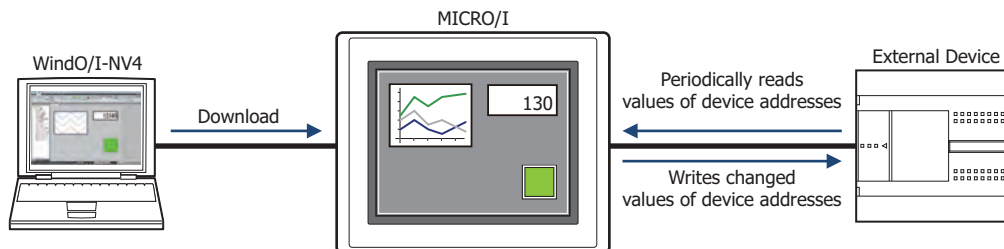

● MICRO/I

The MICRO/I is equipped with a high-brightness, color LCD with fast screen drawing speed, quick-response touch switches, and high-speed communications to provide a comfortable man-machine interface. It is designed to allow easy data read/write from/to external device's, and does not burden the operator with issues relating to communications software.

1.1 System Composition for the RUN operation

The MICRO/I can be operated in the following system configuration. Devices that can be connected vary depending on your MICRO/I model. Refer to the specifications of the model for the details.

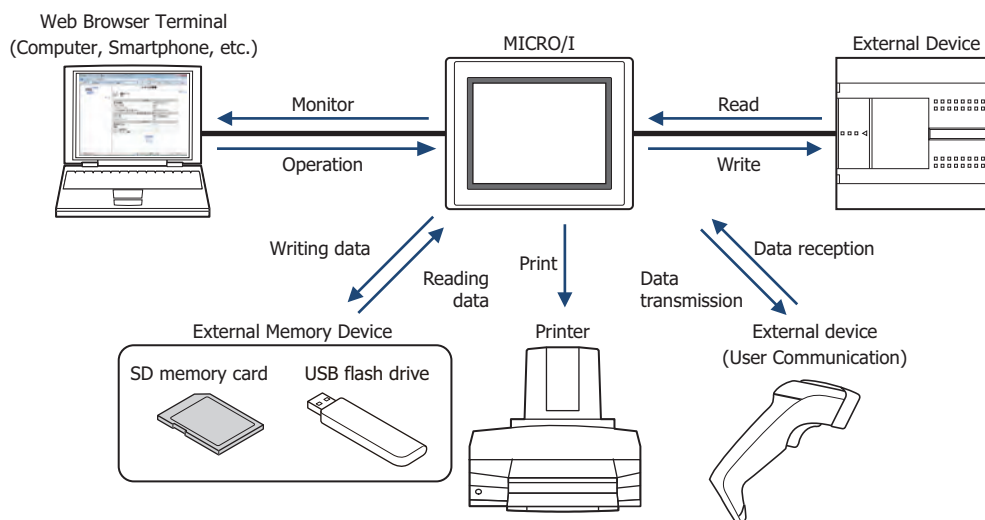

1.2 System Composition for Creating Screens

It is necessary to create and download a project to the MICRO/I for operating it. Use the WindO/I-NV4 to create a project. The project you have created can be downloaded to the MICRO/I by directly connecting it to the computer, or the project data can be downloaded to external memory device, and then it can be copied from external memory device to the MICRO/I equipped with the memory card interface or the USB interface.

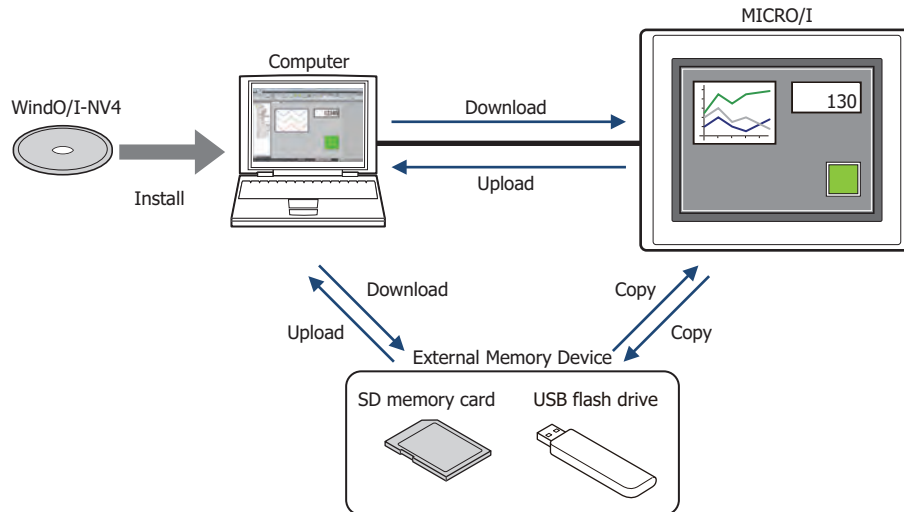

2 About the WindO/I-NV4

WindO/I-NV4 is software that is exclusively designed for operation with the MICRO/I, for specifying settings and creating screens. The set of data made up of settings and created screens is called a project.

Using WindO/I-NV4, you create a project and then download it to the MICRO/I, to build the interface necessary for operation.

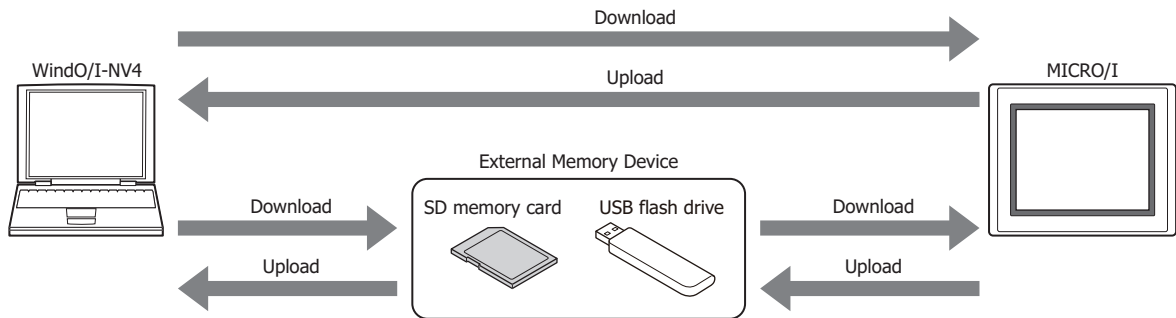

3 Operating Modes

The MICRO/I includes multiple modes, so you switch between modes as and when necessary. These modes are called operating modes. The functions and the operations and conditions for switching are as follows.

Mode	Functions	Conditions required for switching to the mode
Run Mode	This is the mode at the time of executing project data. The created screen is displayed.	<ul style="list-style-type: none"> • Turn ON the power to the MICRO/I. • Press [Run] on the Top Page in System Mode or on the Main Menu. • The download of the project data is completed.
System Mode	Perform initial settings, clock settings, self-diagnosis, etc. for the MICRO/I.	<ul style="list-style-type: none"> • Press down for 3 seconds or more at the top-left corner of the screen to display the Maintenance Screen, and then press System Mode. • Using the screen switching button, multi-buttons, screen switch or multi commands, switch to the System Mode. • All data is cleared using WindO/I-NV4. • Write the System Area 1 Display screen number (address number+0) to FFFFh.
Monitor Mode	Monitor Mode is used for monitoring values of device addresses using WindO/I-NV4. In this mode, the words "Monitor Mode" flashes at the bottom-left of the MICRO/I screen.	On the WindO/I-NV4 Online tab, in the Monitor group, click Start Monitor .
Offline Mode	MICRO/I stops communicating with the external devices. It takes you to a Main Menu with many internal settings to choose from including Initial Setting, Clock Setting and System Information etc. In this mode, the message "Offline Mode" blinks on the bottom-left of the MICRO/I screen.	<ul style="list-style-type: none"> • Press Offline on the Top Page in System Mode or on the Main Menu. • While monitoring in WindO/I-NV4, on the Online tab, in the Monitors group, click Go offline.
Data Transfer Mode	Transferring data between a computer and the MICRO/I.	<ul style="list-style-type: none"> • Download project data. • Upload project data.
Boot Mode*1	Forcibly downloads the MICRO/I OS, system software and project data if MICRO/I does not start normally or you forget its password.	<ul style="list-style-type: none"> • Turn on the power while pressing the RESET switch on the back of the MICRO/I, and press and hold the RESET switch for 3 seconds or longer. • Turn on the MICRO/I with the MICRO/I OS or system software corrupted.



When switched to System Mode, operation of the MICRO/I stops.



- To display the Maintenance Screen, the **Enable Maintenance** check box from the **System Settings** tab of the Project Settings dialog box must be checked.
- For details about Maintenance Mode, refer to Chapter 34 "1 Maintenance Screen" on page 34-1.

*1 HG2J-7U only

4 Flow from Screen Creation and to Run Operation

The following flowchart describes the sequence of step from the screen creation for the MICRO/I to the Run operation.

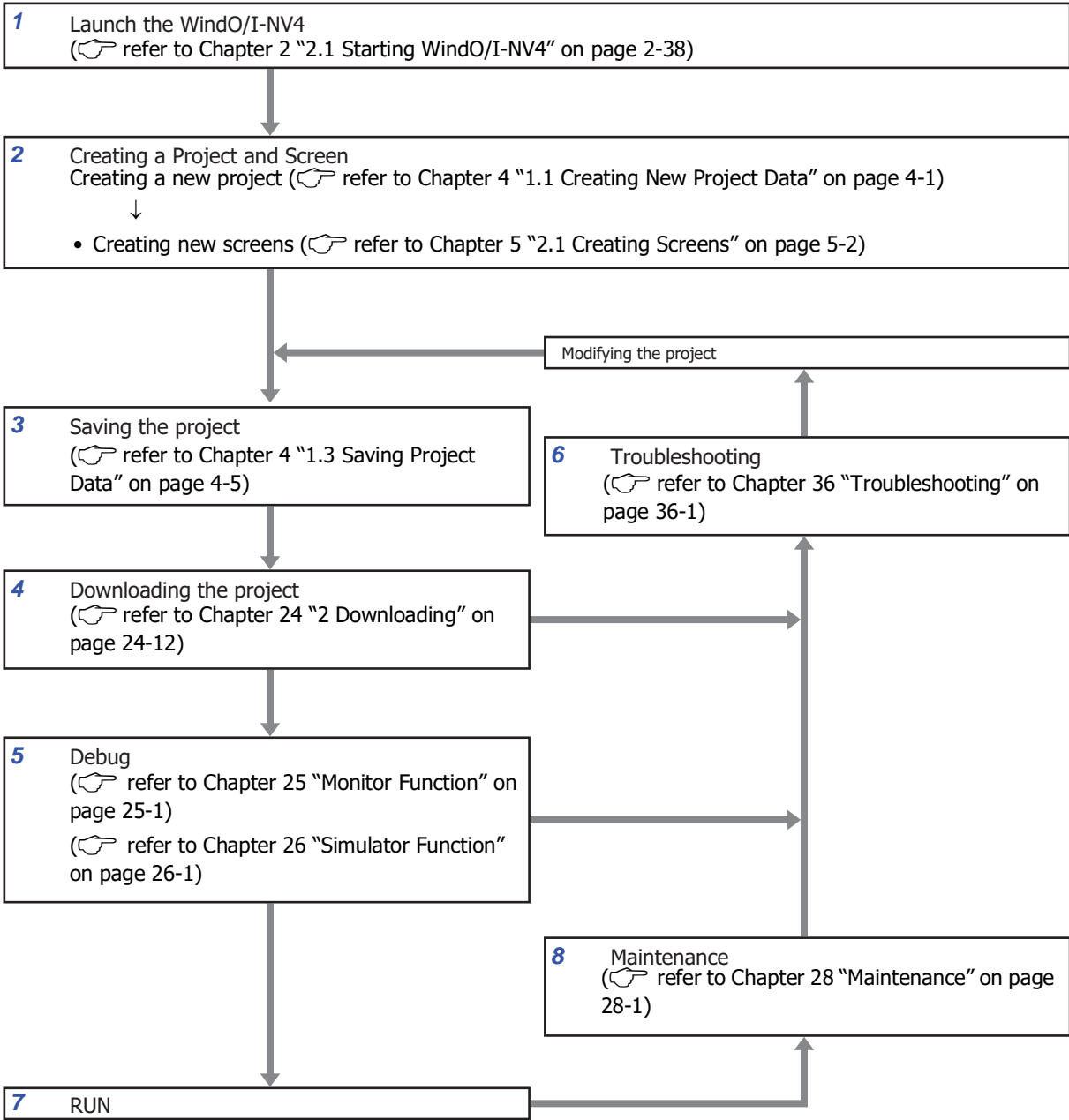

1 Launch WindO/I-NV4

Launch WindO/I-NV4.

2 Creating a Project and Screen

Create a project and performing various settings.

Create display screens.

3 Saving the project

Save the project data at any time after the configuration settings are done.

4 Downloading the project

Connect the computer to the MICRO/I using a USB cable or Ethernet cable and download the created project data to the internal memory of the MICRO/I.

5 Debug

Using Monitor function and Simulator function, you can correct created project data while confirming actual actions.

6 Troubleshooting

If there is a module or communication-related problem with the MICRO/I, or a problem with the screen, an appropriate message is displayed at the top of the screen.

In addition, error information is saved to a special data register. By referring to this information and repeatedly correcting the project, downloading, and debugging, the project can be completed.

7 RUN

Starting communication with the external device and execute various functions according to the project settings.

8 Maintenance

The Web Server function allows the user to remotely monitor or operate the state of the O/Is from the web browser. In addition, the saved data in the MICRO/I and files in External Memory Device can be uploaded to the computer.

Chapter 2 WindO/I-NV4 Features & Basic Operations

This chapter describes the minimum system requirements for WindO/I-NV4, how to start and exit it, and the configuration of its screens and menus.

1 WindO/I-NV4 Specifications

1.1 Available Data

● Data types

Data type is the format of the data related to the minimum and maximum values of data that can be processed by a part and handling of negative and real numbers.

Data types and data ranges that can be used on the MICRO/I and WindO/I-NV4 are listed below.

Data type	Required word count	Processable data range
UBIN16(W)	1	0 to 65535
BIN16(I)	1	-32768 to 32767
UBIN32(D)	2	0 to 4294967295
BIN32(L)	2	-2147483648 to 2147483647
BCD4(B)	1	-999 to 9999
BCD8(EB)	2	-9999999 to 99999999
Float32(F)	2	-3.4×10^{38} to -1.18×10^{-38} , 0, 1.18×10^{-38} to 3.4×10^{38}
Bit	-	0, 1
String(S)	-	String data. It handles from the beginning to the NULL(00h) character as a character string.

● Data handling

Data stored in device addresses is handled as described below.

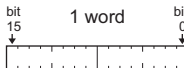
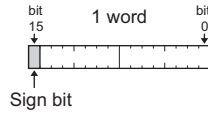
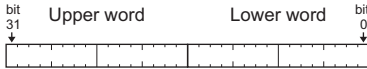
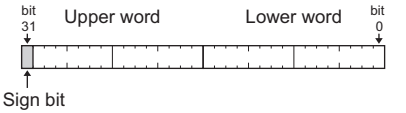
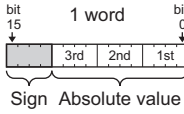
Data type	Data handling
UBIN16(W)	 <p>Data is handled as an unsigned 16-bit integer.</p>
BIN16(I)	 <p>Data is handled as a signed 16-bit integer. If the sign bit (bit 15) is 1, the value is two's complement.</p>
UBIN32(D)	 <p>Handled as an unsigned 32-bit integer with the starting address number as the lower word.</p>
BIN32(L)	 <p>Handled as a signed 32-bit integer with the starting address number as the lower word. If the sign bit (bit 31) is 1, the value is two's complement.</p>
BCD4(B)	 <p>Data is handled as a four digit (16-bit) binary-coded decimal value. Each four bits from bit 0 to bit 11 is handled as the absolute value for the 1st to 3rd digit. Bit 12 to bit 15 is handled as the minus sign (-) when its value is F (Hex) and it is handled as the absolute value for the 4th digit when 0 to 9 (Hex).</p>

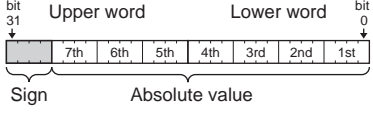
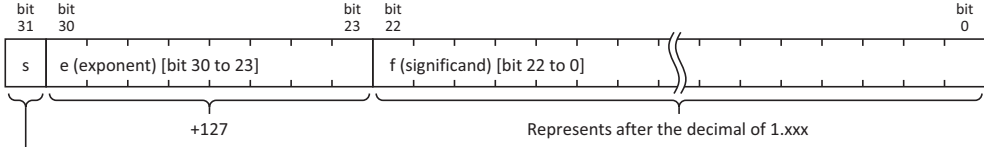
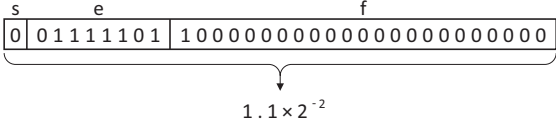
Data type	Data handling
BCD8(EB)	<p>Data is handled as an eight digit (32-bit) binary-coded decimal value.</p> <p>Each four bits from bit 0 to bit 27 is handled as the absolute value for the 1st to 7th digit.</p> <p>Bit 28 to bit 31 is handled as the minus sign (-) when its value is F (Hex) and it is handled as the absolute value for the 8th digit when 0 to 9 (Hex).</p> 
Float32(F)	<p>Data is handled as a 32-bit floating-point real number. The number of significant digits is 6 digits. The floating-point type data format conforms to the IEEE (The Institute of Electrical and Electronics Engineers) standard for the single precision storage format as explained next.</p> <p>Single precision floating-point values in IEEE 754 (32 bits)</p> <p>Single precision floating-point values in IEEE 754 are expressed with a total of 32 bits (2 words) using 1 bit for the sign <i>s</i>, 8 bits for the exponent <i>e</i>, and 23 bits for the significand <i>f</i>. The sign bit indicates the sign of the expressed value (positive or negative). The exponent is an 8 bit signed integer with a value from -128 to 127.</p>  <p>Sign bit (0: positive, 1: negative)</p> <p>Example:</p>  <p>If all bits are 0, the value is "0".</p>

 The internal representation of Float32(F) is described here, but the data for Float32(F) (floating-point real numbers) is handled with a special bit configuration, so do not directly access the bits.

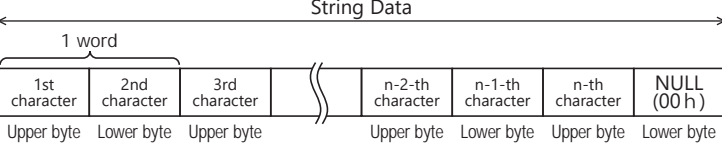
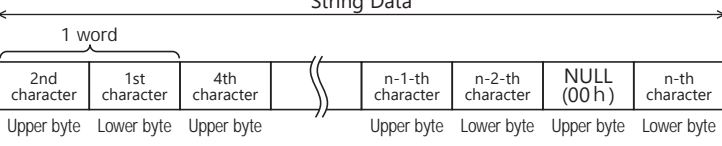
Data type	Data handling
String(S)	<p>The entered text are stored in the upper byte and the lower byte according to the Storage Method of String Data setting of WindO/I-NV4.</p> <p>Select the from Upper byte in the Storage Method of String Data</p>  <p>Select the from Lower byte in the Storage Method of String Data</p>  <p>For details, refer to Chapter 10 "2.6 String Data Storage Method" on page 10-55.</p> <p>The Storage Method of String Data is configured on the System tab in the Project Settings dialog box.</p>

Example: Data handling

Data type	Storing 0FFF (Hex) in LDR0	Storing FFFF (Hex) in LDR0
UBIN16(W)	<p>0FFF (Hex) 0FFF (Hex) is handled as 4095 (Dec).</p>	<p>FFFF (Hex) FFFF (Hex) is handled as 65535 (Dec).</p>
BIN16(I)	<p>+ 0FFF (Hex) 0FFF (Hex) is handled as 4095 (Dec).</p>	<p>- FFFF (Hex) Sign bit is 1, so FFFF (Hex) is two's complement, handled as -1 (Dec).</p>
Data type	Storing FFFF (Hex) in LDR0, 0FFF (Hex) in LDR1	Storing FFFF (Hex) in LDR0, FFFF (Hex) in LDR1
UBIN32(D)	<p>0FFFFFFF (Hex) 0FFFFFFF (Hex) is handled as 268435455 (Dec).</p>	<p>FFFFFFF (Hex) FFFFFFF (Hex) is handled as 4294967295 (Dec).</p>
BIN32(L)	<p>+ 0FFFFFFF (Hex) The sign bit is 0, so the positive number 0FFFFFFF (Hex) is handled as 268435455 (Dec).</p>	<p>- FFFFFFFF (Hex) Sign bit is 1, so two's complement of the negative number FFFFFFFF (Hex), handled as -1 (Dec).</p>
Data type	Storing 1234 (Hex) in LDR0	Storing F765 (Hex) in LDR0
BCD4(B)	<p>+ 234 (Hex) The sign is 1 (Hex), so the binary-coded decimal value of the positive number 234 (Hex), handled as 1234 (Dec).</p>	<p>- 765 (Hex) The sign is F (Hex), so the binary-coded decimal value of the negative number 765 (Hex), handled as -765 (Dec).</p>
Data type	Storing 5678 (Hex) in LDR0, 1234 (Hex) in LDR1	Storing 4321 (Hex) in LDR0, F765 (Hex) in LDR1
BCD8(EB)	<p>+ 2345678 (Hex) The sign is 1 (Hex), so the binary-coded decimal value of the positive number 2345678 (Hex), handled as 2345678 (Dec).</p>	<p>- 7654321 (Hex) The sign is F (Hex), so the binary-coded decimal value of the negative number 7654321 (Hex), handled as -7654321 (Dec).</p>
Data type	Storing 0000 (Hex) in LDR0, BFA0 (Hex) in LDR1	
Float32(F)	<p>Sign: 1 Exponent: 01111111 Significand: 010000000000000000000000</p> <p>$2^0+2^1+2^2+2^3+2^4+2^5+2^6 = 127$ $2^{-2} = 0.25$</p> <p>Negative $-1.25 \times 2^{127-127} = -1.25$</p>	

Data type	Storing "MICRO/I" in LDR50																								
String(S)	<p>Select from Upper byte in Storage Method of String Data</p> <table border="1" style="margin-left: auto; margin-right: auto;"> <tr> <td colspan="2" style="text-align: center;">LDR50</td> <td colspan="2" style="text-align: center;">LDR51</td> <td colspan="2" style="text-align: center;">LDR52</td> <td colspan="2" style="text-align: center;">LDR53</td> </tr> <tr> <td style="text-align: center;">M (4d)</td> <td style="text-align: center;">I (49)</td> <td style="text-align: center;">C (43)</td> <td style="text-align: center;">R (52)</td> <td style="text-align: center;">O (4f)</td> <td style="text-align: center;">I (49)</td> <td style="text-align: center;">00h</td> <td style="text-align: center;">(No change)</td> </tr> <tr> <td colspan="2" style="text-align: center;">Upper byte</td> <td colspan="2" style="text-align: center;">Lower byte</td> <td colspan="2" style="text-align: center;">Upper byte</td> <td colspan="2" style="text-align: center;">Lower byte</td> </tr> </table>	LDR50		LDR51		LDR52		LDR53		M (4d)	I (49)	C (43)	R (52)	O (4f)	I (49)	00h	(No change)	Upper byte		Lower byte		Upper byte		Lower byte	
	LDR50		LDR51		LDR52		LDR53																		
M (4d)	I (49)	C (43)	R (52)	O (4f)	I (49)	00h	(No change)																		
Upper byte		Lower byte		Upper byte		Lower byte																			
<p>Select from Lower byte in Storage Method of String Data</p> <table border="1" style="margin-left: auto; margin-right: auto;"> <tr> <td colspan="2" style="text-align: center;">LDR50</td> <td colspan="2" style="text-align: center;">LDR51</td> <td colspan="2" style="text-align: center;">LDR52</td> <td colspan="2" style="text-align: center;">LDR53</td> </tr> <tr> <td style="text-align: center;">I (49)</td> <td style="text-align: center;">M (4d)</td> <td style="text-align: center;">R (52)</td> <td style="text-align: center;">C (43)</td> <td style="text-align: center;">I (49)</td> <td style="text-align: center;">O (4f)</td> <td style="text-align: center;">(No change)</td> <td style="text-align: center;">00h</td> </tr> <tr> <td colspan="2" style="text-align: center;">Upper byte</td> <td colspan="2" style="text-align: center;">Lower byte</td> <td colspan="2" style="text-align: center;">Upper byte</td> <td colspan="2" style="text-align: center;">Lower byte</td> </tr> </table>	LDR50		LDR51		LDR52		LDR53		I (49)	M (4d)	R (52)	C (43)	I (49)	O (4f)	(No change)	00h	Upper byte		Lower byte		Upper byte		Lower byte		
LDR50		LDR51		LDR52		LDR53																			
I (49)	M (4d)	R (52)	C (43)	I (49)	O (4f)	(No change)	00h																		
Upper byte		Lower byte		Upper byte		Lower byte																			



In the data types UBIN32(D), BIN32(L), BCD8(EB), and Float32(F), two words (upper word and lower word) are used for a single value. The MICRO/I and external devices communicate data in device addresses in one word units, so when the upper word and lower word are sent in separate packets, the value may have already changed when the data for both words is received, which may cause an unexpected result.

● Indirect Read and Indirect Write Settings

The indirect specification of a device address means to add a value (indirect value) to the address number of the set device address and use that address number as the actual read source or write destination. You can change the read source or write destination address number just by changing this indirect value.

Indirect read

Add the indirect value to the address number of the device address set as the read source and read the value of the indirectly specified device address.

Example: To read an indirectly specified value of device address into LDR200

When the device set as the read source is LDR10 and the indirect value's device address is D21, if 4 (indirect value: 4) is set in D21, the device address of the value actually read is LDR14.

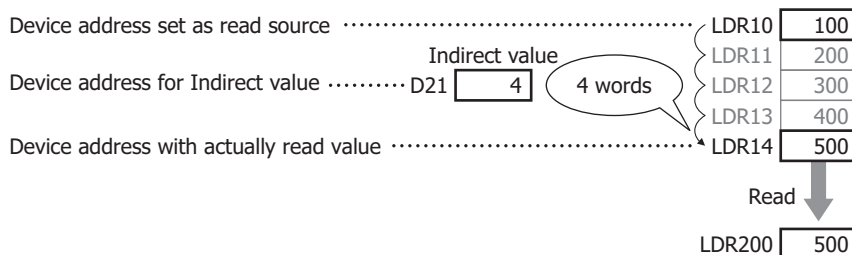

Indirect write

Add the indirect value to the address number of the device address set as the write destination and write a value to the indirectly specified device address.

Example: To write the value in LDR20 to an indirectly specified device address

When the device set as the write destination is LDR100 and the indirect value's device address is D20, if 3 (indirect value: 3) is set in D20, the device address of the value actually written is LDR103.

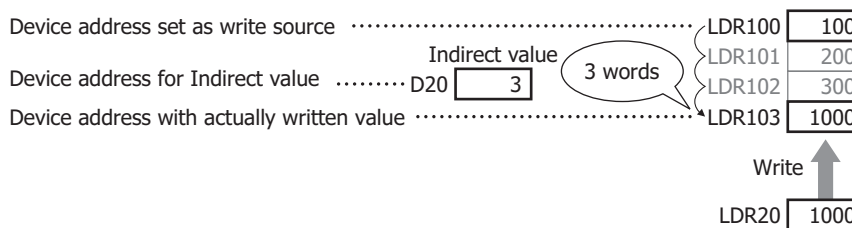

Parts you can indirectly read and indirectly write

Part	Indirect read	Indirect write
Word Button	YES	YES
Multi-Button	YES	YES
Numerical Input	YES	YES
Character Input	YES	YES
Numerical Display	YES	NO
Word Write Command	YES	YES
Script Command	YES	YES
Multi-Command	YES	YES

- Enter the value for indirect values as the data type UBIN16(W). Indirect values can be set in the range of 0 to 32767. When an indirect write is executed with an out-of-range indirect value, "Device range error" is displayed. Similarly, when an indirect read is executed, the previous value before the indirect value changed is retained for a data display part, and "Device range error" is displayed for a part that is not a data display part.
- For reading device address indirectly, decide the read source address number after the indirect value changes and after the screen changes, and then read the value of device address. For the device address of an external device, communication may take some time as the value is read from the external device, so when transferring or calculating the data that was read, repeatedly execute the corresponding part.

1.2 Available Text

● Font

HG2J-7U HG5G-V HG4G-V HG4G HG3G-V HG3G HG2G-V HG2G-5F HG2G-5T HG1G HG1P

Supported Languages

The MICRO/I can display multiple fonts by installing them. In addition to the fonts installed on the MICRO/I, all Windows fonts*1 displayed on your computer can be used on the display.

In addition, the MICRO/I has a function that switches between two or more text groups dynamically. With this function, the registration text of buttons can be switched to different languages according to the conditions.

For details, refer to Chapter 19 "Text Group" on page 19-1.

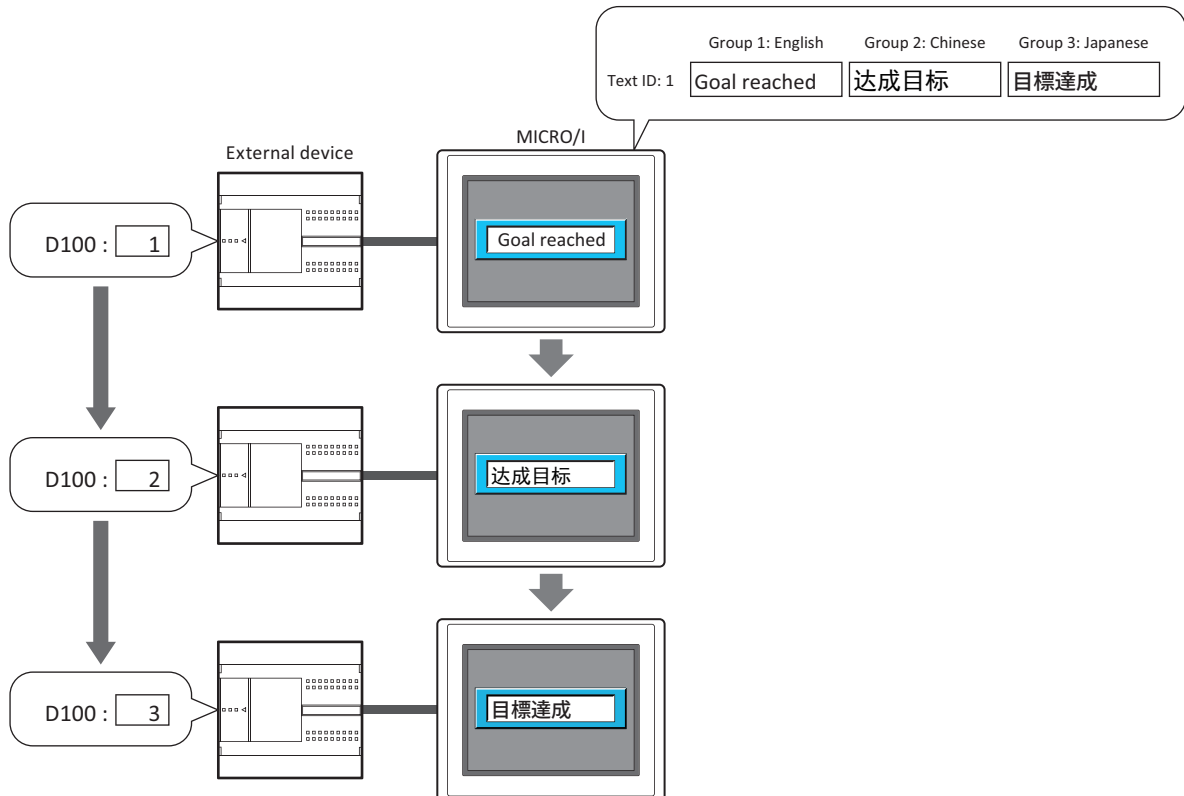

*1 Fonts that use the following character sets are not supported.
Other, OEM/DOS, Mac

Installed Fonts in the MICRO/I

This is the font installed in MICRO/I. The installed fonts vary based on the model.

■ **HG2J-7U**

Font Name	Code System	Language
Japanese	Shift_JIS	Japanese
Western	ISO 8859-1	Icelandic, Irish, Italian, English, Dutch, Swedish, Spanish, Danish, German, Norwegian, Portuguese, Finnish, Faeroese, French
Simplified Chinese	GB2312	Chinese (Simplified Chinese)
Traditional Chinese	BIG5	Taiwanese (Traditional Chinese)
Hangul	KSC5601	Korean
Central European	ANSI1250	Czech, Hungarian, Polish, Slovak, Slovene
Baltic	ANSI1257	Estonian, Latvian, Lithuanian, Greenlandic, Lappish
Cyrillic	ANSI1251	Bulgarian, Belarusian, Ukrainian, Serbian 2, Macedonian, Russian
7-seg	ASCII	Displays number 0 to 9, alphabet character A to F, and symbols such as asterisk, plus, minus, and period only

■ **HG5G/4G/3G/2G-V, HG4G/3G, HG2G-5F/-5T, HG1G/1P**

Font Name	Code System	Language
Japanese	Shift_JIS (JIS level-1 and level-2 kanji sets)	Japanese
Western	ISO 8859-1 (Latin1)	Icelandic, Irish, Italian, English, Dutch, Swedish, Spanish, Danish, German, Norwegian, Portuguese, Finnish, Faeroese, French
Stroke	ISO 8859-1 (Latin1)	Icelandic, Irish, Italian, English, Dutch, Swedish, Spanish, Danish, German, Norwegian, Portuguese, Finnish, Faeroese, French
7-seg	ISO 8859-1 (Latin1)	Displays number 0 to 9, alphabet character A to F, and symbols such as asterisk, plus, minus, and period only



MICRO/I supports Stroke character code from 0x20 to 0x7E only.

Optional Fonts*1

Fonts downloaded from WindO/I-NV4.

Font Name	Code System	Language	Size
High-quality Japanese Font (First standard)	Shift_JIS (JIS level-1 kanji set)	Japanese Text can be displayed sharper when JIS level-1 kanji set is enlarged. Refer to "High-quality Fonts" on page 2-10.	476KB
High-quality Japanese Font (Second standard)	Shift_JIS (JIS level-2 kanji set)	Japanese Text can be displayed sharper when JIS level-2 kanji set is enlarged. Refer to "High-quality Fonts" on page 2-10.	423KB
Simplified Chinese	GB2312	Chinese	237KB
Traditional Chinese	BIG5	Taiwanese	421KB
Hangul	KSC5601	Korean	108KB
High-quality Western Font	ISO 8859-1 (Latin1)	Icelandic, Irish, Italian, English, Dutch, Swedish, Spanish, Danish, German, Norwegian, Portuguese, Finnish, Faeroese, French Text can be displayed sharper when European fonts are enlarged. Refer to "High-quality Fonts" on page 2-10.	101KB
Central European	ANSI1250	Czech, Hungarian, Polish, Slovak, Slovene	5.25KB
Baltic	ANSI1257	Estonian, Latvian, Lithuanian, Greenlandic, Lappish	5.25KB
Cyrillic	ANSI1251	Bulgarian, Belarusian, Ukrainian, Serbian 2, Macedonian, Russian	5.25KB



The single-byte part of Simplified Chinese, Traditional Chinese and Hangul are displayed with ISO 8859-1, and as for double-byte part of Hangul, only the Hangul characters are supported.



The download size of font data is adjusted in multiples of 64KB.

The download size of font data is 64KB when the font size is 0KB or 64KB and smaller.

Example: When downloading Japanese large font (level-1 kanji set), Chinese, and European large fonts:

Font	Size
High-quality Japanese Font(First standard)	476KB
Simplified Chinese	237KB
High-quality Western Font	101KB

Total size of the font data: 814KB

Download size of font data: 832KB (814KB is adjusted in multiples of 64KB.)

*1 HG5G/4G/3G/2G-V, HG4G/3G, HG2G-5F/-5T, HG1G/1P only

Available Fonts for Drawings and Parts

YES: Supported, NO: Not supported

Objects		Installed Fonts in the MICRO/I* ¹	Optional Fonts* ²	Windows Font
Drawings	Text	YES	YES	YES
Buttons	Bit Button	YES	YES	YES
	Word Button	YES	YES	YES
	Goto Screen Button	YES	YES	YES
	Print Button	YES	YES	YES
	Key Button	YES	YES	YES
	Keypad	YES	YES	YES
	Selector Switch* ²	YES	YES	YES* ³
Lamps	Pilot Lamp	YES	YES	YES
	Multi-State Lamp	YES	YES	YES
Data Displays	Numerical Input	YES	NO	YES
	Character Input	YES	YES	NO
	Message Display	YES	YES	YES* ³ * ⁴
	Message Switching Display	YES	YES	YES* ³
	Alarm List Display	YES	YES	YES* ³
	Alarm Log Display	YES	YES	YES* ³
	Data Log Display	YES	YES	NO
	Numerical Display	YES	NO	YES
	Calendar	YES	YES	NO
Charts	Bar Chart	YES	YES	YES* ³
	Line Chart	YES	YES	YES* ³

*1 The fonts that can be used vary based on the object. For details, refer to the setting of each object.

*2 HG5G/4G/3G/2G-V, HG4G/3G, HG2G-5F/-5T, HG1G/1P only

*3 Windows font can be used only when the "Use Text Manager" is selected.

*4 Windows font can be used for fixed text only. Only the MICRO/I-installed font and the optional fonts can be used for the variable strings.

● High-quality Fonts

HG2J-7U HG5G-V HG4G-V HG4G HG3G-V HG3G HG2G-V HG2G-5F HG2G-5T HG1G HG1P

The high-quality fonts are the Japanese large fonts (first standard/second standard), and European fonts.

If you download high-quality fonts and select **Use large font** on the System tab in the Project Setting dialog box, the MICRO/I can replace some of the optional fonts with the high-quality fonts.

Scaled text with a background color is replaced and displayed with these fonts for a more attractive look.

High-quality Western Font Display (Size 8x16)

H \ W	0.5	1	2	3	4	5	6
0.5	AB09	AB09	AB09	AB09	AB09	AB09	AB09
1	AB09	AB09	AB09	AB09	AB09	AB09	AB09
2	AB09	AB09	AB09	AB09	AB09	AB09	AB09
3	AB09	AB09	AB09	AB09	AB09	AB09	AB09
4	AB09	AB09	AB09	AB09	AB09	AB09	AB09
5	AB09	AB09	AB09	AB09	AB09	AB09	AB09
6	AB09	AB09	AB09	AB09	AB09	AB09	AB09
7	AB09	AB09	AB09	AB09	AB09	AB09	AB09
8	AB09	AB09	AB09	AB09	AB09	AB09	AB09

H \ W	7	8
0.5	AB09	AB09
1	AB09	AB09
2	AB09	AB09
3	AB09	AB09
4	AB09	AB09
5	AB09	AB09
6	AB09	AB09
7	AB09	AB09
8	AB09	AB09

High-quality Japanese Font Display (Size 8x16)

H \ W	0.5	1	2	3	4	5	6
	0.5	AB09	AB09	AB09	AB09	AB09	AB09
1	AB09	AB09	AB09	AB09	AB09	AB09	AB09
2	AB09	AB09	AB09	AB09	AB09	AB09	AB09
3	AB09	AB09	AB09	AB09	AB09	AB09	AB09
4	AB09	AB09	AB09	AB09	AB09	AB09	AB09
5	AB09	AB09	AB09	AB09	AB09	AB09	AB09
6	AB09	AB09	AB09	AB09	AB09	AB09	AB09
7	AB09	AB09	AB09	AB09	AB09	AB09	AB09
8	AB09	AB09	AB09	AB09	AB09	AB09	AB09

H \ W	7	8
	0.5	AB09
1	AB09	AB09
2	AB09	AB09
3	AB09	AB09
4	AB09	AB09
5	AB09	AB09
6	AB09	AB09
7	AB09	AB09
8	AB09	AB09

High-quality Japanese Font Display (Size 16x16)

H \ W		0.5		1		2		3		4		5		6	
		あ	い	あ	い	あ	い	あ	い	あ	い	あ	い	あ	い
0.5		あ	い	あ	い	あ	い	あ	い	あ	い	あ	い	あ	い
1		あ	い	あ	い	あ	い	あ	い	あ	い	あ	い	あ	い
2		あ	い	あ	い	あ	い	あ	い	あ	い	あ	い	あ	い
3		あ	い	あ	い	あ	い	あ	い	あ	い	あ	い	あ	い
4		あ	い	あ	い	あ	い	あ	い	あ	い	あ	い	あ	い
5		あ	い	あ	い	あ	い	あ	い	あ	い	あ	い	あ	い
6		あ	い	あ	い	あ	い	あ	い	あ	い	あ	い	あ	い
7		あ	い	あ	い	あ	い	あ	い	あ	い	あ	い	あ	い
8		あ	い	あ	い	あ	い	あ	い	あ	い	あ	い	あ	い

H \ W		7		8	
		あ	い	あ	い
0.5		あ	い	あ	い
1		あ	い	あ	い
2		あ	い	あ	い
3		あ	い	あ	い
4		あ	い	あ	い
5		あ	い	あ	い
6		あ	い	あ	い
7		あ	い	あ	い
8		あ	い	あ	い

- 
 When the high-quality fonts have not been downloaded into the operator interface, the installed fonts in the MICRO/I are used even if "Use large font" is selected.
- When the Character Input part display font size is 8x16, high-quality fonts are not displayed even if "Use large font" is selected.

● Windows Font

HG2J-7U HG5G-V HG4G-V HG4G HG3G-V HG3G HG2G-V HG2G-5F HG2G-5T HG1G HG1P

Selecting Windows Font for the Font property gives you access to all of the fonts*¹ installed on your computer for use on Drawing Objects and Parts. This allows you to display fonts and languages that are not installed on the MICRO/I.

Windows Font Settings

Windows Font settings are made in the Font Settings dialog box.

- 1 Click the **Change** button in the **Windows Font** group on the properties dialog box for Drawing Objects, Parts, or on the Text Manager.

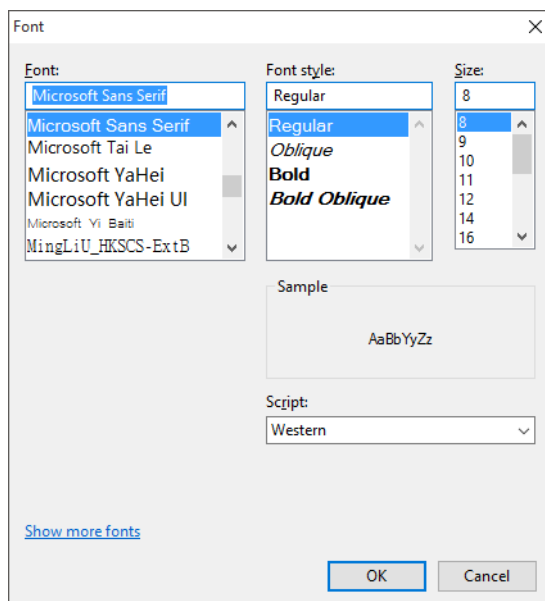

- 2 Set each item and click the **OK** button.

- **Font**
Select the font to use.
- **Font style**
Select italic, bold, or other style.
- **Size**
Select the size of the text.
- **Sample**
Shows a preview using the specified font.
- **Script**
Select the character set code.



- The right end of the text may have missing dots if **Font style** is set to **Italic**. You can remedy this by adding an extra space at the end of the line.
- An alternate font will be used if the Project Data uses a font that does not exist on the computer. This means that text will appear differently if the Project Data is opened on another computer.

*1 Fonts that use the following character sets are not supported.
Other, OEM/DOS, Mac

Using Windows Fonts

This section describes how to use Windows Fonts.



- Selecting Windows Font for the Font property for Draw Objects and Parts automatically disables these properties:
 - Style: The style set under **Windows Font** will be used.
 - Magnification: The width by height magnification will be set to 1 x 1. Note, **Magnification** can be selected on the Message Display, Message Switching Display, and Alarm List Display parts, but will not be reflected on the actual text displayed. To use scrolling on these parts, adjust the display area for text using the **Magnification** property.
- When the **Place on the Top Layer** check box on the Properties dialog box for parts with Windows fonts set is selected, lines containing characters outside the part outline are not displayed.

To register and use a Windows Font in Text Manager

Applicable draw object	Text	
Applicable parts	Buttons	Bit Button, Word Button, Goto Screen Button, Print Button, Key Button, Keypad, Selector Switch
	Lamps	Pilot Lamp, Multi-State Lamp
	Data Displays	Message Display, Message Switching Display, Alarm List Display, Alarm Log Display, Data Log Display
	Charts	Bar Chart, Line Chart

1 Select the **Use Text Manager** check box on the Properties dialog box for Draw Objects and Parts.

- The **Use Text Manager** check box may appear in different locations depending on the object. This table shows where to find this property:

Applicable objects	Location
Text	Properties of Text dialog box
Bit Button, Word Button, Goto Screen Button, Print Button, Key Button, Pilot Lamp, Multi-State Lamp	Registration Text tab
Selector Switch, Message Display	General tab
Message Switching Display	Message tab
Bar Chart, Line Chart	Label tab

- The Alarm List Display and Alarm Log Display parts are designed to use the text registered in the Text Manager so the **Use Text Manager** check box is not shown.

2 Specify the Text ID for the Windows Font set in Text Manager.



- Using the Text ID for the Windows Font set in Text Manager, the text is displayed horizontally. even if **Vertical Writing** is selected in the properties dialog box.
- In the Message Display, variable text “\@” appears as is.
- With the Alarm List Display and Alarm Log Display, line spacing is not automatically adjusted based on the size of the text. Adjust it using the **Line Spacing** property on the **Format** tab.
- If text containing a carriage return is used for a label on a Bar or Line Chart, or for an Alarm List Display or Alarm Log Display part, it will appear truncated after the carriage return if a non-Windows Font is used.
- When printing Alarm Logs, Text IDs set to a Windows Font will be printed using a font that exists on the MICRO/I.

To select a font in the Properties dialog box

Applicable draw object	Text	
Applicable parts	Buttons	Bit Button, Word Button, Goto Screen Button, Print Button, Key Button, Keypad
	Lamps	Pilot Lamp, Multi-State Lamp
	Data Displays	Numerical Input, Character Input

Select **Windows** for **Font** on the Properties dialog box for a Draw Object or Part.

The **Font** property may appear in different locations depending on the part. This table shows where to find this property:

Part	Location
Text	Properties of Text dialog box
Bit Button, Word Button, Goto Screen Button, Print Button, Key Button, Pilot Lamp, Multi-State Lamp	Registration Text tab
Keypad	Properties of Keypad dialog box
Numerical Input, Numerical Display	View tab

● Character Code Table

HG2J-7U HG5G-V HG4G-V HG4G HG3G-V HG3G HG2G-V HG2G-5F HG2G-5T HG1G HG1P

Using the Character Code Table

Example: Finding the character code for the character "a" in the table.

	0	1	2	3	4	5	6	7	8	9	A	B	C	D	E	F
0			0	@	P		p				°	À	Ð	à	ã	
1		!	1	^	Q	a	q				i	±	Á	Ñ	á	ñ
2		"	2	B	R	b	r				∅	²	Ã	Ò	ã	ò
:		#	3	C	S	c	s				£	³	Ñ	Ó	ã	ó

Upper 4 bits of the code (hexadecimal)

Lower 4 bits of the code (hexadecimal)

The upper four bits of the code are hexadecimal 6.
 The lower four bits of the code are hexadecimal 1.
 Therefore, the character code for "a" is as follows.

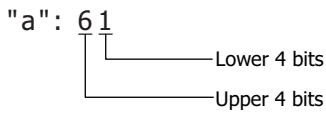

For other fonts and two-byte characters, refer to the table of the relevant code system.
 Japanese: Shift_JIS(JIS First standard, JIS Second standard), Simplified Chinese: GB2312, Traditional Chinese: BIG5, Hangul: KSC5601

High-quality Western Font (ISO 8859-1)

	0	1	2	3	4	5	6	7	8	9	A	B	C	D	E	F
0			0	@	P	`	p				°	À	Ð	à	ð	
1			!	1	À	Q	a	q			ı	±	Á	Ñ	á	ñ
2			”	2	B	R	b	r			ø	²	Â	Ò	â	ò
3			#	3	C	S	c	s			£	³	Ã	Ó	ã	ó
4			\$	4	D	T	d	t			¤	´	Ä	Ô	ä	ô
5			%	5	E	U	e	u			¥	µ	Å	Õ	å	õ
6			&	6	F	V	f	v			ı	¶	Æ	Ö	æ	ö
7			'	7	G	W	g	w			§	·	Ç	×	ç	÷
8			(8	H	X	h	x			¨	,	È	Ø	è	ø
9)	9	I	Y	i	y			©	¹	É	Ù	é	ù
A			*	:	J	Z	j	z			ª	º	Ê	Ú	ê	ú
B			+	;	K	[k	{			«	»	Ë	Û	ë	û
C			,	<	L	\	l				¬	¼	Ì	Ü	ì	ü
D			-	=	M]	m	}				½	Í	Ý	í	ý
E			.	>	N	^	n	~			®	¾	Î	Þ	î	þ
F			/	?	O	_	o				¯	¿	Ï	ß	ï	ÿ

Central European (ANSI 1250)

	0	1	2	3	4	5	6	7	8	9	A	B	C	D	E	F
0			0	@	P	`	p	€			°	°	Á	Ð	á	ð
1			!	1	À	Q	a	q			˘	˘	Á	Ñ	á	ñ
2			”	2	B	R	b	r	,	'	˘	˘	Â	Ñ	â	ñ
3			#	3	C	S	c	s		“	‡	‡	Ã	Ó	ã	ó
4			\$	4	D	T	d	t	„	”	¤	´	Ä	Ô	ä	ô
5			%	5	E	U	e	u	…	•	¥	µ	É	Ó	é	ó
6			&	6	F	V	f	v	†	-	ı	¶	Ć	Ö	ć	ö
7			'	7	G	W	g	w	‡	-	§	·	Ç	×	ç	÷
8			(8	H	X	h	x			¨	,	Č	Ř	č	ř
9)	9	I	Y	i	y	%	™	©	ª	É	Ù	é	ù
A			*	:	J	Z	j	z	Š	š	§	§	Ę	Ú	ę	ú
B			+	;	K	[k	{	<	>	«	»	Ë	Û	ë	û
C			,	<	L	\	l		Ś	ś	¬	ˆ	Ě	Ů	ě	ů
D			-	=	M]	m	}	ř	ť	-	ˆ	Í	Ý	í	ý
E			.	>	N	^	n	~	ž	ž	®	™	Î	Þ	î	þ
F			/	?	O	_	o		Ž	ž	Ž	ž	Ď	B	ď	·

Baltic (ANSI 1257)

	0	1	2	3	4	5	6	7	8	9	A	B	C	D	E	F
0				0	@	P	`	p	€			°	Ā	Š	ą	š
1			!	1	A	Q	a	q		`		±	Į	Ń	ı	ń
2			”	2	B	R	b	r	,	’	ϕ	²	Ā	Ņ	ā	ņ
3			#	3	C	S	c	s		“	£	³	Ć	Ó	ć	ó
4			\$	4	D	T	d	t	„	”	¤	´	Ä	Ō	ä	ō
5			%	5	E	U	e	u	…	•		μ	Å	Õ	å	õ
6			&	6	F	V	f	v	†	-	ı	¶	Ę	Ö	ę	ö
7			’	7	G	W	g	w	‡	-	§	·	Ē	×	e	÷
8			(8	H	X	h	x			Ø	ø	Č	Ů	č	ů
9)	9	I	Y	i	y	%	™	©	’	É	Ł	é	ł
A			*	:	J	Z	j	z			®	ı	Ż	Ś	ż	ś
B			+	;	K	[k	{	<	>	«	»	É	Ū	é	ū
C			,	<	L	\	l				¬	¼	Ğ	Ü	ğ	ü
D			-	=	M]	m	}	“	”	-	½	Ķ	Ž	ķ	ž
E			.	>	N	^	n	~	˘	˙	©	¾	Ī	Ž	ı	ž
F			/	?	O	_	o		˚		€	æ	Ł	ß	ł	·

Cyrillic (ANSI 1251)

	0	1	2	3	4	5	6	7	8	9	A	B	C	D	E	F
0				0	@	P	`	p	б	ђ		°	А	Р	а	р
1			!	1	А	Q	a	q	ѓ	`	ў	±	Б	С	б	с
2			”	2	В	Р	b	r	,	’	ў	ı	В	Т	в	т
3			#	3	С	S	c	s	ѓ	“	Ј	ı	Г	У	г	у
4			\$	4	Д	Т	d	t	„	”	¤	ı	Д	Ф	д	ф
5			%	5	Е	U	e	u	…	•	Г	μ	Е	Х	e	x
6			&	6	Ф	V	f	v	†	-	ı	¶	Ж	Ц	ж	ц
7			’	7	Г	W	g	w	‡	-	§	·	З	Ч	з	ч
8			(8	Н	X	h	x	€		Ё	ё	И	Ш	и	ш
9)	9	И	Y	i	y	%	™	©	®	Й	Щ	й	щ
A			*	:	Ј	Z	j	z	љ	љ	Є	є	К	ъ	к	ъ
B			+	;	К	[k	{	<	>	«	»	Л	ъ	л	ъ
C			,	<	Л	\	l		њ	њ	¬	ј	М	ъ	м	ъ
D			-	=	М]	m	}	ќ	ќ	-	ѕ	Н	Э	н	э
E			.	>	Н	^	n	~	ћ	ћ	©	ѕ	О	Ю	о	ю
F			/	?	О	_	o		џ	џ	İ	ı	П	Я	п	я

Japanese Font (JIS X0201)

	0	1	2	3	4	5	6	7	8	9	A	B	C	D	E	F
0				0	@	P	`	p				-	タ	ミ		
1			!	1	A	Q	a	q			。	ア	チ	ム		
2			"	2	B	R	b	r			「	イ	ツ	メ		
3			#	3	C	S	c	s			」	ウ	テ	モ		
4			\$	4	D	T	d	t			、	エ	ト	ヤ		
5			%	5	E	U	e	u			・	オ	ナ	ユ		
6			&	6	F	V	f	v			ヲ	カ	ニ	ヨ		
7			'	7	G	W	g	w			ァ	キ	ヌ	ラ		
8			(8	H	X	h	x			ィ	ク	ネ	リ		
9)	9	I	Y	i	y			ゥ	ケ	ノ	ル		
A			*	:	J	Z	j	z			ェ	コ	ハ	レ		
B			+	;	K	[k	{			ォ	サ	ヒ	ロ		
C			,	<	L	¥	l				ャ	シ	フ	ワ		
D			-	=	M]	m	}			ュ	ス	ヘ	ソ		
E			.	>	N	^	n	~			ョ	セ	ホ	ッ		
F			/	?	O	_	o				ッツ	ソ	マ	°		

Control Codes

Refer to the following table when using control codes in User Communications.

	0	1	2	3	4	5	6	7	8	9	A	B	C	D	E	F
0	NUL	DEL														
1	SOH	DC1														
2	STX	DC2														
3	ETX	DC3														
4	EOT	DC4														
5	ENQ	NAK														
6	ACK	SYN														
7	BEL	ETB														
8	BS	CAN														
9	HT	EM														
A	LF	SUB														
B	VT	ESC														
C	FF	FS														
D	CR	GS														
E	SO	RS														
F	SI	US														

1.3 Available Number of Colors

The available number of colors that can be used on the WindO/I-NV4 are listed below.

Model	Target	Number of colors
HG2J-7U, HG5G/4G/3G/2G-V, HG4G/3G, HG2G-5F/-5T* ¹ , HG1G/1P	Picture Manager	65536 colors
	Drawing objects and Properties sheet	256 colors
HG2G-5T* ²	Picture Manager	Monochrome (16 shades)
	Drawing objects and Properties sheet	Monochrome (16 shades)

1.4 Available Image Files

The image file formats that can be displayed on the MICRO/I are as follows.

File format	Description
JPEG	Supports JPEG files that conform to the JPEG standard (ISO/IEC 10918-1, ITU-T Recommendation T.81) that adopt baseline DCT coding. The JFIF extension specification is not supported.
Bitmap	Supports monochrome bitmaps, 16-color bitmaps, 256-color bitmaps, and 24-bit bitmaps in which data is stored from the bottom up. Run-length encoding is only supported for 256-color bitmaps.



- The MICRO/I cannot handle image files that are larger than the size of the screen. Images that exceed the screen size are not displayed.
- The Numerical Input, Character Input, Message Display, Message Switching Display, Numerical Display, Calendar, and Meter cannot correctly display pictures that use a transparent color.
- IDEC recommends using bitmap image files when display speed is a priority. JPEG image files take more time to display on the MICRO/I than bitmap image files.

● About Picture Manager

Picture Manager is an application for managing pictures used for part diagrams and drawings.

- When saving, deleting, or reducing pictures, the following operations are displayed in Picture Manager.
 - On the **View** tab, in the **Workspace** group, click  (Picture Manager).
 - Double click **Picture Manager** in the **Project** window.
- To set up the Picture from the Drawings, click on the editing screen where the Picture is positioned to display Picture Manager.
- If setting a graphic for a positioned object, display Picture Manager from the Properties dialog box.

*1 Color LCD models

*2 Monochrome LCD models

● Saving pictures in Picture Manager

This section describes how to save drawing objects in Picture Manager. Saved pictures can be used for part diagrams and drawings.

Saving image files

- 1 Click **Import** in Picture Manager.
The Open dialog box is displayed.

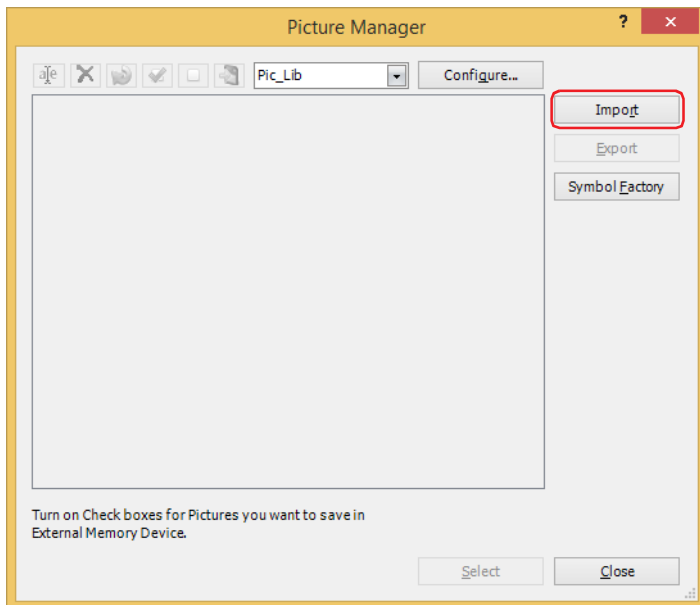

When managing pictures by category, create a new category, and select it. To create a category, click **Configure**, and then click  (New Category) on the Category dialog box. For details, refer to "Category Dialog Box" on page 2-31.

- 2 Specify the image file, and then click **Open**.

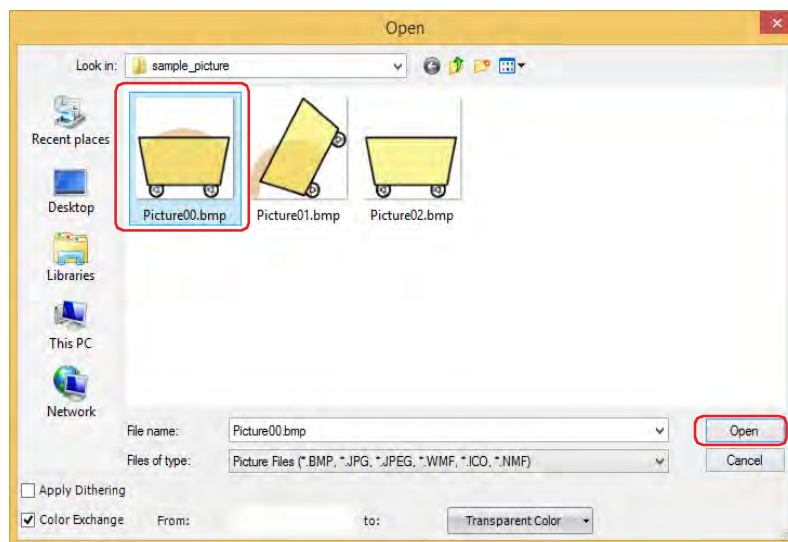

Click **Options** to **Apply Dithering** or **Color Exchange**. For details, refer to "Open Dialog Box" on page 2-30.

The picture is saved in Picture Manager. The name of the image file becomes the picture name.

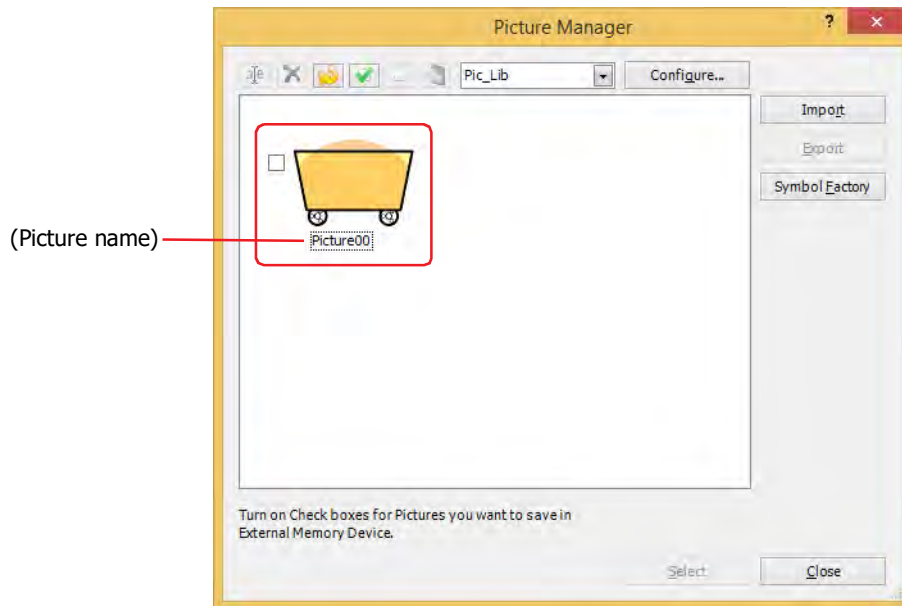

- Even when the image is saved to a different category, if a picture of the same name is already saved in that category, a confirmation message to overwrite the file is displayed.
 - Click **Yes** to overwrite the image.
After overwriting, the image is saved in the list of the selected category, and the previous image is deleted from the list.
 - Example: The picture "Picture00" is saved in the category "Pic_Lib."
If the picture "Picture00.bmp" is saved to the category "NewBook1," the new image "Picture00" is saved to "NewBook1," and the image named "Picture00" that was previously in "Pic_Lib" is deleted.
 - Click **No** to stop saving the picture.
- If a picture is imported that is larger than the screen size, it will be automatically shrunk.

Selecting pictures from Symbol Factory

- 1 Click **Symbol Factory** in Picture Manager.
Symbol Factory is displayed.

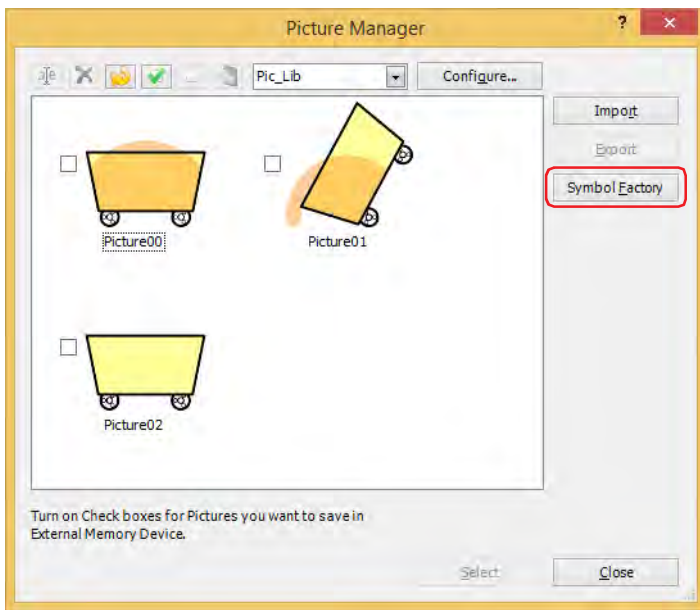

When managing pictures by category, create a new category, and select it. To create a category, click **Configure**, and then click  (New Category) on the Category dialog box. For details, refer to "Category Dialog Box" on page 2-31.

- 2 Select a category of pictures from **Categories**.
A list showing pictures in the category selected from **Symbols** is displayed.

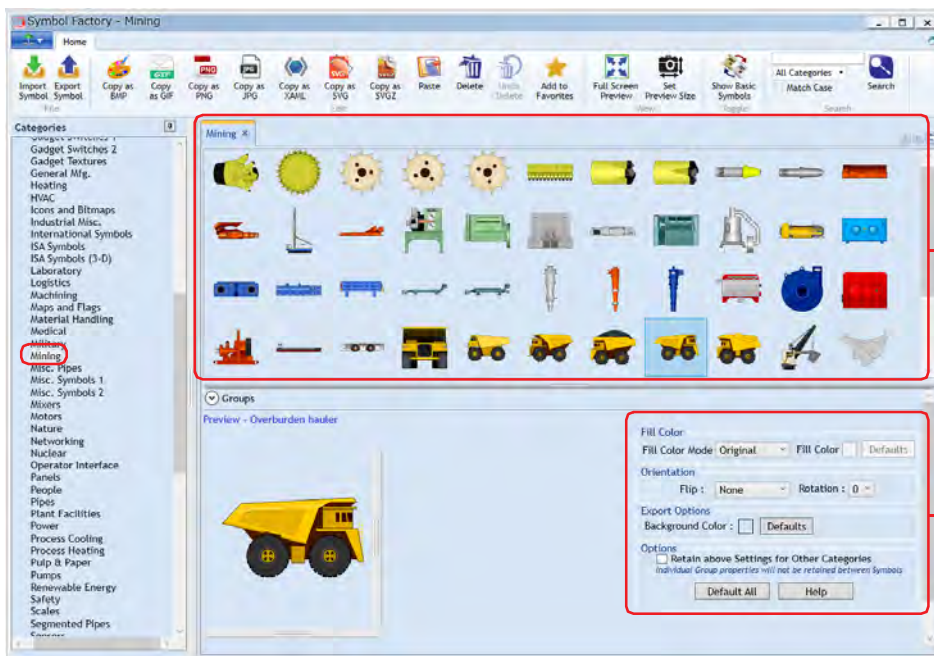

(Categories tab)

(Symbol Options)



By using the settings in **(Symbol Options)**, you can modify fill color and background color, and to flip or rotate shapes. For details, refer to "Symbol Options" on page 2-33.

3 Select a picture from (**Categories tab**) to display it in **Preview**.

The size of the picture displayed in **Preview** is equal the size of the registered picture.



The size of the picture displayed in **Preview** can be changed.

1. Right-click the picture displayed in **Preview**, then click **Set Preview Size**.
The Set Preview Size dialog box is displayed.
2. Specify the width and the height, and click **OK**.
Preview shows the picture with the specified size.
For details, refer to " Set Preview Size Dialog Box" on page 2-35.

4 Right-click the picture displayed in **Preview**, then click **Copy**.

The Picture Name Setting dialog box is displayed.



You can also display the Picture Name Settings dialog box by double-clicking a picture displayed in Preview.

5 Enter the name of the graphic in **Picture Name**.

The maximum number is 256 characters.



You cannot use the following characters in the picture name.

HG2J-7U: " # \$ & ' () * / : ; < > ? \ ` | ~
 HG5G/4G/3G/2G-V, HG4G/3G, HG2G-5F/-5T, HG1G/1P: " * / : < > ? \ |

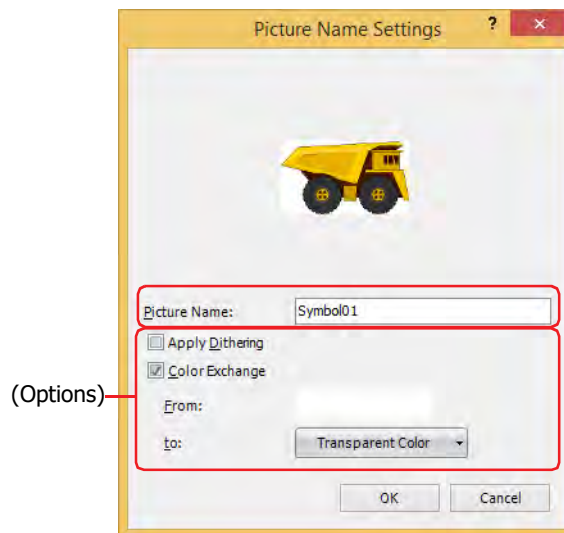

Configures the image processing in **Options**. For details, refer to "Picture Name Setting Dialog Box" on page 2-36.

- 6 Click **OK**.
The picture is saved in Picture Manager.

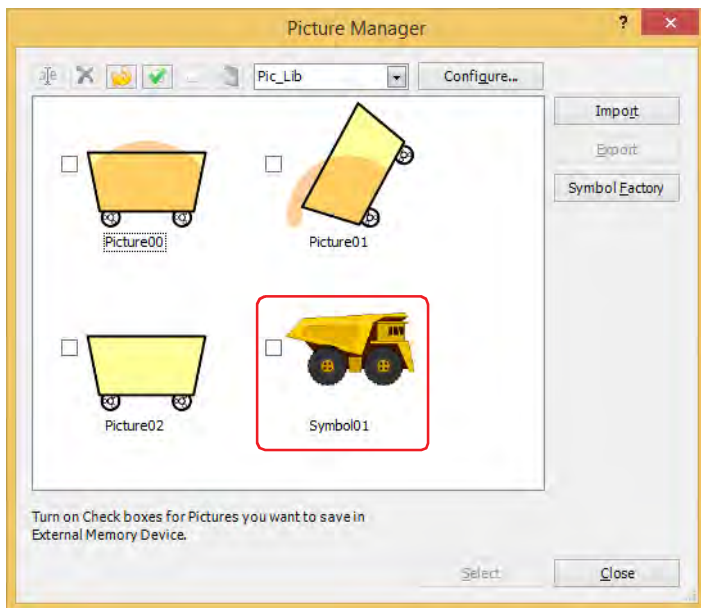

If a picture contains transparency or **Transparent Color** is selected as **to** for the imported picture, the transparency range is displayed in magenta (R: 255, G: 4, B: 255).

Saving drawing objects drawn on the editing screen

Drawing objects drawn on the editing screen are saved as pictures, in NMF (NV Metafile) format in Picture Manager.

- 1 Select and right-click the drawing object, then click **Copy to Picture Manager**.
The Picture Name Setting dialog box is displayed.

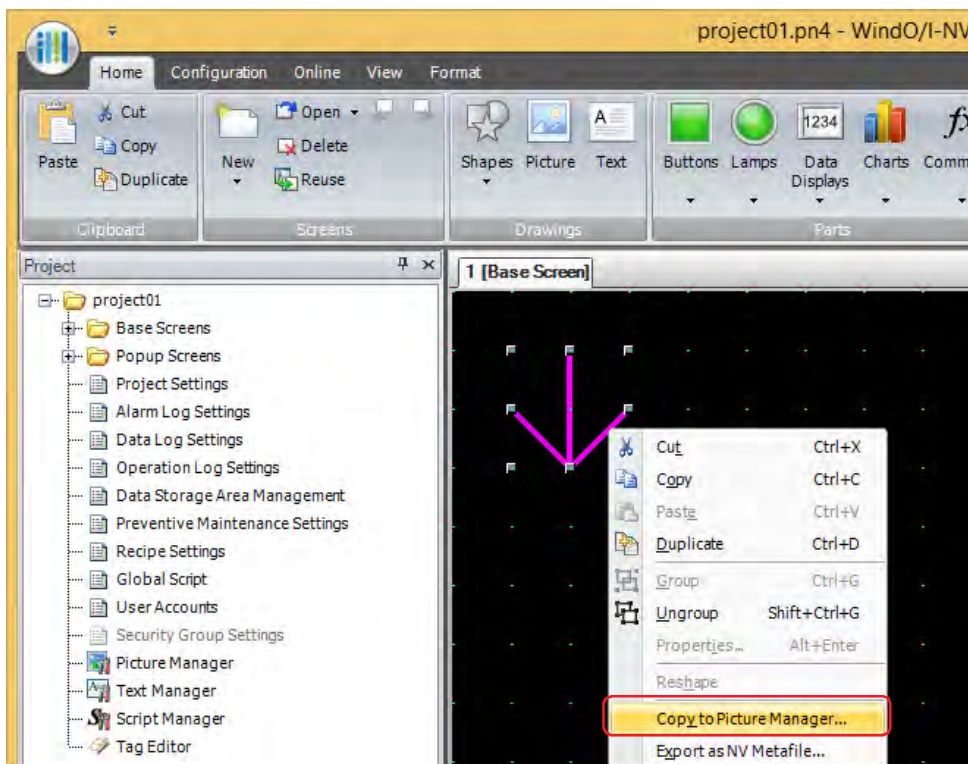

Grouped drawing objects can be saved to Picture Manager as a single picture.

2 Enter the name of the drawing object in **Picture Name**.

The maximum number is 256 characters.



You cannot use the following characters in the picture name.

HG2J-7U: " # \$ & ' () * / : ; < > ? \ ` | ~

HG5G/4G/3G/2G-V, HG4G/3G, HG2G-5F/-5T, HG1G/1P: " * / : < > ? \ |

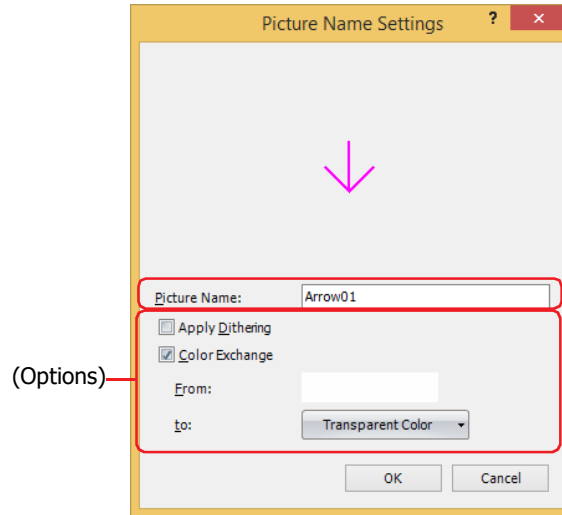

Configures the image processing in **Options**. For details, refer to "Picture Name Setting Dialog Box" on page 2-36.

3 Click **OK**.

The drawing object is saved in Picture Manager.

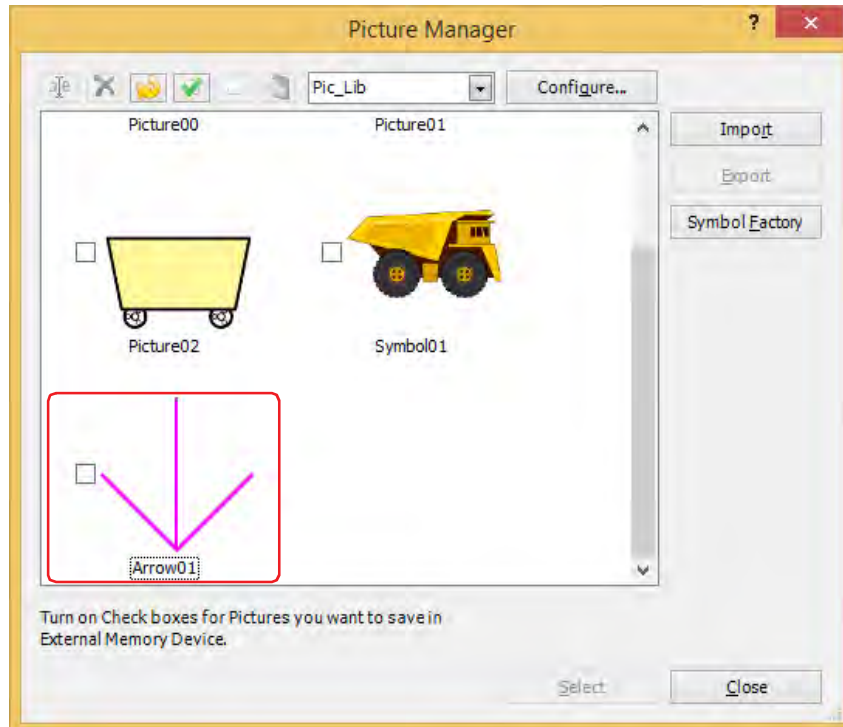

If a picture contains transparency or a picture is imported with the option of enabling the transparency, the transparency range is displayed in magenta (R: 255, G: 4, B: 255).

● Saving pictures as image files

HG2J-7U HG5G-V HG4G-V HG4G HG3G-V HG3G HG2G-V HG2G-5F HG2G-5T HG1G HG1P

To use a picture saved in Picture Manager on another computer, save the picture as an image file.

1 Select a picture to export, and then click **Export**.

The Browse For Folder dialog box is displayed.



- To select multiple pictures, press and hold SHIFT or CTRL while you click the specific items.
- To save as an image file in NMF (NV Metafile) format, select and right-click the drawing object drawn on the editing screen, then click **Export as NV Metafile**.

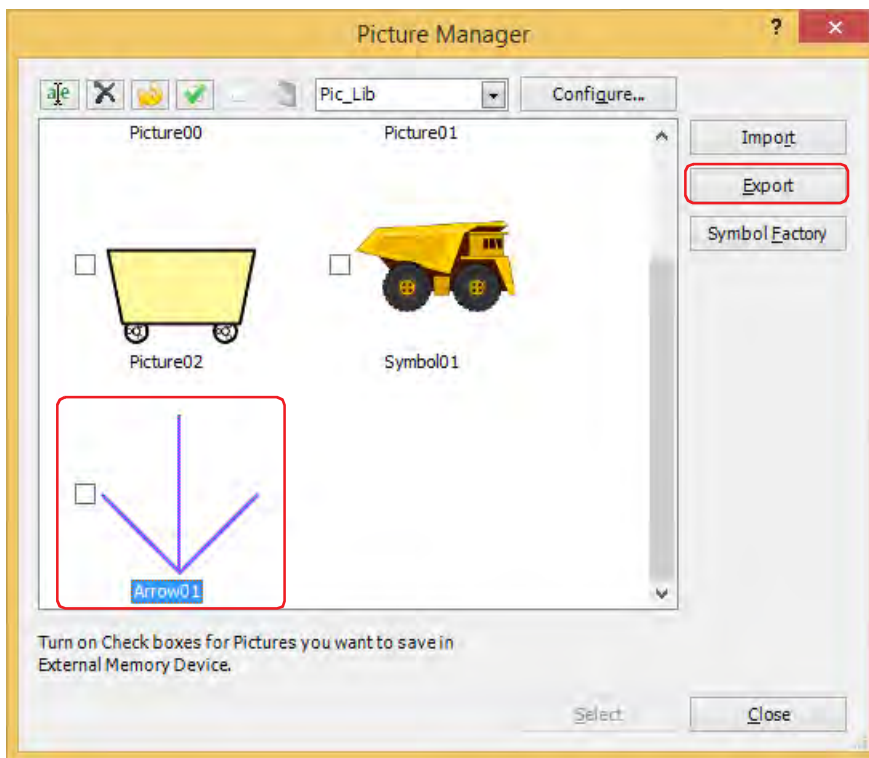

2 Select the folder to save, and then click **OK**.

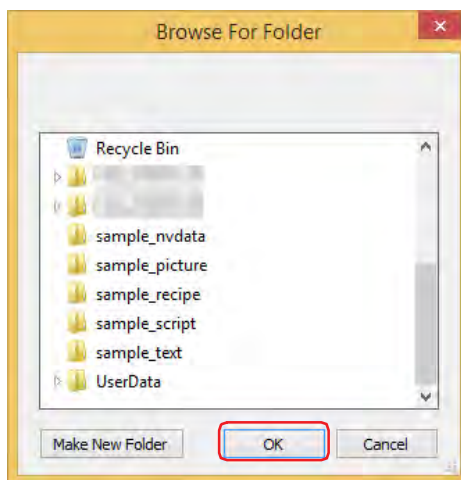

● Picture Manager

Pictures used in pictures of part diagrams and drawings are managed using Picture Manager.

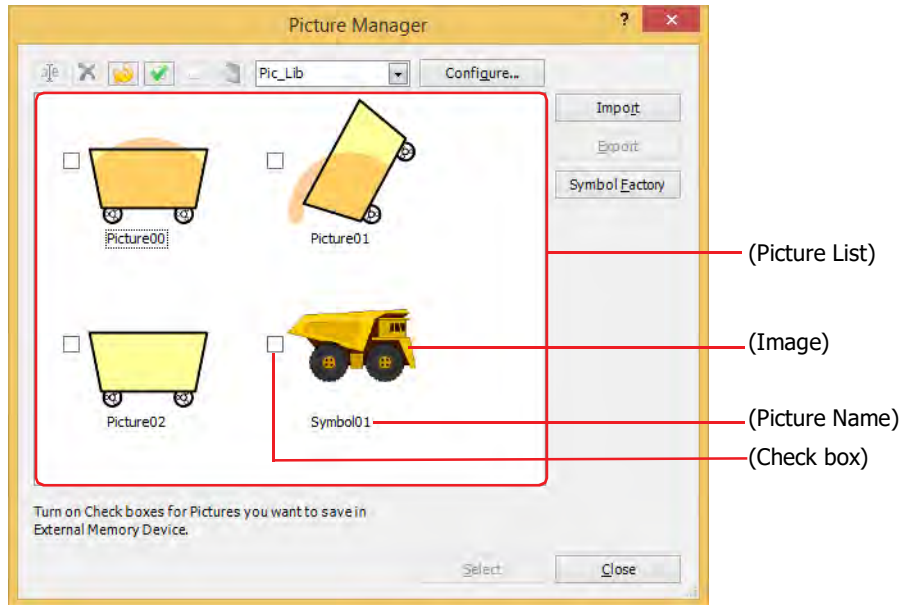

■ (Rename picture)

Renames the picture selected in the picture list. The maximum number is 256 characters.



You cannot use the following characters in the picture name.

HG2J-7U: " # \$ & ' () * / : ; < > ? \ ` | ~

HG5G/4G/3G/2G-V, HG4G/3G, HG2G-5F/-5T, HG1G/1P: " * / : < > ? \ |

■ (Delete)

Deletes the picture selected in the picture list. Pictures that are used in project or parts cannot be deleted.

■ (Reduce)

Deletes all the pictures not used in the project from the pictures saved in the picture list.

■ (Check All)

Selects all of the check boxes for the pictures registered to the picture list.

■ (Reset)

Clears all of the check boxes for the pictures registered to the picture list.

■ (Save Picture Files in External Memory Device)

Saves the image files for the pictures selected with the check boxes to external memory device.

Click this button to display the Select Drive dialog box.

■ (Category)

The name of the category is displayed.

Selects a category to save to when saving pictures.

When selecting a picture, select the category in which the arranged picture is saved.

The only default category is "Pic_Lib." To add a category, click **Configure**, and then click  (New Category) in the Category dialog box.

■ **Configure**

Opens the Category dialog box. You can add or change the category to save. For details, refer to "Category Dialog Box" on page 2-31.

■ (Picture list)

The saved pictures are displayed as a list of images.

(Image): An image of the picture is displayed. If a picture contains transparency or a picture is imported with the option of enabling the transparency, the transparency range is displayed in magenta (R: 255, G: 4, B: 255).

(Picture Name): The name of the picture is displayed.

(Check box): Select this check box to save the picture data to external memory device and use it.

Click  (Write Picture Files to External Memory Device) to save the image files for the pictures selected with the check boxes to external memory device.



When the picture data is saved to external memory device, the amount of project data can be decreased, which allows you to save the internal memory on the MICRO/I. However, the display update rate of the pictures will become slower. To give priority to the display update rate, clear the check boxes.



If you place the cursor near an (Image) or (Picture Name), the size of the picture (width) x (height) and the file size (kilobytes) is displayed in a popup.

■ Import

Save pictures in Picture Manager. Click this button to display the Open dialog box. For details, refer to "Saving image files" on page 2-21.

Supported file formats are as follows. When selecting images that are in WMF or ICO file format, the image is converted to a bitmap before saving.

- BMP (bitmap file)
- WMF (Windows Metafile)
- JPEG
- ICO (icon files)
- NMF (NV Metafile)*¹

■ Export

Saves a picture selected in the picture list in BMP (bitmap), JPEG, or NMF (NV Metafile) file format*¹, according to file type. Click this button to display the Browse For Folder dialog box. For details, refer to "Saving pictures as image files" on page 2-27.

Saved graphics can be saved using **Import**.

■ Symbol Factory

Display the Symbol Factory images. You can select an image provided by Symbol Factory on your project data. For details, refer to "Symbol Factory" on page 2-32.

■ Select

Closes Picture Manager and sets the picture selected in the picture list.

■ Close

Closes Picture Manager.

*1 HG5G/4G/3G/2G-V, HG4G/3G, HG2G-5F/-5T, HG1G/1P only

Open Dialog Box

By clicking **Options**, you have the option to set the **Apply Dithering** and **Color Exchange** for the image to be registered in the Picture Manager.

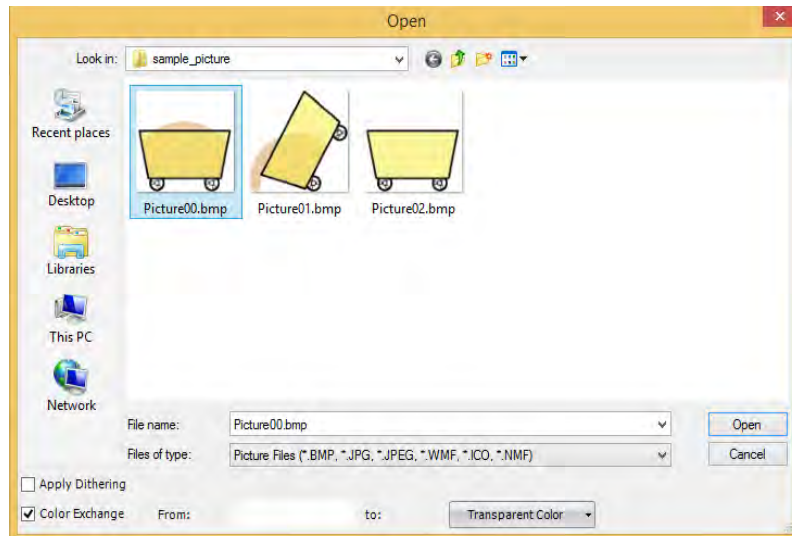

■ **Apply Dithering**

Selects this check box to perform dithering (error diffusion method) on images.

This function enables some images with tonal gradations and photo-like pictures to be rendered more beautifully when they are saved.

■ **Color Exchange**

Selects this check box to convert the color of the picture.

From: Specifies color before conversion. Click this button to display the Color Settings dialog box. Specify the color, and then click **OK**.

to: Selects the color after conversion (color: 256 colors, monochrome: 16 shades). Click this button to display the Color Palette. Select a color from the Color Palette. **Transparent Color** can also be selected.



If a color conversion to transparent is done when the monitor used for WindO/I-NV4 is a 16-bit color or 256-color display, even colors other than the color specified in **From** may appear transparent. However, on the MICRO/I they will appear normally.

Category Dialog Box

Manage the categories where pictures are registered.

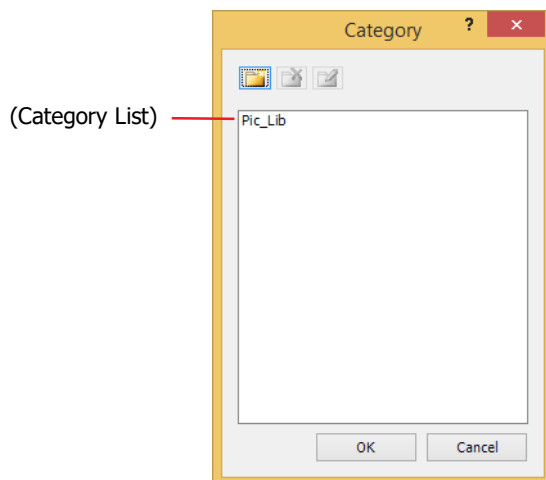

■ (New Category)

Creates a new category in the **Category List**.

The default category name is "NewBook n " (n : Number).

■ (Delete Category)

Deletes a category from the **Category List**.

■ (Rename Category)

Changes the name of the category selected in the **Category List**. The maximum number is 256 characters.



You cannot use the following characters in the category name.

" * / : < > ? \ |

■ (Category List)

The name of the category is displayed.

Symbol Factory

Symbol Factory is an English-version library tool that offers 5,000 images.

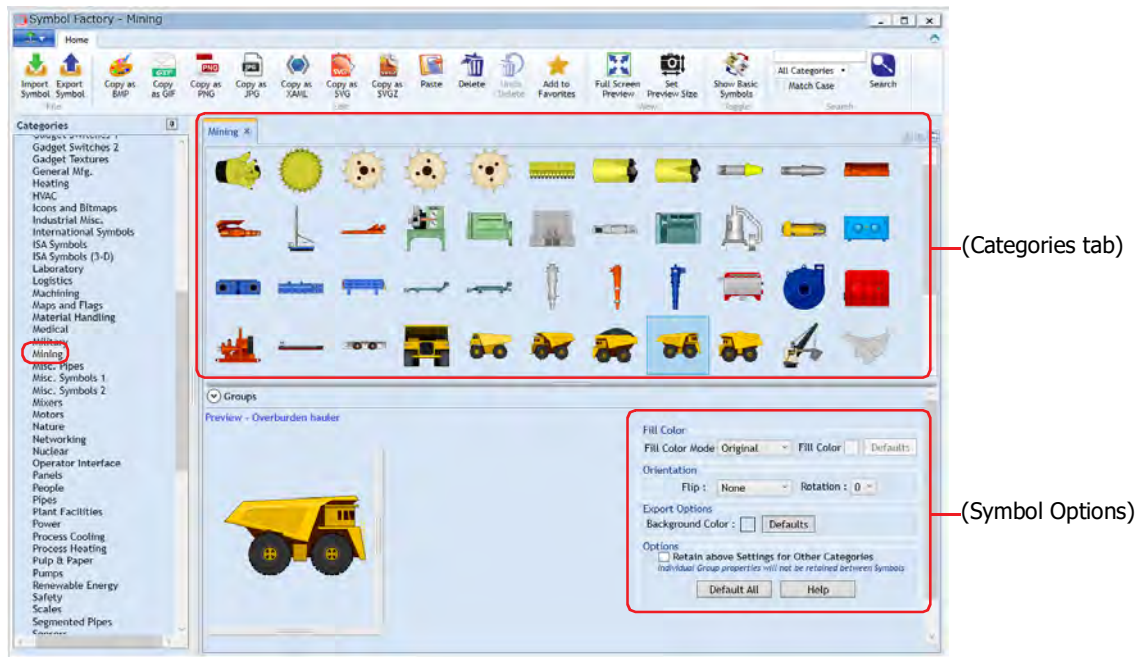

For details, see online help for Symbol Factory.

■ Categories

The images supplied by Symbol Factory are divided into categories. Selects categories of pictures saved in Picture Manager.

■ (Categories tab)

Opens a tab for a category name selected from **Categories**, and shows a list of pictures. Selects a picture saved in Picture Manager.

■ Preview

Display a picture selected from (**Categories tab**) according to (**Symbol Options**) setting.

■ (Symbol Options)

Modify the fill and background color and flip or rotate shapes. For details, refer to "Symbol Options" on page 2-33.

Symbol Options

Modify the fill color and background color, and to flip or rotate a picture selected in (**Categories tab**).

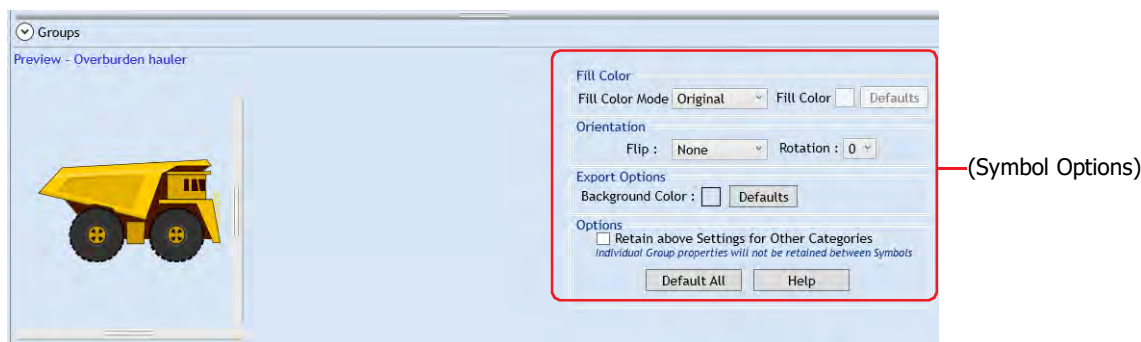

■ Fill Color

Fill Color Mode: Select from the following picture color conversion methods.

- Original: The color of the image is not changed.
- Shaded: The image filled with different shades of the color selected in **Fill Color** (for a 3D effect).
- Solid: The image is filled uniformly in the color selected in **Fill Color**.
- Hollow: All color is deleted.

Fill Color: Selects the color used for **Shaded** or **Solid** modes. Click this button to display the Color Settings dialog box. Select a color from the Color Palette.

This option can only be set when **Shaded** or **Solid** are selected as the **Fill Color Mode**.

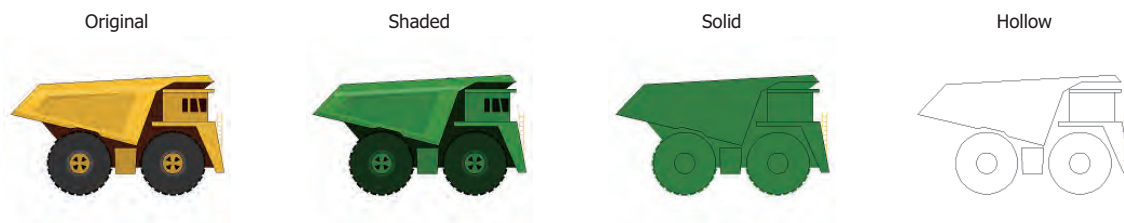

Defaults: Returns all settings in **Fill Color** to their default.

■ Orientation

Flip: Select from the following flipping methods.

- None: The image is not flipped.
- Horizontal: The image is flipped horizontally.
- Vertical: The image is flipped vertically.
- Both: The image is flipped both horizontally and vertically.

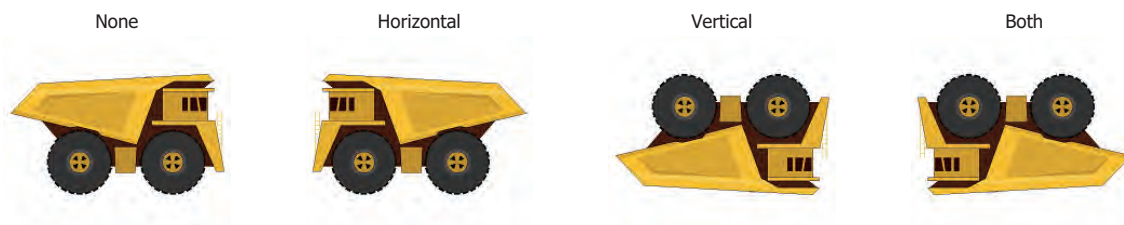

Rotation: Select from the following rotation methods.

0: The image is not rotated.

90: The image is rotated 90° counterclockwise.

180: The image is rotated 180° counterclockwise.

270: The image is rotated 270° counterclockwise.

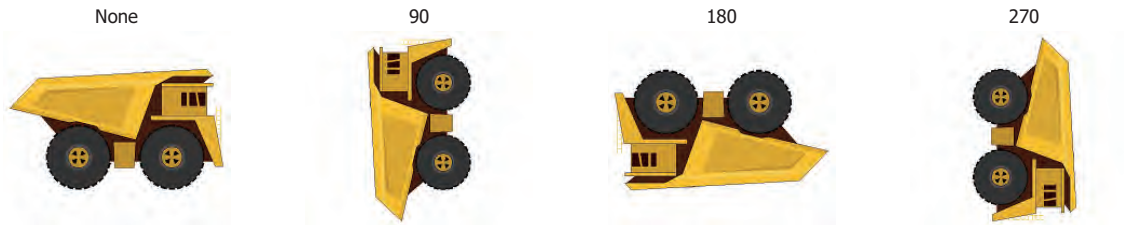

■ Export Options

Background Color: Selects the background color of the image when saving an image in Picture Manager or exporting an image using **Export** from the right-click menu. Click this button to display the Color Settings dialog box. Select a color from the Color Palette.

Defaults: Returns the background color configured to the picture to default.



When exporting an image in the following formats by clicking **Export** from the right-click menu, this setting is not applied.

GIF, PNG, SVG, VML, WMF, XAML

■ Options

Retain above Settings for Other Categories: Select this check box to keep (**Symbol Options**) settings.

Default All: Returns the settings in **Fill Color**, **Orientation** and **Export Options** to their default.

Help: Displays the Symbol Factory Help.

Set Preview Size Dialog Box

Configures the size of picture selected from (**Categories tab**).

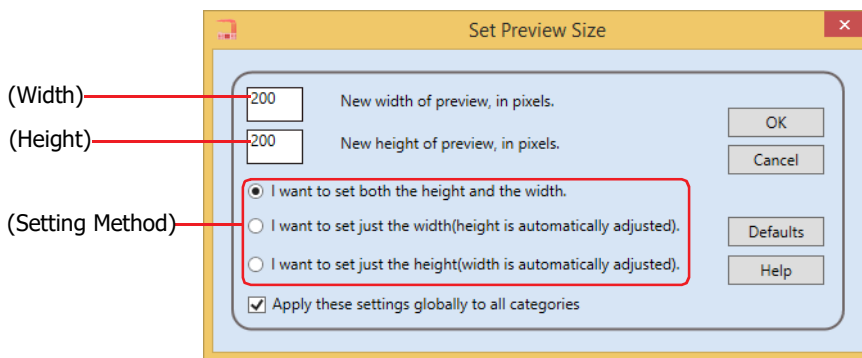

- **(Width)**

Enters the width of the picture in pixels.

- **(Height)**

Enters the height of the picture in pixels.

- **(Setting Method)**

Selects the setting method of the picture size from the following.

I want to set both the height and the width:

Change the width and the height of a picture individually. Enters the width and the height of the picture.

I want to set just the width(height is automatically adjusted). :

Lock aspect ratio and change the size of a picture. Enters the width of the picture only.

I want to set just the height(width is automatically adjusted). :

Lock aspect ratio and change the size of a picture. Enters the height of the picture only.

- **Apply these settings globally to all categories**

Select this check box to apply the specified size to all pictures.

If this check box is not selected, applies to the picture selected in (**Categories tab**).

- **Defaults**

Returns the size configured to the picture to default.

- **Help**

Displays the Symbol Factory Help.

Picture Name Setting Dialog Box

Specifies a name for images saved in Picture Manager.

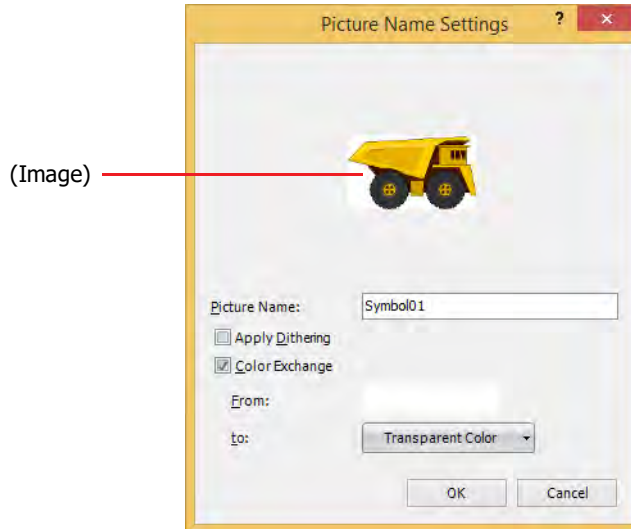

- **(Image)**

An image of the picture is displayed.

- **Picture Name**

Enter a name for the picture. The maximum number is 256 characters.



You cannot use the following characters in the picture name.

HG2J-7U: " # \$ & ' () * / : ; < > ? \ ` | ~

HG5G/4G/3G/2G-V, HG4G/3G, HG2G-5F/-5T, HG1G/1P: " * / : < > ? \ |

- **Apply Dithering**

Select this check box to perform dithering (error diffusion method) on images.

This function enables some images with tonal gradations and photo-like pictures to be rendered more beautifully when they are saved.

- **Color Exchange**

Select this check box to convert the color of the picture.

From: Specifies color before conversion. Click this button to display the Color Settings dialog box. Specify the color, and then click **OK**.

to: Selects the color after conversion (color: 256 colors, monochrome: 16 shades). Click this button to display the Color Palette. Select a color from the Color Palette. **Transparent Color** can also be selected.



To make the background color of the picture saved from Symbol Factory transparent, set **From** and **Background Color** in **(Symbol Options)** to R: 254, G: 254, B: 254.

1.5 Available Sound Files

HG2J-7U HG5G-V HG4G-V HG4G HG3G-V HG3G HG2G-V HG2G-5F HG2G-5T HG1G HG1P

The sound file formats that can be played on the MICRO/I are as follows.

Item	Description
File format	Wave files (.wav)
Data format	PCM
Sampling rate	8000, 11025, 12000, 16000, 24000, 22050, 32000, 44100, 48000* ¹ Hz
Quantization bit rate	16-bit
Audio type	Mono or stereo
File size	Max. 512 KB

1.6 Available Movie Files

HG2J-7U HG5G-V HG4G-V HG4G HG3G-V HG3G HG2G-V HG2G-5F HG2G-5T HG1G HG1P

Movie files that meet the following specifications can be played with the MICRO/I:

Item	Description
File format	HG5G/4G/3G-V: AVI file (.avi) HG4G/3G: MP4 file (.mp4)
Movie	HG5G/4G/3G-V: Motion JPEG HG4G/3G: MPEG-4 Simple Profile
Audio	HG5G/4G/3G-V: PMC (Sampling rate 8000, 11025, 12000, 16000, 24000, 22050, 32000, 44100 Hz) HG4G/3G: AAC-LC (Bit rate 32 kbps or less recommended)
Frame rate	30 fps or less (15 fps or less recommended)
Resolution	720 x 480 dots or less (640 x 480 dots or less recommended)
File size	64 Mbyte or less (32 Mbyte or less recommended)

The MICRO/I may not be able to play the formats above correctly depending on the minimum system requirements. In this situation, shrink the size of the file by lowering the frame rate or the resolution of the file or by lowering the bit rate of the audio. If audio is unnecessary, set to a file without sound.

Movie files is only supported by models that are equipped with a video interface.

*1 HG2J-7U only

2 Starting and Exiting WindO/I-NV4

2.1 Starting WindO/I-NV4

- **Windows 10**

Click **Start**, click **All Apps**, click **IDEC Automation Organizer**, and then click **WindOI-NV4**.

- **Windows 8**

On the **Start** screen tiles, click **WindOI-NV4**.

- **Windows 7**

Click **Start**, click **Programs**, click **IDEC Automation Organizer**, and then click **WindOI-NV4**.

WindO/I-NV4 starts.



You can also start WindO/I-NV4 by double-clicking WindO/I-NV4 icon on the desktop.

● Automation Organizer Updater Dialog Box

Automation Organizer Updater dialog box is a feature that keeps WindO/I-NV4 up to date.

If a new version of Automation Organizer is released, the Automation Organizer Updater dialog box is displayed when WindO/I-NV4 starts.

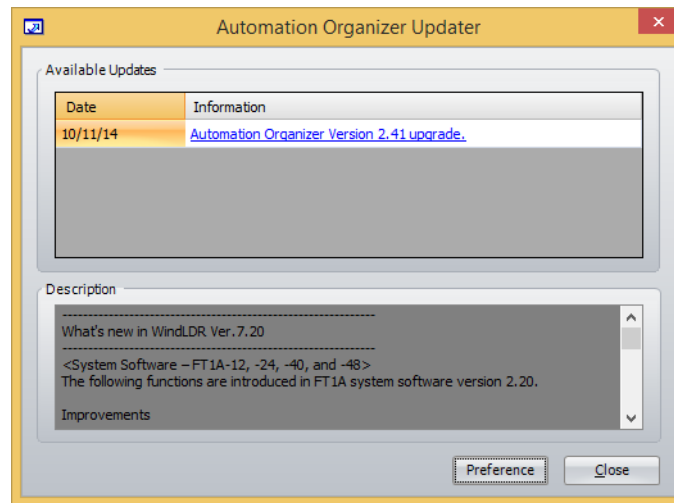

In order to display the Automation Organizer Updater, your computer must be connected to the Internet.

■ Available Updates

Date Shows the date the software was released.

Information Shows the software's title and version.

Click on this link to connect to IDEC's download site.

The software can be updated by downloading and running the latest version.

■ Description

This area shows the details of the latest changes in the software.

■ Preference

The Update Preference dialog box is displayed when this button is clicked.

To update information when WindO/I-NV4 starts, check this check box.

The Automation Organizer Updater dialog box will be displayed when there is an update.

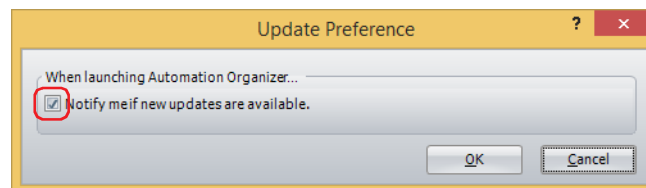

■ Close

Closes the Automation Organizer Updater dialog box and start WindO/I-NV4.

● Project Recovery Dialog Box

The Project Recovery dialog box is a feature to restore edited project data if your computer crashes while you were editing. With this feature, you can return crashed the project to its last-saved state and restore project data that was being edited. The Project Recovery dialog box is displayed if there is crashed project data when WindO/I-NV4 starts.

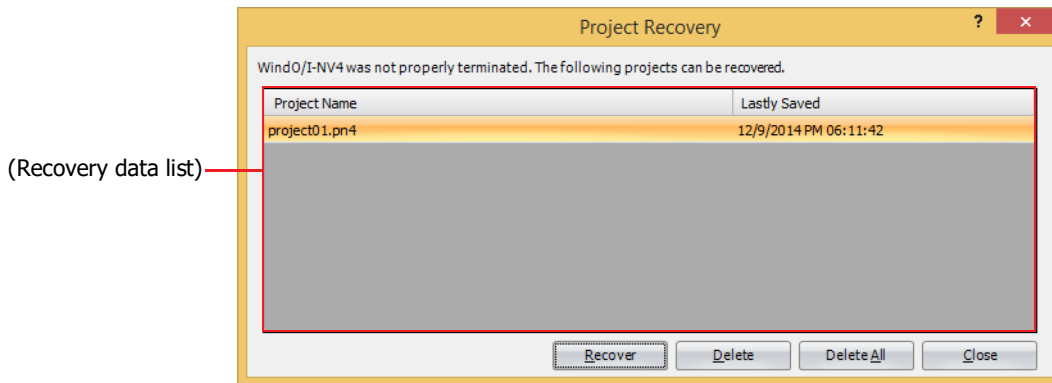

■ (Recovery data list)

This list shows recoverable data for a crashed project.

Project Name: Shows the project name.

Last Save Time: Shows the date and time when the data was last saved.

■ Recover

Select the recovery data from the list and click this button to open the project data. The recovery data is deleted when the project data is saved.

■ Delete

Deletes the selected recovery data.

■ Delete All

Deletes all recovery data.

■ Close

Closes the Project Recovery dialog box.

Recovery data is not deleted. The Project Recovery dialog box will be displayed again the next time WindO/I-NV4 starts.



If WindO/I-NV4 crashes in a state where you edit a screen and perform **Save Screens** after saving the project data, the screen is not saved in the project data. Select the recovery data with the Project Recovery dialog box and recover the project data.

2.2 Exiting WindO/I-NV4

Click  and then click **Exit WindO/I-NV4**.

WindO/I-NV4 ends.

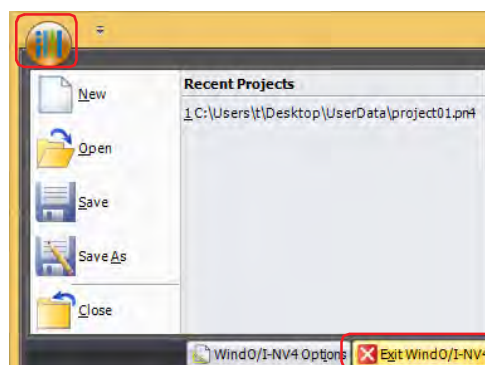

3 Configuration & Functions

This section describes the names and functions that make up WindO/I-NV4.

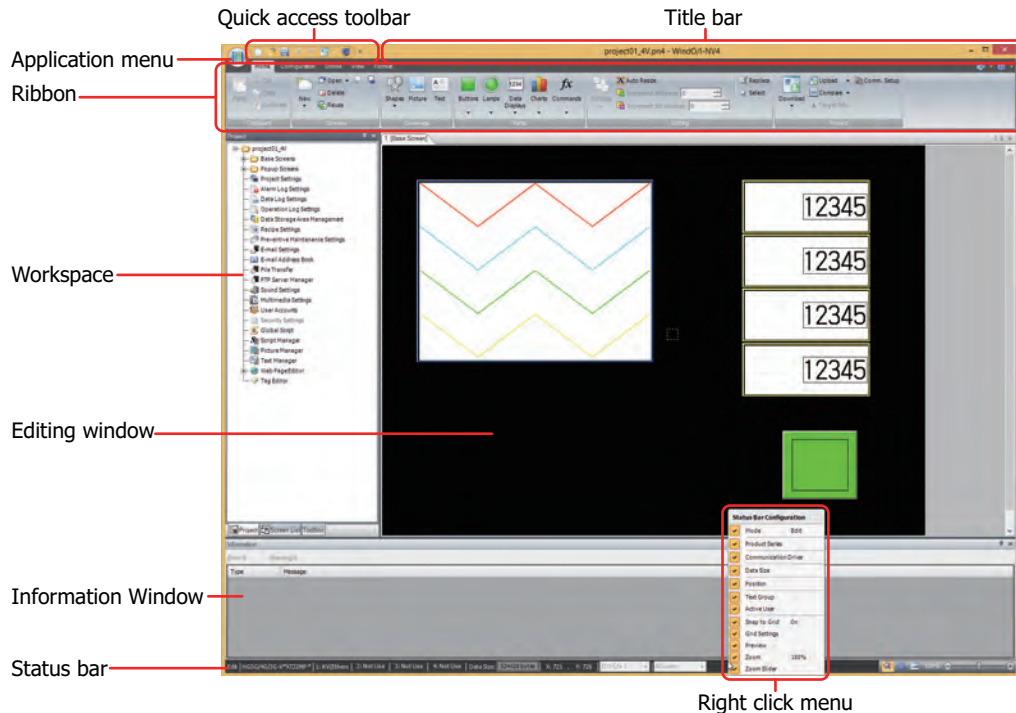

■ Title bar

The title bar shows the name of the project being edited and the name of this software, "WindO/I-NV4".

■ Application menu

The application menu displays commands for handling project data such as commands for creating new project data, opening project data, and saving project data. For details, refer to "3.1 Application Menu Command List" on page 2-42.

■ Quick access toolbar

The quick access toolbar is an area where you can locate commands that you use frequently. You can customize this toolbar by adding or deleting buttons. For details, refer to "3.2 Quick Access Toolbar" on page 2-43.

■ Ribbon

The ribbon shows commands for creating project data and transferring data to the MICRO/I. Common commands are separated into their own tabs, so you can quickly execute. For details, refer to "3.3 Ribbon Command List" on page 2-46.

■ Workspace

The workspace is the area where the **Project** window, the **Object List** window, the **Part Library** window, the **Toolbox** window, etc. are located. You can change the position and method for displaying windows in the workspace. For details, refer to "3.4 Windows Displayed in the Workspace" on page 2-55.

■ Editing window

The editing window is the area for editing Base Screens and Popup Screens.

■ Right click menu

The right click menu is a popup menu that is displayed when right clicking the mouse on drawing objects and parts in a list. It displays context sensitive commands.

■ Status bar

The status bar shows information such as the type number, communication driver, project data size, and cursor position. You can change the items displayed on the status bar. For details, refer to "3.5 Status Bar" on page 2-58.

■ Information Window

When the following operations are executed and an error is found in the project, displays a list of the error messages. Download, Starting the Simulator, Changing Communication Drivers, Changing Product Series

3.1 Application Menu Command List

Commands that can be executed from the application button are listed below.

Command	Description
New	Creates project data by configuring settings displayed in dialog boxes step by step.
Open	Opens project data that has already been created.
Save	Saves the project data being edited.
Save As	Saves the project data being edited with a new name.
Print	Outputs the project data being edited to a printer or Word file.
Close	Closes the project data being edited.
Recent Projects	Shows the list of recently used project data, up to a maximum of ten items.
WindO/I-NV4 Options	Customizes WindO/I-NV4 and configures the work environment.
Exit WindO/I-NV4	Exits WindO/I-NV4.

3.2 Quick Access Toolbar

● Quick access toolbar buttons and menus

Click on a quick access toolbar button or click on ▼ to the right of a button and then click on the displayed command to execute that command.



● Customizing the quick access toolbar

If you click the ▼ (Customize Quick Access Toolbar) button, the Customize Quick Access Toolbar menu is displayed. You can change the quick access toolbar to any desired settings.

■ Changing the buttons displayed on the quick access toolbar

Check only the buttons you wish to display on the quick access toolbar.

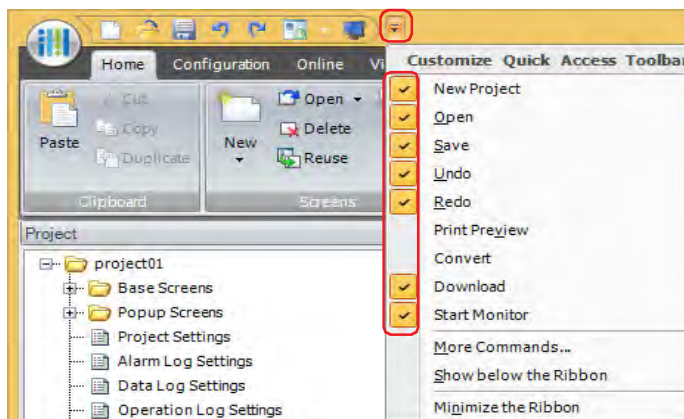

■ More Commands

You can add or delete quick access toolbar commands.

- 1 Click the ▼ button on the quick access toolbar and then click **More Commands**.

The **Quick access toolbar** on the WindO/I-NV4 Options dialog box is displayed.

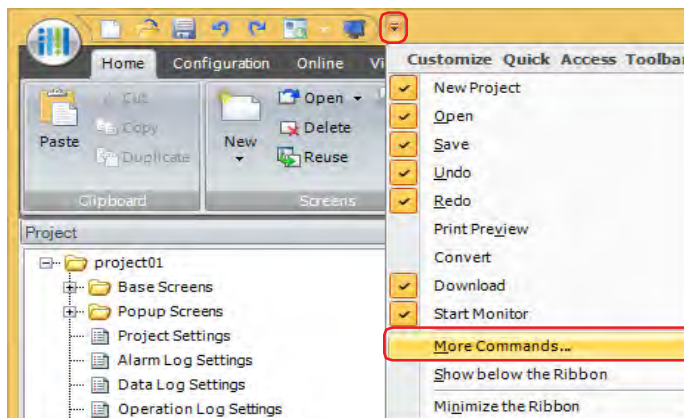

2 Add or delete commands.

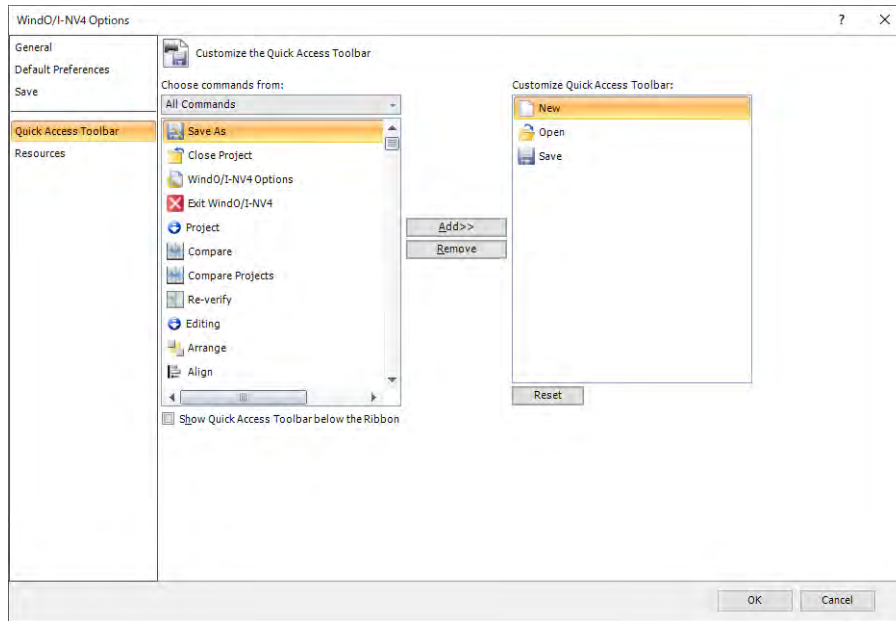

To add a command

- 1 Select the command to add in **Choose commands from**.
- 2 Click on the command to add from the list and then click the **Add>>** button.
The command is added.

To delete a command

Click the command to delete and then click the **Remove** button.

The command is deleted.



- If you right click a command on the quick access toolbar and click **Remove from Quick Access Toolbar**, that quick access toolbar command can be deleted.
- To change the order of the commands, drag and drop a command.
- To return to the quick access toolbar to its default settings, click the **Reset** button.

■ Show below the Ribbon

You can change the position of the quick access toolbar to be located below the ribbon.

Click the  button on the quick access toolbar and then click **Show below the Ribbon**.

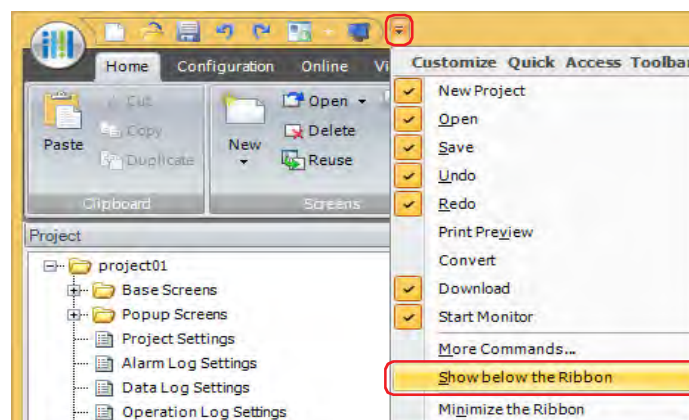

The quick access toolbar moves below the ribbon.

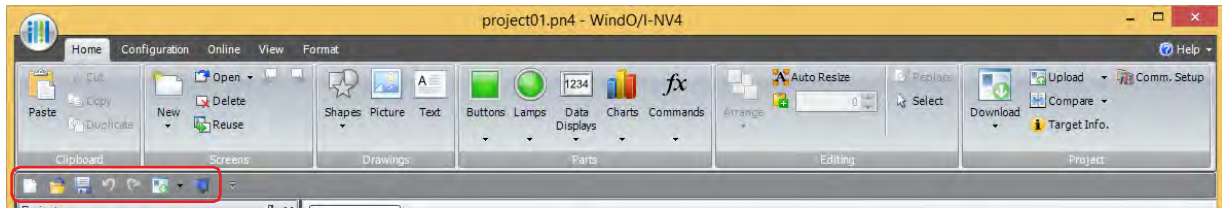

You can also change the quick access toolbar display position to be below the ribbon with the following methods.

- Right click the quick access toolbar or the ribbon and then click **Show below the Ribbon**.
- Select the **Show Quick Access Toolbar below the Ribbon** check box on the **Customize** on the WindO/I-NV4 Options dialog box.

To return the quick access toolbar to its original position, click the  button and then click **Show above the Ribbon**.



You can also return the quick access toolbar to its original position with the following methods.

- Right click the quick access toolbar or the ribbon and then click **Show above the Ribbon**.
- Select the **Show Quick Access Toolbar below the Ribbon** check box on the **Customize** on the WindO/I-NV4 Options dialog box.

■ Minimize the Ribbon

You can change the format of the ribbon to be displayed only as tabs.

Click the  button on the quick access toolbar and then click **Minimize the Ribbon**.

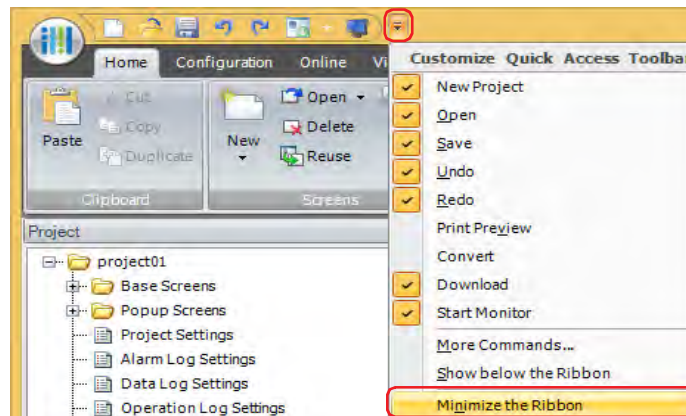

The ribbon is displayed as only tabs.

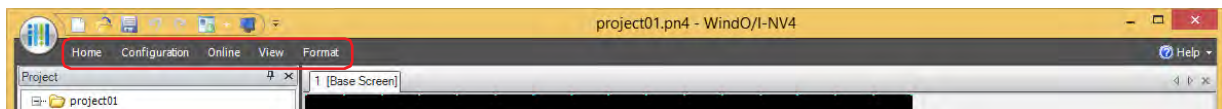

Click on a tab to display its commands.

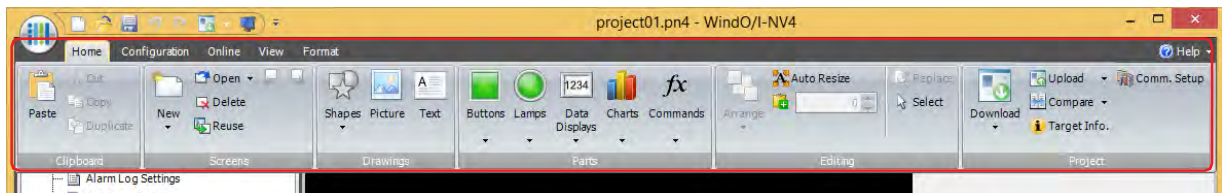

To return the ribbon to its original state, click the  button and then click on the **Maximize the Ribbon**.



You can also change the ribbon to be displayed as only tabs with the following methods.

- Right click the quick access toolbar or the ribbon and then click **Minimize the Ribbon** when switching to the tab only display, or click **Maximize the Ribbon** when returning to the original state.
- Double click a tab.

3.3 Ribbon Command List

- Home

Home is where basic operations are performed such as creating a new screen, editing, and downloading project data.

- Clipboard

Command	Description
Paste	Pastes the contents of the clipboard.
Cut	Cuts the selected object from the editing window and copies it to the clipboard.
Copy	Copies the selected object to the clipboard.
Duplicate	Duplicates the selected object.

- Screens

Command	Description	
New	Base Screen	Adds a new Base Screen.
	Popup Screen	Adds a new Popup Screen.
	Password Input Screens	Adds a new Password Input Screen to the active project data.
		Opens a screen that has already been created.
Open	Base Screen	Opens a Base Screen that has already been created.
	Popup Screen	Opens a Popup Screen that has already been created.
	Password Input Screens	Opens a Password Input Screen that has already been created.
Open Previous Screen	Opens a screen number before the currently selected screen.	
Open Next Screen	Opens a screen number after the currently selected screen.	
Delete	Deletes the selected screen.	
Reuse	Copies another project's screens.	

- Drawings

Command	Description	
Shapes	Line	Draws a line.
	Polyline	Draws a polyline.
	Polygon	Draws a polygon.
	Rectangle	Draws a rectangle.
	Circle/Ellipse	Draws a circle or ellipse.
	Arc	Draws an arc.
	Pie	Draws a pie.
	Equilateral Polygons	Draws equilateral polygons (equilateral triangle, equilateral diamond, equilateral pentagon, equilateral hexagon, equilateral octagon).
	Fill ^{*1}	Fills the region with the same color as the fill start point with the specified color and pattern.
Picture	Inserts a picture.	
Text	Inserts text.	

*1 HG5G/4G/3G/2G-V, HG4G/3G, HG2G-5F/-5T, HG1G/1P only

■ Parts

	Command	Description
Buttons	Bit Button	Inserts a Bit Button.
	Word Button	Inserts a Word Button.
	Goto Screen Button	Inserts a Goto Screen Button.
	Print Button	Inserts a Print Button.
	Key Button	Inserts a Key Button.
	Multi-Button	Inserts a Multi-Button.
	Keypad	Inserts a Keypad.
	Selector Switch*1	Inserts a Selector Switch.
	Potentiometer*1	Inserts a Potentiometer.
Lamps	Pilot Lamp	Inserts a Pilot Lamp.
	Multi-State Lamp	Inserts a Multi-State Lamp.
Data Displays	Numerical Input	Inserts a Numerical Input.
	Character Input	Inserts a Character Input.
	Picture Display	Inserts a Picture Display.
	Video Display*2	Inserts a Video Display.
	Message Display	Inserts a Message Display.
	Message Switching Display	Inserts a Message Switching Display.
	Alarm List Display	Inserts an Alarm List Display.
	Alarm Log Display	Inserts an Alarm Log Display.
	Data Log Display	Inserts a Data Log Display.
	Numerical Display	Inserts a Numerical Display.
	Calendar	Inserts a Calendar.
Charts	Bar Chart	Inserts a Bar Chart.
	Line Chart	Inserts a Line Chart.
	Pie Chart	Inserts a Pie Chart.
	Meter	Inserts a Meter.
Commands	Bit Write Command	Inserts a Bit Write Command.
	Word Write Command	Inserts a Word Write Command.
	Goto Screen Command	Inserts a Goto Screen Command.
	Print Command	Inserts a Print Command.
	Script Command	Inserts a Script Command.
	Multi-Command	Inserts a Multi-Command.
	Timer	Inserts a Timer.

*1 HG5G/4G/3G/2G-V, HG4G/3G, HG2G-5F/-5T, HG1G/1P only

*2 HG5G/4G/3G-V, HG4G/3G with a video interface only

■ Editing

Command		Description	
Arrange	Bring to Front	Moves the selected object to the front.	
	Send to Back	Moves the selected object to the back.	
	Group	Groups multiple objects.	
	Ungroup	Cancels the group.	
	Align	Align Left	Aligns selected objects to the left.
		Align Center	Aligns selected objects to the center.
		Align Right	Aligns selected objects to the right.
		Align Top	Aligns selected objects to the top.
		Align Middle	Aligns selected objects to the middle.
		Align Bottom	Aligns selected objects to the bottom.
		Make Horizontal Spacing Equal	Aligns selected objects to be equally spaced horizontally.
		Make Vertical Spacing Equal	Aligns selected objects to be equally spaced vertically.
	Rotate	Rotate Right 90°	Rotates selected drawing objects 90° to the right.
		Rotate Left 90°	Rotates selected drawing objects 90° to the left.
		Flip Vertical	Flips selected drawing objects vertically.
		Flip Horizontal	Flips selected drawing objects horizontally.
Replace* ³		Automatically replaces a specified device address with a separate device address.	
Select		Selects objects in the editing window.	
AutoResize* ³		Automatically changes the text size to the object's size and display region. A specific value is added to the device address number of the object when pasting and duplicating parts.	
Increment Bit Number* ⁴		Enables or disables the increment bit number function. A specific value is added to the bit number of the object when pasting and duplicating parts.	

■ Project

Command		Description
Download		Downloads project data to the MICRO/I.
	Project Data	This is the same as clicking the Download icon.
	Files to External Memory Device	Stops the MICRO/I and then downloads files to the external memory device inserted in the MICRO/I. The MICRO/I resumes running when files have finished downloading.
	Files to External Memory Device while running	Downloads files to the external memory device inserted in the MICRO/I without stopping it.
	Runtime System of Expansion Modules* ⁵	Downloads the system software to the expansion modules attached to the MICRO/I.
Upload		Uploads project data from the MICRO/I.
	Project Data	This is the same as clicking the Upload icon.
	Stored Data in External Memory Device	Uploads data from the External Memory Device folder for the currently running project.

*³ For the following external devices, this feature cannot be used because the device address format is different.

- The **Manufacturer** is **ABB** or **Emerson**

- The **Manufacturer** is **Allen-Bradley** and the **Communication Driver** is **Logix Native Tag(Ethernet)**

*⁴ For the following external devices, this feature cannot be used because the device address format is different.

- The **Manufacturer** is Emerson

- The **Manufacturer** is **Allen-Bradley** and the **Communication Driver** is **Logix Native Tag(Ethernet)**

*⁵ HG5G/4G/3G/2G-V only

Command	Description	
Compare	Compares the screen data and scripts in an existing project with the project data currently being edited and displays the results of that comparison.	
	Compare Projects	This is the same as clicking the Compare icon.
	Re-verify	Updates the comparison results to the most latest state.
Target Info.	Displays version information for the MICRO/I system software and project information.	
Comm.Setup	Configures the communication target and communication conditions between the target and the MICRO/I or between the computer and the MICRO/I.	

● Configuration

Configuration is where you configure the system settings for the MICRO/I that will use the project data being edited.

■ System Setup

Command	Description
Project	Configures MICRO/I operations and functions.
Alarm Log	Configures the alarm log.
Data Log	Configures the data log.
Operation Log	Configures the operation log.
Data Storage Area	Changes the allocation of the data storage area.
Recipe	Configures recipes.
Preventive Maintenance	Configures the preventative maintenance function.
E-mail	Configures the e-mail function.
Social Media ^{*1}	Configures the social media function.
File Transfer Settings	Configures the file transfer function (FTP client function).
Sound ^{*2}	Configures the sound function.
Multimedia Function ^{*3}	Configures the multimedia function.
Global Script	Configures one global script.

■ Protect

Command	Description
User Accounts	Configures security function, user accounts, and passwords.

■ Editor

Command	Description
Web Page Editor	Shows the Web Page Editor. Creates a Custom Web Page.

■ Manager

Command	Description
Picture Manager	Shows the Picture Manager. Manages the registered images for project use.
Text Manager	Shows the Text Manager. Manages registered text which can be used for Text, Part objects, title of Popup Screen, messages with Alarm List Display and Alarm Log Display.
Script Manager	Shows the Script Manager. Manages registered scripts for project use.
Protocol Manager	Shows the Protocol Manager. Manages protocols created.
E-mail Address Book	Shows the E-mail Address Book. Manages e-mail addresses.
FTP Server Manager	Shows the FTP Server Manager. Manages FTP servers.

*1 HG2J-7U only

*2 This is applicable for HG2J-7U and the models with an audio interface only.

*3 HG5G/4G/3G-V, HG4G/3G with a video interface only.

- Online

Online is where you download created project data and files to the MICRO/I, where you upload data from the MICRO/I, and where you perform monitoring.

- Transfer

Command		Description
Download		Downloads project data to the MICRO/I.
	Project Data	This is the same as clicking the Download icon.
	Files to External Memory Device	Stops the MICRO/I and then downloads files to the external memory device inserted in the MICRO/I. The MICRO/I resumes running when files have finished downloading.
	Files to External Memory Device while running	Downloads files to the external memory device inserted in the MICRO/I without stopping it.
	Runtime System of Expansion Modules ^{*1}	Downloads the system software to the expansion modules attached to the MICRO/I.
Upload		Uploads project data from the MICRO/I.
	Project Data	This is the same as clicking the Upload icon.
	Stored Data in External Memory Device	Uploads data from the External Memory Device folder for the currently running project.

- MICRO/I

Command		Description
Target Info.		Displays version information for the MICRO/I system software and project information.
Clear	All	Clears all of the data stored in the internal memory on the MICRO/I.
	Alarm Log Data	Clears all of the alarm log data stored in the internal memory on the MICRO/I.
	Data Log Data	Clears all of the data log data stored in the internal memory on the MICRO/I.
	Operation Log Data	Clears all of the operation log data stored in the internal memory on the MICRO/I.
	Values from All Device Addresses	Clears the values from all device addresses.
	Stored Data in External Memory Device	Clears data saved to the external memory device inserted in the MICRO/I.
Format ^{*2}		Formats the external memory device inserted in the MICRO/I.

*1 HG5G/4G/3G/2G-V only

*2 HG5G/4G/3G/2G-V, HG4G/3G, HG2G-5F/-5T, HG1G/1P only

■ Monitors

Command		Description
Start/Stop Monitor		Starts or stops monitoring the MICRO/I with WindO/I-NV4. An external device is required when configuring it.
Go Offline/Online		Switch the MICRO/I to Offline Mode or Online Mode. Under Offline Mode, you can change values of device addresses with WindO/I-NV4 and check the operation of project data on the MICRO/I.
Screens		Shows or hides the Screen Monitor window.
Object List		Displays a value of device address in a popup and emphasizes the object that is satisfying the trigger condition in the object list or script editor.
Custom		Shows or hides the Custom Monitor window.
Batch		Shows or hides the Batch Monitor window.
External Devices		Shows or hides the External Device Monitor window during 1:N communication.
Open Current Screens		Opens a monitored screen in the editing window.
Back		Returns to the Base Screen that was displayed immediately before the screen was changed.
Forward		Advances to the Base Screen that was displayed immediately before the screen was changed with the Back command.
Go to Screen	First Screen	Switches to the Base Screen with the smallest screen number in the project data.
	Previous Screen	Switches to the Base Screen with a screen number one smaller than the Base Screen currently displayed. If the screen numbers are not consecutive numbers, this command switches to the closest number.
	Screen Number	Switches to the Base Screen with a specified number.
	Next Screen	Switches to the Base Screen with a screen number one larger than the Base Screen currently displayed. If the screen numbers are not consecutive numbers, this command switches to the closest number.
	Last Screen	Switches to the Base Screen with the largest screen number in the project data.

■ Simulator

Command		Description
Simulator		Launch Simulator.
	Load Value of Device Address (External Device, LK, LKR) and Run	Load the project data, and the values of device addresses on the external devices, HMI Keep Relays (LK), and HMI Keep Registers (LKR), and then launch Simulator.
	Clear Value of Device Address (External Device, LK, LKR) and Run	Clear Value of Device Address (External Device, LK, LKR) and Run

■ Communication

Command		Description
Setup		Configures the communication target and communication conditions between the target and the MICRO/I or between the computer and the MICRO/I.

● View

View is where you can switch the workspace display and display the Tag Editor, Screen Diagram, and various managers.

You can configure the items displayed in the editing window.

■ Workspace

Command	Description
Project Window	Shows the Project window. This window displays the saved screens and project related information.
Screen List	Shows the Screen List window. The window displays the screens saved in the project as thumbnails.
Object List	Shows the Object List window. This window displays all of the graphics and parts placed in an editing screen.
Part Library	Shows the Part Library window. The part designs are listed in a window. You can select a design from the displayed list and drag and drop it from the library screen to the edit screen to create a screen. You can also register drawings, parts, and grouped parts on the editing screen.
Tag Editor	Shows the Tag Editor. This window displays the list of registered device address, tag name, and comments.
Comparison Result	Shows the Comparison Result window. This window displays the results of that comparison of projects.
Screen Diagram	Shows the Screen Diagram. This window displays the Overlapping Screen information, and the screen numbers and titles of the screens linked by the Goto Screen Button, the Goto Screen Command, the Numerical Input, the Character Input, the Alarm List Display and the Alarm Log Display.
Toolbox	Shows the Toolbox window. This window displays Parts and Drawings.
Information	Shows the Information window. This window displays various information such as error message.

■ Show/Hide

Command	Description	
Part Name	Shows or hides drawing object names and part names.	
Device Address	Shows or hides device addresses and tag names.	
Trigger Condition	Shows or hides trigger conditions.	
Security Group	Display	Shows or hides the display security group set for parts.
	Input	Shows or hides the input security group set for parts.
Top Layer	Shows or hides drawing objects and parts placed on the top layer.	
Popup Screen	Shows or hides a Popup Screen's number, display frame, and the part name of the part calling that Popup Screen.	
Overlay Screens	Shows or hides the configured overlay screens.	
Commands	Shows or hides the dotted frame for commands.	
Gridlines	Shows or hides the gridlines in the editing window.	

■ Screens

Command		Description
Focus Order		Changes the order to move the focus with Numerical Input and Character Input.
State	Reset	Returns the displayed images to the default images.
	ON/OFF State	Switches between the ON image and the OFF image for buttons and lamps.
	Previous State	Changes the image for the displayed part to the previous state.
	State Number	Changes the image for the displayed part to the image for the part with the specified number.
	Next State	Changes the image for the displayed part to the next state.
Active User		Displays only the parts that correspond to the specified user.
Text Group		Changes the displayed text to the text of the specified text group.

■ Zoom

Command	Description
Zoom	Changes the magnification of the editing window.

■ Window

Command	Description
Close All	Closes all editing windows.

● Format

Format is where you change the style of drawing objects, arrange objects, and change their size.

■ Shape Style

Command	Description
1 dot	Sets the line width to one dot.
2 dots	Sets the line width to two dots.
3 dots	Sets the line width to three dots.
5 dots	Sets the line width to five dots.
Solid	Sets the line to solid.
Dot	Sets the line to dotted.
Dash	Sets the line to dashes.
Long Dash	Sets the line to long dashes.
Long Dash Dot	Sets the line to long dash dot.
Long Dash Dot Dot	Sets the line to long dash dot dot.
Pattern	Changes the pattern.
Foreground Color	Changes the pattern's foreground color.
Background Color	Changes the pattern's background color.

■ Text Style

Command	Description
Regular*1	Sets the text style to regular.
Bold*1	Sets the text style to bold.
Shadow*1	Gives the text a shadow.
Text Color	Changes the text color.
Text Background Color	Displays the text as if it were highlighted with a highlighter.
Shadow Color*1	Changes the color of the shadow added to text given a shadow.

*1 HG5G/4G/3G/2G-V, HG4G/3G, HG2G-5F/-5T, HG1G/1P only

■ Arrange

Command	Description
X-coordinate	Changes the X-coordinate of the selected object.
Y-coordinate	Changes the Y-coordinate of the selected object.
Bring to Front	Moves selected object to the front.
Send to Back	Moves selected object to the back.
Group	Groups selected objects so they can be handled as a single object.
Ungroup	Restores a grouped object to its individual objects.
Rotate Right 90°	Rotates selected objects right 90°.
Rotate Left 90°	Rotates selected objects left 90°.
Flip Vertical	Vertically flips selected objects.
Flip Horizontal	Horizontally flips selected objects.
Align Left	Aligns selected objects to the left.
Align Center	Aligns selected objects to the center.
Align Right	Aligns selected objects to the right.
Align Top	Aligns selected objects to the top.
Align Middle	Aligns selected objects to the middle.
Align Bottom	Aligns selected objects to the bottom.
Make Horizontal Spacing Equal	Arranges selected objects to be equally spaced horizontally.
Make Vertical Spacing Equal	Arranges selected objects to be equally spaced vertically.

■ Size

Command	Description
Width	Changes the width of the selected object.
Height	Changes the height of the selected object.
Make Same Width	Makes the selected objects a uniform width.
Make Same Height	Makes the selected objects a uniform height.

3.4 Windows Displayed in the Workspace

● Changing the position of windows

Disabling docking

You can change the display position of the window by dragging and dropping the title bar of the window or its tab to disable docking. Windows that are not docked are called floating windows.

- If you drag the title bar of the workspace window, you can move all the docked windows together.

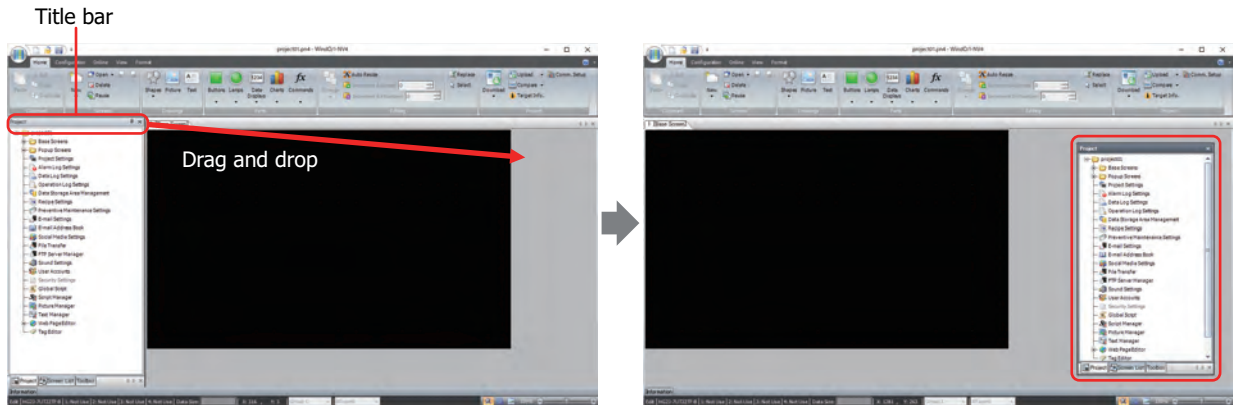

- If you drag the tab of a workspace window, you can move just the selected window.

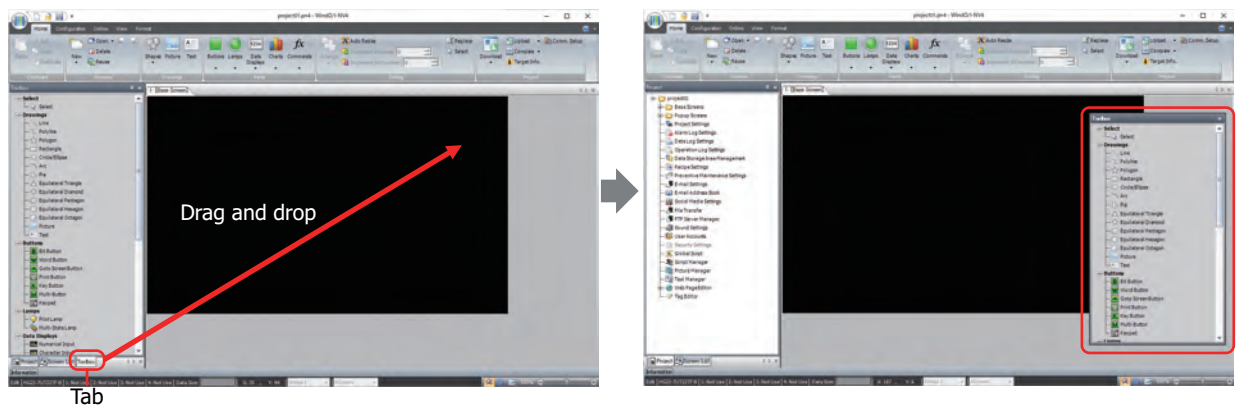

Docking windows

You can dock a floating window to WindO/I-NV4's left, right, top, or bottom frame or a separate window.

- 1 Drag the window's title bar or tab.

The  (Docking) icon is displayed.

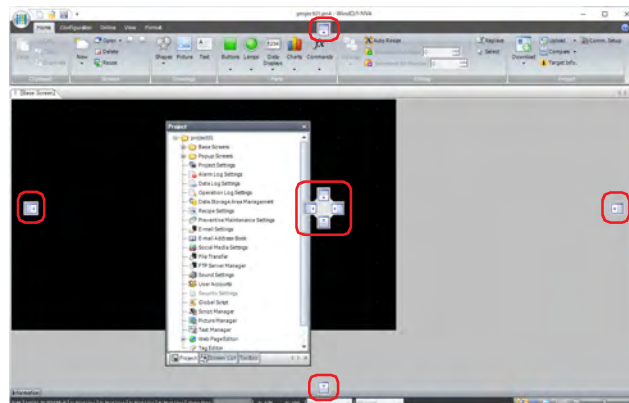



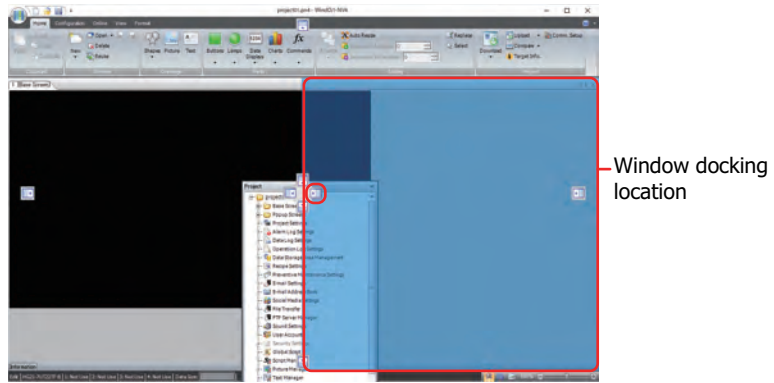

When the mouse cursor gets close to a  (Docking) icon while dragging the title bar or tab, the location to dock the window is displayed.



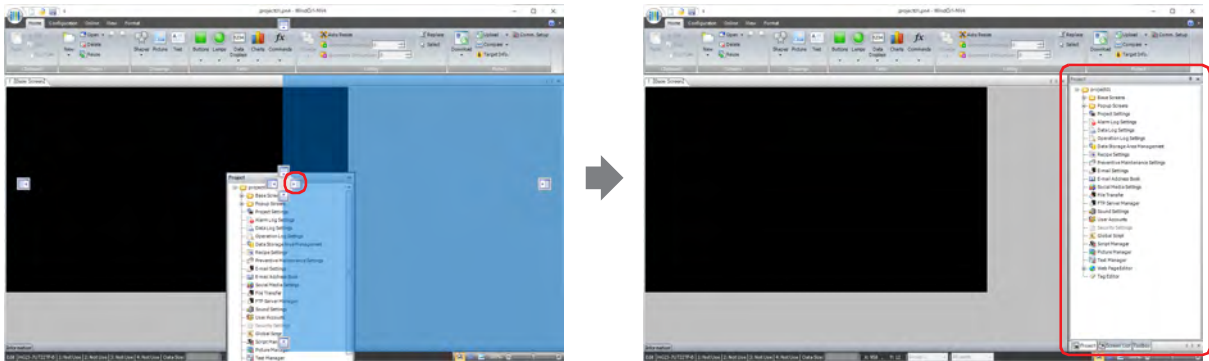

2 Drop the title bar or tab on the  (Docking) icon to dock that window to WindO/I-NV4's left, right, top, or bottom frame or a separate window.

- If the workspace window is dropped on the  icon, it is docked to WindO/I-NV4's left, right, top, or bottom frame.

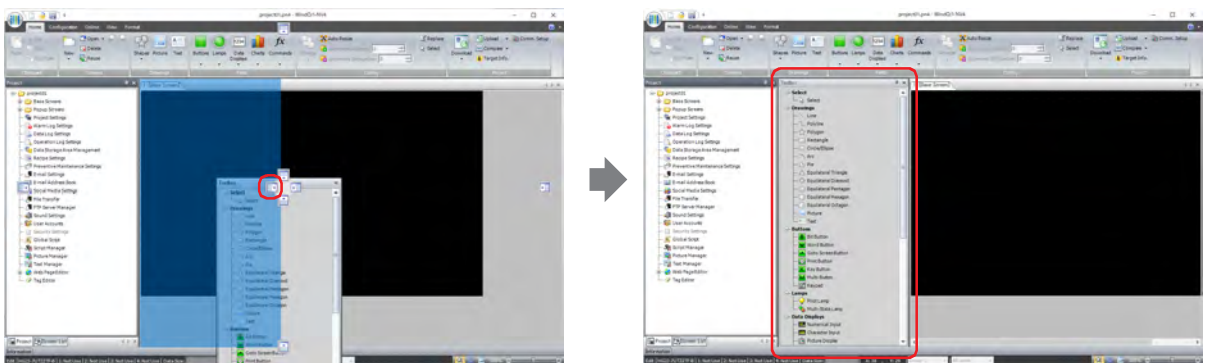

- If a floating window is dropped on the  (Docking) icon, it is docked to WindO/I-NV4's left, right, top, or bottom frame or a docked window.



- If you put the mouse cursor on another window while dragging a floating windows title bar, the  (Docking) icon is displayed. Drop the title bar on the  (Docking) icon to dock the floating window to that window. Change the displayed window with the tabs.

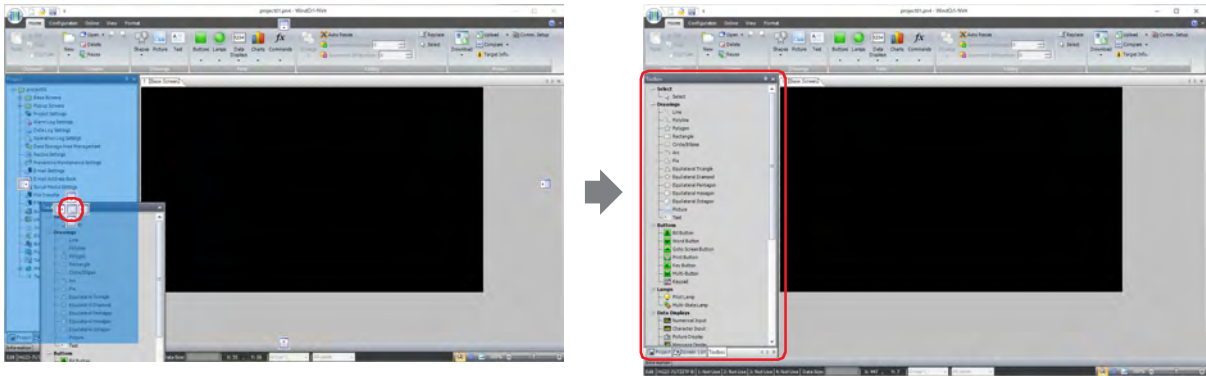

- Changing the display method of windows

Auto Hide

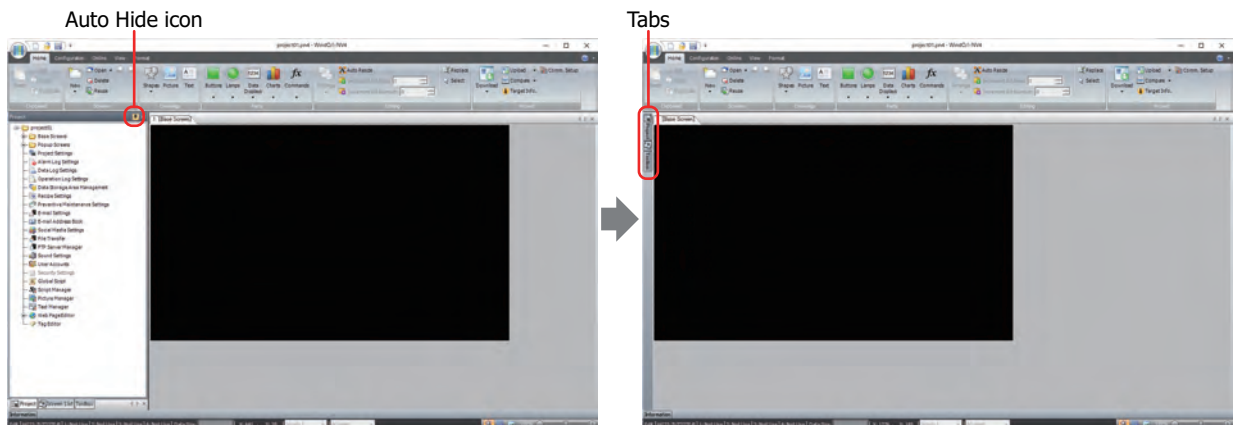

If the workspace window is docked, you can change the window to automatically hide and show only its tabs.

Click the  (Auto Hide) icon to change the window to show only its tabs.

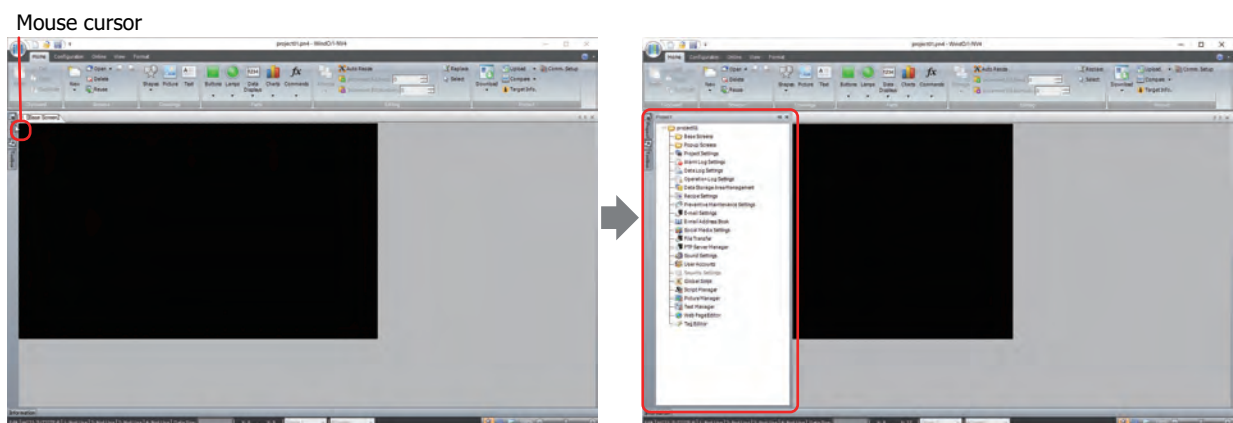

The window is displayed when you bring the mouse cursor close to the tabs.



- Click  (Auto Hide) to secure the window in place.
- Click  (Close) to close the window.

3.5 Status Bar

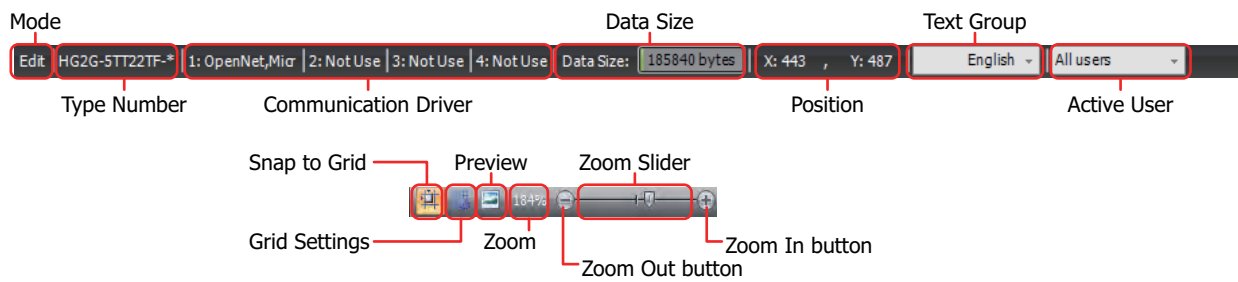

● Status bar items

■ Mode

This section of the status bar shows WindO/I-NV4's current mode.

■ Type Number

This section of the status bar shows the MICRO/I type set in the project data being edited.

■ Communication Driver

This section of the status bar shows the communication driver set in the project data being edited.

■ Data Size

This section of the status bar shows the download data file size for the project data being edited.

When you save the project, the display is updated with the latest information.

■ Position

This section of the status bar shows the X- and Y-coordinates of the mouse cursor in the editing window.

■ Text Group

This section of the status bar shows the current text group. The text displayed in the editing window changes according to the displayed text group.

To change the text group, click ▼ and select the text group.

■ Active User

This section of the status bar shows the active user. You can hide or show objects in the editing window according to the security group of the displayed user.

To change the active user, click ▼ and select the user.

■ Snap to Grid

Click  to align objects to the grid.

■ Grid Settings

You can change the style and spacing of the grid displayed in the editing window.

Click  to display the Grid Settings dialog box. Configure the items and click the **OK** button.

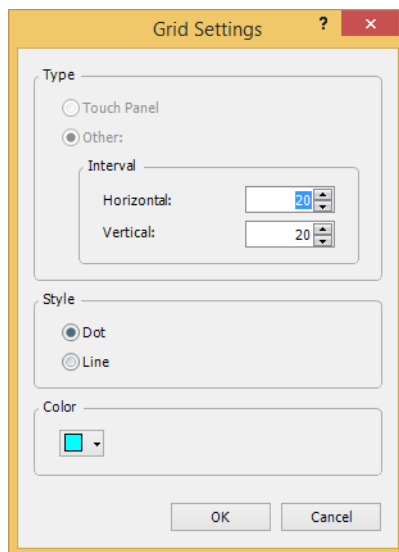

- Type: Selects the type of grid.
- Touch Panel: Aligns the grid to the touch panels.
- Other: Aligns the grid to the specified spacing.
Enter the spacing for the grid in **Horizontal** and **Vertical**.
- Style: Select the grid style with **Dot** or **Line**.
- Color: Select the grid color (color: 256 colors, monochrome: 16 shades).
Click this button to open the color palette. Select the color with the color palette.

■ **Preview**

You can preview an edited screen.

Click  to open the preview window.

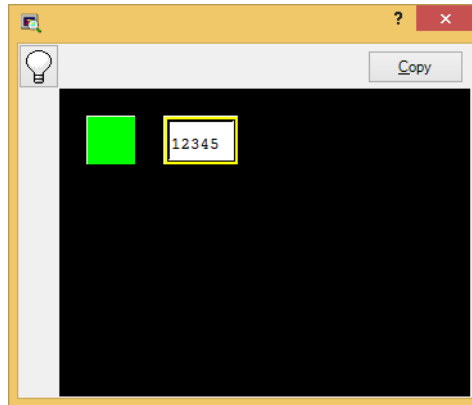

Click the  button to switch between the OFF image and ON image for buttons and lamps.

You can save the image displayed in the preview window as a bitmap image file by clicking the **Copy** button.



The preview display and the actual screen displayed on the MICRO/I may differ.

For example, the image for overlay screens in the preview display is always shown in front. However, when drawing objects and parts overlap on the actual screen, parts are always shown in front irregardless of the order of overlay screens.



■ **Zoom**

Zoom shows the magnification of the editing window.

You can zoom in and zoom out by specifying the magnification.

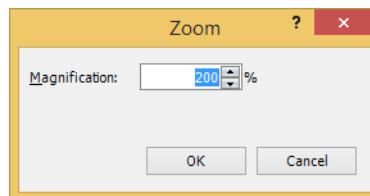
- 1 Click **Zoom** on the status bar.
The Zoom dialog box is displayed.
- 2 Specifying the zoom magnification (50% to 400%) and click **OK**.



You can also specify the zoom magnification by dragging the zoom slider or clicking the  button and the  button.

● **Customizing the status bar**

You can change the commands displayed on the status bar.

Right click the status bar and check only the commands you wish to display on the status bar.

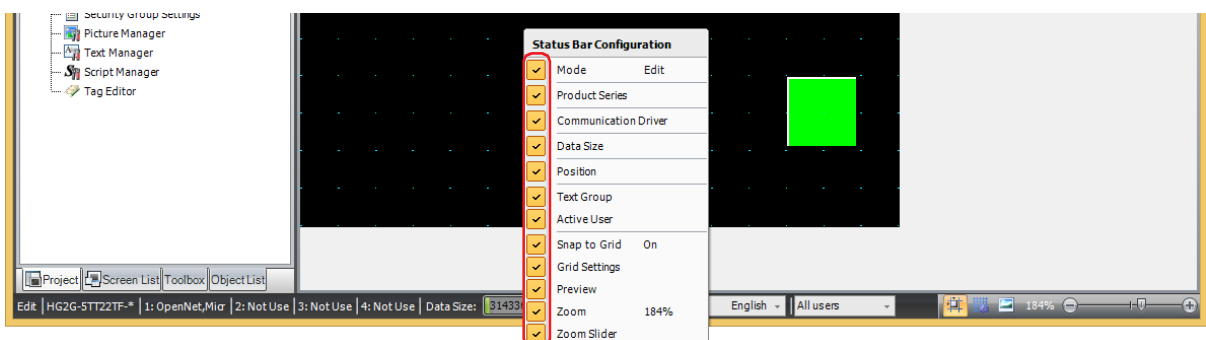

4 Customizing WindO/I-NV4

2

4.1 Configuring the Work Environment

You can configure WindO/I-NV4 settings such as mode and options when editing screens, the path when selecting files, and the path for automatic backups. The settings configured here are saved even when you exit WindO/I-NV4. The procedure for configuring the work environment is shown below.

- 1 Click  and then click **WindO/I-NV4 Options**.

The WindO/I-NV4 Options dialog box is displayed.

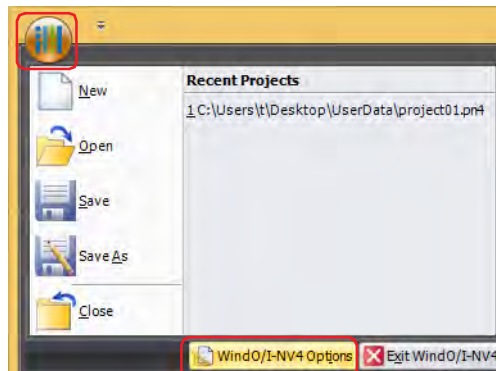

- 2 Change the settings on each tab as desired.

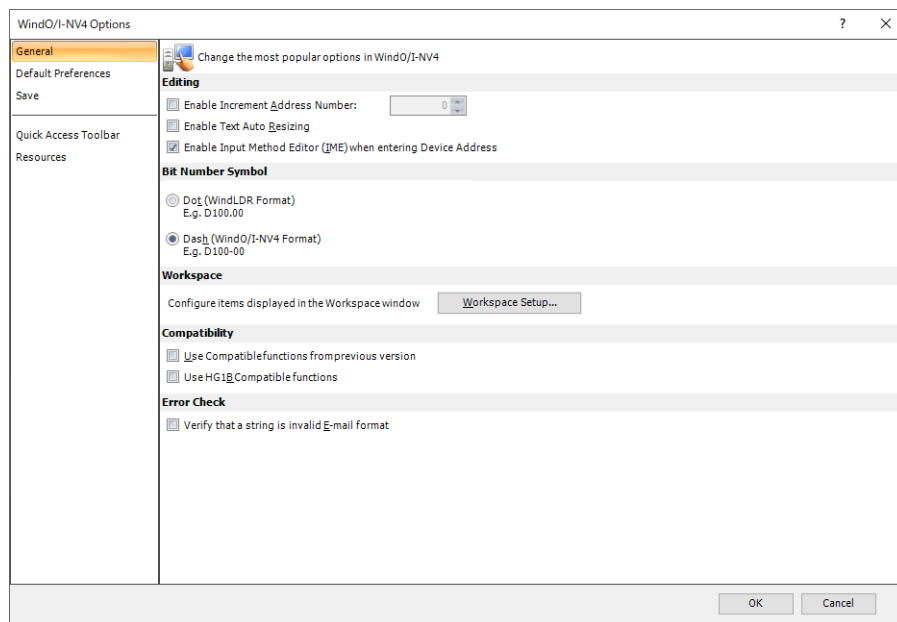

● General Tab

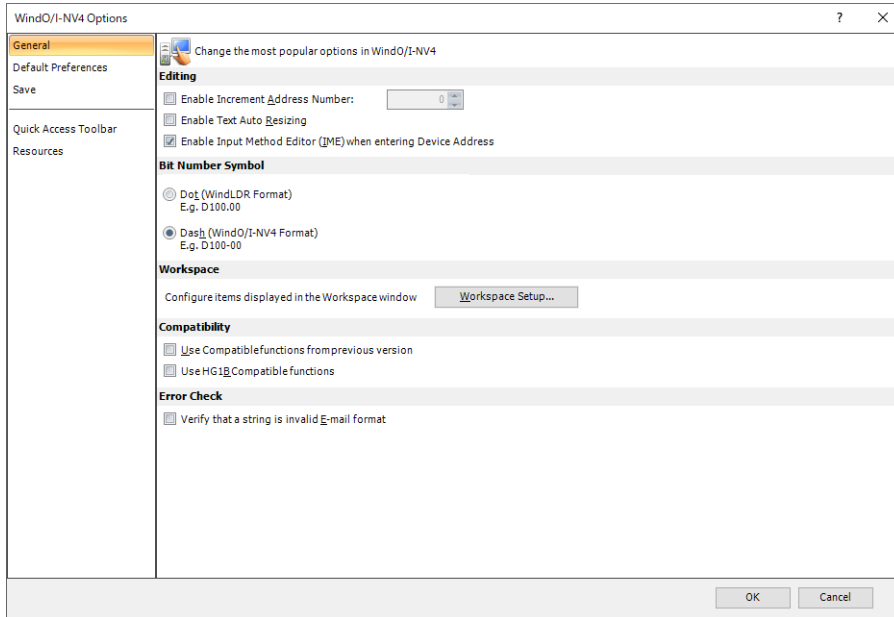

■ Editing

Enable Increment Address Number:

When copying or duplicating parts, select this check box to add a specified value (-999 to 999) to address number of the device address set for the original part before pasting it to the screen.

Enable Text Auto Resizing:

Select this box to automatically change the text size according to a change in part size.

Enable Input Method Editor (IME) when entering Device Address:

Select this box to enter characters other than alphanumeric characters using the input method editor (IME) in text boxes for entering device addresses.



You cannot enter full-width characters in text boxes that only accept alphanumeric input, even if the IME is enabled.

Select this box to use full-width characters in tag names in the device address settings.

■ Bit Number Symbol*¹

Select the separator for address numbers and bit numbers. When manually entering device address, you can enter either separator, but they will be displayed using the symbol selected here.

Dot (WindLDR Format): Separates the address number and bit number with a dot.
Example: D100.00

Dash (WindO/I-NV4 Format): Separates the address number and bit number with a dash.
Example: D100-0

■ Workspace

Workspace Setup:

Displays the Workspace Setup dialog box. You can configure items displayed in the workspace window. For details, refer to "4.2 Customizing the Workspace" on page 2-69

*1 For the following external devices, this feature cannot be used because the device address format is different.

- The **Manufacturer** is **ABB** or **Emerson**
- The **Manufacturer** is **Allen-Bradley** and the **Communication Driver** is **Logix Native Tag(Ethernet)**

■ Compatibility

Use Compatible functions from previous version: Select this box to enable functions from previous versions. For details, refer to Chapter 4 "3.17 Compatible Tab" on page 4-77.

Use HG1B Compatible functions: Select this box to enable previous functions (HG1B). For details, refer to Chapter 4 "3.17 Compatible Tab" on page 4-77.

■ Error Check

Verify that a string is invalid E-mail format: When setting the E-mail address, place a check mark in the check box to check the string format used for the E-mail address. The check target is as follows:

- **Sender E-mail Address** in the E-mail tab on the Project Settings dialog box
- **E-mail Address** on the E-mail Address dialog box
- Import was executed on the E-mail Address Book dialog box.

● Default Preferences Tab

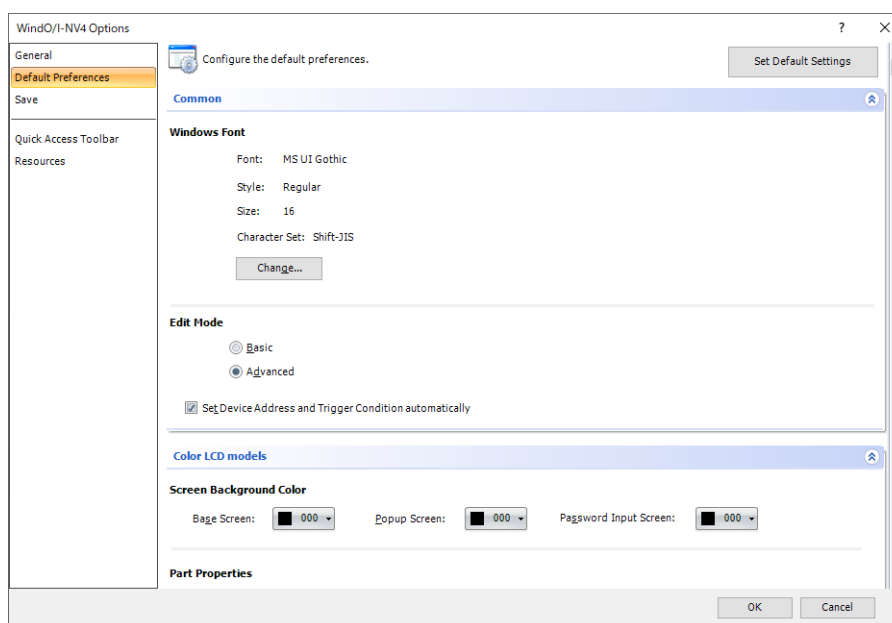

The settings on this tab become the defaults just after creating or opening a project. Thereafter, while editing the project, of the properties dialog boxes for the screen or the part and the WindO/I-NV4 Options dialog box, the priority is given to the settings in the dialog box that you last closed with the OK.

■ Set Default Settings

Returns the settings to the default.

■ Common

Windows Font: When **Windows** is selected for **Font** of each setting, **Font**, **Size**, **Character Set** and **Style** specified here become the default. To change the default, click **Change** and change each item in the Font dialog box.

Edit Mode: Select whether or not to display the Properties dialog box for parts in the Advanced mode.

Basic: Displays the Properties dialog box in Basic mode to use only basic functions.

Advanced: Displays the Properties dialog box in Advanced mode so that all functions can be used.



You can also change the mode by clicking on the **Advanced** button and the **Basic** button in the Properties dialog box for parts.

■ Set Device Address and Trigger Condition automatically

Select this check box to set the initial values of the device address and trigger condition when the part is placed.

■ Color LCD models, Monochrome LCD models

Screen Background Color: The background color of the base screen, popup screen, and password input screen specified here becomes the default.

Part Properties: The properties of the part specified here becomes the default.
To set the shape to be used for the appearance design of the part, click the Shape button. The View Browser is displayed. For details on other settings, refer to the description of the properties of each part. The part properties that can be set are as follows.

Parts		Settings	
Buttons	Bit Button Word Button Goto Screen Button Print Button Key Button Multi-Button	View tab	The shape used for the appearance design of the part Foreground Color, Background Color and Pattern when OFF Foreground Color, Background Color, Pattern and Flash when ON Size - W, H
		Registration Text tab	Font
	Keypad	-	The shape used for the appearance design of the part Switch - Foreground Color, Background Color and Pattern Registration Text - Font Size - W, H
	Selector Switch	View tab	Knob Color Flange - Foreground Color, Background Color and Pattern Switch - Foreground Color, Background Color and Pattern Size - W, H
Registration Text tab		Font	
Potentiometer	View tab	The shape used for the appearance design of the part Slider Color Plate Color Flange - Foreground Color, Background Color and Pattern Switch - Foreground Color, Background Color and Pattern Size - W, H	
Lamps	Pilot Lamp	View tab	The shape used for the appearance design of the part Foreground Color, Background Color, Pattern and Not Display Image when OFF Foreground Color, Background Color and Pattern when ON Size - W, H
		Registration Text tab	Font
	Multi-State Lamp	View tab	Size - W, H
		Registration Text tab	Font
State tab	OFF state and state 0 to 15 of Settings - Image, Foreground Color, Background Color, Pattern and Flash		
Data Displays	Numerical Input Character Input Message Display Message Switching Display Numerical Display Calendar	View tab	The shape used for the appearance design of the part Plate Color Flange - Foreground Color, Background Color and Pattern Size - W, H
		Format tab	Font
	Picture Display	View tab	Size - W, H
	Video Display	View tab	The shape used for the appearance design of the part Plate Color Flange - Foreground Color, Background Color and Pattern Switch - Foreground Color, Background Color and Pattern Size - W, H

Parts		Settings	
Data Displays	Alarm List Display	View tab	The shape used for the appearance design of the part Plate Color Line Color Flange - Foreground Color, Background Color and Pattern Switch - Foreground Color, Background Color and Pattern Size - W, H
	Alarm Log Display Data Log Display	View tab Format tab	The shape used for the appearance design of the part Plate Color Line Color Flange - Foreground Color, Background Color and Pattern Switch - Foreground Color, Background Color and Pattern Size - W, H Font
Charts	Bar Chart	View tab	Plate Color Flange - Foreground Color, Background Color and Pattern Space between Bars Size - W, H
		Scale tab	Show Tick Numbers for X-Axis and Y-Axis - Font
		Label tab	Show Label for X-Axis and Show Label for Y-Axis - Font
	Line Chart	View tab	The shape used for the appearance design of the part Plate Color Flange - Foreground Color, Background Color and Pattern Size - W, H
		X-Axis tab	Label - Font
		Y-Axis tab	Scale and Label - Font
		Date and Time (Cursor) tab	Show date and time data at the cursor position - Font
	Pie Chart	View tab	Flange - Foreground Color, Background Color and Pattern Size - W, H
	Meter	View tab	Needle Color Plate Color Flange - Foreground Color, Background Color and Pattern Size - W, H

● Save Tab

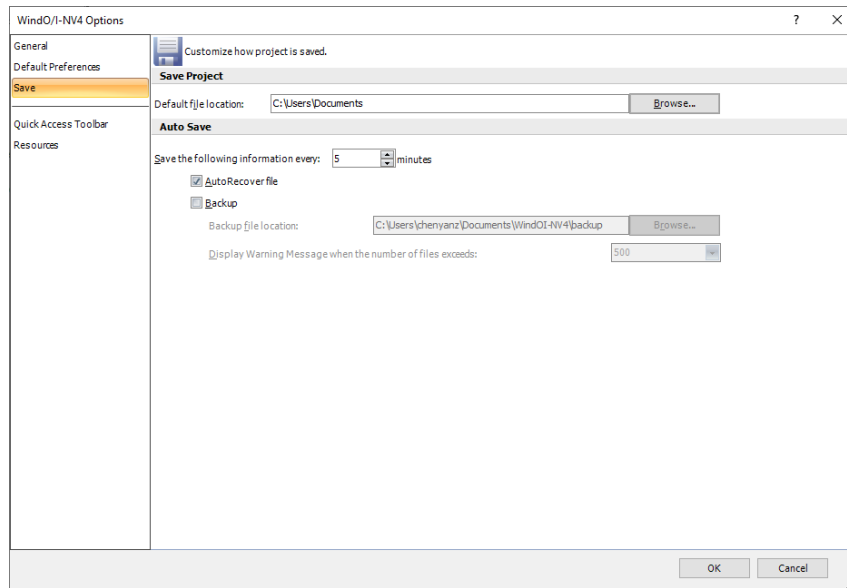

■ Save Project

Default file location: Specify the default save location of the project data.
Click **Browse** to display the Browse For Folder dialog box.

■ AutoSave

Save the following information every:

Specify the interval (5 to 60 minutes) for creating an AutoRecover file or Backup from a project being edited.

This option can only be set when **AutoRecover file** or **Backup** is selected.

AutoRecover file: A project being edited is automatically saved as often as you want. The saved AutoRecover file is used to recover the project if a power failure or otherwise occurs that forces WindO/I-NV4 to quit. The AutoRecover file is automatically deleted when the project is manually saved or WindO/I-NV4 exits. When the AutoRecover file exists, the **Project Recovery** dialog box is displayed when WindO/I-NV4 starts. For details, refer to "Project Recovery Dialog Box" on page 2-40.

Backup: A backup copy of a project being edited is created as often as you want. The file name of the backup is as follows:

Project Name_Backup Date.pn4

Backup date format: YYYYMMDDhhmmss

(YYYY: year, MM: month, DD: day, hh: hour, mm: minute, ss: second)

Example: Project Name is "TEST01" at 4:56:07 on January 23, 2016

TEST01_20160123045607.pn4

If the project file has not been changed, a backup will not be created when the interval specified in **Backup** elapses.

Backup file location:

Specify the save location of the backup file.

Click **Browse** to display the **Browse For Folder** dialog box.

This option can only be set when **Backup** is selected.

Display Warning Message when the number of files exceeds:

Select the maximum number of backup files from the following.

100, 500, 1000

When the specified number of files has been exceeded, a warning message is displayed when WindO/I-NV4 starts.

This option can only be set when **Backup** is selected.

● Quick Access Toolbar Tab

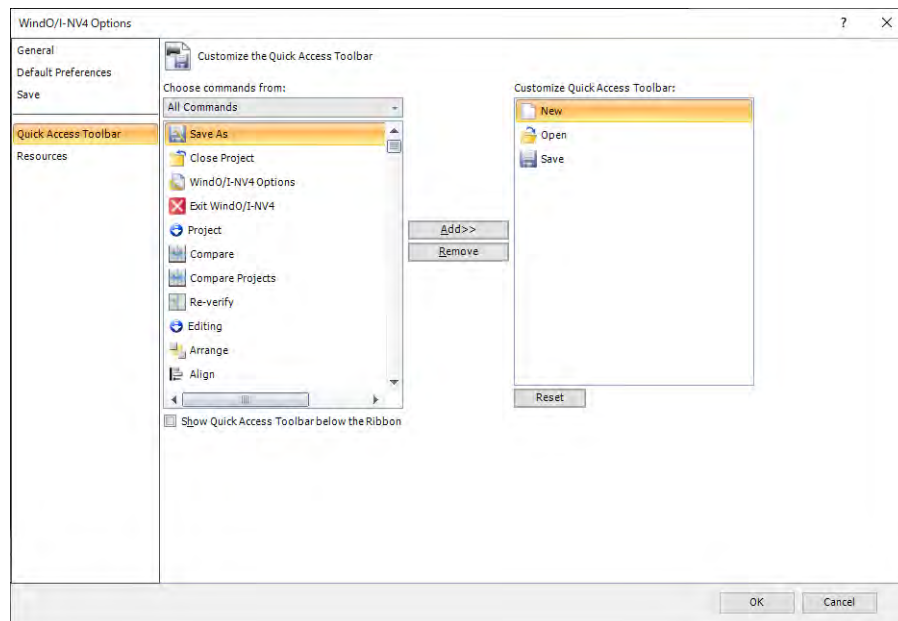

- **Choose commands from**
Select the category of command to add. A list of commands for selected category is displayed.
- **Show Quick Access Toolbar below the Ribbon**
To change the position of the quick access toolbar to be located below the ribbon, select this check box.
- **Add>>**
Add a command to the Customizing the quick access toolbar list.
- **Remove**
Delete a command from the Customizing the quick access toolbar list.
- **Customize Quick Access Toolbar**
Shows the list of commands displayed on the quick access toolbar.



To change the order of the commands, drag and drop a command.

- **Reset**
Returns the settings of the quick access toolbar to their default.



For details about the quick access toolbar, refer to “3.2 Quick Access Toolbar” on page 2-43.

● Resources Tab

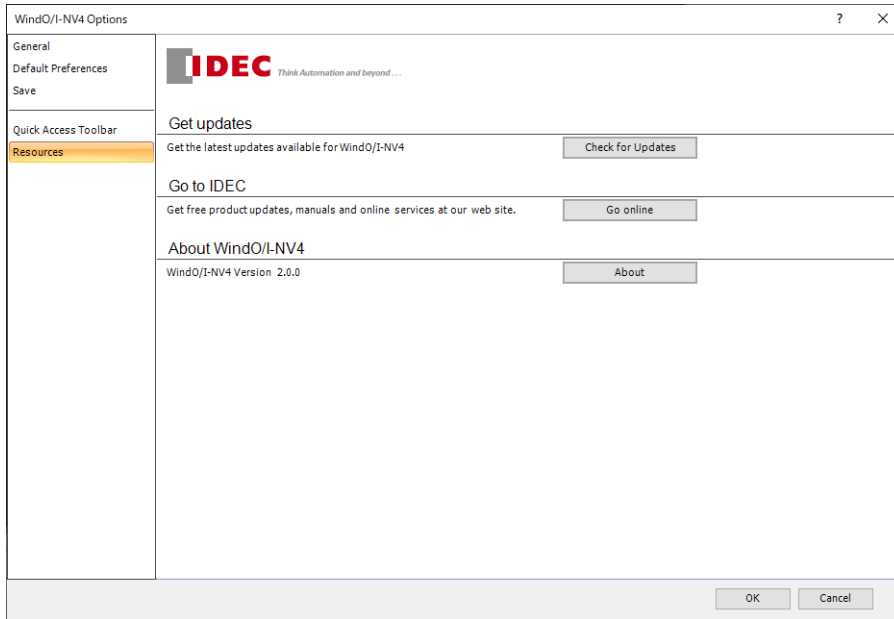

■ Get updates

Check for Updates: This function will check for any updates. If a new version of Automation Organizer is released, the Automation Organizer Updater dialog box is displayed. For details, refer to “Automation Organizer Updater Dialog Box” on page 2-39.

■ Go to IDEC

Go online: Shows the IDEC web page for free updates, manuals, and online services.

■ About WindO/I-NV4

About: Shows the About WindO/I-NV4 dialog box and displays the version of WindO/I-NV4.



In order to display the Automation Organizer Updater, your computer must be connected to the Internet.

4.2 Customizing the Workspace

You can change the windows that are displayed in the workspace with the Workspace Setup dialog box.

● Screen List tab

This tab changes the **Screen List** window display.

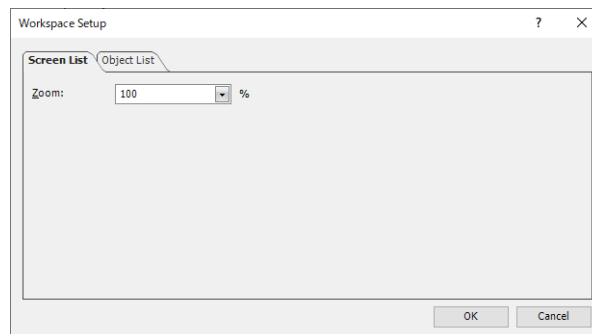

■ Zoom

Select the zoom magnification for the thumbnails displayed in the **Screen List** window from the following.
100, 125, 150, 175, 200, 250, 300, 350, 400

● Object List tab

This tab changes the items displayed in the **Object List** window.

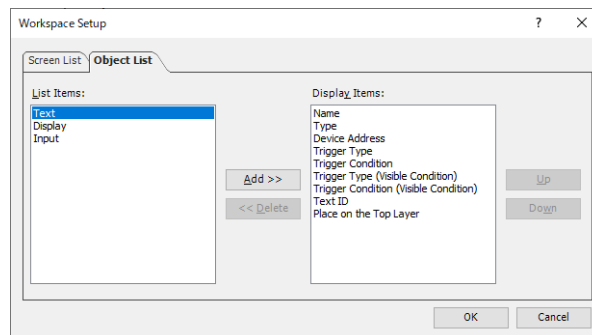

■ List Items

Shows the list of items that can be displayed in the **Object List** window.

■ Add

Adds an item to **Display Items**.

Select an item in **List Items** and click this button to add it to **Display Items**.

■ Delete

Deletes an item from **Display Items**.

Select an item in **Display Items** and click this button.

■ Display Items

Shows the list of items that are displayed in the **Object List** window.

■ Up

Shifts the selected item upward in the **Display Items** list.

■ Down

Shifts the selected item downward in the **Display Items** list.

5 WindO/I-NV4 Common Operations and Settings

This section describes common settings when creating project data.

5.1 Device Address Settings

Device addresses are memory on the MICRO/I and external devices that can store values in bit or word units. By setting device addresses to parts and functions, you can control the screen display and operation of parts. Device addresses are specified by combining the device type and address number in the following formats.

Dot (WindLDR Format):

Dash (WindO/I-NV4 Format):

↑
Address number and bit number separator

The device address can be directly entered or it can be set with the Tag Editor.

● Direct entry

Enter a device address with the keyboard following the basic format.

To enter the bit (0 to 15) for a word device, enter the address number, the bit number separator "." or "-", and the bit. You can enter the address with either separator, but it is displayed according to the **Bit Number Symbol** setting. **Bit Number Symbol** is set on the **General** tab of the WindO/I-NV4 Options dialog box.

● Specifying a device address with the Tag Editor

To display the Tag Editor, click to the right of the text box for setting the device address. Use this Tag Editor to set the device address.

The Tag Editor is different when the **Manufacturer** of the external device is **ABB**, **Allen-Bradley** or **Emerson**. For details, refer to the WindO/I-NV4 External Device Setup Manual.

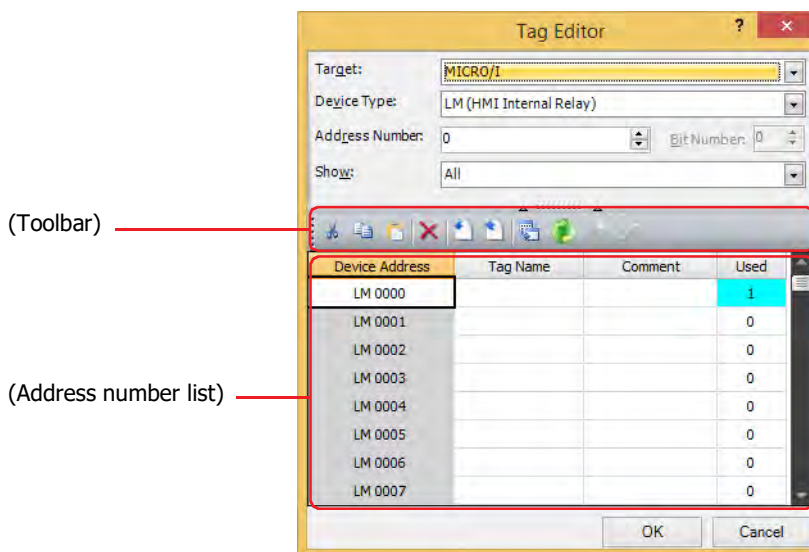

■ Target

Select the device that includes the device address that will be set from **MICRO/I** or **External Device (External Device ID): (External Device Name)**.

You can configure the External Device ID and the external device name in the **Communications Driver Network** tab on the **Project Settings** dialog box. For details, refer to Chapter 4 "3.4 Communication Driver Network Tab" on page 4-52.

■ Device Type

Select the device type.

The list only shows device types that can be used.

■ Address Number

Specify the address number. The range that can be set differs according to the device type selected.

■ Bit Number











Specifies the bit number in a word device (0 to 15). This option can only be configured when a word device is selected for **Device Type**.

■ Show

Select from the following and display the device addresses on the (Address list).

- All: Displays all of the device addresses that can be used with the device selected in **Target**.
 Used: Displays only the device addresses that are used in the active project data.
 Unused: Displays only the device addresses that are not used in the active project data.

■ (Toolbar)

-  (Cut): Cuts the selected tag name or comment from (Address number list) and copies it to the clipboard.
-  (Copy): Copies the selected tag name or comment to the clipboard.
-  (Paste): Pastes the contents of the clipboard.
-  (Delete): Deletes the selected tag name or comment.
-  (Import): Shows the Open dialog box.
 Select a file with exported tag names and comments (CSV file), and then click **Open** to collectively overwrite (Address number list) with the tag names and comments in the selected file.
-  (Export): Displays the Export dialog box.
 Select the location to save the file, enter a file name, and then click **Save** to save the tag names and comments of (Address number list) as a CSV file.
-  (Cross Reference): Shows the Cross Reference dialog box. For details, refer to "Cross Reference Dialog Box" on page 2-72.
-  (Refresh): Updates the **Use** column on the Tag Editor.
-  (Add New Tag): Adds the Allen-Bradley tag data.
 This is valid only if the **Logix Native Tag(Ethernet)** driver of **Allen-Bradley** is selected and the external device is selected from the **Target**. For details, refer to the WindO/I-NV4 External Device Setup Manual.
-  (Edit Tag): Edits the registered Allen-Bradley tag data.
 This is valid only if the **Logix Native Tag(Ethernet)** driver of **Allen-Bradley** is selected and the external device is selected from the **Target**. For details, refer to the WindO/I-NV4 External Device Setup Manual.

■ (Address number list)

Displays a list of device addresses that match the specified condition.

- Device Address: Displays the device addresses of the selected Device Type.
 Tag Name: Displays the tag name of the address number.
 Double clicking the cell allows you to edit the tag name. The maximum number is 20 characters.



The following characters and names cannot be used in the tag name.

- # \$ * + , - /
- Spaces and control characters
- Same name as device address
- Names that start with a number

Comment: Displays the comment of the address number.
Double clicking the cell allows you to edit the comment. The maximum number is 255 characters.
You can enter multi-line messages by inserting a newline.



To enter a multi-line comment, press and hold SHIFT and ENTER.

Used: Displays how many times each address number has used.



The device addresses of the MICRO/I and external devices are collectively managed in Tag Editor. Tag Editor can be displayed with the following procedures.

- On the **View** tab, in the **Workspace** group, click  (Tag Editor).
 - Double click **Tag Editor** in the **Project** window.
-

Cross Reference Dialog Box

On the Tag Editor, select the device address, and then click  (Cross Reference) to show the screen type, screen number, and part number where that device address is used.

Enter the device address in **Device Address** and click  (Refresh) to see the updated data.

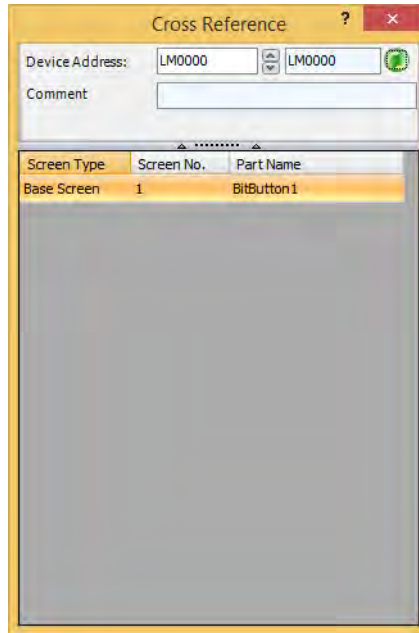

5.2 Setting Conditional Expressions

Specify conditional expressions with **Condition** on the **Trigger Condition** tab.

Conditional expressions are specified by combining data and operators using the following basic format.

[Data] [Operator] [Data]

Directly enter the conditional expression or specify it with the Trigger Conditions Settings dialog box.

● Direct entry

Enter the conditional expression with the keyboard.

- There is no limit on data or operators. However, the maximum number is 1500 characters.

[Data] [Operator] [Data]
to

[Data] [Operator] [Data] [Operator] [Data] [Operator] [Data] [Operator] [Data] [Operator] [Data] ... (within 480 characters)

- To enter a device address for data, always enclose it with “[” and “]”.
- Example: [LDR 100] == 10
- To flip bits, enter “~” before the data.
- Parentheses “(” and “)” can be used.

([Data] [Operator] [Data]) [Operator] ([Data] [Operator] [Data])

- Operator priority is the same as scripts. For details, refer to Chapter 20 “6.5 About the Priority of the Operator” on page 20-62.

● Configuring conditional expressions with the Trigger Condition Settings Dialog Box

You can easily configure a basic conditional expression using the Trigger Condition Settings dialog box.

- Up to a maximum of five items of data can be used.

[Data] [Operator] [Data]
to

[Data] [Operator] [Data] [Operator] [Data] [Operator] [Data] [Operator] [Data]

- To flip the bits in data, select the **Not** check box.
- Operator priority is the same as scripts. For details, refer to Chapter 20 “6.5 About the Priority of the Operator” on page 20-62.

- 1 Click the **Condition**  button to display the Trigger Condition Settings dialog box.

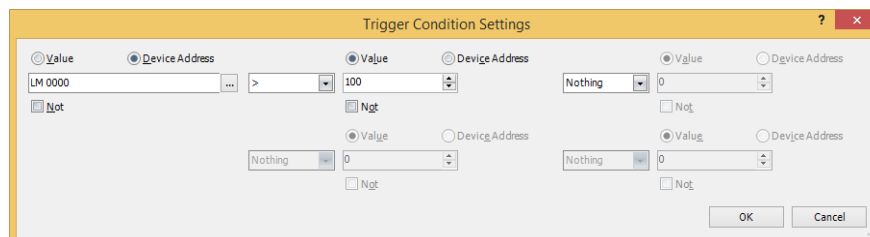

- 2 Click **Value** or **Device Address** and enter a value or device address.
To flip the bits in data, select the **Not** check box.
- 3 Select the operator.
- 4 Click the next **Value** or **Device Address** and enter a value or device address.
To flip the bits in data, select the **Not** check box.
- 5 Repeat steps 3 and 4 for the necessary number of conditions.



If you display the Trigger Condition Settings dialog box after directly entering a conditional expression, that expression will be reflected in the dialog box. However, if you entered an expression that cannot be reflected, the portion of the expression that could not be reflected is deleted when you click the **OK** button and close the Trigger Condition Settings dialog box.

● Data and operations that can be configured

Data

You can specify these types and values of data for conditional expressions.

Item	Description
Value	Set a constant number as data. The range that can be set differs according to the selected data type. For details, refer to "Data types" on page 2-1.
Device Address	Set a device address for a bit device or a word device that stores the value to be handled as data.

Operators

Specify the type of arithmetic operation to execute on the data. (In the table below, indicates the operator's left-hand number, indicates the right-hand number.)

Operator	Details			Supported device	
				Bit device	Word device
Arithmetic operators	+	Addition	Adds <input type="text" value="a"/> and <input type="text" value="b"/> .	NO	YES
	-	Subtraction	Subtracts <input type="text" value="b"/> from <input type="text" value="a"/> .	NO	YES
	*	Multiplication	Multiplies <input type="text" value="a"/> and <input type="text" value="b"/> .	NO	YES
	/	Division	Divides <input type="text" value="a"/> by <input type="text" value="b"/> .	NO	YES
	%	Modulo	Calculates the remainder after dividing <input type="text" value="a"/> by <input type="text" value="b"/> .	NO	YES
Relational operators*1	==	Equal to	Compares if <input type="text" value="a"/> is equal to <input type="text" value="b"/> .	YES	YES
	!=	Not equal to	Compares if <input type="text" value="a"/> is not equal to <input type="text" value="b"/> .	YES	YES
	>=	Greater than or equal to	Compares if <input type="text" value="a"/> is equal or greater than <input type="text" value="b"/> .	NO	YES
	<=	Less than or equal to	Compares if <input type="text" value="a"/> is equal or less than <input type="text" value="b"/> .	NO	YES
	>	Greater than	Compares if <input type="text" value="a"/> is greater than <input type="text" value="b"/> .	NO	YES
	<	Less than	Compares if <input type="text" value="a"/> is less than <input type="text" value="b"/> .	NO	YES
Bitwise operators	&	Bitwise AND	Calculates the logical product (AND) of each bit in <input type="text" value="a"/> and <input type="text" value="b"/> .	YES	YES
		Bitwise OR	Calculates the logical sum (OR) of each bit in <input type="text" value="a"/> and <input type="text" value="b"/> .	YES	YES
	^	Bitwise XOR (exclusive OR)	Calculates the exclusive logical sum (XOR) of each bit of <input type="text" value="a"/> and <input type="text" value="b"/> .	YES	YES
	~	Bitwise NOT	Flips the logic of each bits of <input type="text" value="a"/> .	YES	YES
	<<	Left shift	Shifts each bit of <input type="text" value="a"/> to left for <input type="text" value="b"/> bit(s).	YES	YES
	>>	Right shift	Shifts each bit of <input type="text" value="a"/> to right for <input type="text" value="b"/> bit(s).	YES	YES
Logical operators*1	&&	Logical AND	Calculates the logical product (AND) of a conditional expression and a conditional expression.	YES	YES
		Logical OR	Calculates the logical sum (OR) of a conditional expression and a conditional expression.	YES	YES



- You cannot select logical operators in the Trigger Condition Settings dialog box.
- You cannot mix bit devices and word devices in a conditional expression when using other than logical operators.



As a basic rule, conditional expressions are calculated in order from the left, but when multiple arithmetic operations are combined, they are calculated according to the operator priority.

For $[D 10] == [D 11] + [D 12] * 2 + [D 13]$, the expression is calculated in the following order.

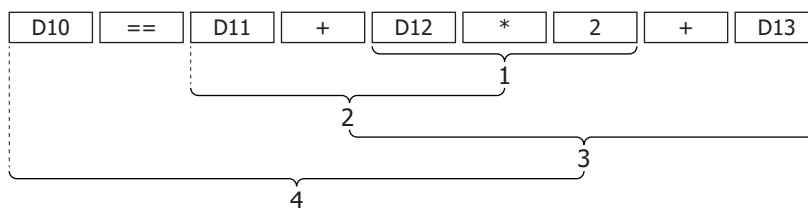

For the operator priority, refer to Chapter 20 "6.5 About the Priority of the Operator" on page 20-62.

*1 1 if satisfied, 0 if not satisfied.

● Setting and operation examples

Settings		Action
Direct entry	Trigger Condition Settings dialog box	
$[M 0] == [M 1]$	Data <input type="text" value="M0"/> Op. <input type="text" value="=="/> Data <input type="text" value="M1"/>	The condition is satisfied if the values of M0 and M1 are equal.
$[M 0] == [M 1] \& [M 2]$	Data <input type="text" value="M0"/> Op. <input type="text" value="=="/> Data <input type="text" value="M1"/> Op. <input type="text" value="&"/> Data <input type="text" value="M2"/>	The condition is satisfied if the result of the AND operation on M1 and M2 is equal to M0.
$[M 0] == \sim[M 1]$	Data <input type="text" value="M0"/> Op. <input type="text" value="&"/> Data <input type="text" value="M1"/> <input checked="" type="checkbox"/> Not	The condition is satisfied if the result of flipping the bits in M1 is equal to M0.
$1234 == [D 0]$	Data <input type="text" value="1234"/> Op. <input type="text" value="=="/> Data <input type="text" value="D0"/>	The condition is satisfied if the value of D0 equals 1234.
$100 \leq [D 0] + [D 1] + [D 2] + [D 3]$	Data <input type="text" value="100"/> Op. <input type="text" value="<="/> Data <input type="text" value="D0"/> Op. <input type="text" value="+"/> Data <input type="text" value="D1"/> Op. <input type="text" value="+"/> Data <input type="text" value="D2"/> Op. <input type="text" value="+"/> Data <input type="text" value="D3"/>	The condition is satisfied if the result of adding the values of D0 through D3 is 100 or greater.
$0 \neq [D 0] \% 10$	Data <input type="text" value="0"/> Op. <input type="text" value="!="/> Data <input type="text" value="D0"/> Op. <input type="text" value="%"/> Data <input type="text" value="10"/>	The condition is satisfied if the value of the remainder after D0 is divided by 10 does not equal 0 (the value of D10 cannot be entirely divided by 10).
$[D 0] == \sim[D 1] \& \sim[D 2] \& [D 3] \& [D 4]$	Data <input type="text" value="D0"/> Op. <input type="text" value="=="/> Data <input type="text" value="D1"/> Op. <input type="text" value="&"/> Data <input type="text" value="D2"/> <input checked="" type="checkbox"/> Not <input checked="" type="checkbox"/> Not Op. <input type="text" value="&"/> Data <input type="text" value="D3"/> Op. <input type="text" value="&"/> Data <input type="text" value="D4"/>	The condition is satisfied if the logical AND operation on the flipped bits of D1, the flipped bits of D2, the value of D3, and the value of D4 is equal to D0.
$[D 10] + [D 11] == [D 12] + [D 13]$	Data <input type="text" value="D10"/> Op. <input type="text" value="+"/> Data <input type="text" value="D11"/> Op. <input type="text" value="=="/> Data <input type="text" value="D12"/> Op. <input type="text" value="+"/> Data <input type="text" value="D13"/>	The condition is satisfied if the result of adding the values of D12 and D13 is equal to the result of adding the values D10 and D11.
$[D 10] == [D 11] + [D 12] * 2 + [D 13]$	Data <input type="text" value="D10"/> Op. <input type="text" value="=="/> Data <input type="text" value="D11"/> Op. <input type="text" value="+"/> Data <input type="text" value="D12"/> Op. <input type="text" value="*"/> Data <input type="text" value="2"/> Op. <input type="text" value="+"/> Data <input type="text" value="D13"/>	The condition is satisfied if the result of adding the values of D11, D12 multiplied by two, and D13 is equal to the value of D10.
$100 \leq [D 0] + [D 1] + [D 2] + [D 3] + [D 4] + [D 5] + [D 6] + [D 7]$	(This expression cannot be configured in the Trigger Condition Settings dialog box because it has over 6 items of data.)	The condition is satisfied if the result of adding the values of D0 through D7 is 100 or greater.
$1 == ([M 0] \&\& [M 1]) \ \ ([M 2] \&\& [M 3])$	(This expression cannot be configured on the Trigger Condition Settings dialog box because it uses logical operators and it contains parentheses "(" and ").")	The condition is satisfied if the logical OR operation on the result of the logical AND operation on M0 and M1 and the result of the logical AND operation on M2 and M3 is equal to 1.
$[LDR 10] + [LDR 11] == [LDR 12] * ([LDR 13] + [LDR 14])$	(This expression cannot be configured on the Trigger Condition Settings dialog box because it mixes bitwise operators and logical operators or it contains parentheses "(" and ").")	The condition is satisfied if the result of multiplying the value of LDR12 by the result of adding the values of LDR13 and LDR14 is equal to the result of adding the values of LDR10 and LDR11.

This chapter describes the communication between the MICRO/I and the external device.

1 Device Link Communication

HG2J-7U HG5G-V HG4G-V HG4G HG3G-V HG3G HG2G-V HG2G-5F HG2G-5T HG1G HG1P

1.1 Overview

Device Link Communication refers to the communication protocol used for communication with the MICRO/I, via the CPU Unit*¹ or PLC Link Unit*¹ Programming Port of the external device connected to the MICRO/I.

The MICRO/I continuously reads the values of the external device addresses on the currently displayed screen, and external devices (such as relays and registers) on the screens are updated with the latest data at all times.

When a button is pressed or a command is executed in the MICRO/I screen, the value is written to the external device address.

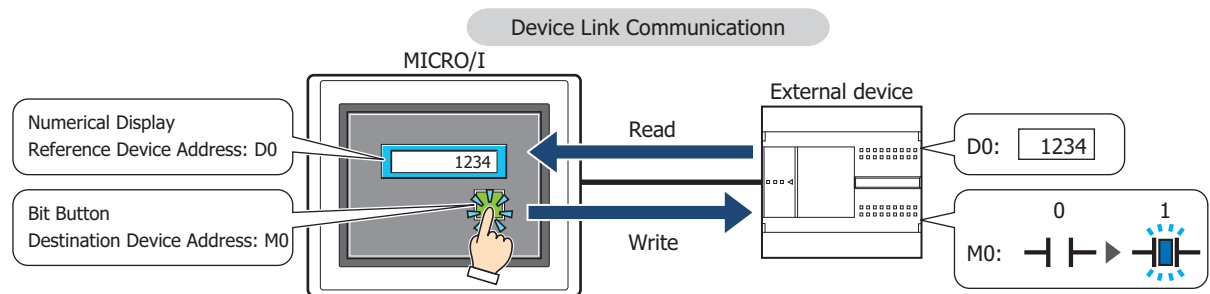

When the read source is the value from the device address of the external device, read all the value of device addresses used with the functions that are always executed during operation and the functions that set for the displayed screens before starting the screens scan. Therefore, if a communication error occurs, check the connection with the external device configured to the project.

- Functions that are always executed during operation:
Project Settings, Alarm Log Settings, Data Log Settings, Operation Log Settings, Recipe Function, Preventive Maintenance Function, E-mail Settings, Social Media Settings, File Transfer, FTP Server Manager, Sound Settings, Multimedia Settings, User Accounts and Global Script
- Functions that set for the displayed screens:
Parts set on the overlaying Base Screens and the displayed screens



For details regarding the Device Link Communication, refer to Chapter 1 "Device Link Communication" and Chapter 2 "Connection to External Devices" in the WindO/I-NV4 External Device Setup Manual.

*1 Unit names vary based on the manufacturer of the external device.

● Connection Types

There are two basic types of connections. 1:1 Communication, where an external device is connected to a MICRO/I; and 1:N Communication, where multiple external devices are connected to a MICRO/I.

■ 1:1 Communication

The MICRO/I is connected to a single external device.

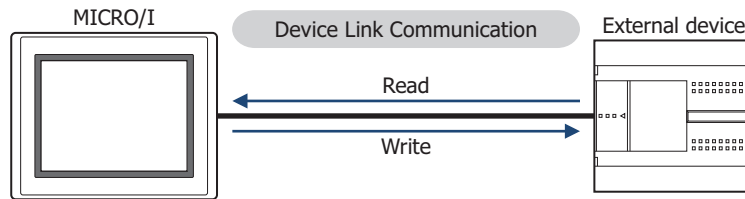

■ 1:N Communication

The MICRO/I is connected to multiple external devices.

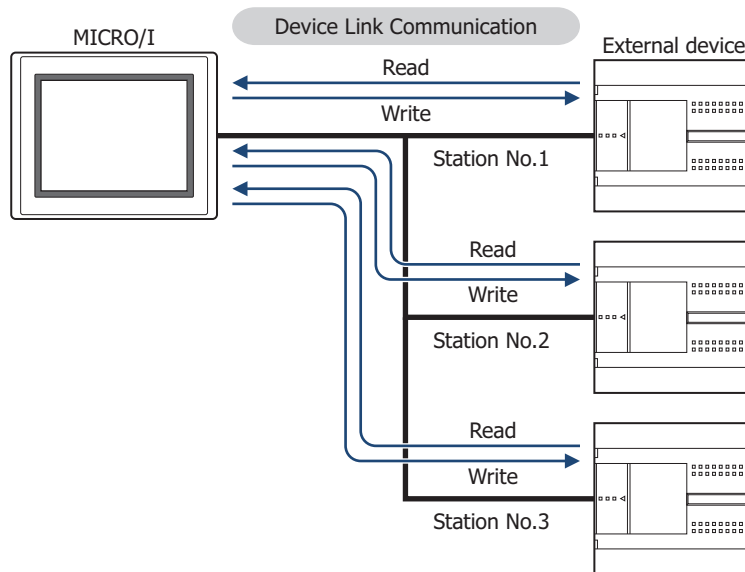

1.2 Device Link Communication Settings

The external devices connected to the MICRO/I are selected on the Select Communication Driver dialog box, or the **Communication Driver** tab on the Project Settings dialog box.

- By clicking , and then clicking **New**, following displayed dialog boxes and configuring settings, the Select Communication Driver dialog box is displayed. For details, refer to Chapter 4 "Create new project data by using the interactive quick start" on page 4-1.
- Click **Communication Driver** on the status bar to display the **Communication Driver** tab on the Project Settings dialog box tab on the Project Settings dialog box. For details, refer to Chapter 4 "Changing Communication Drivers" on page 4-21.

Specify **Manufacturer** and **Communication Driver** for each CPU Unit*¹ or each PLC Link Unit*¹ of the external device. For details regarding the correspondence model, refer to the WindO/I-NV4 External Device Setup Manual.

*1 Unit names vary based on the manufacturer of the external device.

2 O/I Link Communication

HG2J-7U HG5G-V HG4G-V HG4G HG3G-V HG3G HG2G-V HG2G-5F HG2G-5T HG1G HG1P

2.1 Overview

O/I Link Communication is a protocol for communication between Master and Slave, where a MICRO/I connected to the external device is configured as a Master and multiple MICRO/I (Slaves) communicate with the external device via the Master.

The Master MICRO/I unit communicates with the external device by means of Device Link Communication. The Master MICRO/I is called an O/I Link Master and a slave MICRO/I connected to the O/I Link Master is called an O/I Link Slave. A maximum of 15 O/I Link Slaves can be connected to an O/I Link Master.

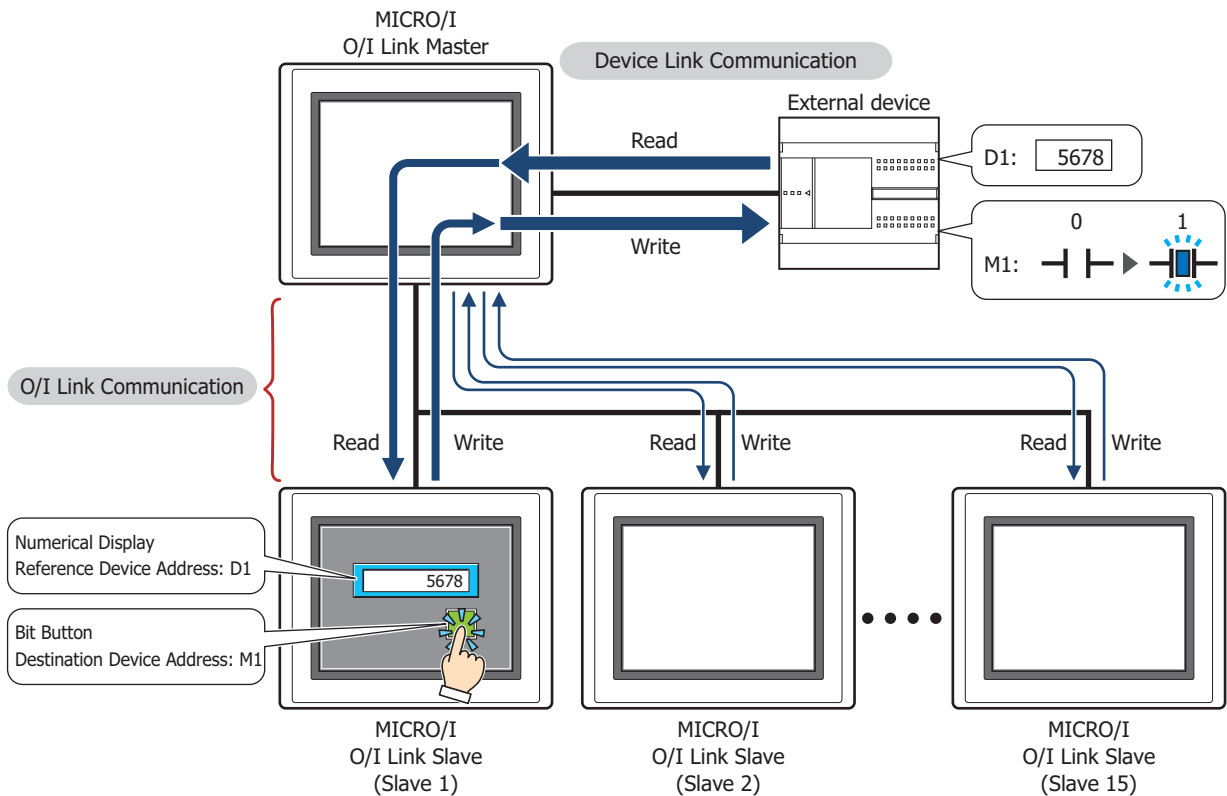

O/I Link Communication can only be used for the **External Device Communication 1**. The communication driver of O/I Link Slave should match the O/I Link Master's.

For details regarding the O/I Link Communication, refer to Chapter 3 "O/I Link Communication" in the WindO/I-NV4 External Device Setup Manual.



- Use the runtime system version 4.01 or later for HG4G/3G and HG2G-5F/-5S/-S when connecting the HG2J-7U, HG5G/4G/3G/2G-V, HG4G/3G, HG2G-5F/-5S/-S, HG1G/1P via O/I Link Communication.
- The HG2J-7U, HG5G/4G/3G/2G-V, HG4G/3G, HG2G-5F/-5T, HG1G/1P and the HG4F/3F/2F/2S/1F use a different protocol for the O/I Link Communication. To communicate them via the O/I Link Communication, select the **Use the same O/I Link Communication as the HG4F/3F/2F/2S/1F** check box on the **Compatible** tab of the **Project Settings** dialog box.
- O/I Link Communication is only supported by models with a serial interface (RS422/485).

2.2 O/I Link Communication Settings

These settings are configured under the **O/I Link** tab on the Project Settings dialog box. The Project Settings dialog box can also be accessed using the following methods.

- Click **Project** on the **Configuration** tab.
- Double click **Project Settings** in the **Project** window.

The O/I Link Communication Settings can only be configured when **O/I Link Master** or **O/I Link Slave** is selected in **Function** under **Interface Settings** on the **Communication Interface** tab. For details, refer to Chapter 4 "3.5 O/I Link Tab" on page 4-55.

3 DM Link Communication

HG2J-7U HG5G-V HG4G-V HG4G HG3G-V HG3G HG2G-V HG2G-5F HG2G-5T HG1G HG1P

3.1 Overview

DM Link Communication reads and writes value to external devices using the MICRO/I's dedicated DM Link memory. The device type of dedicated DM Link memory is DM.

This method uses a dedicated IDEC protocol, so a communication program is required in the external device.

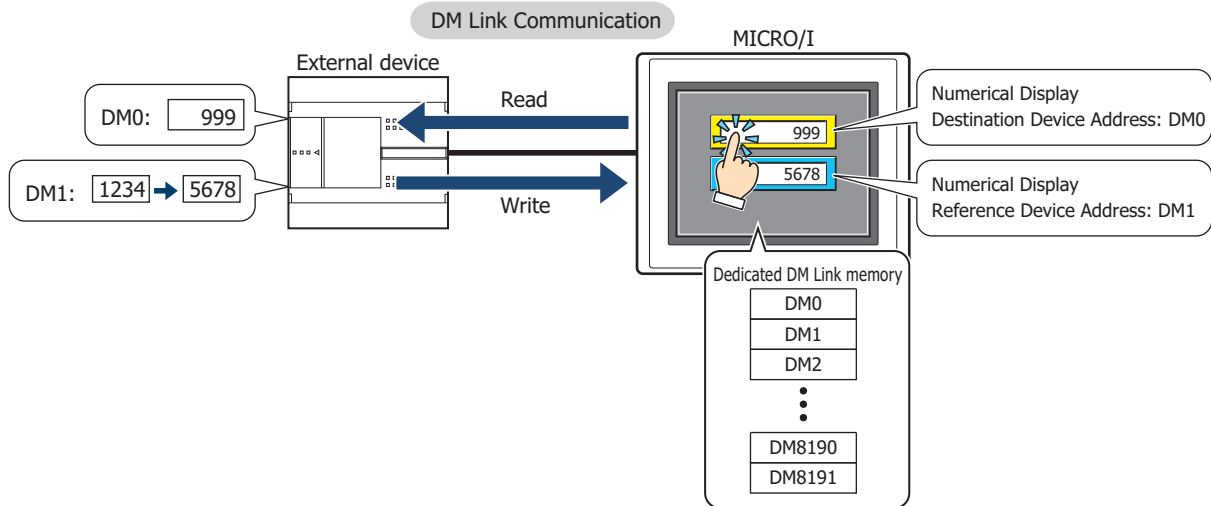

For details regarding the DM Link Communication, refer to Chapter 4 "DM Link Communication" in the WindO/I-NV4 External Device Setup Manual.

● Communication Methods

Over the serial interface, when one external device is communicating with one MICRO/I using this communication method it is called DM Link 1:1 communication, and when one external device is communicating with multiple MICRO/I units, it is called DM Link 1:N communication. When external devices and the MICRO/I are communicating using DM Link communication over the Ethernet interface (UDP protocol), it is called DM Link Ethernet (UDP) communication^{*1}.

■ DM Link 1:1 Communication

HG2J-7U HG5G-V HG4G-V HG4G HG3G-V HG3G HG2G-V HG2G-5F HG2G-5T HG1G HG1P

The external device is connected to a single MICRO/I by using a serial interface.

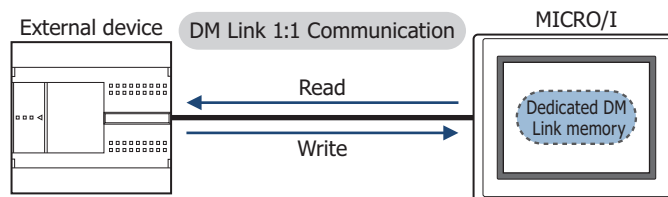

The Event Transmission function from the MICRO/I can be used with DM Link 1:1 Communication.

The Event Transmission function is a function that works as follows. When value in the dedicated DM Link memory of the MICRO/I is changed, the data is transmitted from the MICRO/I to the external device.

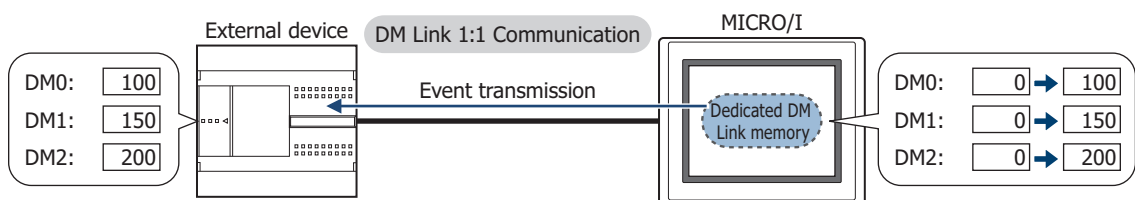

*1 HG2J-7U, HG5G/4G/3G/2G-V, HG4G/3G, HG2G-5F only

■ DM Link 1:N Communication

HG2J-7U HG5G-V HG4G-V HG4G HG3G-V HG3G HG2G-V HG2G-5F HG2G-5T HG1G HG1P

The external device is connected to multiple MICRO/I by using a serial interface.

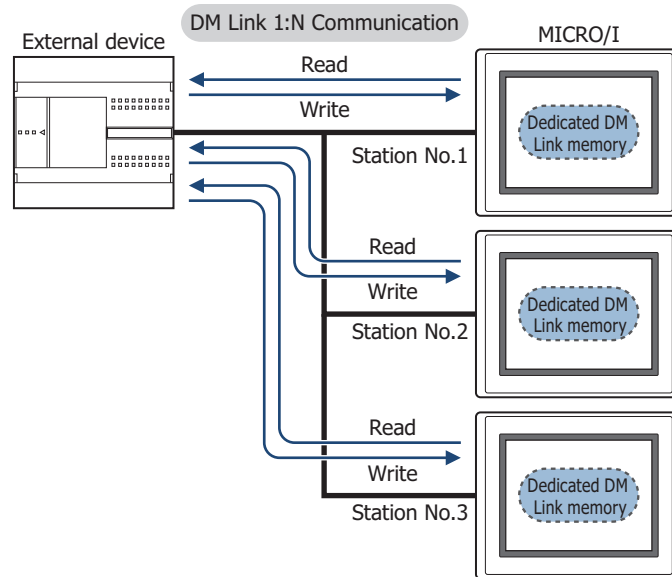

The Event Transmission function cannot be used with DM Link 1:N Communication.

■ DM Link Ethernet (UDP) Communication

HG2J-7U HG5G-V HG4G-V HG4G HG3G-V HG3G HG2G-V HG2G-5F HG2G-5T HG1G HG1P

The external device is connected to multiple MICRO/I by using the Ethernet interface (UDP protocol).

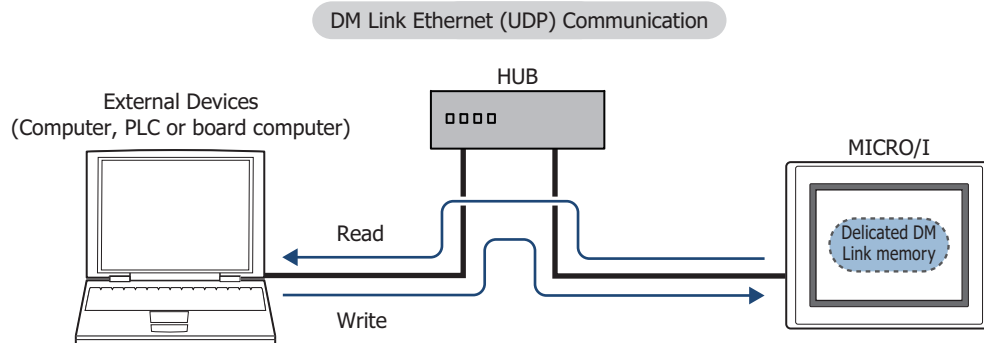

- The Event Transmission function cannot be used with DM Link Ethernet (UDP) communication.
- In DM Link Ethernet (UDP) Communication, when a Response is returned from the MICRO/I to a command source, the Response can also be returned to specified addresses (IP Address, Port Number) at the same time. For details, refer to Chapter 4 "DM Link Communication" in the WindO/I-NV4 External Device Setup Manual.

3.2 DM Link Communication Settings

DM Link Communication settings are selected on the Select Communication Driver dialog box, or the **Communication Driver** tab on the Project Settings dialog box.

- By clicking , and then clicking **New**, following displayed dialog boxes and configuring settings, the Select Communication Driver dialog box is displayed. For details, refer to Chapter 4 "Create new project data by using the interactive quick start" on page 4-1.
 - Click **Communication Driver** on the status bar to display the **Communication Driver** tab on the Project Settings dialog box. For details, refer to Chapter 4 "Changing Communication Drivers" on page 4-21.
- Select **IDEC System** in **Manufacturer**, and then select **DM Link (1:1)**, **DM Link (1:N)** or **DM Link Ethernet (UDP)***1 in **Communication Driver**.

*1 HG2J-7U, HG5G/4G/3G/2G-V, HG4G/3G, HG2G-5F only

4 No External Devices

HG2J-7U HG5G-V HG4G-V HG4G HG3G-V HG3G HG2G-V HG2G-5F HG2G-5T HG1G HG1P

4.1 Overview

In this case, there is no communication with an external device, so the MICRO/I operates as a standalone unit. It is only possible to operate the MICRO/I with relays and registers.

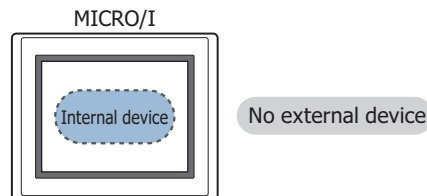

4.2 No External Devices Settings

No external devices settings are selected on the Select Communication Driver dialog box, or the **Communication Driver** tab on the Project Settings dialog box.

- By clicking , and then clicking **New**, following displayed dialog boxes and configuring settings, the Select Communication Driver dialog box is displayed. For details, refer to Chapter 4 "Create new project data by using the interactive quick start" on page 4-1.
- Click **Communication Driver** on the status bar to display the **Communication Driver** tab on the Project Settings dialog box. For details, refer to Chapter 4 "Changing Communication Drivers" on page 4-21.

Select **No External Devices** in **Manufacturer**.

5 User Communication

HG2J-7U HG5G-V HG4G-V HG4G HG3G-V HG3G HG2G-V HG2G-5F HG2G-5T HG1G HG1P

5.1 Overview

User Communication allows you to develop a communication protocol to transmit and receive data from an external device, such as a barcode reader.

User Communication is supported up to three interfaces of the MICRO/I, either serial, Ethernet, or USB interfaces.

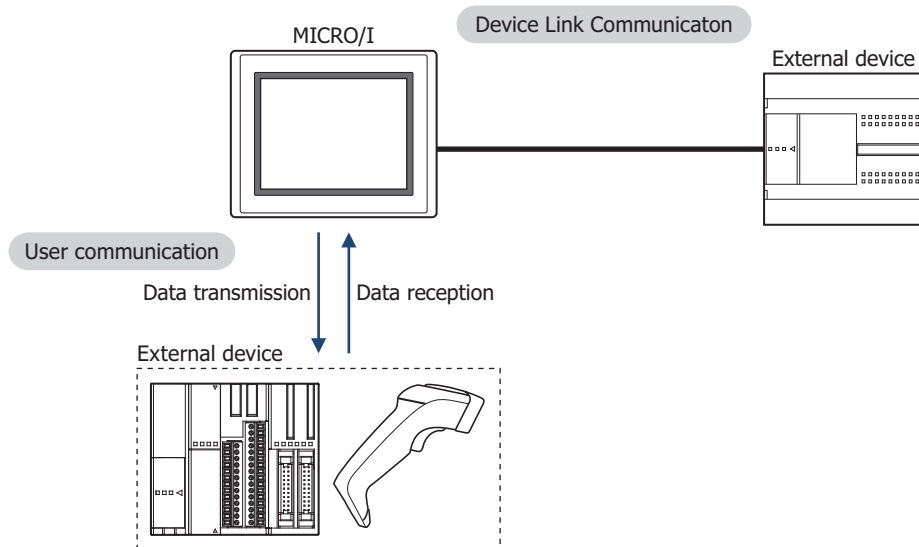

When the serial interface connecting external devices is RS485, a maximum of 31 external devices can be connected. However, carefully check the specifications including the command settings and error processing and verify whether or not multiple external devices is possible and if so how many number of external devices may be supported.



- Flow Control setting is **None**.
- The maximum size of sent data and the maximum size of received data is 1,500 bytes.

5.2 User Communication Settings Procedure

This section describes the procedure for setting user communication.

- Create a new user communication protocol, and then configure it to a communication interface

Using Transmission Command and Receive Command

HG2J-7U HG5G-V HG4G-V HG4G HG3G-V HG3G HG2G-V HG2G-5F HG2G-5T HG1G HG1P



To use the commands for inching function with HG1P, refer to "Using Inching Function" on page 3-21.

- 1 On the **Configuration** tab, in the **System Setup** group, click **Project**.

The Project Settings dialog box is displayed.

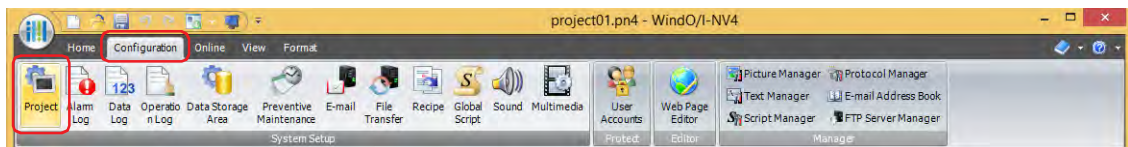

- 2 Click the **Communication Interface** tab on the Project Settings dialog box.

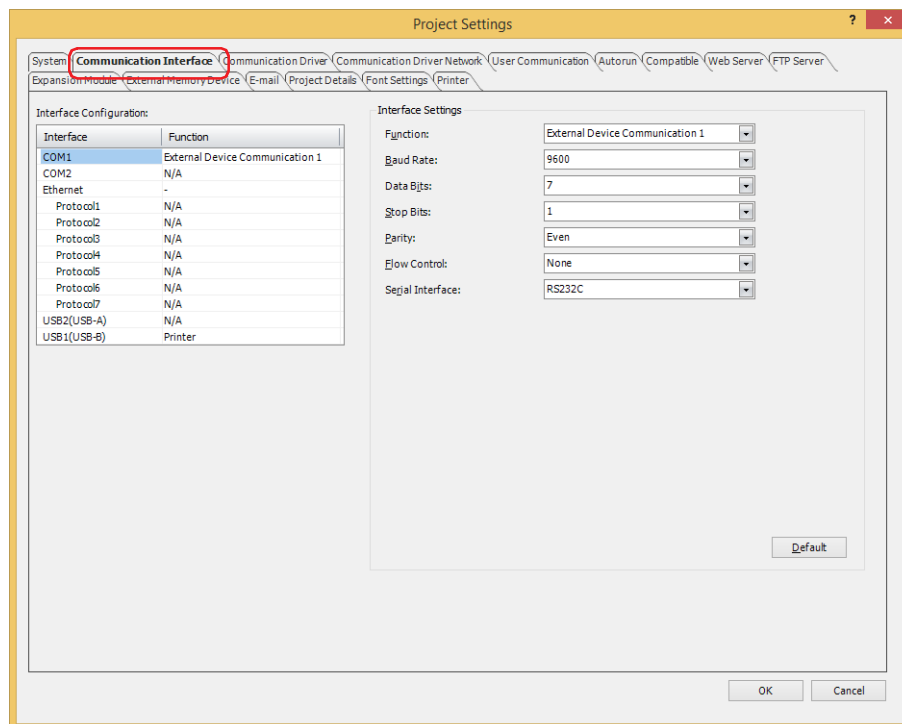

- 3 Select the interface for user communication under **Interface Configuration**, and then select the user communication in **Function** under **Interface Settings**.

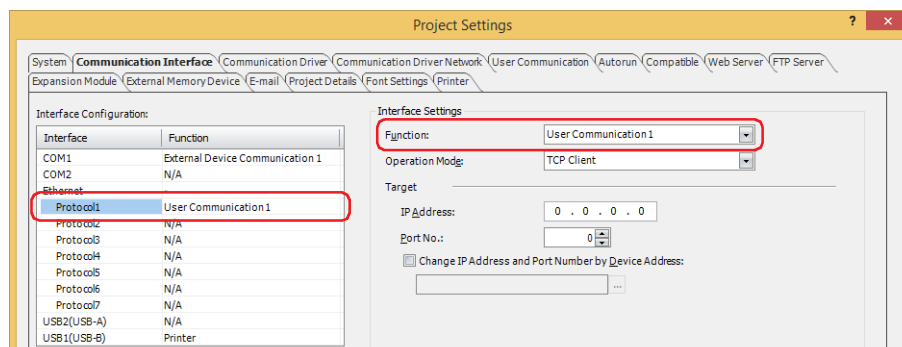

4 Specify the items for **Interface Settings**.

The settings vary based on the interface.

■ **Serial Interface**

- HG5G/4G/3G/2G-V, HG4G/3G, HG2G-F

☞ For details, refer to Chapter 4 “When COM1, COM2, COM2(RS232C), or COM2(RS422/485) is selected under Interface Configuration” on page 4-39.

- HG2J-7U, HG2G-5T, HG1G/1P*1

☞ For details, refer to Chapter 4 “When SERIAL1(RS232C), SERIAL1(RS422/485), COM(RS232C), or COM(RS422/485) is selected under Interface Configuration” on page 4-40.

■ **Ethernet Interface**

☞ For details, refer to Chapter 4 “When Protocol1 to Protocol7 is selected for Ethernet under Interface Configuration” on page 4-43.

■ **USB Interface**

☞ For details, refer to Chapter 4 “When USB1(USB-A) or USB2(USB-A) is selected under Interface Configuration” on page 4-45.

5 Click the **User Communication** tab.

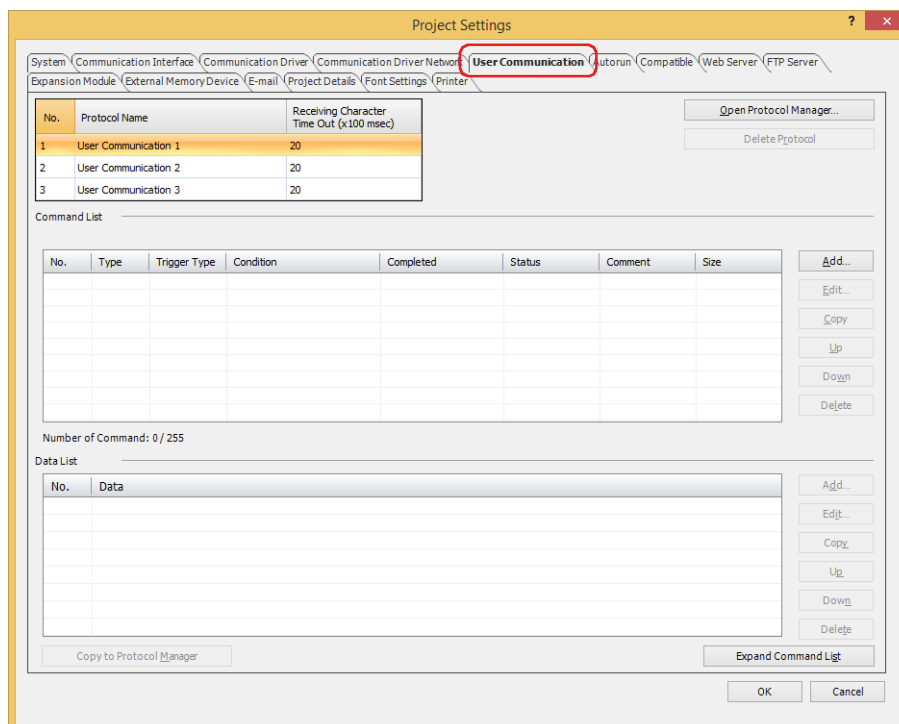

*1 Only special product of HG1P is equipped with a serial interface (RS232C).

- 6 Enter the name of the user communication protocol that will be set in **Protocol Name**.

The maximum number for protocol name is 40 characters.



You cannot use the following characters in the protocol name.

" * , / : ; < > ? \ |

The screenshot shows the 'Project Settings' dialog box with the 'User Communication' tab selected. A table lists three protocols:

No.	Protocol Name	Receiving Character Time Out (x100 msec)
1	Sample01	20
2	User Communication 2	20
3	User Communication 3	20

Below the table is a 'Command List' section with a table that is currently empty. To the right of the table are buttons for 'Add...', 'Edit...', 'Copy', 'Up', 'Down', and 'Delete'. Below the table, it says 'Number of Command: 0 / 255'. At the bottom right of the dialog are 'OK' and 'Cancel' buttons.

- 7 Set the time out (0 to 255) in **Receiving Character Time Out (x100 msec)**.

For details on the **Receiving Character Time Out (x100 msec)**, refer to "Receiving Character Time Out (x100 msec)" on page 3-32.

- 8 Set Transmission (TXD) command.
Click **Add** under **Command List**.

The Command Settings dialog box is displayed.

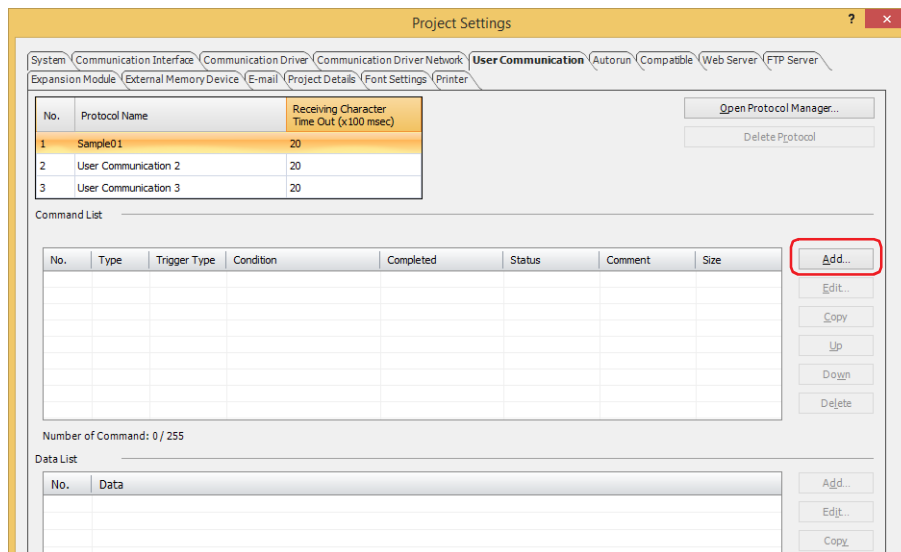

- 9 Select **TXD** in **Type**.

Specify the transmitted data to the external device connected to the MICRO/I and the conditions for transmitting data.

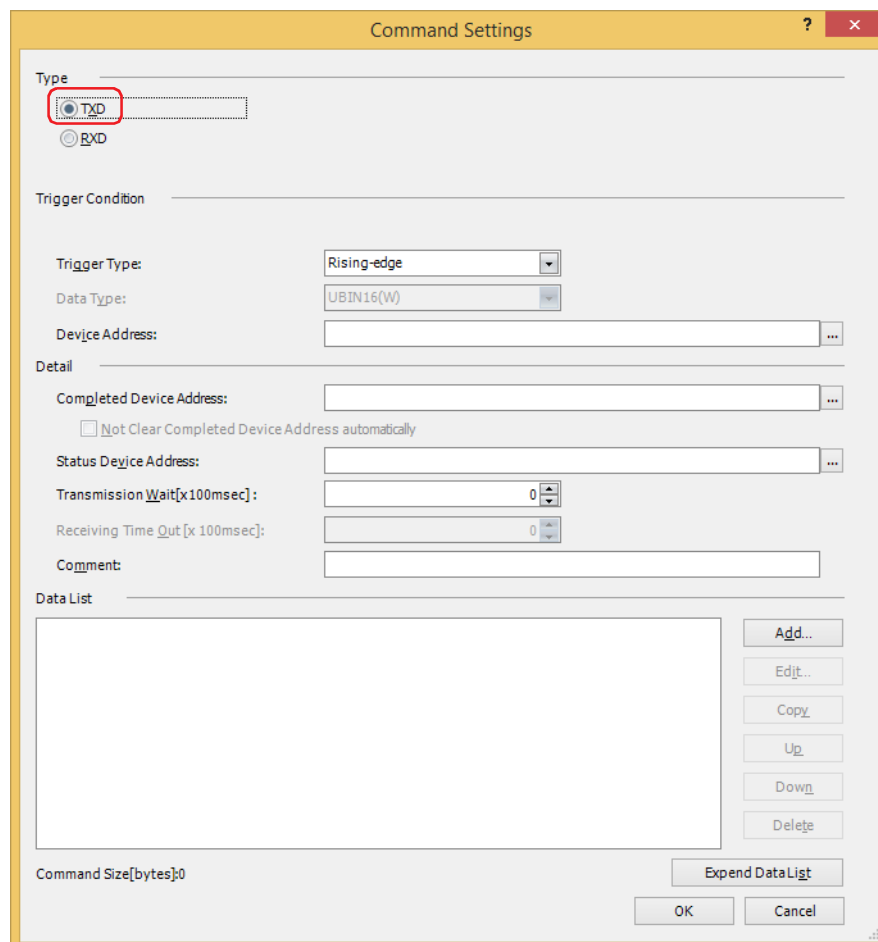

10 Select the condition to transmit data in **Trigger Type** under **Trigger Condition** from the following.

■ **Rising-edge**

Data is transmitted when the value of device address changes from 0 to 1.
Specify the bit device or the bit number of the word device as the condition.

Click to display the Tag Editor. For the device address configuration procedure, refer to Chapter 2 "5.1 Device Address Settings" on page 2-70.

■ **Falling-edge**

Data is transmitted when the value of device address changes from 1 to 0.
Specify the bit device or the bit number of the word device as the condition.

Click to display the Tag Editor. For the device address configuration procedure, refer to Chapter 2 "5.1 Device Address Settings" on page 2-70.

■ **Satisfy the condition**

Data is transmitted when condition changes from not satisfied to satisfied.

Specify the conditional expression in **Condition** and select the data type handled by the conditional expression in **Data Type**.

Click to display the Trigger Condition Settings dialog box. For the conditional expressions configuration procedure, refer to Chapter 2 "5.2 Setting Conditional Expressions" on page 2-73.

For details on data types, refer to Chapter 2 "1.1 Available Data" on page 2-1.

■ **Fixed Period**

Data is transmitted at a fixed time interval.

Set the time interval between data transmissions as 1 to 3600 (seconds) in **Period (sec)**.

11 Specify the bit device or the bit number of the word device for reporting that data transmission was successfully completed in **Completed Device Address** under **Detail**.

Click to display the Tag Editor. For the device address configuration procedure, refer to Chapter 2 "5.1 Device Address Settings" on page 2-70.

12 Specify the destination word device for the transmitted data size and error information in **Status Device Address** under **Detail**.

Click to display the Tag Editor. For the device address configuration procedure, refer to Chapter 2 "5.1 Device Address Settings" on page 2-70.

13 Specify the wait time (0 to 255) from when the trigger condition is satisfied to when the data is transmitted in **Transmission Wait (x100 msec)** under **Detail**.

14 Enter a comment for transmission command in **Comment** under **Detail**.

The maximum number is 40 characters.

15 Set data for transmission command.

Click **Add** under **Data List**.

The Data Settings dialog box is displayed.

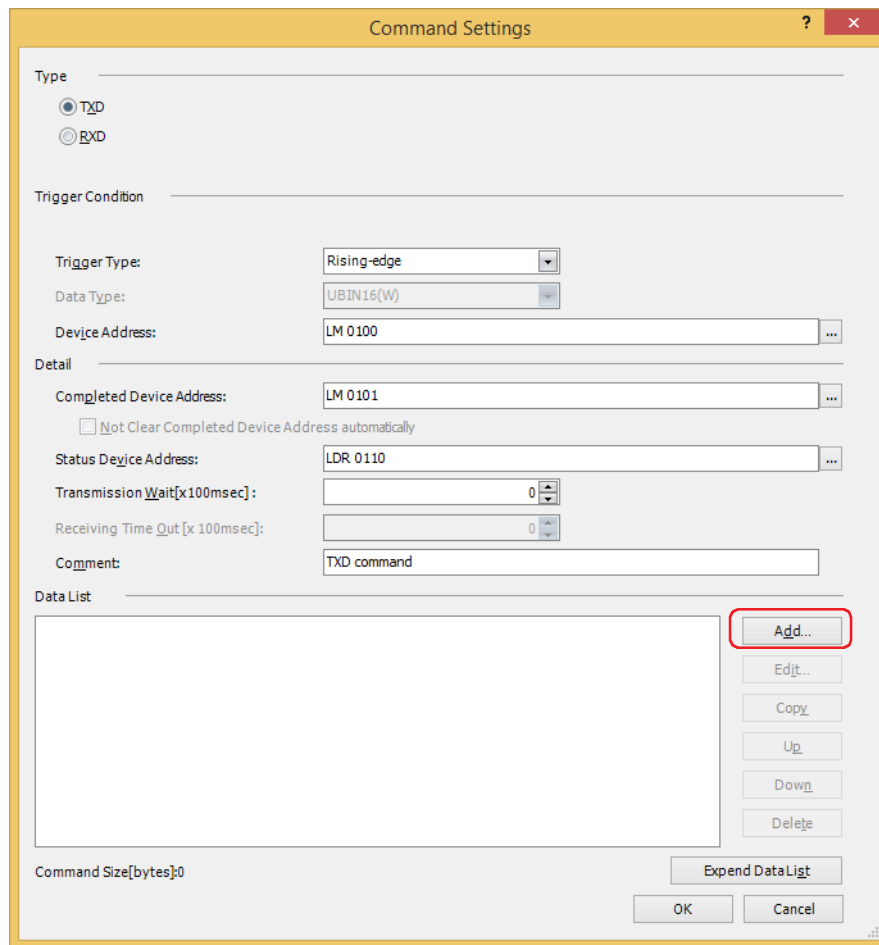

16 Select data type in **Type**.

Data setting items are displayed.

For details on transmission command, refer to "Transmission (TXD) Command" on page 3-49.

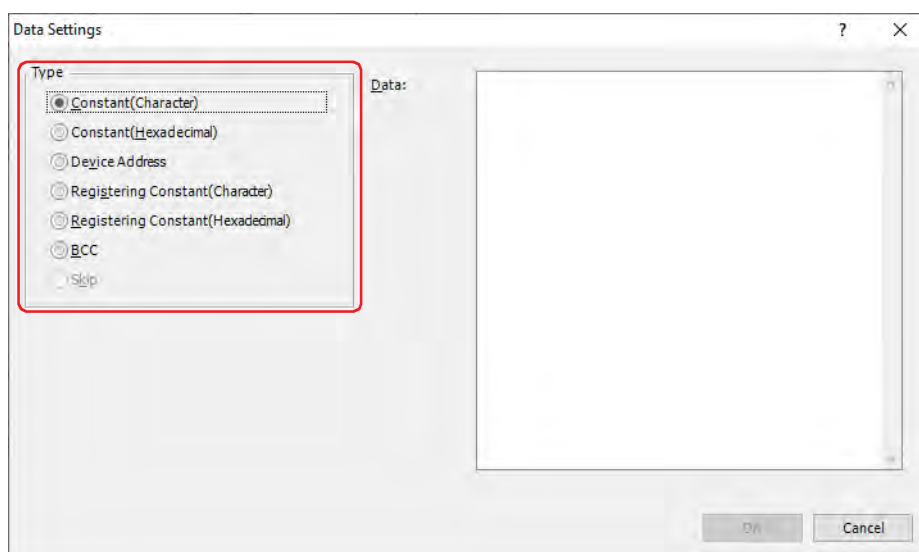

17 Set the data, and then click **OK**.

The data configured in **Data List** on the Command Settings dialog box is displayed.

18 Repeat steps 15 through 17 to set all the data for the transmission command.



- The data is displayed in **Data List** in the order they were set. To change the order of data, select data, and then click **Up** or **Down** to shift it.
- Click **Expand Data List** to hide **Type**, **Trigger Condition** and **Detail**, the number of the data displayed in **Data List** will increase.

19 Click **OK**.

The transmission command configured in **Command List** and **Data List** on Project Settings dialog box is displayed.

- 20 Specify Receive (RXD) command.
Click **Add** under **Command List**.

The Command Settings dialog box is displayed.

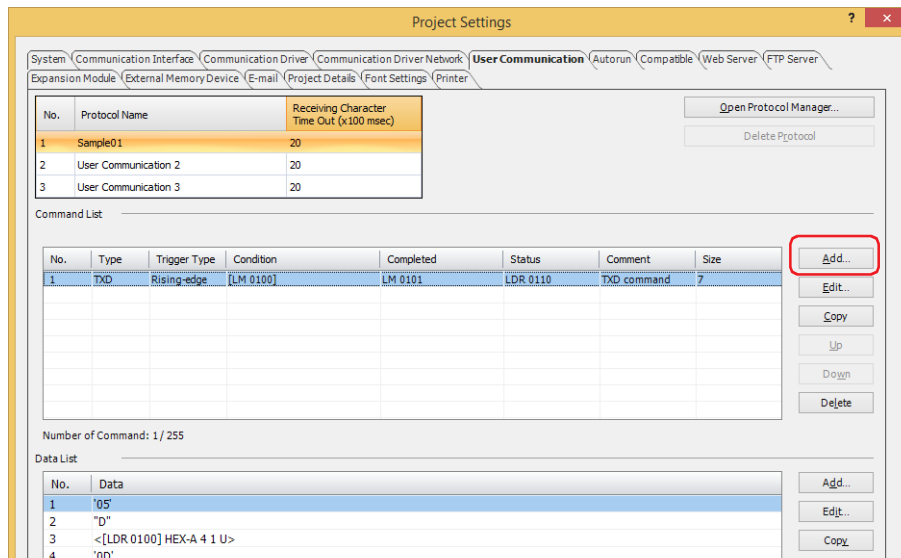

- 21 Select **RXD** in **Type**.

Define the data configuration for received data from the external device.

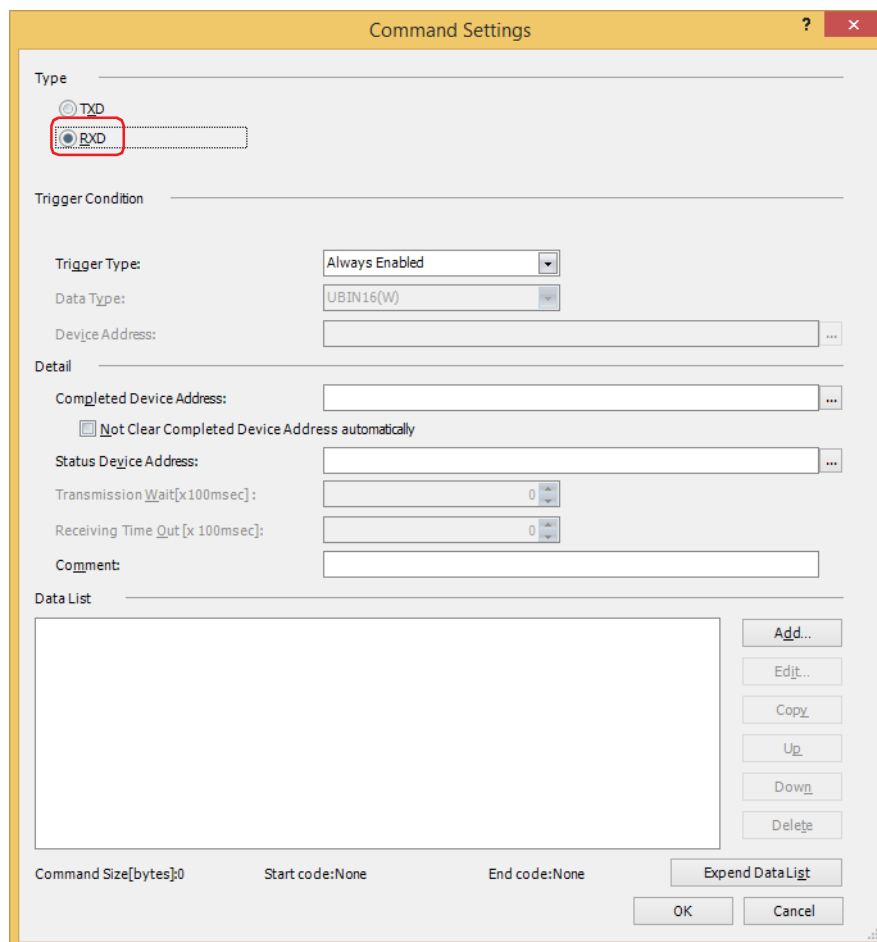

- 22 Select the condition for being ready to receive data in **Trigger Type** under **Trigger Condition** from the following.
- **Always Enabled**
The device is always ready to receive data.
 - **While ON**
Ready to receive data when the value of device address is 1.
Specify the bit device or the bit number of the word device as the condition.
Click to display the Tag Editor. For the device address configuration procedure, refer to Chapter 2 "5.1 Device Address Settings" on page 2-70.
 - **While OFF**
Ready to receive data when the value of device address is 0.
Specify the bit device or the bit number of the word device as the condition.
Click to display the Tag Editor. For the device address configuration procedure, refer to Chapter 2 "5.1 Device Address Settings" on page 2-70.
 - **While satisfying the condition**
Ready to receive data while a condition is satisfied.
Specify the conditional expression in **Condition** and select the type of data handled by the conditional expression in **Data Type**.
Click to display the Trigger Condition Settings dialog box. For the conditional expressions configuration procedure, refer to Chapter 2 "5.2 Setting Conditional Expressions" on page 2-73.
For details on data types, refer to Chapter 2 "1.1 Available Data" on page 2-1.
- 23 Specify the bit device or the bit number of the word device for reporting that data receiving was successfully completed in **Completed Device Address** under **Detail**.
Click to display the Tag Editor. For the device address configuration procedure, refer to Chapter 2 "5.1 Device Address Settings" on page 2-70.
If the value of Completed Device Address automatically is not set to 0 after it is set to 1, select the **Not Clear Completed Device Address automatically** check box.
- 24 Specify the destination word device for the received data size and error information in **Status Device Address** under **Detail**.
Click to display the Tag Editor. For the device address configuration procedure, refer to Chapter 2 "5.1 Device Address Settings" on page 2-70.
- 25 Enter a comment for receive command in **Comment** under **Detail**.
The maximum number is 40 characters.

- 26 Set data for receive command.
Click **Add** under **Data List**.

The Data Settings dialog box is displayed.

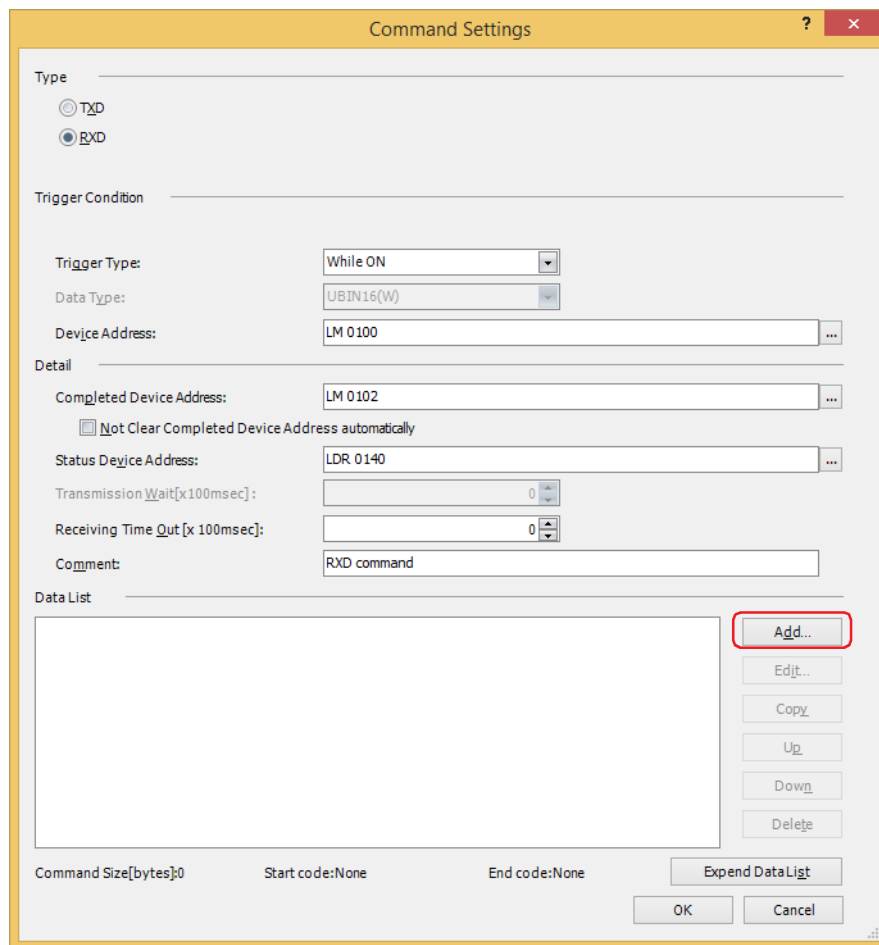

- 27 Select data type in **Type**.

Data setting items are displayed.

For details on receive command, refer to "Receive (RXD) Command" on page 3-62.

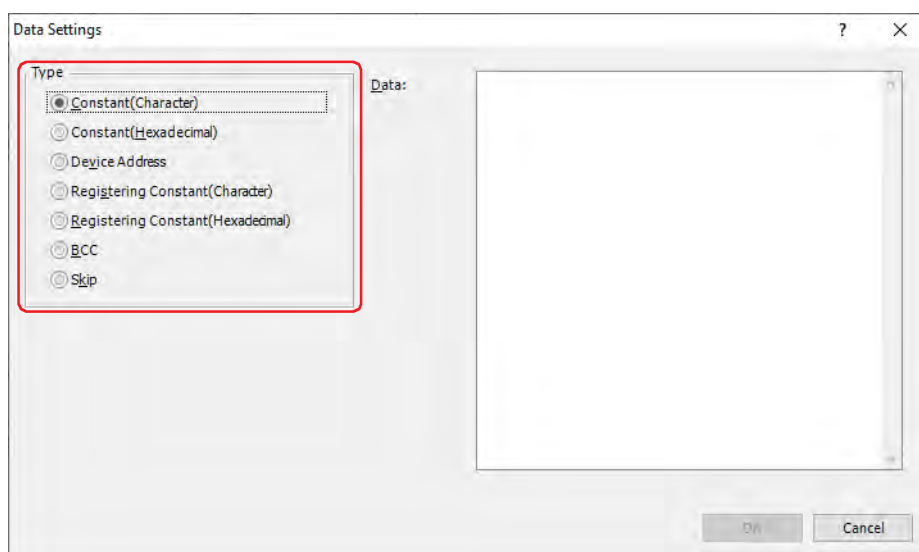

- 28 Specify the data, and then click **OK**.

The data configured in **Data List** on the Command Settings dialog box is displayed.

29 Repeat steps 26 through 28 to specify all the data for the receive command.

The screenshot shows the 'Command Settings' dialog box with the following fields and values:

- Type:** TXD (unselected), RXD (selected)
- Trigger Condition:**
 - Trigger Type: While ON
 - Data Type: UBIN16(W)
 - Device Address: LM 0100
- Detail:**
 - Completed Device Address: LM 0102
 - Not Clear Completed Device Address automatically
 - Status Device Address: LDR 0140
 - Transmission Wait [x100msec]: 0
 - Receiving Time Out [x 100msec]: 0
 - Comment: RXD command
- Data List:**
 - '02'
 - "D"
 - <[LDR 0120] A-DEC 4 1 U>
 - '0D'
- Summary:** Command Size[bytes]:7, Start code:02h, End code:0Dh



- The data are displayed in **Data List** in the order they were set. To change the order of data, select data, and then click **Up** or **Down** to shift it.
- Click **Expand Data List** to hide **Type**, **Trigger Condition** and **Detail**, the number of the data displayed in **Data List** will increase.

30 Click **OK**.

The receive command configured in **Command List** and **Data List** on Project Settings dialog box is displayed.

To add a transmission command, repeat steps 8 through 19. To add a receive command, repeat steps 20 through 29.

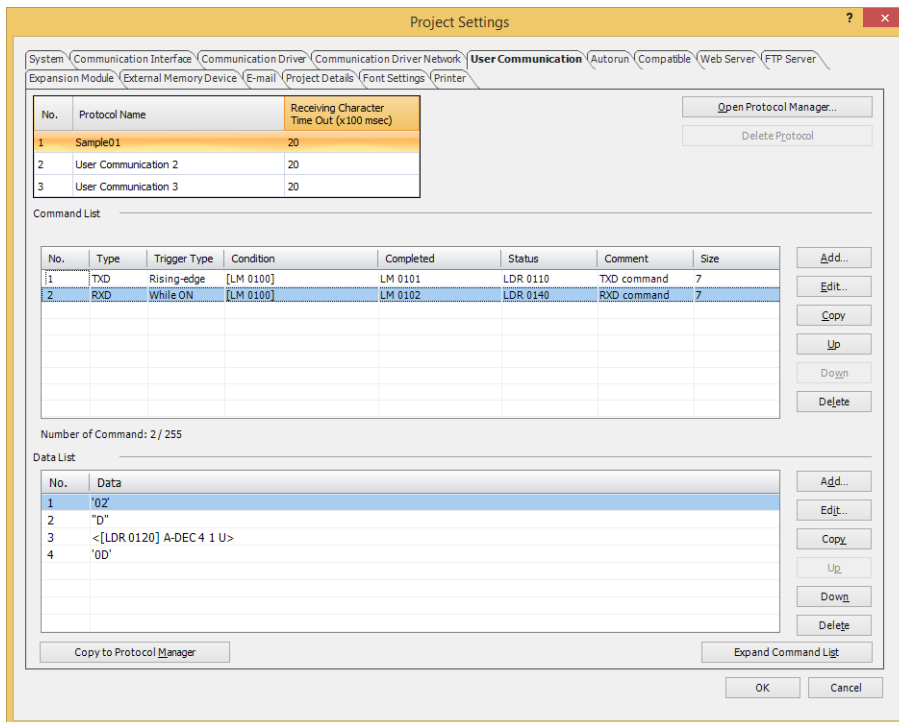
31 Configure all commands, click **OK**.

This concludes configuring user communication to use Transmission (TXD) and Receive (RXD) commands.



To set the created user communication protocol to another user communication or to use it in another project, click **Copy to Protocol Manager** to register it in Protocol Manager. For details on the Protocol Manager, refer to "5.3 Protocol Manager" on page 3-32.

Using Inching Function

HG2J-7U HG5G-V HG4G-V HG4G HG3G-V HG3G HG2G-V HG2G-5F HG2G-5T HG1G HG1P

- 1 On the **Configuration** tab, in the **System Setup** group, click **Project**.

The Project Settings dialog box is displayed.



- 2 Click the **Communication Interface Tab** in the Project Settings dialog box.

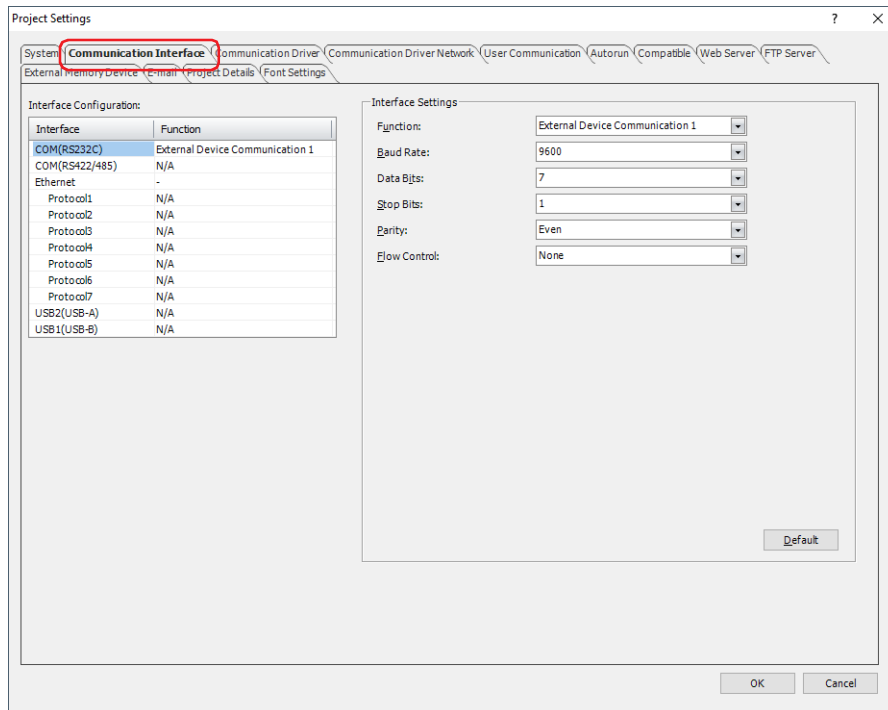

- 3 Select the interface for user communication under **Interface Configuration**, and then select the **User Communication 1**^{*1} in **Function** under **Interface Settings**.

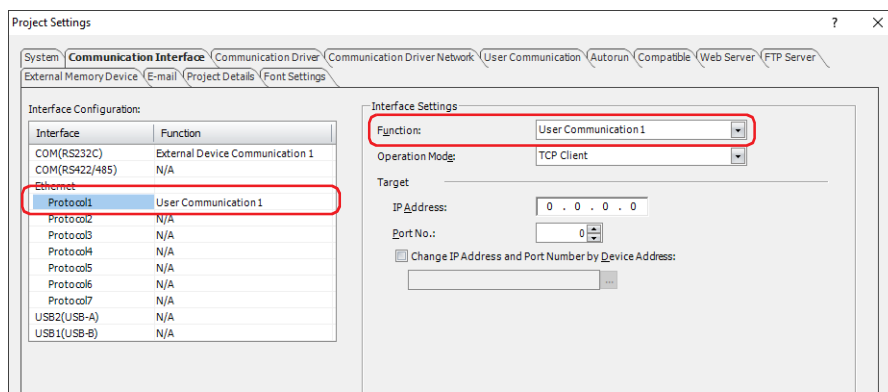

*1 Inching function can be configured only for **User Communication 1**.

4 Specify the items for **Interface Settings**.

The settings vary based on the interface.

■ **Serial Interface***1

☞ For details, refer to Chapter 4 "When SERIAL1(RS232C), SERIAL1(RS422/485), COM(RS232C), or COM(RS422/485) is selected under Interface Configuration" on page 4-40.

■ **Ethernet Interface***2

☞ For details, refer to Chapter 4 "When Protocol1 to Protocol7 is selected for Ethernet under Interface Configuration" on page 4-43.

5 Click the **User Communication** tab.

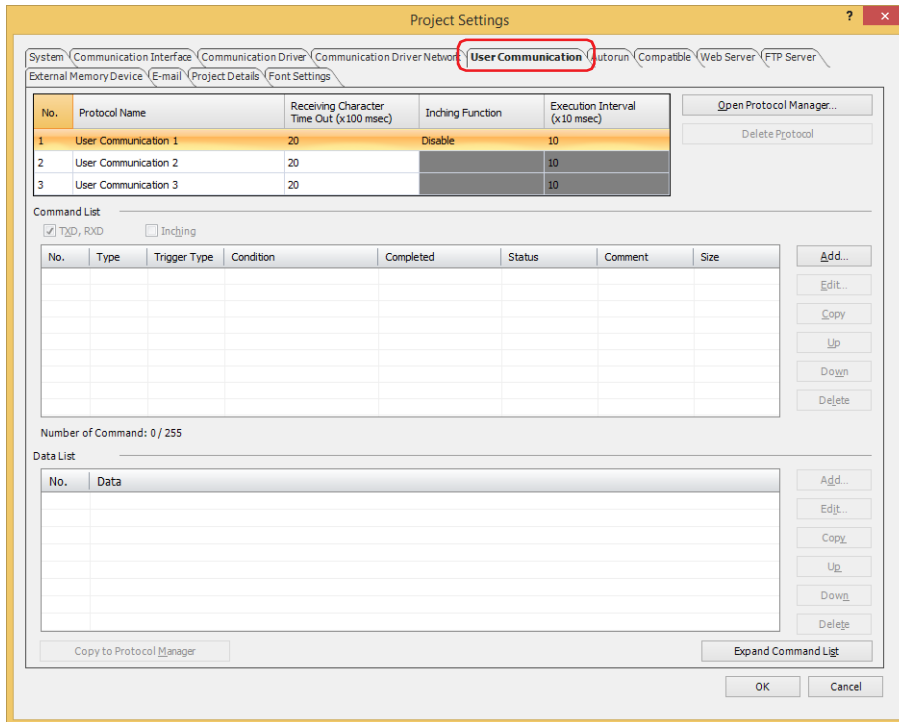

6 Enter the name of the user communication protocol that will be set in **Protocol Name**.

The maximum number for protocol name is 40 characters.



You cannot use the following characters in the protocol name.

" * , / : ; < > ? \ |

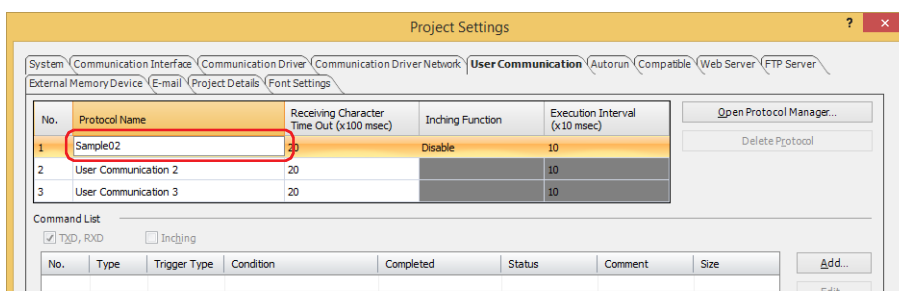

*1 Only special product is equipped with a serial interface (RS232C).

*2 This is applicable for models with an ethernet interface only.

- 7 Double click the cell under **Inching Function** and select **Enable**.

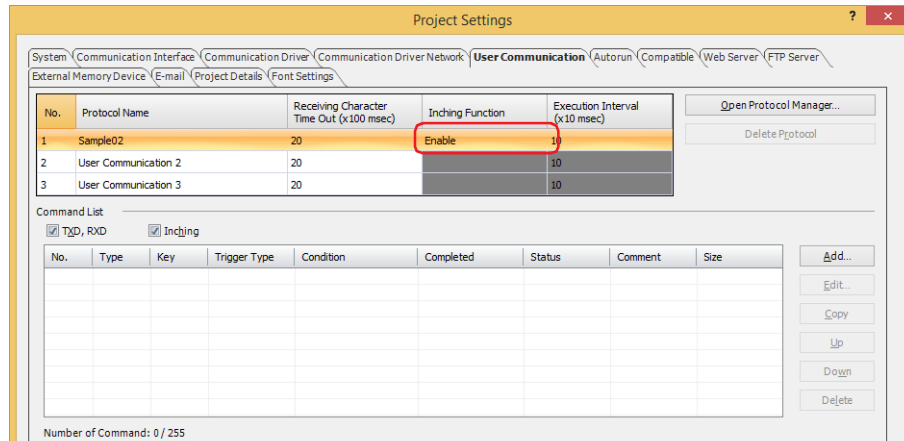

- 8 Specifies the **Execution Interval (x10 msec)** as 40 to 1000 (20 ms increments).
 9 Select the **Inching** check box.



The items displayed in **Command List** can be changed with the **TXD**, **RXD** and **Inching** check boxes. Commands in **Command List** are displayed in the order they were created, but commands for inching function are always displayed above the transmission and receive commands in the list.

- 10 Configure the transmission command for the Inching Function.
 Click **Add** under **Command List**.

The Command Settings dialog box is displayed.

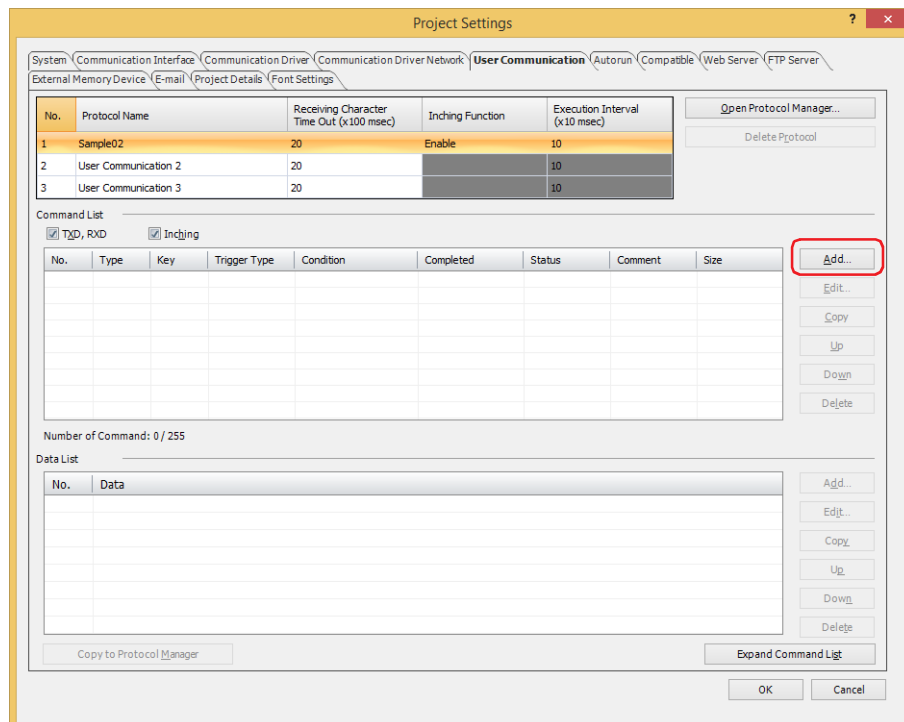

11 Select **Inching** in **Type**.

Specify the transmitted data for the inching function to the external device connected to the MICRO/I and the conditions for transmitting data.

12 With **Function Key** under **Trigger Condition**, select the function key (F1 to F12) to which the command will be assigned.

The function key is the switch on both sides of the screen of the HG1P.

13 Select the condition to transmit data in **Trigger Type** under **Trigger Condition** from the following.

■ **Always Enabled**

Data is always transmitted at the specified execution interval while a function key is pressed.

■ **While satisfying the condition**

Data is transmitted at the specified execution interval while a condition is satisfied.

Specify the conditional expression in **Condition** and select the data type handled by the conditional expression in **Data Type**.

Click to display the Trigger Condition Settings dialog box. For the conditional expressions configuration procedure, refer to Chapter 2 "5.2 Setting Conditional Expressions" on page 2-73.

For details on data types, refer to Chapter 2 "1.1 Available Data" on page 2-1.

14 Specify the bit device or the bit number of the word device for reporting that data transmission was successfully completed in **Completed Device Address** under **Detail**.

Click to display the Tag Editor. For the device address configuration procedure, refer to Chapter 2 "5.1 Device Address Settings" on page 2-70.

15 Specify the destination word device for the transmitted data size and error information in **Status Device Address** under **Detail**.

Click to display the Tag Editor. For the device address configuration procedure, refer to Chapter 2 "5.1 Device Address Settings" on page 2-70.

- 16 Enter a comment of the command for the inching function in **Comment** under **Detail**.

The maximum number is 40 characters.

- 17 Set the command data for the inching function.
Click **Add** under **Data List**.

The Data Settings dialog box is displayed.

- 18 Select data type in **Type**.

Data setting items are displayed.

For details on transmission command, refer to "Transmission (TXD) Command" on page 3-49.

19 Set the data, and then click **OK**.

The data configured in **Data List** on the Command Settings dialog box is displayed.

20 Repeat steps **17** through **19** to set all the command data for the inching function.



- The data are displayed in **Data List** in the order they were set. To change the order of data, select data, and then click **Up** or **Down** to shift it.
- Click **Expand Data List** to hide **Type**, **Trigger Condition** and **Detail**, the number of the data displayed in **Data List** will increase.

21 Click **OK**.

The command for the inching function configured in **Command List** and **Data List** on Project Settings dialog box is displayed.

To add a command for inching function, repeat steps **10** through **20**.

To add a transmission command, repeat steps **8** through **19** of "Using Transmission Command and Receive Command".

To add a receive command, repeat steps **20** through **29** of "Using Transmission Command and Receive Command".

22 Configure all commands, click **OK**.

The screenshot shows the 'Project Settings' dialog box with the 'User Communication' tab selected. The 'Protocol Name' table is as follows:

No.	Protocol Name	Receiving Character Time Out (x100 msec)	Inching Function	Execution Interval (x10 msec)
1	Sample02	20	Enable	10
2	User Communication 2	20		10
3	User Communication 3	20		10

The 'Command List' section shows the following table:

No.	Type	Key	Trigger Type	Condition	Completed	Status	Comment	Size
1	Inching	F7	While satisfying...	[LSD 031] == 5	LM 0301	LDR 0330	TXD Inching co...	7

The 'Data List' section shows the following table:

No.	Data
1	'01'
2	'K'
3	'31' '10'
4	BCC(1 0 XOR.HEX-A 2)
5	'0D'

This concludes configuring user communication.



To set the created user communication protocol to another user communication or to use it in another project, click **Copy to Protocol Manager** to register it in Protocol Manager. For details on the Protocol Manager, refer to "5.3 Protocol Manager" on page 3-32.

- Configuring registered user communication protocol to another user communication
Configure an user communication protocol registered in Protocol Manager to another user communication.

1 On the **Configuration** tab, in the **System Setup** group, click **Project**.

The Project Settings dialog box is displayed.



2 In the **User Communication** tab on the Project Settings dialog box, select the user communication to set from the protocol list, and then click **Open Protocol Manager**.

Protocol Manager is displayed.

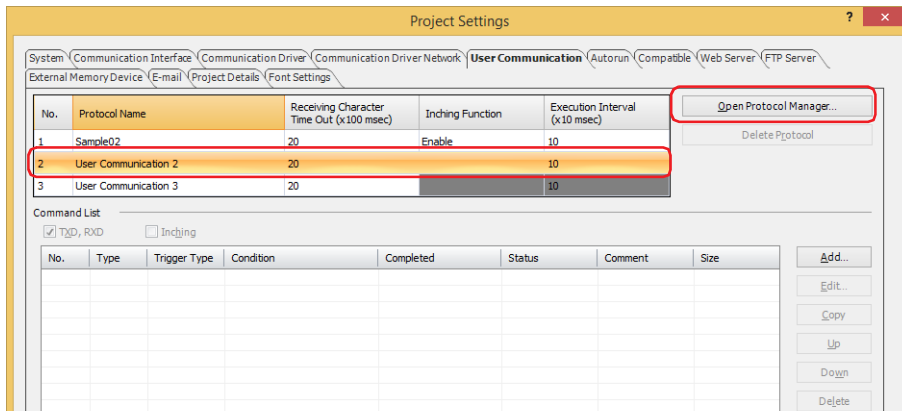

3 Select a user communication protocol in (**Protocol List**), and click **OK**.

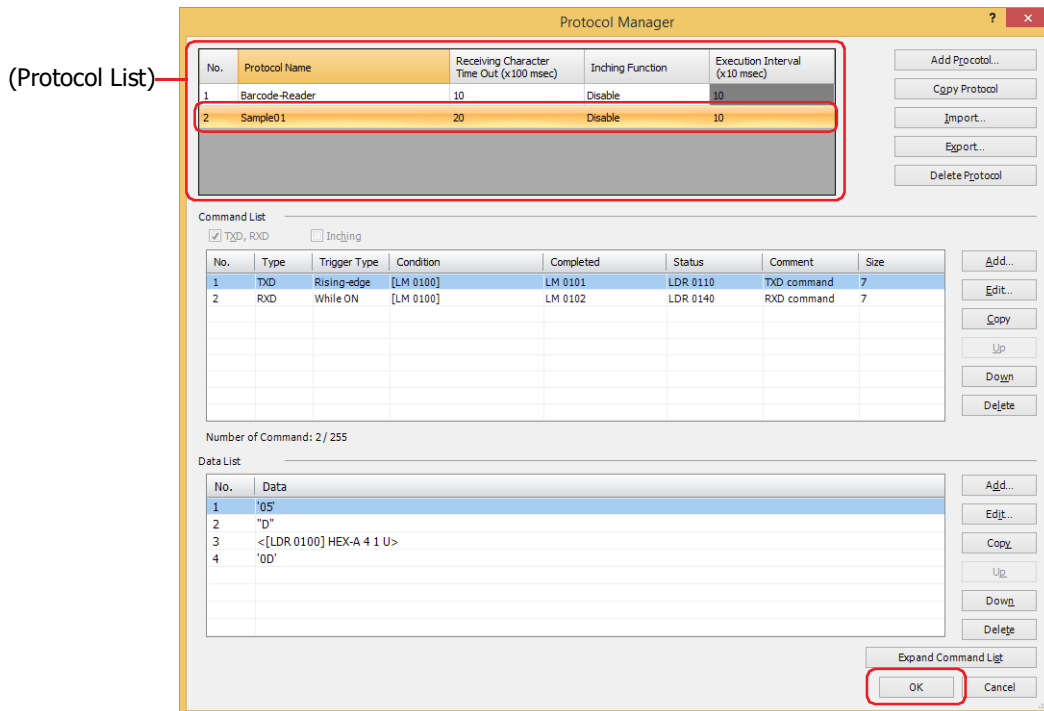

The user communication protocol selected in Protocol Manager is configured to the user communication specified on the Project Settings dialog box.

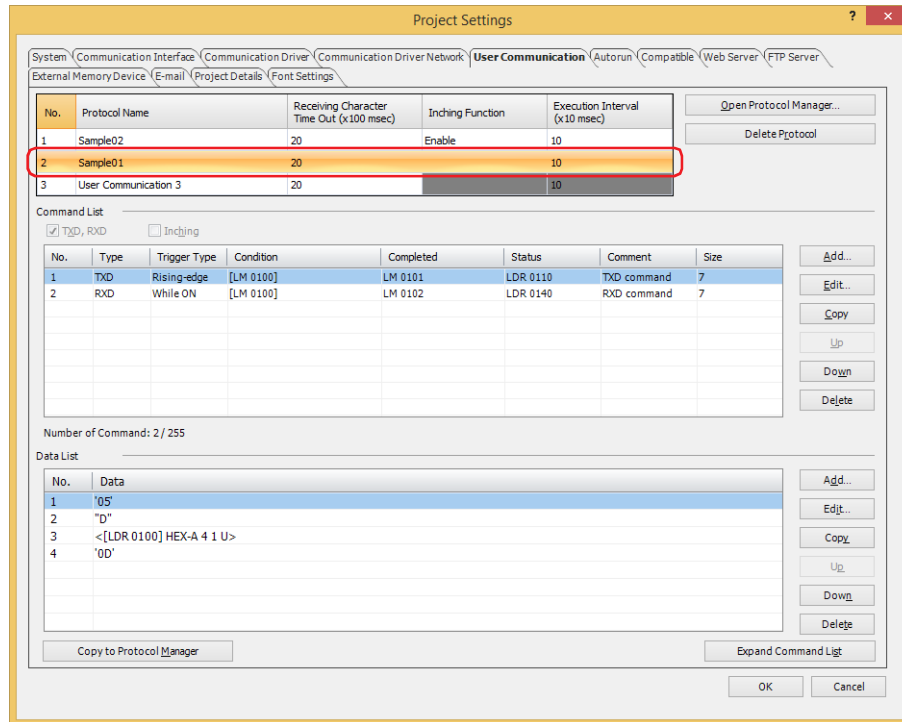

- Using registered user communication protocol on another project

To use the user communication protocol registered in Protocol Manager on another project, save it as a file, and then import it to a project.

Saving registered user communication protocol as a file

1 On the **Configuration** tab, in the **Manager** group, click **Protocol Manager**.

Protocol Manager is displayed.

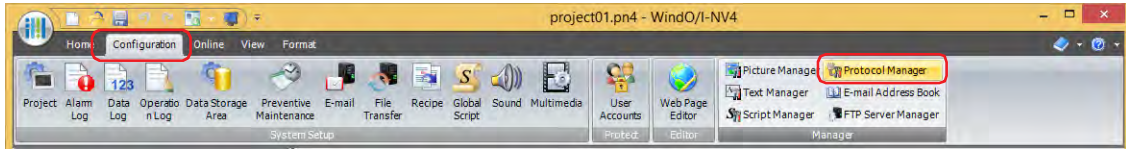

2 Select the user communication protocol in (**Protocol List**), and then click **Export**.

The Save As dialog box is displayed.

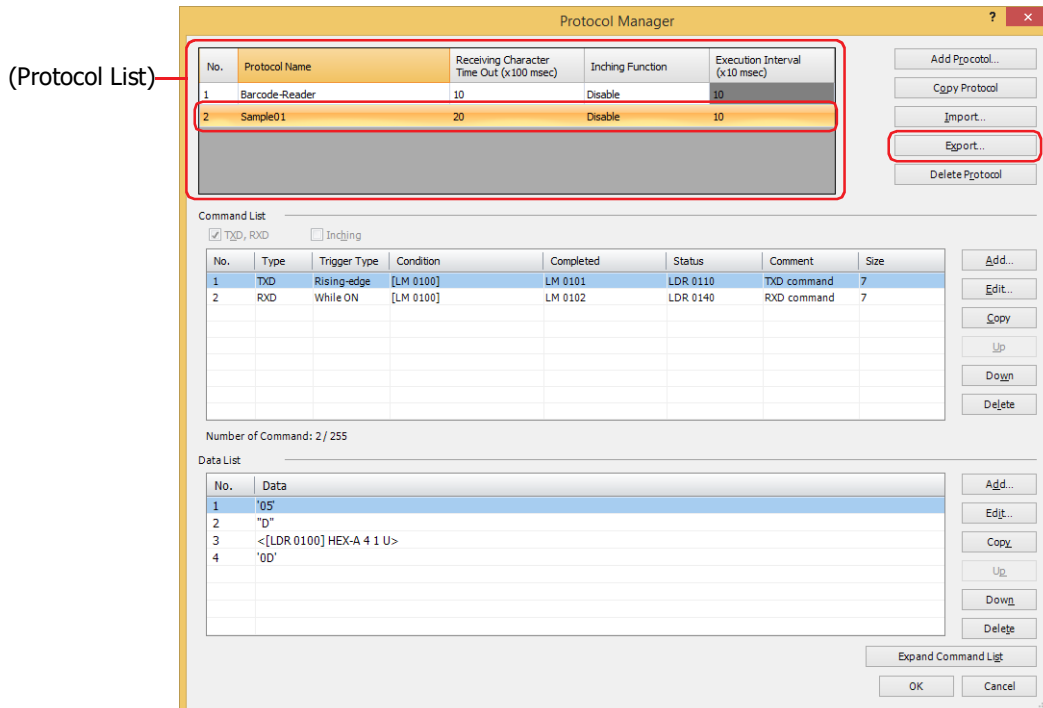

3 Specify the save location, and then click **Save**.

The name of the saved file will be the name of the protocol.

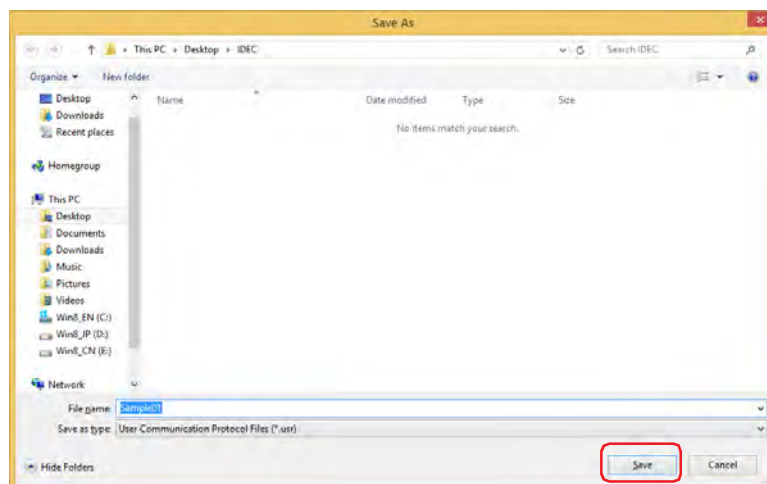

Importing user communication protocol

- 1 On the **Configuration** tab, in the **Manager** group, click **Protocol Manager**.

Protocol Manager is displayed.



- 2 On Protocol Manager, click **Import**.

The Open dialog box is displayed.

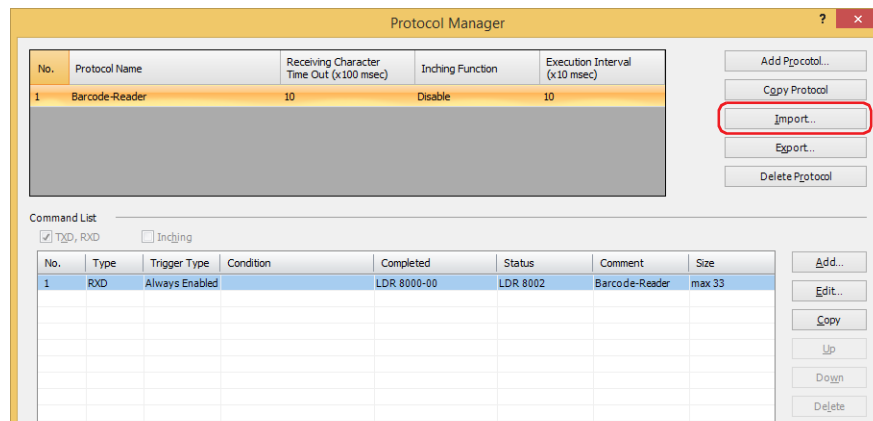

- 3 Specify the user communication protocol file, and then click **Open**.

The user communication protocol is registered in Protocol Manager. The name of the user communication protocol file is set as the name of the protocol.

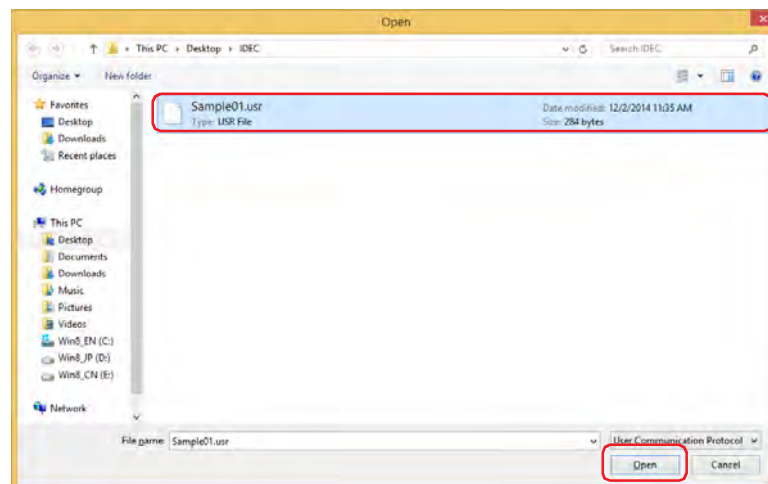

5.3 Protocol Manager

User communication protocols to use in user communication can be created and registered protocols can be edited.

(Protocol List)

No.	Protocol Name	Receiving Character Time Out (x100 msec)	Inching Function	Execution Interval (x10 msec)
1	Barcode-Reader	10	Disable	10
2	Sample01	20	Disable	10
3	Sample02	20	Enable	10

(Type)

Command List

TXD, RXD Inching

No.	Type	Key	Trigger Type	Condition	Completed	Status	Comment	Size
1	Inching	F7	While satisfying...	[LSD 031] == 5	LM 0301	LDR 0330	TXD Inching co...	7

Number of Command: 1 / 255

Data List

No.	Data
1	'01'
2	'K'
3	'31'10'
4	BCC(1 0 XOR HEX-A 2)
5	'0D'

■ (Protocol List)

Displays the registered user communication protocol.

No.: Displays the number for managing the user communication protocol.

Protocol Name: Enter the name of the user communication protocol. The maximum number for protocol name is 40 characters.



You cannot use the following characters in the protocol name.

" * , / : ; > ? \ |

Receiving Character Time Out (x100 msec):

Specify the time out value (0 to 255) from when 1 frame of data has been received to when the next frame of data starts to be received. A frame refers to a data string from the beginning to the end of a command. If the Receiving Character Time Out is set to 0, it is not monitored. These setting items are used only with receive command.

Example: The received data (1 frame) is 2 bytes, **While ON** is selected as **Trigger Type** in **Trigger Condition** and LM100 is set to **Device Address**, LM101 is set to **Completed Device Address**, and LDR110 is set to **Status Device Address**

The data of second byte starts to be received before exceeding the Receiving Character Time Out duration after the data of first byte is received, and the values of the Completed Device Address and Status Device Address when receiving of the data has been successfully completed are as follows.

- The value of the Completed Device Address LM101 changes to 1.
When the **Not Clear Completed Device Address automatically** check box is not selected, when the value of the Trigger Condition device address LM100 changes from 0 to 1, the value of the Completed Device Address LM101 changes to 0.
When the **Not Clear Completed Device Address automatically** check box is selected, the value of Completed Device Address LM101 remains 1, so set 0 if necessary.

- The value of the Receiving Character Time Out (address number+0, bit 15) of the Status Device Address LDR110 remains 0.

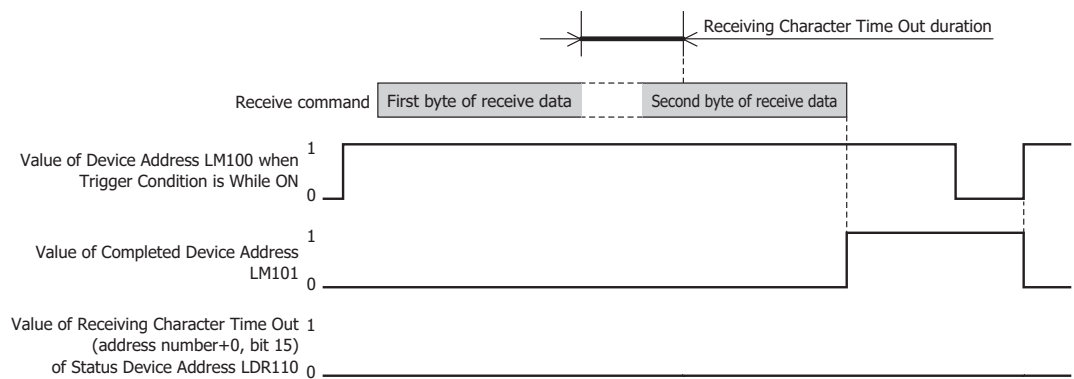

When the Receiving Character Time Out duration exceeds until the data of second byte starts to be received after the data of first byte is received, the value of the Receiving Character Time Out (address number+0, bit 15) of the Status Device Address LDR110 changes to 1 and the Completed Device Address LM101 remains 0. In addition, when the value of the Trigger Condition device address LM100 changes from 0 to 1, the value of LDR110 (address number +0, bit 15) changes to 0.

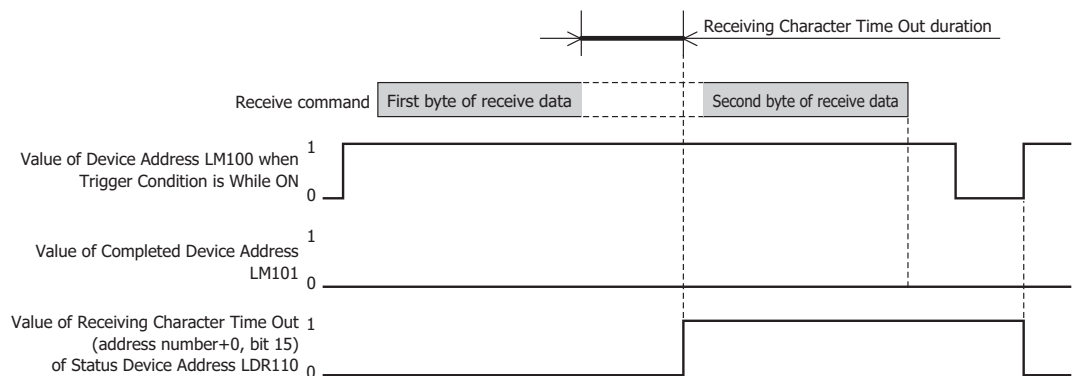

Inching Function^{*1}: Displays whether or not the inching function is used. Double clicking the cell switches between **Enable** and **Disable**. This can only be set for the User Communication 1. By using the inching function, data is transmitted at the specified execution interval.



Inching refers to the inching operation of the drive section. It is a general term for drive operations that repeatedly start and stop in small increments for each operation, such as starting and stopping the drive section when a push button or switch is pushed and released.

Execution Interval (x10 msec)^{*1}: Specifies the interval to send the commands for inching function as 40 to 1000 (20 ms increments).

This option can only be set when **Enable** is selected in **Inching Function**.



The command cannot be sent at the specified execution interval if the following conditions occur:

- The transmission processing for a command cannot be completed within the time set by **Execution Interval**.
⇒ Set **Execution Interval** to a time longer than it takes to send the command.
- The inching function was used at the same time as user communication transmission or receive processing.
⇒ Do not use transmission commands, receive commands and commands for inching function at one time.



One frame is transmitted with no character spacing.

*1 HG1P only

- Add Protocol:** Adds a user communication protocol to the **(Protocol List)**.
- Copy Protocol:** Copies the selected user communication protocol in the **(Protocol List)**.
Click this button to add a copy of the selected user communication protocol to the end of the **(Protocol List)**.
- Import:** Imports a saved user communication protocol file. Click this button to display the Open dialog box. For details, refer to "Importing user communication protocol" on page 3-31.
- Export:** Export and saves a user communication protocol selected in the **(Protocol List)** as a file. Click this button to display the Save As dialog box. For details, refer to "Saving registered user communication protocol as a file" on page 3-30.
Saved user communication protocols can be imported using **Import**.
- Delete Protocol:** Deletes a user communication protocol selected in the **(Protocol List)**.

■ Command List

The command settings for the user communication protocol selected in the **(Protocol List)** are displayed.

- (Type)*1:** Changes the items displayed in the list according to the type of command.
- TXD, RXD:** Select this check box to display transmission and receive commands.
- Inching:** Select this check box to display commands for the inching function.



User communication protocol commands are displayed in the order they were created, but commands for inching function are always displayed above the transmission and receive commands in the list.

- No.:** Shows the number for managing command settings. Double clicking the cell displays the Command Settings dialog box.
- Type:** Shows the type of command. Double clicking the cell displays the Command Settings dialog box.
- Key:** Shows the function keys (F1 to F12) assigned to the command. Double clicking the cell displays the Command Settings dialog box.
This option is displayed only when the **Inching** check box is selected.
- Trigger Type:** Shows the trigger type for data transmission or being ready to receive data. Double clicking the cell displays the Command Settings dialog box.
- Condition:** Shows the condition of trigger type for data transmission or being ready to receive data. Double clicking the cell displays the Command Settings dialog box. The displayed content varies based on **Trigger Type**.
- Always Enabled:** Trigger conditions are not necessary, so nothing is displayed.
- Rising-edge, Falling-edge, While ON, or While OFF:**
Shows the bit device or the bit of the word device as the condition.
- While satisfying the condition or Satisfy the condition:**
Shows the conditional expression.
- Fixed Period:** Shows the period.
- Completed:** Shows the device address for reporting when transmission or receiving of data is successfully completed. Double clicking the cell displays the Command Settings dialog box.
- Status:** Shows the destination device address for the transmitted or received data size and error information. Double clicking the cell displays the Command Settings dialog box.
- Comment:** Shows the command comment. Double clicking the cell displays the Command Settings dialog box.
- Size:** Shows the command data size in bytes. The maximum is displayed if there is data that has the **Variable** check box selected on the Data Settings dialog box. Double clicking the cell displays the Command Settings dialog box.

*1 HG1P only

Add:	Adds a command to the Command List . A maximum of 255 commands may be added. Click this button, displays the Command Settings dialog box. For details, refer to "Command Settings Dialog Box" on page 3-36.
Edit:	Edits the command selected in the Command List . Click this button, displays the Command Settings dialog box. For details, refer to "Command Settings Dialog Box" on page 3-36.
Copy:	Copies the command selected in the Command List . Click this button to add a copy of the selected command to the end of the Command List. Inching function commands are added above the transmission and receive commands.
Up:	Shifts the selected command upward in the list.
Down:	Shifts the selected command downward in the list.
Delete:	Deletes the selected command from the Command List .



Adding, copying, and shifting up and down happen within the range of the same type of command. There are two types of commands: **TXD**, **RXD** and **Inching**.

■ Data List

Displays the list of command data selected in the **Command List**.

No.:	Displays the number for managing the data. Double clicking the cell displays the Data Settings dialog box. For details, refer to "Data Settings Dialog Box" on page 3-48.
Data:	Displays the data settings. Double clicking the cell displays the Data Settings dialog box. For details, refer to "Data Settings Dialog Box" on page 3-48.
Add:	Add: Adds a data to Data List . Click this button, displays the Data Settings dialog box. For details, refer to "Data Settings Dialog Box" on page 3-48.
Edit:	Changes the selected data in Data List . Click this button, displays the Data Settings dialog box. For details, refer to "Data Settings Dialog Box" on page 3-48.
Copy:	Copies the selected data in Data List . Click this button to add a copy of the selected data to the end of the Data List.
Up:	Shifts the selected data upward in the list.
Down:	Shifts the selected data downward in the list.
Delete:	Deletes the selected data from Data List .

■ Expand/Contract Command List

Shows or hides the **Data List**. By hiding **Data List**, the number of commands displayed in **Command List** will increase.

● Command Settings Dialog Box

Specify the command details for user communication protocol.

Command Settings

Type

TXD

RXD

Inching

Trigger Condition

Function Key: F7

Trigger Type: While satisfying the condition

Data Type: UBIN16(W)

Condition: [LSD 031] == 5

Detail

Completed Device Address: LM 0301

Not Clear Completed Device Address automatically

Status Device Address: LDR 0330

Transmission Wait[x100msec]: 0

Receiving Time Out [x 100msec]: 0

Comment: TXD Inching command

Data List

'01'

"K"

'31' '10'

BCC(1 0 XOR HEX-A 2)

'0D'

Command Size[bytes]:7

Expand Data List

OK Cancel

■ Type

Select the type of communication command from the following items.

TXD: A command for data transmission from the MICRO/I to an external device.

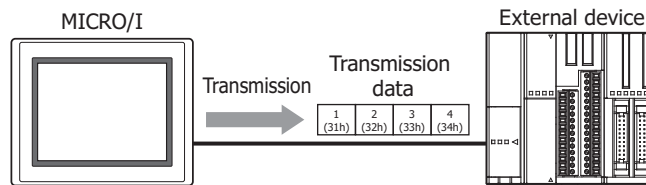

Processing of transmission command is as follows.

Example: When **Trigger Type** in **Trigger Condition** is **Rising-edge**, **Device Address** is LM100 and **Completed Device Address** is LM101

When the value of the Trigger Condition device address LM100 changes to 1, data is transmitted by user communication from the MICRO/I to the external device. When data transmission is successfully completed, the value of the Completed Device Address LM101 changes to 1.

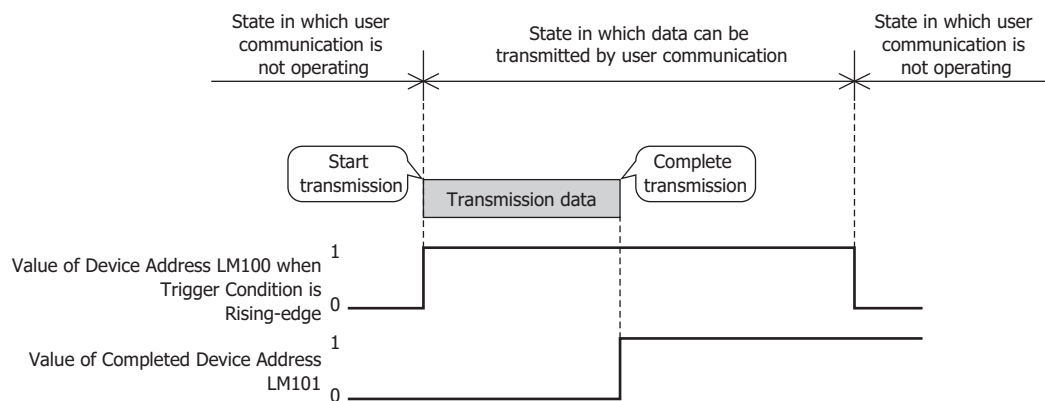

RXD: A command for analyzing and processing data received by the MICRO/I from an external device.

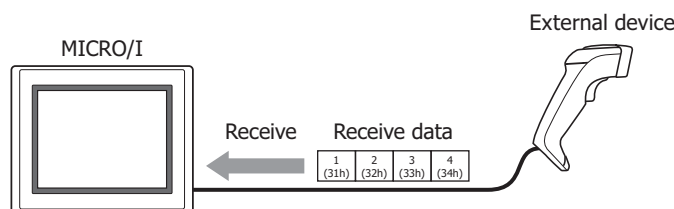

Processing of receive command is as follows.

Example: When **Trigger Type** in **Trigger Condition** is **While ON**, **Device Address** is LM100 and **Completed Device Address** is LM101

When the value of the Trigger Condition device address LM100 changes to 1, data can be received (ready to receive) by user communication, so when data is transmitted from the external device, the MICRO/I starts to receive the data. When data receiving is successfully completed, the value of the Completed Device Address LM101 changes to 1.

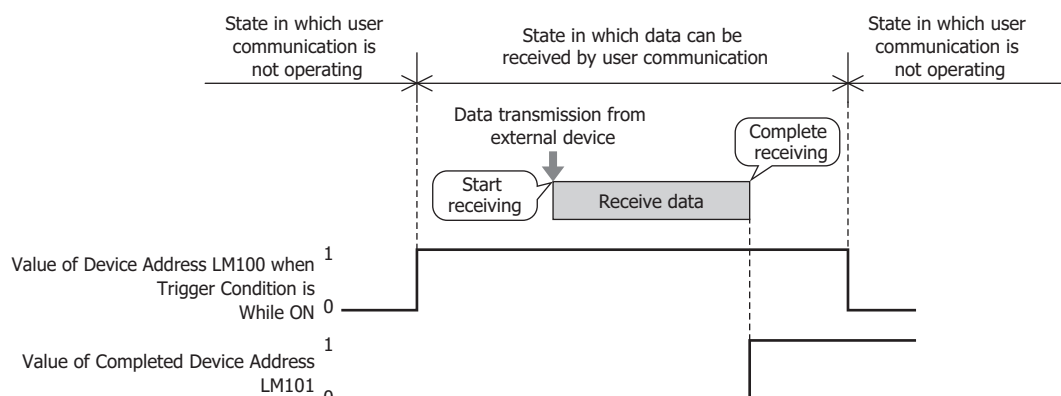

Inching: Commands that send data from the MICRO/I to the external device and execute inching operations of the driving part.
 This option can only be set when **Enable** is selected in **Inching Function** on the Project Settings dialog box.

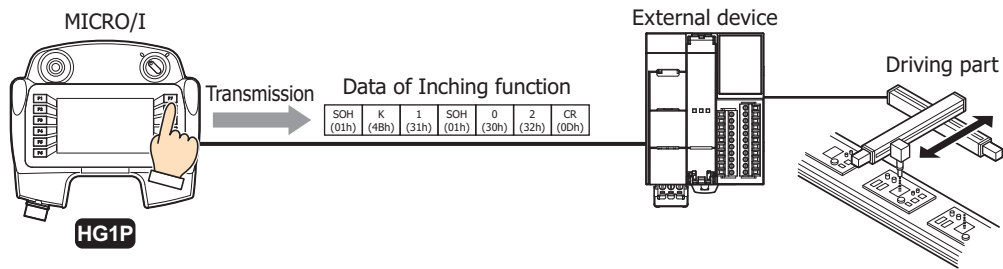

Processing of the command for the inching function is as follows:

Example: **Function Key in Trigger Condition is F7, Trigger Type is While satisfying the condition, Condition is LSD31==5 and Completed Device Address is LM301**
 When the value of the Condition LSD31 is 5 and the Function Key F7 is pressed, data is transmitted by user communication from the MICRO/I to the external device.
 When data transmission is successfully completed, the value of the Completed Device Address LM301 changes to 1.

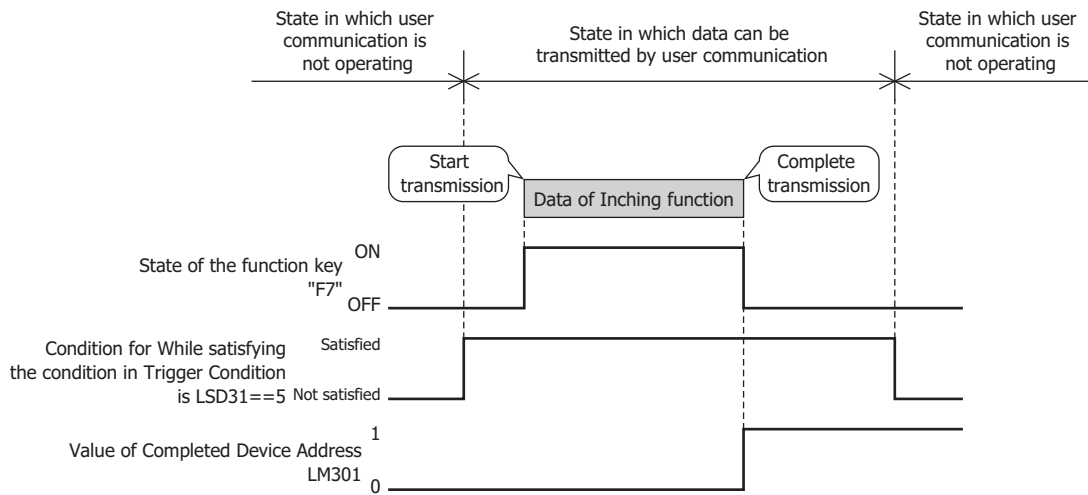

■ Trigger Condition

Set the trigger conditions for transmission or receiving of data.

TXD is selected as **Type**:

Trigger Type: A condition for data transmission is selected from the following.

Rising-edge: Data is transmitted when the value of device address changes from 0 to 1.

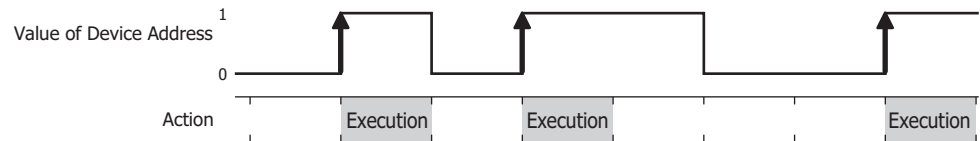

Falling-edge: Data is transmitted when the value of device address changes from 1 to 0.

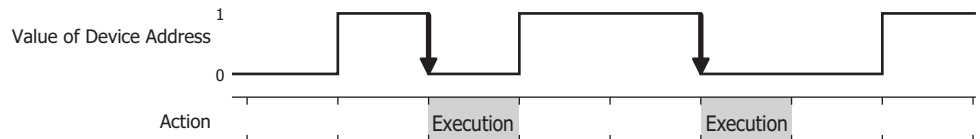

Satisfy the condition:

Data is transmitted when the condition changes from not satisfied to satisfied.

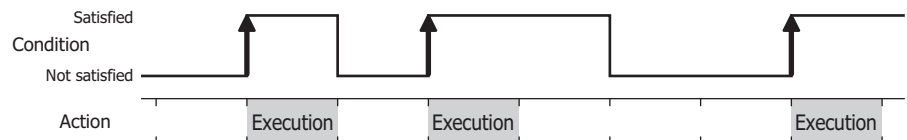

Fixed Period: Data is transmitted at a fixed time interval.

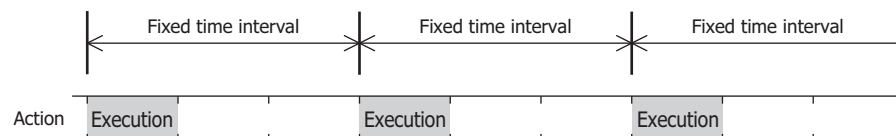

Data Type: Select the data type handled by the conditional expression.

Can only be set if **Satisfy the condition** is selected as **Trigger Type**.

For details, refer to Chapter 2 "1.1 Available Data" on page 2-1.

Device Address: Specifies the bit device or the bit number of the word device to serve as condition. You can only specify the internal device.

Can only be set if **Rising-edge** or **Falling-edge** is selected as **Trigger Type**.

Click to display the Tag Editor. For the device address configuration procedure, refer to Chapter 2 "5.1 Device Address Settings" on page 2-70.

Condition: Sets the condition formula.

Can only be set if **Satisfy the condition** is selected as **Trigger Type**.

Click to display the Trigger Condition Settings dialog box. For the conditional expressions configuration procedure, refer to Chapter 2 "5.2 Setting Conditional Expressions" on page 2-73.

Period (sec): Specify the period for command execution from 1 to 3600 (seconds).

This is enabled only when **Fixed Period** is selected in **Trigger Type**.

RXD is selected as **Type**:

Trigger Type: Selects the condition to be ready to receive data from the following.

Always Enabled: The MICRO/I is always ready to receive data.

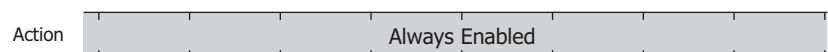

While ON: Ready to receive data when the value of device address is 1.

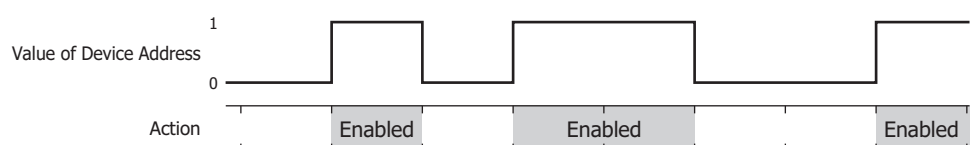

While OFF: Ready to receive data when the value of device address is 0.

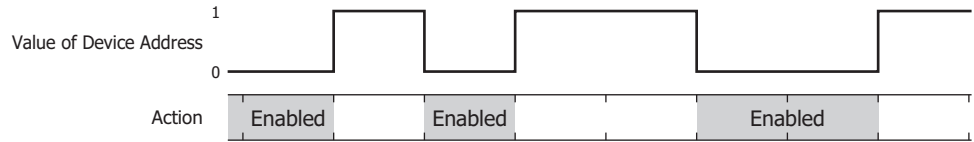

While satisfying the condition:

Ready to receive data while the condition is satisfied.

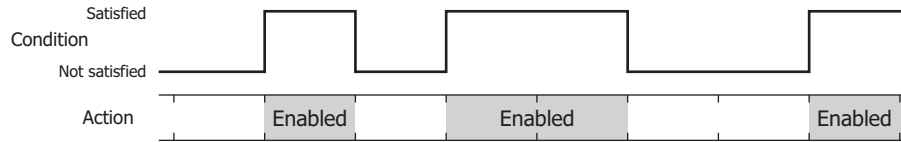

Data Type: Select the data type handled by the conditional expression.
 Can only be set if **While satisfying the condition** is selected as **Trigger Type**.
 For details, refer to Chapter 2 "1.1 Available Data" on page 2-1.

Device Address: Specifies the bit device or the bit number of the word device to serve as condition. You can only specify the internal device.
 Can only be set if **While ON** or **While OFF** is selected as **Trigger Type**.

Click to display the Tag Editor. For the device address configuration procedure, refer to Chapter 2 "5.1 Device Address Settings" on page 2-70.

Condition: Sets the condition formula.
 Can only be set if **While satisfying the condition** is selected as **Trigger Type**.

Click to display the Trigger Condition Settings dialog box. For the conditional expressions configuration procedure, refer to Chapter 2 "5.2 Setting Conditional Expressions" on page 2-73.

Inching is selected as **Type:**

Function Key: Select the function key (F1 to F12) assigned to the command.

Trigger Type: A condition for data transmission is selected from the following.

Always Enabled: Data is always transmitted at a configured execution interval while a function key is pressed.



While satisfying the condition:

Data is transmitted at a configured execution interval while a condition is satisfied.

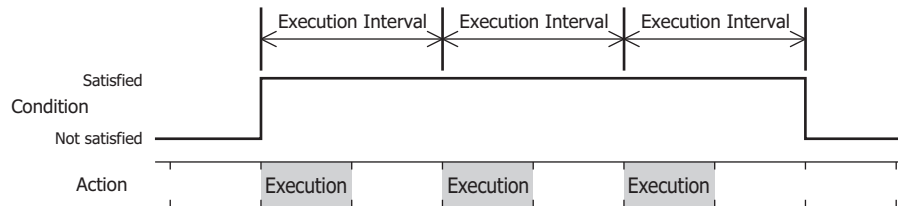

Data Type: Select the data type handled by the conditional expression.
 Can only be set if **Satisfy the condition** is selected as **Trigger Type**.
 For details, refer to Chapter 2 "1.1 Available Data" on page 2-1.

Condition: Sets the condition formula.
 Can only be set if **Satisfy the condition** is selected as **Trigger Type**.

Click to display the Trigger Condition Settings dialog box. For the conditional expressions configuration procedure, refer to Chapter 2 "5.2 Setting Conditional Expressions" on page 2-73.

■ Detail

Completed Device Address:

Specify the bit device or the bit number of the word device for reporting that data transmission or receiving was successfully completed. You can only specify an internal device.

Click to display the Tag Editor. For the device address configuration procedure, refer to Chapter 2 "5.1 Device Address Settings" on page 2-70.

Example: When **Trigger Type** in **Trigger Condition** is **While ON**, **Device Address** is LM100 and **Completed Device Address** is LM101

When data receiving is successfully completed, the value of the Completed Device Address LM101 changes to 1. When the value of the Trigger Condition device address LM100 changes from 0 to 1, the value of the Completed Device Address LM101 changes to 0.

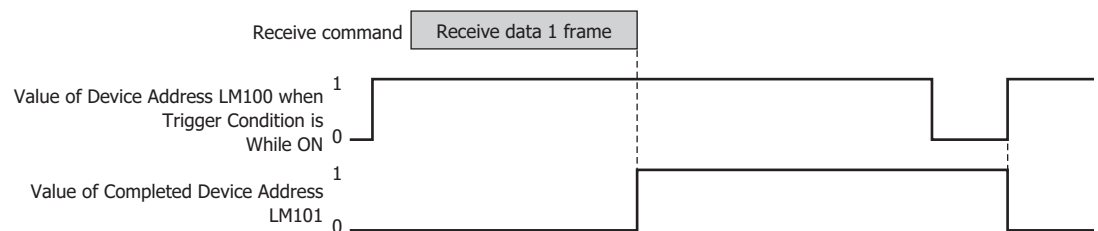

Not Clear Completed Device Address automatically:

Select this check box when the value of the Completed Device Address is not set to 0 automatically after it changes to 1. This can be configured when **RXD** is selected as **Type**.

Example: When **Trigger Type** in **Trigger Condition** is **While ON**, **Device Address** is LM100 and **Completed Device Address** is LM101

When the **Not Clear Completed Device Address automatically** check box is not selected:

When data receiving is successfully completed, the value of the Completed Device Address LM101 changes to 1. When the first data of the next frame is received, the value of the Completed Device Address LM101 changes to 0.

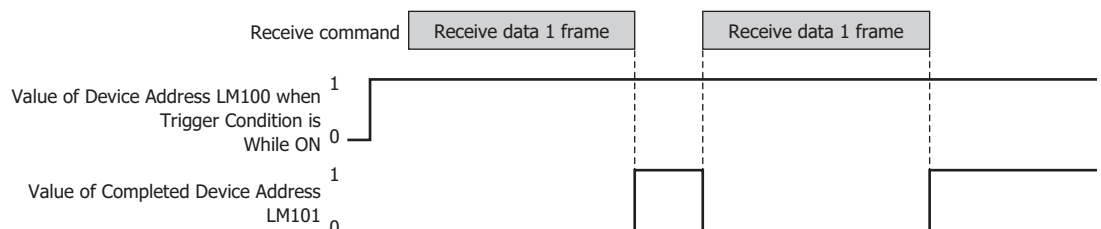

When the **Not Clear Completed Device Address automatically** check box is selected:

When data receiving is successfully completed, the value of the Completed Device Address LM101 is set to 1. Even after the first data of the next frame is received, the value of the Completed Device Address LM101 does not change to 0.

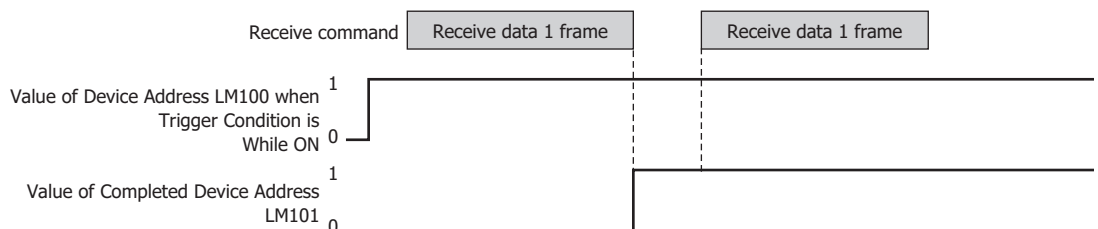

Status Device Address:

Specify the destination word device for the transmitted or received data size and error information. Error information and command data size is stored at the beginning of the configured device address. When data transmission or receiving has not successfully completed, the value of each bit changes to 1. The bits of the Status Device Address changes to 0 when the trigger condition is satisfied and they are not changed to 0 automatically. When **Always Enabled** is selected in **Trigger Condition** of receive command, the value of the Status Device Address is kept as long as a Clear command is not executed.

You can only specify an internal device.

Click to display the Tag Editor. For the device address configuration procedure, refer to Chapter 2 "5.1 Device Address Settings" on page 2-70.

Example: When LDR110 is configured as **Status Device Address**

(Starting address number) +0 ← Error information and time out information
 +1 ← Transmitted or received data size (bytes)

TXD or Inching is selected as **Type**:

Address number	Bit	Function	Cause	Solution
+0	0	BCC Error	<ul style="list-style-type: none"> The Calculation Start Position and Calculation End Position are not stored in 1 frame. The Calculation End Position is set before Calculation Start Position. When Calculation Type is Modbus ASCII (LCR), the data size from Calculation Start Position to Calculation End Position is odd bytes. The ASCII data contains data other than ASCII (30h to 39h, 41h to 46h) data. 	Change the Calculation Start Position and Calculation End Position settings.
	1, 2	Reserved		
	3	Registering Constant Data Error	When data type is Registering Constant (Character) or Registering Constant (Hexadecimal) , the value of the Index Device Address does not match the Index No. of the registered Registering Constant.	Change the data stored in the Index Device Address.
	4	Reserved		
	5	Use Reference Device Data Error	When data type is Device Address and the Use Reference Device Address check box is selected, the device address in which the value of the Reference Device Address is stored as offset has exceeded the valid range.	Change the value stored in the Reference Device Address.
	6	Device Data Variable Specification Error	When data type is Device Address , the Variable check box is selected and Device Address is selected, the value of device address is negative or exceeds the setting (number of bytes x number of words).	Change the value of device address to a positive value or to a value that does not exceed the setting (number of bytes x number of words).
	7	Transmission Command Abandon Error	When transmitting command after the Trigger Condition is satisfied, the command with the same Command No. was transmitting or transmission (transmission is not completed).	Increase the time interval for starting transmission.
	8	Inching Transmission Command Abandon Error	The processing to send the inching function command did not complete within the time set by Execution Interval (transmission is not completed)	Increase the Execution Interval for inching.
	9 to 15	Reserved		

Address number	Function	Description
+1	Transmission Data Size (bytes)	Stores the size of transmission data.



When the Error Information bit changes to 1, data is not transmitted, and the Transmission Completed Device Address does not change to 1.

RXD is selected as **Type**:

Address number	Bit	Function	Cause	Solution
+0	0	BCC error	The BCC that calculated the receive data did not match the BCC that is appended to the receive data.	Check the transmission data from the external device.
			<ul style="list-style-type: none"> The Calculation Start Position and Calculation End Position are not stored in 1 frame. The Calculation End Position is set before Calculation Start Position. 	Change the Calculation Start Position and Calculation End Position settings.
			<ul style="list-style-type: none"> When Calculation Type is Modbus ASCII (LCR), the data size from Calculation Start Position to Calculation End Position is odd bytes. The ASCII data contains data other than ASCII (30h to 39h, 41h to 46h) data. 	Change the Calculation Start Position and Calculation End Position settings and the transmission data from the external device.
	1	Received Data Size Error	The received data size of the data does not match that of the specified receive command.	Check the transmission data from the external device.
	2	Registering Constant Data Error	The Constant (Character) or Constant (Hexadecimal) set up with the receive command does not match the receive data.	Check the transmission data from the external device.
	3	Registering Constant Error	No data matches the registered setting of the Registering Constant data.	Check the transmission data from the external device.
	4	Device Data Conversion Error	<ul style="list-style-type: none"> When data type is Device Address and Conversion Type is ASCII to Hexadecimal, a code other than 0 to 9 or A to F receives as data. When data type is Device Address and Conversion Type is ASCII to Decimal, a code other than 0 to 9 receives as data. Or the converted data exceeds 65535. 	Check the transmission data from the external device.
	5	Device Data Reference Device Error	When data type is Device Address and the Use Reference Device Address check box is selected, the device address in which the value of the Reference Device Address is stored as offset has exceeded the valid range. Or the number of words setting of the device address is beyond the range of device address for which data is stored.	Change the value of the Reference Device Address or the change the number of words.
6	Terminal Code of Receive Data Miscompare Error	In the receive command whose trigger condition is being satisfied, the start code matches while the terminal code does not match.	Check the transmission data from the external device.	
7	Device Storing Error	<p>During the reception process of multiple received commands, the total number of words of the next device address to be stored exceeds 800 words.</p> <ul style="list-style-type: none"> The stored device addresses that Type is Device Address. Index device address whose Type is Registering Constant (Character) or Registering Constant (Hexadecimal). 	Change settings so that the total number of device addresses used for storage at one time does not exceed 800 words. Change settings so that the trigger conditions for several receive commands are not satisfied, to reduce the number of receive commands that are processed.	
8 to 13	Reserved			

Address number	Bit	Function	Cause	Solution
+0	14	Receiving Time Out	1 frame of data is not received even when the preset Receiving Time Out duration has passed after the Trigger Condition is satisfied.	Check the transmission data from the external device.
	15	Receiving Character Time Out	While 1 frame of data is being received, even after the time out period—the specified time interval between receiving data (from when 1 frame of data has been received to when the next frame of data starts to be received)—has elapsed, the next frame of data does not start to be received.	Check the transmission data from the external device.

Address number	Function	Description
+1	Receive Data Size (bytes)	Stores the size of receive data.

 After the Receiving Character Time Out duration has elapsed, the receive data is analyzed. When the Error Information bit changes to 1, data is not received, and the Receiving Completed Device Address does not change to 1.

Transmission Wait (x100 msec):

Specify the wait time (0 to 255) from when the trigger condition is satisfied to when the data is transmitted. This can be configured only when **TXD** is selected as **Type** on the Command Settings dialog box. After the Transmission Wait duration has elapsed from when the trigger condition is satisfied, transmission starts.

Example: When **Trigger Type** in **Trigger Condition** is **Rising-edge** and **Device Address** is LM100

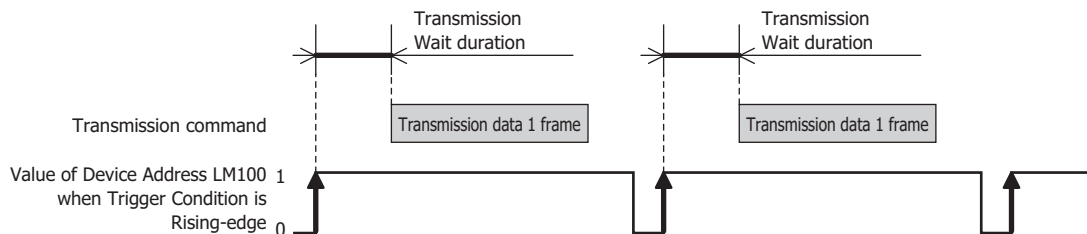

Receiving Time Out (x100 msec):

Set the time out (0 to 255) from when the trigger condition is satisfied to when 1 frame of data has been received. A frame refers to a data string from the beginning to the end of a command. If the Receiving Character Time Out is set to 0, it is not monitored.

This can be configured only when **RXD** is selected as **Type**, and **While ON**, **While OFF**, or **While satisfying the condition** is selected in **Trigger Type**.

When 1 frame of data could not be received, even though the Receiving Time Out duration has elapsed from when the trigger condition is satisfied, the value of the Receiving Time Out of the Status Device Address (address number+0, bit 14) changes to 1. When the Receiving Time Out duration elapses, the value of the Completed Device Address does not change to 1, and the receive data is not processed.

When the trigger condition again changes from not satisfied to satisfied, the value of the Receiving Time Out of the Status Device Address (address number+0, bit 14) changes to 0. When the value of this bit is not 0, the Receiving Time Out cannot be detected.

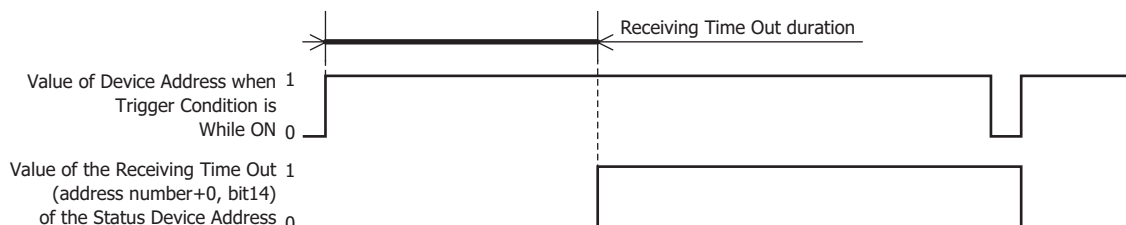

Example: When **Trigger Type** in **Trigger Condition** is **While ON**, **Device Address** is LM100, **Status Device Address** is LDR110, **Completed Device Address** is LM101 and the **Not Clear Completed Device Address automatically** check box is not selected

When **Status Device Address** is LDR110, error information and time out information is stored in each bit of LDR110.

When receiving of 1 frame of data is completed before the Receiving Time Out duration has elapsed from when the trigger condition is satisfied, the value of the Receiving Time Out of the Status Device Address LDR110 (address number+0, bit 14) remains 0.

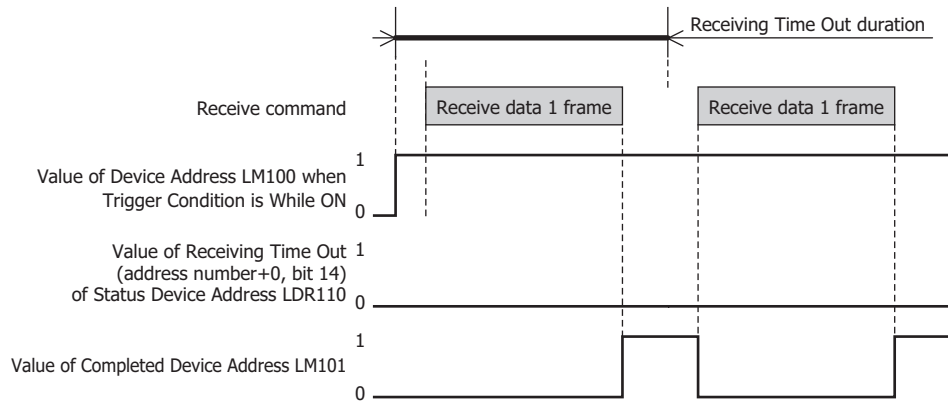

When receiving of 1 frame of data could not be completed by the time the Receiving Time Out duration elapses from when the trigger condition is satisfied, the value of the Receiving Time Out of the Status Device Address LDR110 (address number+0, bit 14) changes to 1.

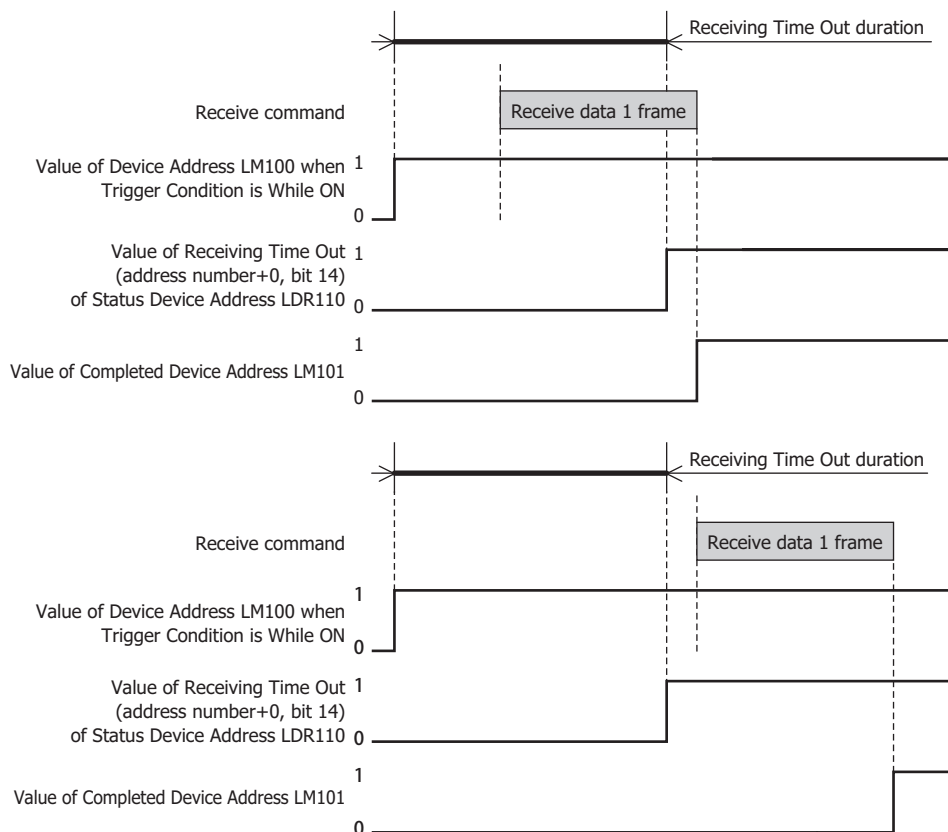

Comment : Enter a comment for a command. The maximum number is 40 characters.

■ Data List

Shows a list of command data. Double clicking the line displays the Data Settings dialog box.

For details, refer to "Data Settings Dialog Box" on page 3-48. The maximum data size that can be configured is 1500 bytes per command.

The content displayed in lists varies based on the type of command.

Constant (Character):

Displays the specified data enclosed in " ".

"Data"

Example: "1234"

Constant (Hexadecimal):

Displays the specified data with each byte value enclosed in ' '.

'Data of the first byte' 'Data of the second byte' 'Data of the third byte' 'Data of the fourth byte'

Example: '31' '32' '33' '34'

Device Address:

Displays the specified data enclosed by < >, in the following order.

<Device Address Conversion Type Number of bytes Variable Words Storage Method of data>

Device Address: Displays the device address enclosed by []

When the **Use Reference Device Address** check box is selected, displays as
OFFSET([Device Address], [Reference Device Address])

Number of bytes: Displays the number of bytes of the transmitted or received data.

Conversion Type: Display the conversion methods for values of device addresses as follows.
The Conversion Type varies based on the type selected in **Type** on the
Command Settings dialog box.

TXD: HEX-A: **Hexadecimal to ASCII** is selected

DEC-A: **Decimal to ASCII** is selected

N: **No conversion** is selected

RXD: A-DEC: **ASCII to Decimal** is selected

A-HEX: **ASCII to Hexadecimal** is selected

N: **No conversion** is selected

Variable: When the **Variable** check box is selected, variables are displayed as follows.

V00: **NULL(00h)** is selected for transmission command

V [Device Address]: **Device Address** is selected for transmission command

V: In the case of receive command

Words: Displays the number of word devices for transmitting or receiving data.

Storage Method of data: Displays the handling method for value of read device address as follows.

U: **from Upper byte** is selected

L: **from Lower byte** is selected

Example: <OFFSET([LDR0100], [LDR0300]) N 2V[LDR0200] 2 U>

Registering Constant (Character):

Displays the specified data enclosed in << >>.

<<Index No. of No. 1: Data of No. 1 Index No. of No. 2: Data of No. 2 ... Index No. of No. N: Data of No. N Index Device Address>> (N = 1 to 100)

Data: Displays the data enclosed by " "

Index Device Address: Displays the device address enclosed by []

Example: <<1:"123" 2 : "456" 3 : "789" [LDR0100]>>

Registering Constant (Hexadecimal):

Displays the specified data enclosed in << >>.

<<Index No. of No. 1: Data of No. 1 Index No. of No. 2: Data of No. 2 ... Index No. of No. N: Data of No. N Index Device Address>> (N = 1 to 100)

Data: Displays the data enclosed by ' '

Index Device Address: Displays the device address enclosed by []

Example: <<1:'313233' 2:'343536' 3 : '373839' [LDR0100]>>

BCC: Displays the specified data enclosed in BCC ().
 BCC(Calculation Start Position Calculation End Position Calculation Type Conversion Type Number of bytes)
 Calculation Start Position: Displays the data position where the BCC calculation starts.
 Calculation End Position: Displays the data position where the BCC calculation ends.
 Calculation Type: Display the methods to calculate the data between the Calculation Start Position and Calculation End Position as follows.
 XOR: **XOR** is selected
 ADD: **ADD** is selected
 ADD2: **ADD (2's Complement)** is selected
 LCR: **Modbus ASCII(LCR)** is selected
 CRC: **Modbus RTU(CRC)** is selected
 Conversion Type: Display the conversion methods for values of device addresses as follows.
 HEX-A: **Hexadecimal to ASCII** is selected
 N: **No conversion** is selected
 Number of bytes: Displays the number of bytes of the transmitted or received data.

Example: BCC(2 1 XOR N 2)

Skip: Displays the specified data enclosed in Skip().

Skip(Number of bytes)

Example: Skip(2)

Add: Adds a data to **Data List**.

Click this button, displays the Data Settings dialog box. For details, refer to "Data Settings Dialog Box" on page 3-48.

Edit: Changes the selected data in **Data List**.

Click this button, displays the Data Settings dialog box. For details, refer to "Data Settings Dialog Box" on page 3-48.

Copy: Copies the selected data in **Data List**.

Click this button to add a copy of the selected data to the end of **Data List**.

Up: Shifts the selected data upward in the list.

Down: Shifts the selected data downward in the list.

Delete: Deletes the selected data from **Data List**.

■ **Command Size (byte)**

Displays the data size of a configured command.

The calculation method for command size varies based on the type selected in **Type** on the Command Settings dialog box.

TXD: Number of bytes for Constant Data + Number of bytes for a data of Registering Constant + Number of bytes of BCC + Number of bytes of Device Address x Words of Device Address

RXD: Number of bytes for Constant Data + Number of bytes for a data of Registering Constant + Number of bytes of BCC + Number of bytes of Skip + Number of bytes of Device Address x Words of Device Address

■ **Start Code, Terminal Code**

Display the start code and the terminal code in hexadecimal notation.

■ **Expand/Contract Data List**

Shows or hides the **Type**, **Trigger Condition** and **Detail**. By hiding **Type**, **Trigger Condition** and **Detail**, the number of the data displayed in Data List will increase.

● Data Settings Dialog Box

Specify the transmitted or received data by a command.

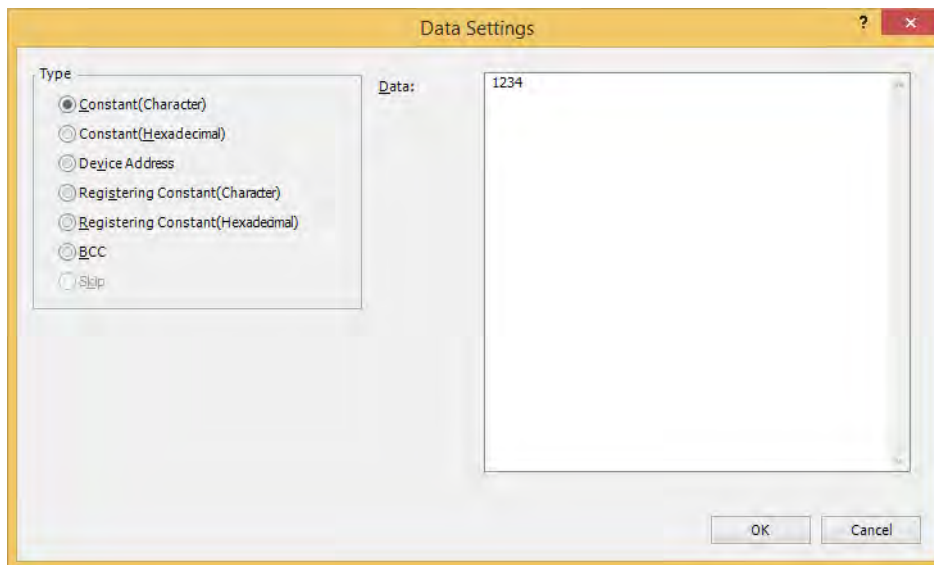

■ Type

Selects data types from the following items.

Constant (Character), Constant (Hexadecimal), Device Address, Registering Constant (Character), Registering Constant (Hexadecimal), BCC, Skip

Skip can only be configured when **RXD** is selected as **Type** on the Command Settings dialog box.

Setting item varies based on the selection in **Type** on the Command Settings dialog box.

When **TXD** or **Inching** is selected, refer to "Transmission (TXD) Command" on page 3-49.

When **RXD** is selected, refer to "Receive (RXD) Command" on page 3-62.

● Transmission (TXD) Command

Constant (Character)

The character data is sent without being converted.

This can be configured only when **TXD** or **Inching** is selected as **Type** on the Command Settings dialog box, and **Constant (Character)** is selected under **Type** on the Data Settings dialog box.

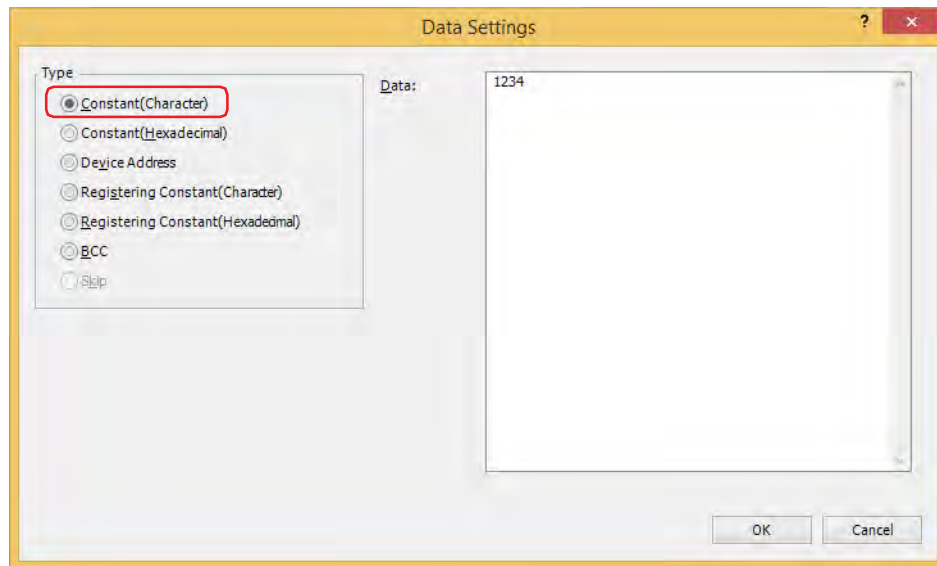

■ Data

Enter character data to be transmitted (1 to 1,500 bytes). The size of a single-byte character is one byte and that of a double-byte character is two bytes.

Example: Constant (Character) for transmission command data

Item	Setting
Data	1234

When the trigger condition is satisfied, the character data is transmitted in the following order.

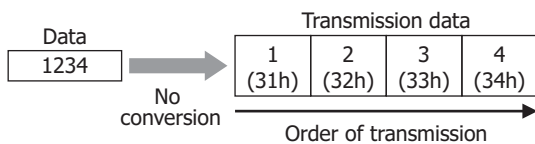

Constant (Hexadecimal)

The hexadecimal data is sent without being converted.

Use this setting to send a control code of ASCII data (00h to 1Fh).

This can be configured only when **TXD** or **Inching** is selected as **Type** on the Command Settings dialog box, and **Constant (Hexadecimal)** is selected under **Type** on the Data Settings dialog box.

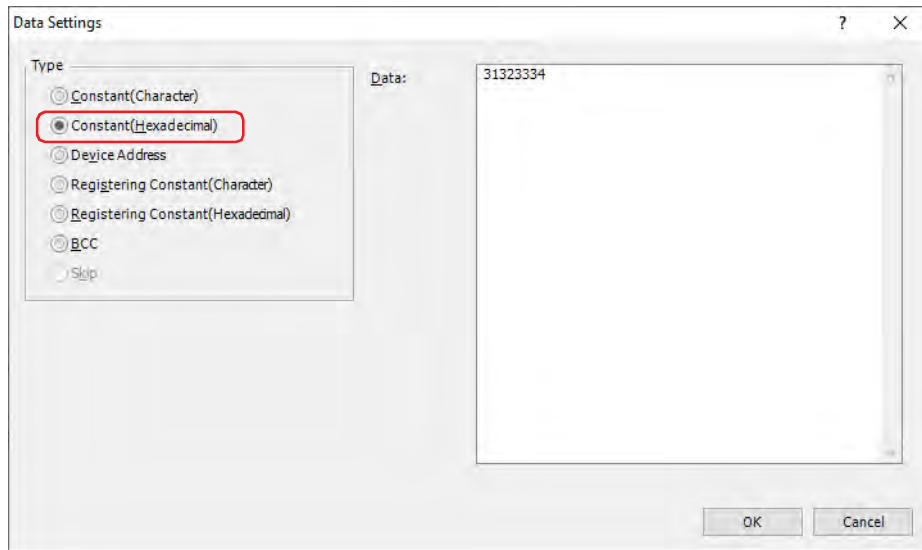

■ Data

Enter hexadecimal data to be transmitted (1 to 1,500 bytes).

Example: Constant (Hexadecimal) for transmission command data

Item	Setting
Data	1234

When the trigger condition is satisfied, 1234h is transmitted in the order 12h and 34h.

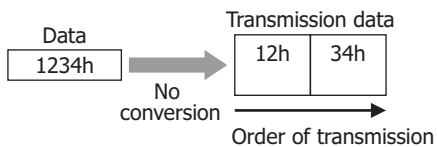

Device Address

The value of device address is either not converted or converted to ASCII and then sent as data with the specified size. This can be configured only when **TXD** or **Inching** is selected as **Type** on the Command Settings dialog box, and **Device Address** is selected under **Type** on the Data Settings dialog box.

■ Conversion Type:

Select the conversion rule for the value of device address from the following.

Hexadecimal to ASCII: Considers the value of device address as binary-coded hexadecimal number and converts it to ASCII data.

Decimal to ASCII: Considers the value of device address as binary-coded decimal number and converts it to ASCII data.

No conversion: No conversion is performed.



Displays the example of the selected **Conversion Type**.

■ Device Address

Specify the source word device for transmitted data. You can only specify an internal device.

Click to display the Tag Editor. For the device address configuration procedure, refer to Chapter 2 "5.1 Device Address Settings" on page 2-70.

■ Use Reference Device Address

To change the source word device for transmitted data according to values of device address, select this check box and specify a device address. You can only specify an internal device.

For details, refer to Chapter 2 "Indirect Read and Indirect Write Settings" on page 2-5.

Click to display the Tag Editor. For the device address configuration procedure, refer to Chapter 2 "5.1 Device Address Settings" on page 2-70.

■ Storage Method of data

Select the handling method for the value of read device address. This can be configured only when **No conversion** is selected under **Conversion Type**.

from Upper byte: Value of device addresses are read from the upper byte.

from Lower byte: Value of device addresses are read from the lower byte.

■ Number of bytes

Specify the number of bytes of transmitted data. The number of bytes that can be specified varies based on the setting under **Conversion Type**.

Hexadecimal to ASCII: 1 to 4

Decimal to ASCII: 1 to 5

No conversion: 1 to 2

■ **Words**

Specify the number of word devices (1 to 99) of transmitted data.

■ **Variable**

Select this check box to change the transmitted data size according to conditions. This can be configured only when **No conversion** is selected under **Conversion Type**. When the check box is not selected, the amount of data (bytes) transmitted is data (bytes) for Number of bytes x Words.

NULL(00h): Send the data from the start data of the value of device address up to 00 (hexadecimal). Data 00 will not be sent. This setting is effective for sending only the character data section of character data having 00 (hexadecimal) as the last data.

Device Address: Specify a word device to which a number of bytes is applied for transmitted data.

Click to display the Tag Editor. For the device address configuration procedure, refer to Chapter 2 "5.1 Device Address Settings" on page 2-70.

When the value of device address exceeds Number of bytes x Words, or when it is negative, the Device Data Variable Specification Error (address number+0, bit 6) of the Status Device Address changes to 1, and transmission does not occur.

Examples: Device address for transmission command data

Example 1

Item	Setting
Conversion Type	No conversion
Device Address	LDR100
Use Reference Device Address	OFF
Storage Method of data	from Upper byte
Number of bytes	1
Words	3
Variable	OFF

When the trigger condition is satisfied, the value of device address is read and data is transmitted in the following order.

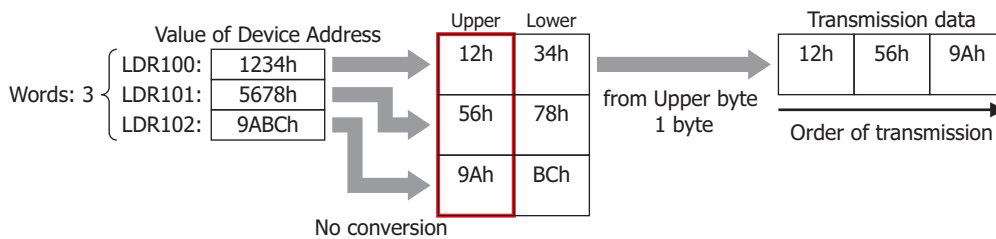

Example 2

Item	Setting
Conversion Type	No conversion
Device Address	LDR100
Use Reference Device Address	OFF
Storage Method of data	from Lower byte
Number of bytes	2
Words	3
Variable	OFF

When the trigger condition is satisfied, the value of device address is read and data is transmitted in the following order.

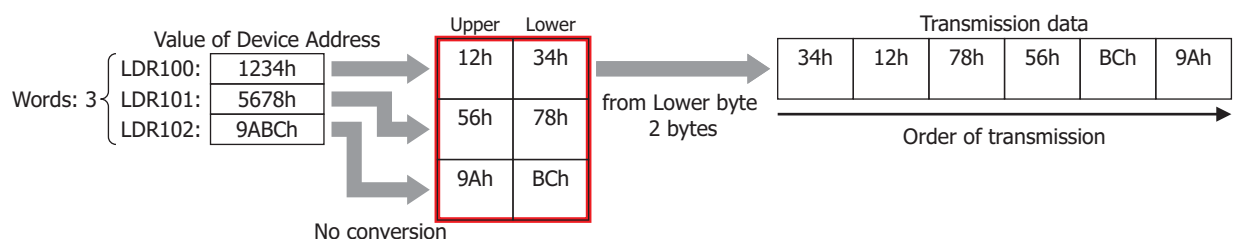

Example 3

Item	Setting
Conversion Type	Hexadecimal to ASCII
Device Address	LDR100
Use Reference Device Address	OFF
Number of bytes	2
Words	2
Variable	OFF

When the trigger condition is satisfied, the value of device address is read, and data is converted to ASCII and transmitted in the following order.

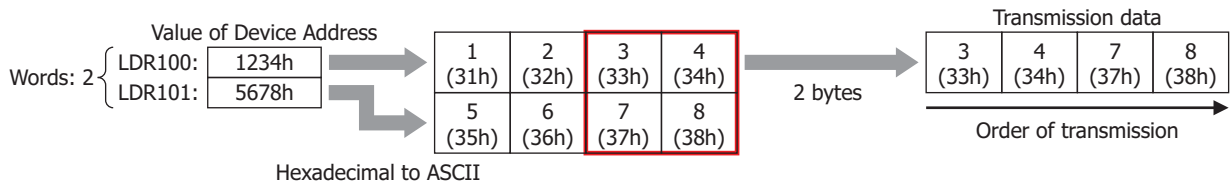
**Example 4**

Item	Setting
Conversion Type	Decimal to ASCII
Device Address	LDR100
Use Reference Device Address	OFF
Number of bytes	2
Words	2
Variable	OFF

When the trigger condition is satisfied, the value of device address is read, and data is converted to ASCII and transmitted in the following order.

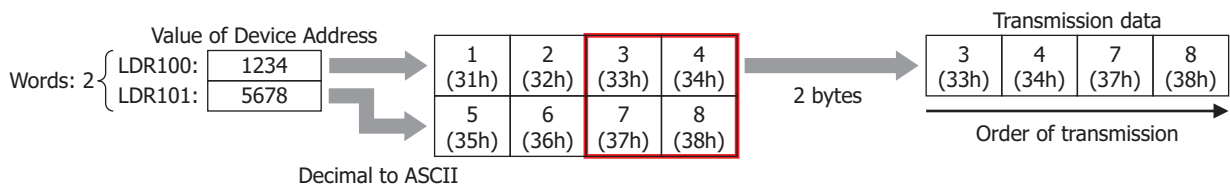
**Example 5**

Item	Setting
Conversion Type	No conversion
Device Address	LDR100
Use Reference Device Address	OFF
Storage Method of data	from Upper byte
Number of bytes	2
Words	2
Variable	ON, NULL(00h)

When the trigger condition is satisfied, the value of device address is read and data is transmitted in the following order.

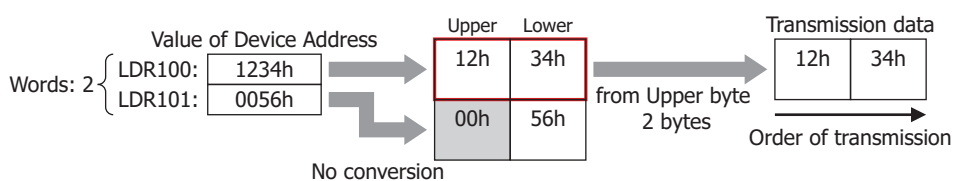

Example 6

Item	Setting
Conversion Type	No conversion
Device Address	LDR100
Use Reference Device Address	OFF
Storage Method of data	from Lower byte
Number of bytes	2
Words	2
Variable	ON, Device Address: LDR200

When the trigger condition is satisfied, the value of device address is read and data is transmitted in the following order.

When the LDR200 value is 3

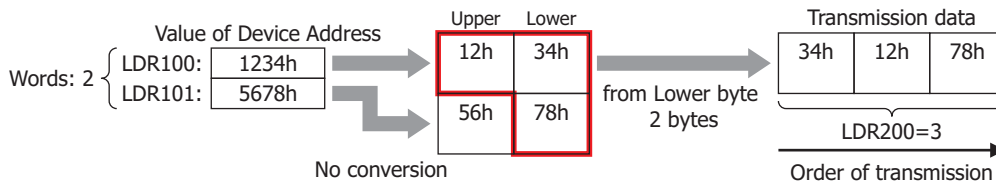

Example 7

Item	Setting
Conversion Type	No conversion
Device Address	LDR100
Use Reference Device Address	ON, Device Address: LDR200
Storage Method of data	from Upper byte
Words	2
Variable	OFF

When the trigger condition is satisfied, the value of device address is read and data is transmitted in the following order.

When the LDR200 value is 2

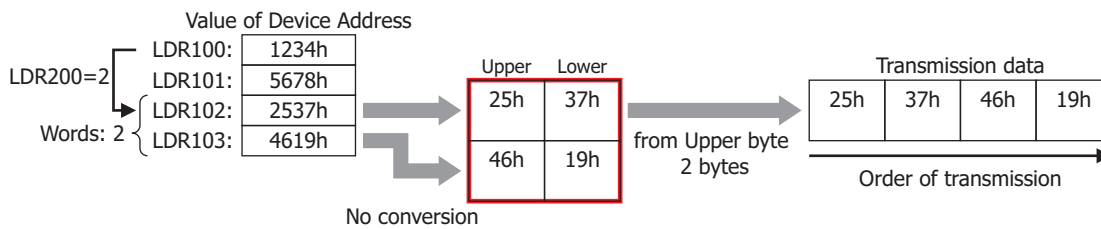

Registering Constant (Character)

From the registered character data, character data according to the value of device address is read and transmitted. This can be configured only when **TXD** or **Inching** is selected as **Type** on the Command Settings dialog box, and **Registering Constant (Character)** is selected under **Type** on the Data Settings dialog box.

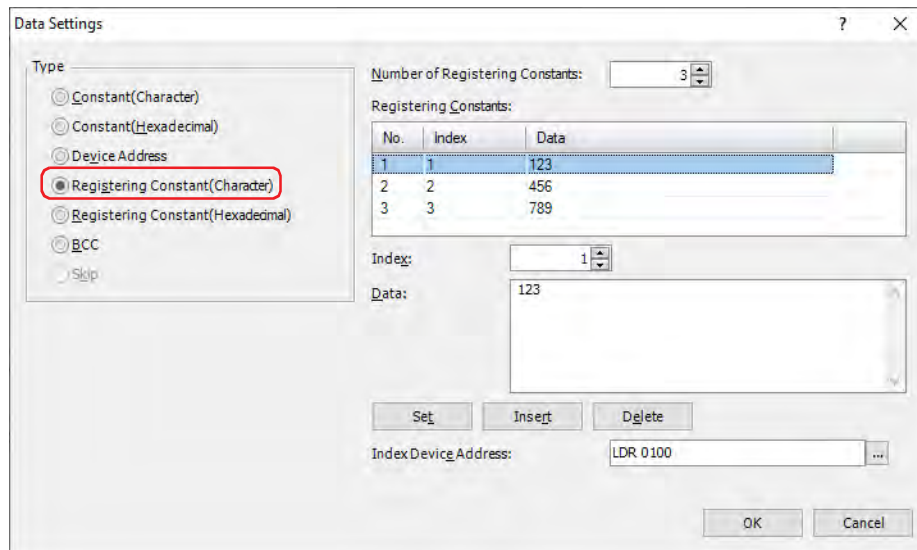

■ Number of Registering Constants

Specify the number of data of the registered character data (1 to 100).

■ Registering Constants

No.: Shows the ID No. (1 to 100) of the character data.

Index: Shows the Index No. of the character data.

Data: Shows the character data.

■ Index

Specify the Index No. (0 to 65535) of the character data.

■ Data

Enter the character data (1 to 1500 bytes) to be registered. The size of a single-byte character is one byte and that of a double-byte character is two bytes.

The character data of different size or the same data with a different number cannot be registered.

■ Set

Register the **Index** and **Data** settings to the list. When a number that is already registered is selected, it is overwritten with the new setting.

■ Insert

Insert a character data setting to the selected number in the list.

Click this button to insert the **Index** and **Data** setting. The settings at the insertion point shift down 1 line. Settings cannot be inserted when all numbers are already set.

■ Delete

Delete the selected settings from the list.

■ Index Device Address

Specify the source word device to serve as the Index No. You can only specify an internal device.

Click to display the Tag Editor. For the device address configuration procedure, refer to Chapter 2 "5.1 Device Address Settings" on page 2-70.

Example: Transmission command for Registering Constant (Character) data

Item	Setting
Number of Registering Constants	3
Registering Constants	Index No. 1: 123
	Index No. 2: 456
	Index No. 3: 789
Index Device Address	LDR100

When the trigger condition is satisfied, the data of the Index No. according to the value of device address is transmitted.

When the LDR100 value is 2

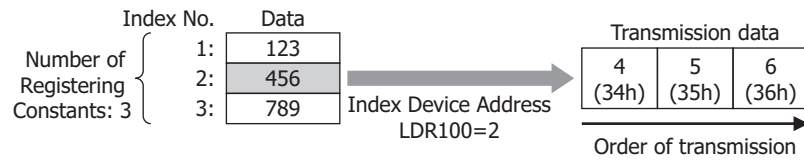

Registering Constant (Hexadecimal)

From the registered hexadecimal data, the hexadecimal data according to the value of device address is read and transmitted.

This can be configured only when **TXD** or **Inching** is selected as **Type** on the Command Settings dialog box, and **Registering Constant (Hexadecimal)** is selected under **Type** on the Data Settings dialog box.

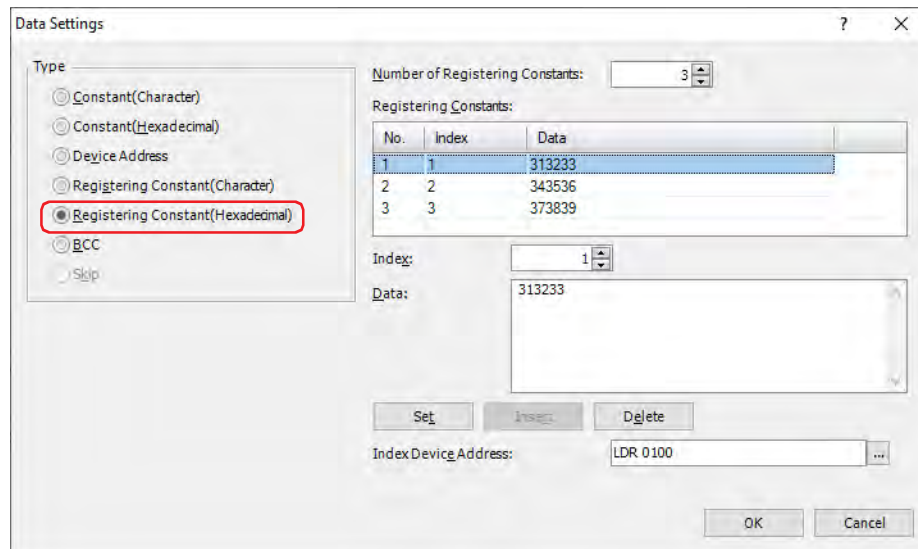

■ Number of Registering Constants

Specify the number of data of the registered hexadecimal data (1 to 100).

■ Registering Constants

No.: Shows the ID No. (1 to 100) of the hexadecimal data.

Index: Shows the Index No. of the hexadecimal data.

Data: Shows the hexadecimal data.

■ Index

Specify the Index No. (0 to 65535) of the hexadecimal data.

■ Data

Enter the hexadecimal data (1 to 1500 bytes) to be registered.

The data of different size or the same data with a different number cannot be registered.

■ Set

Register the **Index** and **Data** settings to the list. When a number that is already registered is selected, it is overwritten with the new setting.

■ Insert

Insert a hexadecimal data setting to the selected number in the list.

Click this button to insert the **Index** and **Data** setting. The settings at the insertion point shift down one line. Settings cannot be inserted when all numbers are already set.

■ Delete

Delete the selected settings from the list.

■ Index Device Address

Specify the source word device to serve as the Index No. You can only specify an internal device.

Click to display the Tag Editor. For the device address configuration procedure, refer to Chapter 2 "5.1 Device Address Settings" on page 2-70.

Example: Transmission command for Registering Constant (Hexadecimal) data

Item	Setting
Number of Registering Constants	3
Registering Constants	Index No. 1: 1234
	Index No. 2: 5678
	Index No. 3: 2537
Index Device Address	LDR100

When the trigger condition is satisfied, the data of the Index No. according to the value of device address is transmitted.

When the LDR100 value is 3

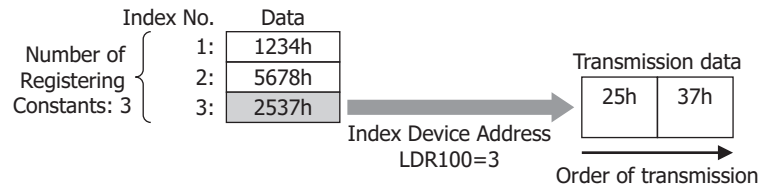

BCC (Block Check Code)

A BCC for the transmission data is automatically calculated and appended to the transmission data at an arbitrary position and transmitted.

This can be configured only when **TXD** or **Inching** is selected as **Type** on the Command Settings dialog box, and **BCC** is selected under **Type** on the Data Settings dialog box.

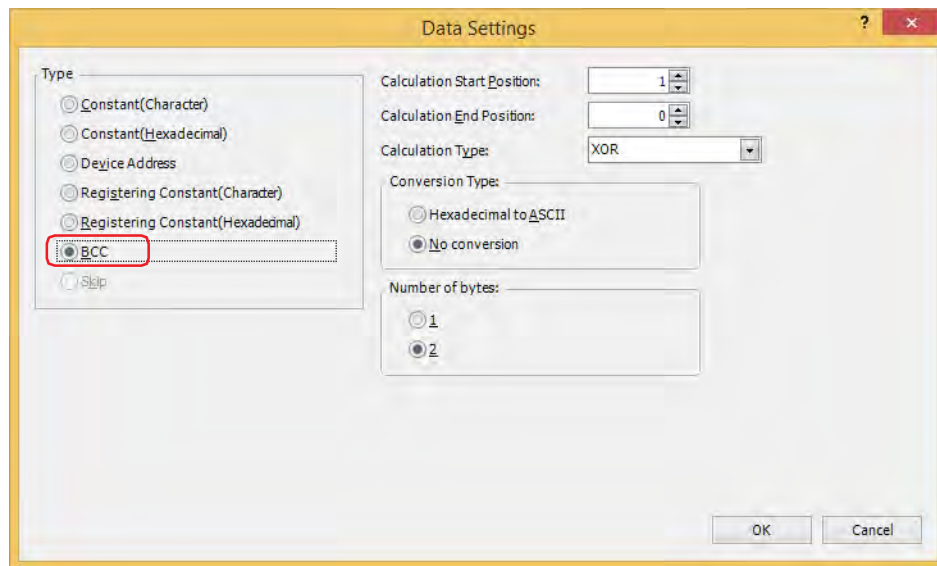

■ Calculation Start Position

Specify the position of transmission data at which BCC calculation starts (1 to 15). The position is counted backwards, with the first position of the transmission data taken as 1.

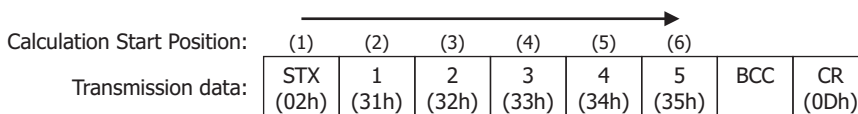

■ Calculation End Position

Specify the position of transmission data at which BCC calculation ends (0 to 15). The position is counted forwards, with the data position before the BCC taken as 0.

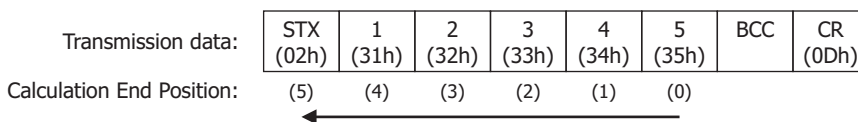

■ Calculation Type

Select the method to calculate the data between the Calculation Start Position and Calculation End Position.

XOR: Calculates the data with exclusive logical add.

ADD: Calculates the data using addition.

ADD (2's Complement): Calculates the data using addition, inverts the bit and adds one.

Modbus ASCII (LCR): Calculation is performed according to the following procedure. Conversion Type: Hexadecimal to ASCII, Number of bytes: 2

1. Convert the ASCII characters between Calculation Start Position and Calculation End Position into 1-byte hexadecimal data for each set of two characters.
Example: 37h, 35h→75h
2. Calculate the sum of the data obtained in step 1.
3. Invert the bit of the result of step 2 and add one. (2's complement)
4. Convert the lower one byte data of the result of step 3 into ASCII characters.
Example: 75h→37h, 35h

Modbus RTU (CRC): CRC-16 (Generating polynomial: $x^{16}+x^{15}+x^2+1$) is calculated according to the following procedure. Conversion Type: No conversion, Number of bytes: 2

1. Obtain an exclusive OR (XOR) of 1 byte data at Calculation Start Position and FFFFh.
2. If the least significant bit of the result of step 1 is 0, shift to the right by one bit. If the bit is 1, shift to the right by 1 bit and obtain XOR of the result and the value (A001h).
3. Repeat step 2 to shift 8 times.
4. Obtain XOR of the next one byte of data and the result of step 3.
5. Repeat steps 2 through 4 until the data at Calculation End Position is processed.
6. Send the result of step 5 in the order of the lower byte and upper byte.

Example: 1234h→34h, 12h

Conversion Type

After calculating the data using the specified calculation type, select the type of conversion for the data from the following.

Hexadecimal to ASCII : Considers the data as binary-coded hexadecimal number and converts it to ASCII data.

No conversion: No conversion is performed.

Number of bytes

After converting according to the specified conversion type, select **1** or **2** for the number of bytes for transmission data.

Example: BCC for transmission command data

This example describes the case of transmitting the BCC calculation result from the following transmission data as BCC data.

STX (02h)	1 (31h)	2 (32h)	3 (33h)	4 (34h)	5 (35h)	BCC	CR (0Dh)
--------------	------------	------------	------------	------------	------------	-----	-------------

• Calculation Start Position and Calculation End Position

When Calculation Start Position is 2 and Calculation End Position is 1: Calculates the range **1234**.

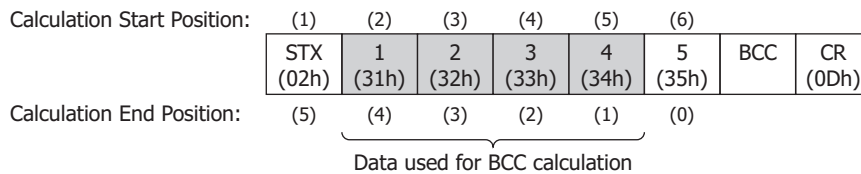

• Calculation Type

- XOR: $31h \wedge 32h \wedge 33h \wedge 34h = 04h$
- ADD: $31h + 32h + 33h + 34h = CAh$
- ADD (2's Complement): Inverts the bit of $CAh + 1 = 36h$
- Modbus ASCII (LCR): $100h - (12h + 34h) = BAh$
- Modbus RTU (CRC): $BA30h \rightarrow BAh, 30h$

• Conversion Type

When the BCC calculation result is **0004h**, the converted data is as follows.

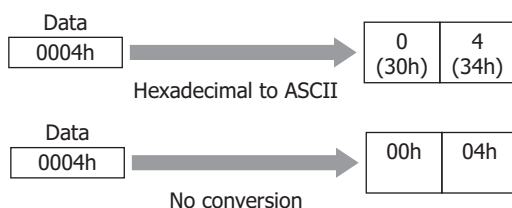

- Bytes and BCC data

When the converted data is **3034h**, the data appended to the transmission data is as follows.

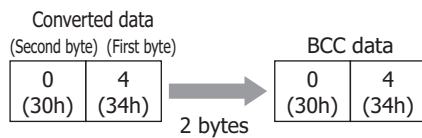
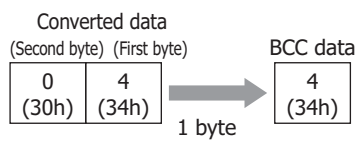

- When Calculation Type is **Modbus ASCII (LCR)**

When the BCC calculation result is **4241h** after **Hexadecimal to ASCII** conversion the resulting two bytes of data is appended to the transmission data.

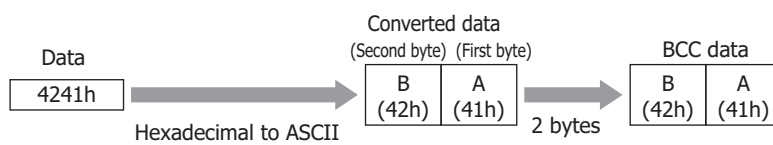

- When Calculation Type is **Modbus RTU (CRC)**

When the BCC calculation result is **BA30h** with no conversion the two bytes of data is appended to the transmission data.

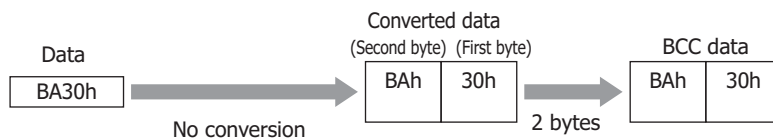

● Receive (RXD) Command

Constant (Character)

The received data is considered as character data and compared with the data specified without being converted. This can be configured only when **RXD** is selected as **Type** on the Command Settings dialog box, and **Constant (Character)** is selected under **Type** on the Data Settings dialog box.

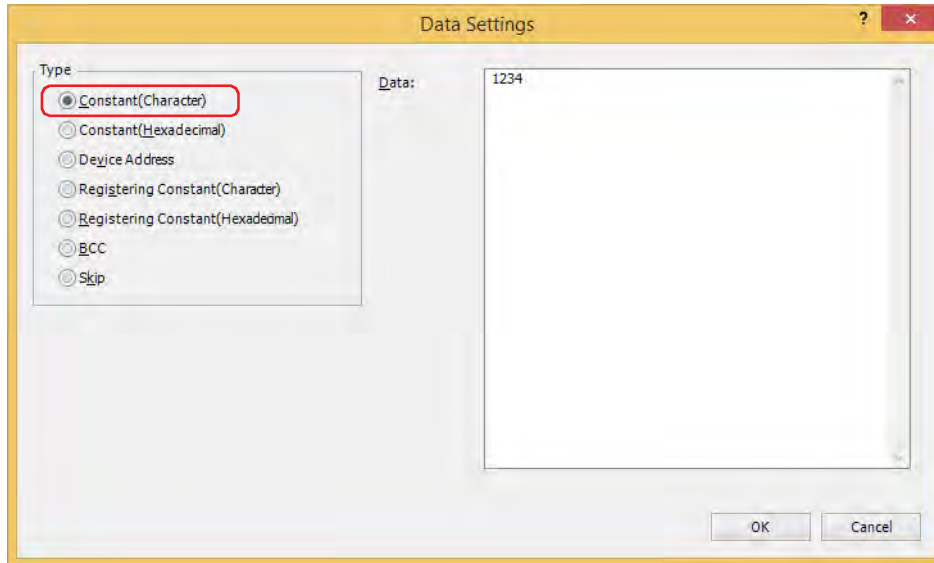

■ Data

Enter character data designated to be received (1 to 1,500 bytes). The size of a single-byte character is one byte and that of a double-byte character is two bytes.



When a Constant (Character) is set at the beginning of a command, the first one byte is recognized as the start code. When a Constant (Character) is set at the end of a command, the last one byte is recognized as the terminal code.

For details, refer to "Start Code and Terminal Code" on page 3-78.

Example: Constant (Character) for receive command data

Item	Setting
Data	1234

When the trigger condition is satisfied, the received data is compared with the following data.

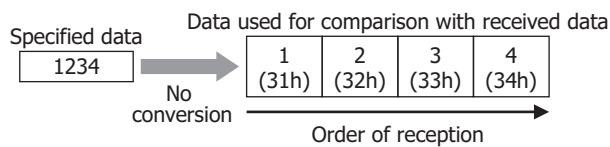

Constant (Hexadecimal)

The received data is considered as hexadecimal data and compared with the data specified without being converted. Use this setting to receive a control code of ASCII data (00h to 1Fh).

This can be configured only when **RXD** is selected as **Type** on the Command Settings dialog box, and **Constant (Hexadecimal)** is selected under **Type** on the Data Settings dialog box.

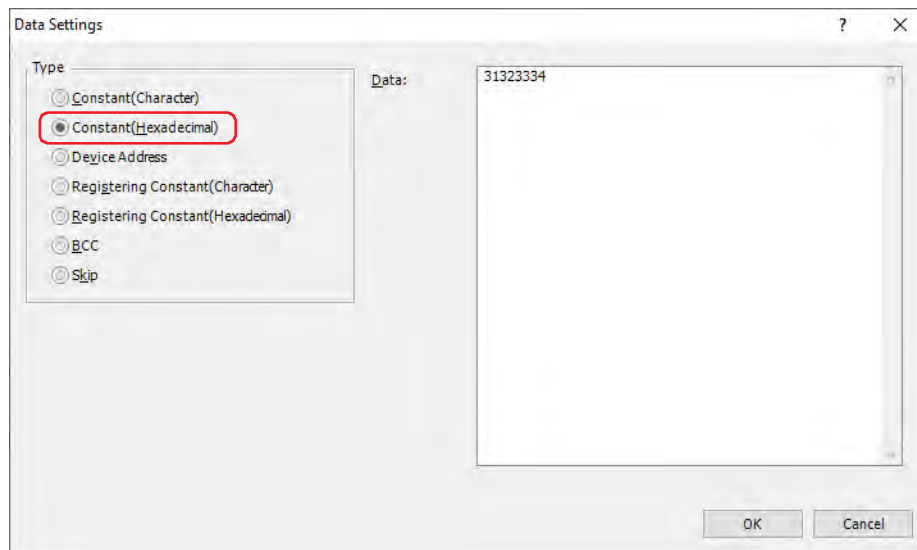

■ Data

Enter hexadecimal data designated to be received (1 to 1,500 bytes).



When a Constant (Character) is set at the beginning of a command, the first one byte is recognized as the start code. When a Constant (Character) is set at the end of a command, the last one byte is recognized as the terminal code.

For details, refer to "Start Code and Terminal Code" on page 3-78.

Example: Constant (Hexadecimal) for receive command data

Item	Setting
Data	1234

When the trigger condition is satisfied, the received data is compared with the following data.

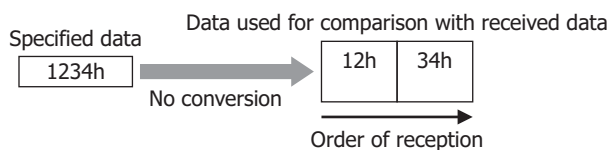

Device Address

From the received data, data of the specified size is unconverted, or converted to binary format, and stored in the device.

This can be configured only when **RXD** is selected as **Type** on the Command Settings dialog box, and **Device Address** is selected under **Type** on the Data Settings dialog box.

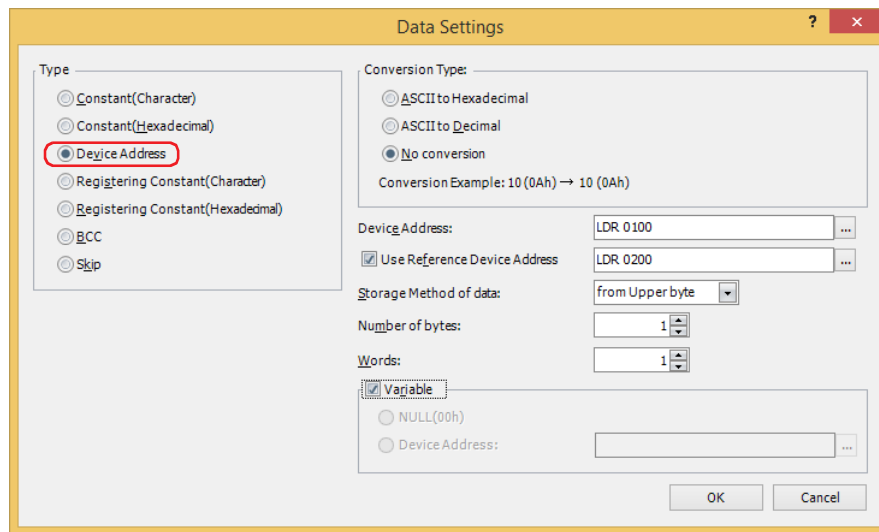

■ Conversion Type

Select conversion processing for the received data from the following.

- | | |
|-----------------------|---|
| ASCII to Hexadecimal: | Considers the received data as a hexadecimal number and converts it to binary data. |
| ASCII to Decimal: | Considers the received data as a decimal number and converts it to binary data. |
| No conversion: | No conversion is performed. |



Displays the example of the selected **Conversion Type**.

■ Device Address

Specify the word device for storing the received data. You can only specify an internal device.

Click to display the Tag Editor. For the device address configuration procedure, refer to Chapter 2 "5.1 Device Address Settings" on page 2-70.

■ Use Reference Device Address

To change the word device for storing the received data according to values of device addresses, select this check box and specify a device address. You can only specify an internal device.

Click to display the Tag Editor. For the device address configuration procedure, refer to Chapter 2 "5.1 Device Address Settings" on page 2-70.

■ Storage Method of data

Select the handling method for received data. This can be configured only when **No conversion** is selected under **Conversion Type**.

from Upper byte: Values of device addresses are stored from the upper byte.

from Lower byte: Values of device addresses are stored from the lower byte.

■ Number of bytes

Specify the received data size to be stored per word. The number of bytes to be specified varies based on **Conversion Type**.

- | | |
|-----------------------|--------|
| ASCII to Hexadecimal: | 1 to 4 |
| ASCII to Decimal: | 1 to 5 |
| No conversion: | 1 to 2 |

■ Words

Specify the number of word devices (1 to 250) for storing the received data.

Variable

Select this check box to store data up to either **Constant (Character)** data, or **Constant (Hexadecimal)** data from the beginning of the received data in a device. Stores data of the size specified under **Words**.

When the stored data is smaller than the size specified under **Words**, the values of all remaining devices will be stored 0.

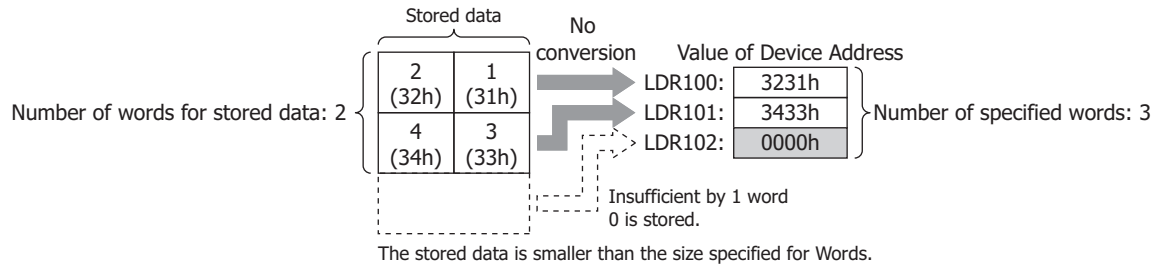

When the check box is not selected, the amount of data (bytes) stored is Number of bytes x Number of words.



When the **Variable** check box is selected, observe the following points.

- When data is set expect for the end of a command, set **Constant (Character)** data or **Constant (Hexadecimal)** data following **Device Address** data.
- When there is no data stored in the device address, all of the values of device addresses specified under **Words** will be 0.
- The maximum amount of the received data stored in the device address is Number of bytes x Number of words.

Examples: Device address for receive command data

Example 1

Item	Setting
Conversion Type	No conversion
Device Address	LDR100
Use Reference Device Address	OFF
Storage Method of data	from Upper byte
Number of bytes	1
Words	3
Variable	OFF

When the trigger condition is satisfied, the received data is stored in device addresses in the following order.

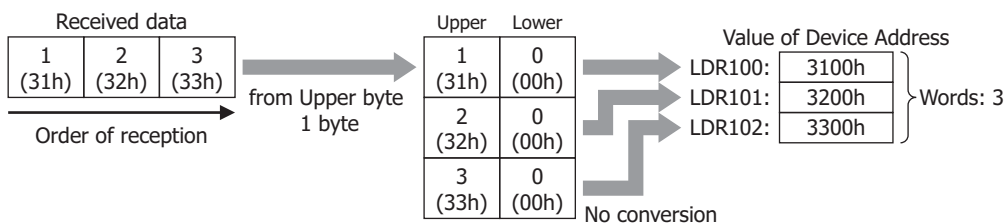

Example 2

Item	Setting
Conversion Type	No conversion
Device Address	LDR100
Use Reference Device Address	OFF
Storage Method of data	from Lower byte
Number of bytes	2
Words	2
Variable	OFF

When the trigger condition is satisfied, the received data is stored in device addresses in the following order.

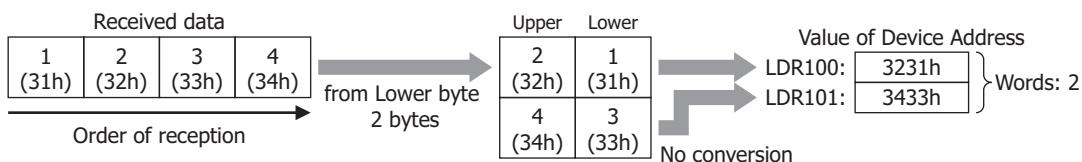

Example 3

Item	Setting
Conversion Type	ASCII to Hexadecimal
Device Address	LDR100
Use Reference Device Address	OFF
Number of bytes	2
Words	2
Variable	OFF

When the trigger condition is satisfied, the received data is stored in device addresses in the following order.

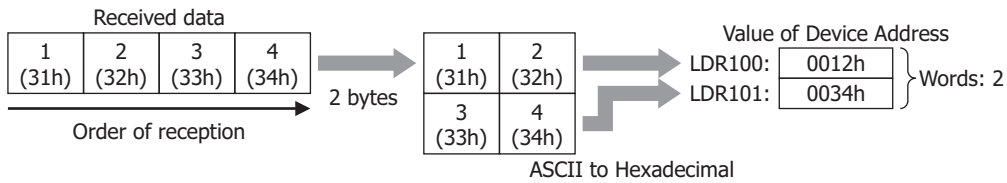

Example 4

Item	Setting
Conversion Type	ASCII to Decimal
Device Address	LDR100
Use Reference Device Address	OFF
Number of bytes	2
Words	2
Variable	OFF

When the trigger condition is satisfied, the received data is stored in device addresses in the following order.

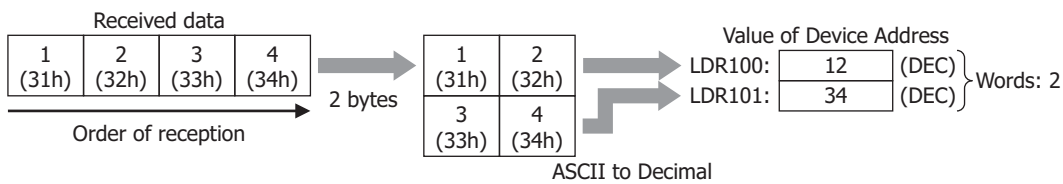

Example 5

Item	Setting
Conversion Type	No conversion
Device Address	LDR100
Use Reference Device Address	OFF
Storage Method of data	from Upper byte
Number of bytes	1
Words	3
Variable	ON

When the trigger condition is satisfied, the received data is stored in device addresses in the following order.

Data from the beginning of the received data to **Constant (Hexadecimal)** data is stored in the device address. **Constant (Hexadecimal)** data is not stored.

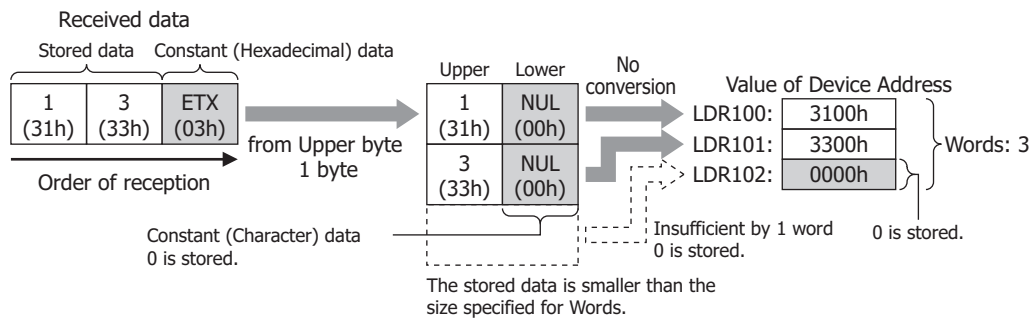

Example 6

Item	Setting
Conversion Type	No conversion
Device Address	LDR100
Use Reference Device Address	OFF
Storage Method of data	from Lower byte
Number of bytes	2
Words	3
Variable	ON

When the trigger condition is satisfied, the received data is stored in device addresses in the following order. Data from the beginning of the received data to **Constant (Hexadecimal)** data is stored in the device address. **Constant (Hexadecimal)** data is not stored.

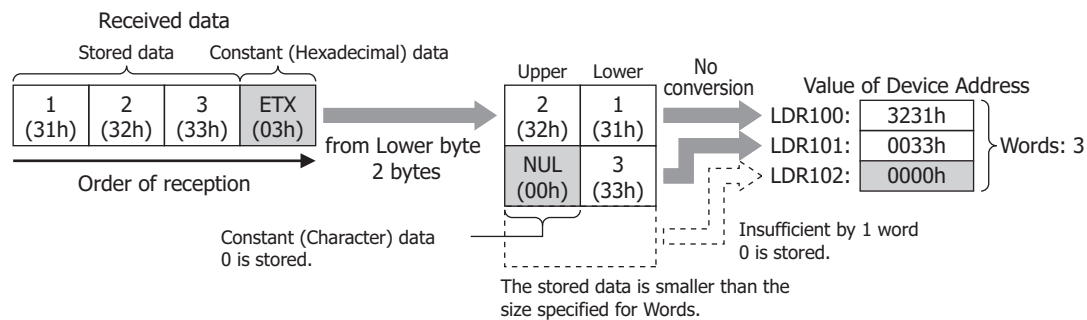
**Example 7**

Item	Setting
Conversion Type	ASCII to Hexadecimal
Device Address	LDR100
Use Reference Device Address	OFF
Number of bytes	1
Words	3
Variable	ON

When the trigger condition is satisfied, the received data is stored in device addresses in the following order. Data from the beginning of the received data to **Constant (Hexadecimal)** data is stored in the device address. **Constant (Hexadecimal)** data is not stored.

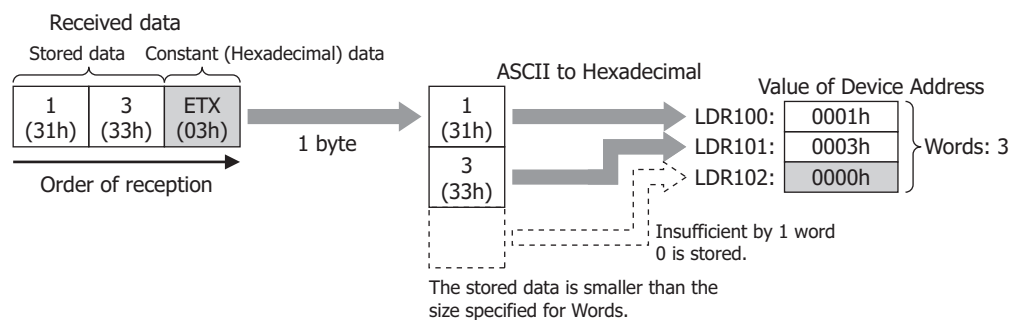

Example 8

Item	Setting
Conversion Type	ASCII to Decimal
Device Address	LDR100
Use Reference Device Address	OFF
Number of bytes	2
Words	3
Variable	ON

When the trigger condition is satisfied, the received data is stored in device addresses in the following order. Data from the beginning of the received data to **Constant (Hexadecimal)** data is stored in the device address. **Constant (Hexadecimal)** data is not stored.

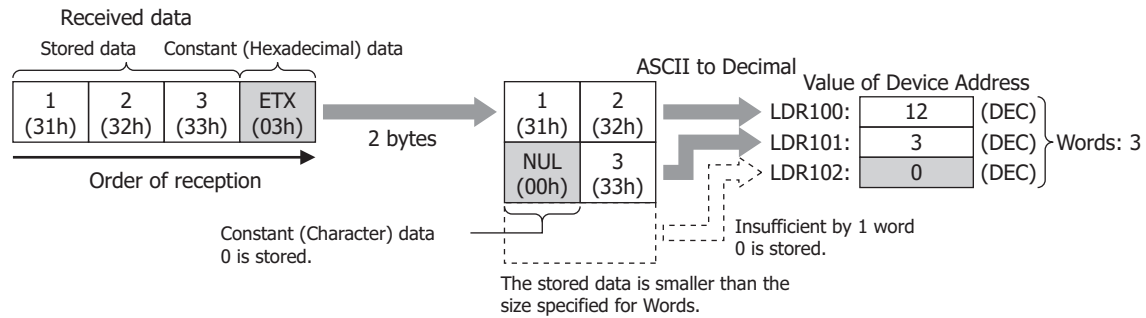

Example 9

Item	Setting
Conversion Type	No conversion
Device Address	LDR100
Use Reference Device Address	ON, Device Address: LDR200
Storage Method of data	from Upper byte
Words	2
Variable	OFF

When the trigger condition is satisfied, the received data is stored in device addresses in the following order. When the LDR200 value is 2

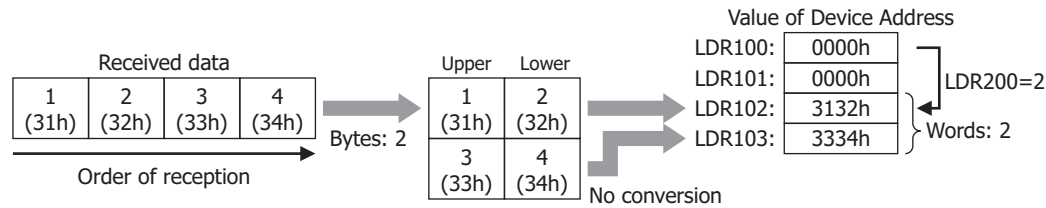

Registering Constant (Character)

The received data is compared with the registered character data and the number of the matching character data is stored in the device address.

This can be configured only when **RXD** is selected as **Type** on the Command Settings dialog box, and **Registering Constant (Character)** is selected under **Type** on the Data Settings dialog box.

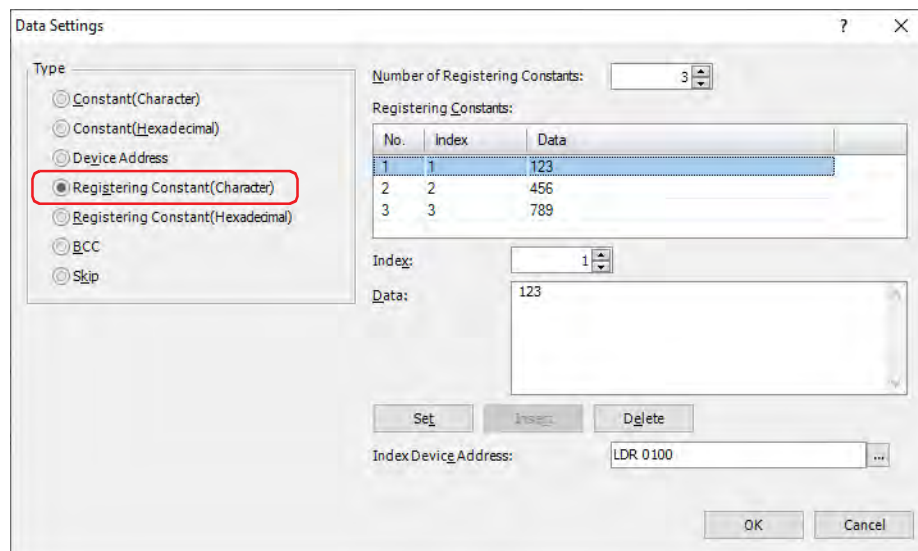

■ Number of Registering Constants

Specify the number of data of the registered character data (1 to 100).

■ Registering Constants

No.: Shows the ID No. (1 to 100) of the character data.

Index: Shows the Index No. of the character data.

Data: Shows the character data.

■ Index

Specify the Index No. (0 to 65535) of the character data.

■ Data

Enter the character data (1 to 1500 bytes) to be registered. The size of a single-byte character is one byte and that of a double-byte character is two bytes.

The character data of different size or the same data with a different number cannot be registered.

■ Set

Register the **Index** and **Data** settings to the list. When a number that is already registered is selected, it is overwritten with the new setting.

■ Insert

Insert a character data setting to the selected number in the list.

Click this button to insert the **Index** and **Data** setting. The settings at the insertion point shift down 1 line. Settings cannot be inserted when all numbers are already set.

■ Delete

Delete the selected settings from the list.

■ Index Device Address

Specify the word device for storing the Index No. of the character data matching the received data. You can only specify an internal device.

Click to display the Tag Editor. For the device address configuration procedure, refer to Chapter 2 "5.1 Device Address Settings" on page 2-70.

Example: Registering Constant (Character) for receive command data

Item	Setting
Number of Registering Constants	3
Registering Constants	Index No. 1: 123
	Index No. 2: 456
	Index No. 3: 789
Index Device Address	LDR100

When the trigger condition is satisfied, the received data is compared with the registered data, and the value of the Index No. 2 of the matching data is stored in Index Device Address LDR100.

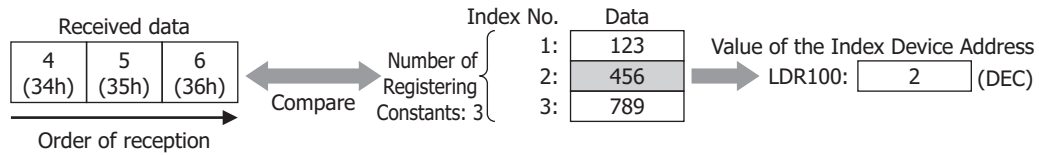

Registering Constant (Hexadecimal)

The received data is compared with the registered hexadecimal data and the number of the matching hexadecimal data is stored in the device address.

This can be configured only when **RXD** is selected as **Type** on the Command Settings dialog box, and **Registering Constant (Hexadecimal)** is selected under **Type** on the Data Settings dialog box.

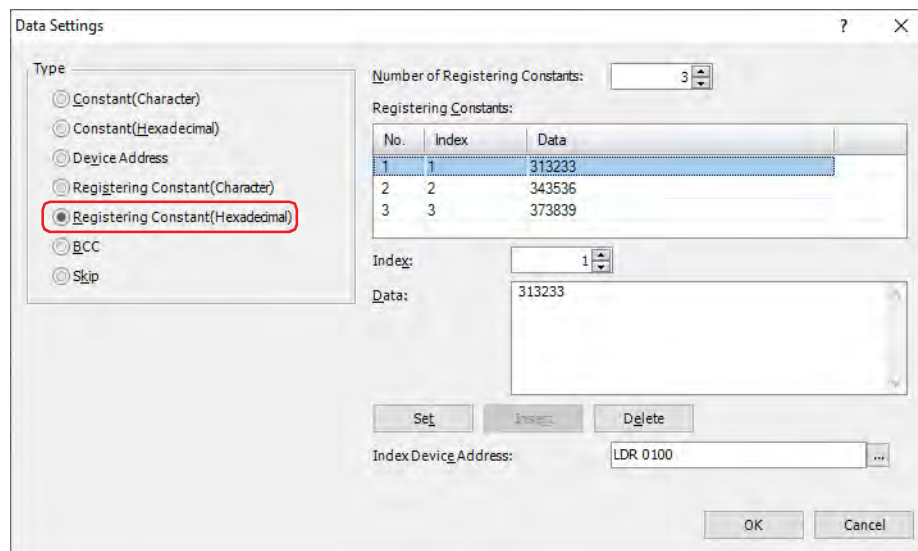

■ Number of Registering Constants

Specify the number of data of the registered hexadecimal data (1 to 100).

■ Registering Constants

No.: Shows the ID No. (1 to 100) of the hexadecimal data.

Index: Shows the Index No. of the hexadecimal data.

Data: Shows the hexadecimal data.

■ Index

Specify the Index No. (0 to 65535) of the hexadecimal data.

■ Data

Enter the hexadecimal data (1 to 1500 bytes) to be registered.

The hexadecimal data of different size or the same data with a different number cannot be registered.

■ Set

Register the **Index** and **Data** settings to the list. When a number that is already registered is selected, it is overwritten with the new setting.

■ Insert

Insert a hexadecimal data setting to the selected number in the list.

Click this button to insert the **Index** and **Data** setting. The settings at the insertion point shift down 1 line. Settings cannot be inserted when all numbers are already set.

■ Delete

Delete the selected settings from the list.

■ Index Device Address

Specify the word device for storing the Index No. of the hexadecimal data matching the received data. You can only specify an internal device.

Click to display the Tag Editor. For the device address configuration procedure, refer to Chapter 2 "5.1 Device Address Settings" on page 2-70.

Example: Registering Constant (Hexadecimal) for receive command data

Item	Setting
Number of Registering Constants	3
Registering Constants	Index No. 1: 1234
	Index No. 2: 5678
	Index No. 3: 2537
Index Device Address	LDR100

When the trigger condition is satisfied, the received data is compared with the registered hexadecimal data, and the value of the Index No. 2 of the matching data is stored in Index Device Address LDR100.

When the LDR100 value is 3

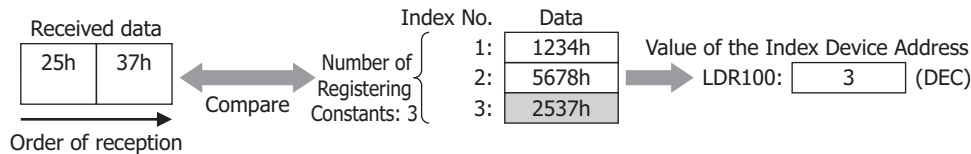

Example of applying Registering Constant

When the same device address is specified for the Index Device Address for **Registering Constant (Character)** data or **Registering Constant (Hexadecimal)** data and for **Use Reference Device Address** for **Device Address** data, the data storage destination for each unit of received data can be changed.

Data type	Item	Setting
Constant (Hexadecimal)	Data	02
Registering Constant (Character)	Number of Registering Constants	2
	Registering Constant	Index No. 1: AA Index No. 2: BB
	Index Device Address	LDR100
Device Address	Conversion Type	No conversion
	Device Address	LDR100
	Use Reference Device Address	ON, Device Address: LDR200
	Storage Method for Data	from Upper byte
	Bytes	2
	Words	2
	Variable	OFF
Constant (Hexadecimal)	Data	0D

When the following commands are received

STX (02h)	B (42h)	B (42h)	1 (31h)	2 (32h)	CR (0Dh)
--------------	------------	------------	------------	------------	-------------

- The first 1 byte is taken as the start code. **Constant (Hexadecimal)** data is not stored.

STX (02h)

- The received data is compared with the registered data, and the value of the Index No. 2 (Dec) of the matching data is stored in Index Device Address LDR100.

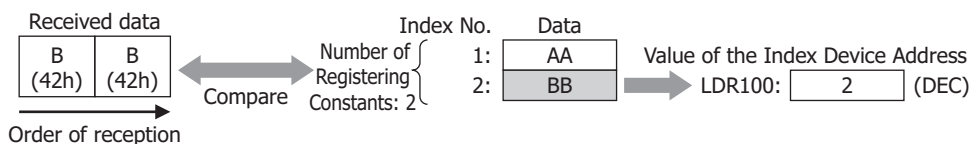

- Since the Indirect Device Address LDR100 of **Device Address** of the receive command data is 2 (Dec), the data is stored in the device address LDR202, which is offset by +2.

Value of Device Address

LDR200:	0000h
LDR201:	0000h
LDR202:	3132h

LDR100=2

- The last 1 byte is taken as the terminal code. **Constant (Hexadecimal)** data is not stored.

CR (0Dh)

BCC (Block Check Code)

The BCC comparison data is automatically calculated from the receive data and compared with the BCC part of the receive data.

This can be configured only when **RXD** is selected as **Type** on the Command Settings dialog box, and **BCC** is selected under **Type** on the Data Settings dialog box.

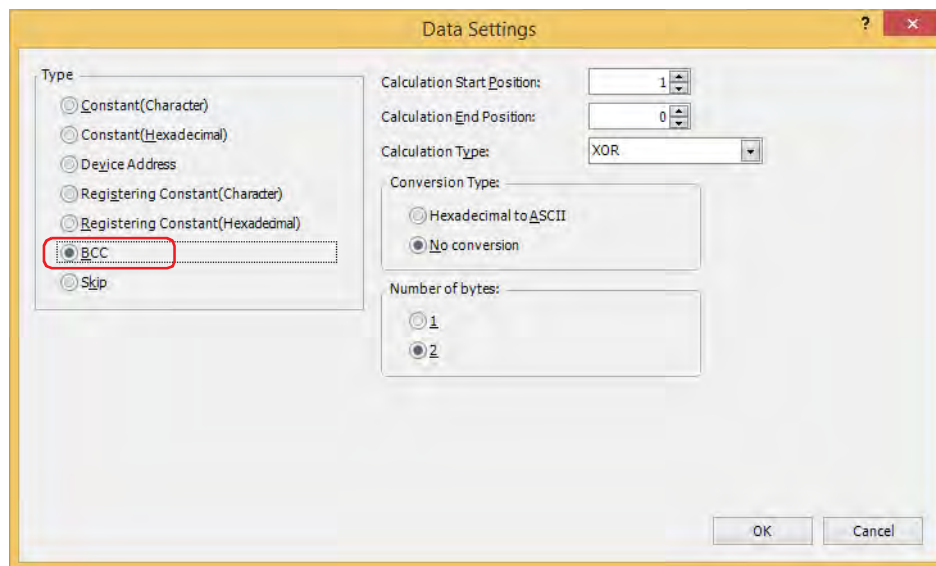

■ Calculation Start Position

Specify the position (1 to 15) in the receive data where BCC calculation starts. The position is counted backwards, with the first position of the receive data taken as 1.

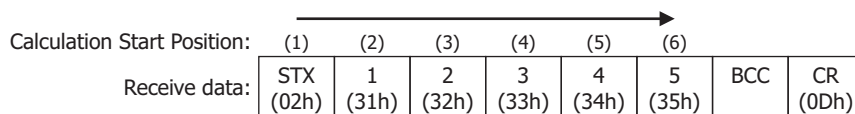

■ Calculation End Position

Specify the position (0 to 15) in the receive data where BCC calculation ends. The position is counted forwards, with the data position before the BCC taken as 0.

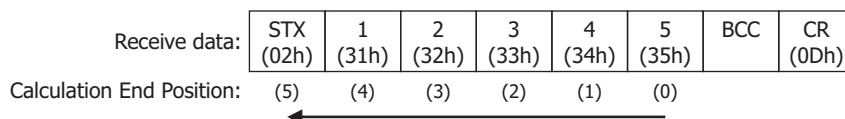

■ Calculation Type

Select the method to calculate the data between the Calculation Start Position and Calculation End Position.

XOR: Calculates the data with exclusive logical add.

ADD: Calculates the data using addition.

ADD (2's Complement): Calculates the data using addition, inverts the bit and adds one.

Modbus ASCII (LCR): Calculation is performed according to the following procedure. Conversion Type: Hexadecimal to ASCII, Number of bytes: 2

1. Convert the ASCII characters between Calculation Start Position and Calculation End Position into 1-byte hexadecimal data for each set of two characters.
Example: 37h, 35h → 75h
2. Calculate the sum of the data obtained in step 1.
3. Invert the bit of the result of step 2 and add one. (2's complement)
4. Convert the lower one byte data of the result of step 3 into ASCII characters.
Example: 75h → 37h, 35h

- Modbus RTU (CRC): CRC-16 (Generating polynomial: $x^{16}+x^{15}+x^2+1$) is calculated according to the following procedure. Conversion Type: No conversion, Number of bytes: 2
1. Obtain an exclusive OR (XOR) of 1 byte data at Calculation Start Position and FFFFh.
 2. If the least significant bit of the result of step 1 is 0, shift to the right by one bit. If the bit is 1, shift to the right by 1 bit and obtain XOR of the result and the value (A001h).
 3. Repeat step 2 to shift 8 times.
 4. Obtain XOR of the next one byte of data and the result of step 3.
 5. Repeat steps 2 through 4 until the data at Calculation End Position is processed.
 6. Compare the result of step 5 in the order of the lower byte and upper byte.
- Example: 1234h → 34h, 12h

■ Conversion Type

After calculating the data using the specified calculation type, select the type of conversion for the data from the following.

- Hexadecimal to ASCII: Considers the data as binary-coded hexadecimal number and converts it to ASCII data.
 No conversion: No conversion is performed.

■ Number of bytes

After converting according to the specified conversion type, select **1** or **2** for the number of bytes for comparison data.

Example: BCC for receive command data

This example describes the case of comparing the BCC calculation result for the following receive data with the BCC part of the receive data.

STX (02h)	1 (31h)	2 (32h)	3 (33h)	4 (34h)	5 (35h)	BCC	CR (0Dh)
--------------	------------	------------	------------	------------	------------	-----	-------------

• Calculation Start Position and Calculation End Position

When Calculation Start Position is 2 and Calculation End Position is 1: Calculates the range **1234**.

Calculation Start Position:	(1)	(2)	(3)	(4)	(5)	(6)		
	STX (02h)	1 (31h)	2 (32h)	3 (33h)	4 (34h)	5 (35h)	BCC	CR (0Dh)
Calculation End Position:	(5)	(4)	(3)	(2)	(1)	(0)		
		Data used for BCC calculation						

• Calculation Type

- XOR: $31h \wedge 32h \wedge 33h \wedge 34h = 04h$
 ADD: $31h + 32h + 33h + 34h = CAh$
 ADD (2's Complement): Inverts the bit of $CAh + 1 = 36h$
 Modbus ASCII (LCR): **BA** → 42h, 41h
 Modbus RTU (CRC): BA30h → BAh, 30h

• Conversion Type

When the BCC calculation result is **0004h**, the converted data is as follows.

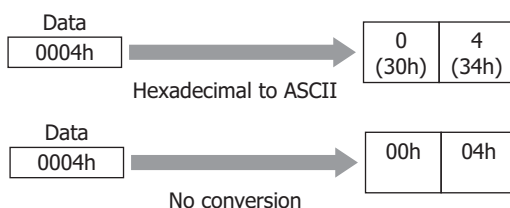

- Number of bytes and comparison data

When the converted data is **3034h**, the data used for comparison with the BCC part of the receive data is as follows.

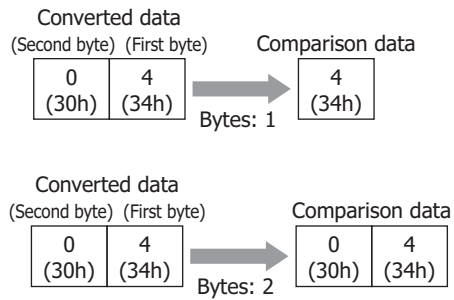

- BCC data comparison

The comparison data is compared with the BCC part of the receive data.

In the following receive data, when the comparison data is the 1-byte 34h, there is a match since the BCC part data is 34h.

When there is no match, the BCC Error (address number+0, bit 0) of the Status Device changes to 1.

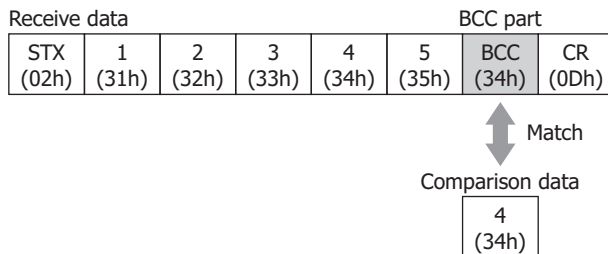

- When the calculation type is **Modbus ASCII (LCR)**

When the BCC calculation result is **4241h** after **Hexadecimal to ASCII** conversion the resulting two bytes of data is used for comparison with the BCC part of the receive data.

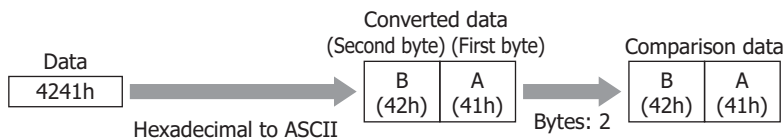

- When the calculation type is **Modbus RTU (CRC)**

When the BCC calculation result is **BA30h** with no conversion the two bytes of data is used for comparison with the BCC part of the receive data.

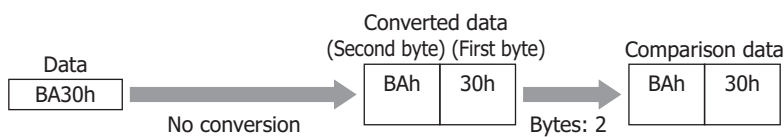

Skip

The data with the specified number of bytes in the receive data will be ignored.

This can be configured only when **RXD** is selected as **Type** on the Command Settings dialog box, and **Skip** is selected under **Type** on the Data Settings dialog box.

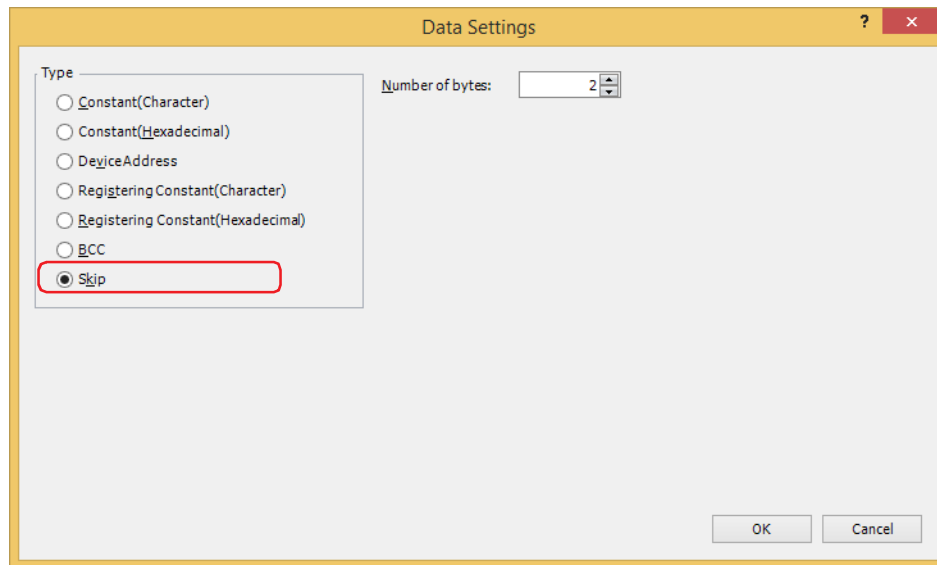

■ Number of bytes

Specify the number of bytes (1 to 249) of receive data to be ignored.

Example: Skip for receive command data

Item	Setting
Number of bytes	2

In the received four byte data (1 (31h), 2 (32h), 3 (33h), 4 (34h)), only the data for 3 (33h) and 4 (34h) is received and the two bytes of 1 (31h) and 2 (32h) are discarded.

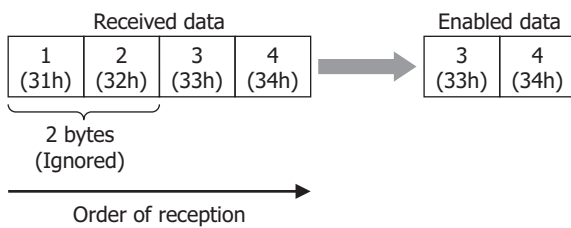

● Start Code and Terminal Code

A start code starts data reception and a terminal code judges the terminal of data reception. A start code and a terminal code can be configured for either **Constant (Character)** or **Constant (Hexadecimal)** settings for receive command. The first 1 byte of the constant is recognized as the start code and the last 1 byte as the terminal code.

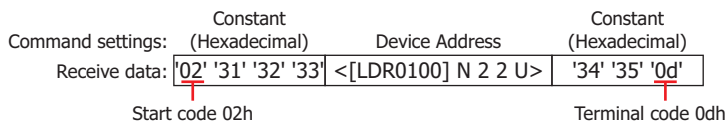

Code 00h to 7Fh can be set when **Data Length** under **Interface Settings** is 7 bits, and 00h to FFh when the data length is 8 bits. **Data Length** is configured under the **Communication Interface** tab on the Project Settings dialog box.

The procedure for terminal of data reception varies whether or not the receive data contains a start code and a terminal code, and whether the **Variable** check box for **Device Address** for receive command data is selected.

In the following description, **With Variable** indicates that the **Variable** check box for **Device Address** for receive command data is selected and **Without Variable** indicates that the **Variable** check box is not selected. Also, when there are multiple **Device Address** set for receive command data, and at least 1 command has the **Variable** check box selected, this corresponds to **With Variable**.

Start code	Terminal code	Variable	Description of the procedure for terminal of data reception
Set	Set	Set Not set	<p>Reception is started with the start code and terminated with the terminal code.</p> <p>Command settings: Constant (Hexadecimal) Device Address Constant (Hexadecimal)</p> <p>Receive data: '02' '31' '32' '33' <[LDR0100] N 2 2 U> '34' '35' '0d'</p> <p>Start code 02h Terminal code 0dh</p> <p>Receive</p>
			<p>When the terminal code is followed by BCC, the data including the number of bytes of BCC is received.</p> <p>Command settings: Constant (Hexadecimal) Device Address Constant (Hexadecimal) BCC</p> <p>Receive data: '02' '31' '32' '33' <[LDR0100] N 2 2 U> '34' '35' '0d' BCC(1 0 XOR N 1)</p> <p>Start code 02h Terminal code 0dh</p> <p>Receive</p>
Set	Not set	Set	<p>Reception is started with the start code and the data is received according to the maximum command length.</p> <p>Command settings: Constant (Hexadecimal) Device Address With Variable Registering Constant (Hexadecimal)</p> <p>Receive data: '02' '31' '32' <[LDR0100] N 2V 2 U> <<1:"AB" 2:"CD" [LDR0200]>></p> <p>Start code 02h Terminal code: None</p> <p>Maximum command length</p> <p>Receive</p>
		Not set	<p>Reception is terminated when the Receiving Character Time Out occurs.</p> <p>Command settings: Constant (Hexadecimal) Device Address With Variable Constant (Hexadecimal) Registering Constant (Hexadecimal)</p> <p>Receive data: '02' '31' '32' <[LDR0100] N 2V 2 U> '03' <<1:"AB" 2:"CD" [LDR0200]>></p> <p>Start code 02h Receiving character time out occurs. Terminal code: None</p> <p>Receive</p>
		Not set	<p>Reception is started with the start code and the data is received according to the length of the command.</p> <p>Command settings: Constant (Hexadecimal) Device Address Without Variable Registering Constant (Hexadecimal)</p> <p>Receive data: '02' '31' '32' <[LDR0100] N 2 2 U> <<1:"AB" 2:"CD" [LDR0200]>></p> <p>Start code 02h Terminal code: None</p> <p>Command length</p> <p>Receive</p>

Start code	Terminal code	Variable	Description of the procedure for terminal of data reception
Not set	Set	Set Not set	<p>Reception is started from the beginning and terminated with the terminal code.</p> <p>Command settings: Registering Constant (Hexadecimal) Device Address Constant (Hexadecimal)</p> <p>Receive data: <<1:"AB" 2:"CD" [LDR0200]>> <[LDR0100] N 2 2 U> '34' '35' '0d'</p> <p>Start code: None Terminal code 0dh</p>
Not set	Not set	Set	<p>Reception is started from the beginning and the data is received according to the maximum command length.</p> <p>Command settings: Skip Constant (Character) Device Address With Variable</p> <p>Receive data: Skip(2) "123" <[LDR0100] N 2V 2 U></p> <p>Start code: None Terminal code: None</p> <p>Reception is terminated when the Receiving Character Time Out occurs.</p> <p>Command settings: Skip Constant (Character) Device Address With Variable</p> <p>Receive data: Skip(2) "123" <[LDR0100] N 2V 2 U></p> <p>Start code: None Terminal code: None</p>
		Not set	<p>Reception is started from the beginning and terminated when the data is received according to the length of the command.</p> <p>Command settings: Device Address Without Variable Registering Constant (Hexadecimal) BCC</p> <p>Receive data: <[LDR0100] N 2 2 U> <<1:"AB" 2:"CD" [LDR0200]>> BCC(1 0 XOR N 1)</p> <p>Start code: None Terminal code: None</p>



- When trigger conditions are satisfied for two or more receive commands for which both start code and terminal code are set, all commands are analyzed and processed for receive processing. Since commands with and without errors may be mixed depending on the results of data reception analysis of each command, take extra caution regarding error handling.
- While the trigger condition is satisfied for a receive command for which either a start code or terminal code is not set, only this command is processed for data reception when the trigger condition of another command is being satisfied. When two or more commands exist for which either start code or terminal code is not set, the command with the biggest number for managing the protocol is processed.
- When a start code of the receive command for which a start code is set cannot be received, all of the receive data is ignored and abandoned. No error occurs.
- When start code is received with a receive command for which start code and terminal code are set, the data reception is completed after the maximum number of bytes received in case of continuous reception of data that does not match the terminal code of all receive command in which the trigger conditions is satisfied.

5.4 Example of User Communication Settings

This section describes examples of user communication settings and command operations.

● Example 1

This section describes an example of user communication protocol settings for creating the following commands and command operations.

- Transmission command for transmitting data using Constant (Hexadecimal), Constant (Character), Device Address, Constant (Hexadecimal) command settings when the trigger condition device address changes to 1
- Receive command for receiving, processing, and storing data in device addresses, using Constant (Hexadecimal), Constant (Character), Device Address, Constant (Hexadecimal) command settings, for data transmitted from an external device, when the trigger condition device address is 1

■ Settings in the User Communication tab on the Project Settings dialog box

Item	Setting
Protocol Name	Sample 1
Receiving Character Time Out	30 (×100 msec)

Transmission command: Command Settings dialog box settings

Item	Setting	
Type	TXD	
Trigger Condition	Rising-edge, Device Address: LM100	
Completed Device Address	LM101	
Status Device Address	LDR110	
Transmission Wait	50 (×100 msec)	
Comment	TXD command	
Command Data Settings dialog box settings	Constant (Hexadecimal)	'05'
	Constant (Character)	"D"
	Device Address	Conversion Type: Decimal to ASCII, Number of bytes: 4, Words: 1 Device Address: LDR100
	Constant (Hexadecimal)	'0D'

Operation for transmission command

- 1 Write a value of 100 (Dec) to LDR100 of transmission command data **Device Address**.
- 2 Change the trigger condition LM100 from 0 to 1 to start command transmission.

After the transmission wait duration (five seconds), the transmission data is sent. The transmission data is as follows.

Command settings:	Constant (Hexadecimal)	Constant (Character)	Device Address			Constant (Hexadecimal)	
Transmission data:	EQN (05h)	D (44h)	0 (30h)	1 (31h)	0 (30h)	0 (30h)	CR (0Dh)

- When data transmission is successfully completed, the Completed Device Address LM101 changes to 1.
- When the value of each bit of address number+0 for Status Device Address LDR110 is 0, transmission is completed without an error.

Receive command: Command Settings dialog box settings

Item	Setting	
Type	RXD	
Trigger Condition	While ON, Device Address: LM101	
Completed Device Address	LM102	
Not Clear Completed Device Address automatically	No	
Status Device Address	LDR130	
Receiving Time Out	0 (No Receive Time Out)	
Comment	RXD command	
Command Data Settings dialog box settings	Constant (Hexadecimal)	'02'
	Constant (Character)	"D"
	Device Address	Conversion Type: ASCII to Hexadecimal, Number of bytes: 4, Words: 1 Device Address: LDR120, Reference Device Address: LDR100
	Constant (Hexadecimal)	'0D'

Operation for receive command

- 1 When data transmission of the transmission command is completed, the value of LM101 changes to 1, and since the same device address is specified for the trigger condition user communication becomes ready for receiving.
- 2 Data is transmitted from the external device and the transmitted data is received and processed.

The receive data is as follows.

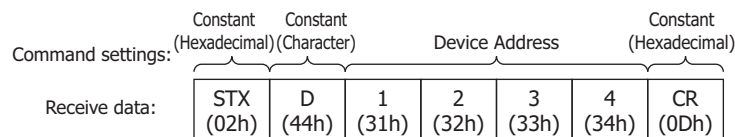

Since a value of 100 is written to LDR100 at the time of transmission, the data is stored in device address LDR220, which corresponds to an offset of +100 from LDR120.

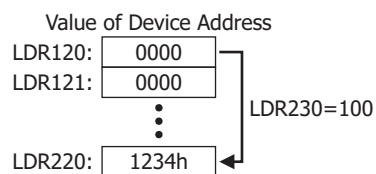

- When data reception is successfully completed, the Completed Device Address LM102 changes to 1.
- When the value of each bit of address+0 of Status Device Address LDR130 is 0, reception is completed without an error.

● Example 2

This section describes an example of user communication protocol settings for creating the following commands and command operations.

- Transmission command for transmitting data using Constant (Hexadecimal), Registering Constant (Character), Device Address, BCC, Constant (Hexadecimal) command settings when the trigger condition device address changes to 1
- Receive command for receiving, processing, and storing data in device addresses, using Constant (Hexadecimal), Registering Constant (Character), Skip, Device Address, BCC, Constant (Hexadecimal) command settings, for data transmitted from an external device, when the trigger condition device address is 1

■ Settings in the User Communication tab on the Project Settings dialog box

Item	Setting
Protocol Name	Sample 2
Receiving Character Time Out	30 (×100 msec)

Transmission command: Command Settings dialog box settings

Item	Setting	
Type	TXD	
Trigger Condition	Rising-edge, LM200	
Completed Device Address	LM201	
Status Device Address	LDR220	
Transmission Wait	0 (×100 msec)	
Comment	TXD command	
Command Data Settings dialog box settings	Constant (Hexadecimal)	'05'
	Registering Constant (Character)	10: "AB", 20: "CD", Index Device Address: LDR200
	Device Address	No conversion, from Upper byte, Number of bytes: 2, Words: 2, Device Address: LDR210
	BCC	Start Calculation Position: 1, End Calculation Position: 0, XOR, Hexadecimal to ASCII, 2 bytes
	Constant (Hexadecimal)	'0D"0A'

Operation for transmission command

- 1 Write a value of 10 (Dec) to LDR200 for **Registering Constant (Character)** for transmission command data. **AB** is selected.

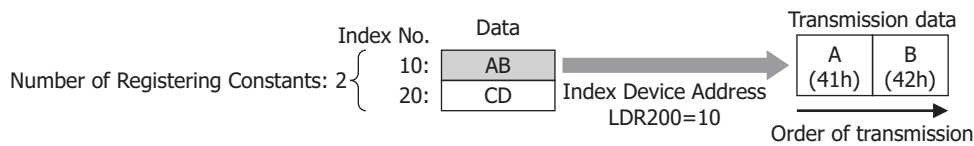

- 2 Write a value of 3132h to LDR210 and 3334h to LDR211 for **Device Address** for transmission command data.
- 3 Change the value of the trigger condition LM200 from 0 to 1 to send the command.

The transmission data is as follows.

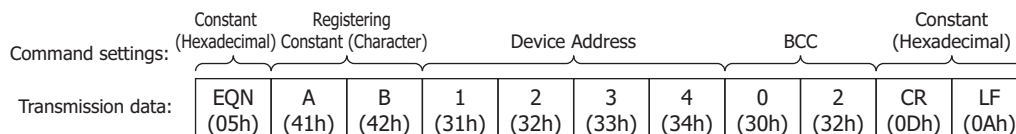

- When data transmission is successfully completed, the Completed Device Address LM201 changes to 1.
- When the value of each bit of address number+0 for Status Device Address LDR220 is 0, transmission is completed without an error.

Receive command: Command Settings dialog box settings

Item	Setting	
Type	RXD	
Trigger Condition	While ON, Device Address: LM202	
Completed Device Address	LM203	
Not Clear Completed Device Address automatically	No	
Status Device Address	LDR260	
Receiving Time Out	0 (No Receive Time Out)	
Comment	RXD command	
Command Data Settings dialog box settings	Constant (Hexadecimal)	'02'
	Registering Constant (Character)	10: "AB", 20: "CD", Index Device Address: LDR230
	Skip	2 bytes
	Device Address	Conversion Type: No conversion, from Upper byte, Number of bytes: 2, Words: 2 Device Address: LDR240, Reference Device Address: LDR230
	BCC	Calculation Start Position: 1 Calculation End Position: 0, XOR Hexadecimal to ASCII, 2 bytes
	Constant (Hexadecimal)	'0D'0A'

Operation for receive command

- 1 Change the trigger condition LM202 from 0 to 1 to be ready for receiving user communication.
- 2 Data is transmitted from the external device and the transmitted data is received and processed. The receive data is as follows.

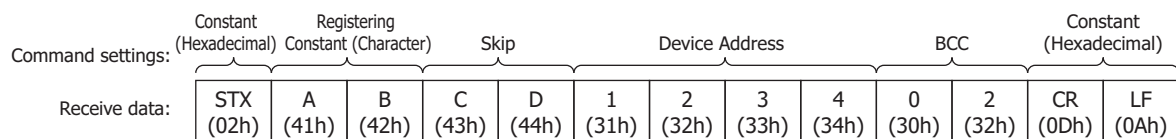

- The receive data is compared with the character data, and the value of the matching Index No. (10 (Dec)) is stored in Index Device Address LDR230.

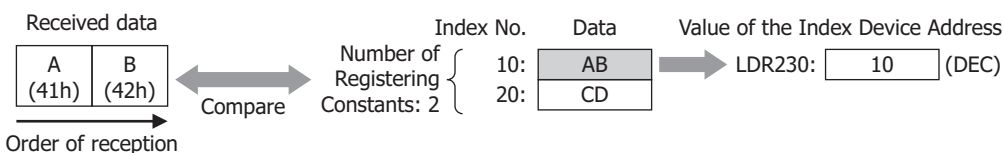

- The 2 bytes (specified with **Skip**) of the receive command data 43h and 44h are ignored.
- Since the Reference Device Address LDR 230 of **Device Address** of the receive command data is 10 (Dec), the data is stored in the device address LDR250 and LDR251, which is offset by +10.

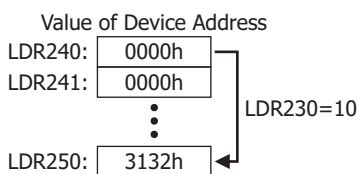

- **[STX] ABCD1234** is calculated with **BCC** of receive command data and compared with 3032h.
- When Calculation Start Position is 1 and Calculation End Position is 0: Calculates the range **STX ABCD1234**.

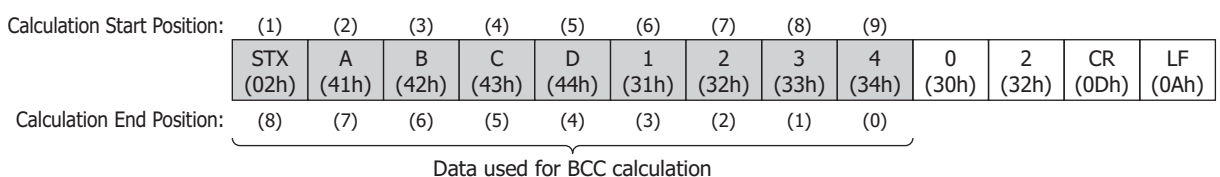

- The BCC calculation type is **XOR**.
 $02h \wedge 41h \wedge 42h \wedge 43h \wedge 44h \wedge 31h \wedge 32h \wedge 33h \wedge 34h = 02h$

- When the BCC calculation result is **0002h**, the converted data will be **3032h**.

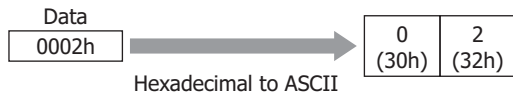

- When the converted data is **3032h**, the data for comparison with the BCC part of the receive data will be **3032h**.

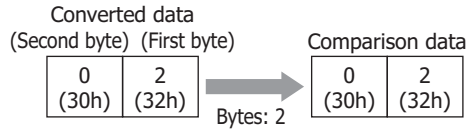

- The comparison data is compared with the BCC part of the receive data.
 In the following receive data, when the comparison data is the 2-byte 3032h, there is a match since the BCC part data is 3032h.

When there is no match, the BCC Error (address number+0, bit 0) of Status Device Address changes to 1.

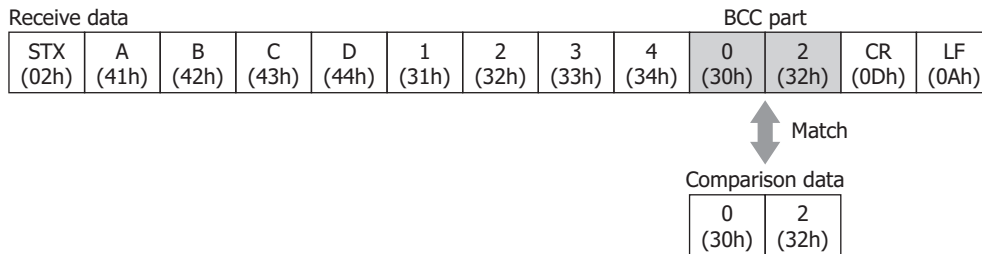

- When data reception is successfully completed, the Completed Device Address LM203 changes to 1.
- When the value of each bit of address number+0 for Status Device Address LDR250 is 0, transmission is completed without an error.

● Example 3

This section describes an example of user communication protocol settings for creating the following commands and command operations.

Transmission command for transmitting data using Constant (Hexadecimal), Constant (Character), Constant (Hexadecimal), BCC, Constant (Hexadecimal) command settings when the value of the trigger condition device address is 1

■ Settings in the User Communication tab on the Project Settings dialog box

Item	Setting
Protocol Name	Sample 3
Receiving Character Time Out	- (Cannot be configured)
Inching Function	Enable
Execution Interval	10 (x10 msec)

Transmission command: Command Settings dialog box settings

Item	Setting
Type	Inching
Function Key	F7
Trigger Condition	While satisfying the condition, LSD31==5
Completed Device Address	LM301
Status Device Address	LDR330
Transmission Wait	- (Cannot be configured)
Comment	TXD Inching command
Command Data Settings dialog box settings	Constant (Hexadecimal) '01'
	Constant (Character) "K"
	Constant (Hexadecimal) '31'01'
	BCC Calculation Start Position: 1, Calculation End Position: 0, XOR, Hexadecimal to ASCII, 2 bytes
	Constant (Hexadecimal) '0D'

Operation for transmission command

- 1 When the value of Trigger Condition LSD31 is 5, press the Function Key F7 and command is transmitted in one hundred milliseconds intervals.

The transmission data is as follows.

Command settings:	Constant (Hexadecimal)	Constant (Character)	Constant (Hexadecimal)	BCC	Constant (Hexadecimal)
Transmission data:	SOH (01h)	K (4Bh)	1 (31h)	0 (30h) 2 (32h)	CR (0Dh)

- When data transmission is successfully completed, the Completed Device Address LM301 changes to 1.
- When the value of each bit of address number+0 for Status Device Address LDR330 is 0, transmission is completed without an error.

5.5 Connection Diagram for User Communication

When connecting an external device to the MICRO/I via user communication, refer to the following connection diagram.

■ Serial interface 1 (RS232C)

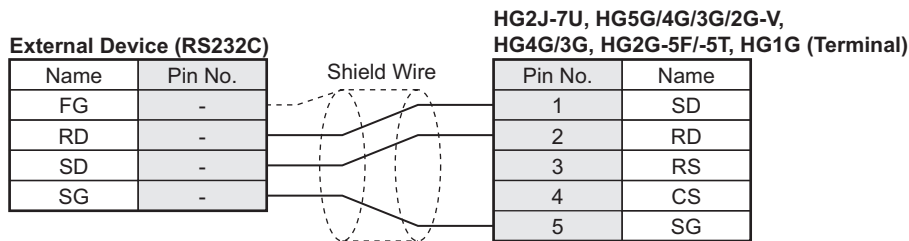
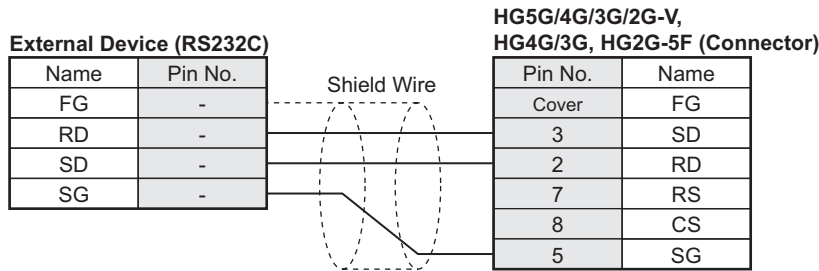

■ Serial interface 1 (RS422/485)

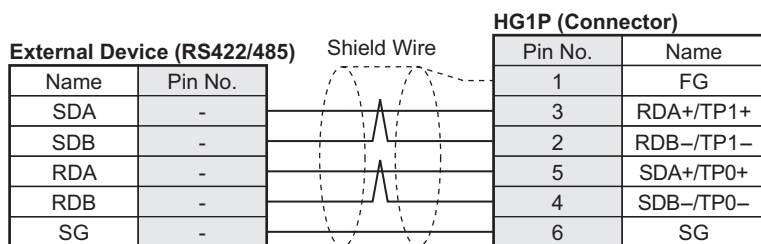
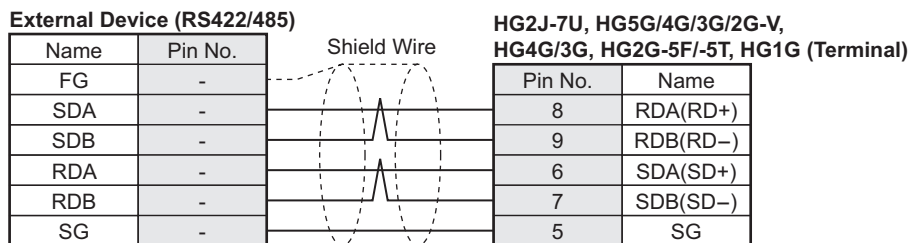
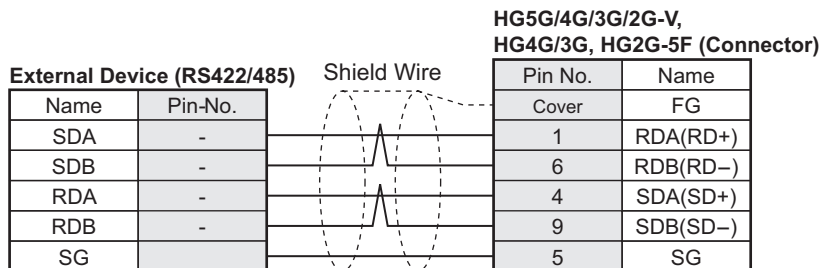

There is no pin number corresponding to TERM. When you need a terminating resistor, read the Chapter 1 "3 Important Points Regarding Wiring" in the WindO/I-NV4 External Device Setup Manual.

■ Serial Interface 2

HG5G/4G/3G/2G-V, HG4G/3G, HG2G-5F (Terminal)

Refer to the above "Serial interface 1 (RS232C)" and "Serial interface 1 (RS422/485)" about the connection diagram of the Serial Interface 2 on the HG5G/4G/3G/2G-V, HG4G/3G, HG2G-5F.

6 Sub Host Communication

HG2J-7U HG5G-V HG4G-V HG4G HG3G-V HG3G HG2G-V HG2G-5F HG2G-5T HG1G HG1P

6.1 Overview

Sub Host Communication is a function for communicating with an external device using the MICRO/I's HMI Link Registers (LLR).

The external device addresses are allocated to HMI Link Registers (LLR). When MICRO/I receives a request to read from or write to HMI Link Registers (LLR), it reads from or writes to the allocated external device addresses, and the execution results are stored in HMI Link Registers (LLR).

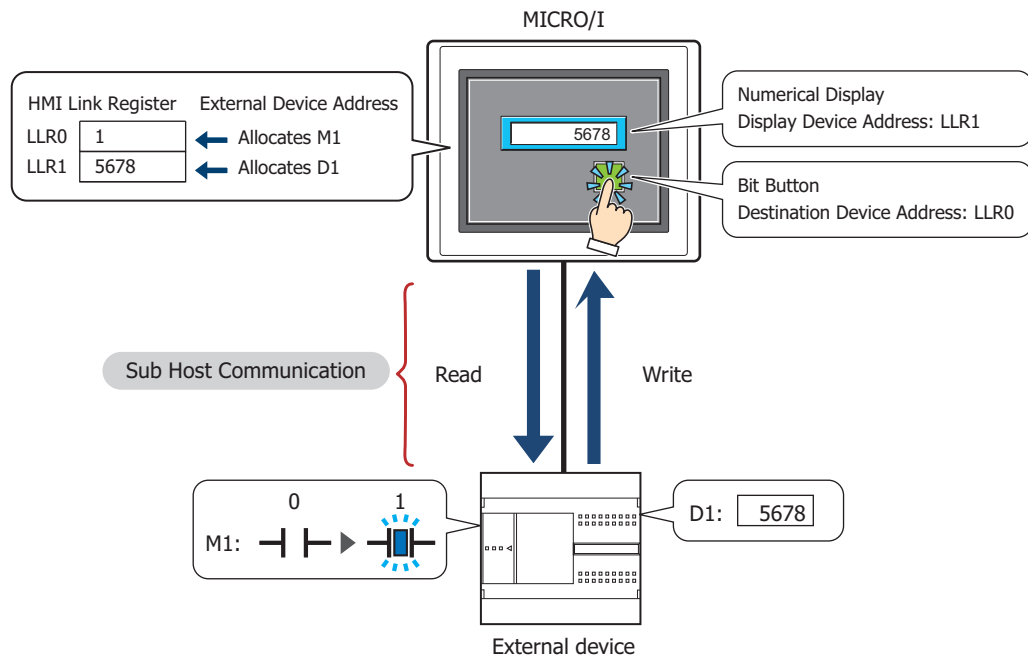

6.2 Supported Protocols and Communication Driver

The Sub Host communication can be used with the following protocols and communication drivers:

Protocol	Communication Driver
MICROSmart	Manufacturer: IDEC Communication driver: OpenNet, MICROSmart, SmartAXIS Pro/Lite(RS232C/485)
Modbus RTU Master	Manufacturer: Modbus Communication driver: Modbus RTU Master



For the device addresses that can be used by each protocol, communication cable connection, and usable device addresses, refer to "5.5 Connection Diagram for User Communication" on page 3-86 and Chapter 2 "Connection to a PLC" in the WindO/I-NV4 External Device Setup Manual.

6.3 HMI Link Register (LLR) Assignment

This section describes how to allocate and the operation of HMI Link Registers (LLR) in Sub Host Communication.

● Example of HMI Link Register (LLR) Settings

Use the Device Link Communication between the external device and the MICRO/I's serial interface (COM1), and use the Sub Host communication between the external device and the MICRO/I's serial interface (COM2).

Allocate the following external device addresses to the HMI Link Registers (LLR).

■ Settings in the Communication Interface tab on the Project Settings dialog box

Interface	Function
COM1	External Device Communication 1
COM2	Sub Host Communication

■ Settings in the Sub Host Communication tab on the Project Settings dialog box

Item	Settings	
Protocol	MICROSmart	
Allocate Device Address HMI Link Register (LLR)	LLR0	0:D0100
	LLR1	0:M0002
	LLR2	1:D100-1
	LLR3	2:D101

Example: HMI Link Registers (LLR) are configured for the following parts

Display Device Address for Numerical Display	LLR0
Destination Device Address for Numerical Input	LLR3
Destination Device Address for Bit Button	LLR1
Trigger Device Address for Pilot Lamp	LLR2

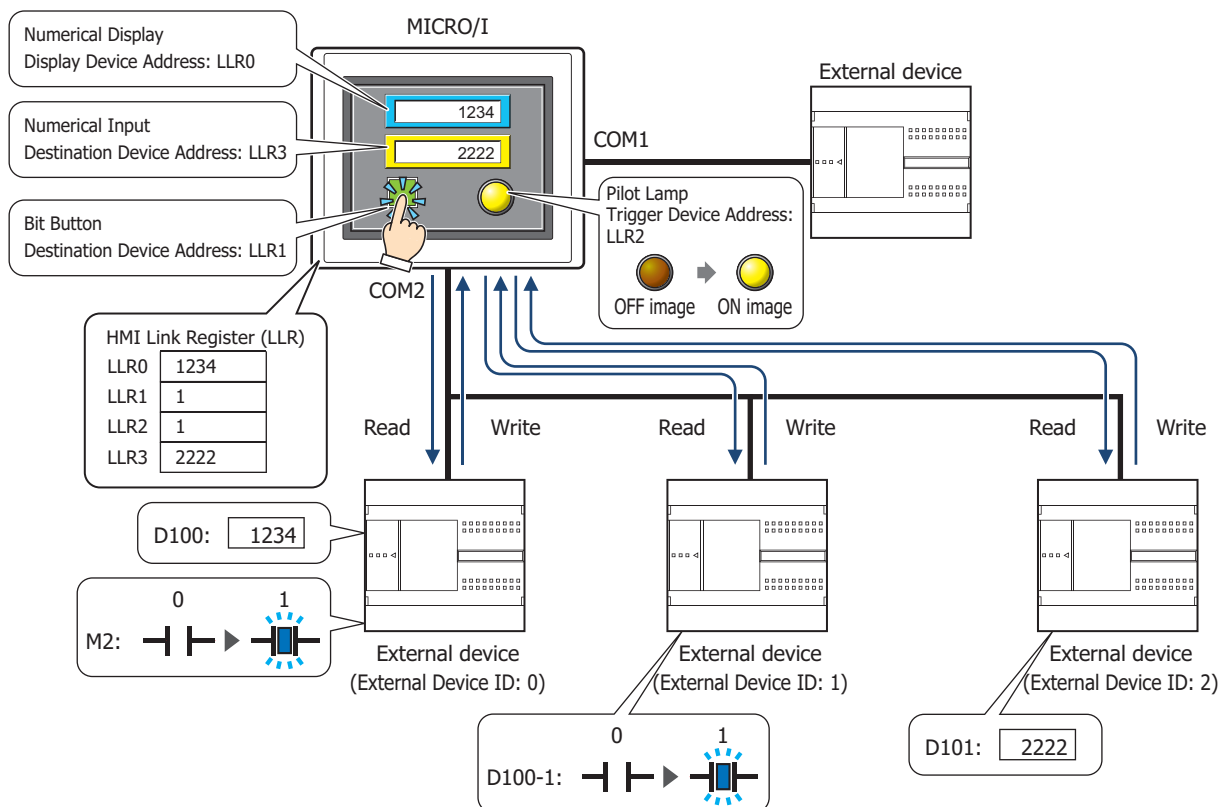

Don't use the frequent write operation for HMI Link Register (LLR) which is caused by a script and a word command. It may make the reading data operation too much slow.

6.4 Sub Host Communication Configuration Procedure

This section describes the configuration procedure for Sub Host Communication.

● Setting Sub Host Communication for a communication interface

1 On the **Configuration** tab, in the **System Setup** group, click **Project**.

The Project Settings dialog box appears.

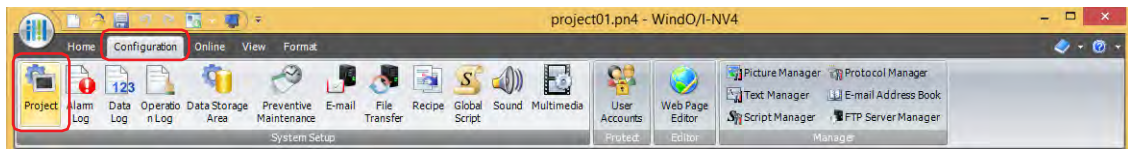

2 Click the **Communication Interface** tab.

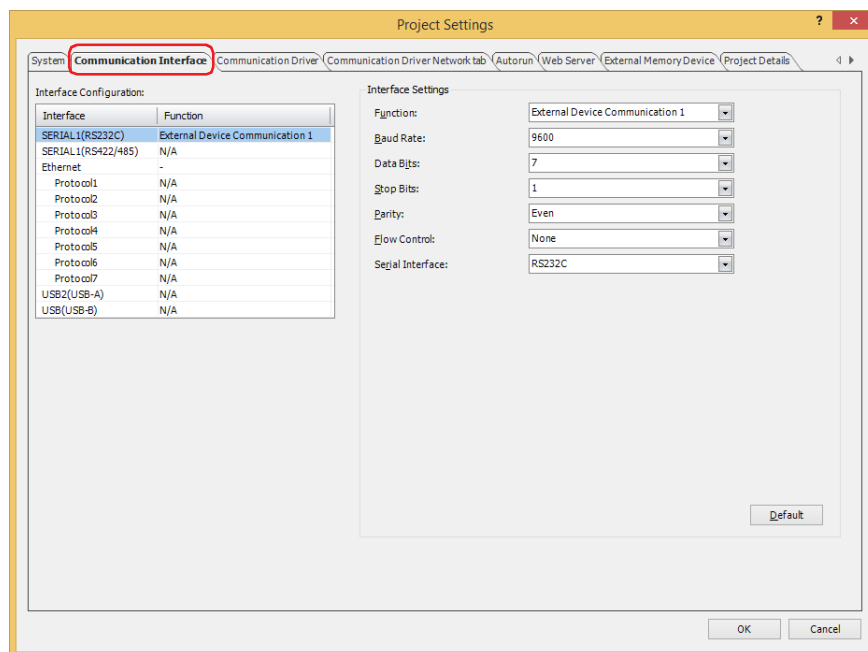

3 Select the interface for Sub Host Communication under **Interface Configuration**, and then select the **Sub Host Communication** in **Function** under **Interface Settings**.

The **Sub Host Communication** tab is displayed.

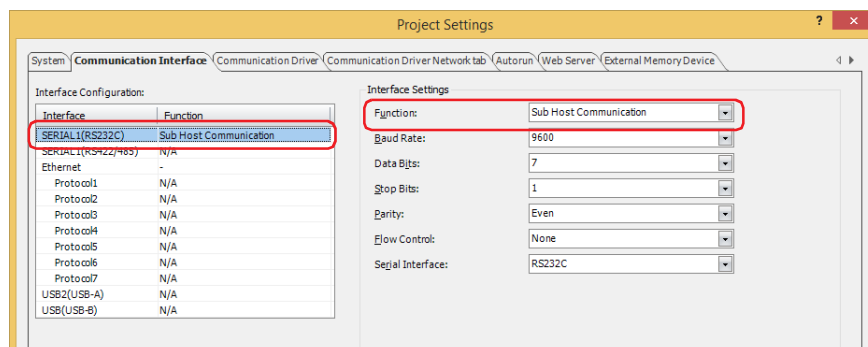

Serial Interface (COM1*1, COM2*1, COM*2, or SERIAL1*3) can be used for Sub Host Communication. Two or more interfaces cannot be used at the same time.

*1 HG5G/4G/3G/2G-V, HG4G/3G, HG2G-5F only

*2 HG1G/1P only

*3 HG2G-5T only

4 Configure the **Interface Settings**.

■ **HG5G/4G/3G/2G-V, HG4G/3G, HG2G-5F**

For details, refer to Chapter 4 “When COM1, COM2, COM2(RS232C), or COM2(RS422/485) is selected under Interface Configuration” on page 4-39.

■ **HG2G-5T, HG1G/1P*1**

For details, refer to Chapter 4 “When SERIAL1(RS232C), SERIAL1(RS422/485), COM(RS232C), or COM(RS422/485) is selected under Interface Configuration” on page 4-40.

5 Click the **Sub Host Communication** tab.

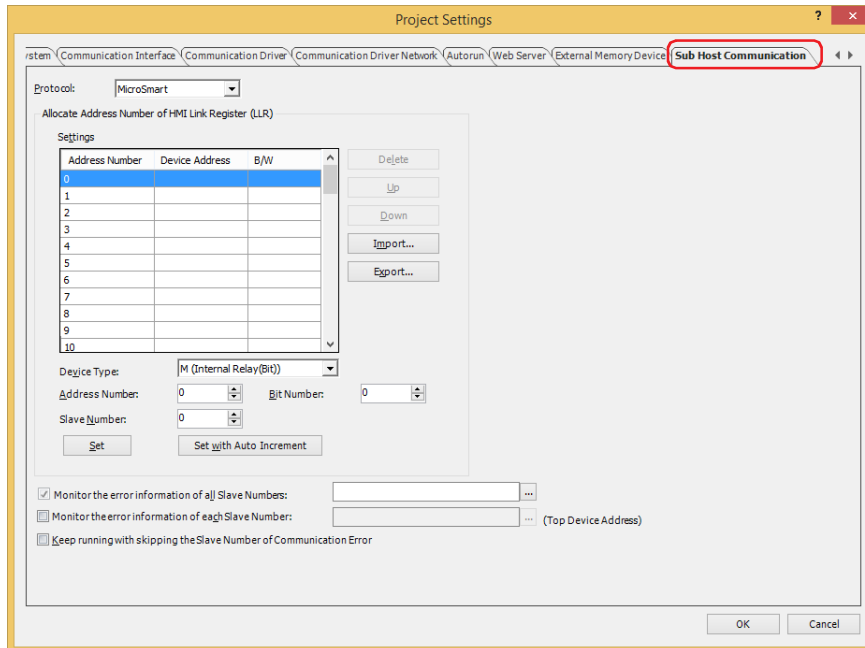

6 Selects the protocol as **MICROSmart** or **Modbus RTU Master** in the **Protocol**.

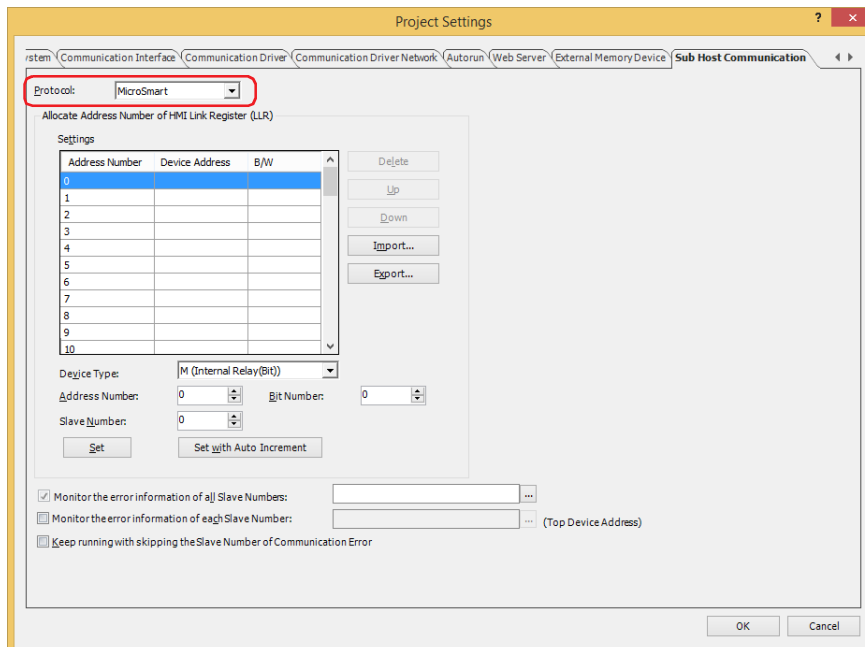

*1 This is applicable for models with a serial interface (RS422/485) only.

- 7 Allocate the external device addresses to the HMI Link Registers (LLR) used with **Address Number** in **Settings**.
For details, refer to Chapter 4 "3.7 Sub Host Communication Tab" on page 4-60.

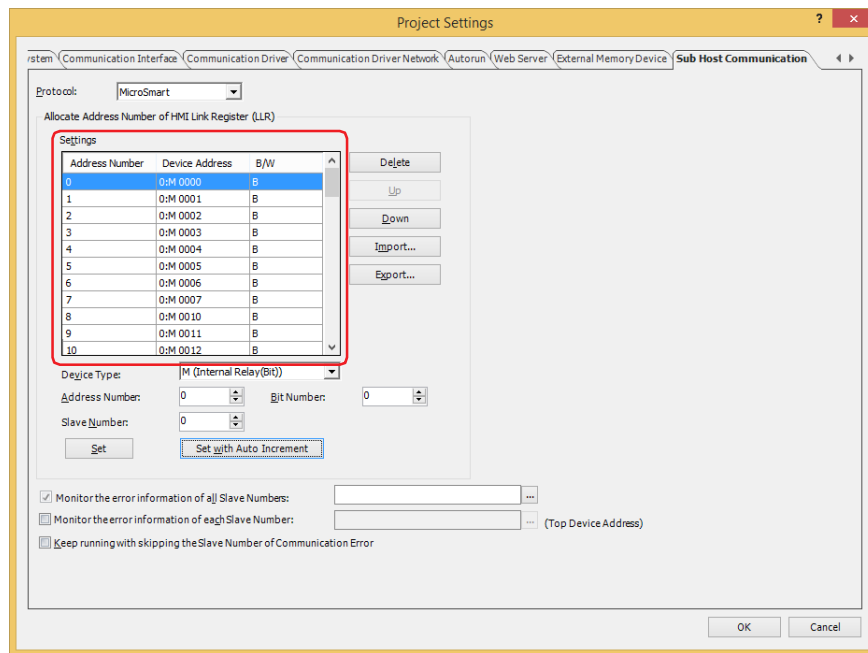

- 8 Click **OK**.

This concludes configuring Sub Host Communication for communication interfaces.

6.5 Error Information

This setting is for monitoring all error information and for controlling Sub Host Communication.

● Monitor the error information of all Slave Numbers

The error information of all external devices communicated with using Sub Host Communication can be monitored. This option is configured on the **Sub Host Communication** tab in the Project Settings dialog box. Select the **Monitor the error information of all Slave Numbers** check box, and then specifies a word device to write the error information.

Click  to display the Tag Editor. For the device address configuration procedure, refer to Chapter 2 "5.1 Device Address Settings" on page 2-70.

Bit	15	14	13	12	11	10	9	8	7	6	5	4	3	2	1	0
Function	Reserved								Error Log for Writing	Error Log for Reading	Reserved	Current Error	Reserved	Finish 1st reading	Initialize	Reserved
Read/Write									R	R		R		R	R/W	

Bit	Function	Descriptions
0	Reserved	—
1	Initialize	Clear all error information of Sub Host Communication. Write 1 to clear all error information, and this bit changes to 0 after clear. Error information of each slave number of the device addresses configured with the Monitor the error information of each Slave Number check box is also cleared.
2	Finish 1st reading	This bit changes to 1 after all device addresses allocated to HMI Link Registers (LLR) are read.
3	Reserved	—
4	Current Error	This bit changes to 1 while a communication error occurs in any device address allocated to HMI Link Registers (LLR). The bit changes to 0 after the communication error recovers.
5	Reserved	—
6	Error Log for Reading	This bit changes to 1 when the reading error has occurred in any device address allocated to HMI Link Registers (LLR). This bit keeps 1 even if the reading error recovers. Writes 1 to the Bit 1 (Initialize) to make this bit 0.
7	Error Log for Writing	This bit changes to 1 when the writing error has occurred in any device address allocated to HMI Link Registers (LLR). This bit keeps 1 even if the writing error recovers. Writes 1 to the Bit 1 (Initialize) to make this bit 0.
8 to 15	Reserved	—

- Monitor the error information of each Slave Number

The error information of external devices communicated with using Sub Host Communication can be monitored per external device.

This option is configured on the **Sub Host Communication** tab in the Project Settings dialog box. Select the **Monitor the error information of each Slave Number** check box, and then specifies a word device to write the error information. 256 word devices from top device set in this option are used. Each device is assigned to each slave number of PLC.

Click to display the Tag Editor. For the device address configuration procedure, refer to Chapter 2 "5.1 Device Address Settings" on page 2-70.

Bit	15	14	13	12	11	10	9	8	7	6	5	4	3	2	1	0
Function	Reserved								Error Log for Writing	Error Log for Reading	Reserved	Current Error	Reserved	Finish 1st reading	Reserved	Connection
Read/Write									R	R		R		R		R/W

Bit	Function	Descriptions
0	Connection	Specifies the communication with the external devices of the relevant slave number. When this bit is 1, MICRO/I connects with each external device. When this bit is 0, MICRO/I does not connect the external device. Default value is 1 when the device addresses of the relevant slave number are registered to HMI Link Registers (LLR).
1	Reserved	—
2	Finish 1st reading	This bit changes to 1 after all device addresses allocated to HMI Link Registers (LLR) of the relevant slave number are read.
3	Reserved	—
4	Current Error	This bit changes to 1 while the communication error occurs in the device addresses allocated to the HMI Link Registers (LLR) of the relevant slave number. This bit changes to 0 after the communication error recovers.
5	Reserved	—
6	Error Log for Reading	This bit changes to 1 when the reading error has occurred in any device address allocated to the HMI Link Registers (LLR) of the relevant slave number. This bit keeps 1 even if the reading error recovers. Writes 1 to the Bit 1 (Initialize) of the Monitor the error information of all Slave Numbers check box to make this bit 0.
7	Error Log for Writing	This bit changes to 1 when the writing error has occurred in any device address allocated to the HMI Link Registers (LLR) of the relevant slave number. This bit keeps 1 even if the writing error recovers. Writes 1 to the Bit 1 (Initialize) of the Monitor the error information of all Slave Numbers check box to make this bit 0.
8 to 15	Reserved	—

- Keep running with skipping the Slave Number of communication error

When this option is selected, skip the slave number error has occurred and connect with next slave number. This option is configured on the **Sub Host Communication** tab in the Project Settings dialog box. Select the **Keep running with skipping the Slave Number of communication error** check box.

When this option is not selected, retry communication with same slave number until recover from the error.

7 BACnet Communication

HG2J-7U HG5G-V HG4G-V HG4G HG3G-V HG3G HG2G-V HG2G-5F HG2G-5T HG1G HG1P

7.1 Overview

BACnet communication stands for "Building Automation and Control Networking Protocol". In building equipment, it is an open protocol that has been standardized for interoperability between systems built by different manufacturers, and a communication standard for building networks.

Previous air conditioning, lighting, security, and fire protection systems were connected using methods unique to the building equipment and systems manufacturers. However, conforming to BACnet allows equipment and systems to be connected and monitored using a common method.

A device connected by BACnet, and a device compatible with BACnet/IP is called a BACnet device.

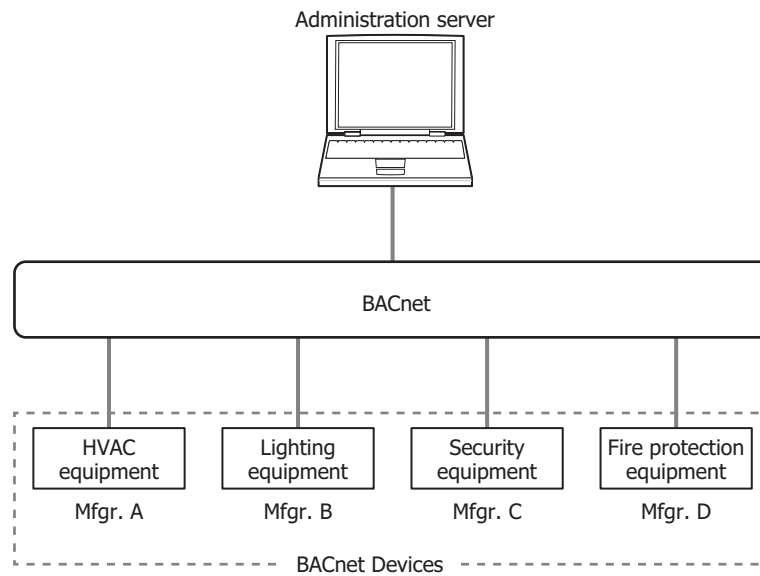

7.2 BACnet Specifications

Item		Details
Interface		Ethernet Interface
Applicable Standards		ANSI/ASHRAE135-2012
Standard Specifications	Protocol	BACnet/IP
	Profile	B-ASC
	Object Type	Device Object, Analog Input Object, Analog Output Object, Analog Value Object, Binary Input Object, Binary Output Object, Binary Value Object
	Number of Objects	256 maximum ^{*1}
	BIBBs	DS-RP-B, DS-WP-B, DS-RPM-B, DS-WPM-B, DS-COV-B, DS-COVU-B, DM-DDB-B, DM-DOB-B, DM-DCC-B
	BBMD	None-BBMD Device
	Virtual Device	Not supported
	Foreign Device	Supported
Subscribed COV Function	Number of Requests That Can Be Accepted	256 requests maximum
Unsubscribed COV Function	Transmission Unit	Every object
	Transmission Cycle	1 to 65,535 msec ^{*2}
Foreign Device Function	Registration Method	Registration as needed by registration trigger device
	Lifetime	0 to 65,535 sec
Device Binding Function		Synchronization between properties and device addresses ^{*3} Data type conversion of Present _Value ^{*4} Coefficient conversion of Present _Value ^{*4}

*1 Device Object is not included.

*2 The transmission cycle is set for all objects.

*3 The properties of objects created in internal memory are synchronized with specified device addresses.

*4 Supported objects are Analog Input Object, Analog Output Object, and Analog Value Object.

7.3 About BACnet

■ Applicable Standards

- ANSI/ASHRAE135-2012

■ Profile

BACnet/IP in the MICRO/I supports the following profile.

- B-ASC

■ Objects

Information, such as input and output values handled by BACnet devices that support BACnet/IP, are managed in units called objects. Objects are separated into a number of different types, depend on the content of the object, and these are called object types. The object types supported by BACnet/IP in the MICRO/I are as follows.

Object Type			
	Name	Abbreviation	Identifier
Basic input and output	Analog Input Object	AI	0
	Analog Output Object	AO	1
	Analog Value Object	AV	2
	Binary Input Object	BI	3
	Binary Output Object	BO	4
	Binary Value Object	BV	5
BACnet device attributes	Device Object	DV	8

The MICRO/I can set objects for each object type. This information can be written to and read from BACnet devices on the same BACnet/IP network. Regardless of the object type, the maximum number of objects that can be set is 256 in total.

For details on objects, refer to "7.8 Objects" on page 3-124.

■ Properties

Properties are the detailed information and attributes of each object.

For details on the properties of each object type, refer to "7.8 Objects" on page 3-124.

■ Services

Services are interfaces used to exchange information between BACnet devices. Services are classified into the client side that initiates services and the server side that executes services.

The Services supported by BACnet/IP in the MICRO/I are as follows.

Services	Initiate ^{*1}	Execute ^{*2}
ReadProperty	NO	YES
ReadPropertyMultiple	NO	YES
WriteProperty	NO	YES
WritePropertyMultiple	NO	YES
SubscribeCOV	NO	YES
ConfirmedCOVNotification	YES	NO
UnconfirmedCOVNotification	YES	NO
Who-Is	NO	YES
I-Am	YES	NO
Who-Has	NO	YES
I-Have	YES	NO
DeviceCommunicationControl	NO	YES



For details on services, refer to the ANSI/ASHRAE 135-2012 (ISSN 1041-2336) standard or "BACnet Building Automation Data Communication Protocol", a book published by the Institute of Electrical Installation Engineers of Japan.

*1 The MICRO/I initiates services for other BACnet devices.

*2 The MICRO/I executes services that are initiated from other BACnet devices.

■ BIBB

BACnet interoperability building blocks (BIBB) are groupings of multiple services for each function that will be implemented. BIBBs are classified into the client side that uses the function and the server side that provides the function. '-A' is appended to the end of the client-side BIBBs, and '-B' is appended to the end of the server-side BIBBs. BACnet devices define the functions they support using BIBBs.

The BIBB supported by BACnet/IP in the MICRO/I are as follows.

BIBB Category	BIBB		Services
Data Sharing	DS-RP-B	Data Sharing Read Property B	ReadProperty
	DS-WP-B	Data Sharing Write Property B	ReadPropertyMultiple
	DS-RPM-B	Data Sharing Read Property Multiple B	WriteProperty
	DS-WPM-B	Data Sharing Write Property Multiple B	WritePropertyMultiple
	DS-COV-B	Data Sharing COV B	SubscribeCOV ConfirmedCOVNotification UnconfirmedCOVNotification
	DS-COVU-B	Data Sharing COV Unsubscribed B	UnconfirmedCOVNotification
Device & Network Management	DM-DDB-B	Device Management Dynamic Device Binding B (Who-Is, I-Am)	Who-Is I-Am
	DM-DOB-B	Device Management Dynamic Object Binding B (Who-Has, I-Have)	Who-Has I-Have
	DM-DCC-B	Device Management Device Communication Control B	DeviceCommunicationControl



For details on BIBBs, refer to "BACnet Building Automation Data Communication Protocol", a book published by the Institute of Electrical Installation Engineers of Japan.

7.4 Function

The MICRO/I provides the following functions as a single BACnet device.

- Object and Device Address Binding function
- Read Property function
- Write Property function
- Subscribed COV function
- Unsubscribed COV function
- Foreign Device function

● Object and Device Address Binding Function

A portion of the properties held by objects created in the MICRO/I can be allocated to device addresses, such as data registers, and those device addresses can be written to and read.

For example, the analog input value of the MICRO/I can be stored in a data register (#D0000) allocated as Present_Value of the Analog Input object, and that analog input value can be read by BACnet devices. The analog output value of the MICRO/I can also be changed from BACnet devices by allocating the data register (#D0004) that stores the analog output value as Present_Value of the Analog Output object.

The types and numbers of objects can be freely set. The initial values of properties are also set with WindO/I-NV4.

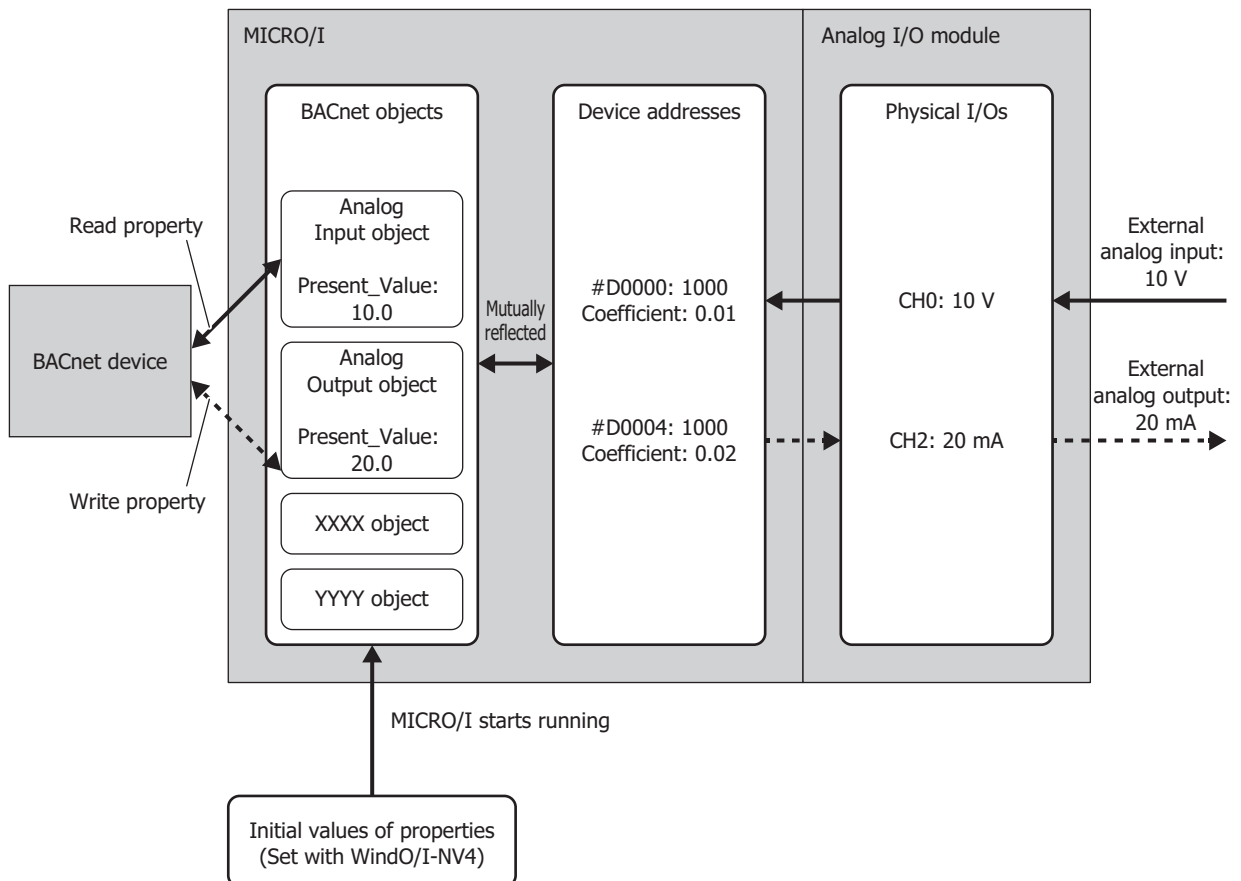

- The processing to mutually reflect properties and device addresses is performed with no relationship to the processing for parts on the MICRO/I screen. Because device addresses allocated to objects will be written and read during execution of the processing for parts on the screen, create it so that no problems will occur when device addresses are referenced or refreshed.
- If a device address changes at an interval which is shorter than the cycle at which changes are reflected to the property of an object, those changes may not be reflected to the property. To reflect those changes to the property, keep the values of device addresses for 1 second. For example, the changes may not be reflected to the property when #M0000, which has been allocated to Present_Value of a Binary Input object, is turned on for only 10 msec. To reflect those changes to the property, ensure that #M0000 stays 1 for 1 second.

● Read Property Function

In the Read Property function, the MICRO/I returns the value of a property when there is a read property request from a BACnet device. This function is implemented using DS-RP-B (Data Sharing Read Property B) and DS-RPM-B (Data Sharing Read Property Multiple B).

The below diagram shows a BACnet device reading the analog input value of the MICRO/I that has been associated with the Analog Input object.

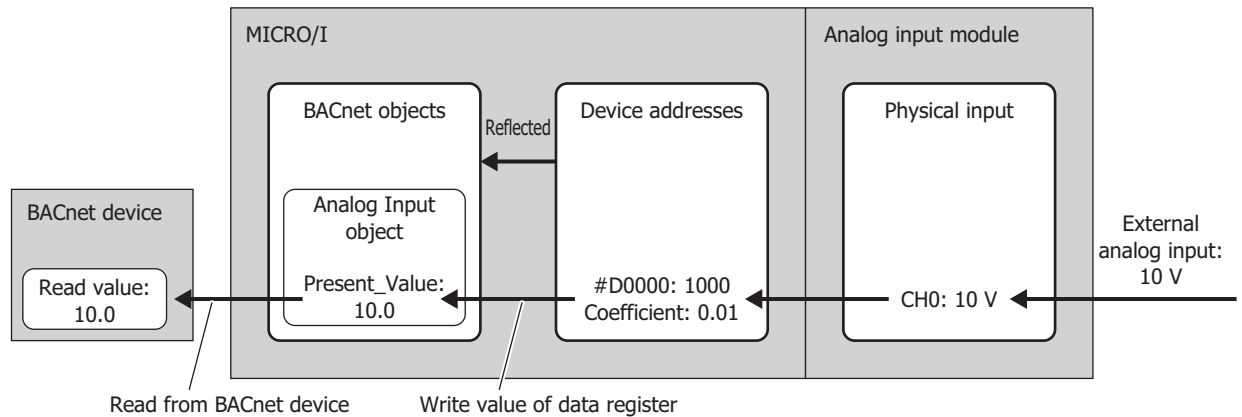

● Write Property Function

In the Write Property function, the MICRO/I writes a value to the property of an object when there is a write property request from a BACnet device. This function is implemented using DS-WP-B (Data Sharing Write Property B) and DS-WPM-B (Data Sharing Read Property Multiple B).

The below diagram shows a BACnet device changing the analog output value of the MICRO/I that has been associated with the Analog Output object.

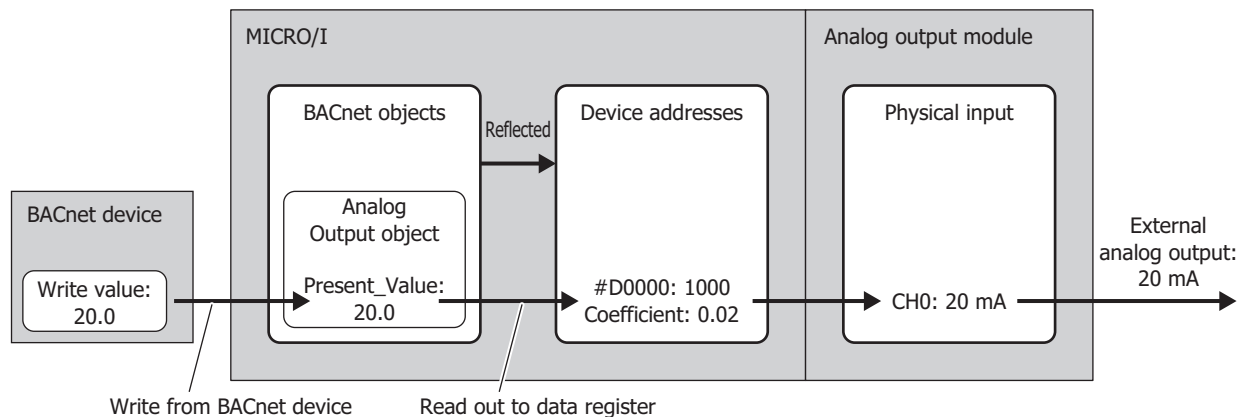

● Subscribed COV (COV) function

In the COV (Change Of Value) function, the MICRO/I monitors an object for which a report request has been received from a BACnet device. Then when Present_Value or Status_Flags has changed, the MICRO/I notifies the BACnet device of the change.

The properties of objects that correspond to the COV function and the timing of when to provide notification of changes are given as follows.

Object	Properties	Timing to Provide Notification of Change
Analog Input Analog Output Analog Value	Present_Value Status_Flags	Notification of change is provided when (1) or (2) as follows. When Present_Value has changed to a value greater than or equal to the value set for COV_Increment (starting point is from when the previous COV notification was sent)*1 (1) set for COV_Increment (starting point is from when the previous COV notification was sent)*1 (2) When any of the bits in Status_Flags have changed
Binary Input Binary Output Binary Value	Present_Value Status_Flags	Notification of change is provided when (1) or (2) as follows. (1) When Present_Value has changed (2) When any of the bits in Status_Flags have changed



Notification may not be provided for changes in values that are faster than the synchronization cycle of objects and device addresses.

*1 For example, the following diagram shows when a report request is received from a BACnet device and AI-10 (Analog Input object, instance number 10) has the status in the following table.

AI-10 Properties	Value
Present_Value	10.0
COV_Increment	3.0

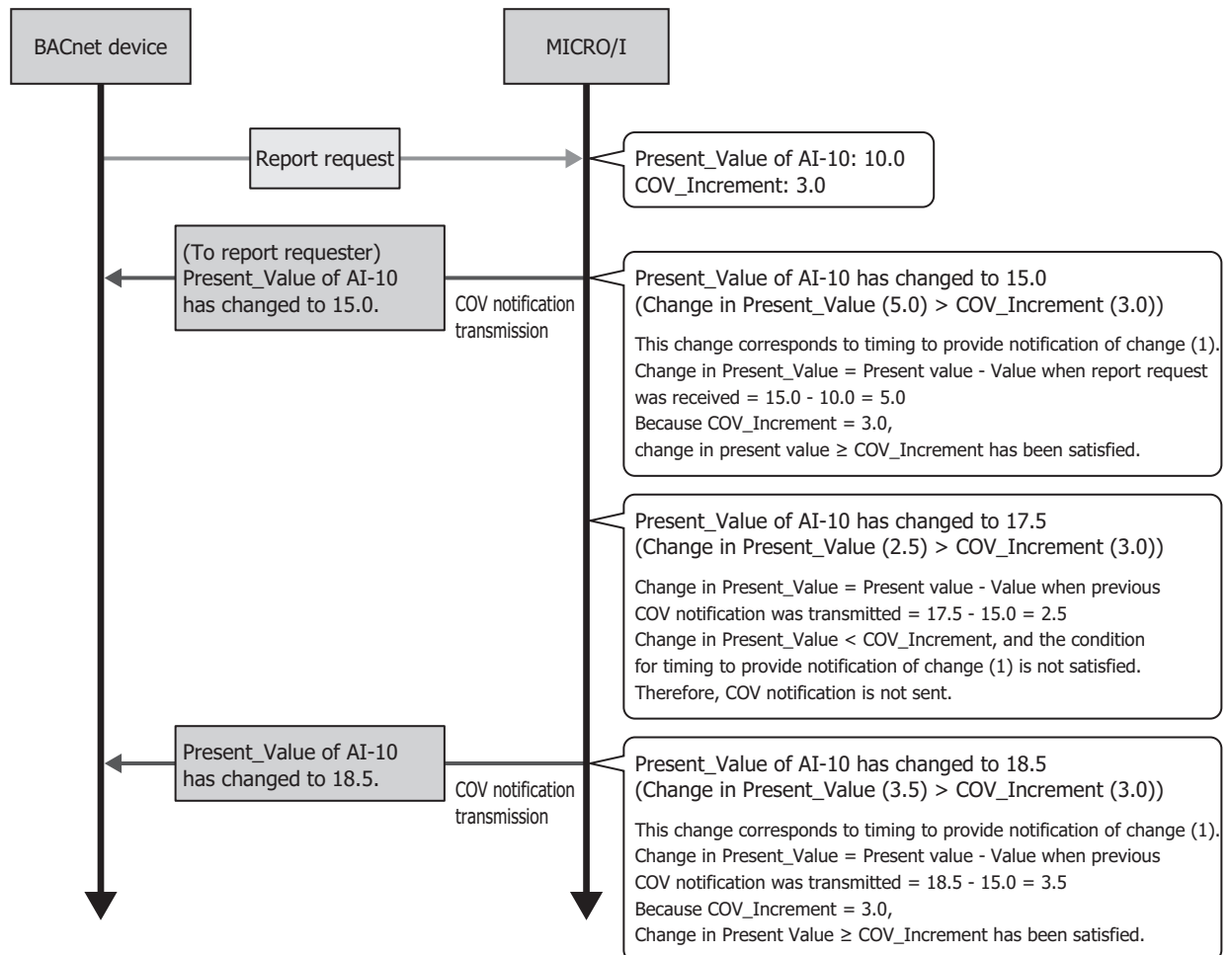

The MICRO/I implements the COV function by sending the Confirmed COV Notification service or Unconfirmed COV Notification service to the report requesting BACnet device according to the parameters contained in the report request when that report request (Subscribe COV service) was transmitted from the BACnet device.

The key parameters contained in the report request are as follows.

Parameters	Description
Monitored Object Identifier	Type and ID of object for which to enable the COV function.
Issue Confirmed Notifications	Selects whether or not to confirm messages that will be sent from the MICRO/I to the BACnet device. <ul style="list-style-type: none"> •With confirmation (ConfirmedCOVNotification) •Without confirmation (UnconfirmedCOVNotification)
Lifetime	The time to enable the COV function in 1 sec increments. If 0 or omitted, the COV function is enabled with no time limit.

The following diagram shows when the MICRO/I has received a report request transmitted from a BACnet device like that in the following table.

Report Request Parameters	Description
Monitored Object Identifier	Analog Input object (instant number: 10)
Issue Confirmed Notifications	With confirmation (ConfirmedCOVNotification)
Lifetime	360 sec

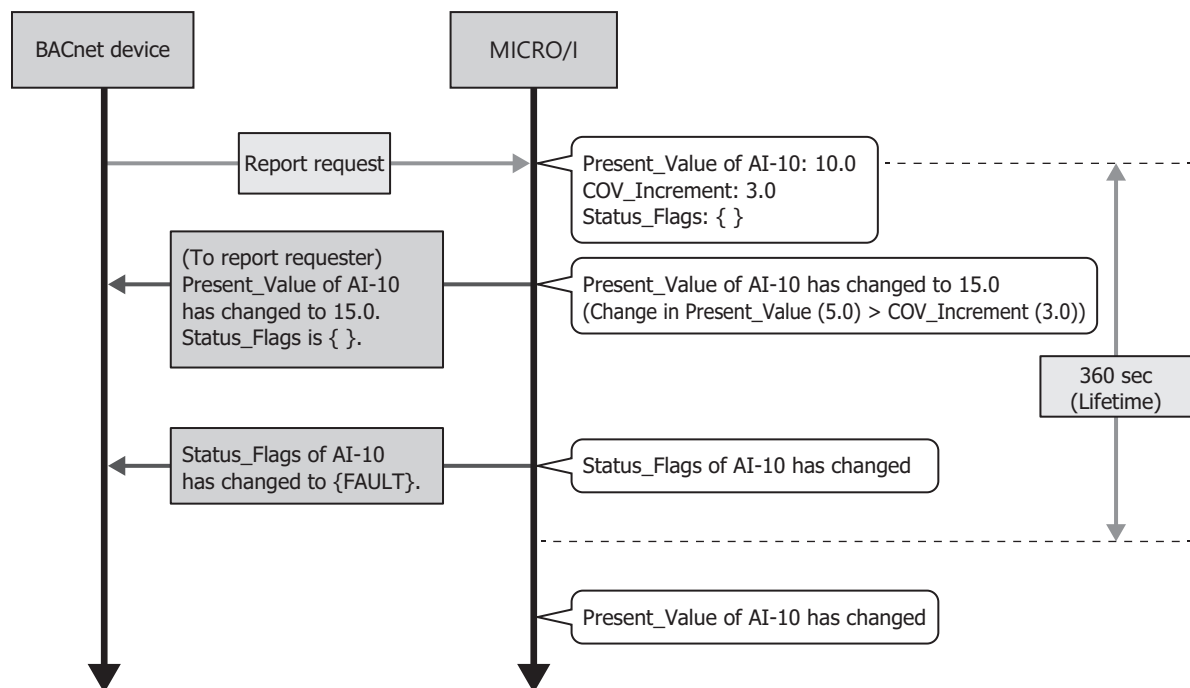

The maximum number of COVs that can be registered is 256.

For details on the parameters in a response request, refer to "BACnet Building Automation Data Communication Protocol", a book published by the Institute of Electrical Installation Engineers of Japan.

● Unsubscribed COV (COVU) function

In the COVU (Change Of Value Unsubscribed) function, the MICRO/I spontaneously provides notification that Present_Value or Status_Flags of a specific object has changed to all BACnet devices connected to the same network.

The properties of objects that correspond to the COVU function and the timing of when to provide notification of changes are given as follows.

Object	Properties	Timing to Provide Notification of Change
Analog Input Analog Output Analog Value	Present_Value Status_Flags	Notification of the status is provided at the interval of the Unsubscribed COV frequency* ¹ . Notification of change is also provided when (1) or (2) as follows. (1) When Present_Value has changed to a value greater than or equal to the value set for COV_Increment (starting point is from when the previous COV notification was sent) (2) When any of the bits in Status_Flags have changed
Binary Input Binary Output Binary Value	Present_Value Status_Flags	Notification of change is provided when (1) or (2) as follows. (1) When Present_Value has changed (2) When any of the bits in Status_Flags have changed

The MICRO/I implements the COVU function by sending the Unconfirmed COV Notification service to BACnet devices.

For example, when BACnet/IP is started with AI-10 (Analog Input object, instant number 10) having the status in the following table, notification is provided on the status of the properties at the set cycle (Unsubscribed COV frequency).

AI-10 Properties	Value
Present_Value	10.0
COV_Increment	3.0
Status_Flags	{ }

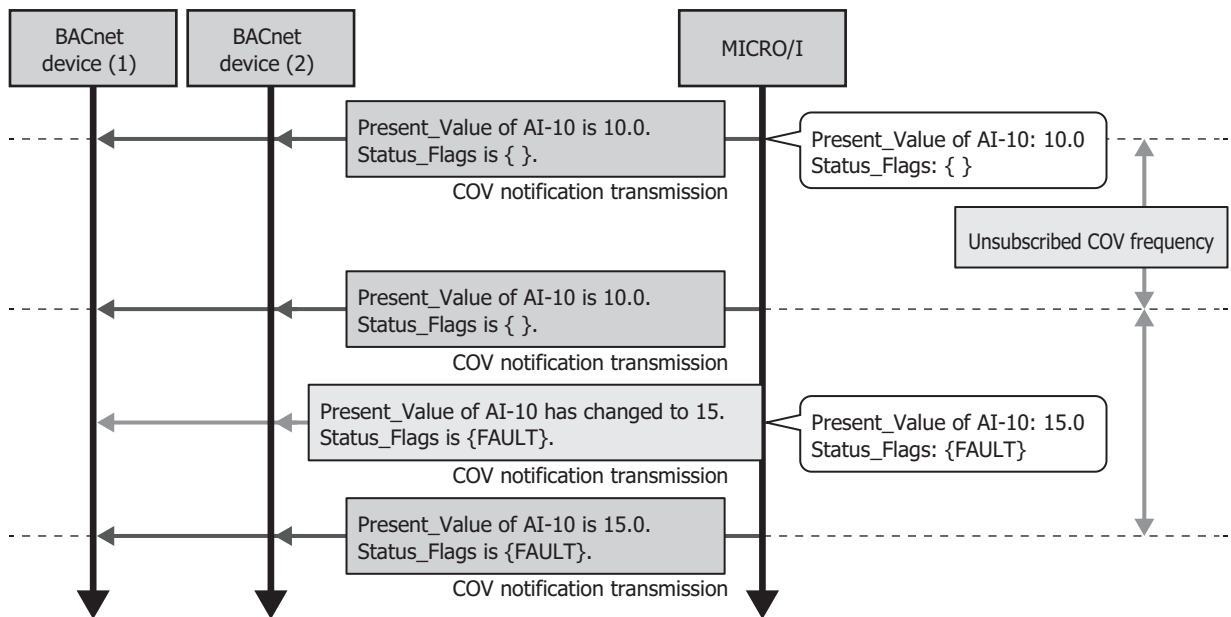

- When using the COVU function, the values of properties can be regularly sent to BACnet devices, regardless of any change in the value of the properties.
- The COVU function can be set for each object.
- Only one Unsubscribed COV Frequency can be set for the MICRO/I. Different frequencies cannot be set for each object.
- If the Unsubscribed COV Frequency is set to 0, the COV function is stopped, and notification is provided only when there is a change in the target property.
- When the Unsubscribed COV frequency is changed by a device address, the change will be applied after the service is next initiated.
- Notification may not be provided for changes in values that are faster than the synchronization cycle of objects and device addresses.

*1 Refer to "BACnet/IP Settings" on page 3-108.

● Foreign device function

When the BACnet/IP network is built with multiple IP subnets, install one BBMD (BACnet Broadcast Management Device) on each IP subnet. A BBMD is a device that transfers broadcast communications of BACnet devices to different IP subnets. BACnet devices perform broadcast communications with BACnet devices on different IP subnets via BBMDs. The Foreign Device function is used for performing broadcast communications with BACnet devices on different IP subnets even when there is no BBMD on the IP subnet of the MICRO/I. Broadcast communications can be performed with a BACnet device on the BACnet/IP network by registering the MICRO/I as a foreign device for a specified BBMD.

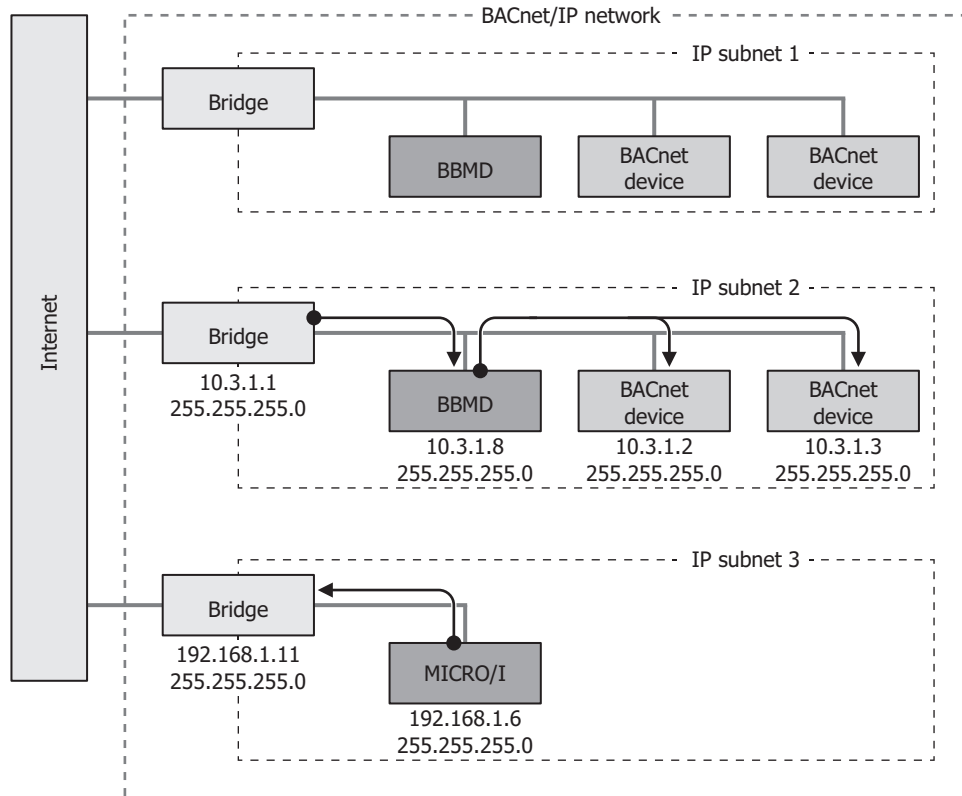

7.5 BACnet/IP Operation

BACnet/IP is enabled and disabled according to the value of HMI Special Internal Relay LSM70 (BACnet Communication Bit).

Properties with allocated device addresses work by referencing those device addresses.

When BACnet/IP is enabled and properties or the values of device addresses that are associated with properties are changed, they operate with the values after the change.

BACnet/IP	Properties with Allocated Device Addresses and the Values of Those Device Addresses
Enabled	Bound
Disabled	Not bound



When the status of the BACnet communication is stopped by error (the value of HMI Special Data Registers LSD260-3 is 1) and restarts the BACnet communication, set 0 to the value of HMI Special Internal Relay LSM70, and then set 1 to the value of HMI Special Internal Relay LSM70 after the status of the BACnet communication is stopped (the value of HMI Special Data Registers LSD260-0 is 1).

7.6 BACnet/IP Settings Procedure

This section describes the procedure for setting BACnet/IP.

- 1 On the **Configuration** tab, in the **System Setup** group, click **Project**.
The **Project Settings** dialog box is displayed.



- 2 Click the **BACnet/IP Settings** tab, select the **Use BACnet/IP** check box and click **Settings**.
The **BACnet Settings** dialog box is displayed.

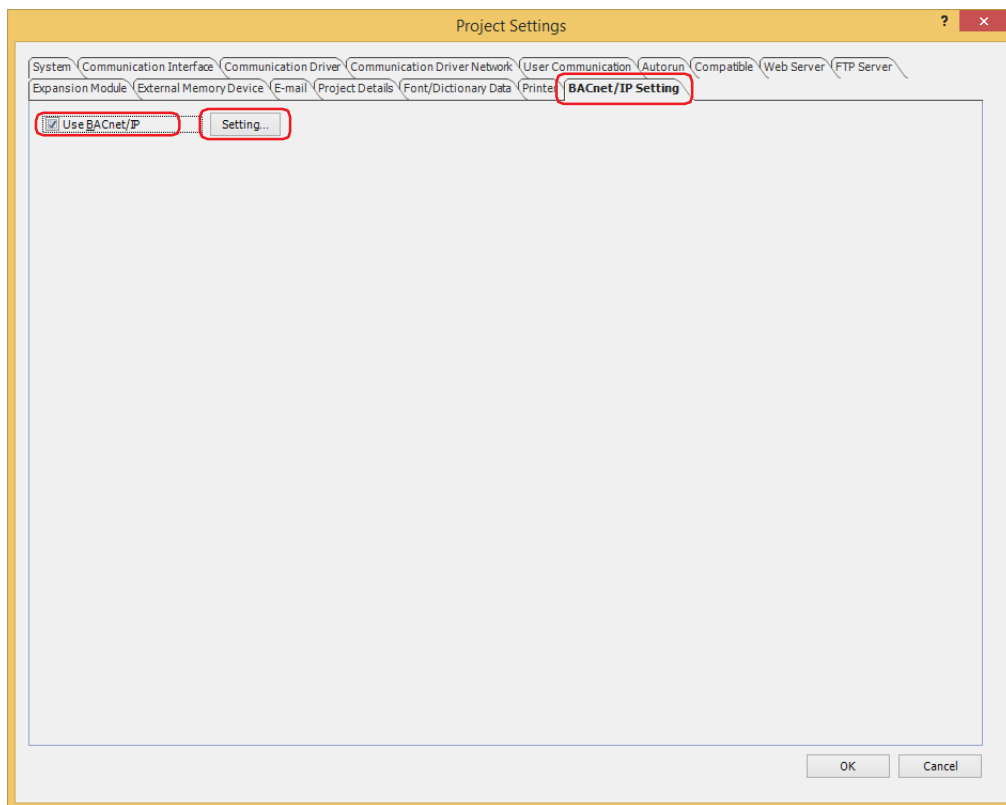

- 3 Configures a basic settings of BACnet/IP.
For details, refer to "BACnet/IP Settings" on page 3-108.

- 4 Adds a new object.
Click **New**.

The **New Object** dialog box is displayed.

The screenshot shows the 'BACnet Settings' dialog box. On the left, there is a sidebar with 'BACnet/IP Settings' and 'Object List'. The main area is divided into three sections: 'Basic Settings', 'COV Settings', and 'Foreign Device Settings'. The 'Basic Settings' section includes fields for Device ID (Fixed Value: 4194302), Port Number (Fixed Value: 47808), and checkboxes for 'Turn ON BACnet Communication bit (LSM 70) automatically' and 'Device Communication Control Password'. The 'COV Settings' section includes 'Unsubscribed COV Frequency (sec)' (Fixed Value: 60). The 'Foreign Device Settings' section includes a checked 'Enable Foreign Device' checkbox, 'BBMD IP Address' (Fixed Value: 0.0.0.0), 'BBMD Port Number' (Fixed Value: 47808), 'Lifetime (sec): 360', and 'Registration Trigger Device'. At the bottom, there are buttons for 'New', 'Delete', 'Export', 'Import', 'OK', and 'Cancel'. The 'New' button is highlighted with a red box.

- 5 Select the object type of the object to register, and assign it an instance number.

The screenshot shows the 'New Object' dialog box. It has two main input fields: 'Object Type' with a dropdown menu set to 'analog-input', and 'Instance Number' with a numeric spinner set to 1. Both fields are highlighted with red boxes. At the bottom, there are 'OK' and 'Cancel' buttons.

- 6 Click **OK**.

The new object is added to the object list.

- 7 Click the registered object ID in the object list.
The properties are displayed.

Property Name	Device Control	Initial Value	Device	Note
Object_Identifier	Disable	AT_1	Unavailable	
Object_Name	Disable	Analog Input 1	Unavailable	
Object_Type	Disable	analog-input	Unavailable	
Present_Value	Disable	0.0		
Description	Disable		Unavailable	
Device_Type	Disable		Unavailable	
Status_Flags	Disable	F,F,F,F		
Event_State	Disable	Normal	Unavailable	
Reliability	Disable	no-fault-detected		
Out_Of_Service	Disable	FALSE		
Units	Disable	meters-per-second-per-second	Unavailable	
Resolution	Disable	1E-06	Unavailable	
COV_Increment	Disable	1E-06	Unavailable	

Send Unsubscribed COV:

- 8 Configure the properties.
For details, refer to "Object List" on page 3-110.



The maximum number of objects that can be registered is 256.

- 9 Repeat steps 4 through 8 to set all the objects.
- 10 click **OK**.
This concludes configuring BACnet/IP.

7.7 BACnet Settings Dialog Box

This section describes items on the **BACnet Settings** dialog box.

● BACnet/IP Settings

■ Basic Settings

- Device ID:** The assigned ID used to identify BACnet devices on the BACnet/IP network. Configures the device ID in the range from 1 to 4,194,302.
- Fixed Value:** Specifies the Device ID as a constant. (Default: 4194301)
- Data Register:** Specifies the Device ID as a value of word device.
This option uses 2 words of address numbers starting from the specified data register.
- Port Number:** Configures the port number for performing BACnet Communication. Configures the port number in the range from 0 to 65,535.
- Fixed Value:** Specifies the port number as a constant. (Default: 47808)
- Data Register:** Specifies the port number as a value of word device.
- Turn ON BACnet Communication bit (LSM70) automatically:**
Configures whether or not to set 1 to the HMI Special Internal Relay LSM70 (BACnet Communication Bit) in the END processing of the first scan when starting operation.

LSM70 Status	BACnet/IP	Present_Value* ¹ and Device Address Value	Overridden Flag in Status_Flags* ²
1	Enabled	Bound	FALSE
0	Disabled	Not bound	—



When the following operations are performed, the value of the HMI Special Internal Relay LSM70 (BACnet Communication Bit) changes to 0.

- Downloads the project data.
- Turns off the MICRO/I.
- Switches to System Mode.

*1 For Present_Value, refer to "7.8 Objects" on page 3-124 and "Present_Value" on page 3-132.

*2 For Status_Flags, refer to "7.8 Objects" on page 3-124 and "Status_Flags" on page 3-145.

Device Communication Control Password:

Configures the password to request when the Device Communication Control service is received from a BACnet device. The maximum number is 20 characters. When the Device Communication Control service is received, the MICRO/I does not initiate a service or provide a response for the specified period of time.

■ COV Settings

Unsubscribed COV Frequency (sec):

Configures the cycle to regularly provide notifications of property values with the COVU function as 1 to 65,535 (seconds). If 0 is set, the COVU function is stopped, and notification is provided only when there is a change in the target property.

Fixed Value: Specifies the interval as a constant. (Default: 60 sec)

Data Register: Specifies the interval as a value of word device.



- Only one Unsubscribed COV frequency can be set for the MICRO/I, and different frequencies cannot be set per object.
- Whether or not to use the COVU function can be selected per object. The COVU function can also be enabled and disabled by specifying a data register and changing its value.
- When changing the value of the data register, the Unsubscribed COV frequency after it has been changed will be applied after the service is next initiated.

■ Foreign Device Settings

Enable Foreign Device: Configures whether or not to use the Foreign Device function. Using the Foreign Device function, the MICRO/I registers itself as a Foreign Device on the configure BBMD.

BBMD IP Address: To join a BACnet/IP network when there is no BBMD on the IP subnet of the MICRO/I, configures the IP address of the BBMD on the other IP subnet.

Fixed Value: Specifies the IP address as a constant.

Data Register: Specifies the IP address as a value of word device.

This option uses 4 words of address numbers starting from the specified data register.

Example: Configures 192.168.2.5 to the IP address of the BBMD.

The address number of Top Device Address+0 = 192

The address number of Top Device Address+1 = 168

The address number of Top Device Address+2 = 2

The address number of Top Device Address+3 = 5

BBMD Port Number: To join a BACnet/IP network when there is no BBMD on the IP subnet of the MICRO/I, configures the port number of BBMD on other IP subnet from 1 to 65,535.

Fixed Value: Specifies the port number as a constant. (Default: 47808)

Data Register: Specifies the port number as a value of word device.

Lifetime (sec): Configures the interval of time to register the MICRO/I with the BBMD as a Foreign Device in the range from 0 to 65,535 (seconds). (Default: 360 sec)

When (Lifetime + 30) sec has elapsed from registration, the registered content will be deleted from the BBMD.

Registration Trigger Device: The device address used to register the MICRO/I with the BBMD configure with **BBMD IP Address** above as a Foreign Device. When the value of the **Registration Trigger Device** is changed from 0 to 1, the MICRO/I is registered with the BBMD. To continuously register the MICRO/I with the BBMD, use the **Registration Trigger Device** to re-register the MICRO/I before (Lifetime + 30) sec elapses.

● Object List

Select an object node to display the list of registered objects.

For example, select Analog Input to display the list of Analog Input objects, and select the object list node to display the list of all objects. The properties can also be changed when the list is displayed.

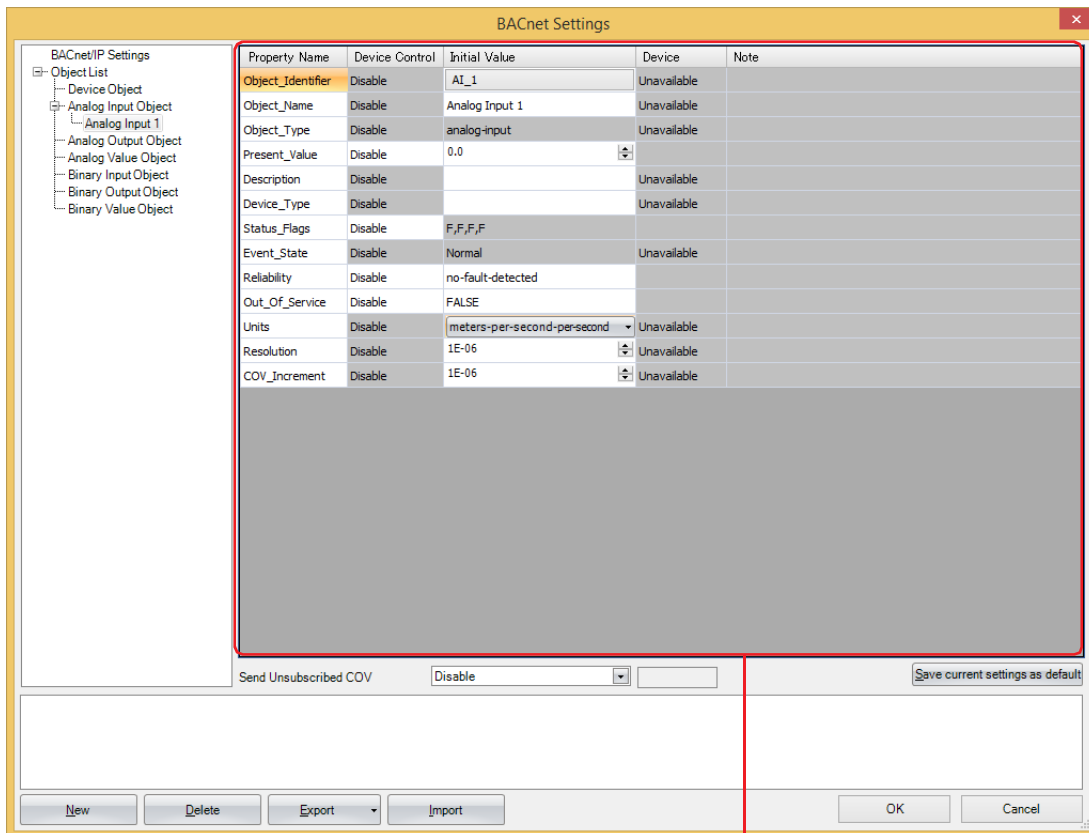

(Property settings)

■ (Property settings)

This area displays the properties of the object ID selected in the object list.

A portion of the properties can be edited.

■ Send Unsubscribed COV

Configures whether or not to send Unsubscribed COV.

- Enable: When the value of the HMI Special Internal Relay LSM70 (BACnet Communication Bit) is 1, the COVU function is always enabled and the Unconfirmed COV Notification service is sent.
- Disable: The COVU function is always disabled and the Unconfirmed COV Notification service is not sent.
- Control by device: Toggles between enabled and disabled with the value of device address. Specify the bit device or the bit number of the word device to use as the condition to switch between enabled and disabled.
- It is enabled when the value of device address changes from 0 to 1, and it is disabled when the value of device address changes from 1 to 0.

■ Save current settings as default

Saves the settings of the properties as the default values of the object.

■ New

Adds a new object.

Click **New** to display the **New Object** dialog box. Configures the object type and instance number (0 to 4,194,302). Ensures that objects of the same object type do not have the same instance number.

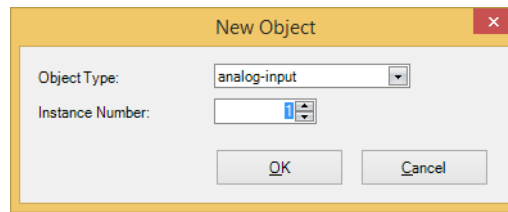
**■ Delete**

Deletes the object under the node selected in the object list.

■ Export

Exports the settings of the following objects as a CSV file.

Analog Input, Analog Output, Analog Value, Binary Input, Binary Output, Binary Value

■ Import

Imports a CSV file that was export and automatically creates objects.

Objects cannot be imported if the format of the CSV file is invalid or if the maximum number of objects has been reached.

● Present_Value Settings

This section describes how to configure Present_Value. Present_Value is a Float32(F) numeric value.

Analog Input Object

Use these settings to configure fixed values and device addresses for Present_Value of the Analog Input object.

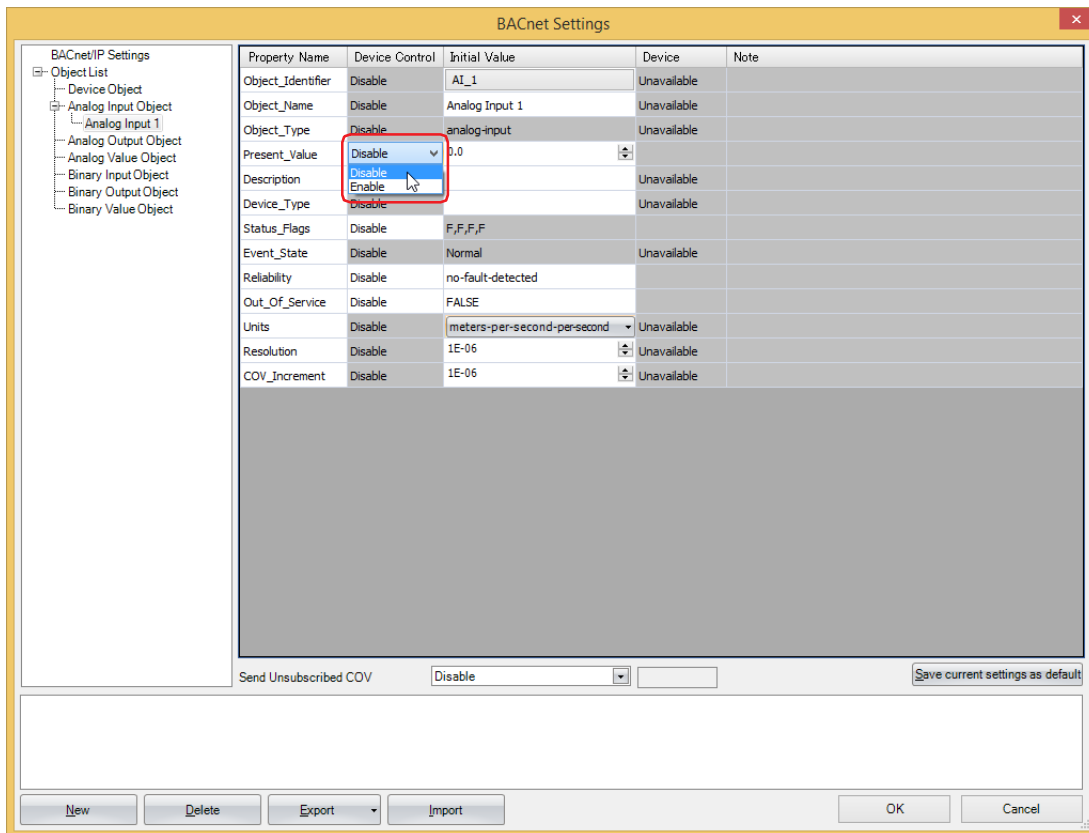

■ Device Control

Selects whether to set a fixed value for Present_Value or to allocate device addresses.

Enable: Specifies the Present_Value as a constant.

Disable: Specifies the Present_Value as a value of word device.

Configures a fixed value to Present_Value

Select **Disable** in the **Device Control** of **Present_Value**, enter a constant value for **Initial Value**.

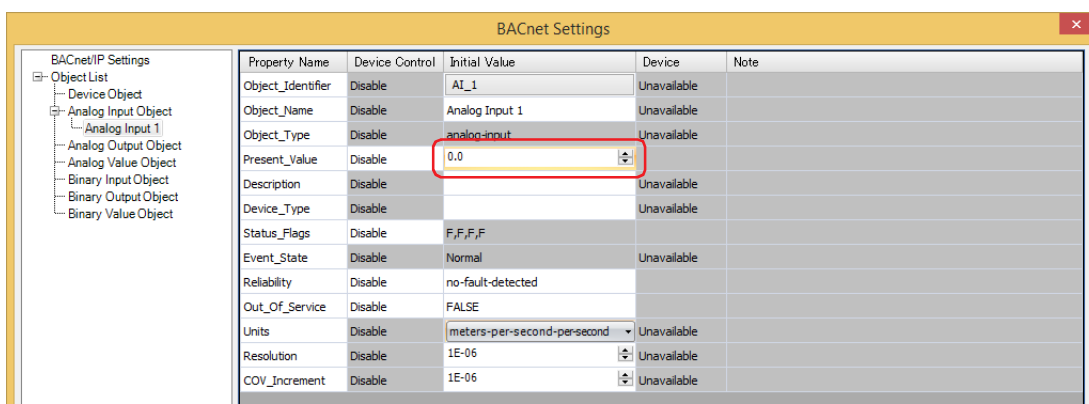

Allocate device addresses to Present_Value

Select **Enable** in the **Device Control** of **Present_Value**, and then click a button displayed in **Device** to display the **Present_Value Settings** dialog box. Configure the parameters in the **Present_Value Settings** dialog box.

■ Device for Present_Value

Configures the device address to store Present_Value.

According to **Conversion type**, 1 or 2 continuous words of address number are used starting from the specified address number of Device Address.

Device for Present_Value	Conversion type	Storage Destination
Present_Value for writing	UBIN16(W), BIN16(I)	The address number of Top Device Address+0
	UBIN32(D), BIN32(L), Float32(F)	The address number of Top Device Address+0, The address number of Top Device Address+1



Specify the Top Device Address so that the address number of device address is not exceeded.

■ Conversion type

Configures the data type of the device address to which Present_Value (float) is allocated. For details, refer to Present_Value in "Analog Input Object" on page 3-136.

■ Coefficient

Configures Present_Value as the product of the value stored in the device address multiplied by the coefficient.

$$\text{Present_Value} = \text{Value stored in the device address} \times \text{Coefficient}$$

Example:

Device Address	Data Type	Value	Coefficient	Present_Value
#D0000	UBIN16(W)	1000	0.01	10.0
#D0000, #D0001	Float32(F)	2.5	0.5	1.25

The coefficient is multiplied as a Float32(F) value. The conversion order is as follows.

Device Addresses → Present_Value

- (1) The value of the device addresses is converted to a Float32(F) value.
- (2) The coefficient is multiplied by the conversion result in (1).

Analog Output Object

Use these settings to configure devices for Present_Value of the Analog Output object.

The screenshot shows the 'BACnet Settings' dialog box. On the left is a tree view of object types, with 'Analog Output 1' selected. The main area is a table of properties for this object. The 'Present_Value' row is highlighted with a red box, indicating its 'Device Control' is 'Enable'. Other properties are mostly disabled.

Property Name	Device Control	Initial Value	Device	Note
Object_Identifier	Disable	AO_1	Unavailable	
Object_Name	Disable	Analog Output 1	Unavailable	
Object_Type	Disable	analog-output	Unavailable	
Present_Value	Enable			
Description	Disable		Unavailable	
Device_Type	Disable		Unavailable	
Status_Flags	Disable	F,F,F,F		
Event_State	Disable	Normal	Unavailable	
Reliability	Disable	no-fault-detected		
Out_Of_Service	Disable	FALSE		
Units	Disable	meters-per-second-per-second	Unavailable	
Resolution	Disable	1E-06	Unavailable	
Relinquish_Default	Disable	0.0	Unavailable	
COV_Increment	Disable	1E-06	Unavailable	
Priority_Array	Disable		Unavailable	

Below the table, there is a 'Send Unsubscribed COV' dropdown menu set to 'Disable' and a 'Save current settings as default' button. At the bottom of the dialog are buttons for 'New', 'Delete', 'Export', 'Import', 'OK', and 'Cancel'.

- **Device Control**

Device Control of **Present_Value** is **Enable**. A constant value cannot be configured for **Present_Value** of the Analog Output object.

Allocate device addresses to Present_Value

Configure the parameters in the **Present_Value Settings** dialog box.

■ Device for Present_Value

Configures the device address to store Present_Value.

According to **Conversion type**, 1 or 2 continuous words of address number are used starting from the specified address number of Device Address.

Device for Present_Value	Conversion type	Storage Destination
Present_Value for reading	UBIN16(W), BIN16(I)	The address number of Top Device Address+0
	UBIN32(D), BIN32(L), Float32(F)	The address number of Top Device Address+0, The address number of Top Device Address+1



Specify the Top Device Address so that the address number of device address is not exceeded.

■ Conversion type

Configures the data type of the device addresses to which Present_Value (float) is allocated. For details, refer to Present_Value in "Analog Output Object" on page 3-137.

■ Coefficient

The product of Present_Value multiplied by 1/coefficient multiplied is stored in the device addresses.

$$\text{Value of device addresses} = \text{Present_Value} \times (1/\text{coefficient})$$

Example:

Present_Value	Coefficient	Device Addresses	Data Type	Value
10.0	0.01	#D0000	UBIN16(W)	1000
1.25	0.5	#D0000, #D0001	Float32(F)	2.5

The coefficient is multiplied as a Float32(F) value. The conversion order is as follows.

Present_Value → Device Addresses

- (1) Present_Value is multiplied by (1/coefficient).
- (2) The data type of the result of (1) (Float32(F)) is converted.

Analog Value Object

Use these settings to configure device addresses for Present_Value of the Analog Value object.

The screenshot shows the 'BACnet Settings' dialog box. On the left is a tree view with the following structure:

- BACnet/IP Settings
 - Object List
 - Device Object
 - Analog Input Object
 - Analog Input 1
 - Analog Output Object
 - Analog Output 1
 - Analog Value Object
 - Analog Value 1
 - Binary Input Object
 - Binary Output Object
 - Binary Value Object

The main table contains the following data:

Property Name	Device Control	Initial Value	Device	Note
Object_Identifier	Disable	AV_1		Unavailable
Object_Name	Disable	Analog Value 1		Unavailable
Object_Type	Disable	analog-value		Unavailable
Present_Value	Enable			
Description	Disable			Unavailable
Status_Flags	Disable	F,F,F,F		Unavailable
Event_State	Disable	Normal		Unavailable
Reliability	Disable	no-fault-detected		Unavailable
Out_Of_Service	Disable	FALSE		Unavailable
Units	Disable	meters-per-second-persecond		Unavailable
Relinquish_Default	Disable	0.0		Unavailable
COV_Increment	Disable	1E-06		Unavailable
Resolution	Disable	1E-06		Unavailable
Priority_Array	Disable			Unavailable

Below the table, there is a 'Send Unsubscribed COV' dropdown menu set to 'Disable' and a 'Save current settings as default' button. At the bottom of the dialog are buttons for 'New', 'Delete', 'Export', 'Import', 'OK', and 'Cancel'.

- **Device Control**

Device Control of **Present_Value** is **Enable**. A constant value cannot be configured for **Present_Value** of the Analog Value object.

Allocate device addresses to Present_Value

Configure the parameters in the **Present_Value Settings** dialog box.

■ Device for Present_Value

Configures the device address for reading Present_Value and the device address for writing Present_Value.

The device address for reading Present_Value and writing Present_Value are automatically assigned according to the configured device address and **Conversion type**. Starting from the specified address number of Device Address, 2 or 4 continuous words of address number are used.

Device for Present_Value	Conversion type	Storage Destination
Present_Value for reading	UBIN16(W), BIN16(I)	The address number of Top Device Address+0
	UBIN32(D), BIN32(L), Float32(F)	The address number of Top Device Address+0, The address number of Top Device Address+1
Present_Value for writing	UBIN16(W), BIN16(I)	The address number of Top Device Address+1
	UBIN32(D), BIN32(L), Float32(F)	The address number of Top Device Address+2, The address number of Top Device Address+3



Specify the Top Device Address so that the address number of device address is not exceeded.

■ Top device for priority and trigger

Use this device address when writing the value of the device addresses to Present_Value. For details, refer to Present_Value in "Analog Value Object" on page 3-138.

Device for priority and Device for write trigger are automatically assigned when the device address is set. Starting from the specified address number of Device Address, 2 continuous words of address number are used.

MICRO/I	Storage Destination	Description
Device for priority	The address number of Top Device Address+0	Bit 15: 0: the value of the Present_Value for writing. 1: NULL(00h). Bits 14 to 5: Disabled Bits 4 to 0: Priority ^{*1}
Device for write trigger	The address number of Top Device Address+1	When the value changes from 0 to 1, writes a value to Priority_Array of index number indicated by the priority (bit 4 to 0 of Device for priority). The value to be written varies based on the value of bit 15 of Device for priority.



Specify the Top Device Address so that the address number of device address is not exceeded.

*1 Specify the priority between 1 and 16. If the priority is out of range, nothing is executed even when the value of Device for write trigger changes from 0 to 1.

■ Conversion type

Configures the data type of the device address to which Present_Value is allocated. For details, refer to Present_Value in "Analog Value Object" on page 3-138.

■ Coefficient

The product of Present_Value multiplied by 1/coefficient is stored in the device addresses allocated as Present_Value for reading.

$$\text{Present_Value for reading} = \text{Present_Value} \times (1/\text{coefficient})$$

When the device for write trigger is changed from 0 to 1, the product of multiplying the value of the device addresses allocated as Present_Value for writing by the coefficient is set as Present_Value.

$$\text{Present_Value} = \text{Present_Value for writing} \times \text{Coefficient}$$

Present_Value	Coefficient	Conversion Type	Device Addresses Allocated as Present_Value for Reading or Writing	
			Device Addresses	Value
10.0	0.01	UBIN16(W)	#D0000	1000
1.25	0.5	Float32(F)	#D0000, #D0001	2.5

The coefficient is multiplied as a float-type value. The conversion order is as follows.

Present_Value → Device Addresses

- (1) Present_Value is multiplied by (1/coefficient).
- (2) The data type of the result of (1) (Float32(F)) is converted.

Device Addresses → Present_Value

- (1) The value of the device addresses is converted to a Float32(F) value.
- (2) The coefficient is multiplied by the conversion result in (1).

Binary Input Object

Use these settings to configure fixed values and device addresses for Present_Value of the Binary Input object.

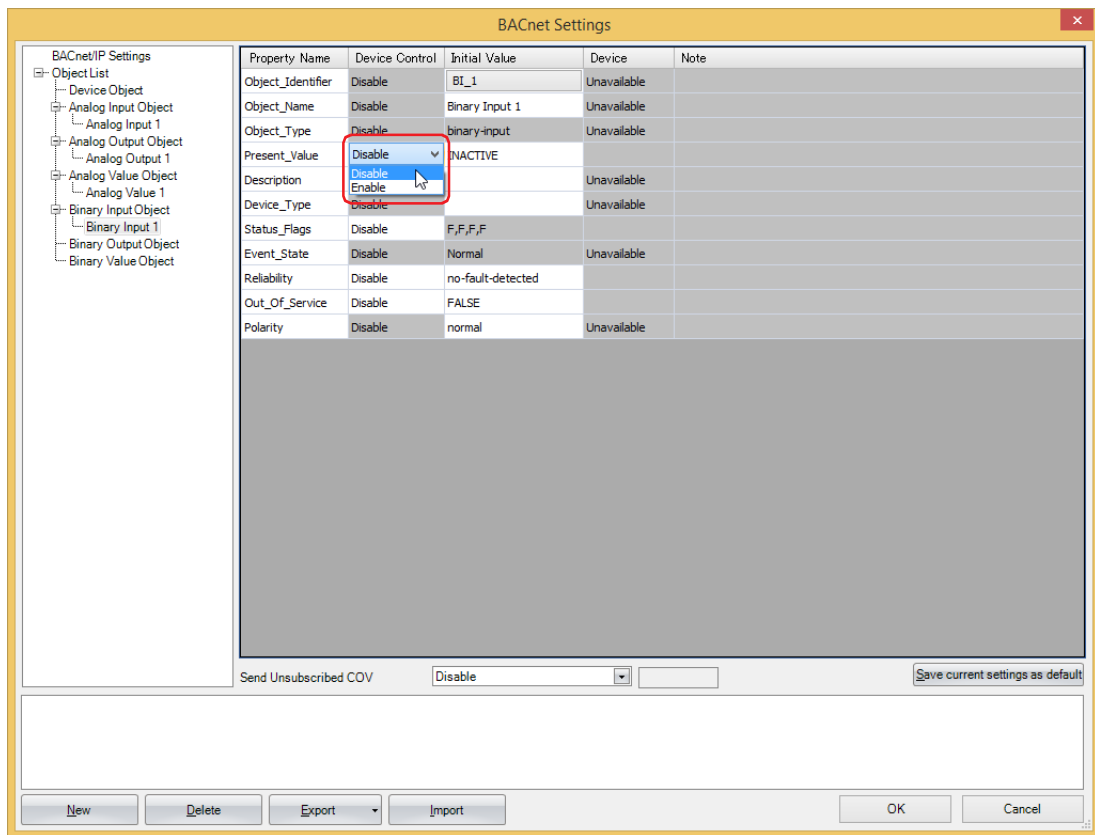

■ Device Control

Selects whether to set a fixed value for Present_Value or to allocate device addresses.

Enable: Specifies the Present_Value as a constant.

Disable: Specifies the Present_Value as a value of word device.

Configures a fixed value to Present_Value

Select **Disable** in the **Device Control** of **Present_Value**, and then select **INACTIVE** or **ACTIVE** for **Initial Value**.

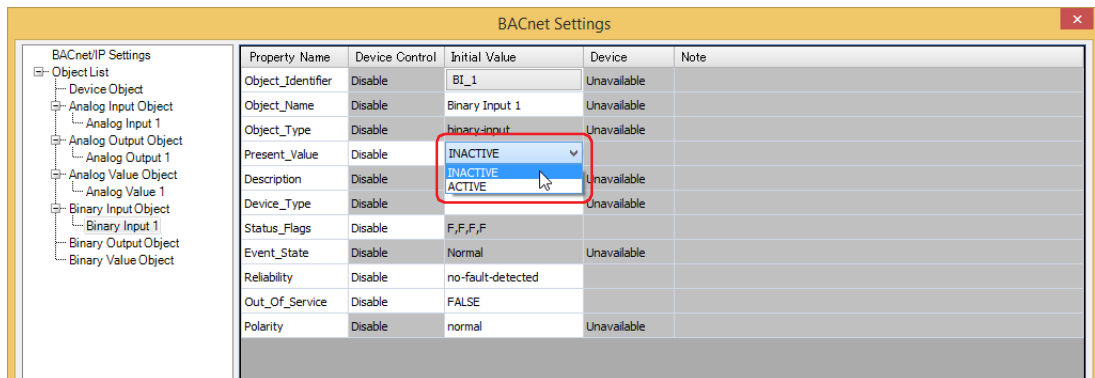

Allocate device addresses to Present_Value

Select **Enable** in the **Device Control** of **Present_Value**, and then click a button displayed in **Device** to display the **Present_Value Settings** dialog box. Configure the parameters in the **Present_Value Settings** dialog box.

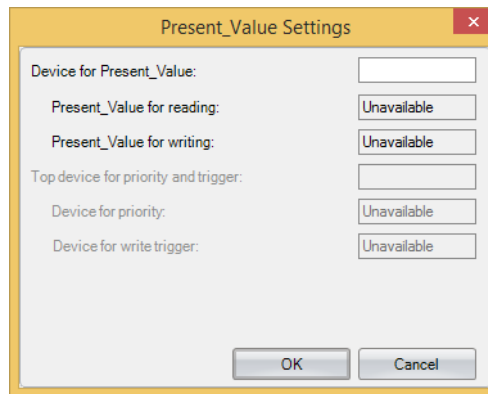

The image shows a dialog box titled "Present_Value Settings" with a close button (X) in the top right corner. The dialog contains several configuration fields:

- Device for Present_Value: [Empty text box]
- Present_Value for reading: [Unavailable button]
- Present_Value for writing: [Unavailable button]
- Top device for priority and trigger: [Empty text box]
- Device for priority: [Unavailable button]
- Device for write trigger: [Unavailable button]

At the bottom of the dialog are two buttons: "OK" and "Cancel".

■ Device for Present_Value

Configures the device address to store Present_Value.

Binary Output Object

Use these settings to configure device addresses for Present_Value of the Binary Output object.

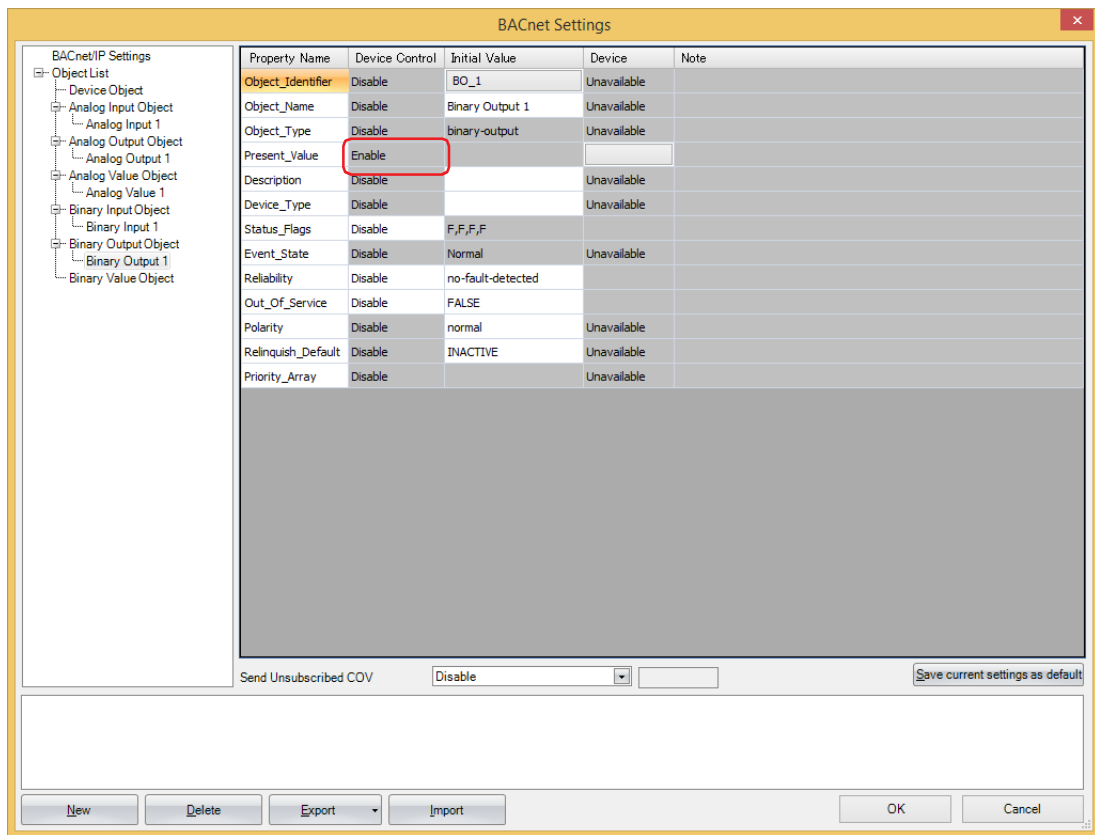

■ Device Control

Device Control of **Present_Value** is **Enable**. A constant value cannot be configured for **Present_Value** of the Binary Output object.

Allocate device addresses to Present_Value

Configure the parameters in the **Present_Value Settings** dialog box.

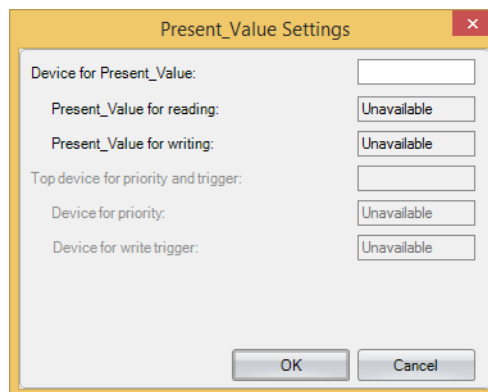

■ Device for Present_Value

Configures the device address to store Present_Value.

Binary Value Object

Use these settings to configure device addresses for Present_Value of the Binary Value object.

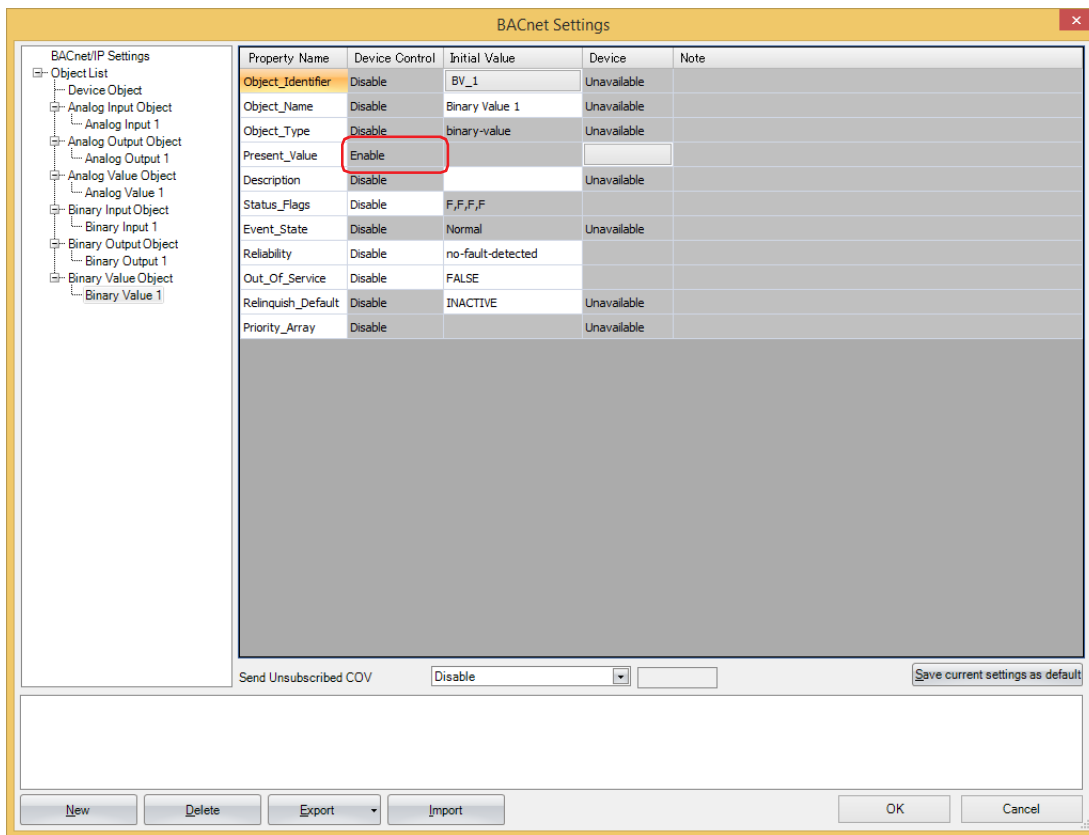

■ Device Control

Device Control of **Present_Value** is **Enable**. A constant value cannot be configured for **Present_Value** of the Binary Value object.

Allocate device addresses to Present_Value

Configure the parameters in the **Present_Value Settings** dialog box.

■ Device for Present_Value

Configures the device address for reading Present_Value and the device for writing Present_Value.

The devices for reading Present_Value and writing Present_Value are automatically assigned according to the set device address. Starting from the specified address number of Device Address, 2 bits of address number are used.

Device for Present_Value	Storage Destination
Present_Value for reading	The address number of Top Device Address+0
Present_Value for writing	The address number of Top Device Address+1



Specify the Top Device Address so that the address number of device address is not exceeded.

■ Top device for priority and trigger

Use this device address when writing the value of the device addresses to Present_Value. For details, refer to Present_Value in "Binary Value Object" on page 3-143.

Device for priority and Device for write trigger are automatically assigned when the device address is set. Starting from the specified address number of Device Address, 2 continuous words of address number are used.

MICRO/I	Storage Destination	Description
Device for priority	The address number of Top Device Address+0	Bit 15: 0: the value of the Present_Value for writing. 1: NULL(00h). Bits 14 to 5: Disabled Bits 4 to 0: Priority* ¹
Device for write trigger	The address number of Top Device Address+1	When the value changes from 0 to 1, writes a value to Priority_Array of index number indicated by the priority (bit 4 to 0 of Device for priority). The value to be written varies based on the value of bit 15 of Device for priority.



Specify the Top Device Address so that the address number of device address is not exceeded.

*1 Specify the priority between 1 and 16. If the priority is out of range, If the value of Device for write trigger changes from 0 to 1, then nothing is executed.

7.8 Objects

The MICRO/I holds objects registered with WindO/I-NV4 in internal memory. Part of the properties of the object can be allocated to the device address, and the value of the device address can be written and read. BACnet devices can read and write the properties of objects on the MICRO/I using services.

Properties of objects on the MICRO/I and values of device addresses allocated to properties are continually synchronized.

For how to register objects using WindO/I-NV4, refer to "7.6 BACnet/IP Settings Procedure" on page 3-105. The maximum number of objects that can be registered is 256.

The following diagram shows two concepts.

- (1) The BACnet device reads the analog input value of the Analog Input object.
- (2) The BACnet device writes the analog output value of the Analog Output object.

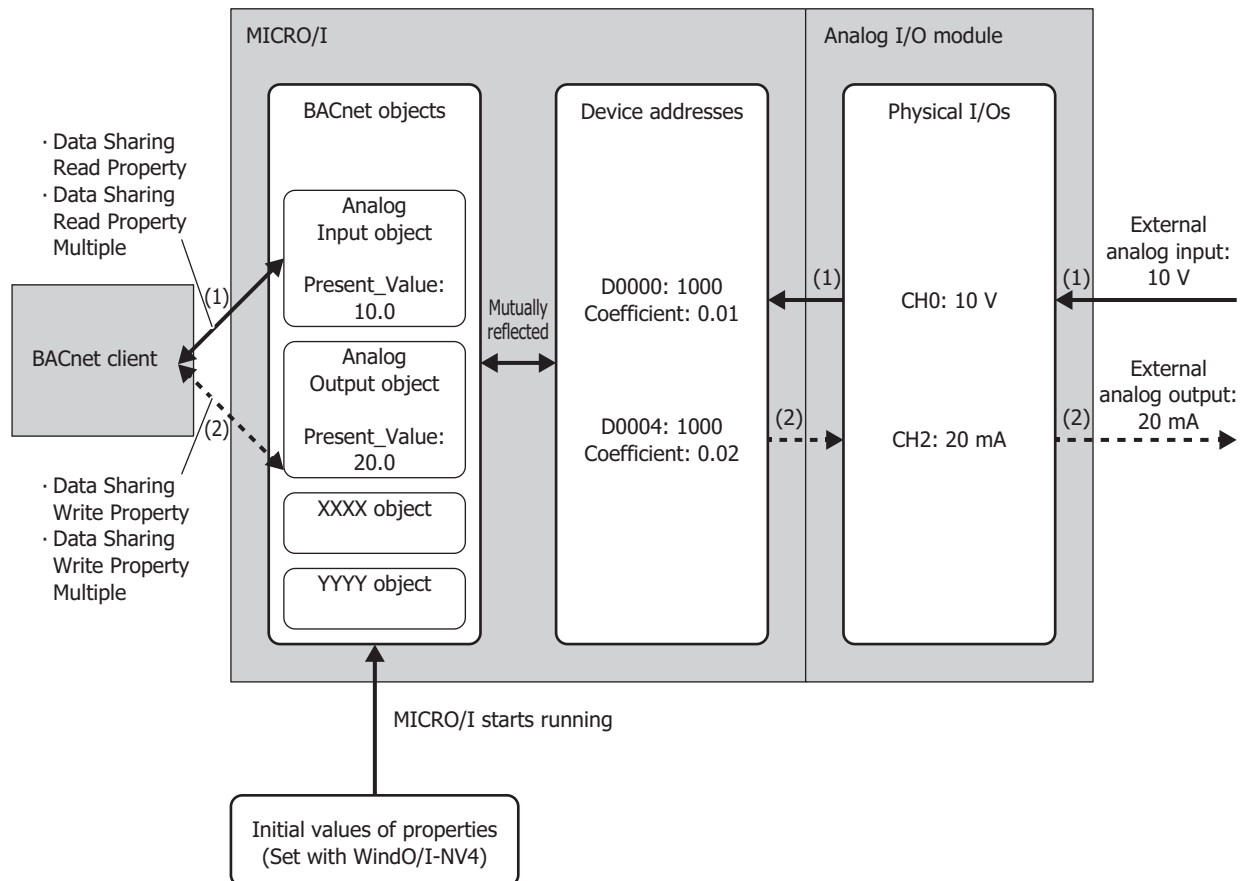

For details on properties held by objects, refer to "BACnet Building Automation Data Communication Protocol", a book published by the Institute of Electrical Installation Engineers of Japan.

● Analog Input Object

This object manages a Float32(F) numeric value. The MICRO/I can make arbitrary numeric values available to BACnet devices. For example, use this object when handling analog values input with the analog input module, the measured room temperature, and other analog values.

Properties List

(1): Read and write from BACnet devices

(2): Read and write from device addresses when properties are allocated to device addresses

R: Read-only, W: Write-only, R/W: Read and write, -: Not Read and write

Property Identifier	Data Type of Property	(1)	(2)	Comments
Object_Identifier	BACnetObjectIdentifier	R	-	Set a fixed value with WindO/I-NV4.
Object_Name	Character string* ¹	R	-	Set a fixed value with WindO/I-NV4.
Object_Type	BACnetObjectType	R	-	Set a fixed value with WindO/I-NV4.
Present_Value	Real number	R	W	Refer to "Present_Value" on page 3-132.
Description	Character string* ¹	R	-	Set a fixed value with WindO/I-NV4.
Device_Type	Character string* ¹	R	-	Set a fixed value with WindO/I-NV4.
Status_Flags	BACnetStatus_Flags	R	R	Refer to "Status_Flags" on page 3-145.
Event_State	BACnetEventState	R	-	Normal (fixed).
Reliability	BACnetReliability	R	R/W	Indicates whether or not the value of Present_Value is reliable.
Out_Of_Service	Logical value	R/W	R/W	Refer to "Out_Of_Service" on page 3-146.
Units	BACnetEngineeringUnits	R/W	-	Set the initial value with WindO/I-NV4.
Resolution	Real number	R	-	Set a fixed value with WindO/I-NV4.
COV_Increment	Real number	R/W	-	Refer to "COV_Increment" on page 3-145.
Property_List* ²	BACnetARRAY[N] of type BACnetPropertyIdentifier	R	-	Cannot be edited with WindO/I-NV4.

*1 Character encoding is ISO 10646 (UTF-8), and the maximum size is 64 bytes.

*2 Cannot be displayed on WindO/I-NV4.

● Analog Output Object

This object manages a Float32(F) numeric value. The MICRO/I can receive arbitrary numeric values from BACnet devices. For example, this object is used when receiving analog values such as those values that are output with the analog output module and temperature set points used as operating parameters from BACnet devices.

Properties List

(1): Read and write from BACnet devices

(2): Read and write from device addresses when properties are allocated to device addresses

R: Read-only, W: Write-only, R/W: Read and write, -: Not Read and write

Property Identifier	Data Type of Property	(1)	(2)	Comments
Object_Identifier	BACnetObjectIdentifier	R	-	Set a fixed value with WindO/I-NV4.
Object_Name	Character string ^{*1}	R	-	Set a fixed value with WindO/I-NV4.
Object_Type	BACnetObjectType	R	-	Set a fixed value with WindO/I-NV4.
Present_Value	Real number	R	R	Refer to "Present_Value" on page 3-132.
Description	Character string ^{*1}	R	-	Set a fixed value with WindO/I-NV4.
Device_Type	Character string ^{*1}	R	-	Set a fixed value with WindO/I-NV4.
Status_Flags	BACnetStatus_Flags	R	R	Refer to "Status_Flags" on page 3-145.
Event_State	BACnetEventState	R	-	Normal (fixed).
Reliability	BACnetReliability	R	R/W	Indicates whether or not the value of Present_Value is reliable.
Out_Of_Service	Logical value	R/W	R/W	Refer to "Out_Of_Service" on page 3-146.
Units	BACnetEngineeringUnits	R/W	-	Set the initial value with WindO/I-NV4.
Resolution	Real number	R	-	Set a fixed value with WindO/I-NV4.
Priority_Array	BACnetPriority_Array	R/W	-	Refer to "Priority_Array" on page 3-145.
Relinquish_Default	Real number	R/W	-	Refer to "Relinquish_Default" on page 3-145.
COV_Increment	Real number	R/W	-	Refer to "COV_Increment" on page 3-145.
Property_List ^{*2}	BACnetARRAY[N] of type BACnetPropertyIdentifier	R	-	Cannot be edited with WindO/I-NV4.

*1 Character encoding is ISO 10646 (UTF-8), and the maximum size is 64 bytes.

*2 Cannot be displayed on WindO/I-NV4.

● Analog Value Object

This object can be used in the same manner as the Analog Input object and Analog Output object.

Properties List

(1): Read and write from BACnet devices

(2): Read and write from device addresses when properties are allocated to device addresses

R: Read-only, W: Write-only, R/W: Read and write, -: Not Read and write

Property Identifier	Data Type of Property	(1)	(2)	Comments
Object_Identifier	BACnetObjectIdentifier	R	-	Set a fixed value with WindO/I-NV4.
Object_Name	Character string*1	R	-	Set a fixed value with WindO/I-NV4.
Object_Type	BACnetObjectType	R	-	Set a fixed value with WindO/I-NV4.
Present_Value	Real number	R	R	Refer to "Present_Value" on page 3-132.
Description	Character string*1	R	-	Set a fixed value with WindO/I-NV4.
Status_Flags	BACnetStatus_Flags	R	R	Refer to "Status_Flags" on page 3-145.
Event_State	BACnetEventState	R	-	Normal (fixed).
Reliability	BACnetReliability	R	R/W	Indicates whether or not Present_Value is reliable.
Out_Of_Service	Logical value	R/W	R/W	Refer to "Out_Of_Service" on page 3-146.
Units	BACnetEngineeringUnits	R/W	-	Set the initial value with WindO/I-NV4.
Priority_Array	BACnetPriority_Array	R/W	R/W	Refer to "Priority_Array" on page 3-145.
Relinquish_Default	Real number	R/W	-	Refer to "Relinquish_Default" on page 3-145.
COV_Increment	Real number	R/W	-	Refer to "COV_Increment" on page 3-145.
Resolution	Real number	R	-	Set a fixed value with WindO/I-NV4.
Property_List*2	BACnetARRAY[N] of type BACnetPropertyIdentifier	R	-	Cannot be edited with WindO/I-NV4.

*1 Character encoding is ISO 10646 (UTF-8), and the maximum size is 64 bytes.

*2 Cannot be displayed on WindO/I-NV4.

● Binary Input Object

This object manages a binary value (on/off). Use this object when the MICRO/I makes binary values available to BACnet devices.

Properties List

(1): Read and write from BACnet devices

(2): Read and write from device addresses when properties are allocated to device addresses

R: Read-only, W: Write-only, R/W: Read and write, -: Not Read and write

Property Identifier	Data Type of Property	(1)	(2)	Comments
Object_Identifier	BACnetObjectIdentifier	R	-	Set a fixed value with WindO/I-NV4.
Object_Name	Character string ^{*1}	R	-	Set a fixed value with WindO/I-NV4.
Object_Type	BACnetObjectType	R	-	Set a fixed value with WindO/I-NV4.
Present_Value	BACnetBinaryPV	R	W	Refer to "Present_Value" on page 3-132.
Description	Character string ^{*1}	R	-	Set a fixed value with WindO/I-NV4.
Device_Type	Character string ^{*1}	R	-	Set a fixed value with WindO/I-NV4.
Status_Flags	BACnetStatus_Flags	R	R	Refer to "Status_Flags" on page 3-145.
Event_State	BACnetEventState	R	-	Normal (fixed).
Reliability	BACnetReliability	R	R/W	Indicates whether or not the value of Present_Value is reliable.
Out_Of_Service	Logical value	R/W	R/W	Refer to "Out_Of_Service" on page 3-146.
Polarity	BACnetPolarity	R/W	-	Refer to "Polarity" on page 3-145.
Property_List ^{*2}	BACnetARRAY[N] of type BACnetPropertyIdentifier	R	-	Cannot be edited with WindO/I-NV4.

*1 Character encoding is ISO 10646 (UTF-8), and the maximum size is 64 bytes.

*2 Cannot be displayed on WindO/I-NV4.

● Binary Output Object

This object manages a binary value (on/off). Use this object when the MICRO/I receives binary values from BACnet devices.

Properties List

(1): Read and write from BACnet devices

(2): Read and write from device addresses when properties are allocated to device addresses

R: Read-only, W: Write-only, R/W: Read and write, -: Not Read and write

Property Identifier	Data Type of Property	(1)	(2)	Comments
Object_Identifier	BACnetObjectIdentifier	R	-	Set a fixed value with WindO/I-NV4.
Object_Name	Character string* ¹	R	-	Set a fixed value with WindO/I-NV4.
Object_Type	BACnetObjectType	R	-	Set a fixed value with WindO/I-NV4.
Present_Value	BACnetBinaryPV	R	R	Refer to "Present_Value" on page 3-132.
Description	Character string* ¹	R	-	Set a fixed value with WindO/I-NV4.
Device_Type	Character string* ¹	R	-	Set a fixed value with WindO/I-NV4.
Status_Flags	BACnetStatus_Flags	R	R	Refer to "Status_Flags" on page 3-145.
Event_State	BACnetEventState	R	-	Normal (fixed).
Reliability	BACnetReliability	R	R/W	Indicates whether or not the value of Present_Value is reliable.
Out_Of_Service	Logical value	R/W	R/W	Refer to "Out_Of_Service" on page 3-146.
Polarity	BACnetPolarity	R/W	-	Refer to "Polarity" on page 3-145.
Priority_Array	BACnetPriority_Array	R/W	-	Refer to "Priority_Array" on page 3-145.
Relinquish_Default	BACnetBinaryPV	R/W	-	Refer to "Relinquish_Default" on page 3-145.
Property_List* ²	BACnetARRAY[N] of type BACnetPropertyIdentifier	R	-	Cannot be edited with WindO/I-NV4.

*1 Character encoding is ISO 10646 (UTF-8), and the maximum size is 64 bytes.

*2 Cannot be displayed on WindO/I-NV4.

● Binary Value Object

This object can be used in the same manner as the Binary Input object and Binary Output object.

Properties List

(1): Read and write from BACnet devices

(2): Read and write from device addresses when properties are allocated to device addresses

R: Read-only, W: Write-only, R/W: Read and write, -: Not Read and write

Property Identifier	Data Type of Property	(1)	(2)	Comments
Object_Identifier	BACnetObjectIdentifier	R	-	Set a fixed value with WindO/I-NV4.
Object_Name	Character string* ¹	R	-	Set a fixed value with WindO/I-NV4.
Object_Type	BACnetObjectType	R	-	Set a fixed value with WindO/I-NV4.
Present_Value	BACnetBinaryPV	R	R	Refer to "Present_Value" on page 3-132.
Description	Character string* ¹	R	-	Set a fixed value with WindO/I-NV4.
Status_Flags	BACnetStatus_Flags	R	R	Refer to "Status_Flags" on page 3-145.
Event_State	BACnetEventState	R	-	Normal (fixed).
Reliability	BACnetReliability	R	R/W	Indicates whether or not the value of Present_Value is reliable.
Out_Of_Service	Logical value	R/W	R/W	Refer to "Out_Of_Service" on page 3-146.
Priority_Array	BACnetPriority_Array	R/W	R/W	Refer to "Priority_Array" on page 3-145.
Relinquish_Default	BACnetBinaryPV	R/W	-	Refer to "Relinquish_Default" on page 3-145.
Property_List* ²	BACnetARRAY[N] of type BACnetPropertyIdentifier	R	-	Cannot be edited with WindO/I-NV4.

*1 Character encoding is ISO 10646 (UTF-8), and the maximum size is 64 bytes.

*2 Cannot be displayed on WindO/I-NV4.

● Device Object

Use this object when the MICRO/I makes basic information available to BACnet devices.

Properties List

(1): Read and write from BACnet devices

(2): Read and write from device addresses when properties are allocated to device addresses

R: Read-only, W: Write-only, R/W: Read and write, -: Not Read and write

Property Identifier	Data Type of Property	(1)	(2)	Comments
Object_Identifier	BACnetObjectIdentifier	R	-	Cannot be edited with WindO/I-NV4.
Object_Name	Character string ^{*1}	R	-	Set a fixed value with WindO/I-NV4.
Object_Type	BACnetObjectType	R	-	Cannot be edited with WindO/I-NV4.
System_Status	BACnetDeviceStatus	R	-	Cannot be edited with WindO/I-NV4.
Vendor_Name	Character string ^{*1}	R	-	Cannot be edited with WindO/I-NV4.
Vendor_Identifier	16-bit unsigned integer	R	-	Cannot be edited with WindO/I-NV4.
Model_Name	Character string ^{*1}	R	-	Set a fixed value with WindO/I-NV4.
Firmware_Revision	Character string ^{*1}	R	-	Cannot be edited with WindO/I-NV4.
Application_Software_Version	Character string ^{*1}	R	-	Set a fixed value with WindO/I-NV4.
Location	Character string ^{*1}	R/W	-	Set the initial value with WindO/I-NV4.
Description	Character string ^{*1}	R/W	-	Set the initial value with WindO/I-NV4.
Protocol_Version	Unsigned integer	R	-	Cannot be edited with WindO/I-NV4.
Protocol_Revision	Unsigned integer	R	-	Cannot be edited with WindO/I-NV4.
Protocol_Services_Supported	BACnetServicesSupported	R	-	Cannot be edited with WindO/I-NV4.
Protocol_Object_Types_Supported	BACnetObjectType Supported	R	-	Cannot be edited with WindO/I-NV4.
Object_List	BACnetARRAY[N] of type BACnetObjectIdentifier	R	-	Cannot be edited with WindO/I-NV4.
Max_APDU_Length_Accepted	Unsigned integer	R	-	Cannot be edited with WindO/I-NV4.
Segmentation_Supported	BACnetSegmentation	R	-	Cannot be edited with WindO/I-NV4.
Local_Time	Time	R	-	Cannot be edited with WindO/I-NV4.
Local_Date	Date	R	-	Cannot be edited with WindO/I-NV4.
APDU_Timeout	Unsigned integer	R	-	Cannot be edited with WindO/I-NV4.
Number_of_APDU_Retries	Unsigned integer	R	-	Cannot be edited with WindO/I-NV4.
Device_Address_Binding	BACnetLIST of type BACnetAddressBiding	R	-	Cannot be edited with WindO/I-NV4.
Database_Revision	Unsigned integer	R	-	Cannot be edited with WindO/I-NV4.
Property_List ^{*2}	BACnetARRAY[N] of type BACnetPropertyIdentifier	R	-	Cannot be edited with WindO/I-NV4.
Profile_Name	Character string ^{*1}	R	-	Set a fixed value with WindO/I-NV4.

*1 Character encoding is ISO 10646 (UTF-8), and the maximum size is 64 bytes.

*2 Cannot be displayed on WindO/I-NV4.

7.9 Key Properties

- Present_Value

This property represents the current value. This property handles input and output values associated with objects.

Priority Mechanism

Objects^{*1} with Present_Value that can be written from BACnet devices use a priority mechanism with Priority_Array in which write instructions are ranked and the value of Present_Value is determined. In this case, values cannot be directly written to Present_Value. To write a value to Present_Value, the value is first stored in Priority_Array ("Present_Value Settings" on page 3-112) at the index number indicated by **Priority** ("Priority_Array" on page 3-145). Then the value stored in Priority_Array with the smallest index number out of all non-NULL(00h) values is used as the value of Present_Value.

*1 Analog Output, Analog Value, Binary Output, Binary Value objects

Writing the Value of a Device Address as Present_Value or Writing Present_Value from a BACnet Device

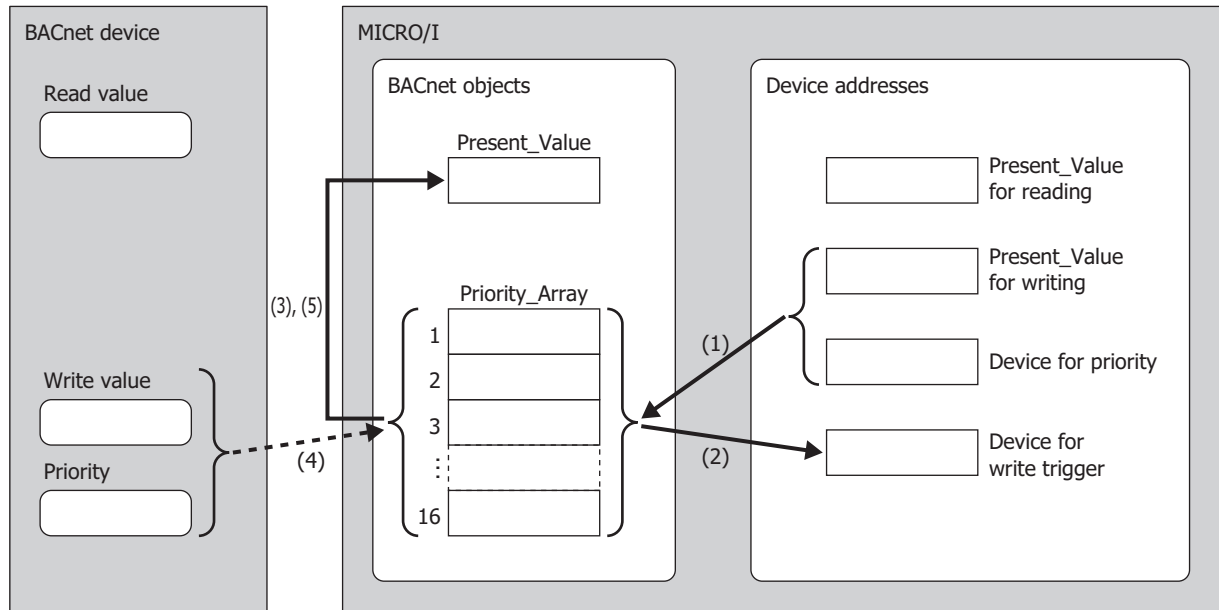

The items used in the above diagram are described in the following table.

Item	Description
Present_Value for reading	This device address stores Present_Value read from the BACnet device.
Present_Value for writing	This device address stores the value to be written to the BACnet device as Present_Value.
Device for priority	This device address stores the index number in the array (Priority_Array) where the priority value is stored.
Device for write trigger	When this device address is 1, the value stored in the Present_Value for writing is stored in Priority_Array at the index number stored in device address for priority.
Present_Value	Present_Value held by the BACnet object in the MICRO/I.
Priority_Array	Refer to "Priority_Array" on page 3-145.
Read value	Current Present_Value.
Write value	Present_Value to be written from the BACnet device.

Writing from a Device Address

- (1) When bit 15 of **Device for priority** is 0 and the value of **Device for write trigger** changes from 0 to 1, writes the value of **Present_Value for writing** to the Priority_Array at the index number stored in the bit 4 to 0 of **Device for priority**.
- (2) **Device for write trigger** is automatically reset to 0.
- (3) The value stored in Priority_Array with the smallest index number out of all non-NULL(00h) values is used as the value of Present_Value. (The value of Priority_Array at the index number is used as Present_Value until it is reset to NULL(00h).)



When bit 15 of **Device for priority** is 1 and the value of **Device for write trigger** changes from 0 to 1, NULL(00h) is written to Priority_Array at the index number stored in **Device for priority**.

For details about the bit assignments of the Device for priority, refer to "Analog Value Object" in "Top device for priority and trigger" on page 3-117.

Writing from the BACnet Device

- (4) The BACnet device writes the value of Present_Value to Priority_Array at the index number indicated by the specified priority.
- (5) The value stored in the Priority_Array property with the smallest index number out of all non-NULL(00h) values is used as the value of Present_Value. (The value of Priority_Array at the index number is used as Present_Value until it is reset to NULL(00h).)



If all values stored in Priority_Array are NULL(00h), "Relinquish_Default" on page 3-145 is used as Present_Value.

Writing the Value of a Device Address to Present_Value

Example: When #D0000 is allocated to the Present_Value device, #D0010 is allocated to the top device for priority and trigger, and Float32(F) is allocated to the conversion type, the device addresses are allocated as follows: #D0000 is the Present_Value for reading, #D0002 is the Present_Value for writing, #D0010 is the Device for priority, and #D0011 is the Device for write trigger.

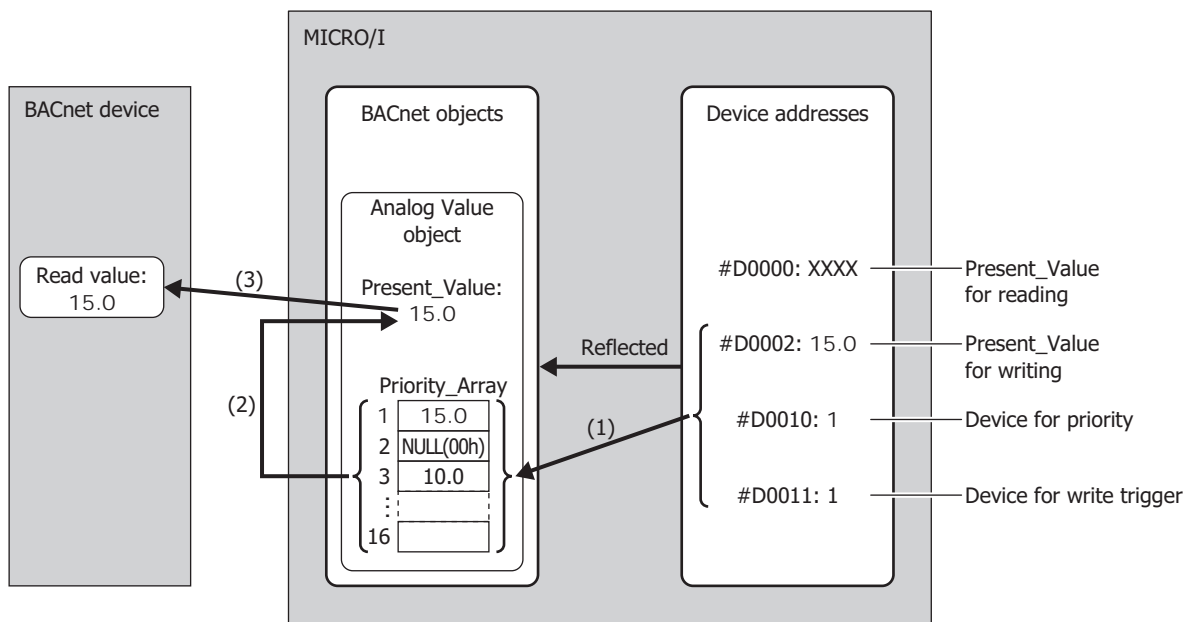

- (1) If the value of the Device for priority (#D0010) is 1 when the value of the Device for write trigger (#D0011) is 1, writes the value (15.0) of the Present_Value for writing (#D0002) to the element 1 of Priority_Array. After the write has completed, the value of the Device for write trigger (#D0011) is reset to 0.
- (2) Priority_Array with the smallest index number out of all non-NULL(00h) values is element 1 (15.0), so 15.0 is used as the value of Present_Value.
- (3) Present_Value (15.0) is read from the BACnet device.

Writing a Value to Present_Value from the BACnet Device

Example: When #D0000 is allocated to the Present_Value device, #D0010 is allocated to the top device for priority and trigger, and Float32(F) is allocated to the conversion type, the device addresses are allocated as follows: #D0000 is the Present_Value for reading, #D0002 is the Present_Value for writing, #D0010 is the Device for priority, and #D0011 is the Device for write trigger.

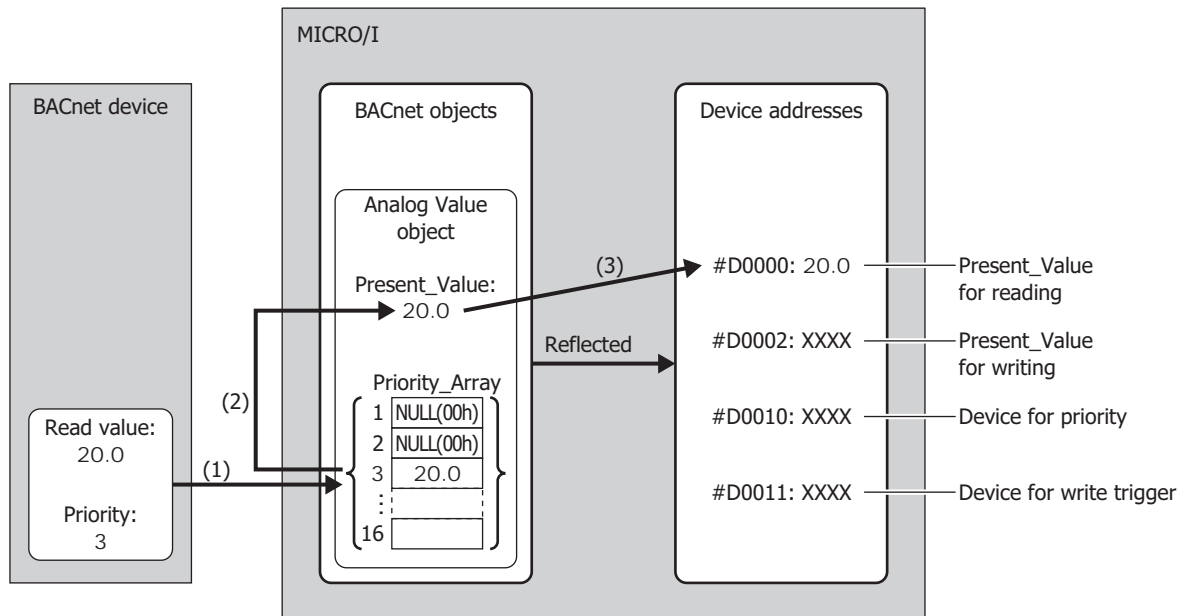

- (1) The BACnet device writes the write value (20.0) to Priority_Array at the index number indicated by the specified priority (3).
- (2) Priority_Array with the smallest index number out of all non-NULL(00h) values is element 3 (20.0), so 20.0 is used as the value of Present_Value.
- (3) Present_Value (20.0) is written to the Present_Value for reading (#D0000).

Analog Input Object

Present_Value of the Analog Input object can be set to a fixed value or allocated device addresses and set to the value of those device address. Present_Value is a Float32(F) numeric value. When device addresses are allocated to Present_Value, Present_Value is set to the product of those device addresses multiplied by the coefficient.

The following diagram illustrates the concept when device addresses are allocated to Present_Value of the Analog Input object and the BACnet device reads out the analog input value.

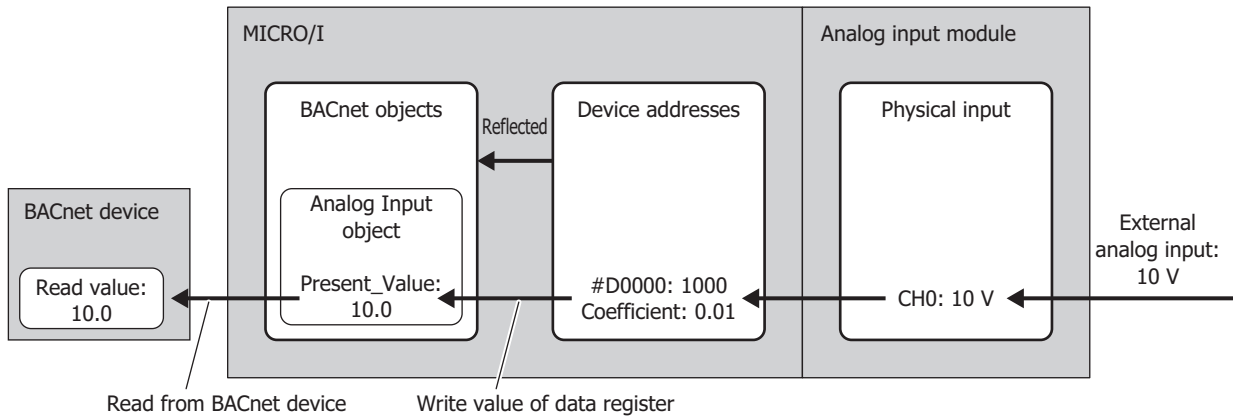

When writing the value of device addresses as Present_Value, Present_Value changes in the following manner.

Data Type	Value of Device Addresses	Present_Value of BACnet Device
UBIN16(W)	Value within range of each data type	Value of Device Addresses
BIN16(I)		
UBIN32(D)		
BIN32(L)		
Float32(F)	±0	±0.0
	Denormalized number	Value of Device Addresses
	Normalized number	
	±∞ (±infinity)	Present_Value does not change
	Non-number	

Analog Output Object

Present_Value of the Analog Output object can be allocated device addresses and set to the value of those device addresses. Present_Value is a Float32(F) numeric value. When device addresses are allocated to Present_Value, the product of Present_Value multiplied by 1/coefficient is stored in the device addresses.

The following diagram illustrates the concept when device addresses are allocated to Present_Value of the Analog Output object and the BACnet device writes the analog output value.

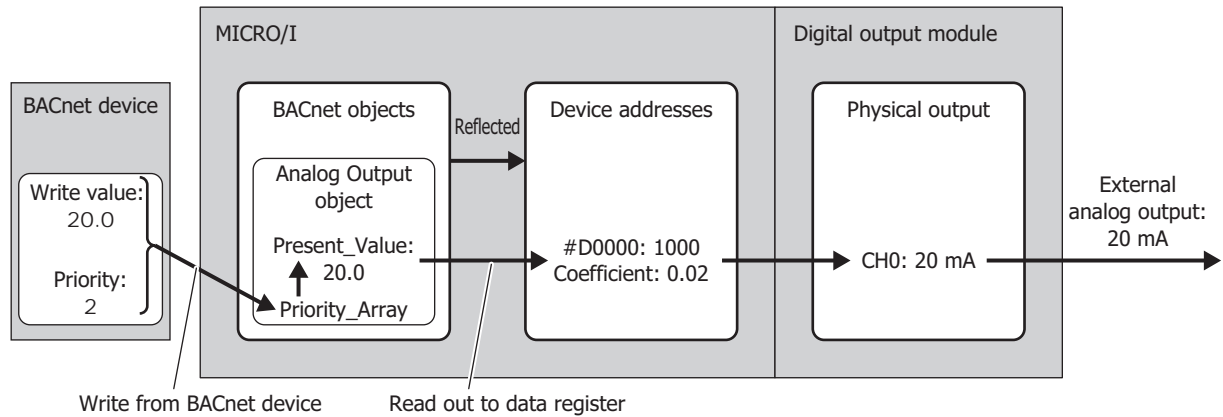

Present_Value of the Analog Output object cannot be changed from the MICRO/I.

When reading out Present_Value to device addresses, you must be aware of the data type. Depending on the data type of the device addresses, the value is stored in the device addresses as follows. Set the data type according to the value of Present_Value. The data type of Present_Value is set in "Conversion type" on page 3-115 of the "Analog Output Object".

Data Type	Present_Value of BACnet Device	Value of Device Addresses
UBIN16(W)	Value within range of 0 to 65,535	Present_Value
	Value outside range of 0 to 65,535	0
BIN16(I)	Value within range of -32,768 to 32,767	Present_Value
	Value outside range of -32,768 to 32,767	0
UBIN32(D)	Value within range of 0 to 4,294,967,295	Present_Value
	Value outside range of 0 to 4,294,967,295	0
BIN32(L)	Value within range of -2,147,483,648 to 2,147,483,647	Present_Value
	Value outside range of -2,147,483,648 to 2,147,483,647	0
Float32(F)	—	Present_Value

Analog Value Object

Present_Value of the Analog Value object can be used as Present_Value of both the Analog Input and Analog Output objects. Present_Value is a Float32(F) numeric value.

The following diagram illustrates the concept when device addresses are allocated to Present_Value of the Analog Value object and the temperature of an office air conditioner is temporarily lowered from the base temperature (27.0°C) to 26.5°C.

Example: When #D0000 is allocated to the Present_Value device, #D0010 is allocated to the top device for priority and trigger, and Float32(F) is allocated to the conversion type, the device addresses are allocated as follows: #D0000 is the Present_Value for reading, #D0002 is the Present_Value for writing, #D0010 is the Device for priority, and #D0011 is the Device for write trigger.

Writing the Value of a Device Address to Present_Value

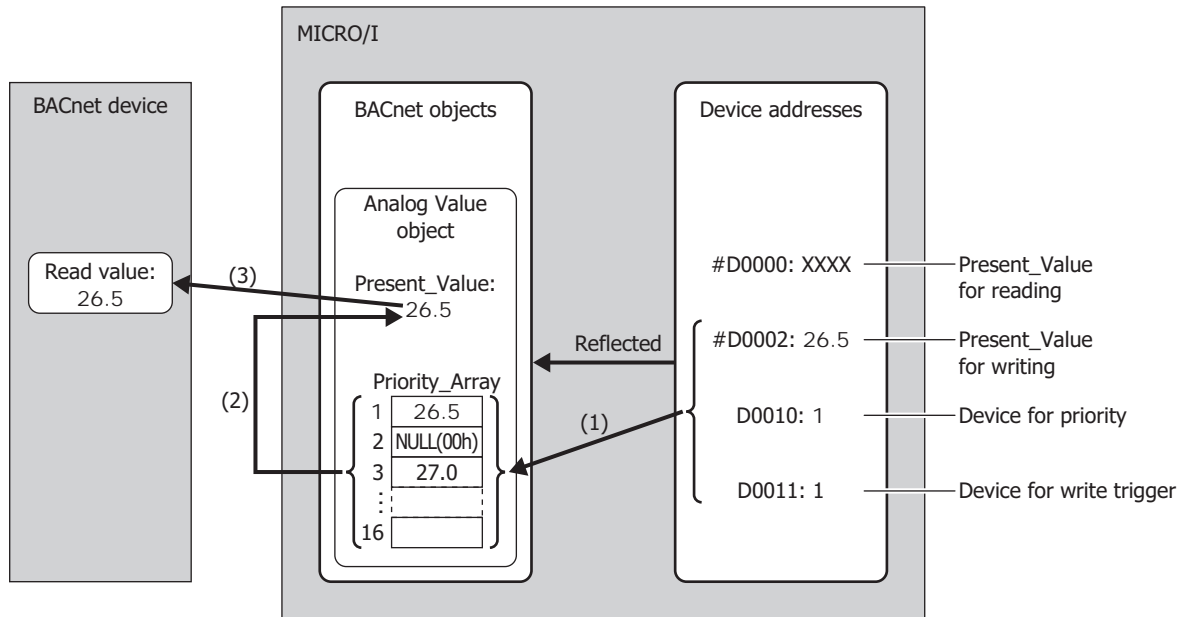

- (1) When the value of the Device for write trigger (#D0011) is 1, writes the value of the Present_Value for writing (#D0002) to the Priority_Array at the index number stored in the Device for priority (#D0010).
- (2) The Device for write trigger (#D0011) is automatically reset to 0.
- (3) Priority_Array with the smallest index number out of all non-NULL(00h) values is element 1 (26.5), so 26.5 is used as the value of Present_Value.

Writing a Value to Present_Value from the BACnet Device

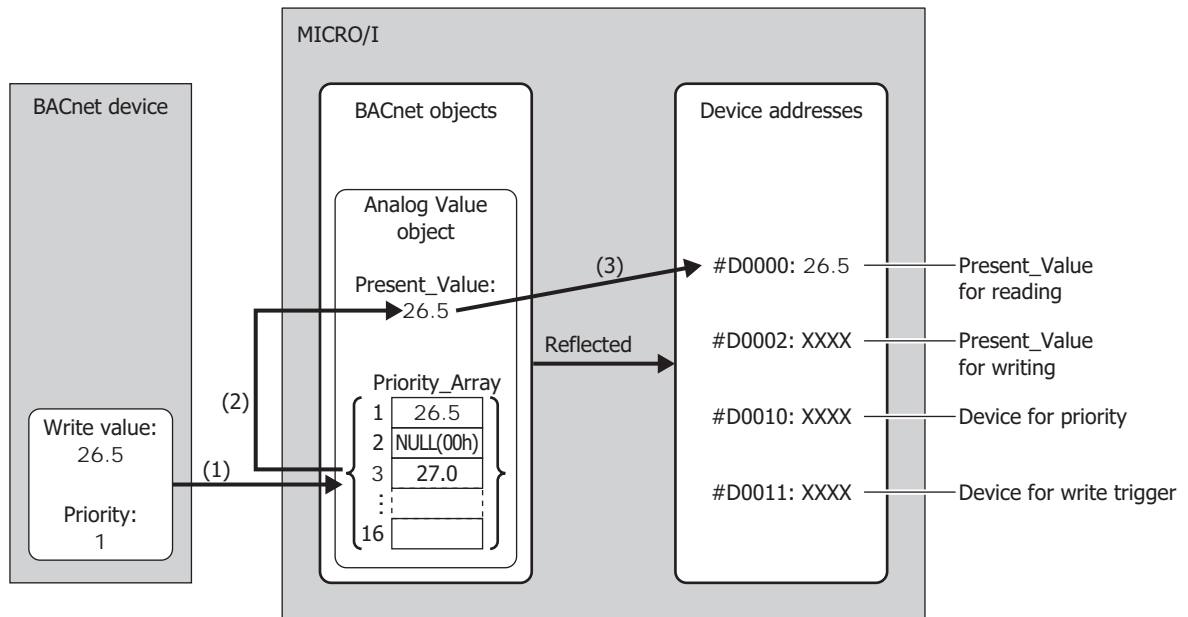

- (1) The BACnet device writes the write value (26.5) to Priority_Array at the index number indicated by the specified priority (1).
- (2) Priority_Array with the smallest index number out of all non-NULL(00h) values is element 1 (26.5), so 26.5 is used as the value of Present_Value.
- (3) Present_Value (26.5) is written to the Present_Value for reading (#D0000).



Element 1 (26.5) of Priority_Array is used as the value of Present_Value until it is reset to NULL(00h). When element 1 is reset to NULL(00h), element 3 (27.0) is used as the value of Present_Value.

For how to write NULL(00h), refer to "Analog Value Object" in "Top device for priority and trigger" on page 3-117.

Depending on the data type of the allocated device addresses, Present_Value is stored in the device addresses as follows. Set the data type according to the value of Present_Value. The data type of Present_Value is set in "Conversion type" on page 3-118 of the "Analog Value Object".

Data Type	Present_Value of BACnet Device × (1/Coefficient)	Value of Device Addresses
UBIN16(W)	Value within range of 0 to 65,535	Present_Value
	Value outside range of 0 to 65,535	0
BIN16(I)	Value within range of -32,768 to 32,767	Present_Value
	Value outside range of -32,768 to 32,767	0
UBIN32(D)	Value within range of 0 to 4,294,967,295	Present_Value
	Value outside range of 0 to 4,294,967,295	0
BIN32(L)	Value within range of -2,147,483,648 to 2,147,483,647	Present_Value
	Value outside range of -2,147,483,648 to 2,147,483,647	0
Float32(F)	—	Present_Value

Additionally, when writing the value of device addresses to Present_Value, Present_Value changes in the following manner.

Data Type	Value of Device Addresses	Present_Value of BACnet Device
UBIN16(W)	Value within range of each data type	Value of device addresses × Coefficient
BIN16(I)		
UBIN32(D)		
BIN32(L)		
Float32(F)	±0	±0.0
	Denormalized number	Value of device addresses × Coefficient
	Normalized number	
	±∞ (±infinity)	Present_Value does not change
	Non-number	

Binary Input Object

Present_Value of the Binary Input object can be set to a fixed value or allocated to a bit device address and set to the value of that bit device.

The following diagram illustrates the concept when an external input is allocated to Present_Value of the Binary Input object and the BACnet device reads out the state of the external input.

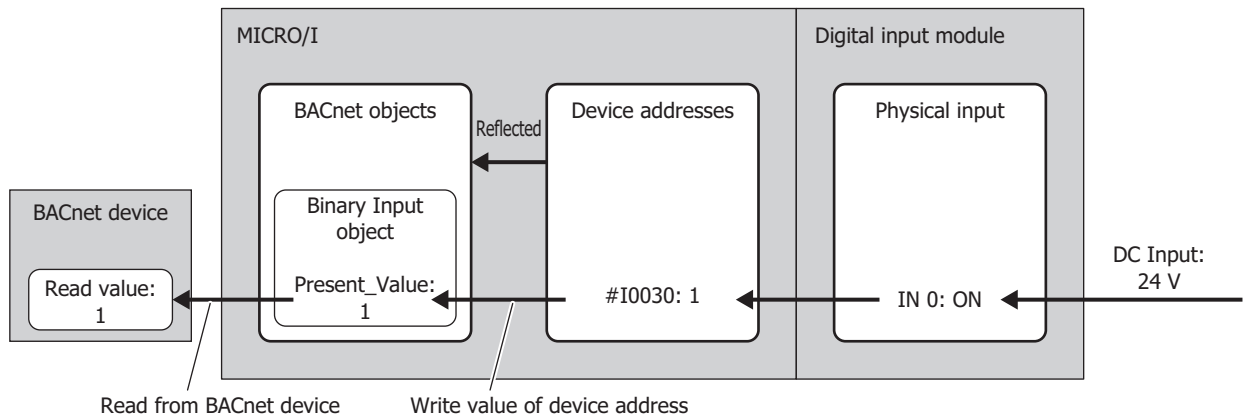

The following table shows Present_Value, Polarity, and the physical state of the input.

Present_Value	Polarity	Physical State of Input
INACTIVE	NORMAL	OFF or INACTIVE
ACTIVE	NORMAL	ON or ACTIVE
INACTIVE	REVERSE	ON or ACTIVE
ACTIVE	REVERSE	OFF or INACTIVE

Binary Output Object

Present_Value of the Binary Output object can be allocated to a bit device and set to the value of that bit device.

The following diagram illustrates the concept when a device address is allocated to Present_Value of the Binary Output object and the BACnet device writes the state of the external output.

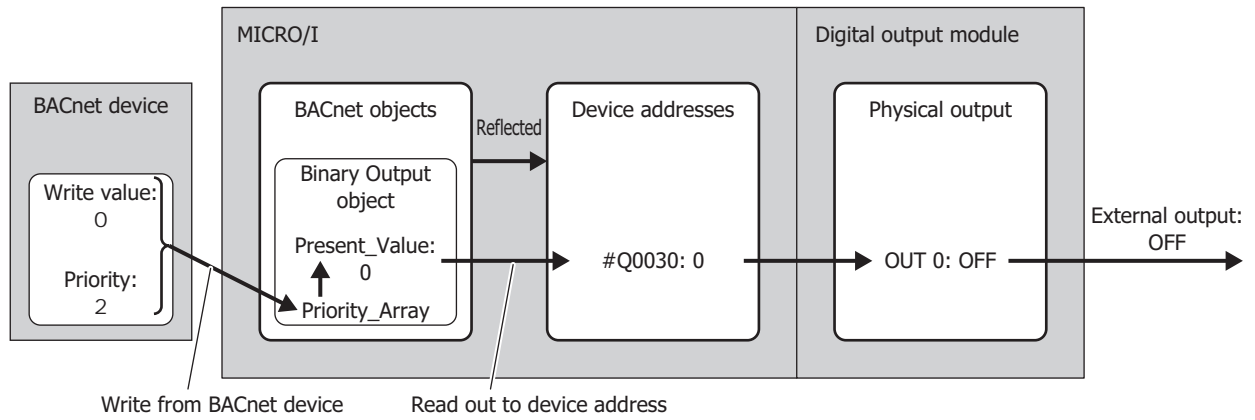

The following table shows Present_Value, Polarity, and the physical state of the output.

Present_Value	Polarity	Physical State of Output
INACTIVE	NORMAL	OFF or INACTIVE
ACTIVE	NORMAL	ON or ACTIVE
INACTIVE	REVERSE	ON or ACTIVE
ACTIVE	REVERSE	OFF or INACTIVE

Binary Value Object

Present_Value of the Binary Value object can be used as Present_Value of both the Binary Input and Binary Output objects.

The following diagram illustrates the concept when an internal relay is allocated to Present_Value of the Binary Value object and the office lights are temporarily turned on from off.

Example: When #M0000 is allocated to the Present_Value device and #D0010 is allocated to the top device for priority and trigger, the device address are allocated as follows: #M0000 is the Present_Value for reading, #M0001 is the Present_Value for writing, #D0010 is the Device for priority, and #D0011 is the Device for write trigger.

Writing the Value of a Device Address to Present_Value

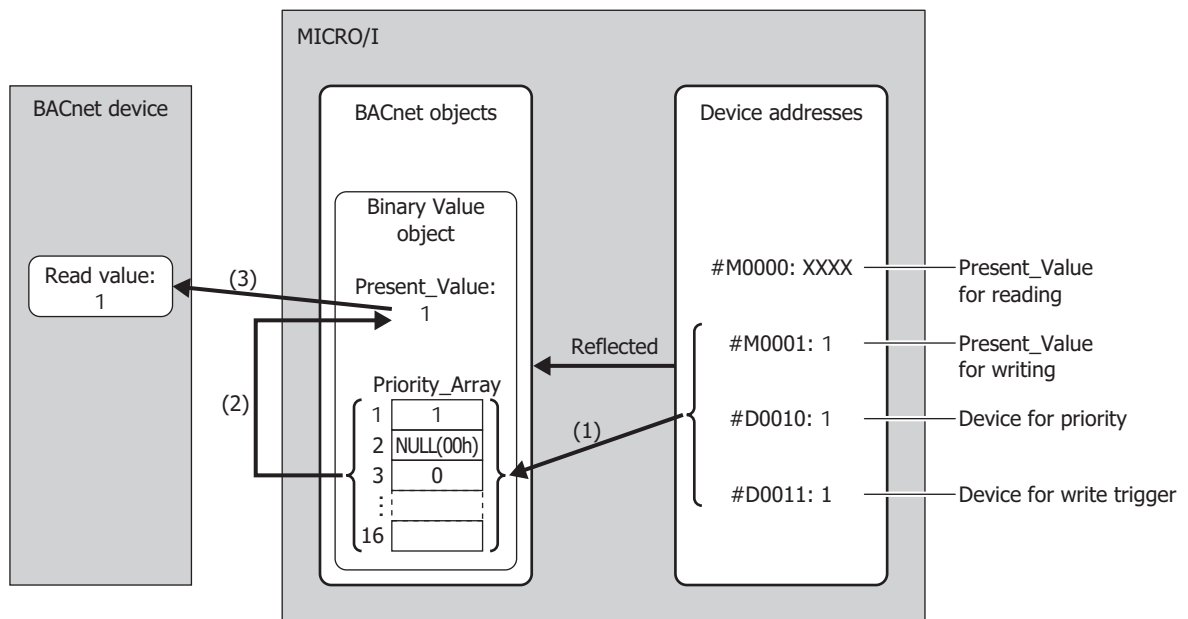

- (1) When the value of the Device for write trigger (#D0011) is 1, writes the value of the Present_Value for writing (#M0001) to the Priority_Array at the index number stored in the Device for priority (#D0010).
- (2) The value of the Device for write trigger (#D0011) is automatically reset to 0.
- (3) Priority_Array with the smallest index number out of all non-NULL(00h) values is element 1 (1), so 1 is used as the value of Present_Value.

Writing a Value to Present_Value from the BACnet Device

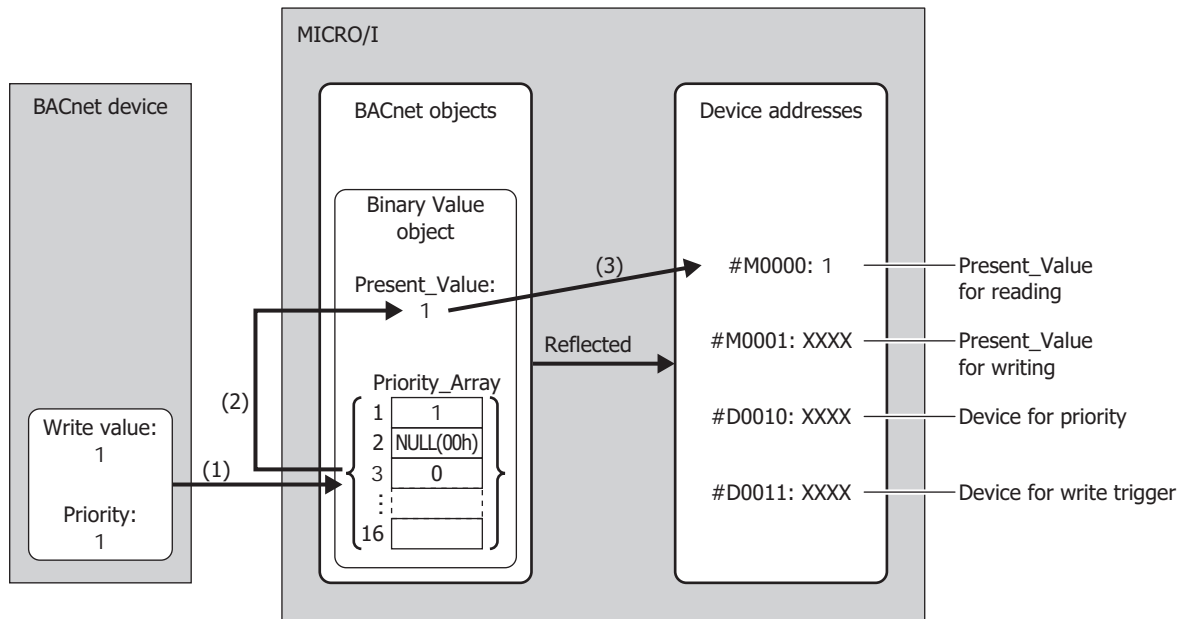

- (1) The BACnet device writes the write value (1) to Priority_Array at the index number indicated by the specified priority (1).
- (2) Priority_Array with the smallest index number out of all non-NULL(00h) values is element 1 (1), so 1 is used as the value of Present_Value.
- (3) Present_Value (1) is written to the Present_Value for reading (#M0000).



Element 1 (1) of Priority_Array is used as the value of Present_Value until it is reset to NULL(00h). When element 1 is reset to NULL(00h), element 3 (0) is used as the value of Present_Value.

For how to write NULL(00h), refer to "Binary Value Object" in "Top device for priority and trigger" on page 3-123.

Status_Flags

This property represents the current status of the object (in alarm, fault, out of service, etc.).

Status_Flags	Value	Logical Value	Condition
IN_ALARM*1	0	FALSE	When obtaining a value where Event State is Normal.
	1	TRUE	Other than above
FAULT	0	FALSE	Other than below
	1	TRUE	When Reliability is present and the no-fault-detected value is not obtained
OVERRIDDEN*1	0	FALSE	Other than below
	1	TRUE	Present_Value and Reliability did not follow the change in physical input
OUT_OF_SERVICE	0	FALSE	When Out_Of_Service is TRUE
	1	TRUE	When Out_Of_Service is FALSE

The allocation of flags in the device address is as follows.

Bit	Flag	Value
Bits 15 to 8	Reserved	Undefined
Bit 7	IN_ALARM	0 (fixed)
Bit 6	FAULT	0 or 1
Bit 5	OVERRIDDEN	0 (fixed)
Bit 4	OUT_OF_SERVICE	0 or 1
Bits 3 to 0	Reserved	Undefined

COV_Increment

This property represents the minimum amount of change in Present_Value.

COV notifications are sent when the value of Present_Value for the COV notification that was last sent changes to a value that is greater than or equal to the value set with COV_Increment. COV_Increment cannot be read out to device address. Set the initial value with WindO/I-NV4.

Priority_Array

Priority_Array is a read-only property representing the array that stores the priority values.

Of the 16 elements in the array (element 1 to element 16), the value stored in Priority_Array with the smallest index number out of all non-NULL(00h) values is used as the value of Present_Value. If all values stored in Priority_Array are NULL(00h), Relinquish_Default is used as Present_Value.

Relinquish_Default

Relinquish_Default is the default value used as Present_Value when all values stored in Priority_Array are NULL(00h).

Polarity

This property represents the relationship between the physical state of the input/output and the logical state indicated by Present_Value in the Binary Input and Binary Output objects.

Polarity	Physical State of Input/Output	Present_Value	Physical State of Device
NORMAL	OFF or INACTIVE	INACTIVE	Not running
NORMAL	ON or ACTIVE	ACTIVE	Running
REVERSE	ON or ACTIVE	INACTIVE	Not running
REVERSE	OFF or INACTIVE	ACTIVE	Running

*1 Always FALSE on the MICRO/I.

Out_Of_Service

Out_Of_Service is the property that represents whether or not Present_Value and the physical input/output have been unbound.

Properties	Value	Logical Value	Condition
Out_Of_Service	0	FALSE	In service (Present_Value and the physical input/output are bound.)
	1	TRUE	Out of service (Present_Value and the physical input/output are unbound.)

Out_Of_Service can be read out to an internal relay, and the status of an internal relay can be written as Out_Of_Service.



Out_Of_Service = TRUE is used for simulations.

Reliability

This property represents the reliability of the object property.

The following table shows the definition of Reliability for each object type.

YES: Valid, NO: Invalid

Definition	Value	Analog Input	Analog Output	Analog Value	Binary Input	Binary Output	Binary Value
no-fault-detected	0	YES	YES	YES	YES	YES	YES
no-sensor	1	YES	NO	NO	YES	NO	NO
over-range	2	YES	NO	YES	NO	NO	NO
under-range	3	YES	NO	YES	NO	NO	NO
open-loop	4	YES	YES	NO	YES	YES	NO
shorted-loop	5	YES	YES	NO	YES	YES	NO
no-output	6	NO	YES	NO	NO	YES	NO
unreliable-other	7	YES	YES	YES	YES	YES	YES
process-error	8	NO	NO	NO	NO	NO	NO
multi-state-fault	9	NO	NO	NO	NO	NO	NO
configuration-error	10	NO	NO	NO	NO	NO	NO
-- enumeration value 11 is reserved for a future addendum	11	YES	YES	NO	YES	YES	YES
communication-failure	12	YES	YES	YES	YES	YES	YES
member-fault	13	NO	NO	NO	NO	NO	NO
monitored-object-fault	14	NO	NO	NO	NO	NO	NO
tripped	15	NO	NO	NO	NO	NO	NO

Reliability can be read out to a device address, and the value of a device address can be written as Reliability.

System_Status

Indicates the physical status and logical status of the MICRO/I.

Parameter	Value
OPERATIONAL	0
OPERATIONAL_READ_ONLY	1
DOWNLOAD_REQUIRED	2
DOWNLOAD_IN_PROGRESS	3
NON_OPERATIONAL	4
BACKUP_IN_PROGRESS	5

System_Status of the MICRO/I is fixed as OPERATIONAL.

Firmware_Revision

This property is set with the System Software Version of the MICRO/I.

Application_Software_Version

Set information about the application, such as the modification date of the created project data, as a fixed string with WindO/I-NV4.

Protocol_Services_Supported

This property represents the types of services that are supported by the MICRO/I.

Protocol_Object_Types_Supported

This property represents the types of objects that are supported by the MICRO/I.

Object_List

This property represents the list of created objects.

Chapter 4 Project Settings

The settings and screen data required to run the MICRO/I are contained in a data structure called a Project. You must create a project using WindO/I-NV4 before creating the screens and configuring the settings for the MICRO/I. This chapter describes the various settings required to create a project.

1 Creating and Manipulating WindO/I-NV4 Project Data

HG2J-7U HG5G-V HG4G-V HG4G HG3G-V HG3G HG2G-V HG2G-5F HG2G-5T HG1G HG1P

4

Project Settings

1.1 Creating New Project Data

- Create new project data by using the interactive quick start
You can create project data by following displayed dialog boxes and configuring settings step by step.

1 Click , then click **New**.

A **Select Product Series** dialog box is displayed.

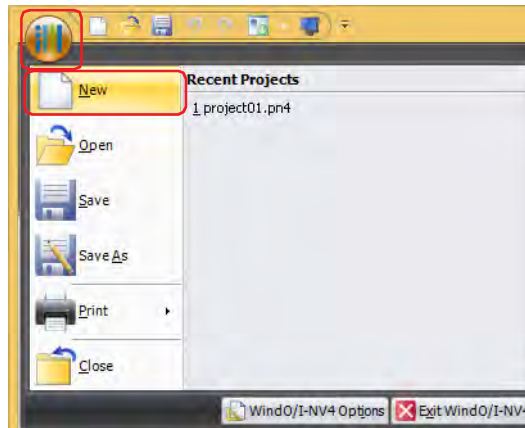

2 Select **Product Series**, **Type Number**, and **Installation**, and then click **Next**.

The **Select Communication Driver** dialog box is displayed.

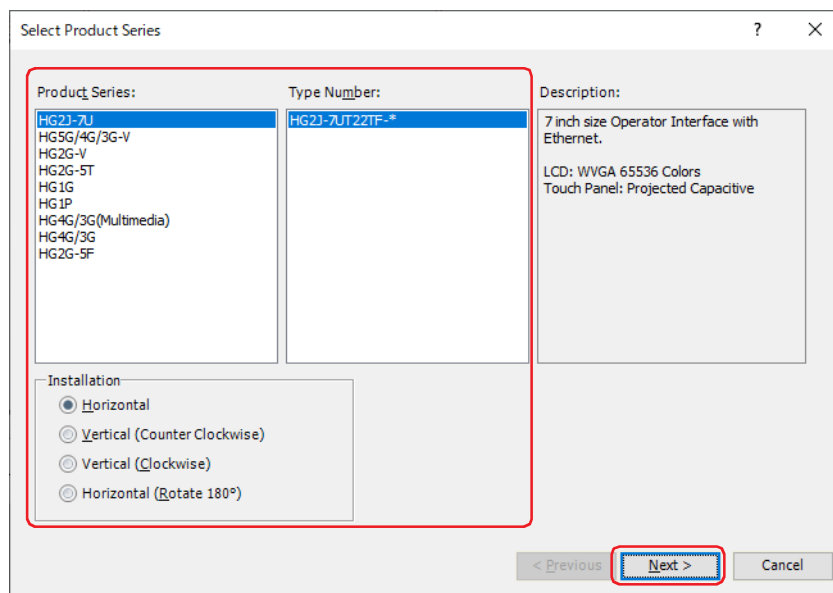

■ **Product Series**

Select the MICRO/I type.

■ **Type Number**

A list of model numbers associated with the selected MICRO/I is displayed. Select the model number to use.

■ **Installation**

Select the MICRO/I installation direction from the following options. The supported display orientation varies based on the model.

HG2J-7U, HG2G-5T, HG1G:	Horizontal, Vertical (Counter Clockwise), Vertical (Clockwise), Horizontal (Rotate 180°)
HG5G/4G/3G/2G-V, HG4G/3G, HG2G-5F:	Horizontal, Vertical (Counter Clockwise), Vertical (Clockwise)
HG1P:	Horizontal

- 3 Select **Manufacturer** and **Communication Driver** and then click **OK**.

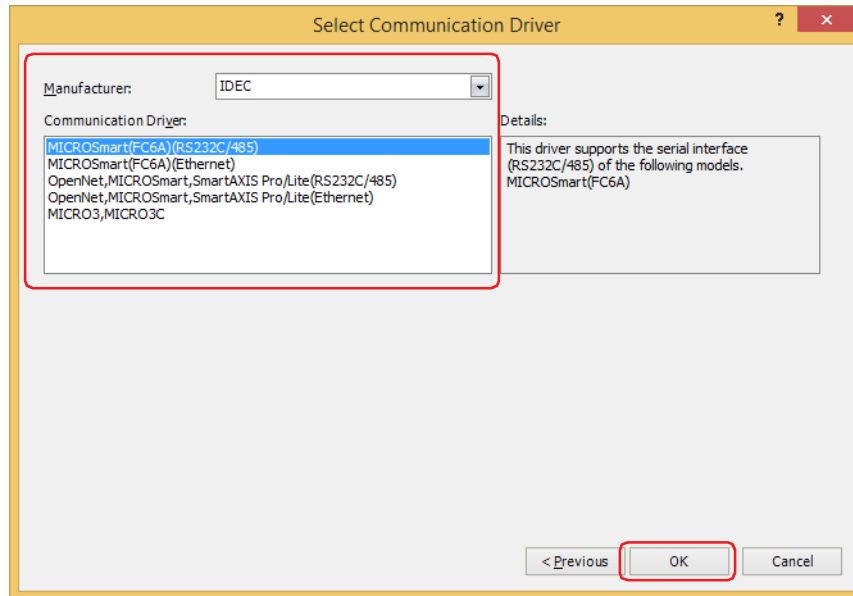

- **Manufacturer**
Select the manufacturer name of the external device used.
- **Communication Driver**
Shows the communication driver list for the select manufacturer. Select the communication driver to use.
- **Expression of Device Address Format**
Select the format for the device address.

Allen-Bradley: Enter device addresses in the Allen-Bradley format.
Example: B 10:123/5

WindO/I-NV4: Enter device addresses in the WindO/I-NV4 format.
Example: B 1012305

This option can only be configured when **Allen-Bradley** is selected for **Manufacturer**.



You can return to the **Select Communication Driver** dialog box and change its setting by clicking **Previous**.

This concludes creating project data.

Next you will create a screen. For details, refer to Chapter 5 “3.1 Properties of Base Screen Dialog Box” on page 5-14.

1.2 Opening Project Data

● Opening project data

You can open project data that has already been created.

- 1 Click , then click **Open**.

The **Open** dialog box is displayed.

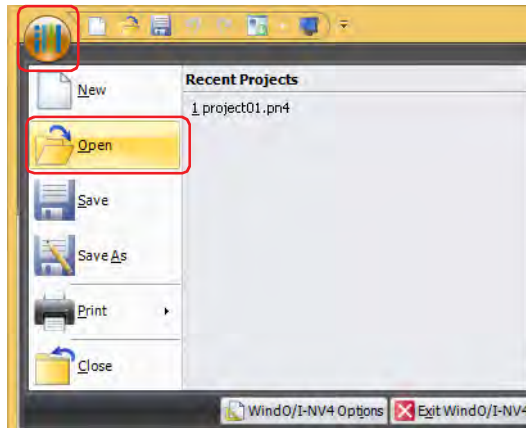

- 2 Select the file and click **Open**.

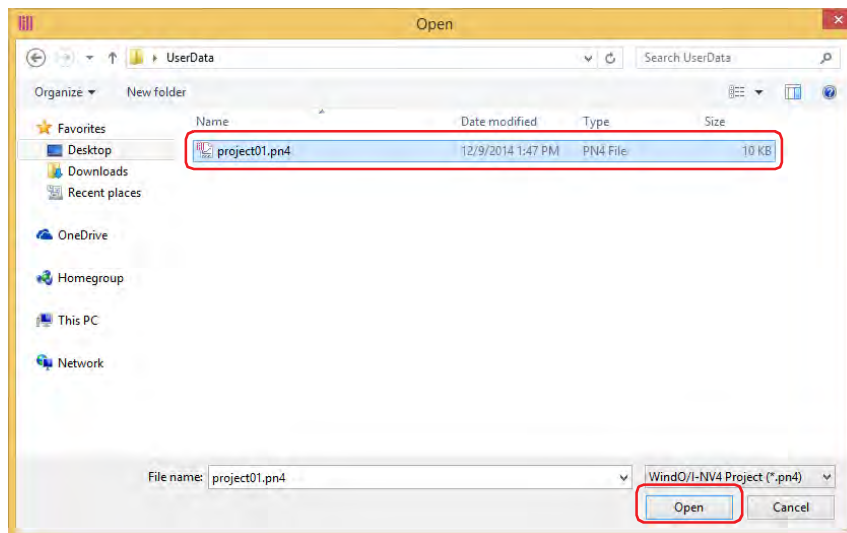

If a password has been configured for the project data, the Enter Password screen will be displayed. Enter the password for projects created with WindO/I-NV4 Ver. 1.11.4 or earlier using only 4 to 15 uppercase letters and numbers.

The password to enter varies based on the check box setting of the **Use Password to open a Project** found under the **Options** tab in the **Security** dialog box.

When this check box is checked, enter the password for **Use Password to open a Project**.

When this check box is unchecked, enter the password for the user account assigned to the Administrator security group.

For details, refer to Chapter 23 "User Accounts and the Security Function" on page 23-1.

Next you will open a screen. For details, refer to Chapter 5 "2.2 Opening Screens" on page 5-3.



Project data can also be opened by the following methods.

Click  and then click project data on the **Recent Projects** list

1.3 Saving Project Data

- Saving project data

You can save the project data being edited.

Click  and then click **Save**.

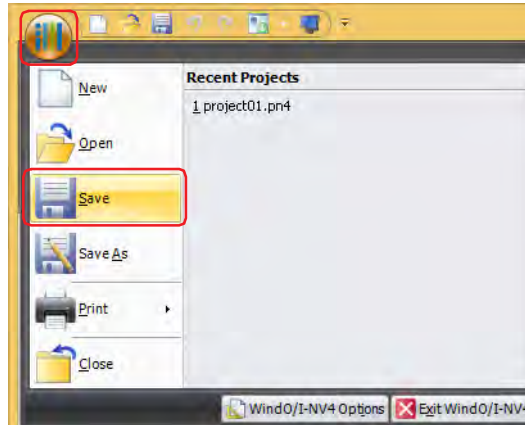

When new project data is created and you have never save it, the **Save As** dialog box is displayed. Enter the project name and then click **Save**.

● Saving project data with a different name

You can save the project data being edited with a different name.

- 1 Click , then click **Save As**.

The **Save As** dialog box is displayed.

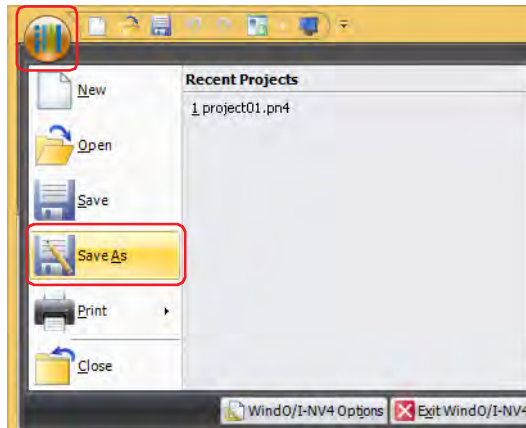

- 2 Enter the project name and click **Save**.

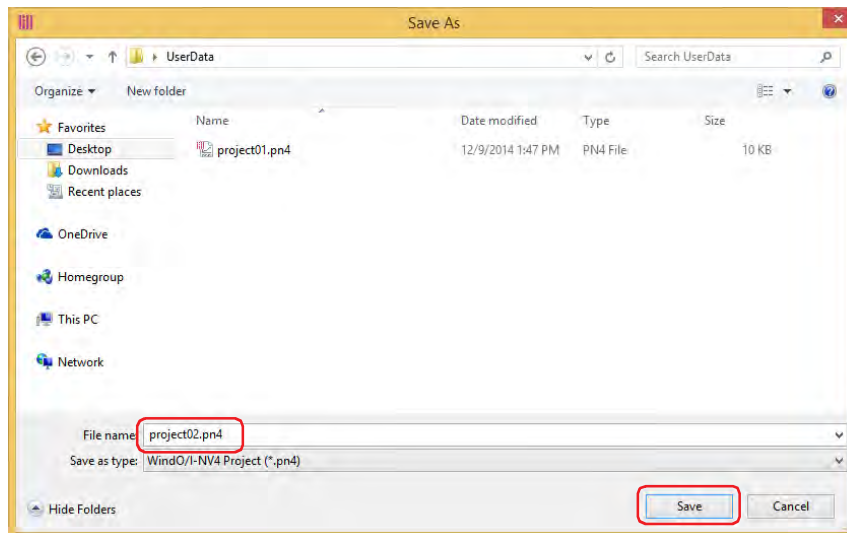

- You cannot use the following characters in the project name.
" * / : < > ? \ |
 - You cannot create project data in read-only folders or in WindO/I-NV4's working folders (temporary folders that start with "~").
-

1.4 Printing Project Data

You can print the settings for the project data being edited and its screen images.

- 1 Click  and then click **Print** and **Print Settings**.

The **Print Settings** dialog box is displayed.

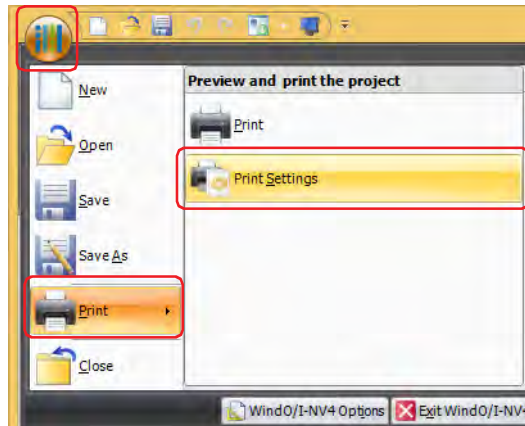

If the print settings have been completed, click , and then press **Print** and **Print** to immediately start printing.

- 2 Select the check boxes of the items to print in (**Print Items**), and configure the items as necessary. When an item is selected, the settings are displayed in (**Detailed Settings**) to the right.

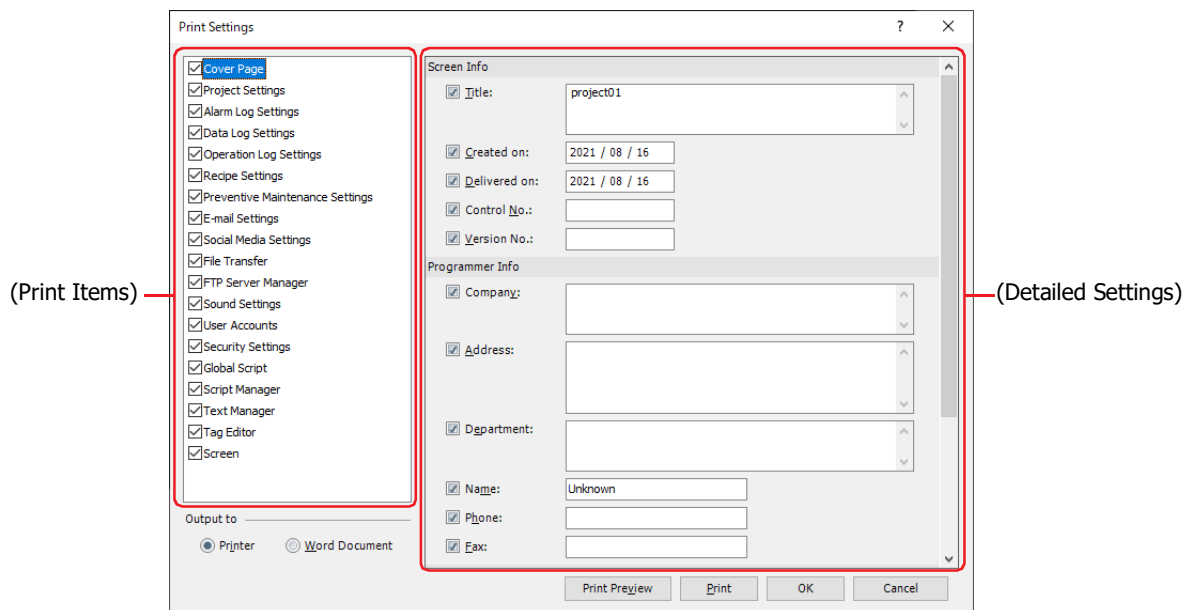

- 3 Select **Output to** and click **Print**.

■ Printer

The data is printed on the printer connected to the computer.

The Windows **Print** dialog is displayed. For details, refer to Windows help.

■ Word Document

The data is output to a Word file.

The **Save As** dialog box is displayed. Specify the save location and file name, and then click **Save**.



The data cannot be output to a Word file if Microsoft Office is not installed on the computer.

● **Print Settings Dialog Box**

The items to print and details for those items are configured in the **Print Settings** dialog box.

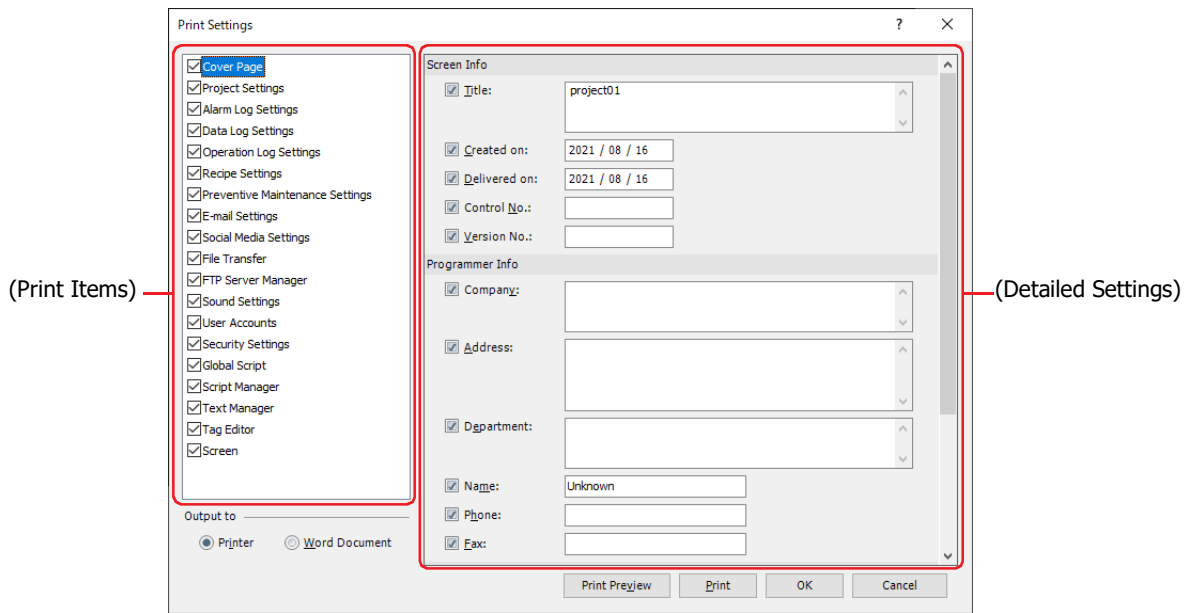

■ **(Print Items)**

Select the check boxes of the items to print.

- Cover Page: Select the cover page items, enter the information to print, and those items will be printed. For details, refer to “Cover Page” on page 4-10.
- Project Settings: Select the project setting items and those settings will be printed. For details, refer to “Project Settings” on page 4-11.
- Alarm Log Settings: Select the print target for the alarm log settings and those settings will be printed. For details, refer to “Alarm Log Settings” on page 4-12.
- Data Log Settings: Select the print target for the data log settings and those settings will be printed. For details, refer to “Data Log Settings” on page 4-12.
- Operation Log Settings: **Target Events to record** in the operation log settings will be printed.
- Recipe Settings: **Settings** in the recipe settings will be printed.
- Preventive Maintenance Settings: Prints the **Settings** in the Preventive Maintenance.
- E-mail Settings: Select the print target for the e-mail settings and those settings will be printed. For details, refer to “E-mail Settings” on page 4-13.
- Social Media Settings*¹: Select the print target for the Social Media Settings will be printed. For details, refer to “Social Media Settings” on page 4-13.
- File Transfer: **Settings** in the file transfer settings will be printed.
- FTP Server Manager: **Settings** in the FTP Server Manager will be printed.
- Sound Settings*²: Prints the **(Settings)** in Sound Settings will be printed.
- Multimedia Settings*³: Prints the **Movie File List, Use Event Recording** and **Input Signal** in the Multimedia Settings.
- User Accounts: **Number, User Name, Security Group** and the settings on the **Option** tab of the user accounts will be printed.
- Security Settings: **Number, Group Name,** and the **Operations** that are permitted in the security settings and the privileges for the Custom Web Pages will be printed.

*1 HG2J-7U only

*2 This is applicable for HG2J-7U and models with an audio interface only.

*3 This is applicable for models with a video interface only.

Global Script:	Settings in Global Script will be printed.
Script Manager:	Select the print target for the Script Manager and those settings will be printed. For details, refer to "Script Manager" on page 4-14.
Text Manager:	Select the (Text Messages List) for the Text Group and those settings will be printed. For details, refer to "Text Manager" on page 4-14.
Tag Editor:	Prints the device addresses used in the project, the tag names and the comments.
Screens:	Items such as the screen settings, list of laid out objects, and an image of the screen will be printed. For details, refer to "Screen" on page 4-15.

■ (Advanced Setting)

This area is used to configure the details of the items selected in (**Print Items**). The configured items will be printed according to the print format.

When an item is selected in (**Print Items**), the settings are displayed in (**Advanced Setting**).

■ Output to

Select the output destination when printing.

Printer: The data is printed on the printer connected to the computer.

Word Document: The data is output to a Word file.



The data cannot be output to a Word file if Microsoft Office is not installed on the computer.

■ Print Preview

Displays the **Print Preview** dialog box. An image of the layout to print on paper will be displayed in the preview. The layout can be configured while checking the preview. For details, refer to "Print Preview Dialog Box" on page 4-16.



The print preview will not work properly if Internet Explorer 8 or higher is not installed on the computer.

■ Print

If **Printer** is selected for **Output to**, the Windows **Print** dialog box is displayed. For details, refer to Windows help.

If **Word Document** is selected for **Output to**, the **Save As** dialog box is displayed. Specify the save location and file name, and then click **Save**.

Cover Page

■ Screen Info

Select the check boxes of the items to print about the project data information.

- Title: Enter the title of the project data. The maximum length is 90 characters on 3 lines.
- Created on: Select the creation date of the project data.
- Delivered on: Select the delivery date of the project data.
- Control No.: Enter the control number of the project data. The maximum length is 60 characters.
- Version No.: Enter the version number. The maximum length is 60 characters.

■ Programmer Info

Select the check boxes of the items to print about the programmer of the project data.

- Company: Enter the name of the company. The maximum length is 60 characters on 2 lines.
- Address: Enter the address of the company. The maximum length is 120 characters on 4 lines.
- Department: Enter the department in the company. The maximum length is 60 characters on 2 lines.
- Name: Enter the name of the programmer. The maximum length is 60 characters.
- Phone: Enter the telephone number of the company. The maximum length is 60 characters.
- Fax: Enter the fax number of the company. The maximum length is 60 characters.

■ Supplementary Info

Select the check boxes of the items to print about the programmer of the project data.

- Comment: Enter a comment for the project data.

Project Settings

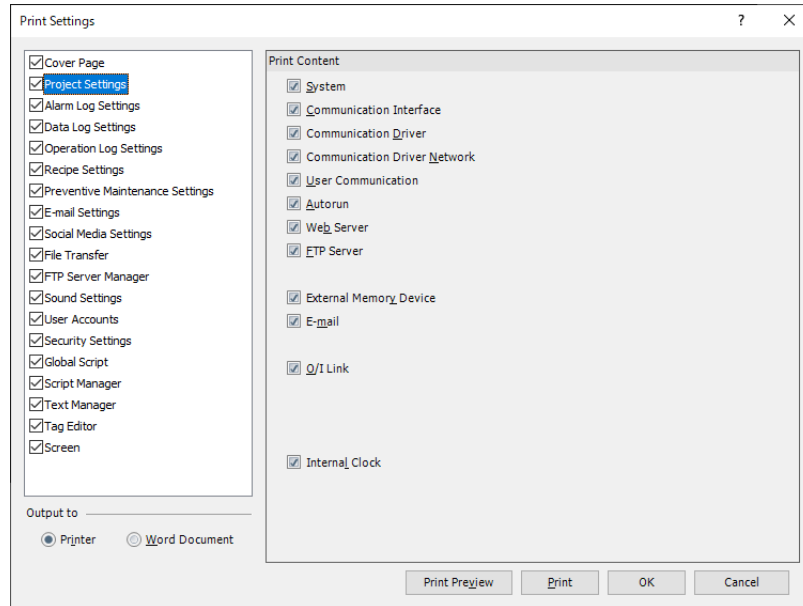

■ Print Content

Select the check boxes of the project settings to print.

System:	The settings on the System tab will be printed.
Communication Interface:	Interface and Function that have been configured and the corresponding Interface Settings will be printed.
Communication Driver:	The function of the configured external device and its Manufacturer and Communication Driver will be printed.
Communication Driver Network:	Settings will be printed. The settings of external devices for which External Device Communication is set to N/A will not be printed.
User Communication:	Protocol Name will be printed. Settings for which Protocol Name is set to N/A will not be printed.
Autorun:	The Enable USB Autorun and Open Popup Screen when USB Flash Drive is inserted settings will be printed.
Web Server:	All settings on the Web Server tab will be printed.
FTP Server:	All settings on the FTP Server tab will be printed.
Expansion Module ^{*1} :	All settings on the Expansion Module tab will be printed.
External Memory Device:	All settings on the External Memory Device tab will be printed.
E-mail:	All settings on the E-mail tab will be printed.
Sub Host Communication ^{*2} :	All settings on the Sub Host Communication tab will be printed.
O/I Link:	If Function is set to O/I Link Master , then Slave Settings will be printed. If Function is set to O/I Link Slave , then O/I Link Station will be printed.
Font/Kanji Dictionary Data ^{*2} :	The settings of the Optional Fonts to be downloaded and the Use Kanji dictionary data will be printed.
Printer ^{*1} :	All settings on the Printer tab will be printed.
BACnet/IP Settings ^{*3} :	Prints the settings on the BACnet/IP Settings tab.
Internal Clock ^{*4} :	All settings on the Internal Clock tab will be printed.

*1 HG5G/4G/3G/2G-V, HG4G/3G, HG2G-5F only

*2 HG5G/4G/3G/2G-V, HG4G/3G, HG2G-5F/-5T, HG1G/1P only

*3 HG5G/4G/3G/2G-V only

*4 HG2J-7U only

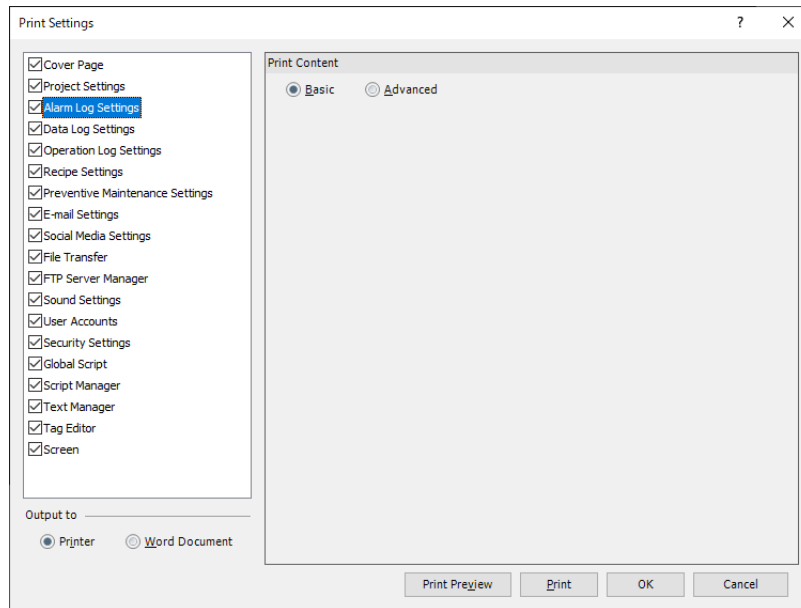
Alarm Log Settings

- **Print Content**

Select the print target to print from **Basic** or **Advanced**.

Basic: **Settings** on the **Channel** tab will be printed.

The settings of numbers that do not use the alarm function will not be printed.

Advanced: Prints the **Basic** print content, the **Storage Method** and the **Monitoring Period** on the **General** tab, and the contents of the **External Memory Device** tab, the **Printing** tab and the **Options** tab.

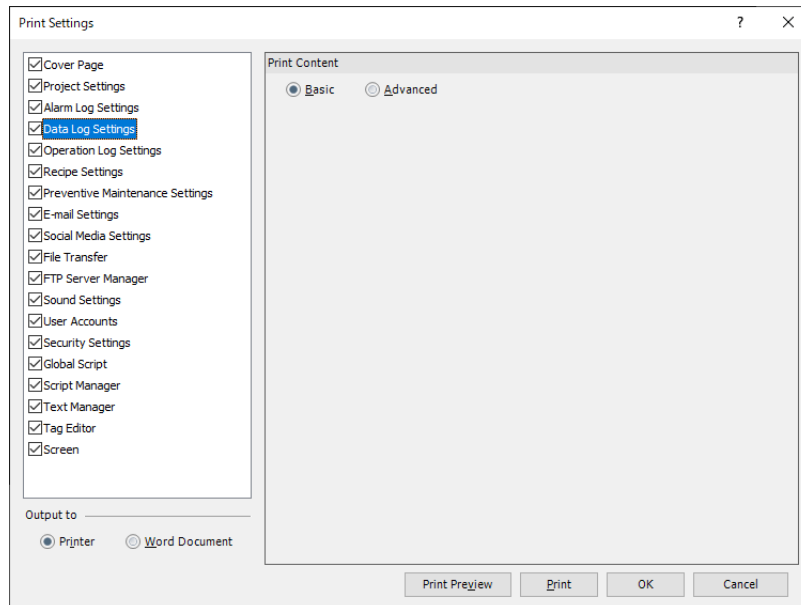
Data Log Settings

- **Print Content**

Select the print target to print from **Basic** or **Advanced**.

Basic: **Settings** will be printed.

Channel numbers for which **Log function** is **Disable** will not be printed.

Advanced: The Basic print content, **Channel Name** and **Condition of Writing to Data Storage Area** on the **General** tab, the **External Memory Device** tab, and the output data of the data sampled for each channel will be printed.

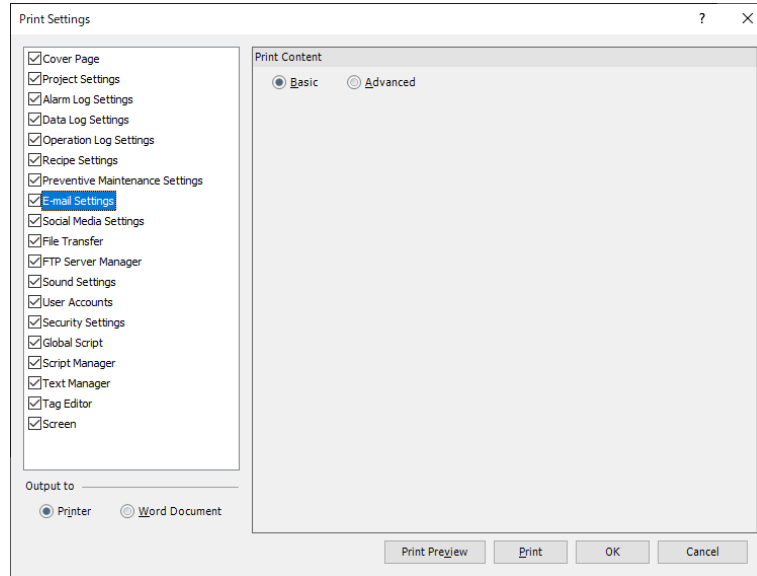
E-mail Settings■ **Print Content**

Select the print target to print from **Basic** or **Advanced**.

Basic: **Settings** will be printed.
Numbers for which **E-mail Function** is **Disable** will not be printed.

Advanced: Only content that differs from the default content will be printed for the **Basic** print content and **E-mail Function, Trigger Condition, and E-mail content** for each number. Numbers for which **E-mail Function** is **Disable** will not be printed.

Social Media Settings

HG2J-7U HG5G-V HG4G-V HG4G HG3G-V HG3G HG2G-V HG2G-5F HG2G-5T HG1G HG1P

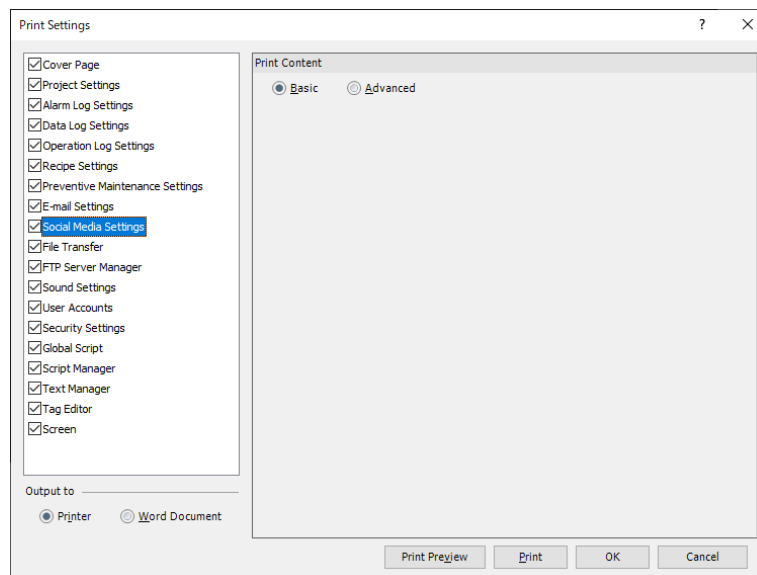
■ **Print Content**

Select the print target to print from **Basic** or **Advanced**.

Basic: **Settings** will be printed.
Numbers for which **Social Media Function** is **Disable** will not be printed.

Advanced: Only content that differs from the default content will be printed for the **Basic** print content and **Social Media Function, Trigger Condition, and Social Media content** for each number. Numbers for which **Social Media Function** is **Disable** will not be printed.

Script Manager

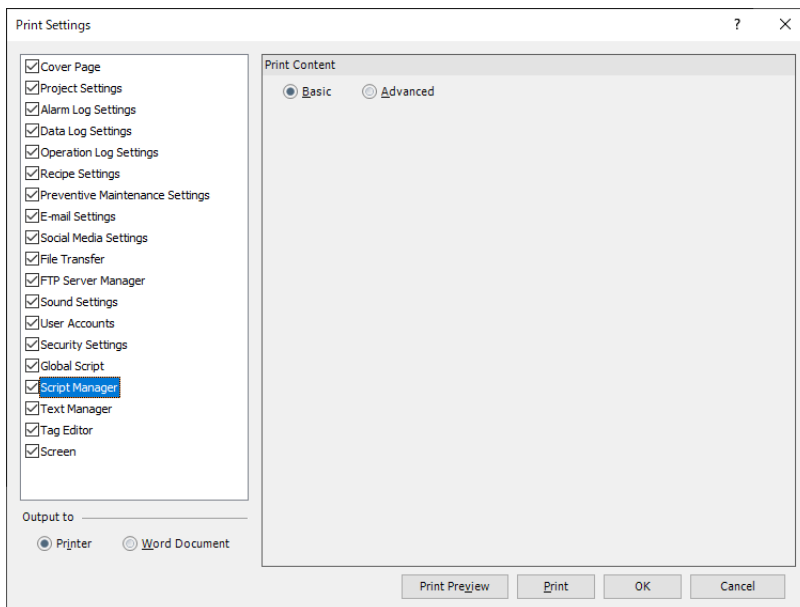

■ **Print Content**

Select the print target to print from **Basic** or **Advanced**.

Basic: Prints the **Script List**.

Advanced: Prints the **Basic** print content and the **Script ID**, the **Script Name**, the **Data Type**, the contents of the registered script.

Text Manager

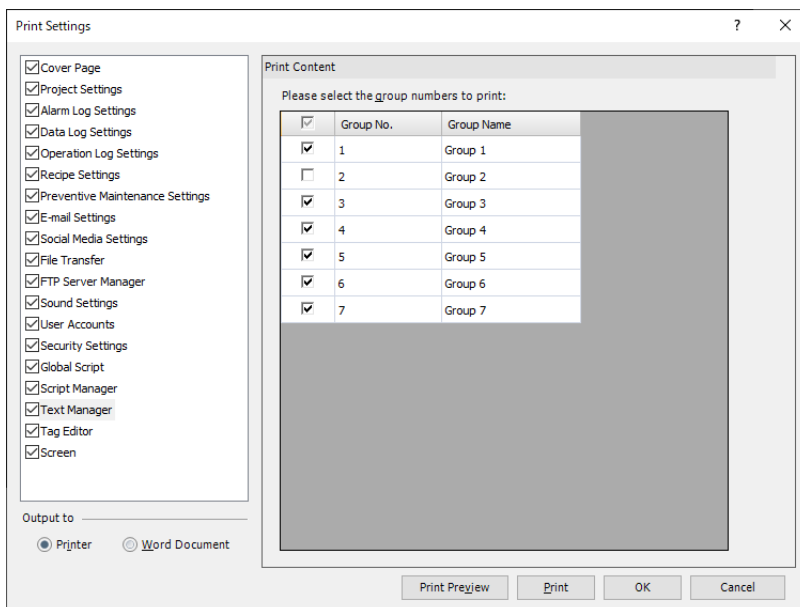

■ **Print Content**

Please select the group numbers to print: Select the check boxes of the Text Group to print the Text Message List. Up to 6 groups can be printed at once.

Group No.: Displays the number of the Text Group.

Group Name: Displays the Text Group Name.

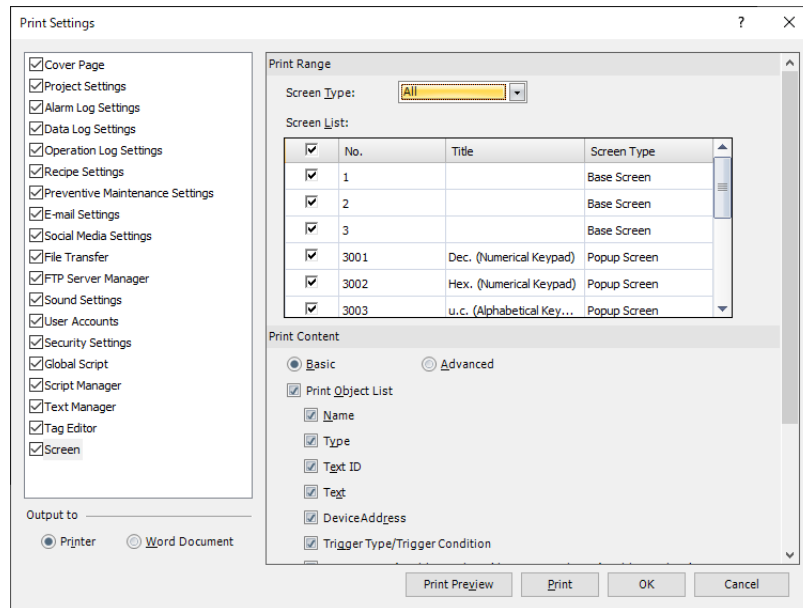
Screen

■ Print Range

Screen Type: Select the screens to print from the following items.

All, Base Screen, Popup Screen

Screen List: This list shows screens that have already been created. Select the check boxes of the screens to print.

■ Print Content

Select the print target to print from **Basic** or **Advanced**.

Print Object List: Select this check box to print the object list.

Select the items of data that will be output when printing the object list. Select the check boxes of the items to output.

Name, Type, Text ID, Text, Device Address, Trigger Type/Trigger Condition, Trigger Type(visible)/Trigger Condition(visible)

■ Screen Image

State: Changes the state of the parts for printing. Select the state from the following items.
OFF, ON, ON, OFF (Both)

Invert white and black: Select this to print the screen by inverting the colors so white is black and black is white.

Display Object No.: Select this check box to display and print object numbers.

Show Part Name: Select this to print the screen by displaying part names.

Show Device Address: Select this to print the screen by displaying device addresses.

● Print Preview Dialog Box

Displays the **Print Preview** dialog box. An image of the layout to print on paper will be displayed in the preview. The layout can be configured while checking the preview. This is a Windows dialog box.

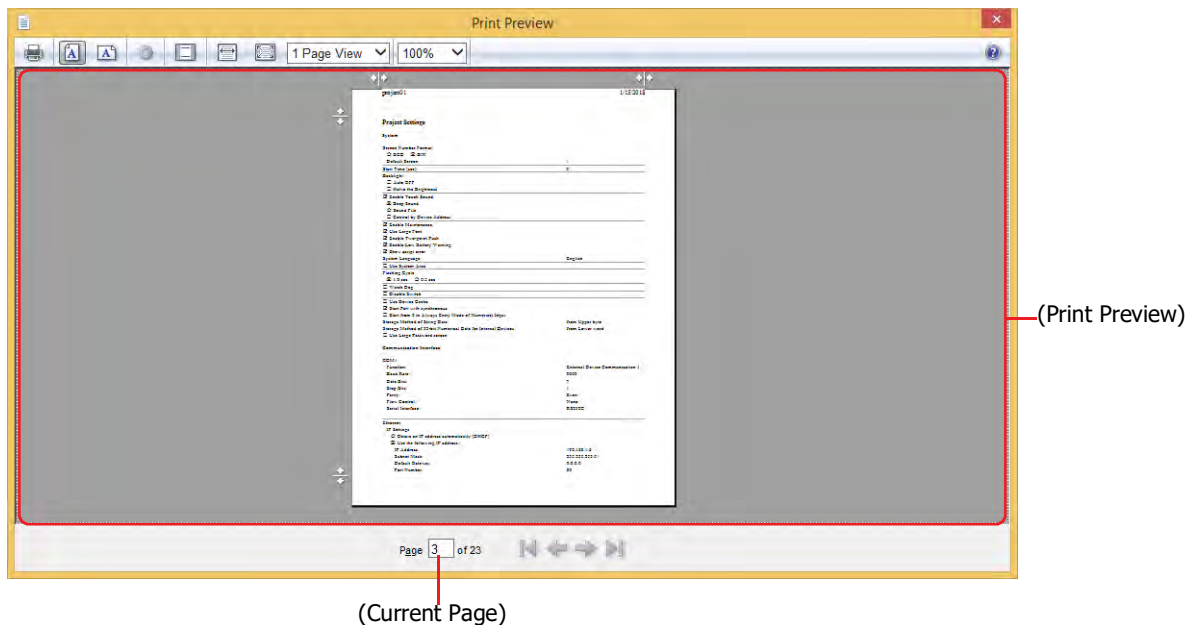

■ (Print Document)

The Windows **Print** dialog box is displayed. The opened project data will be printed. For details, refer to Windows help.

■ (Portrait)

Sets the paper orientation to portrait.

■ (Landscape)

Sets the paper orientation to landscape.

■ (Page Setup)

Displays the **Page Setup** dialog box. Use this dialog box to set up the page layout, such as the page size, orientation, and headers and footers.

■ (Turn Headers and Footers On or Off)

Sets whether or not to print headers and footers when printing. Each click of the button switches between show and hide.

■ (View Full Width)

Use this button to display one page of the print at its full width in the print preview dialog box.

■ (View Full Page)

Use this button to display one entire page of the print in the print preview dialog box.

■ (Show Multiple Pages)

Selects the number of pages to display in the preview from the following options.

1 Page View, 2 Page View, 3 Page View, 6 Page View, 12 Page View

■ (Change Print Size)

Selects the print size on the paper from the following options.

30%, 50%, 60%, 70%, 80%, 85%, 90%, 95%, 100%, 125%, 150%, 200%, Custom



- **(Print Preview)**

Displays a preview of the content that will be printed.

- **(Current Page)**

Indicates the current page number in (Current Page)/(Total Pages) format. You can also enter a page number to display it.



Drag  /  to adjust the margins.

-  **(First Page)**

Displays the first page.

-  **(Previous Page)**

Displays the previous page.

-  **(Next Page)**

Displays the next page.

-  **(Last Page)**

Displays the last page.

1.5 Comparing Project Data

Compares project data during editing with the screens and scripts of saved projects.

- 1 On the **Home** tab, in the **Project** group, click **Compare**.

The Open dialog box is displayed.

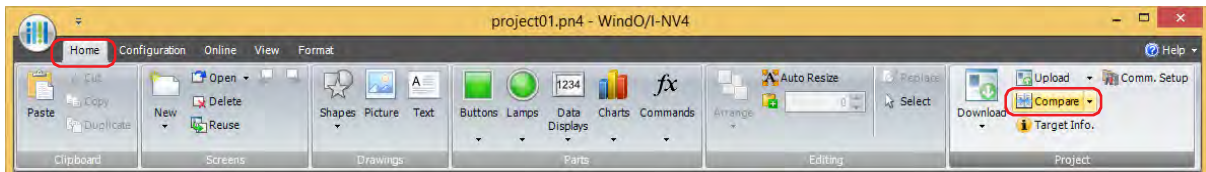

- 2 Select a file to compare with, then click **Open**.

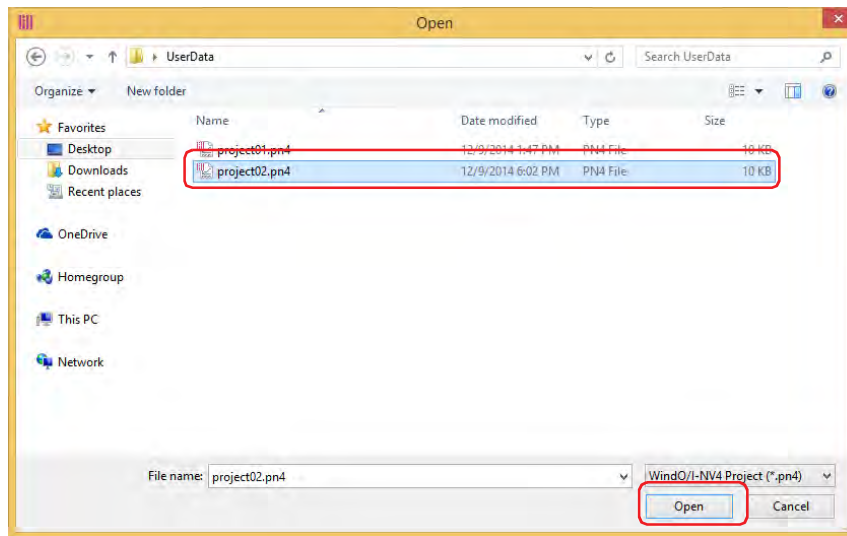

The **Comparison Result** window is displayed.

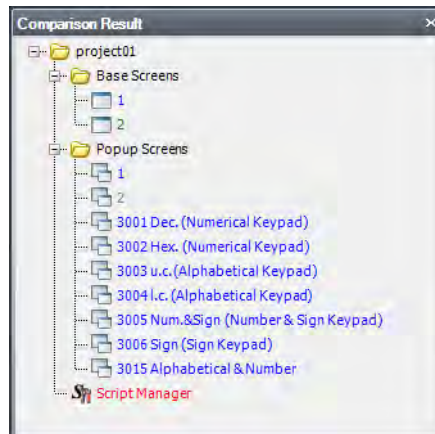

Comparison results are displayed using colored text.

Blue: Complete match

Red: Different content

Green: Only saved in the open project

Gray: Only saved in the comparison project



To compare with the comparison project data again, click the arrow to the right of **Compare** from the **Project** group of the **Home** tab, then click **Recompare**.

1.6 Changing Project Settings

● Changing Product Series

This section describes how to change the product series set in the project data being edited.

- 1 Click **Change Product Series** on the status bar.

The **Change Product Series** dialog box is displayed.

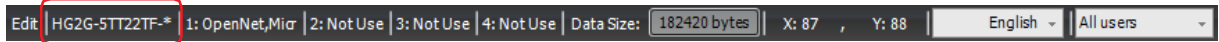

- 2 Select **Product Series**, **Model**, **Installation**, and **Set Conversion Option**, and then click **OK**.

The **Save As** dialog box is displayed.

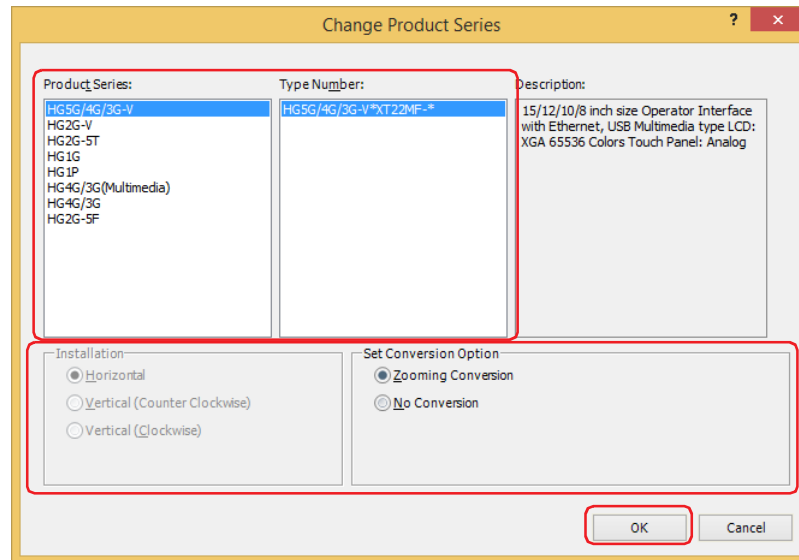

- HG2J-7U project data cannot be converted to HG5G/4G/3G/2G-V, HG4G/3G, HG2G-5F/-5T and HG1G/1P's. Also HG5G/4G/3G/2G-V, HG4G/3G, HG2G-5F/-5T, HG1G/1P project data cannot be converted to HG2J-7U's.
- HG5G/4G/3G/2G-V project data cannot be converted to HG4G/3G and HG2G-5F's.
- Color settings (color data) are not converted.
- If the Popup Screen size is larger than the Base Screen size after the Product Series is changed, the Popup Screen size is changed to the same size as the Base Screen.
- When **Zooming Conversion** is selected as **Set Conversion Option**, note the following points:
 - The coordinates and size of the object are adjusted to fit within the display area of the screen, however, if you convert to a model with a different screen aspect ratio, you may not be able to maintain the coordinate or size ratio.
 - Text and messages are adjusted to fit within the display area of the object, however, you may not be able to maintain the ratio because the font size setting is not in pixels.

- 3 Specify the save location and file name, and then click **Save**.

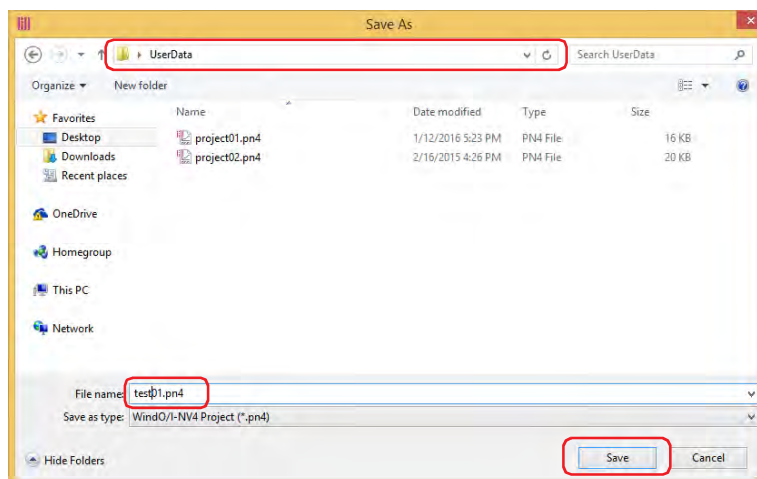

- 4 When the data is finished being converted, click **Close**.

● Changing Communication Drivers

This section describes how to change the communication driver set in the project data being edited.

- 1 With **Communication Driver** on the status bar, click one of **External Device Communication 1** to **External Device Communication 4**.

The **Communication Driver** tab on the **Project Settings** dialog box is displayed.

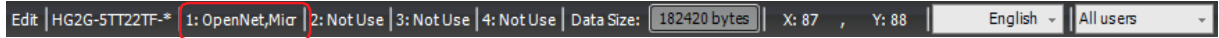

- 2 Change the settings on each tab as necessary.

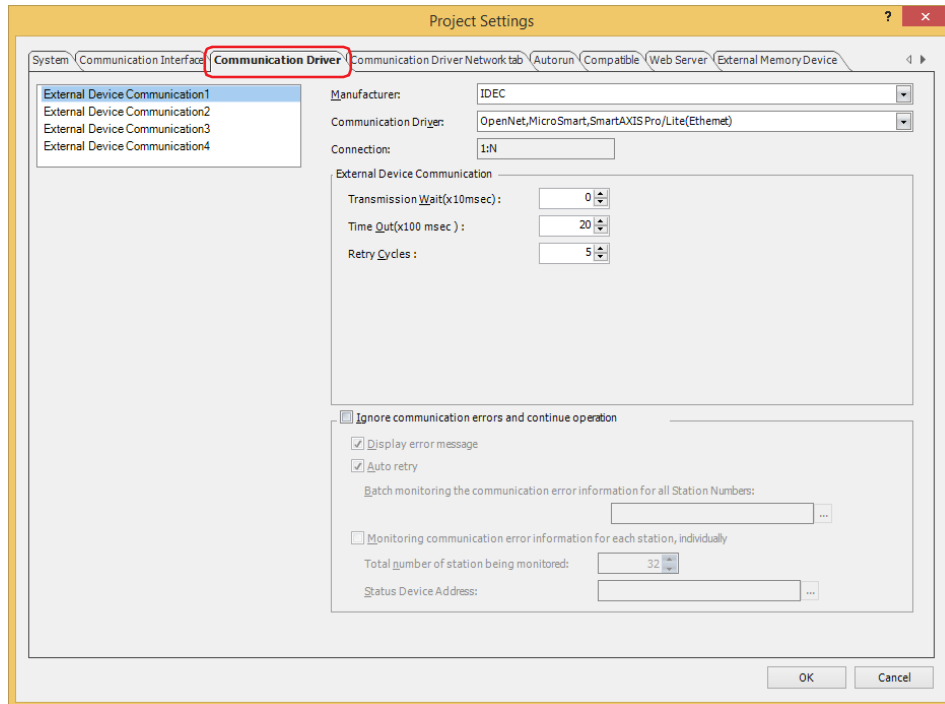

- 3 Click the **Communication Driver Network** tab, change the settings as necessary and then click **OK**. The confirmation message is displayed.

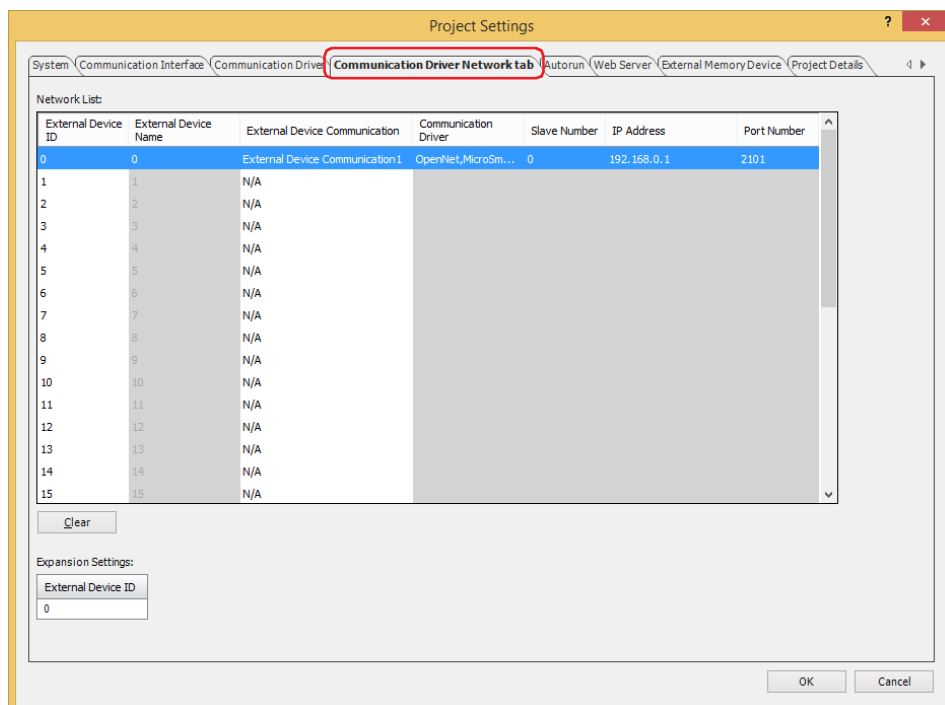

- 4 Check the message and click **Yes**.

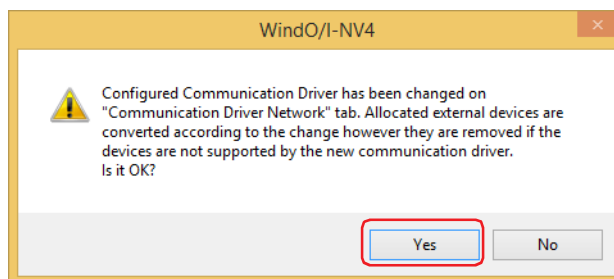

If there are no device addresses that correspond to the external device addresses used in the current project data after changing the communication driver, the items set with those device addresses are blank.

1.7 Closing Project Data

You can close the project data being edited.

Click  and then click **Close**.

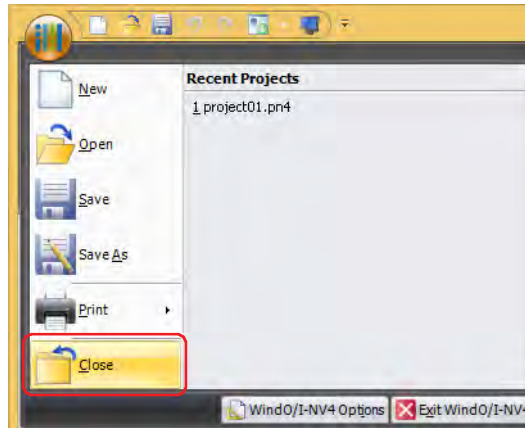

If the project data being edited has not been saved, a confirmation message for saving the project data is displayed.

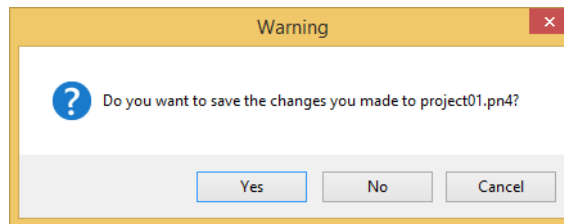

- Click **Yes** to save the project data and close it.
- Click **No** to close the project data without saving changes.
- Click **Cancel** to return to the editing screen without saving the project data.

2 Project Settings Configuration Procedure

HG2J-7U HG5G-V HG4G-V HG4G HG3G-V HG3G HG2G-V HG2G-5F HG2G-5T HG1G HG1P

The **Project Settings** dialog box is used to configure MICRO/I operations and functions for the project overall. This section describes the configuration procedure for project settings.

- 1 On the **Configuration** tab, in the **System Setup** group, click **Project**. The **Project Settings** dialog box is displayed.



- 2 Change the settings on each tab as necessary.

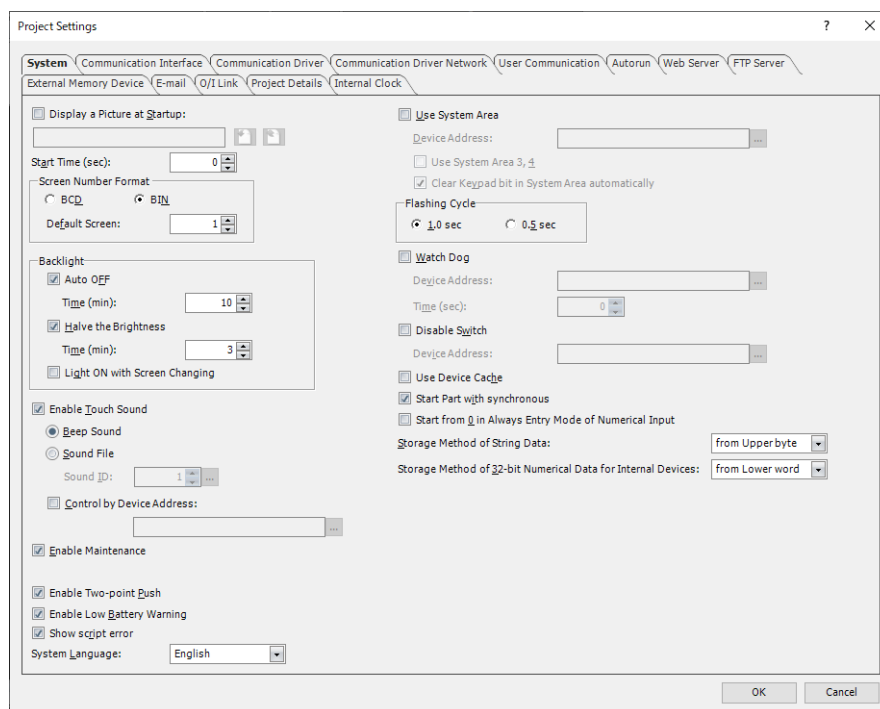

3 Project Settings Dialog Box

HG2J-7U HG5G-V HG4G-V HG4G HG3G-V HG3G HG2G-V HG2G-5F HG2G-5T HG1G HG1P

This section describes items and buttons on the **Project Settings** dialog box.

3.1 System Tab

HG2J-7U HG5G-V HG4G-V HG4G HG3G-V HG3G HG2G-V HG2G-5F HG2G-5T HG1G HG1P

The **System** tab is used to configure MICRO/I operations for the project data overall.

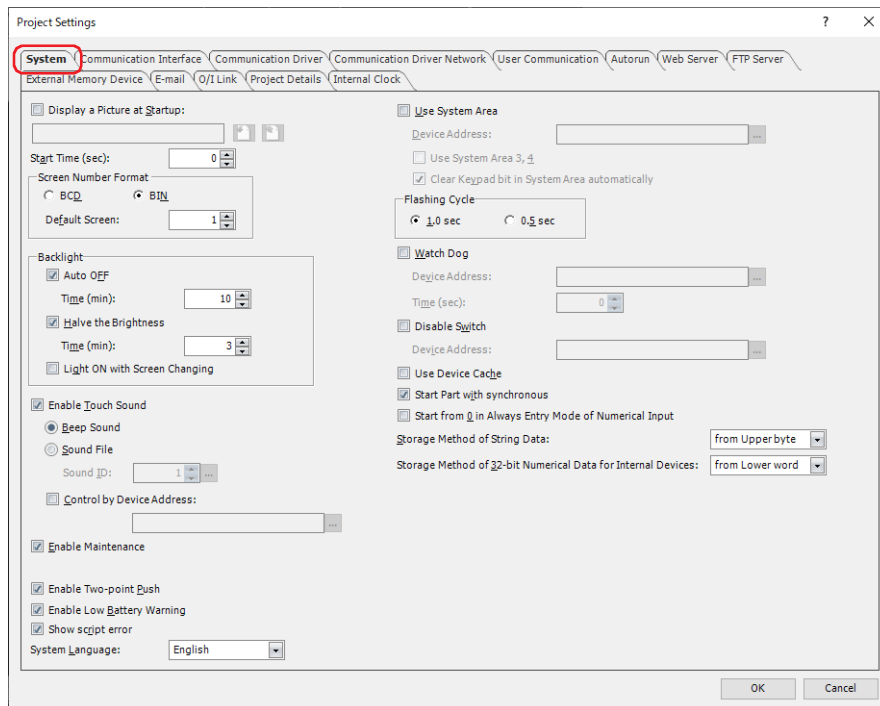

■ Display a Picture at Startup*1

Select this check box to display an image on the screen when MICRO/I is started.

(Image file name): Displays the file name of the imported image.



Shows the Open dialog box.

Select a bitmap format (*.bmp) image file and click Open to import it as an image to be displayed at startup.

The maximum image size that can be used is 800 x 480 dots and 1,160,000 bytes.



Displays the Save As dialog box.

Select the location to save the file, enter a file name, and then click **Save** to save the image file as a bitmap file.

■ Start Time (sec)

It can be set vary based on the MICRO/I model.

HG2J-7U: Specifies the start time of communication with the external device (0 to 9999 seconds) after the MICRO/I power is turned on and the POWER LED (green) changes from blinking to lit.

HG5G/4G/3G/2G-V, HG4G/3G, HG2G-5F/-5T, HG1G/1P:

Specifies the start time of communication with the external device (0 to 9999 seconds) after the MICRO/I power is turned on.

*1 HG2J-7U only

■ Screen Number Format

Selects the type of data to use for the System Area 1 Display screen number (address number+0) as **BCD** or **BIN**.

Default Screen: Specifies the screen number of the base screen to display first when the MICRO/I is turned on (0 to 3000). When 0 is specified, the MICRO/I is in the screen waiting state. Write a screen number to System Area 1 Display screen number (address number+0) or specify the default screen number from 1 to 3000.

■ Backlight

These options configure the backlight control function.

Auto OFF: Select this check box to turn off the backlight when the MICRO/I is unused for an extended period of time. To turn on the backlight, touch the screen or the function keys^{*2}, or write 1 to System Area 1 Backlight auto off bit (address number+1, bit 5) or System Area 1 Backlight bit (address number+1, bit 0).

Time (min): Specifies the time (1 to 9999) from when the MICRO/I is last used to when the backlight is turned off.

Halve the Brightness: Select this check box to lower the backlight brightness when the MICRO/I is unused for an extended period of time. To return to the backlight to its original brightness, touch the screen or write 1 to System Area 1 Backlight bit (address number+1, bit 0).

Time (min): Specifies the time (1 to 9999) from when the MICRO/I is last used to when the backlight brightness is lowered.

Light ON with Screen Changing:

When the backlight is turned off or when the backlight brightness has been lowered with the backlight control function, select this check box to turn on the backlight or restore the backlight brightness when the screen is switched.

This option can only be configured when the **Auto OFF** check box or the **Halve the Brightness** check is selected.

■ Enable Touch Sound

Select this check box to play a sound when the screen is pressed.

(Touch sound)^{*3}: These options select the touch sound.

These options can only be configured when **Enable Touch Sound** is selected.

Beep Sound: Plays a beep (electronic sound).

Sound File: Plays a sound file.

Sound ID: Configures the sound file to play as the touch sound.

Click  to display the **Sound Settings** dialog box. For the sound file configuration procedure, refer to Chapter 21 "To play a sound file as a touch sound instead of a beep." on page 21-3.

Control by Device Address: Select this check box to control the touch sound with a value of device address.

(Device Address): Specifies the word device that controls the touch sound.

Click  to display the Tag Editor. For the device address configuration procedure, refer to Chapter 2 "5.1 Device Address Settings" on page 2-70.

The control over a touch sound with a value of device address is as follows.

0: Do not play the touch sound.

1: Play the touch sound.

2: Play a shortened^{*4} touch sound.

*2 HG1P only

*3 This is applicable for HG2J-7U and models with an audio interface only.

*4 When the Sound File is selected, the sound is the same whether the device address is set to 1 or 2.

■ Enable Maintenance

Select this check box to display the maintenance screen during operation. The methods for displaying the maintenance screen are as follows.

Press the upper-left corner of the MICRO/I screen for three seconds or more.

If the base screen is switched before three seconds have elapsed, the load operation for the maintenance screen will be canceled. Please press the screen again.

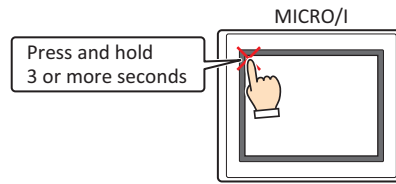

■ Use Large Font*5

Select this check box to display text on the MICRO/I in high-quality fonts. The **Japanese** or **European** font is replaced with the high-quality fonts depending on the magnification.

To use high-quality fonts, the fonts must be downloaded to the MICRO/I at the same time as the project. To download fonts, specify the high-quality fonts under **Optional Fonts to be downloaded** in the **Font Settings** tab. For details on high-quality fonts, refer to Chapter 2 "High-quality Fonts" on page 2-10.

■ Enable Two-point Push

Select this check box to enable two-point push for touch switches. When two-point push is enabled, the bottom switch and the switch above it operate in order.

On an analog touch panel*5, this function operates two overlapping switches when the two are pressed. This is not a function to simultaneously operate two non-overlapping switches when they are both pressed.

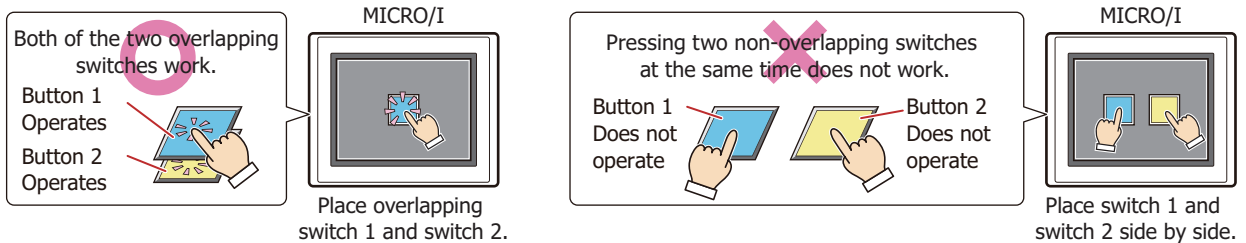

On a projected capacitive touch panel*1, this function operates both switches even when two non-overlapping touch switches are pressed at the same time.

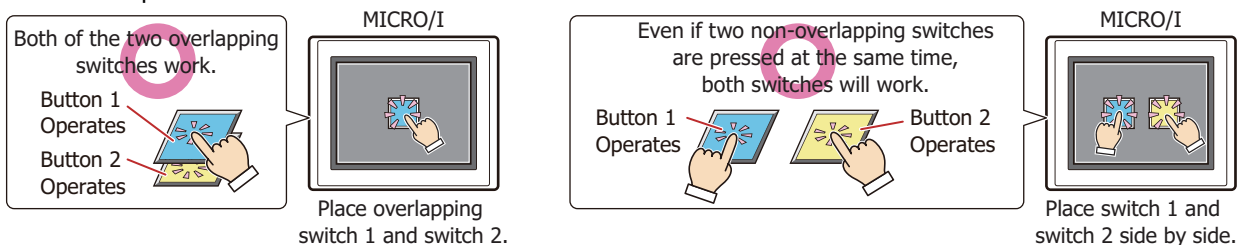

The overlapping touch switches and the non-overlapping touch switch are pressed at the same time on the projected capacitive touch panel;

- If you press the overlapping touch switches first, the non-overlapping touch switches will not operate.

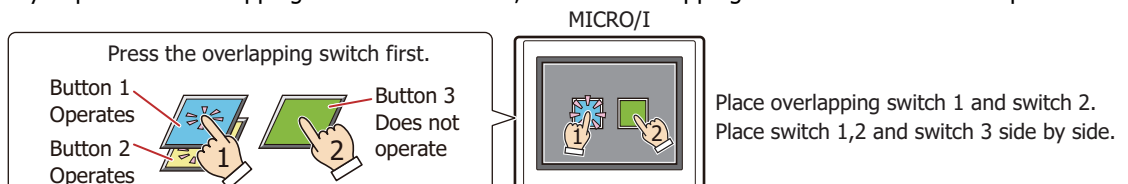

- If you press the non-overlapping touch switch first, only the back switch of the overlapping touch switches will operate.

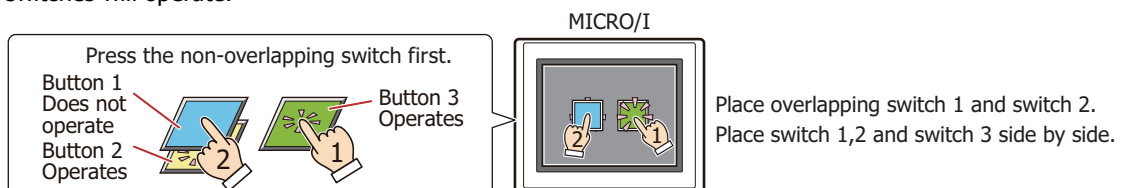

*1 HG2J-7U only

*5 HG5G/4G/3G/2G-V, HG4G/3G, HG2G-5F/-5T, HG1G/1P only

■ Enable Low Battery Warning*6

Select this check box to display a warning message when the backup battery is dead.

This option also displays a warning message when it is time to replace the battery.

■ Show script error

Select this check box to display an error message on the screen when a script error occurs.



Script error information is saved to the HMI Special Data Registers (LSD52 and LSD53). For details, refer to Chapter 20 "1.4 Script Error" on page 20-4.

■ System Language

Selects the display language for the Maintenance screen, System Mode screens, Device Monitor, and Adjust Brightness screen as **English** or **Japanese**.

For details, refer to Chapter 34 "1 Maintenance Screen" on page 34-1.

■ Use System Area

The System Area is an area of predetermined device addresses to control the screen and communicate error information and time information between the MICRO/I and the external device. Select this check box to use the System Area. For details, refer to "System Area" on page 4-30.

Device Address: Specifies the word device to use as the System Area. The System Area is allocated starting from the configured device address.

Click to display the Tag Editor. For the device address configuration procedure, refer to Chapter 2 "5.1 Device Address Settings" on page 2-70.

Use System Area 3, 4:

Select this check box to use System Area 3 and 4.

Clear Keypad bit in System Area automatically:

Select this check box to automatically set the System Area 2 numerical input setting and character input setting bits to 0 after they have been set to 1.

The System Area 2 bits cleared by this function are as follows.

Numerical input setting complete (address number+3, bit 0)

Numerical input setting cancel (address number+3, bit 1)

Character input setting complete (address number+3, bit 5)

Character input setting complete (address number+3, bit 6)

■ Flashing Cycle

Selects the cycle when flashing (displaying a drawing object by switching it on and off at a fixed interval) drawings and parts as **1.0 sec** or **0.5 sec**.

■ Watch Dog

Select this check box to monitor on the external device side whether or not the MICRO/I and the external device are communicating by writing a set value (00FF (Hex)) at a fixed interval.

Device Address: Specifies the word device to write the value.

Click to display the Tag Editor. For the device address configuration procedure, refer to Chapter 2 "5.1 Device Address Settings" on page 2-70.

Time (sec): Specifies the interval to write the value (1 to 65535).

■ Disable Switch

Select this check box to enable and disable touch switches with a value of device address.

Touch switches are enabled when the value of device address is 1. They are disabled when the device value is 0.

Device Address: Specifies the bit device or the bit number of the word device that is read to enable or disable touch switches.

Click to display the Tag Editor. For the device address configuration procedure, refer to Chapter 2 "5.1 Device Address Settings" on page 2-70.

*6 HG5G/4G/3G/2G-V, HG4G/3G, HG2G-5F/-5T, HG1G only

■ Use Device Cache

Select this check box to execute processing by reading all the values of the external device addresses configured for a screen when switching the base screen or when displaying a popup screen.

■ Start Part with synchronous

Select this check box to operate commands and HMI Special Internal Relays LSM1, LSM2, LSM3, and LSM5 after reading all the values of the external device addresses configured on the screen.

When this check box is cleared, all processing is immediately executed when the screen is displayed.

■ Start from 0 in Always Entry Mode of Numerical Input

Select this check box to display 0 when a Numerical Input that has the **Always Entry Mode** check box selected on the **General** tab is displayed on the screen. When this check box is cleared, the value of device address is displayed. This option is reflected for all Numerical Inputs configured in the project.

■ Storage Method of String Data

Selects the handling method for text entered with the Character Input and values of device addresses read by the Message Display.

from Upper byte: Values of device addresses are read from and written to the upper order byte.

Example: When the text ABCDE is entered with the Character Input and written to the destination device address LDR100

Device address	Stored value	
	Upper byte	Lower byte
LDR100	'A' = 41 (Hex)	'B' = 42 (Hex)
LDR101	'C' = 43 (Hex)	'D' = 44 (Hex)
LDR102	'E' = 45 (Hex)	0

NULL terminating character

from Lower byte: Values of device addresses are read from and written to the lower order byte.

Example: When the text ABCDE is entered with the Character Input and written to the destination device address LDR100

Device address	Stored value	
	Upper byte	Lower byte
LDR100	'B' = 42 (Hex)	'A' = 41 (Hex)
LDR101	'D' = 44 (Hex)	'C' = 43 (Hex)
LDR102	0	'E' = 45 (Hex)

NULL terminating character



When handling strings, 0 is written to the device address as the NULL terminating character and treated as the end of the string.

■ Storage Method of 32-bit Numerical Data for Internal Devices

Selects the handling method for values of internal devices when **UBIN32(D)**, **BIN32(L)**, **BCD8(EB)**, or **Float32(F)** is selected for **Data Type** from the following. The initial value is set according to the communication driver that was selected when the project was created. When the bit devices in control devices are handled as words, this setting is always the **from Lower word**.

from Upper word: Values of internal devices are read from and written to the upper order word.

Example: When **Data Type** for the Numerical Input is **UBIN32(D)** and the numerical value 12345678 (Hex) was entered and written to destination device address LDR100

Device address	Stored value	
LDR100	1234 (Hex)	Upper word
LDR101	5678 (Hex)	Lower word

from Lower word: Values of internal devices are read from and written to the lower order word.

Example: When **Data Type** for the Numerical Input is **UBIN32(D)** and the numerical value 12345678 (Hex) was entered and written to destination device address LDR100

Device address	Stored value	
LDR100	5678 (Hex)	Upper word
LDR101	1234 (Hex)	Lower word

● System Area

Overview

The area of predetermined device addresses to control the screen and communicate error information and time information between the MICRO/I and the external device is called the System Area.

The System Area on the MICRO/I is as follows.

System Area	Number of word addresses	MICRO/I Operations
System Area 1	2	Read and write
System Area 2	2	Write
System Area 3	4	Read
System Area 4	4	Write

To use System Area 1 and 2, select the **Use System Area** check box on the **Project Settings** dialog box. To use System Area 3 and 4, select the **Use System Area 3, 4** check box.

Specify the word device to use as the System Area in **Device Address** to allocate the System Area starting at the configured device address.

Click  to display the Tag Editor. For the device address configuration procedure, refer to Chapter 2 "5.1 Device Address Settings" on page 2-70.

Example: When **Device Address** is configured as LDR100

(The address number of Top Device Address)	LDR100	} System Area 1
+1	LDR101	
+2	LDR102	} System Area 2
+3	LDR103	
+4	LDR104	} System Area 3
+5	LDR105	
+6	LDR106	
+7	LDR107	
+8	LDR108	} System Area 4
+9	LDR109	
+10	LDR110	
+11	LDR111	

System Area 1

This area configures the MICRO/I display, beep, and clearing bits.

Address number	Bit	Function	Description
+0	0 to 15	Display screen number	This bit stores the number of the screen being displayed. Write a value to this bit to change the screen to that number. Immediately after the power is turned on, the value configured by Default Screen in the Project Settings dialog box is stored here. This is the data type specified in Screen Number Format on the Project Settings dialog box. If the screen number is not exist in the project, "No Screen Data" message will be displayed. If 0xFFFF (Hex) is written to this bit, MICRO/I will display the Top Page of System Mode. However, when 0 is written to this bit, the screen is not switched and no error message is displayed.
+1	0	Backlight	This bit stores the illumination state of the backlight. Write a value to this bit to change the state. 0: Off Turns the backlight off. 1: On Turns the backlight on.
	1	Flash display (1 sec. cycle)	This bit stores the screen flash state (1 sec. cycle). Write a value to this bit to change the state. This bit is 0 immediately after the power is turned on. 0: Do not flash Stop flashing the screen and turn it on. 1: Flash Flashes the screen in one second intervals. When the Flash display (1 sec. cycle) (address number+1, bit 1) and the Flash display (0.5 sec. cycle) (address number+1, bit 2) are both 1, the screen flashes at one second intervals.

Address number	Bit	Function	Description
+1	2	Flash display (0.5 sec. cycle)	This bit stores the screen flash state (0.5 sec. cycle). Write a value to this bit to change the state. This bit is 0 immediately after the power is turned on. 0: Do not flash Stop flashing the screen and turn it on. 1: Flash Flashes the screen in 0.5 second intervals. When the Flash display (1 sec. cycle) (address number+1, bit 1) and the Flash display (0.5 sec. cycle) (address number+1, bit 2) are both 1, the screen flashes at one second intervals.
	3 to 4	Reserved	
	5	Backlight auto off	This bit stores whether or not the function to automatically turn off the backlight is enabled when the Auto OFF check box is selected under Backlight in the Project Settings dialog box. Write a value to this bit to change the state. This bit is 0 immediately after the power is turned on. 0: Enabled Automatically turns off the backlight when the MICRO/I is unused for an extended period of time. 1: Disabled Does not automatically turn off the backlight when the MICRO/I is unused for an extended period of time. The backlight turns on if the value changes to 1 when the backlight is off.
	6	Beep	This bit stores the beep state. Write a value to this bit to change the state. This bit is 0 immediately after the power is turned on. 0: Stop Stops continuous beeping. 1: Beep Starts continuous beeping.
	7	Screen display	This bit stores the screen display state. Write a value to this bit to change the state. 0: Hide Hides the screen when the backlight is on. 1: Show Displays the screen.
	8	Reserved	
	9	Clear error	Write 1 to this bit to clear the error information bit (System Area 2, address number+2). This bit automatically changes to 0 when processing is finished.
	10	Numerical input setting clear	Write 1 to this bit to clear the Numerical input setting complete bit (System Area 2 address number+3, bit 0) and the Numerical input setting cancel bit (System Area 2 address number+3, bit 1). This bit automatically changes to 0 when processing is finished.
	11	Character input setting clear	Write 1 to this bit to clear the Character input setting complete bit (System Area 2 address number+3, bit 5) and the Character input setting cancel bit (System Area 2 address number+3, bit 6). This bit automatically changes to 0 when processing is finished.
	12 to 15	Reserved	

System Area 2

This area stores MICRO/I states and error information. These bits are 0 immediately after the power is turned on.

Address number	Bit	Function	Description
+2	0 to 2	Reserved	
	3	Communication error	This bit changes to 1 when a communication error occurs in external device communication. To clear this bit, write 1 to the Clear error bit (System Area 1 address number+1, bit 9).
	4	Reserved	
	5	Processing error	This bit changes to 1 when executing the following arithmetic operations. To clear this bit, write 1 to the Clear error bit (System Area 1 address number+1, bit 9). <ul style="list-style-type: none"> • There is data which cannot be handled with the specified data type; BCD4(B), BCD8(EB), or Float32(E). • A value is divided by 0. • The setting of Origin, Minimum, or Maximum for the Bar Chart or Line Chart are invalid, or the Minimum and Maximum are the same values. • The setting of Minimum, Maximum, or ranges for the Meter are invalid, or the Minimum and Maximum are the same values. • There is invalid clock data which is used in Calendar parts.
	6	Device range error	This bit changes to 1 when writing a value to a device address that falls outside its range or when exceeding the restrictions on the number of configured device addresses. To clear this bit, write 1 to the Clear error bit (System Area 1 address number+1, bit 9).
	7	Clock IC error*1	This bit changes to 1 when the MICRO/I internal clock stops. To clear this bit, write 1 to the Clear error bit (System Area 1 address number+1, bit 9).
	8	External memory device (A:) access error	This bit changes to 1 when an error occurs when the external memory*2 device inserted in the MICRO/I is accessed. To clear this bit, write 1 to the Clear error bit (System Area 1 address number+1, bit 9).
	9	Printer timeout error*1	This bit changes to 1 when a printing error occurs when data is output to the printer connected to the MICRO/I. To clear this bit, write 1 to the Clear error bit (System Area 1 address number+1, bit 9).
	10	Script error	This bit changes to 1 when an error occurs during script execution. Error details are stored in HMI Special Data Registers LSD52 and LSD53. For details, refer to Chapter 20 "1.4 Script Error" on page 20-4. To clear this bit, write 1 to the Clear error bit (System Area 1 address number+1, bit 9).
	11	External memory device (B:) access error*3	This bit changes to 1 when an error occurs when accessing an inserted USB flash drive.
	12	Replace battery error*4	This bit changes to 1 when it is time to replace the backup battery. To clear this bit, write 1 to the Clear error bit (System Area 1 address number+1, bit 9).
	13	Replace battery error (low battery)*4	This bit changes to 1 when the backup battery is low. To clear this bit, write 1 to the Clear error bit (System Area 1 address number+1, bit 9).
	14	Backup data error*5	This bit changes to 1 when the data sampled by the log functions, the clock data and values in the HMI Keep Registers and HMI Keep Relays disappears*6. To clear this bit, write 1 to the Clear error bit (System Area 1 address number+1, bit 9).
	15	Reserved	

*1 HG5G/4G/3G/2G-V, HG4G/3G, HG2G-5F only

*2 USB flash drive inserted in USB1 for HG2J-7U, SD memory card for HG5G/4G/3G-V, HG4G/3G and HG2G-5F

*3 HG2G-5T, HG1G/1P only

*4 HG5G/4G/3G/2G-V, HG4G/3G, HG2G-5F/-5T, HG1G only

*5 HG2J-7U, HG5G/4G/3G/2G-V, HG4G/3G, HG2G-5F/-5T, HG1G only

*6 Only clock data is lost for HG2J-7U.

Address number	Bit	Function	Description
+3	0	Numerical input setting complete	This bit changes to 1 when finished entering a numerical value with the Numerical Input. This bit changes to 0 when entering a numerical value or when entering a numerical value has been canceled. Write 1 to numerical input setting clear (address number+1, bit 10) to clear this bit.
	1	Numerical input setting cancel	This bit changes to 1 when entering a numerical value with the Numerical Input was canceled. This bit changes to 0 when entering a numerical value or when entering a numerical value has been completed. Write 1 to numerical input setting clear (address number+1, bit 10) to clear this bit.
	2	Backlight auto off running	The value of this bit changes to 1 when Auto OFF is configured and the backlight was turned off by this function. To configure Auto OFF , select the Auto OFF check box under Backlight in the Project Settings dialog box. This bit automatically changes to 0 when the backlight turns on.
	3	Sending output to a printer	This bit changes to 1 when sending output to the printer. This bit automatically changes to 0 when finished sending output.
	4	Transferring recipe	This bit changes to 1 when transferring recipe data. This bit automatically changes to 0 when the transfer is finished.
	5	Character input setting complete	This bit changes to 1 when finished entering text with the Character Input. This bit changes to 0 when entering text or when entering text has been canceled. Write 1 to character input setting clear (address number+1, bit 11) to clear this bit.
	6	Character input setting cancel	This bit changes to 1 when entering text with the Character Input is canceled. This bit changes to 0 when entering text or when entering text has been completed. Write 1 to character input setting clear (address number+1, bit 11) to clear this bit.
7 to 15	Reserved		

System Area 3

This area is for changing the MICRO/I internal clock data.

Address number	Bit	Function	Description
+4	0 to 7	Clock data Month	Enter Month (01 to 12) as a 2 digit BCD.
	8 to 15	Clock data Year	Enter Year (00 to 99) as a 2 digit BCD.
+5	0 to 7	Clock data Hour	Enter Hour (00 to 23) as a 2 digit BCD.
	8 to 15	Clock data Day	Enter Day (01 to 31) as a 2 digit BCD.
+6	0 to 7	Clock data Second	Enter Second (00 to 59) as a 2 digit BCD.
	8 to 15	Clock data Minute	Enter Minute (00 to 59) as a 2 digit BCD.
+7	0 to 14	Reserved	Enter 0 in the reserved area.
	15	Update	Write 1 to this bit to write the entered data (address number+4 to +6, bits 0 to 15) to the MICRO/I internal clock data.



When the value of the update bit (address number+7, bit 15) becomes 1, the clock data is updated as a whole.

Year, month, day, hour, minute, and second cannot be set individually.

System Area 4

This area reads the MICRO/I internal clock data in one minute intervals.

Address number	Bit	Function	Description
+8	0 to 7	Clock data Month	These bits store the current Month (01 to 12) value as a 2 digit BCD.
	8 to 15	Clock data Year	These bits store the current Year (00 to 99) value as a 2 digit BCD.
+9	0 to 7	Clock data Hour	These bits store the current Hour (00 to 23) value as a 2 digit BCD.
	8 to 15	Clock data Day	These bits store the current Day (01 to 31) value as a 2 digit BCD.
+10	0 to 7	Reserved	
	8 to 15	Clock data Minute	These bits store the current MICRO/I clock data Minute (00 to 59).
+11	0 to 3	Clock data Day of Week	These bits store the current Day of Week value as a 2 digit BCD. The relationship between the day of the week and the value is as follows. 00: Sunday 01: Monday 02: Tuesday 03: Wednesday 04: Thursday 05: Friday 06: Saturday
	4 to 15	Reserved	

3.2 Communication Interface Tab

HG2J-7U HG5G-V HG4G-V HG4G HG3G-V HG3G HG2G-V HG2G-5F HG2G-5T HG1G HG1P

The **Communication Interface** tab is used to configure the functions used by the MICRO/I communication interfaces.

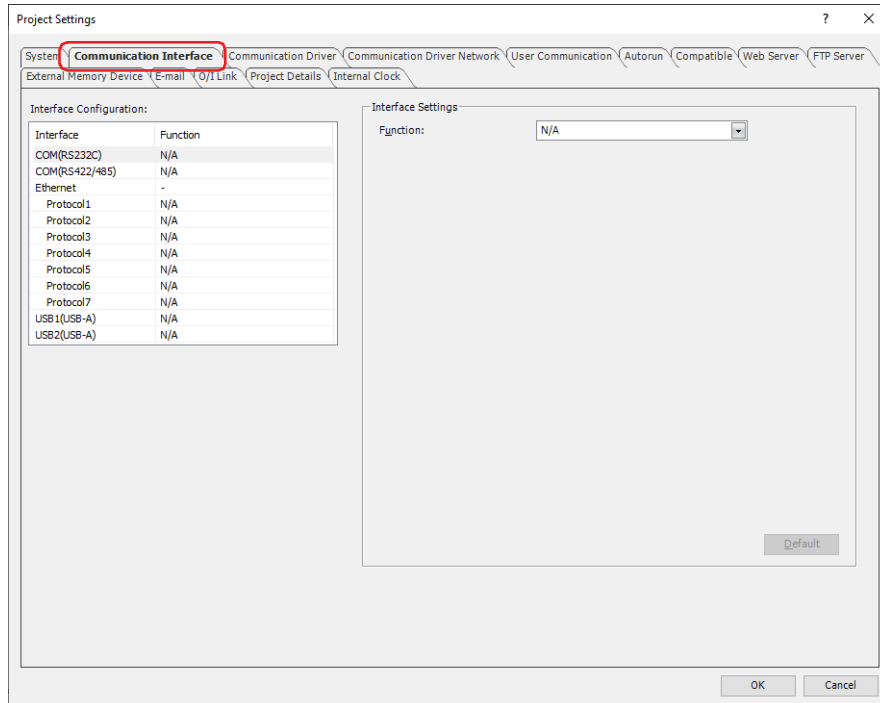

■ Interface Configuration

Interface Configuration lists the communication interfaces and functions to use. Select the appropriate **Interface** (COM1, COM2, etc.) to switch **Interface Settings** to the items that can be configured for that communication interface.

The items displayed in **Interface** vary based on the MICRO/I model. The supported functions for each communication interface are as follows.

HG2J-7U

Name	Interface	Function						
		External Device Communication 1 to 4	O/I Link Master	O/I Link Slave	User Communication 1 to 3	Maintenance Communication	Wireless LAN	Speaker
COM (RS232C)	Serial Interface (RS232C)	YES	NO	NO	YES	NO	NO	NO
COM (RS422/485)	Serial Interface (RS422/485)	YES	YES	YES	YES	NO	NO	NO
Ethernet	Ethernet Interface	YES	NO	NO	YES	YES	NO	NO
USB1 (USB-A)	USB Interface (Type A)	NO	NO	NO	YES	NO	YES	YES
USB2 (USB-B)	USB Interface (Type A)	NO	NO	NO	NO	YES	YES	YES



When **External Memory Device** is selected as **Save To** for the sound file in **Sound Settings**, configures **Speaker** to **USB2(USB-A)**.

HG5G/4G/3G/2G-V

Name	Interface	Function						
		External Device Communication 1 to 4	O/I Link Master	O/I Link Slave	User Communication 1 to 3	Sub Host Communication	Printer	Maintenance Communication
COM1	Serial Interface (RS232C or RS422/485)	YES	YES*1	YES*1	YES	YES	NO	NO
COM2 (RS232C)	Serial Interface (RS232C)	YES	NO	NO	YES	YES	NO	NO
COM2 (RS422/485)	Serial Interface (RS422/485)	YES	YES	YES	YES	YES	NO	NO
Ethernet	Ethernet Interface	YES	NO	NO	YES	NO	NO	YES
USB2 (USB-A)	USB Interface (Type A)	NO	NO	NO	YES	NO	NO	NO
USB1 (USB-B)	USB Interface (Mini-B)	NO	NO	NO	NO	NO	YES	YES

HG4G/3G, HG2G-5F

Name	Interface	Function						
		External Device Communication 1 to 4	O/I Link Master	O/I Link Slave	User Communication 1 to 3	Sub Host Communication	Printer	Maintenance Communication
COM1	Serial Interface (RS232C or RS422/485)	YES	YES*1	YES*1	YES	YES	NO	NO
COM2	Serial Interface (RS232C or RS422/485)	YES	YES*1	YES*1	YES	YES	NO	NO
Ethernet	Ethernet Interface	YES	NO	NO	YES	NO	NO	YES
USB2 (USB-A)	USB Interface (Type A)	NO	NO	NO	YES	NO	NO	NO
USB1 (USB-B)	USB Interface (Mini-B)	NO	NO	NO	NO	NO	YES	YES

HG2G-5T

Name	Interface	Function					
		External Device Communication 1 to 4	O/I Link Master	O/I Link Slave	User Communication 1 to 3	Sub Host Communication	Maintenance Communication
SERIAL1(RS232C)	Serial Interface (RS232C)	YES	NO	NO	YES	YES	NO
SERIAL1(RS422/485)	Serial Interface (RS422/485)	YES	YES	YES	YES	YES	NO
Ethernet	Ethernet Interface	YES	NO	NO	YES	NO	YES
USB2(USB-A)	USB Interface (Type A)	NO	NO	NO	YES	NO	NO
USB(USB-B)	USB Interface (Mini-B)	NO	NO	NO	NO	NO	YES

*1 RS422/485 only

HG1G/1P

Name	Interface	Function					
		External Device Communication 1 to 4	O/I Link Master	O/I Link Slave	User Communication 1 to 3	Sub Host Communication	Maintenance Communication
COM(RS232C)* ²	Serial Interface (RS232C)	YES	NO	NO	YES	YES	NO
COM(RS422/485)	Serial Interface (RS422/485)	YES	YES	YES	YES	YES	NO
Ethernet	Ethernet Interface	YES	NO	NO	YES	NO	YES
USB2(USB-A)	USB Interface (Type A)	NO	NO	NO	YES	NO	NO
USB1(USB-B)	USB Interface (Mini-B)	NO	NO	NO	NO	NO	YES





Functions Available with the Serial Interface

The following functions can be used with MICRO/I models equipped with the serial interface.

- Barcode reader connection
 Refer to Chapter 3 "5 User Communication" on page 3-8.

Functions Available with the Ethernet Interface

The following functions can be used with MICRO/I models equipped with the Ethernet interface.

- Online
 Refer to Chapter 24 "Online Function" on page 24-1.
- Debug
 Refer to Chapter 25 "Monitor Function" on page 25-1.
- Web Server
 Refer to Chapter 28 "1 Web Server Function" on page 28-1.
- BACnet Communication*³
 Refer to Chapter 3 "7 BACnet Communication" on page 3-94.







*2 Only special product of HG1P is equipped with a serial interface (RS232C).

*3 HG5G/4G/3G/2G-V only

Functions Available with the USB Interface

The following functions can be used with MICRO/I models equipped with a USB interface. Available functions vary based on the MICRO/I model.

MICRO/I functions	HG2J-7U	HG5G/4G/3G/2G-V, HG4G/3G, HG2G-5F	HG2G-5T, HG1G/1P
Online	NO	YES	YES
Debug	NO	YES	YES
Printer connection	NO	YES	NO
Barcode reader connection	YES	YES	YES
Wireless LAN connection	YES	NO	NO
Speaker connection	YES	NO	NO

- Online
 Refer to Chapter 24 "Online Function" on page 24-1.
- Debug
 Refer to Chapter 25 "Monitor Function" on page 25-1.
- Printer connection
 Refer to Chapter 32 "Printer" on page 32-1.
- Barcode reader connection
 Refer to Chapter 3 "5 User Communication" on page 3-8.
- Wireless LAN adapter connection
 Refer to " When USB1(USB-A) or USB2(USB-A) is selected under Interface Configuration" on page 4-45.
- Speaker connection
 Refer to Chapter 21 "Sound Function" on page 21-1.

■ Interface Settings

The items that can be configured vary based on the communication interface selected under **Interface Configuration**.



With multiple communication interfaces, **External Device Communication 1 to External Device Communication 4, User Communication 1 to User Communication 3, Wireless LAN^{*4}** or **Speaker^{*4}** on the **Function** cannot be configured in multiple settings.

When COM1, COM2, COM2(RS232C), or COM2(RS422/485) is selected under Interface Configuration

The items displayed in the **Interface** vary based on the MICRO/I model.

HG5G/4G/3G/2G-V: **COM1, COM2(RS232C), COM2(RS422/485)**

HG4G/3G, HG2G-5F: **COM1, COM2**

Function: Selects the function to use with the serial interface from the following.
N/A, External Device Communication 1, External Device Communication 2, External Device Communication 3, External Device Communication 4, O/I Link Master, O/I Link Slave, User Communication 1, User Communication 2, User Communication 3, Sub Host Communication

The **O/I Link Master** and the **O/I Link Slave** can only be configured when the **COM1**, the **COM2** or the **COM2(RS422/485)** is selected for the **Interface** under the **Interface Configuration**.

Baud Rate: Selects the communication speed with the external device from the following.
1200, 2400, 4800, 9600, 19200, 38400, 57600, 115200, 187500
 The baud rate that can be configured varies based on **Function**.

Data Bits: Selects the data length as **7** or **8**.
 This option can only be configured when **External Device Communication 1, External Device Communication 2, External Device Communication 3, External Device Communication 4, User Communication 1, User Communication 2, User Communication 3**, or **Sub Host Communication** is selected for **Function**.

Stop Bits: Selects the stop bits as **1** or **2**.
 This option can only be configured when **External Device Communication 1, External Device Communication 2, External Device Communication 3, External Device Communication 4, User Communication 1, User Communication 2, User Communication 3**, or **Sub Host Communication** is selected for **Function**.

Parity: Selects the parity from the following.
None, Odd, Even
 This option can only be configured when **External Device Communication 1, External Device Communication 2, External Device Communication 3, External Device Communication 4, User Communication 1, User Communication 2, User Communication 3**, or **Sub Host Communication** is selected for **Function**.

Flow Control: Selects the flow control method as **None** or **ER** according to the external device being used.
 This option can only be configured when **External Device Communication 1, External Device Communication 2, External Device Communication 3, External Device Communication 4** or **Sub Host Communication** is selected for **Function**.

Serial Interface: Select the interface standard for the serial port. The items that can be displayed vary based on the **Interface** under the **Interface Configuration**.

COM1, COM2: **RS232C, RS422/485 2-wire, RS422/485 4-wire**

COM2(RS232C): **RS232C**

COM2(RS422/485): **RS422/485 2-wire, RS422/485 4-wire**

This option can only be configured when the **External Device Communication 1**, the **External Device Communication 2**, the **External Device Communication 3**, the **External Device Communication 4**, the **User Communication 1**, the **User Communication 2**, the **User Communication 3**, or the **Sub Host Communication** is selected for **Function**.

*4 HG2J-7U only

When SERIAL1(RS232C), SERIAL1(RS422/485), COM(RS232C), or COM(RS422/485) is selected under Interface Configuration

The items displayed in the **Interface** vary based on the MICRO/I model.

HG2J-7U, HG1G/1P: **COM(RS232C)*2, COM(RS422/485)**

HG2G-5T: **SERIAL1(RS232C), SERIAL1(RS422/485)**

- Function:** Selects the function used by Serial Interface from the following.
N/A, External Device Communication 1, External Device Communication 2, External Device Communication 3, External Device Communication 4, O/I Link Master, O/I Link Slave, User Communication 1, User Communication 2, User Communication 3, Sub Host Communication
 The **O/I Link Master** and the **O/I Link Slave** can only be configured when the **SERIAL1(RS422/485)** or the **COM(RS422/485)** is selected for the **Interface** under the **Interface Configuration**.
- Baud Rate:** Selects the communication speed with the external device from the following.
1200, 2400, 4800, 9600, 19200, 38400, 57600, 115200, 187500
 The baud rate that can be configured varies based on **Protocol**.
- Data Bits:** Selects the data length as **7** or **8**.
 This option can only be configured when **External Device Communication 1, External Device Communication 2, External Device Communication 3, External Device Communication 4, User Communication 1, User Communication 2, User Communication 3, or Sub Host Communication** is selected for **Function**.
- Stop Bits:** Selects the stop bits as **1** or **2**.
 This option can only be configured when **External Device Communication 1, External Device Communication 2, External Device Communication 3, External Device Communication 4, User Communication 1, User Communication 2, User Communication 3, or Sub Host Communication** is selected for **Function**.
- Parity:** Selects the parity from the following.
None, Odd, Even
 This option can only be configured when **External Device Communication 1, External Device Communication 2, External Device Communication 3, External Device Communication 4, User Communication 1, User Communication 2, User Communication 3, or Sub Host Communication** is selected for **Function**.
- Flow Control:** Selects the flow control method as **None** or **ER** according to the external device being used.
 This option can only be configured when **External Device Communication 1, External Device Communication 2, External Device Communication 3, External Device Communication 4, or Sub Host Communication** is selected for **Function**.
- Serial Interface:** Select the interface standard for the serial port. The items that can be displayed vary based on the **Interface** under the **Interface Configuration**.
 SERIAL1(RS232C), COM(RS232C)*2: **RS232C**
 SERIAL1(RS422/485), COM(RS422/485): **RS422/485 2-wire, RS422/485 4-wire**
 This option can only be configured when **External Device Communication 1, External Device Communication 2, External Device Communication 3, External Device Communication 4, User Communication 1, User Communication 2, User Communication 3, or Sub Host Communication** is selected for **Function**.

*2 Only special product of HG1P is equipped with a serial interface (RS232C).

When Ethernet is selected under Interface Configuration

Example: To communicate with two MICRO/Is and a computer via Ethernet

Set MICRO/I A, MICRO/I B, and the computer all to the same values: subnet mask **255.255.255.0**, default gateway **192.168.1.254**.

Set the IP addresses to values that do not conflict: MICRO/I A IP address **192.168.1.6**, MICRO/I B IP address **192.168.1.7**, computer IP address **192.168.1.8**.

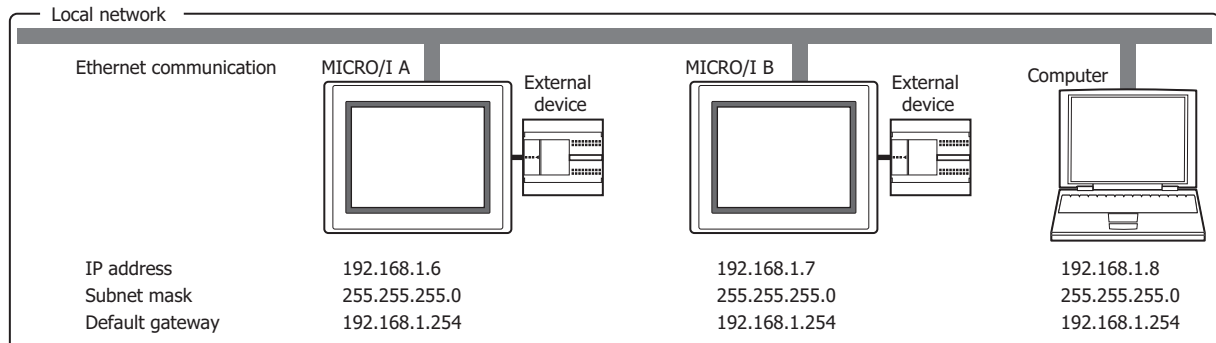

- Set the IP address, subnet mask, and default gateway according to the local network environment being used. When **Automatically obtain the IP address** is selected, the network settings are automatically assigned from the DHCP server on the local network environment being used. Settings assigned from the DHCP server can be checked on the Top Page in the System Mode.
- When **Automatically obtain the IP address** is selected, note the following points:
 - It takes some time to acquire the network settings. If the download fails, increase the timeout time on the **Home** tab, in the **Project** group, in **Comm.Setup**. For details, refer to Chapter 24 "1.3 Change Communication Settings" on page 24-5.
 - According to the DHCP server specifications, the IP address may change by removing and reinserting the Ethernet cable.
 - After connecting the MICRO/I into a different network, turn the power to MICRO/I off and then on again.

IP Settings: Selects the network setting method.

Automatically obtain the IP address (DHCP):

Automatically sets the network when connected to a network.

Use the following IP address: Manually specifies the IP address, subnet mask, and default gateway.

IP Address: Specifies the IP address. (Default: 192.168.1.6)
The format is "xxx.xxx.xxx.xxx". "xxx" stands for a numeric value from 0 to 255.
When connecting multiple devices to the same network, make sure to assign each device a unique IP address.

Subnet Mask: Specifies the subnet mask. (Default: 255.255.255.0)
The format is "xxx.xxx.xxx.xxx". "xxx" stands for a numeric value from 0 to 255.
This value must be the same for all devices.

Default Gateway: Specifies the default gateway. (Default: 0.0.0.0)
The format is "xxx.xxx.xxx.xxx". "xxx" stands for a numeric value from 0 to 255.
Set this value when using a router. Leave the value blank when not required.

Port Number: Specifies the TCP port number (1 to 65535) to use for maintenance communication. (Default: 2537)

Forbid Maintenance Communication:

Select this check box to prohibit maintenance communication via Ethernet communication. Please make sure you fully understand that enabling this setting will restrict access from the outside, such as disabling downloads.



Regarding TCP port number of MICRO/I, note the following points.

- The numbers that cannot be used:
- 2539: Maintenance communication (Data Transfer)
 - 2538: For pass-through
 - 2101: For FC4A Series MicroSmart direct connection pass-through

Duplicate numbers cannot be configured in the following functions:

- Maintenance communication
(☞ refer to "Port Number" on page 4-41)
- Web server function (☞ refer to "Port Number" on page 4-67)
- FTP server function (☞ refer to "Port Number" on page 4-68)
- **TCP Server** is selected for the User Communication
(☞ refer to "Port No." on page 4-43)
- **Modbus as Manufacture** and **Modbus TCP Server as Communication Driver** are selected on the **Communication Driver** tab
(☞ refer to the WindO/I-NV4 External Device Setup Manual)
- **YASKAWA Electric as Manufacture** and **MP2000(Ethernet)** as **Communication Driver** are selected on the **Communication Driver** tab
(☞ refer to the WindO/I-NV4 External Device Setup Manual)

- DNS Settings:** In order to access a DNS server from the MICRO/I, the IP address of the DNS server must be specified.
The setting method of the IP address of the DNS server is determined by the setting method of the network settings selected under **IP Settings**.
Obtain DNS Server Address Automatically (DHCP):
Automatically sets the IP address of the DNS server.
This can be selected when **Automatically obtain the IP address (DHCP)** is selected under **IP Settings**.
- Use the Following DNS Server Addresses:
Manually specifies the IP address of DNS Server.
- Preferred DNS Server: Specifies the IP address of Preferred DNS Server. (Default: 0.0.0.0)
The format is "xxx.xxx.xxx.xxx". "xxx" stands for a numeric value from 0 to 255.
- Alternate DNS Server: Specifies the IP address of Alternate DNS Server. (Default: 0.0.0.0)
The format is "xxx.xxx.xxx.xxx". "xxx" stands for a numeric value from 0 to 255.
- Connect Speed*5:** Select the Ethernet connection speed with the connected device from **10Mbps** or **10/100Mbps**.
When **10/100Mbps** is selected, attach ferrite cores to the communication cable. For details, refer to Chapter 35 "5.5 Specifications" on page 35-73.

*5 HG1P only

When Protocol1 to Protocol7 is selected for Ethernet under Interface Configuration

Function: Selects the user communication to configure for the selected function from the following.
External Device Communication 1, External Device Communication 2, External Device Communication 3, External Device Communication 4
User Communication 1, User Communication 2, User Communication 3

Operation Mode:

Selects the operation mode when performing user communication with the Ethernet interface. This option can only be configured when **User Communication 1, User Communication 2, or User Communication 3** is selected for **Function**.

TCP Client: The MICRO/I operates as a TCP/IP client and the external device operates as a TCP server. The MICRO/I connects to the TCP server and sends and receives data.

TCP Server: The MICRO/I operates as a TCP/IP server and the external device operates as a TCP client. The MICRO/I creates a listening port as a TCP server and waits for connections from TCP clients. After a connection, it sends and receives data with the TCP client.

UDP*6: The MICRO/I operates as a UDP server and client. The MICRO/I sends data to the listening port of the external device. The external device also sends data to the MICRO/I's listening port and that data is received by the MICRO/I.

Target: Configures the IP address and port number for the external device. These options can only be configured when **TCP Client** or **UDP** is selected for **Operation Mode**.

IP Address: Specifies the IP address for the target.
 The format is "xxx.xxx.xxx.xxx". "xxx" stands for a numeric value from 0 to 255.
 When connecting multiple devices to the same network, make sure to assign each device a unique IP address.

Port No.: Specifies the port number for the target (0 to 65535).

Change IP Address and Port Number by Device Address:

Select this check box and specify a word device to change the target's IP address and port number during operation. You can only specify an internal device. During the start of operation, the MICRO/I writes the values configured by **IP Address** and **Port No.** to this device address. After the start of operation, the value of device address is read and the target is changed.

Click to display the Tag Editor. For the device address configuration procedure, refer to Chapter 2 "5.1 Device Address Settings" on page 2-70.
 Example: When **IP Address** is set to 192.168.1.1, **Port No.** is 2105, and the device address is LDR100

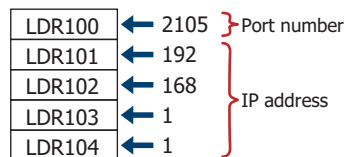

MICRO/I: Configures the MICRO/I listening port number. These options can only be configured when **TCP Server** or **UDP** is selected for **Operation Mode**.

Port No.: Specifies the MICRO/I listening port number (0 to 65535).

*6 HG2J-7U, HG5G/4G/3G/2G-V, HG4G/3G, HG2G-5F only



- When using the MICRO/I as UDP, the MICRO/I cannot automatically identify and reply to the IP address and port number of the external device. UDP broadcasting is also not supported.
- For TCP client and TCP server, make a 1:1 connection between the MICRO/I and the external device for one user communication setting.
- When the **Change IP Address and Port Number by Device Address** check box is selected, the changed IP address and port number are reflected when data is next sent.
- Regarding TCP port number of MICRO/I, note the following points.

The numbers that cannot be used:

- 2539: Maintenance communication (Data Transfer)
- 2538: For pass-through
- 2101: For FC4A Series MicroSmart direct connection pass-through

Duplicate numbers cannot be configured in the following functions:

- Maintenance communication
(☞ refer to "Port Number" on page 4-41)
 - Web server function (☞ refer to "Port Number" on page 4-67)
 - FTP server function (☞ refer to "Port Number" on page 4-68)
 - **TCP Server** is selected for the User Communication
(☞ refer to "Port No." on page 4-43)
 - **Modbus** as **Manufacture** and **Modbus TCP Server** as **Communication Driver** are selected on the **Communication Driver** tab
(☞ refer to the WindO/I-NV4 External Device Setup Manual)
 - **YASKAWA Electric** as **Manufacture** and **MP2000(Ethernet)** as **Communication Driver** are selected on the **Communication Driver** tab
(☞ refer to the WindO/I-NV4 External Device Setup Manual)
- Duplicate UDP port numbers of MICRO/I cannot be configured in the following functions.
 - **UDP** is selected for the User Communication (☞ refer to "Port No." on page 4-43)
 - **IDEC System** as **Manufacture** and **DM LINK Ethernet(UDP)** as **Communication Driver** are selected on the **Communication Driver** tab
(☞ refer to the WindO/I-NV4 External Device Setup Manual)
 - **OMRON** as **Manufacture** and **SYSMAC CS1/CJ series(Ethernet)** as **Communication Driver** are selected on the **Communication Driver** tab
(☞ refer to the WindO/I-NV4 External Device Setup Manual)



- The connection status for TCP clients and the TCP server can be checked with the value of the HMI Special Data Registers (LSD). The connection is disconnected when 0. The connection is connected when 1.
 - LSD67-0: Connection status for User Communication 1 set to Ethernet interface
 - LSD67-1: Connection status for User Communication 2 set to Ethernet interface
 - LSD67-2: Connection status for User Communication 3 set to Ethernet interface
- To forcibly disconnect the connection with TCP clients and the TCP server, set the value of the HMI Special Data Registers (LSD) from 0 to 1.
 - LSD68-0: User Communication 1 set to Ethernet interface
 - LSD68-1: User Communication 2 set to Ethernet interface
 - LSD68-2: User Communication 3 set to Ethernet interface

When USB1(USB-A) or USB2(USB-A) is selected under Interface Configuration

Function:	Selects the function used by the USB interface (Type A) from the following. N/A, User Communication 1, User Communication 2, User Communication 3, Wireless LAN^{*4}, Speaker^{*4}
Access Point Setting:	Configures the target access point to connect from MICRO/I via wireless LAN. These options can only be configured when Wireless LAN is selected for Function .
Network Name (SSID):	Enters the name (SSID) of the target access point. The network name (SSID) is 1 to 32 characters.
Security Type:	WPA2-PSK
Password:	Enter a password. The password is 8 to 64 characters. Only alphanumeric characters and symbols can be used. Show Password: Select this check box to display the characters entered in Password. When this check box is cleared, the passwords are displayed with * (asterisk).
IP Settings:	Configure the IP address and subnet mask of the access point of the target. These options can only be configured when Wireless LAN is selected for Function .
IP Address:	Specifies the IP address. (Default: 192.168.0.150) The format is "xxx.xxx.xxx.xxx". "xxx" stands for a numeric value from 0 to 255. When connecting multiple devices to the same network, make sure to assign each device a unique IP address.
Subnet Mask:	Specifies the subnet mask. (Default: 255.255.255.0) The format is "xxx.xxx.xxx.xxx". "xxx" stands for a numeric value from 0 to 255. This value must be the same for all devices.
Port Number:	Specifies the TCP port number (1 to 65535) to use for maintenance communication. (Default: 2537)
Forbid Maintenance Communication:	Select this check box to prohibit maintenance communication via wireless LAN communication.



Regarding TCP port number of MICRO/I, note the following points.

- The numbers that cannot be used:
- 2539: Maintenance communication (Data Transfer)
 - 2538: For pass-through
 - 2101: For FC4A Series MicroSmart direct connection pass-through

Duplicate numbers cannot be configured in the following functions:

- Maintenance communication (☞ refer to "Port Number" on page 4-41)
- Web server function (☞ refer to "Port Number" on page 4-67)
- FTP server function (☞ refer to "Port Number" on page 4-68)
- **TCP Server** is selected for the User Communication (☞ refer to "Port No." on page 4-43)
- **Modbus as Manufacture** and **Modbus TCP Server as Communication Driver** are selected on the **Communication Driver** tab (☞ refer to the WindO/I-NV4 External Device Setup Manual)

*4 HG2J-7U only



- Check the IDEC web site for more information about compatible wireless LAN adapter.
- The wireless LAN network settings and connection status can be checked and controlled with the value of the HMI Special Data Registers (LSD) and HMI Special Internal Relays (LSM).

LSD292 to 341: SSID and password of the access point

LSD344 to 351: IP address and subnet mask of the wireless LAN

LSD356: Port number for maintenance communication on the wireless LAN

LSD366: Wireless LAN connection status

LSD367: Wireless LAN signal strength

LSM77: Writing the wireless LAN network settings

LSM78: Connecting and disconnecting from the wireless LAN

For details, refer to Chapter 33 "Internal Devices" on page 33-1.

When **USB1(USB-B)** or **USB(USB-B)** is selected under **Interface Configuration**

The items displayed in the **Interface** vary based on the MICRO/I model.

HG5G/4G/3G/2G-V, HG4G/3G, HG2G-5F, HG1G/1P: **USB1(USB-B)**

HG2G-5T: **USB(USB-B)**

Function: Selects the function used by the USB interface (Mini-B) as **N/A** or **Printer**.^{*7}

■ **Default**

Returns the configured values to their default values.

*7 HG5G/4G/3G/2G-V, HG4G/3G, HG2G-5F only

3.3 Communication Driver Tab

HG2J-7U HG5G-V HG4G-V HG4G HG3G-V HG3G HG2G-V HG2G-5F HG2G-5T HG1G HG1P

The **Communication Driver** tab is used to configure the communication driver for the external device configured in the current project data.

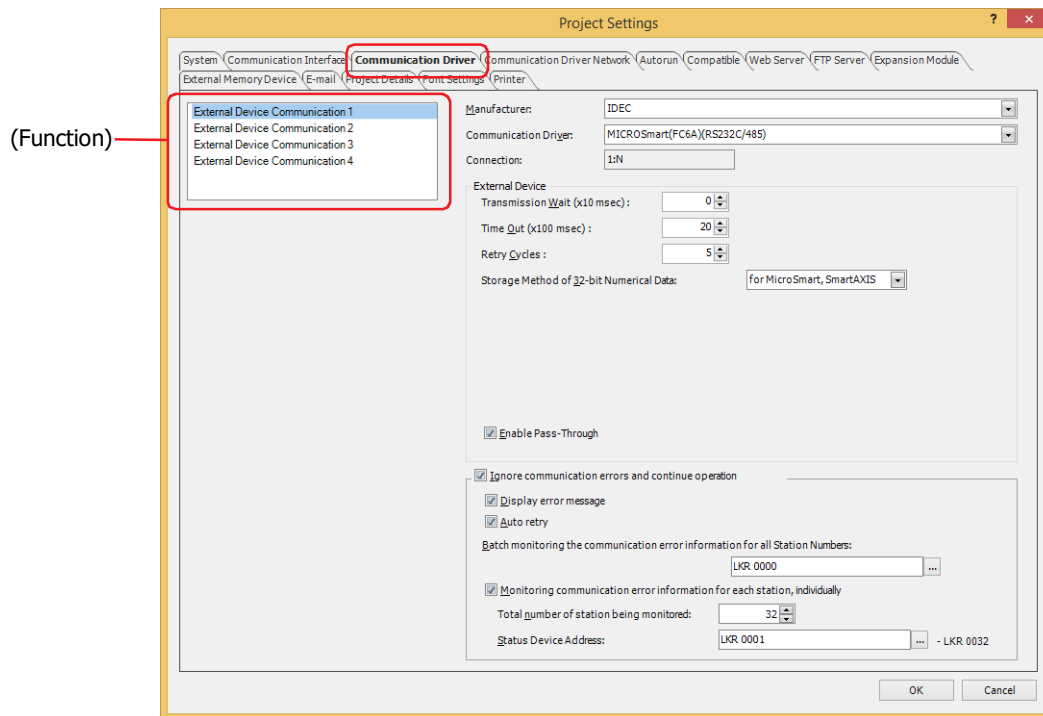

- **(Function)**
Select the External Device Communication.
- **Manufacturer**
Selects the manufacturer name of the external device to use in External Device Communication selected by (Function).
- **Communication Driver**
The communication driver list for the selected manufacturer is displayed. Selects the serial interface to use.
- **Connection**
The connection of the selected communication driver is displayed.
 1:1: The MICRO/I is connected to a single external device.
 1:N: The MICRO/I is connected to multiple external devices.
- **External Device**
These options configure the communication driver to use. For details, refer to the WindO/I-NV4 External Device Setup Manual.

Transmission Wait (x 10 msec):	Specifies the transmission interval for communication commands (0 to 255).
Time Out (x 100 msec):	Specifies the time to wait for a response from the external device (1 to 255).
Retry Cycles:	Specifies the number of times to execute a reconnection when the MICRO/I cannot communicate with the external device. When the number of reconnect attempts reaches the number of times set here, a communication error is displayed.

Storage Method of 32-bit Numerical Data : Selects the handling method for values of external device addresses when **UBIN32(D)**, **BIN32(L)**, **BCD8(EB)**, or **Float32(F)** is selected for **Data Type** from the following.

from Upper word:

Values of external device addresses are read from and written to the upper order word.

Example: When **Data Type** for the Numerical Input is **UBIN32(D)** and the numerical value 12345678 (Hex) was entered and written to destination device address D100

Device address	Stored value	
D100	1234 (Hex)	Upper word
D101	5678 (Hex)	Lower word

from Lower word:

Values of external device addresses are read from and written to the lower order word.

Example: When **Data Type** for the Numerical Input is **UBIN32(D)** and the numerical value 12345678 (Hex) was entered and written to destination device address D100

Device address	Stored value	
D100	5678 (Hex)	Upper word
D101	1234 (Hex)	Lower word

for MICROSmart, SmartAXIS:

The storage method of data varies based on device type when selecting the following communication drivers.

Manufacturer	Communication driver
IDEC	MICROSmart(FC6A)(RS232C/485)
	MICROSmart(FC6A)(Ethernet)
	OpenNet,MICROSmart,SmartAXISPro/Lite(RS232C/485)
	OpenNet,MICROSmart,SmartAXISPro/Lite(Ethernet)
	MICRO3,MICRO3C

- Device types handled as from upper word
Data Register, Timer Current Value, Counter Current Value, Timer Preset Value, Counter Preset Value, Special Data Register
- Device types handled as from lower word
Input (Word), Output (Word), Internal Relay (Word), Link Register, Special Internal Relay (Word), Shift Register (Word)

When using a communication driver other than those listed above and **for MICROSmart, SmartAXIS** is selected, the values of all device addresses are handled as **from Upper word**.

Enable Pass-Through:

Select this check box to use the Pass-Through function.

This option is only displayed for models that can use the Pass-Through function. For details, refer to Chapter 27 "1.2 Supported External Devices" on page 27-2.



The Pass-Through function can only use one of **External Device Communication 1** to **External Device Communication 4**.



The Pass-Through Tool is required to use the Pass-Through function when using a version of WindLDR before Ver. 6.01, another company's PLC programming software, or an external device other than IDEC's external device.

Communication Driver Extension Settings:

This button is displayed when the communication driver extension settings are required.

Click this button to display the **Communication Driver Extension Settings** dialog box. For details, refer to "Communication Driver Extension Settings Dialog Box" on page 4-51.

■ Ignore communication errors and continue operation

Select this check box to continue MICRO/I operation even when a communication error occurs.

Display error message: Select this check box to display an error message (communication error) when a communication error occurs and operation continues. **Ack** is displayed on the error message (communication error).

When the **Ignore communication errors and continue operation** check box is cleared, **Ack** is not displayed on the error message.

Auto retry: Select this check box to automatically retry communication from the MICRO/I to the station number where the communication error occurred when a communication error occurs and operation continues.

All other communication stops while retrying.



To manually retry communication, clear the **Auto retry** check box.

To retry all station numbers, write 1 in bit 1 (initialize) of the device address configured by **Batch monitoring the communication error information for all Station Numbers**.

To individually retry communication, write 1 in bit 0 (connection setting) of the device address configured by **Monitoring communication error information for each station, individually**.

Batch monitoring the communication error information for all Station Numbers:

Specifies the word device that stores communication error information for all station numbers. Only an internal device can be configured for this option.

Click to display the Tag Editor. For the device address configuration procedure, refer to Chapter 2 "5.1 Device Address Settings" on page 2-70.

The information stored as error information is as follows. For details, refer to the WindO/I-NV4 External Device Setup Manual.

- Initialization
- Conditions under which the error occurred
- Read error history
- Write error history

Monitoring communication error information for each station, individually:

Select this check box to store the error information for each station number in device addresses.

Total number of station being monitored: Specifies the number of station numbers for external devices.

Status Device Address:

Specifies the word device that stores communication error information for each station number. Only an internal device can be configured for this option.

Click to display the Tag Editor. For the device address configuration procedure, refer to Chapter 2 "5.1 Device Address Settings" on page 2-70.

This error information utilizes a maximum of 256 device addresses. Use caution so that the used address numbers do not overlap with other addresses.

The information stored as error information is as follows. For details, refer to the WindO/I-NV4 External Device Setup Manual.

- Connection settings
- Conditions under which the error occurred
- Read error history
- Write error history



The station number varies based on the communication interface. The displayed settings are as follows:

Serial interface: Slave Number

Ethernet interface: External Device ID

Communication drivers that cannot be simultaneously used

The following communication driver combinations can only be used in a single (Function). They cannot be configured in multiple settings.

■ **Communication drivers that cannot be simultaneously used (1)**

Manufacturer	Communication Driver
Modbus	Modbus RTU Master
	Modbus RTU Slave
SIEMENS	S7-200(PPI)
	S7-MPI
YASKAWA ELECTRIC CORPORATION	MP920-RTU

■ **Communication drivers that cannot be simultaneously used (2)*¹**

Manufacturer	Communication Driver
Allen-Bradley	Logix Controllers(Ethernet)
	Logix Native Tag(Ethernet)

■ **Communication drivers that cannot be simultaneously used (3)**

Manufacturer	Communication Driver
IDEC System	DM Link (1:1)
	DM Link (1:N)
	DM Link Ethernet(UDP)* ¹
Modbus	Modbus RTU Slave
	Modbus TCP Server

Example: **Communication Driver** for **External Device Communication 1** is set to **Modbus RTU Slave**. According to the communication drivers that cannot be simultaneously used (1), **External Device Communication 2**, **External Device Communication 3**, and **External Device Communication 4** cannot be set to **Modbus RTU Master**, **S7-200(PPI)**, **S7-MPI**, or **MP920-RTU**. According to the communication drivers that cannot be simultaneously used (3), **External Device Communication 2**, **External Device Communication 3**, and **External Device Communication 4** cannot be set to **DM Link (1:1)**, **DM Link (1:N)**, **DM Link Ethernet(UDP)*¹**, or **Modbus TCP Server**.

*1 HG5G/4G/3G/2G-V, HG4G/3G, HG2G-5F only

- Communication Driver Extension Settings Dialog Box

The **Communication Driver Extension Settings** dialog box is used to configure the communication driver extension settings. These settings vary based on the external device. For details, refer to the WindO/I-NV4 External Device Setup Manual.

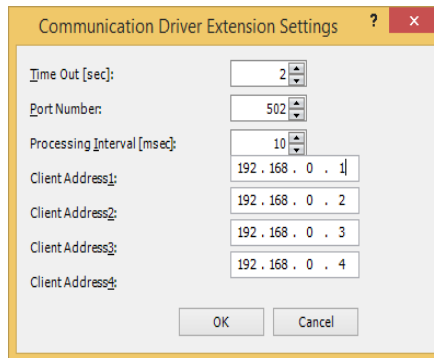

3.4 Communication Driver Network Tab

HG2J-7U HG5G-V HG4G-V HG4G HG3G-V HG3G HG2G-V HG2G-5F HG2G-5T HG1G HG1P

The **Communication Driver Network** tab is used to configure the information for external devices.

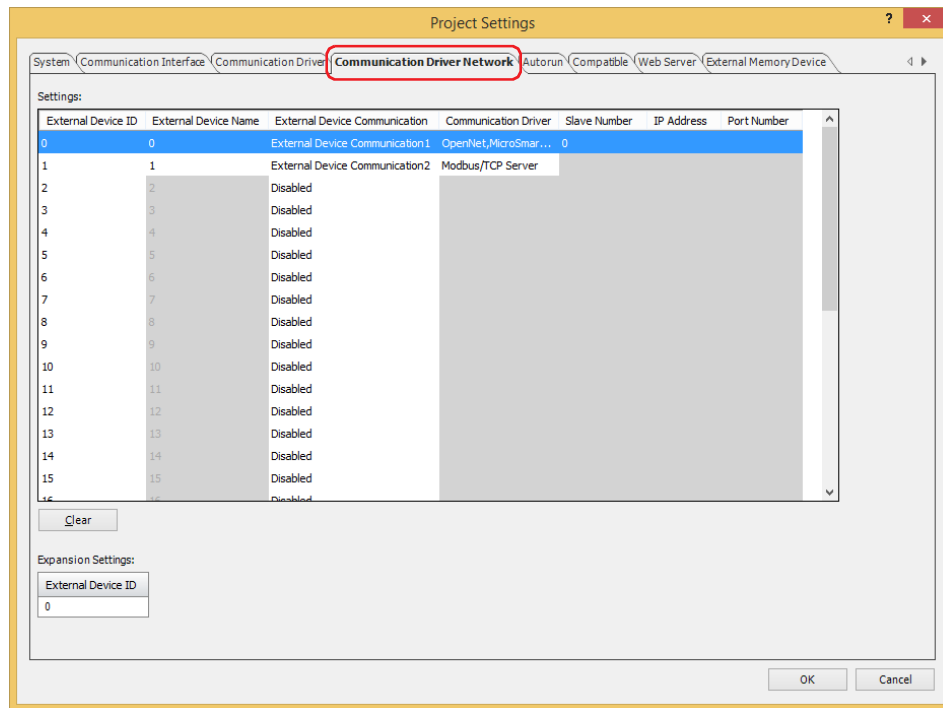

■ Settings

Edits the settings for the external devices.

External Device ID: Shows the number (0 to 31) that the MICRO/I uses to manage the external devices are displayed.

External Device Name: Shows the name for the external device. The default is the number (0 to 31). Clicking the cell allows you to edit the name. The maximum number is 20 characters. Only alphanumeric characters and symbols can be used.



You cannot use the following characters and name in the External Device Name.

- The following characters and a space
" * / : ; < > ? \ |
- (blank)
- The same name as another External Device ID

External Device Communication: Shows the function set for the serial interface or the Ethernet interface. (Default: Disabled)

Clicking the cell allows you to select the function from the following items.
Disabled, External Device Communication 1, External Device Communication 2, External Device Communication 3, External Device Communication 4



Function configured in communication drivers with a 1:1 connection in **External Device Communication** cannot be set to multiple **External Device ID**.

Communication Driver: Shows the communication driver for use with the External Device Communication.

Slave Number: Displays the slave number of the external device.
Clicking the cell allows you to change the slave number of the external device.
This option can only be configured when Serial Interface is selected for **Interface Configuration** on **Communication Interface** tab. For details, refer to "Interface Configuration" on page 4-35.



Leaving it blank or the same number as the other External Device IDs cannot be used for **Slave Number**.

IP Address: Shows the IP address of the external device. (Default: 192.168.0.1)
Clicking the cell allows you to specify the IP address of the external device.
The format is "xxx.xxx.xxx.xxx". "xxx" stands for a numeric value from 0 to 255.
When connecting multiple devices to the same network, make sure to assign each device a unique IP address.
This option can only be configured when **Ethernet** is selected for **Interface Configuration** on **Communication Interface** tab.

Port Number: Shows the port number of external device. (Default: 2101)
Clicking the cell allows you to specify the port number of the external device (0 to 65535).
This option can only be configured when **Ethernet** is selected for **Interface Configuration** on **Communication Interface** tab.

■ Clear

Returns the settings for the selected External Device ID to the defaults.



You can change the IP address of the external devices in the System Mode. Perform the following operation on the Main Menu screen.

HG2J-7U, HG5G/4G/3G/2G-V, HG4G/3G, HG2G-5F: Press **Initial Setting, Communication I/F, Ext. Device IP Address** in order.

HG2G-5T, HG1G/1P: Press **Initial Setting, Comm. I/F, Ext. IP Address** in order.

■ Specify Slave Number of Modbus RTU Master by Value of Device Address

Select this check box to specify the slave number with the value of a device address.

This option is only displayed when the **Manufacturer** of the external device is **Modbus** and **Communication Driver** is **Modbus RTU Master**. For details, refer to WindO/I-NV4 External Device Setup Manual.

(Top Device Address): Specifies a word device to write the Slave Number.

Click to display the Tag Editor. For the device address configuration procedure, refer to Chapter 2 "5.1 Device Address Settings" on page 2-70.

■ Expansion Settings

If extension settings are required for the communication driver set for the selected slave number, those settings are displayed. For details, refer to the WindO/I-NV4 External Device Setup Manual.

■ Tag File

Import the Allen-Bradley tag defined in the RSLogix5000 L5K file (*.L5K). Click the button to display the Open dialog box.

This option is only displayed when the **Manufacturer** of the external device is **Allen-Bradley** and the **Communication Driver** is **Logix Native Tag(Ethernet)**. For details, refer to the WindO/I-NV4 External Device Setup Manual.

■ Configure Application Name

Configures name to an Application. Click this button to display the Configure Application Name dialog box.

This option is only displayed when the **Manufacturer** of the external device is **ABB**. For details, refer to the WindO/I-NV4 External Device Setup Manual.



If you change the **Communication Driver** and then click **OK** on the **Project Settings** dialog box, a confirmation message is displayed. Click **Yes** on the message to run the conversion for the external device addresses. If there are no device addresses that correspond to the external device addresses in the current project data after changing the communication driver, the items set with those device addresses are blank.

Number of external device limitations

- The number of external devices that can be connected to **External Device Communication 1** to **External Device Communication 4** is a total of 32 external devices.
- The number of external devices that can be set varies based on the communication interface.

Communication Interface	Number of External Devices
Serial Interface (Connection: 1:1 communication)	1
Serial Interface (Connection: 1:N communication)	31 max.
Ethernet Interface	32 max.

3.5 O/I Link Tab

HG2J-7U HG5G-V HG4G-V HG4G HG3G-V HG3G HG2G-V HG2G-5F HG2G-5T HG1G HG1P

The **O/I Link** tab configures the slave stations to connect to when the MICRO/I is used as the O/I Link communication master. It configures the O/I link station when the MICRO/I is used as a slave. For details, refer to Chapter 3 “2 O/I Link Communication” on page 3-3. These options can only be configured when **O/I Link Master** or **O/I Link Slave** is selected for **Function** under **Interface Settings** on the **Communication Interface** tab.

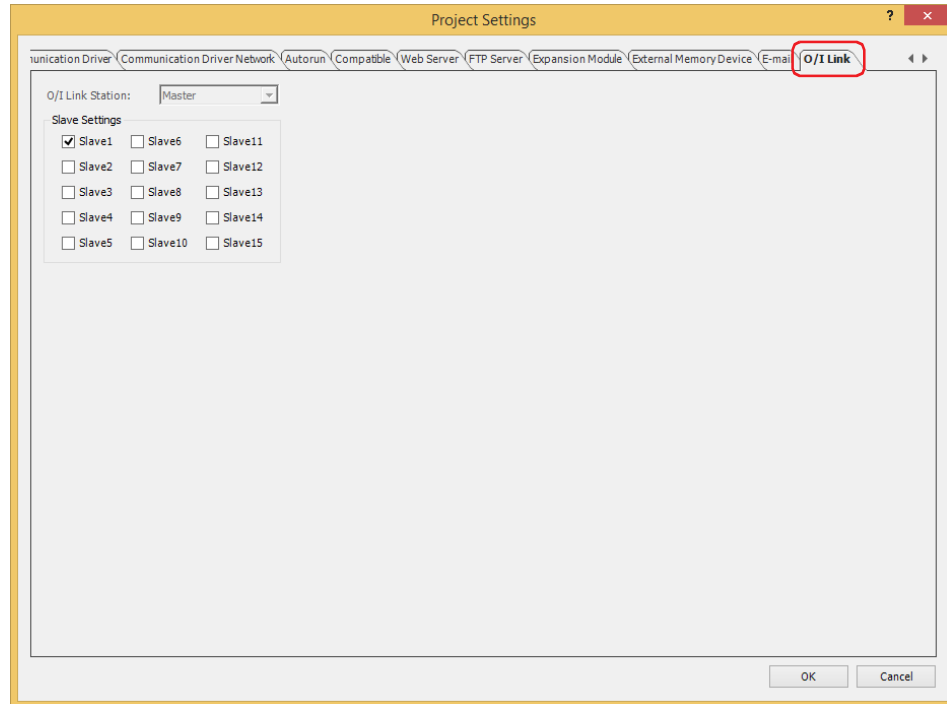

■ O/I Link Station

Selects the slave station (Slave1 to Slave15).

This option can only be configured when **O/I Link Slave** is selected for **Function** under **Interface Settings** on the **Communication Interface** tab.

■ Slave Settings

Select the check boxes for the slave stations to connect to.

This option can only be configured when **O/I Link Master** is selected for **Function** under **Interface Settings** on the **Communication Interface** tab.



The slave stations to connect to when the MICRO/I is used as an O/I link communication master are enabled after the project is downloaded. The slave station number when the MICRO/I is used as a slave is also enabled after the project is downloaded.

3.6 User Communication Tab

HG2J-7U HG5G-V HG4G-V HG4G HG3G-V HG3G HG2G-V HG2G-5F HG2G-5T HG1G HG1P

The **User Communication** tab is used to configure communication with external devices such as barcode readers. For details, refer to Chapter 3 "5 User Communication" on page 3-8. This option can only be configured when **User Communication 1**, **User Communication 2**, or **User Communication 3** is selected for Function under **Interface Settings** on the **Communication Interface** tab.

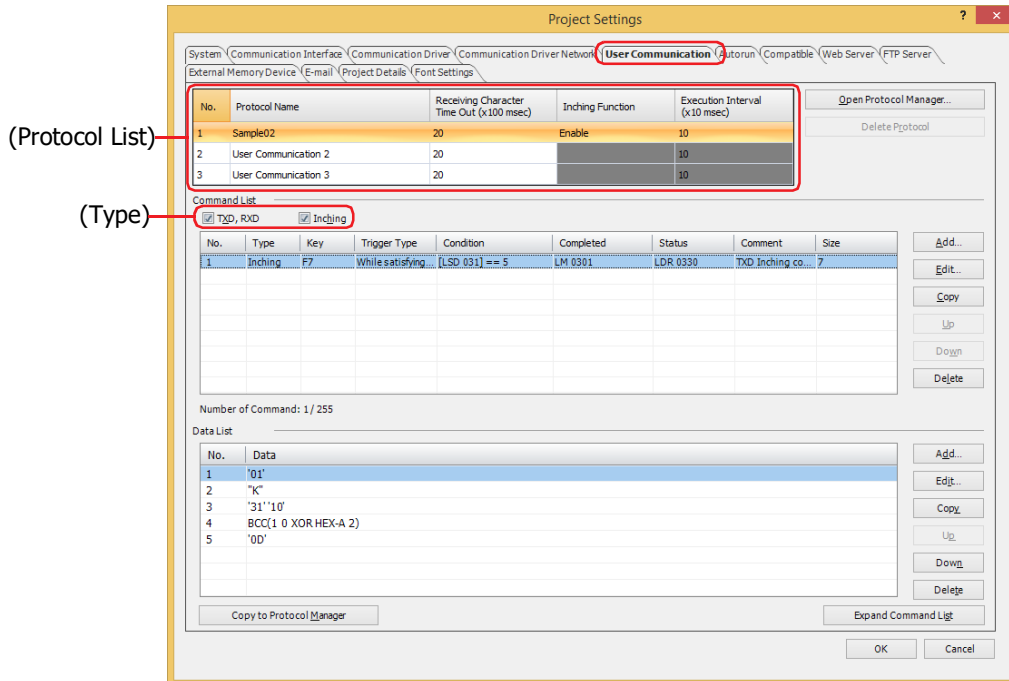

■ (Protocol List)

Displays the registered user communication protocol.

No.: Displays the number for managing the user communication protocol.

Protocol Name: Enter the name of the user communication protocol. The maximum number for protocol name is 40 characters.



You cannot use the following characters in the protocol name.

" * , / : ; < > ? \ |

Receiving Character Time Out (x100 msec):

Specify the time out value (0 to 255) from when 1 frame of data has been received to when the next frame of data starts to be received. A frame refers to a data string from the beginning to the end of a command. If the Receiving Character Time Out is set to 0, it is not monitored. These setting items are used only with receive command.

Example: The received data (1 frame) is 2 bytes, the **While ON** is selected as the **Trigger Type** in the **Trigger Condition** and LM100 is set to the **Device Address**, LM101 is set to the **Completed Device Address**, and LDR110 is set to the **Status Device Address**

The data of second byte starts to be received before exceeding the Receiving Character Time Out duration after the data of first byte is received, and the values of the Completed Device Address and Status Device Address when receiving of the data has been successfully completed are as follows.

- The value of the Completed Device Address LM101 changes to 1.
When the **Not Clear Completed Device Address automatically** check box is not selected, when the value of the Trigger Condition device address LM100 changes from 0 to 1, the value of the Completed Device Address LM101 changes to 0.
When the **Not Clear Completed Device Address automatically** check box is selected, the value of Completed Device Address LM101 remains 1, so set 0 if necessary.

- The value of the Receiving Character Time Out (address number+0, bit 15) of the Status Device Address LDR110 remains 0.

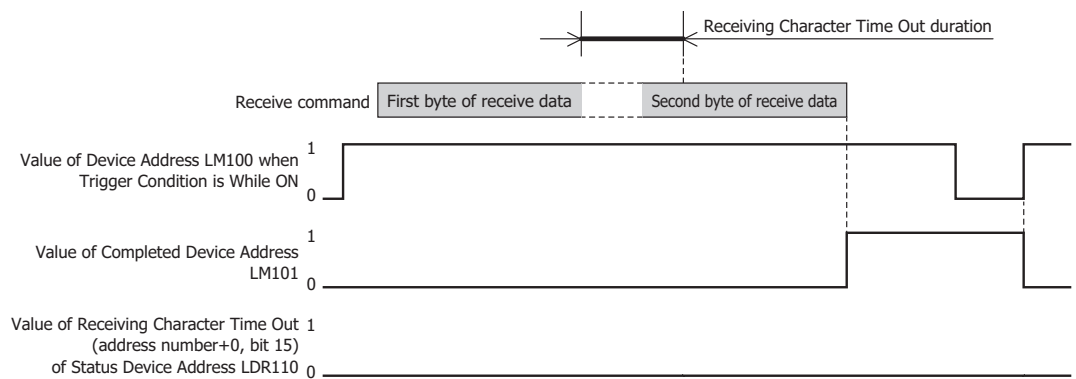

When the Receiving Character Time Out duration exceeds until the data of second byte starts to be received after the data of first byte is received, the value of the Receiving Character Time Out (address number+0, bit 15) of the Status Device Address LDR110 changes to 1 and the Completed Device Address LM101 remains 0. In addition, when the value of the Trigger Condition device address LM100 changes from 0 to 1, the value of LDR110 (address number +0, bit 15) changes to 0.

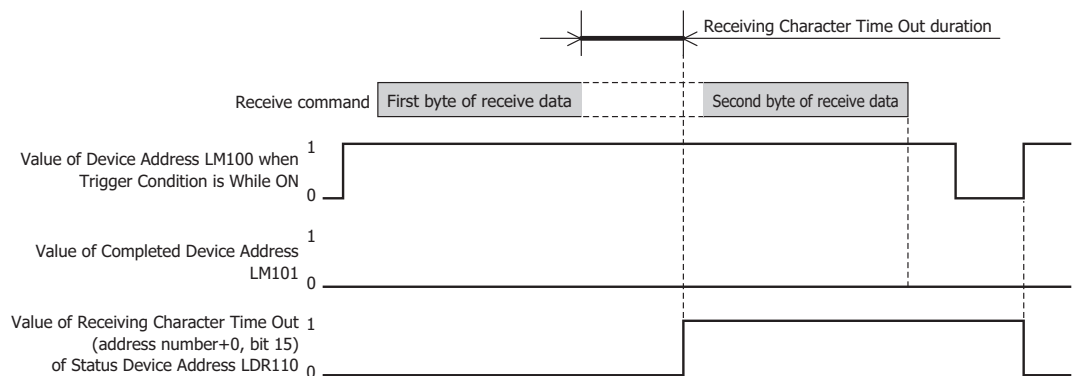

Inching Function^{*1}: Displays whether or not the inching function is used. Double clicking the cell switches between the **Enable** and the **Disable**. This can only be set for the User Communication 1. By using the inching function, data is transmitted at the specified execution interval.



Inching refers to the inching operation of the drive section. It is a general term for drive operations that repeatedly start and stop in small increments for each operation, such as starting and stopping the drive section when a push button or switch is pushed and released.

Execution Interval (x10 msec)^{*1}: Specifies the interval to send the commands for inching function as 40 to 1000 (20 ms increments).

This option can only be set when the **Enable** is selected in the **Inching Function**.



The command cannot be sent at the specified execution interval if the following conditions occur:

- The transmission processing for a command cannot be completed within the time set by the **Execution Interval**.
⇒ Set the **Execution Interval** to a time longer than it takes to send the command.
- The inching function was used at the same time as user communication transmission or receive processing.
⇒ Do not use transmission commands, receive commands and commands for inching function at one time.



One frame is transmitted with no character spacing.

*1 HG1P only

- Open Protocol Manager: Configures the user communication protocol registered in the Protocol Manager to the user communication protocol selected in the **(Protocol List)**.
Click this button to display Protocol Manager. For details, refer to Chapter 3 "Configuring registered user communication protocol to another user communication" on page 3-28.
- Delete Protocol: Deletes the user communication protocol selected in the **(Protocol List)**.

■ Command List

The command settings for the user communication protocol selected in the **(Protocol List)** are displayed.

- (Type)^{*1}: Changes the items displayed in the list according to the type of command.
- TXD, RXD: Select this check box to display transmission and receive commands.
- Inching: Select this check box to display commands for the inching function.



User communication protocol commands are displayed in the order they were created, but commands for inching function are always displayed above the transmission and receive commands in the list.

- No.: Shows the number for managing command settings. Double clicking the cell displays the Command Settings dialog box.
- Type: Shows the type of command. Double clicking the cell displays the Command Settings dialog box.
- Key: Shows the function keys (F1 to F12) assigned to the command. Double clicking the cell displays the Command Settings dialog box.
This option is displayed only when the **Inching** check box is selected.
- Trigger Type: Shows the trigger type for data transmission or being ready to receive data. Double clicking the cell displays the Command Settings dialog box.
- Condition: Shows the condition of trigger type for data transmission or being ready to receive data. Double clicking the cell displays the Command Settings dialog box. The displayed content varies based on the **Trigger Type**.
Always Enabled: Trigger conditions are not necessary, so nothing is displayed.
Rising-edge, Falling-edge, While ON, or While OFF:
Shows the bit device or the bit of the word device as the condition.
While satisfying the condition or Satisfy the condition:
Shows the conditional expression.
Fixed Period: Shows the period.
- Completed: Shows the device address for reporting when transmission or receiving of data is successfully completed. Double clicking the cell displays the Command Settings dialog box.
- Status: Shows the destination device address for the transmitted or received data size and error information. Double clicking the cell displays the Command Settings dialog box.
- Comment: Shows the command comment. Double clicking the cell displays the Command Settings dialog box.
- Size: Shows the command data size in bytes. The maximum is displayed if there is data that has the **Variable** check box selected on the Data Settings dialog box. Double clicking the cell displays the Command Settings dialog box.

*1 HG1P only

Add:	Adds a command to the Command List . A maximum of 255 commands may be added. Click this button, displays the Command Settings dialog box. For details, refer to Chapter 3 "Command Settings Dialog Box" on page 3-36.
Edit:	Edits the command selected in the Command List . Click this button, displays the Command Settings dialog box. For details, refer to Chapter 3 "Command Settings Dialog Box" on page 3-36.
Copy:	Copies the command selected in the Command List . Click this button to add a copy of the selected command to the end of the Command List. Inching function commands are added above the transmission and receive commands.
Up:	Shifts the selected command upward in the list.
Down:	Shifts the selected command downward in the list.
Delete:	Deletes the selected command from the Command List .



Adding, copying, and shifting up and down happen within the range of the same type of command. There are two types of commands: the **TXD**, the **RXD** and the **Inching**.

■ Data List

Displays the list of command data selected in the **Command List**.

No.:	Displays the number for managing the data. Double clicking the cell displays the Data Settings dialog box. For details, refer to Chapter 3 "Data Settings Dialog Box" on page 3-48.
Data:	Displays the data settings. Double clicking the cell displays the Data Settings dialog box. For details, refer to Chapter 3 "Data Settings Dialog Box" on page 3-48.
Add:	Add: Adds a data to the Data List . Click this button, displays the Data Settings dialog box. For details, refer to Chapter 3 "Data Settings Dialog Box" on page 3-48.
Edit:	Changes the selected data in the Data List . Click this button, displays the Data Settings dialog box. For details, refer to Chapter 3 "Data Settings Dialog Box" on page 3-48.
Copy:	Copies the selected data in the Data List . Click this button to add a copy of the selected data to the end of the Data List.
Up:	Shifts the selected data upward in the list.
Down:	Shifts the selected data downward in the list.
Delete:	Deletes the selected data from the Data List .

■ Copy to Protocol Manager

Click this button to register the user communication protocol selected in the (**Protocol List**) to the Protocol Manager. For details, refer to Chapter 3 "5.3 Protocol Manager" on page 3-32.

■ Expand/Contract Command List

Shows or hides the **Data List**. By hiding the **Data List**, the number of commands displayed in the **Command List** will increase.

3.7 Sub Host Communication Tab

HG2J-7U HG5G-V HG4G-V HG4G HG3G-V HG3G HG2G-V HG2G-5F HG2G-5T HG1G HG1P

The **Sub Host Communication** tab is used to configure the sub host communication protocol and HMI Link Register (LLR) addresses to use. For details, refer to Chapter 3 “6 Sub Host Communication” on page 3-87. This option is configured only when **Sub Host Communication** is selected for **Function** under **Interface Settings** on the **Communication Interface** tab.

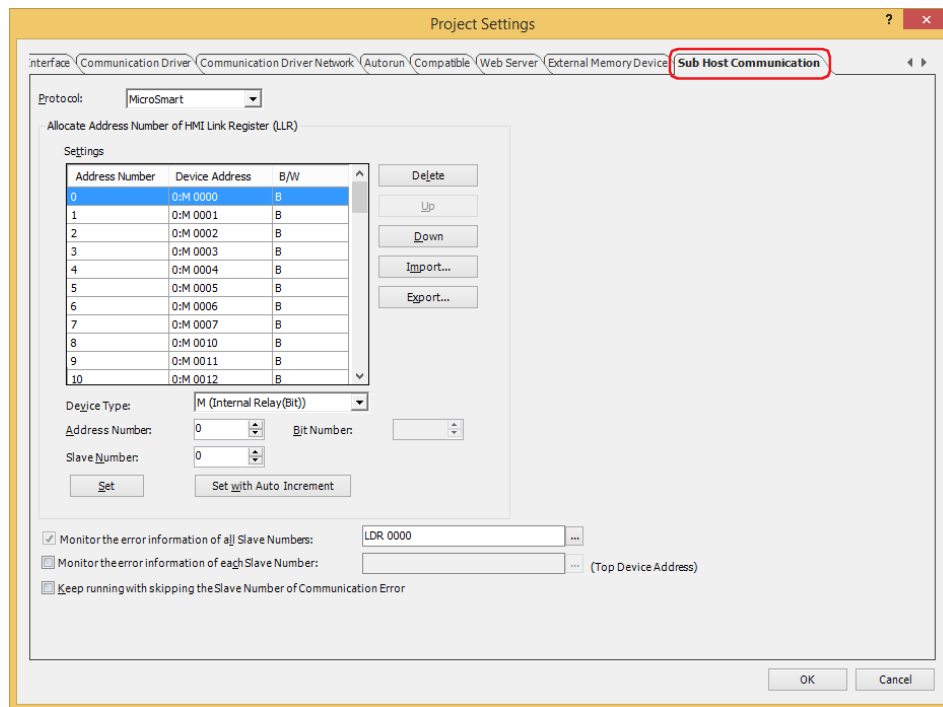

■ Protocol

Selects the protocol to use in sub host communication as **MicroSmart** or **Modbus RTU Master**.

■ Allocate Address Number of HMI Link Register (LLR)

Settings: Lists the device addresses allocated to HMI Link Registers.
Address Number: Shows the LLR address numbers (LLR 0 to LLR 63).
Device Address: Shows the device addresses allocated to LLR address numbers.
B/W: Shows the device type.

B: Bit device

W: Word device

BWORD: Bit device in word

Device Type: Selects the device type of the device address to allocate to the HMI Link Register (LLR). Only device types that can be used are shown.

Address Number: Specifies the address number of device address to allocate to the HMI Link Register (LLR). The range that can be set varies based on the selected device type.

Bit Number: Specifies the bit number in a word device (0 to 15). This option can only be configured when a word device is selected for **Device Type**.

Slave Number: Specifies the slave number of the external device for the device address to allocate to the HMI Link Register (LLR). The range that can be specified varies based on the selected communication driver.

Set:	Allocates the device address to the HMI Link Register (LLR). When a device address is already allocated to an LLR address number, the allocated device address can be changed. Select an LLR address number and click Set to allocate the settings configured by Device Type, Address Number, Bit Number, and Slave Number to the HMI Link Register (LLR).
Set with Auto Increment:	Allocates sequential device addresses from the device address configured by Device Type, Address Number, Bit Number, and Slave Number to the HMI Link Registers (LLR) after the selected LLR address number.
Delete:	Deletes the device address allocated to the HMI Link Register (LLR) from the list. Select the LLR address on the list and click Delete .
Up:	Shifts the device address allocated to the selected HMI Link Register (LLR) up in the list.
Down:	Shifts the device address allocated to the selected HMI Link Register (LLR) down in the list.
Import:	Displays the Open dialog box. Select a file with exported device addresses (CSV file) and click Open to collectively overwrite the LLR address numbers under Settings with the device addresses in the selected file.
Export:	Displays the Save As dialog box. Select the location to save the file, enter a file name, and then click Save to save the device address details as a CSV file.

■ Monitor the error information of all Slave Numbers

Select this check box to monitor the error information of all external devices that are being communicated with using sub host communication.

For details, refer to Chapter 3 "Monitor the error information of all Slave Numbers" on page 3-92.

(Destination device address): Specifies the word device to write the error information to.

Click to display the Tag Editor. For the device address configuration procedure, refer to Chapter 2 "5.1 Device Address Settings" on page 2-70.

■ Monitor the error information of each Slave Number

Select this check box to monitor the error information for each external device that is being communicated with using sub host communication.

The information for each slave is stored starting with the allocated internal device and utilizes 256 words of address numbers.

The slave numbers are allocated with the starting address as number 0, up to number 255.

For details, refer to Chapter 3 "Monitor the error information of each Slave Number" on page 3-93.

(Top device address): Specifies the word device to write the error information to. This option uses 64 words of addresses starting with the configured device address.

Click to display the Tag Editor. For the device address configuration procedure, refer to Chapter 2 "5.1 Device Address Settings" on page 2-70.

■ Keep running with skipping the Slave Number of Communication Error

Select this check box to temporarily stop communication with the slave number where the communication error occurred and connect to the next slave number.

For details, refer to Chapter 3 "Keep running with skipping the Slave Number of communication error" on page 3-93.

3.8 Printer Tab

HG2J-7U HG5G-V HG4G-V HG4G HG3G-V HG3G HG2G-V HG2G-5F HG2G-5T HG1G HG1P

The **Printer** tab is used to configure the printer that is connected to the MICRO/I.

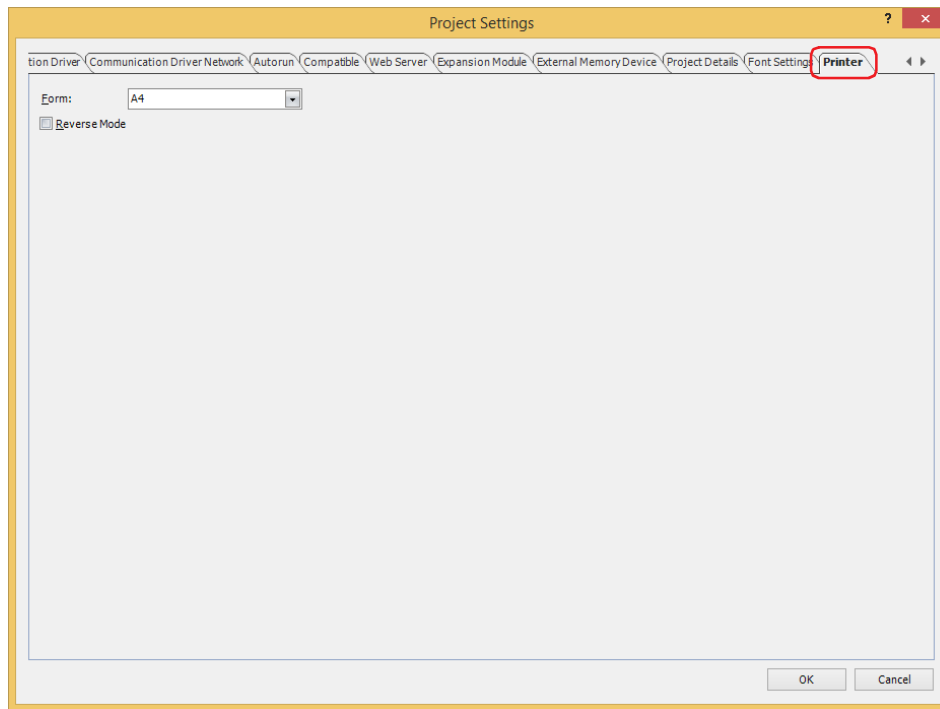

■ Form

Selects the paper size to output as **A4** or **Letter**.

If the printer does not support the selected paper size, printing is performed with the paper size specified in the printer's settings.

■ Reverse Mode

Select this check box to reverse only black or white when printing.



- The color cannot be configured. To print in monochrome, configure the print color on the printer that is used. When the edge of the data is not printed, enable **No Trimming** and **Bordered** in the printer's settings.
- When connecting the MICRO/I to a printer, an error may occur on the printer side as an unsupported device. However, data is sent that satisfies the PictBridge standard when printing, so the data can be printed correctly.

3.9 External Memory Device Tab

HG2J-7U HG5G-V HG4G-V HG4G HG3G-V HG3G HG2G-V HG2G-5F HG2G-5T HG1G HG1P

The **External Memory Device** tab is used to configure the destination folder on the external memory device^{*1} inserted in the MICRO/I.

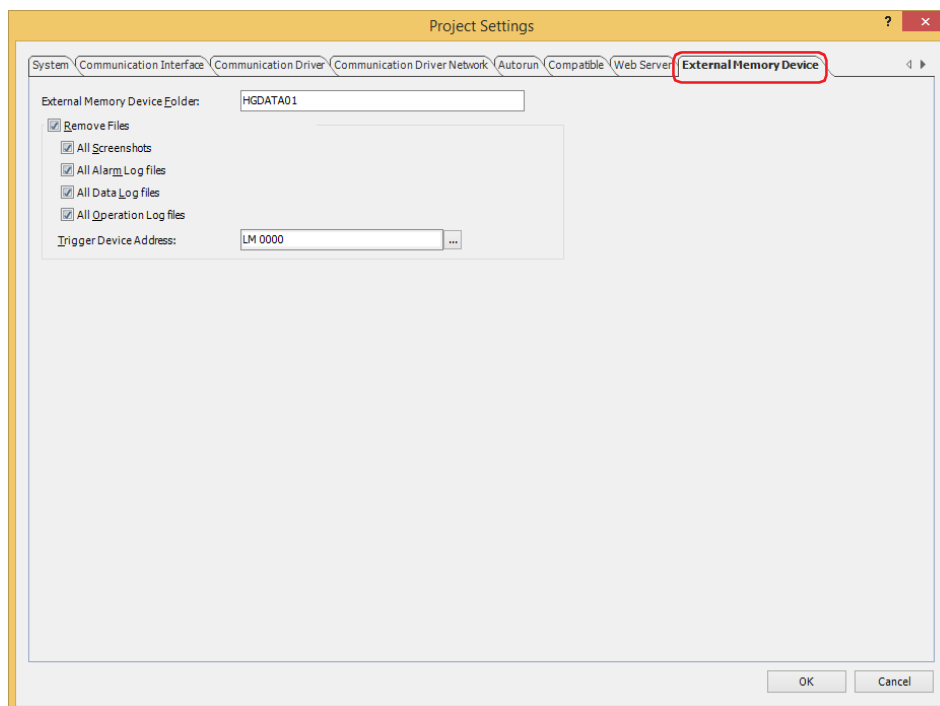

External Memory Device Folder

Enter the folder name for the folder to use on the MICRO/I within 8 alphanumeric characters using upper-case alphabetic characters (A to Z) and numbers (0 to 9). (Default: HGDATA01)

All the data sampled with the log functions is saved in this External Memory Device folder. For details on the external memory device, refer to Chapter 31 "1 External Memory Devices" on page 31-1.



- You cannot use the following characters in the folder name.

HG2J-7U: " # \$ & ' () * . / : ; < > ? \ ` | ~

HG5G/4G/3G/2G-V, HG4G/3G, HG2G-5F/-5T, HG1G/1P: " * . / : < > ? \ |

- After operation starts, the folders created in the External Memory Device folder and the file names cannot be changed.

Remove Files

Select this check box to erase the files saved in the External Memory Device folder.

All Screenshots: Select this check box to erase all the screenshots in the "CAPTURE" folder.

All Alarm Log files: Select this check box to erase all the Alarm Log data saved in the "ALARMLOG" folder.

All Data Log files: Select this check box to erase all the Data Log data saved in the "DATALOG" folder.

All Operation Log files: Select this check box to erase all the Operation Log data saved in the "OPERATIONLOG" folder.

Trigger Device Address: Specifies the bit device or the bit number of the word device to serve as condition to delete the files.

Click  to display the Tag Editor. For the device address configuration procedure, refer to Chapter 2 "5.1 Device Address Settings" on page 2-70.

*1 USB flash drive inserted in USB1 for HG2J-7U, SD memory card for HG5G/4G/3G/2G-V, HG4G/3G and HG2G-5F, USB flash drive for HG2G-5T and HG1G/1P

3.10 Autorun Tab

HG2J-7U HG5G-V HG4G-V HG4G HG3G-V HG3G HG2G-V HG2G-5F HG2G-5T HG1G HG1P

The **Autorun** tab is used to configure the functions for a USB flash drive inserted in the MICRO/I. For details, refer to Chapter 31 "2 USB Autorun Function" on page 31-19.

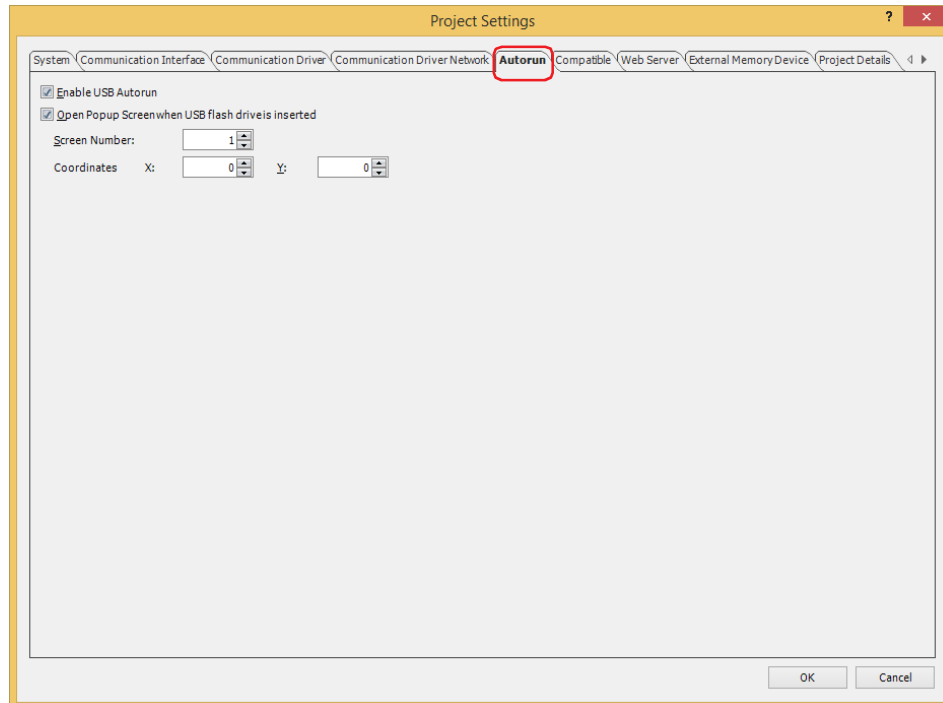

■ Enable USB Autorun

Select this check box to enable the USB Autorun function.

The USB Autorun function automatically displays a menu screen from which the user can execute predefined commands when a USB flash drive is inserted in the MICRO/I.

■ Open Popup Screen when USB Flash Drive is inserted

Select this check box to display a popup screen when a USB flash drive is inserted in the MICRO/I.

Screen Number: Specifies the popup screen number (1 to 3015) to display when a USB flash drive is inserted in the MICRO/I.

Coordinates X, Y: Specifies the coordinates to display the popup screen. With the upper-left corner of the screen as the origin, the X and Y coordinates are the upper-left corner of the popup screen.

The units and range for the display coordinates are as follows.

Specify the coordinates in 1 dot units.

X: 0 to (base screen horizontal size - 1)

Y: 0 to (base screen vertical size - 1)

3.11 Expansion Module Tab

HG2J-7U HG5G-V HG4G-V HG4G HG3G-V HG3G HG2G-V HG2G-5F HG2G-5T HG1G HG1P

The **Expansion Module** tab is used to configure input and output expansion modules attached to the MICRO/I. For details on expansion modules, refer to Chapter 30 "Expansion Modules" on page 30-1.

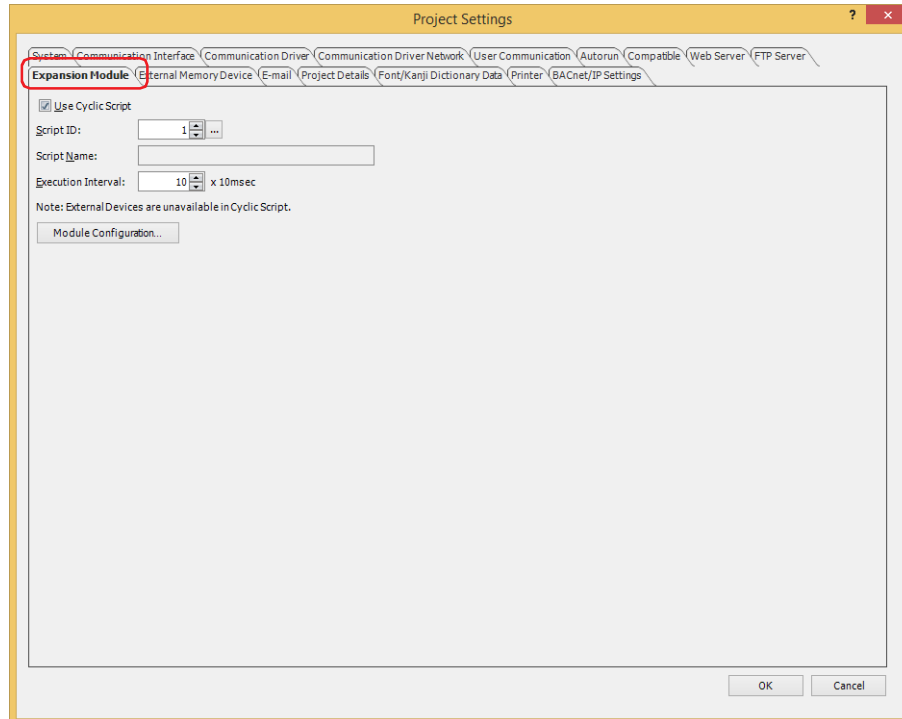

■ Use Cyclic Script

A Cyclic Script is a script with a trigger condition that is a fixed interval (10 ms increments). When a script is specified as a Cyclic Script, it executes at the specified fixed interval independent of the scan time of the screen (processing time for parts on the screen).

Select this check box to use a Cyclic Script. Only one Cyclic Script can be configured for the project.

■ Script ID

Specify the script ID to use (1 to 32000) as the Cyclic Script.

Click to display Script Manager. Select a script from the script list. For details, refer to Chapter 20 "2.2 Script Manager" on page 20-7.

■ Script Name

Displays the name of the script specified with **Script ID**.

■ Execution Interval

Specifies the interval to execute the script as 10 to 1000 (10 ms increments).

■ Module Configuration*1

Displays the **Module Configuration** dialog box. For details, refer to Chapter 30 "5 Module Configuration Dialog Box" on page 30-30.

*1 HG5G/4G/3G/2G-V only

3.12 Web Server Tab

HG2J-7U HG5G-V HG4G-V HG4G HG3G-V HG3G HG2G-V HG2G-5F HG2G-5T HG1G HG1P

The **Web Server** tab configures the MICRO/I's Web Server function. For details, refer to Chapter 28 "1 Web Server Function" on page 28-1.

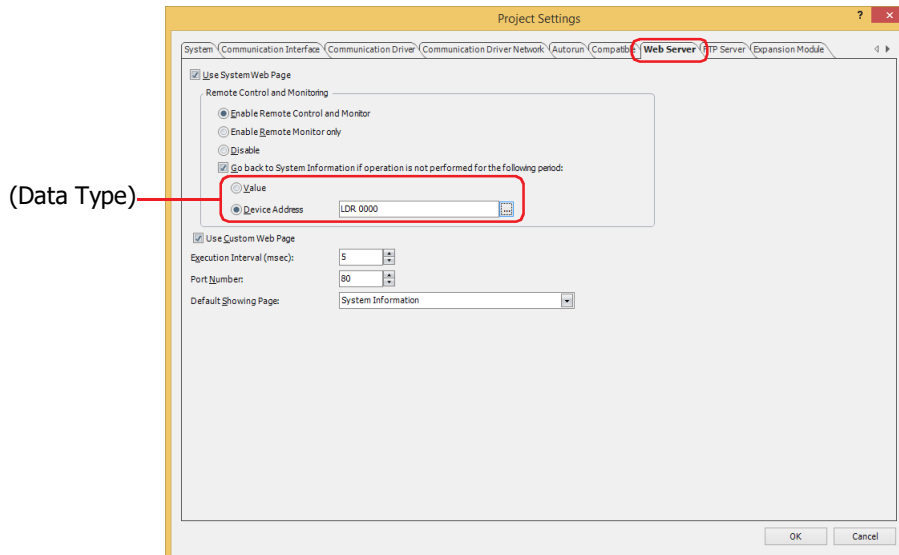

■ Use System Web Page

Select this check box to access the Remote Control page, Remote Monitor page or System Detailed Information page of MICRO/I from a web browser terminal.

Remote Control and Monitoring:

Select the functions allowed when accessing the MICRO/I from a web browser terminal from the following.

This option can only be set when **Use System Web Page** is selected.

Enable Remote Control and Monitor: Displays a screenshot of the screen displayed on the MICRO/I. You can also control the MICRO/I being monitored by clicking on the displayed screenshot.

Enable Remote Monitor only: Displays a screenshot of the screen displayed on the MICRO/I.

Disable: Displays only the detailed system information page.

Go back to System Information if operation is not performed for the following period:

Select this check box to automatically return to the homepage when no action is performed in the Remote Control page or Remote Monitor page for a specified time. Specify the time until the page returns to the System Information page following the last action performed in the Remote Control page or the Remote Monitor page.

This can only be set when **Enable Remote Control and Monitor** or **Enable Remote Monitor only** is selected.

(Data Type): Select the data type for which the System Information page return time is specified. Units are minutes.

Value: Use a constant value (1 to 60).

Device Address: Use a value of device address.

Click  to display the Tag Editor. For the device address configuration procedure, refer to Chapter 2 "5.1 Device Address Settings" on page 2-70.



If **Device Address** is selected for (Data Type), note the following points:

- If the value of device address is set to 61 or higher, it will be treated as 60 minutes.
- Once a network connection is established between the web browser and the MICRO/I, the timeout period cannot be changed. The timeout period needs to be set in Device Address before a web browser access to the MICRO/I.

■ Use Custom Web Page

Select this check box to access the Custom Web Page saved in the external memory device of MICRO/I from a web browser terminal. For details, refer to Chapter 28 "1.6 Custom Web Page" on page 28-12.

■ Execution Interval (msec)

Specifies the interval (0 to 5,000 ms) for the MICRO/I to return data. The load that the remote control function and the remote monitoring function place on MICRO/I operation can be reduced by increasing this value. However, the display update speed in the web browser will become slower.

■ Port Number

Specifies the TCP port number to use for the Web Server function (0 to 65,535).



Regarding TCP port number of MICRO/I, note the following points.

The numbers that cannot be used:

- 2539: Maintenance communication (Data Transfer)
- 2538: For pass-through
- 2101: For FC4A Series MicroSmart direct connection pass-through

Duplicate numbers cannot be configured in the following functions:

- Maintenance communication
(☞ refer to "Port Number" on page 4-41)
- Web server function
- FTP server function (☞ refer to "Port Number" on page 4-68)
- **TCP Server** is selected for the User Communication
(☞ refer to "Port No." on page 4-43)
- **Modbus** as **Manufacture** and **Modbus TCP Server** as **Communication Driver** are selected on the **Communication Driver** tab
(☞ refer to the WindO/I-NV4 External Device Setup Manual)
- **YASKAWA Electric** as **Manufacture** and **MP2000(Ethernet)** as **Communication Driver** are selected on the **Communication Driver** tab
(☞ refer to the WindO/I-NV4 External Device Setup Manual)

■ Default Showing Page

Select the web page to display first when accessing the MICRO/I from a web browser terminal from the following. System Information, Remote Monitor, Remote Control

In (Custom Web Page), the Custom Web page file name is displayed in **Web Page Editor** of the **Project** window. This option can only be set when Use System Web Page or Use Custom Web Page is selected.

3.13 FTP Server Tab

HG2J-7U HG5G-V HG4G-V HG4G HG3G-V HG3G HG2G-V HG2G-5F HG2G-5T HG1G HG1P

The **FTP Server** tab configures the MICRO/I's FTP Server function. For details, refer to Chapter 28 "2 FTP Server Function" on page 28-16.

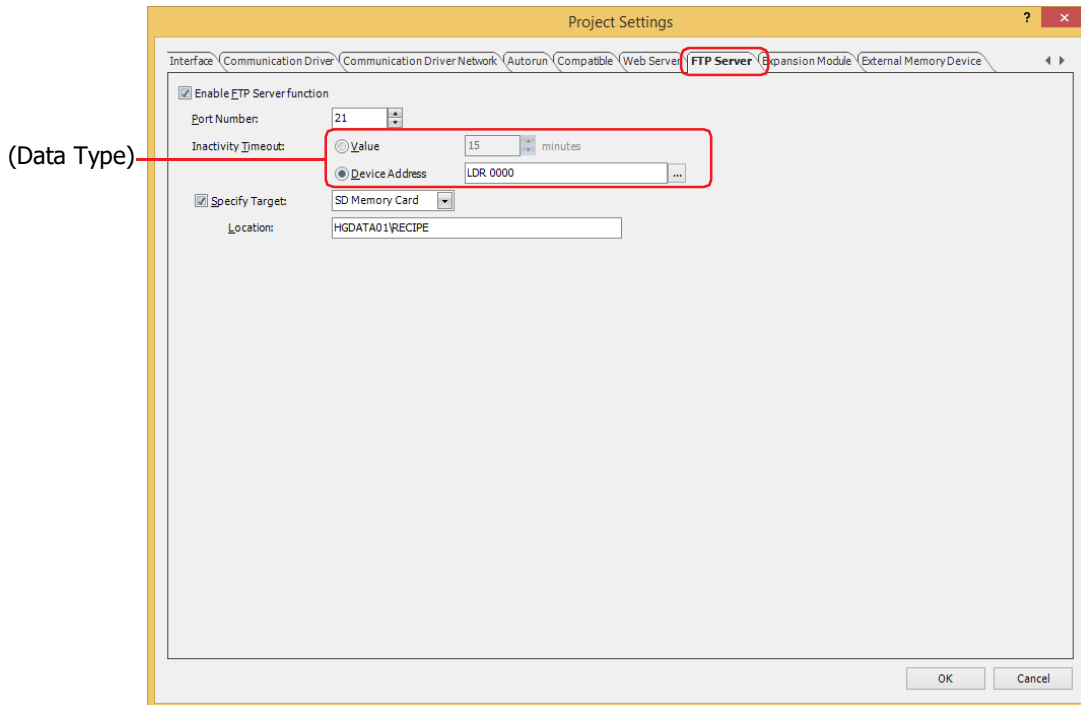

■ Enable FTP Server function

Select this box to enable FTP Server function.

This allows the FTP client to read or write the file contained in the external memory device inserted in the MICRO/I.

■ Port Number

Specifies the TCP port number to use for the FTP server function (0 to 65535).



Regarding TCP port number of MICRO/I, note the following points.

The numbers that cannot be used:

- 2539: Maintenance communication (Data Transfer)
- 2538: For pass-through
- 2101: For FC4A Series MicroSmart direct connection pass-through

Duplicate numbers cannot be configured in the following functions:

- Maintenance communication
(☞ refer to "Port Number" on page 4-41)
- Web server function (☞ refer to "Port Number" on page 4-67)
- FTP server function
- **TCP Server** is selected for the User Communication
(☞ refer to "Port No." on page 4-43)
- **Modbus as Manufacture** and **Modbus TCP Server as Communication Driver** are selected on the **Communication Driver** tab
(☞ refer to the WindO/I-NV4 External Device Setup Manual)
- **YASKAWA Electric as Manufacture** and **MP2000(Ethernet)** as **Communication Driver** are selected on the **Communication Driver** tab
(☞ refer to the WindO/I-NV4 External Device Setup Manual)

■ Inactivity Timeout

Set the timeout period between the MICRO/I and the FTP Client. After log in to the MICRO/I, if there is no communication between the MICRO/I and the FTP client for a specified set time, the MICRO/I will automatically disconnect the communication.

(Data Type): Select the data type for the timeout period until the MICRO/I disconnects the FTP client. Units are minutes.

Value: Use a constant value (1 to 60).

Device Address: Use a value of device address.

Click  to display the Tag Editor. For the device address configuration procedure, refer to Chapter 2 "5.1 Device Address Settings" on page 2-70.



- The timeout period to login the MICRO/I is 1 minute.
- If **Device Address** is selected for (Data Type), note the following points:
 - When the value of device address is 0, the Inactivity Timeout is 1 minute, and when the value of device address is 61 or more, the Inactivity Timeout is regarded as 60 minutes.
 - Once a network connection is established between the FTP client and the MICRO/I, the timeout period cannot be changed. The timeout period needs to be set in Device Address before connecting the FTP client to the MICRO/I.

■ Specify Target

Select **SD Memory Card**^{*1}, **USB Flash Drive**^{*2}, **USB1**^{*3} or **USB2**^{*3} to specify target folder. When you specify the target folder, you cannot access the higher level folders.

Location: Specify the location of the target folder path. The maximum number is 247 characters. Only alphanumeric characters and symbols can be used. Path delimiters and characters that cannot be used vary based on the model.

Model	Delimiter	Characters that cannot be used
HG2J-7U	/	" # \$ & ' () * : ; < > ? \ ` ~
HG5G/4G/3G/2G-V, HG4G/3G, HG2G-5F/-5T, HG1G/1P	\	" * : ; < > ?

Example: Access the "RECIPE" folder under "HGDATA01" folder on the external memory device

HG2J-7U: HGDATA01/RECIPE

HG5G/4G/3G/2G-V, HG4G/3G, HG2G-5F/-5T, HG1G/1P: HGDATA01\RECIPE

*1 HG5G/4G/3G/2G-V, HG4G/3G, HG2G-5F only

*2 HG5G/4G/3G/2G-V, HG4G/3G, HG2G-5F/-5T, HG1G/1P only

*3 HG2J-7U only

3.14 E-mail Tab

HG2J-7U HG5G-V HG4G-V HG4G HG3G-V HG3G HG2G-V HG2G-5F HG2G-5T HG1G HG1P

You can set the outgoing mail server (SMTP) to be used for sending an e-mail from MICRO/I. For details, refer to Chapter 28 "4 E-mail Function" on page 28-38.

The screenshot shows the 'Project Settings' dialog box with the 'E-mail' tab selected. The settings are organized into sections: General Setting, Authentication Setting, and Advanced Setting. In the General Setting section, 'Outgoing mail server (SMTP):' has 'IP Address' selected with the value '192.168.0.44'. Other fields include 'Outgoing mail server (SMTP) port number: 587', 'Sender E-mail Address: test@example.com', and 'Sender Name: Test'. The Authentication Setting section has 'Require authentication (LOGIN) to send E-mail' checked, with 'Account Name: test_account' and 'Password: *****'. The Advanced Setting section has 'Specify General setting and Authentication setting by Value of Device Address' checked, with 'Top Device Address: LDR 0100' and 'Copy the settings as default value to Device Address: LM 0000'. 'OK' and 'Cancel' buttons are at the bottom right.

■ General Setting

Outgoing mail server (SMTP): Selects the Outgoing mail server (SMTP) setting method.

Host Name: Specifies the Host Name of the outgoing mail server (SMTP).
The maximum number is 40 characters. Only alphanumeric characters, -(dash) and .(period) can be used.

IP Address: Specifies the IP address of the outgoing mail server (SMTP).
The format is "xxx.xxx.xxx.xxx". "xxx" stands for a numeric value from 0 to 255.



If Host Name is selected, the IP address of the outgoing mail server (SMTP) is looked up and obtained from the host name using the DNS server. In order to access a DNS server from the MICRO/I, the IP address of the DNS server must be specified. For details, refer to "When Ethernet is selected under Interface Configuration" on page 4-41.

Outgoing mail server (SMTP) port number: Specifies the port number for the outgoing mail server (SMTP) (0 to 65535).



The outgoing mail server (SMTP) port number to use varies based on the server. For details, contact the administrator of the network which the MICRO/I is connected to.



Normally, port number 25 for SMTP, and port number 587 for SMTP-AUTH are used.

Sender E-mail Address: Enter an e-mail address of the sender. The maximum number is 40 characters. Only alphanumeric characters and symbols can be used.



For how to judge the validity of e-mail address format, refer to Chapter 2 "Error Check" on page 2-63.

Sender Name: Enter a name of the sender. The maximum number is 40 characters. Only alphanumeric characters and symbols can be used.

Use secure connection (SSL/TLS):

Select this check box to use SSL/TLS communications with the outgoing mail server. The protocol to use varies based on the model and the port number.

Model	Port No.	Protocol or Command
HG2J-7U	465	SMTPS
	587	STARTTLS
	Other than 465 and 587	STARTTLS
HG5G/4G/3G/2G-V, HG4G/3G, HG2G-5F/-5T, HG1G/1P	Any number	SMTPS

■ Authentication Setting

Require authentication (LOGIN) to send E-mail: Select this check box to access the outgoing mail server (SMTP) protected with an account name and a password.

Account Name: Enter a name of the account. The maximum number is 40 characters. Only alphanumeric characters and symbols can be used.

Password: Enter a password. The maximum number is 40 characters. Only alphanumeric characters and symbols can be used.

■ Advanced Setting

Specify General setting and Authentication setting by Value of Device Address:

Select this check box to set the **General Setting** and the **Authentication Setting** using the value of the specified device address.

Top Device Address: Specify the word device to use. It allocates the settings of the **General Setting** and the **Authentication Setting** starting at the configured device address. You can only specify an internal device.

Click to display the Tag Editor. For the device address configuration procedure, refer to Chapter 2 "5.1 Device Address Settings" on page 2-70.

Copy the settings as default value to Device Address: Select this check box to copy the settings in the **General Setting** and the **Authentication Setting** to device addresses as default.

(Device Address): Specifies the bit device or the bit number of the word device that triggers the copy of the settings.

When the value of device address changes from 0 to 1, the values configured in the **General Setting** and the **Authentication Setting** are written, beginning from the device address set by the **Top Device Address**.

Click to display the Tag Editor. For the device address configuration procedure, refer to Chapter 2 "5.1 Device Address Settings" on page 2-70.



When the **Specify General setting and Authentication setting by Value of Device Address** check box is selected, an e-mail is not sent when the value of the device address allocated as the **Sender E-mail Address** or the **Sender Name** is 0, and the value of LSD222 changes to 1.

Device Addresses for General Setting and Authentication Setting

When the **Specify General setting and Authentication setting by Value of Device Address** check box is selected, it allocates the settings of the **General Setting** and the **Authentication Setting** starting at the device address set in the **Top Device Address**. The details are shown below.

Settings	Address Number	Words	Data Format
Outgoing mail server (SMTP)	+0 to +20	21 ^{*1, *2}	Host Name is selected: String IP Address is selected: Decimal
Outgoing mail server (SMTP) port number	+21	1	Decimal
Sender E-mail Address	+22 to +42	21 ^{*2, *3}	String
Sender Name	+43 to +63	21 ^{*2, *3}	String
Require authentication (LOGIN) to send E-mail (0: Not require authentication, 1: Require authentication)	+64	1	Decimal
Account Name	+64 to +85	21 ^{*2, *3}	String
Password	+86 to +106	21 ^{*2, *3}	String
Use secure connection (SSL/TLS) (0: Disable, 1: Enable)	+107	1	Decimal



String data is stored in the upper byte and lower byte according to the **Storage Method of String Data** setting. For details, refer to "Storage Method of String Data" on page 4-29.

*1 When IP address is selected, use only four words from the beginning, and the remaining seventeen words are left as a reserved area.

*2 The twenty-first word is recognized as a NULL terminating character (0x00) regardless of the value of device address.

*3 Add a NULL terminating character (0x00) as the end of the string data when the string length is less than twenty words.

Example: The **Authentication Setting** and the **General Setting** are set as follows:

Settings	Preset Value
Outgoing mail server (SMTP), IP Address is selected.	192.168.0.44
Outgoing mail server (SMTP) port number	587
Sender E-mail Address	test@example.com
Sender Name	Test
Require authentication (LOGIN) to send E-mail	Selected
Account Name	test_account
Password	test_password
Use secure connection (SSL/TLS)	Selected
Top Device Address	LKR 100
Storage Method of String Data	from Upper byte

(The address number of Top Device Address)	+0	LKR 100	}	Outgoing mail server (SMTP)
	}			
	+20	LKR 120	}	Outgoing mail server (SMTP) port number
	+21	LKR 121		
	+22	LKR 122	}	Sender E-mail Address
	}			
	+42	LKR 142	}	Sender Name
	+43	LKR 143		
	+63	LKR 163	}	Require authentication (LOGIN) to send E-mail
	+64	LKR 164		
	+65	LKR 165	}	Account Name
	}			
	+85	LKR 185	}	Password
	+86	LKR 186		
	+106	LKR 206	}	Use secure connection (SSL/TLS)
	+107	LKR 207		

The value of each device address is listed below.

Settings	Preset Value										
Outgoing mail server (SMTP)	Device Address	LKR 100	LKR 101	LKR 102	LKR 103	LKR 104 to LKR 120					
	Value (Decimal)	192	168	0	44	Reserved					
Outgoing mail server (SMTP) port number	Device Address	LKR 121									
	Value (Decimal)	587									
Sender E-mail Address	Device Address	LKR 122	LKR 123	LKR 124	LKR 125	LKR 126	LKR 127	LKR 128	LKR 129	LKR 130	LKR 131 to LKR 142
	String (ASCII)	't'e'	's't'	'@^e'	'x^a'	'm^p'	'l^e'	'.^c'	'o^m'	'\0^0'	'\0^0'
	Value (Hexadecimal)	7465h	7374h	4065h	7861h	6D70h	6C65h	2E63h	6F6Dh	0000h	0000h
Sender Name	Device Address	LKR 143	LKR 144	LKR 145	LKR 146 to LKR 163						
	String (ASCII)	'T^e'	's^t'	'\0^0'	'\0^0'						
	Value (Hexadecimal)	5465h	7374h	0000h	0000h						
Require authentication (LOGIN) to send E-mail	Device Address	LKR 164									
	Value (Decimal)	1									
Account Name	Device Address	LKR 165	LKR 166	LKR 167	LKR 168	LKR 169	LKR 170	LKR 171	LKR 172 to LKR 185		
	String (ASCII)	't^e'	's^t'	'_^a'	'c^c'	'o^u'	'n^t'	'\0^0'	'\0^0'		
	Value (Hexadecimal)	7465h	7374h	5F61h	6363h	6F75h	6E74h	0000h	0000h		

Settings	Preset Value									
Password	Device Address	LKR 186	LKR 187	LKR 188	LKR 189	LKR 190	LKR 191	LKR 192	LKR 193 to LKR 206	
	String (ASCII)	't^e'	's^t'	'_ ^p'	'a^s'	's^w'	'o^r'	'd^0'	'0^0'	
	Value (Hexadecimal)	7465h	7374h	5F70h	6173h	7377h	6F72h	6400h	0000h	
Use secure connection (SSL/TLS)	Device Address	LKR 207								
	Value (Decimal)	1								

3.15 Project Details Tab

HG2J-7U HG5G-V HG4G-V HG4G HG3G-V HG3G HG2G-V HG2G-5F HG2G-5T HG1G HG1P

The **Project Details** tab displays and configures project data information.

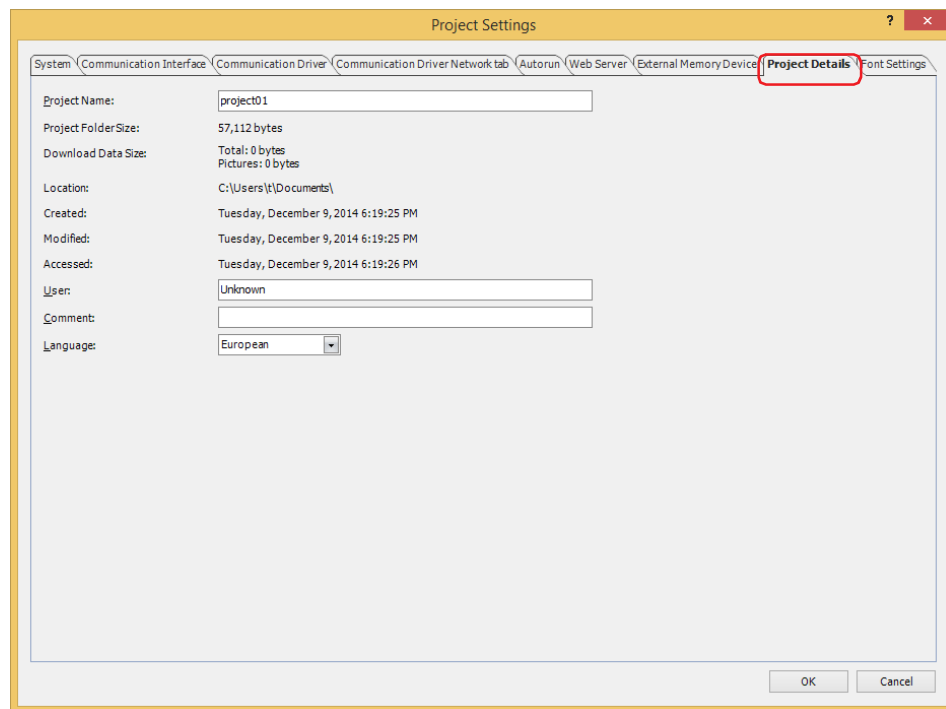

- **Project Name**
Shows the current project name.
- **Project Folder Size**
Shows the total size of the current project data.
- **Download Data Size**
Shows the total size of the data and the total size of only the image files when the current project data is downloaded.
- **Location**
Shows the save location for the current project data.
- **Created**
Shows the date and time the current project data was created.
- **Modified**
Shows the date and time the current project data was last saved.
- **Accessed**
Shows the date and time the current project data was opened.
- **User**
Enter the name of the creator. The maximum number is 40 characters.
- **Comment**
Enter a comment for the project data. The maximum number is 40 characters.
- **Language**
Select the language used for outputting alarm log data to the printer^{*1}, and when saving alarm log, data log, and operation log data as CSV files:
Western, Japanese, Simplified Chinese, Traditional Chinese, Hangul, Central European, Baltic, Cyrillic
 The display type for dates and times varies based on the selected language.
 Japanese: YYYY/MM/DD hh:mm:ss
 Western, Simplified Chinese, Traditional Chinese, Hangul, Central European, Baltic, Cyrillic: MM/DD/YYYY hh:mm:ss

*1 HG5G/4G/3G/2G-V, HG4G/3G, HG2G-5F only

3.16 Font/Kanji Dictionary Data Tab

HG2J-7U HG5G-V HG4G-V HG4G HG3G-V HG3G HG2G-V HG2G-5F HG2G-5T HG1G HG1P

The **Font/Kanji Dictionary Data** tab is used to configure the optional fonts and the Kanji dictionary data when downloading to the MICRO/I.

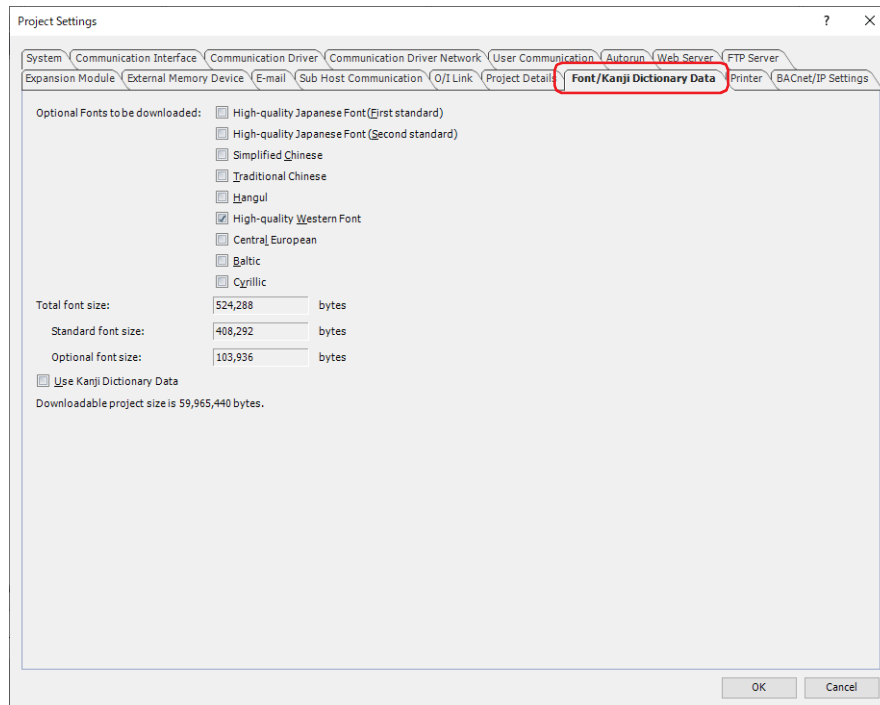

■ Optional Fonts to be downloaded

Select the optional fonts for download to the MICRO/I. Select the check boxes for the optional fonts when downloading:

Japanese Large Font (First standard), Japanese Large Font (Second Standard), High-quality Western Font, Simplified Chinese, Traditional Chinese, Hangul, Central European, Baltic, Cyrillic.



- Optional fonts, if left cleared, will be removed from the MICRO/I when the project data is downloaded.
 - The check boxes for optional fonts used in drawings, parts, and Text Manager are automatically selected.
- For details about optional fonts, refer to Chapter 2 "Installed Fonts in the MICRO/I" on page 2-7.

■ Total font size

Shows the total size of the standard fonts and selected optional fonts.

If no optional fonts are selected for download to the MICRO/I, shows the size of the standard fonts.

Standard font size: Shows the total size of the standard fonts.

Optional font size: Shows the total size of the selected optional fonts.

■ Use Kanji Dictionary Data*1

Select this check box to download the Kanji dictionary data to the MICRO/I.



If the **Use Kanji Dictionary Data** check box was cleared, will be removed the Kanji dictionary data from the MICRO/I when the project data is downloaded.

*1 HG5G/4G/3G/2G-V only

3.17 Compatible Tab

HG2J-7U HG5G-V HG4G-V HG4G HG3G-V HG3G HG2G-V HG2G-5F HG2G-5T HG1G HG1P

The **Compatible** tab is used to enable the functions in previous versions of WindO/I-NV4 and older MICRO/I series (HG1B).

This tab is displayed only when the **Use Compatible functions for previous version** check box or the **Use HG1B Compatible functions** check box is selected in the **WindO/I-NV4 Options** dialog box, on the **General** tab, under **Compatibility**.

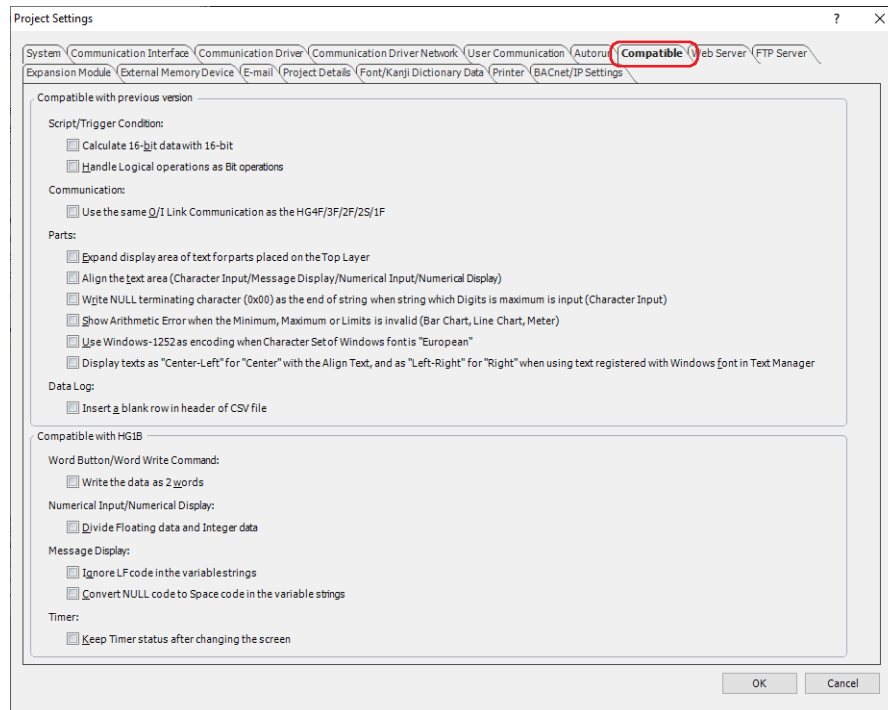

■ Compatible with previous version

This option is displayed only when the **Use Compatible functions for previous version** check box is selected in the **WindO/I-NV4 Options** dialog box, on the **General** tab, under **Compatibility**.

Script/Trigger Condition:

Calculate 16-bit data with 16-bit:

Select this check box to calculate arithmetic operations (+, -, *, /, modulo) as 16-bit data when **UBIN16(W)**, **BIN16(I)**, or **BCD4(B)** is selected for **Data Type**. Data that exceeds 16 bits is lost.
Clear this check box to calculate as 32 bits. No data will be lost.

Handle Logical operations as Bit operations:

Select this check box to process logical operations (||, &&) by replacing them with bit operations (|, &). The priority of the replaced bit operators is the same as the corresponding logical operators.

Communication:

Use the same O/I Link Communication as the HG4F/3F/2F/2S/1F:

Select this check box if you will connect the HG5G/4G/3G/2G-V, HG4G/3G or HG2G-5F/-5T, HG1G/1P to the O/I Link Communication of the HG4F/3F/2F/2S/1F.

Parts:

Expand display area of text for parts placed on the Top Layer:

Select this check box to draw text even when a part of the text is located outside of the part. However, if the text too far outside the outline of the part, it may not be drawn.

Align the text area (Character Input/Message Display/Numerical Input/Numerical Display):

For characters displayed in Numerical Input, Character Input, Message Display, and Numerical Display, select this check box to align characters based on the area of maximum displayable character length.

Write NULL terminating character (0x00) as the end of string when string which Digits is maximum is input (Character Input):

Select this check box to write a NULL character (0x00) at the end character when a string of the maximum length has been input.

Show Arithmetic Error when the Minimum, Maximum or Limits is invalid (Bar Chart, Line Chart, Meter):

Select this check box to display the Processing error when the following values are invalid.

Bar Chart, Line Chart: Minimum, Maximum

Meter: Minimum, Maximum, Limits for the range

Use Windows-1252 as encoding when Character Set of Windows font is "European"

Select this check box to use Windows-1252 as encoding when the character set of the Windows Font is "European".

Display texts as "Center-Left" for "Center" with the Align Text, and as "Left-Right" for "Right" when using text registered with Windows font in Text Manager:

When displaying multi-line text registered with Windows fonts, select this check box to display the text aligned center-left when Center is selected, and the text with right-indented left-aligned when Right is selected. When the check box is selected, the operation is the same as WindO/I-NV4 Ver. 1.11.4 or earlier. The follows show how text appears using the "Center-Left" and the "Left-Right".

Center-Left: Centers the line containing the most number of characters, and then aligns the other lines to the left end of that line.

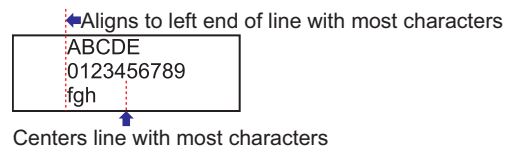

Left-Right: Aligns the line containing the most number of characters along the right edge, and then aligns the other lines to the left end of that line.

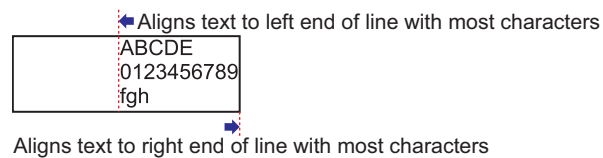

Data Log

Insert a blank row in header of CSV file: Select this check box to insert a blank row to the third line of the header. For the data structure, refer to Chapter 14 "Data Structure and Output Example" on page 14-45.

■ Compatible with HG1B

These options are displayed only when the **Use HG1B Compatible functions** check box is selected in the **WindO/I-NV4 Options** dialog box, on the **General** tab, under **Compatibility**.

Word Button/Word Write Command:

Write the data as 2 words:

Select this check box to write the calculated result of arithmetic operations (+, -, *, /) as two words when **UBIN16(W)** or **BIN16(I)** is selected for **Data Type**. For +, -, *, /, the calculated result is written in two words as a 32-bit numeric value. For "/" (division), the quotient data is written in the first word, and the remainder data is written in the second word. Clear this check box to write the result of arithmetic operations as one word.

Numerical Input/Numerical Display:

Divide Floating data and Integer data:

Select this check box to read and display the decimal portion of data and the integer portion of data from different device addresses when **BCD4(B)** or **BCD8(EB)** is selected for **Data Type**.

Message Display:

Ignore LF code in the variable strings:

Select this check box to display messages by ignoring the linefeed code LF (0Ah) when displaying text according to values of device addresses.

Clear this check box to display messages with line breaks using the linefeed code LF (0Ah).

Convert NULL code to Space code in the variable strings:

Select this check box to display messages by converting the NULL terminating code (00h) to a space (20h) when displaying text according to values of device addresses.

Clear this check box to terminate messages with the NULL terminating code (00h).

Timer:

Keep Timer status after changing the screen: Select this check box to continue the timer count when switching the base screen or when displaying a popup screen.

3.18 BACnet/IP Settings Tab

HG2J-7U HG5G-V HG4G-V HG4G HG3G-V HG3G HG2G-V HG2G-5F HG2G-5T HG1G HG1P

Enables the functions of the BACnet communication. For details on the BACnet communication, refer to Chapter 3 “7 BACnet Communication” on page 3-94.

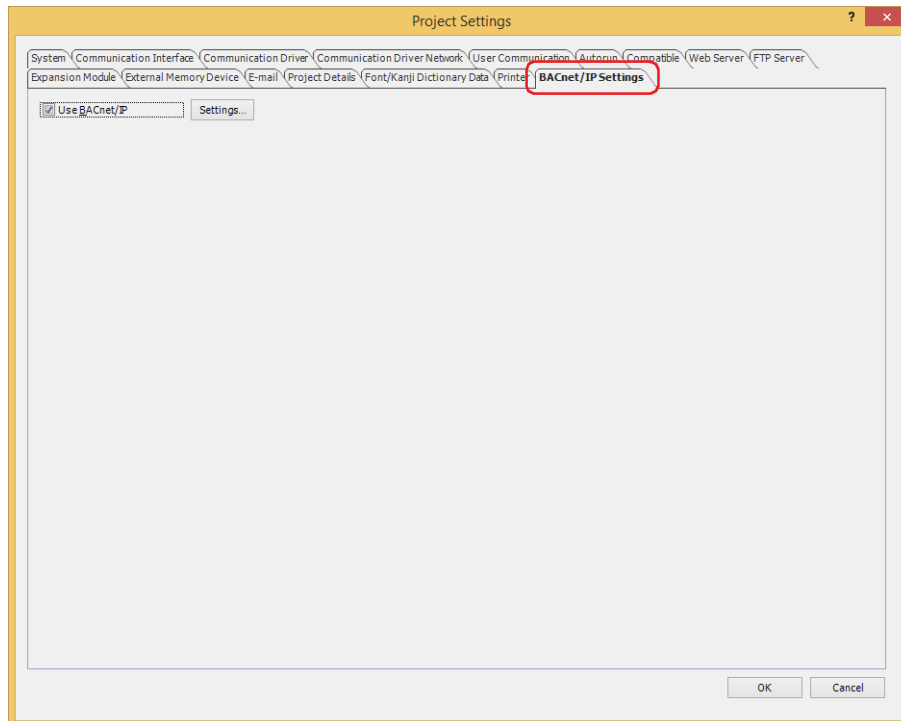

■ Use BACnet/IP

Select this check box to use the functions of the BACnet communication.

Click **Setting** to display the **BACnet Settings** dialog box.

3.19 Internal Clock Tab

HG2J-7U HG5G-V HG4G-V HG4G HG3G-V HG3G HG2G-V HG2G-5F HG2G-5T HG1G HG1P

Configure the SNTP server, time zone, and daylight saving time to get date and time data. The acquired date and time data is written to the internal clock of MICRO/I.

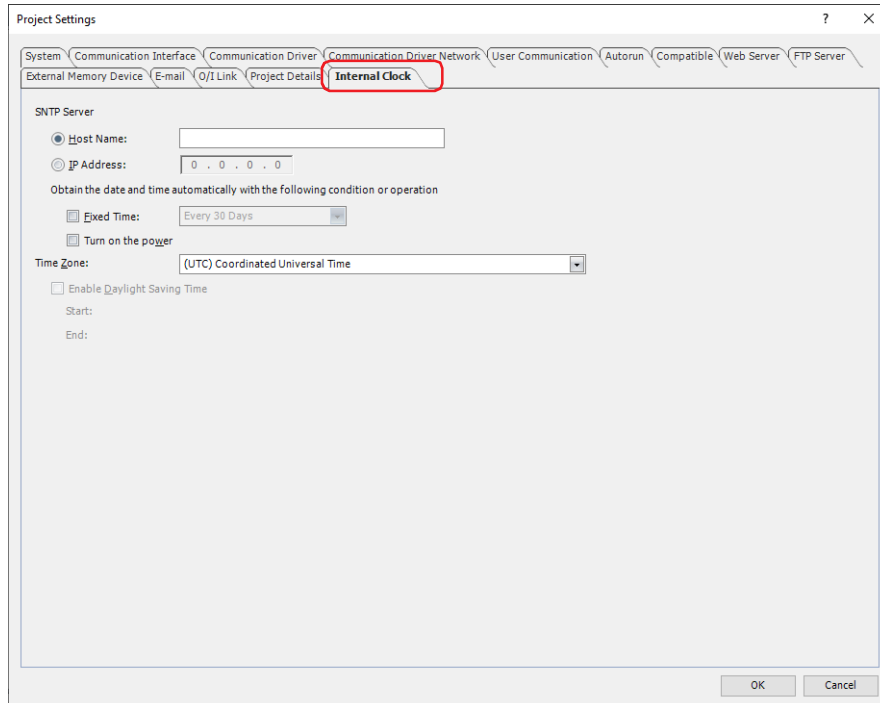

■ SNTP Server

Selects the SNTP server setting method.

- Host Name:** Specifies the host name of the SNTP server.
The maximum number is 40 characters. Only alphanumeric characters, -(dash) and .(period) can be used.
- IP Address:** Specifies the IP address of the SNTP server.
The format is "xxx.xxx.xxx.xxx". "xxx" stands for a numeric value from 0 to 255.



- If Host Name is selected, the IP address of the SNTP server is looked up and obtained from the host name using the DNS server. In order to access a DNS server from the MICRO/I, the IP address of the DNS server must be specified. For details, refer to "When Ethernet is selected under Interface Configuration" on page 4-41.
- The port number is 123.

Obtain the date and time automatically with the following condition or operation:

Set the conditions for acquiring date and time data from the SNTP server.

Fixed Time: Select this check box to get date and time data from the SNTP server on a regular basis, and then select the period to get the data from the following.

Every 10 Minutes, Every 1 Hour, Every 1 Day, Every 1 Week, Every 30 Days

Turn on the power: Select this check box to get the date and time data from the SNTP server when the MICRO/I power is turned on.

■ Time Zone

Select the time zone to set. (Default: (UTC) Coordinated Universal Time)

Enable Daylight Saving Time: Select this check box to correct the time to daylight saving time when it exists in the selected time zone.

Start: Displays the start date and time of daylight saving time.

End: Displays the end date and time of daylight saving time.



When the Enable Daylight Saving Time check box is selected, the following date and time in the Alarm Log, Data Log, and Operation Log functions may appear to log data at the same time twice, or to have advanced in time and no data has been logged. This is due to the daylight saving time correction.

- Date and time when output as a CSV file
- Output date and time added to the CSV file name
- Date and time displayed on the part



- The daylight saving time system is subject to change, therefore check the dates and times displayed in Start and End.
- IANA Time Zone Database version number 2019a is adopted.

● Checking the communication contents with the SNTP server

You can check the communication contents with the SNTP server through the values of the HMI Special Internal Relays and the HMI Special Data Registers.

■ LSM57

When the value of this bit changes from 0 to 1, get the current time from the SNTP server. The acquired current time is written to the MICRO/I internal clock and stored in the MICRO/I internal current time data (LSD13 to 19).

■ LSD29

The execution result of communication with the SNTP server is stored.

Status	Cause
0: Successfully Completed	-
2: Timeout error	The SNTP server does not return a response after the timeout period (30 seconds) has elapsed due to the following reasons. <ul style="list-style-type: none"> • An Ethernet cable is disconnected. • Host Name of the SNTP server is incorrect. • IP address of the SNTP server is incorrect. • A connection cannot be made to the preferred DNS server and alternate DNS server.
4: Other error	MICRO/I cannot perform communication with SNTP server

■ LSD30

The elapsed time (0 to 65535 minutes) from the time last obtained from the SNTP server to the current time is stored. If the current time is successfully obtained, the value will be reset and the elapsed time will start counting. Even if it fails to get the current time, the elapsed time counting continues without interruption until it succeeds.

4 Project Restrictions

HG2J-7U HG5G-V HG4G-V HG4G HG3G-V HG3G HG2G-V HG2G-5F HG2G-5T HG1G HG1P

4.1 Download Restrictions

■ Project Data Size

The size of the project data that can be downloaded to the MICRO/I is as follows.

MICRO/I	Project data size
HG5G/4G/3G/2G-V	Approx. 58 MB max (including additional fonts and Kanji Dictionary Data)
HG4G/3G, HG2G-5F, HG1G/1P	Approx. 12 MB max (including additional fonts)
HG2G-5T	Approx. 5 MB max (including additional fonts)



- To check the project data size, on the **Home** tab, in the **Project** group, click **Target Info**. The **Target Information** dialog box is displayed. The project data size can be checked with **Memory Space (byte)** under **Target Runtime Information**.
- The project data size varies based on the fonts downloaded to the MICRO/I. For details, refer to Chapter 2 "Optional Fonts" on page 2-8.

■ Number of Parts

The number of parts that can be downloaded to the MICRO/I are as follows.

Parts	Number of parts
Total number of Bit Buttons, Word Buttons, Goto Screen Buttons, Key Buttons	32,000 max.
Selector switches	200 max.

4.2 Maximum Number of External Device Addresses

■ Data Log Settings

A maximum of 128 external device addresses can be used in the Data Log settings.



If the same device address is used in multiple device address settings, the number of used device addresses is counted as 1. It is not counted as 1 device address per device address setting.

■ Global Script

A maximum of 256 external device addresses can be used as a trigger condition and in scripts executed as Global Script.



If the same device address is used in multiple device address settings, the number of used device addresses is counted as 1. It is not counted as 1 device address per device address setting.

■ Scripts

The number of external device addresses which can be used in the script are as follows:

Item	Number of devices
Destination external device addresses	64 max.
Source external device addresses	64 max.



- If the same device address is used in multiple device address settings, the number of used device addresses is counted as 1. It is not counted as 1 device address per device address setting.
- For the Global Script, the maximum number of source external device addresses which can be used as a trigger condition and in scripts executed as Global Script is 256.

■ **E-mail Settings, Social Media Settings**

The total number of external device addresses can be used in the E-mail Settings and the Social Media Settings is 255.



If the same device address is used in multiple device address settings, the number of used device addresses is counted as 1. It is not counted as 1 device address per device address setting.

■ **File Transfer Settings (FTP client function)**

A maximum of 240 external device addresses can be used in the File Transfer settings.

Chapter 5 Screen

This chapter gives an overview of the MICRO/I screen and describes how to create setup and operate the screen.

1 Screen Overview

HG2J-7U HG5G-V HG4G-V HG4G HG3G-V HG3G HG2G-V HG2G-5F HG2G-5T HG1G HG1P

1.1 Screen Types

The types of screens offered by the MICRO/I and screens that can be created with the WindO/I-NV4 are given below.

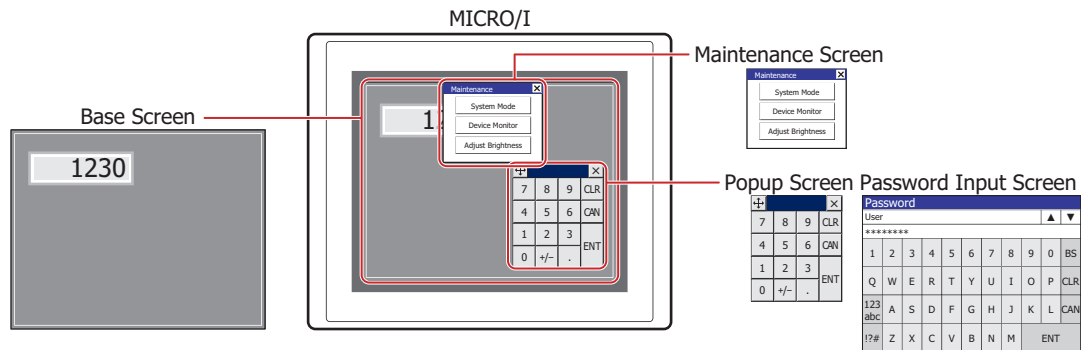

Screen Type	Screen No.	Description
Screens that can be created with the WindO/I-NV4	Base Screen	1 to 3000 The screen that is displayed when the MICRO/I is in Run Mode. This screen places drawing objects and parts on the base and creates a screen that is displayed on the MICRO/I.
	Popup Screen	1 to 3015 The Popup Screen that is displayed on the Base Screen when the MICRO/I is in Run Mode. The size and coordinates of the screen can be specified and this screen can also be moved on the Base Screen. A Popup Screen for the standard Keypad*1 will automatically be created in screen numbers 3001 to 3015.
	Password Input Screen	3026 to 3033 The Password Input Screen is used to enter the user name and password required for switching user accounts when the MICRO/I is in Run Mode. This screen can only be created when the Use Security functions check box and the Customize Password Input Screens check box in the Security dialog box are selected. If you are using the Password Input Screen provided by MICRO/I, you do not need to create the screen. For details, refer to Chapter 23 "4.1 Entering the Password on the MICRO/I" on page 23-47. A standard Password Input Screens will automatically be created in screen numbers 3026 to 3028.
The screen provided by the MICRO/I	Maintenance Screen	- Using the screen that is displayed when the MICRO/I is in Run Mode, you can switch from Run Mode to System Mode and load a screen to adjust device monitor and screen brightness. For details, refer to Chapter 34 "1 Maintenance Screen" on page 34-1.

1.2 Screen Size

The screen size differs depending on the MICRO/I model selected. The size of the MICRO/I screen is equal the size of the Base Screen.

Model	Screen Size (W x H)
HG2J-7U	800 x 480 dots
HG5G/4G/3G-V	1024 x 768 dots
HG4G/3G	800 x 600 dots
HG2G-V, HG2G-5F	640 x 480 dots
HG2G-5T	320 x 240 dots
HG1G/1P	480 x 272 dots

*1 The Keypad that is displayed when operating Numerical and Character Input parts when **Standard** is selected under **Type** in the **Keypad** menu for Numerical and Character Input parts.

2 Creating and Manipulating WindO/I-NV4 Screens

HG2J-7U HG5G-V HG4G-V HG4G HG3G-V HG3G HG2G-V HG2G-5F HG2G-5T HG1G HG1P

2.1 Creating Screens



The Password Input Screen is created only when the **Use Security functions** check box and the **Customize Password Input Screens** check boxes in the Security dialog box are selected. For details, refer to Chapter 23 "3 Security Dialog Box" on page 23-37.

● Creating a screen

- 1 On the **Home** tab, in the **Screens** group, click ▼ under **New**.
- 2 Click **Base Screen**, **Popup Screen** or **Password Input Screen**.

The **Screen Properties** dialog box is displayed.

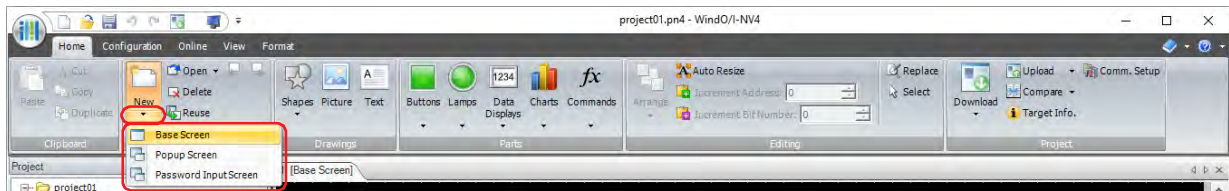

- To edit the properties for a Base Screen, Popup Screen or Password Input Screen that has already been created, double click an area in the editing window with no objects.
- The default of the screen's background color can be set on the **Default Preferences** tab in the **WindO/I-NV4 Options** dialog box. For details, refer to Chapter 2 "Default Preferences Tab" on page 2-63.

- 3 Change the settings on each tab as necessary and click the **OK** button.

2.2 Opening Screens

- **Opening a screen**
 You can open a single screen that has already been created.
 Double click the screen to open in the **Project** window.

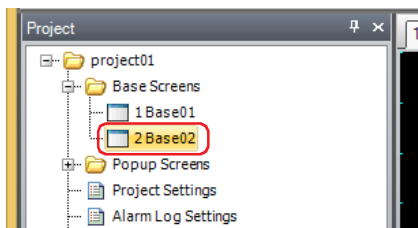

If you right click a screen in the **Project** window, and then click **Open Screens**, the selected screen opens.

- **Opening specific screens**
 You can open multiple screens as a group.
 - 1 On the **Home** tab, in the **Screens** group, click ▼ to the right of **Open**.
 - 2 Click **Base Screen**, **Popup Screen** or **Password Input Screen**.
 The **Open Screens** dialog box is displayed.

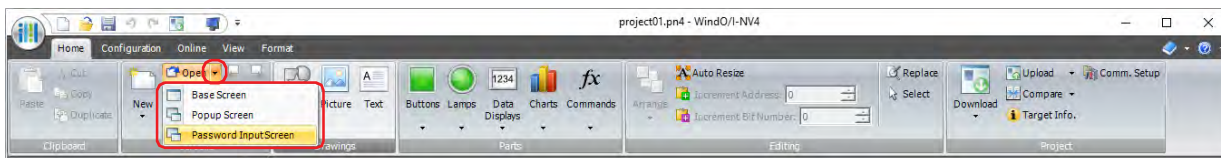

If you right click a screen folder in the **Project** window and then click **Open Screens**, the **Open Screens** dialog box is displayed.

- 3 Click the screens to open in **Screen List** and then click the **OK** button.



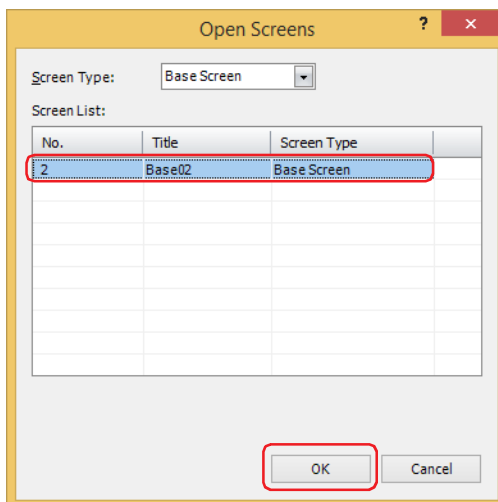

To select multiple screens, press and hold SHIFT or CTRL while you click the specific items.



- **Screen Type**
 Select the type of screen to open from the following items. The selected screen type is displayed in **Screen List**.
All, Base Screen, Popup Screen, Password Input Screen
- **Screen List**
 This list shows screens that have already been created.

- Opening the previous or next screen

You can open the screen with the previous screen number or the next screen number of the screen displayed in the active editing window.

To open the screen with the previous screen number, click the  (Open Previous Screen) button in the **Screens** group on the **Home** tab. To open the screen with the next screen number, click the  (Open Next Screen) button.

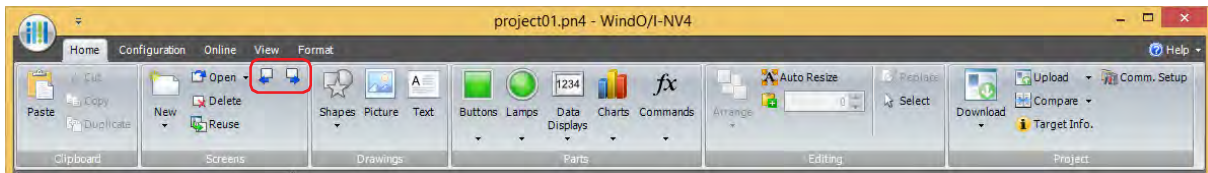

2.3 Closing Screens

- Closing the displayed screen
You can close the active editing window.

Click  in the upper-right of the editing window.

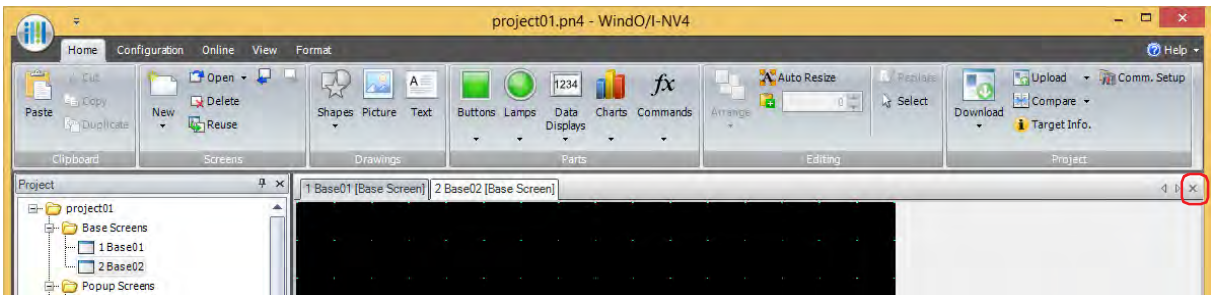

- Closing all screens
You can close all the editing windows.

On the **View** tab, in the **Window** group, click **Close All**.

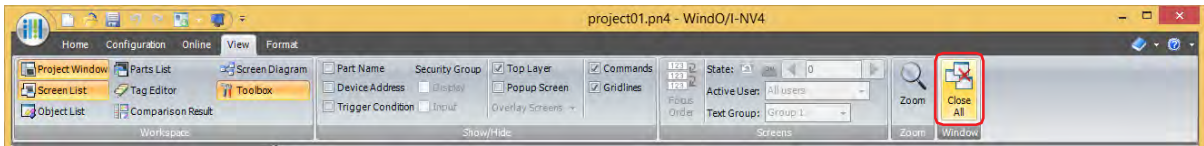

- Closing a specific screen
You can close multiple editing windows as a group.
- 1 Right click a screen folder in the **Project** window and click **Close Screens**.
The **Close Screens** dialog box is displayed.

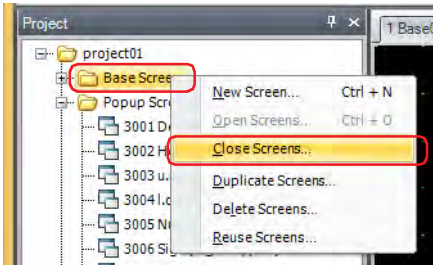

- 2 Click the screens to close in **Screen List** and click the **OK** button.



To select multiple screens, press and hold SHIFT or CTRL while you click the specific items.

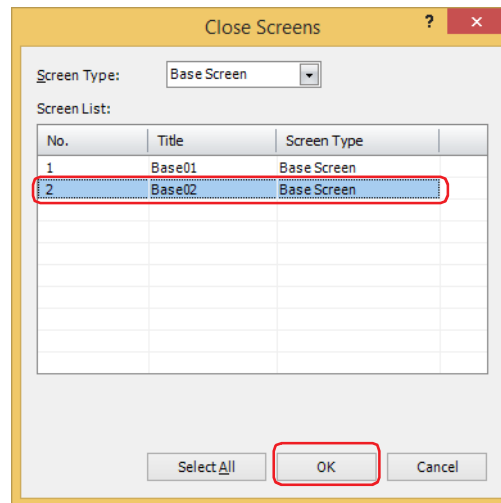

- **Screen Type**

Select the type of screen to close from the following items. The selected screen type is displayed in **Screen List**.

All, Base Screen, Popup Screen, Password Input Screen

- **Screen List**

This list shows the screens being edited.

- **Select All**

Selects all the screens displayed in **Screen List**.

2.4 Duplicating Screens

You can copy a screen that has already been created to create a new screen.

- 1 Right click a screen folder or screen in the **Project** window and click **Duplicate Screens**.
The **Duplicate Screens** dialog box is displayed.

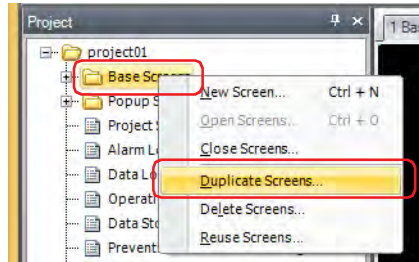

- 2 Select the screens to copy in **Screen List**.



To select multiple screens, press and hold SHIFT or CTRL while you click the specific items.

- 3 Specify **Screen Number** for the new screen and the **Number of copies** to duplicate and then click the **OK** button.

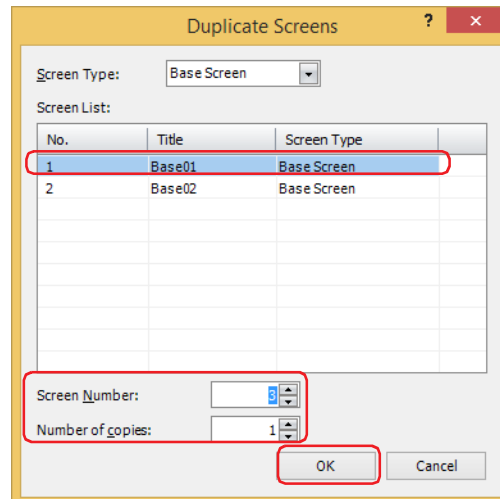

■ Screen Type

Select the type of screen to duplicate from the following items. The selected screen type is displayed in **Screen List**.
Base Screen, Popup Screen, Password Input Screen

■ Screen List

This list shows screens that have already been created.

■ Screen Number

Specify the screen number (Base Screen: 1 to 3000, Popup Screen: 1 to 3015, Password Input Screen: 3026 to 3033) for the new screen.

■ Number of copies

Specify the number of screens to copy (Base Screen: 1 to 2999, Popup Screen: 1 to 3014, Password Input Screen: 1 to 7).



- If multiple screens are selected in **Screen List** or if the **Number of copies** is 2 or more, consecutive screen numbers are added to the screens starting with the number specified in **Screen Number**.
Example: When a screen with screen number of **1** is selected in **Screen List**, the **Number of copies** is **3**, and **Screen Number** is **100** is selected, then the screen numbers after duplication are "100", "101", "102".

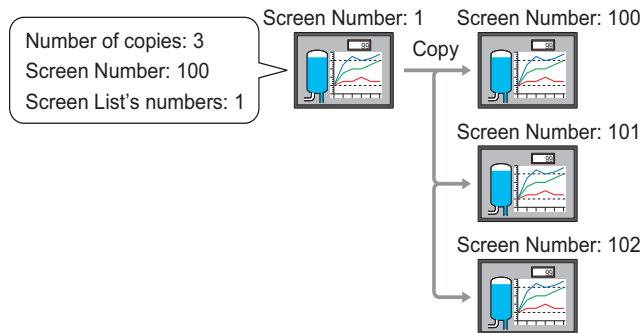

- Example: When screens with screen numbers **3** and **5** are selected in **Screen List**, the **Number of copies** is **2**, and **Screen Number** is **100** is selected, then the screen numbers after duplication are "100" and "102" for the screens duplicated from screen number **3** and "101" and "103" for the screens duplicated from screen number **5**.

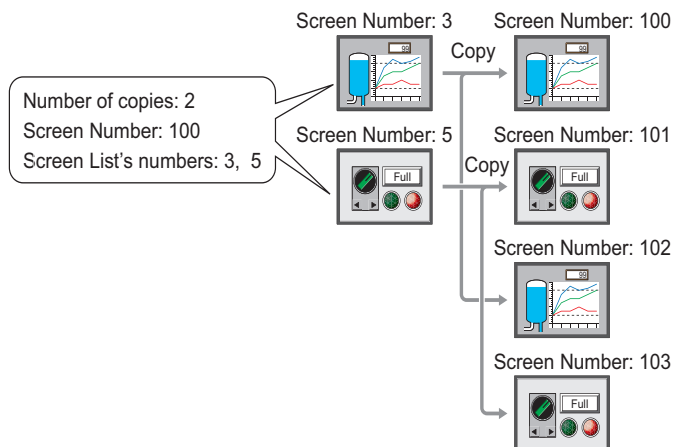

- If a screen number already exists after copying and you click the **OK** button on the **Duplicate Screens** dialog box, an overwrite confirmation message is displayed.
 - Click the **Yes** button to overwrite the screen with the number displayed in the confirmation message.
 - Click the **Yes To All** button to overwrite all the screens.
 - Click the **No** button to display the next confirmation message without copying the screen with the number displayed in the confirmation message.
 - Click the **Cancel** button to stop copying screens and return to the editing window.

2.5 Deleting Screens

- Deleting a screen
You can delete a single screen.

- 1 Right click the screen to delete in the **Project** window and click **Delete Screens**.
A delete confirmation message is displayed.

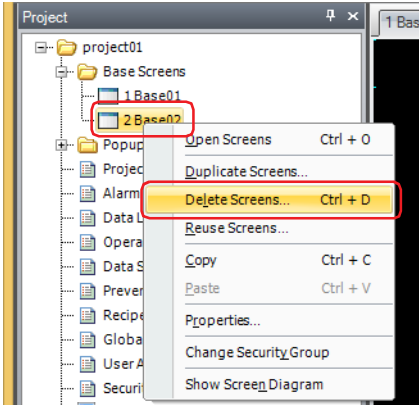

- 2 Click the **Yes** button.
The screen is deleted.
Click the **No** button to return to the editing window without deleting the screen.

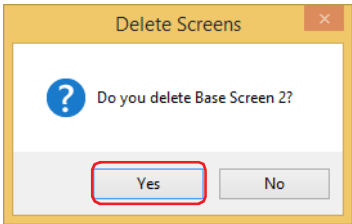

- Deleting specific screens
You can delete multiple screens as a group.

- 1 On the **Home** tab, in the **Screens** group, click **Delete**.
The **Delete Screens** dialog box is displayed.



If you right click a screen folder in the **Project** window and click **Delete Screens**, the **Delete Screens** dialog box is displayed.

- 2 Click the screens to delete in **Screen List** and click the **OK** button.

A delete confirmation message is displayed.



To select multiple screens, press and hold SHIFT or CTRL while you click the specific items.

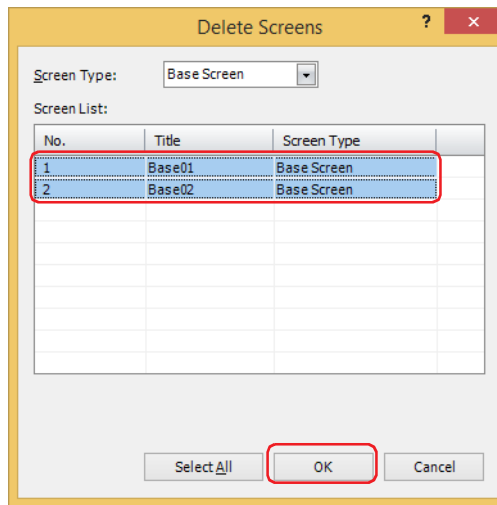

■ **Screen Type**

Select the type of screen to delete from the following items. The selected screen type is displayed in **Screen List**.

All, Base Screen, Popup Screen, Password Input Screen

■ **Screen List**

This list shows screens that have already been created.

■ **Select All button**

Selects all the screens displayed in **Screen List**.

- 3 Click the **Yes** button or the **Yes To All** button.

- Click the **Yes** button to delete the screen with the number displayed in the confirmation message. When deleting multiple screens, the next message to confirm deleting a screen is displayed.
- Click the **Yes To All** button to delete all the screens without displaying the confirmation message.
- Click the **No** button to display the next message to confirm deleting a screen without deleting the screen with the number displayed in the confirmation message. You will return to the editing window when finished confirming all the screens.
- Click the **Cancel** button to stop deleting screens and return to the editing window.

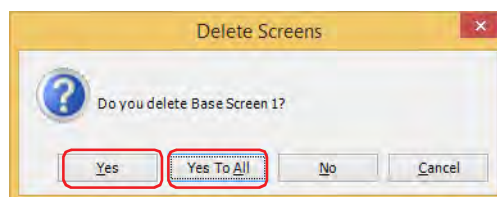

2.6 Reusing Screens

You can copy screens from other project data.



The Password Input Screen is reused only when the **Use Security functions** check box and the **Customize Password Input Screens** check boxes in the **Security** dialog box are selected. For details, refer to Chapter 23 "3 Security Dialog Box" on page 23-37.

- 1 On the **Home** tab, in the **Screens** group, click **Reuse**.

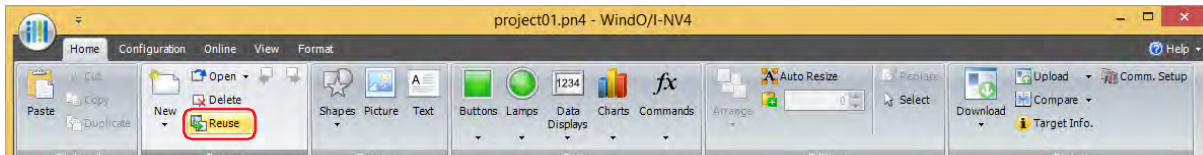

If you right click a screen folder or screen in the **Project** window and click **Reuse Screens**, the **Open** dialog box is displayed.

- 2 Select project data that includes the screens to copy and click **OK**.
The **Open** dialog box is displayed.

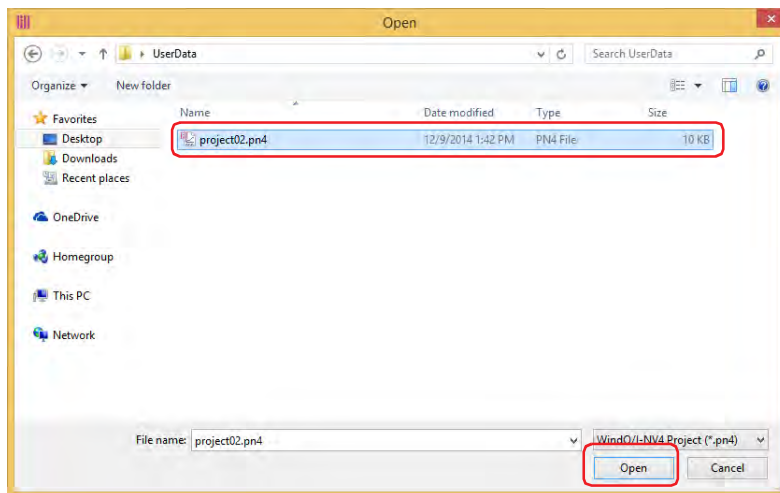

If a password has been configured for the project data, the Password Screen will be displayed. Enter the password for projects created with WindO/I-NV4 Ver. 1.11.4 or earlier using only 4 to 15 uppercase letters and numbers.

The password to enter varies based on the check box setting of the **Use Password to open a Project** found under the **Options** tab in the **Security** dialog box.

When this check box is checked, enter the password for **Use Password to open a Project**.

When this check box is unchecked, enter the password for the user account assigned to the Administrator security group.

For details, refer to Chapter 23 "User Accounts and the Security Function" on page 23-1.

- 3 Click the screens to copy in **Screen List** and click the **OK** button.



To select multiple screens, press and hold SHIFT or CTRL while you click the specific items.

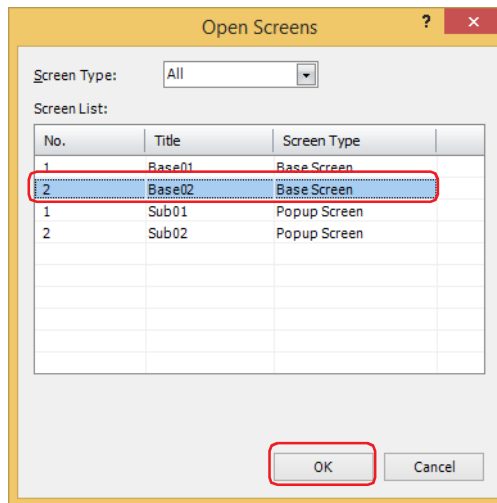

■ Screen Type

Select the type of screen to copy from the following items. The selected screen type is displayed in **Screen List**.

All, Base Screen, Popup Screen, Password Input Screen

■ Screen List

This list shows screens included in the source project data.



If the screen number of the screen to copy, a picture included in the screen, a text ID, or a script ID already exists in the project data being edited, an overwrite message is displayed.

- Click the **Yes** button to overwrite the item displayed in the confirmation message. If there are multiple redundant items, a confirmation message is displayed for each of those items.
- Click the **Yes To All** button to overwrite all of the picture numbers, pictures, text IDs, and script IDs.
- Click the **No** and a dialog box opens for each setting. Change the item to a unique screen number or ID and click the **OK** button.
- Click the **Cancel** button to stop overwriting the displayed in the confirmation message. If there are multiple redundant items, a confirmation message is displayed for each of those items.

2.7 Batch Editing of Multiple Screen Settings

You can modify the settings for multiple Base Screens, Popup Screens or Password Input Screens collectively.

- 1 Selects multiple screens of the same type on the **Project** window or in the **Screen List** window, right-click to open a popup menu, and then click **Properties**.
The **Screen Properties** dialog box is displayed.



To select multiple screens, press and hold SHIFT or CTRL while you click the specific items.

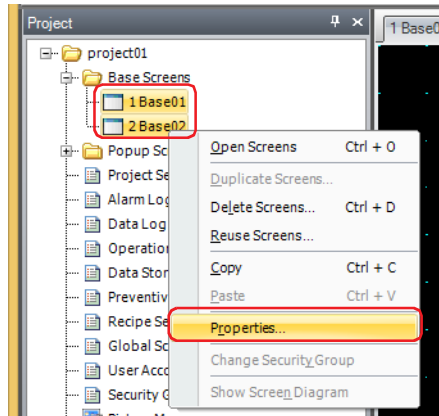

- 2 Configure only the items to modify collectively.

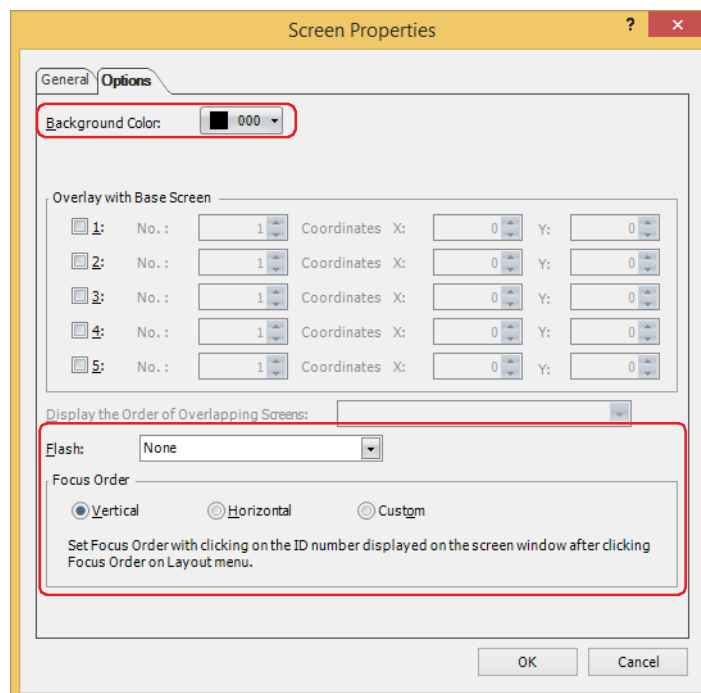

- 3 Click the **OK** button.

3 Base Screen

HG2J-7U HG5G-V HG4G-V HG4G HG3G-V HG3G HG2G-V HG2G-5F HG2G-5T HG1G HG1P

The screen that is displayed when the MICRO/I is in Run Mode. This screen places drawing objects and parts on the base and creates a screen that is displayed on the MICRO/I.

3.1 Properties of Base Screen Dialog Box

● General Tab

No.	Title	Screen Type
1	Base01	Base Screen

■ Screen Type

Select **Base Screen** as the screen type.

You can only select the screen type when creating a new screen.

■ Number

Enter the Base Screen's screen number (1 to 3000).

■ Title

Enter the Base Screen's title. Maximum number is 40 characters.

■ Size

Shows the screen size. You cannot change the size of Base Screens.

■ Screen List

This list shows screens that have already been created. It is only displayed when creating a new screen.

● Options Tab

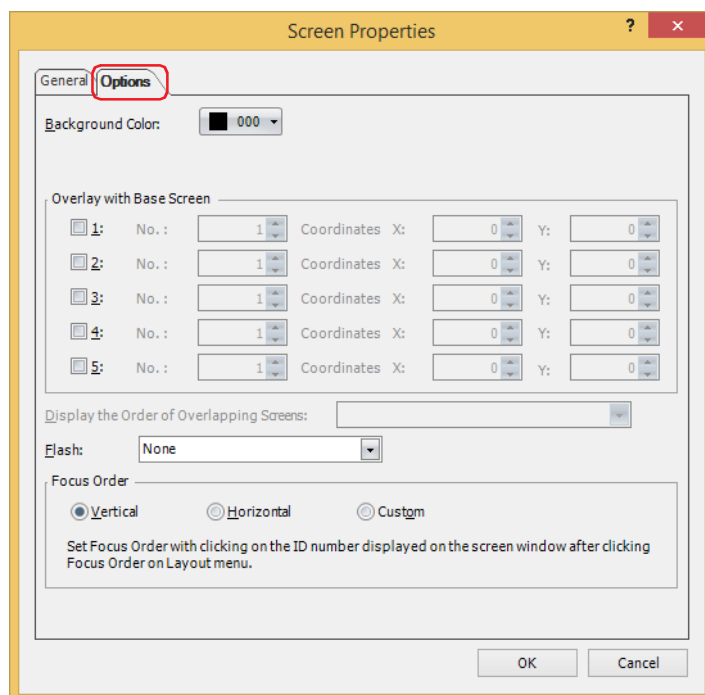

■ Background Color

Select the screen's background color (color: 256 colors, monochrome: 16 shades). Click this button to open the color palette. Select color with the color palette.



When **Overlay with Base Screen** is configured, the background color for the Base Screen specified as the background is displayed.

■ Overlay with Base Screen

Configure this section to display the Base Screen by overlaying screens.

- 1 to 5: Select these to display the Base Screen by overlaying screens.
- No.:
- Coordinates X, Y:
- Enter the overlay screen's screen number (1 to 3000).
- Specify the display location of the overlay screen in coordinates. The coordinates can be set in the range (Screen size - 1 dot).
The origin is the upper-left corner of the screen and the X- and Y-coordinates correspond to the upper-left corner of the overlay window.

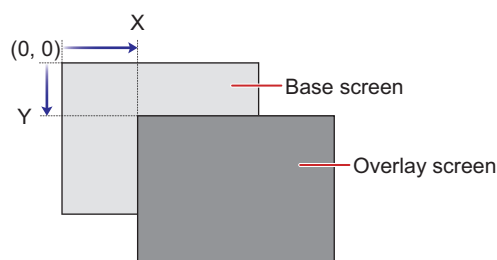

Display the Order of Overlapping Screens

You can select the display order of the Base Screen and the overlay screens.

Example: To display the Base Screen being edited as the background

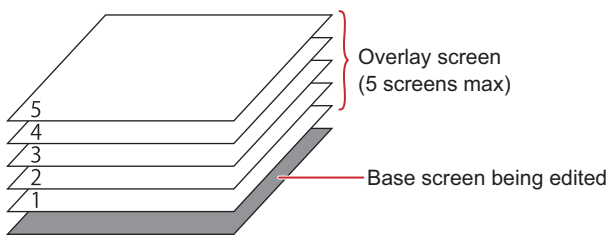

Example: To display the Base Screen being edited above overlay screen: 3

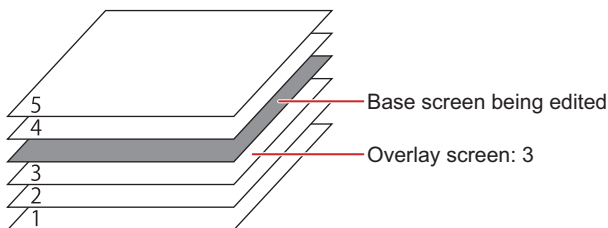

Flash

Select one of the following items as the setting when the screen is flashing.

- None: Displays the screen.
- Flash (1 sec cycle): The screen display is flashed in one second intervals.
- Flash (0.5 sec cycle): The screen display is flashed in half second intervals.
- Backlight OFF: Turns off the backlight until the screen is touched or until bit 0 or bit 7 is set to 1 in the system area 1's address number + 1.

Focus Order

Sets the focus order for Numerical Input and Character Input. The focus order is the order the focus moves between Numerical Input or Character Input when the user presses the **ENT** key. Text can be input in Numerical Input or Character Input that has focus. The focus order number starts from 0.

- Vertical: The focus moves vertically from top to bottom.
- Horizontal: The focus moves horizontally from left to right.
- Custom: Sets the desired order for moving the focus.
On the **View** tab, in the **Screens** group, click **Focus Order**, and then click the parts in the order to move the focus.



The focus moves in the following order when Numerical Input and Character Input on the screen is not aligned to the left or top.

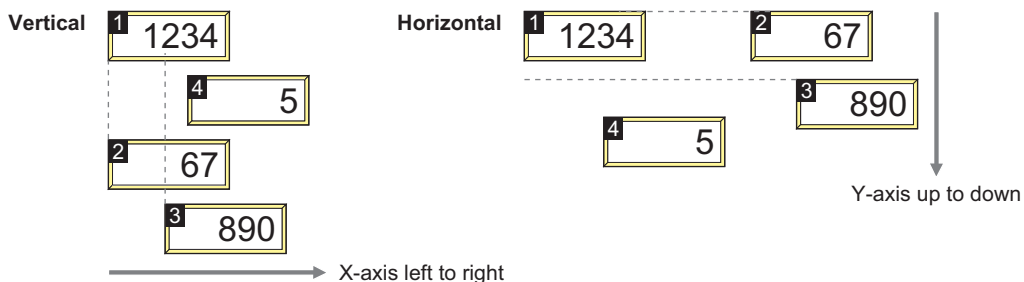

● Security Tab

This tab is used to restrict displaying the screen by security groups.

This option can only be set when **Use Security functions** is selected. The **Use Security functions** check box is set on **General** tab in the **Security** dialog box.

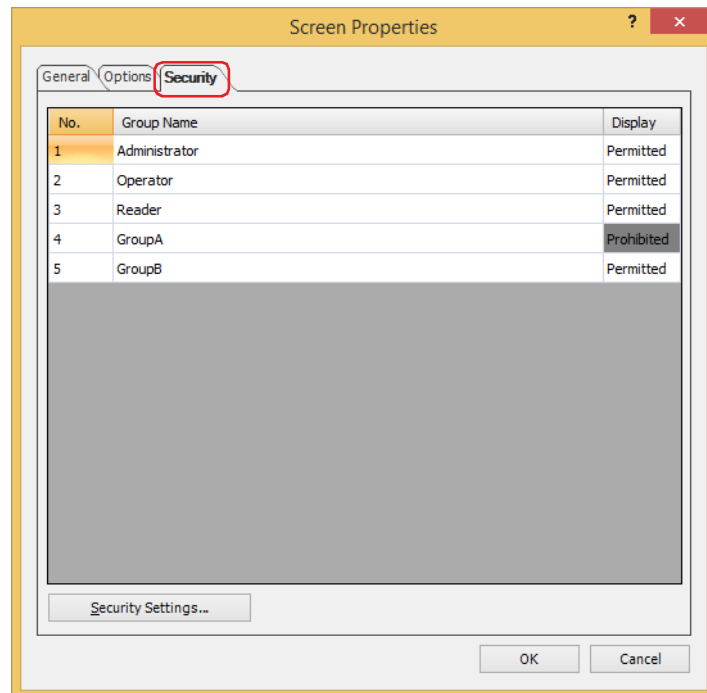

■ (Settings)

Displays the list of security groups used on the MICRO/I.

No.:	Displays the security group numbers (1 to 15).
Group Name:	Displays the name of the security group.
Display:	Displays whether or not there is permission to display the screen. Only Permitted security groups can open this screen. Double clicking the cell switches between Permitted and Prohibited .



You can also switch between **Permitted** and **Prohibited** from the right-click menu on a **Display** cell.

■ Security Settings

The **Security Settings** dialog box is displayed. If you create a security group in the **Security Settings** dialog box, you can select that created group. For details, refer to Chapter 23 "2.2 Adding and Editing Security Groups" on page 23-19.



For details about the security function, refer to Chapter 23 "User Accounts and the Security Function" on page 23-1.

3.2 Displaying Layered Base Screens

It is possible to layer and display multiple Base Screens. The coordinates and display order for layered screens can be set on the screen that will serve as the base. A maximum of 5 layered screens can be displayed.

■ **Coordinates**

Using the upper-left corner of the screen as the origin, the upper-left area of the layered screen become the X and Y coordinates.

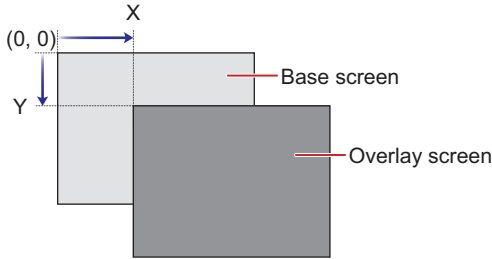

■ **Display Order**

This allows you to select the order of display for the screen that will serve as the base and layered screens.

Example: Displaying a Base Screen that is currently being edited as the bottom most layer

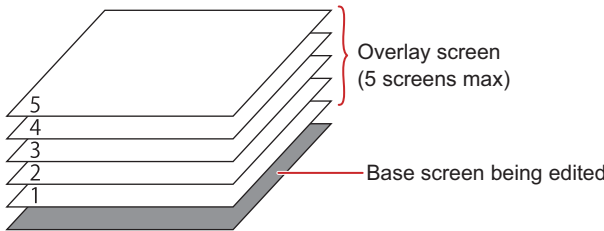

Example: Displaying a Base Screen currently being edited on the layered screen: 3.

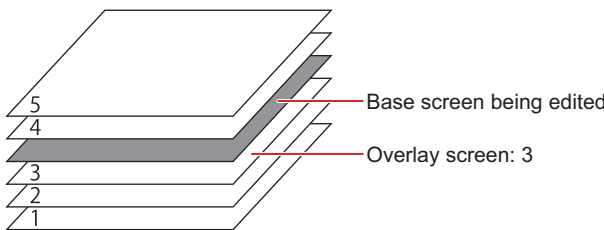

For details about how to configure these settings, refer to "3.1 Properties of Base Screen Dialog Box" on page 5-14.

Example: When Base Screen: 100 which has a clock placed in it, is used as a layered screen, Base Screen:1 which is displayed as the base and Base Screen: 2 will be displayed as follows:

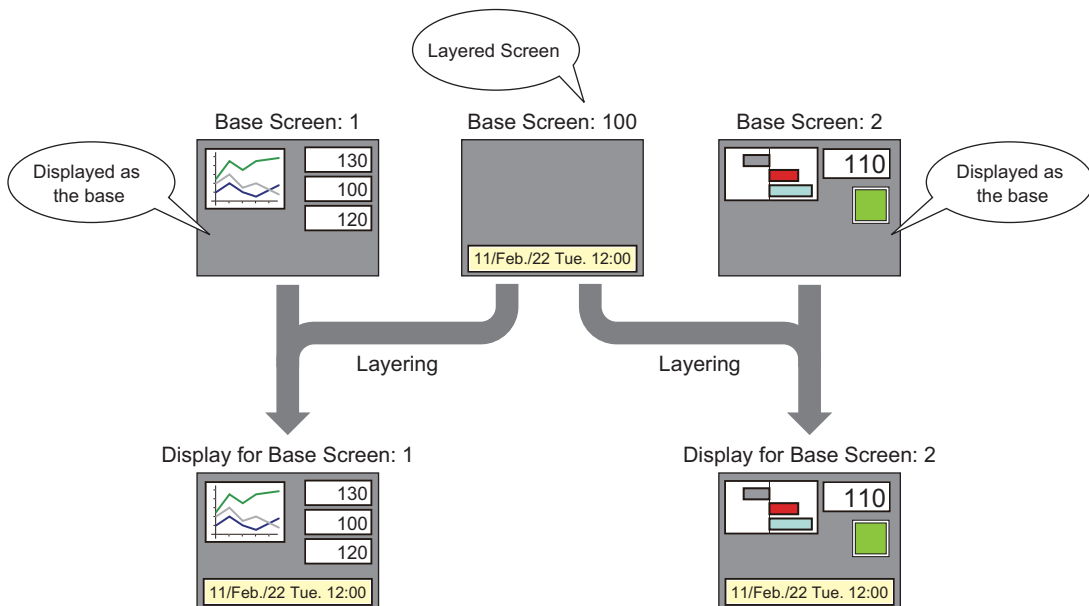



- Layered screens that have been set as layered screens will not be displayed on the screen that is displayed as the base.

Example: Layering and displaying Base Screen: 100 on Base Screen: 1
 Layering and displaying Base Screen: 101 on Base Screen: 100

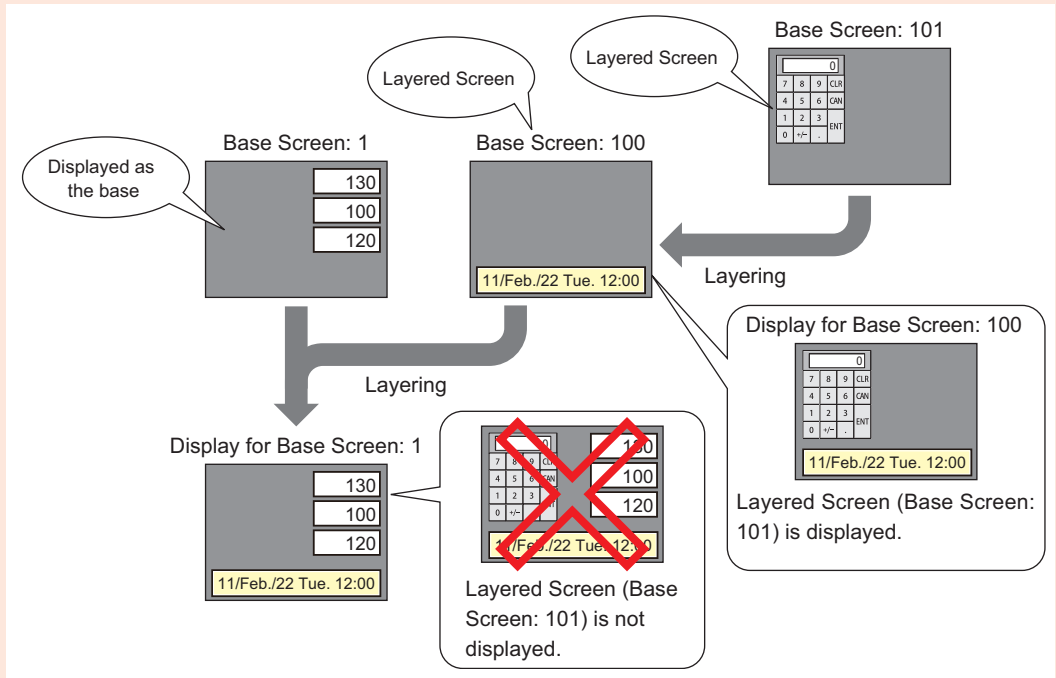

- Drawing objects and parts from layered screens may not display properly when placed outside of the display area.

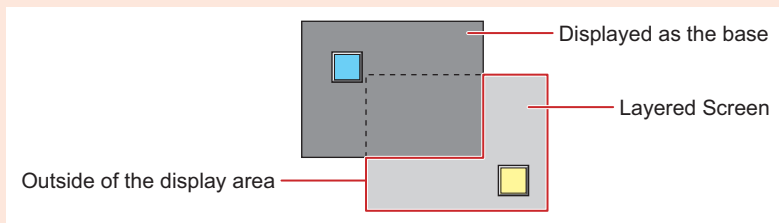

When layering and displaying base screens that have drawings and parts placed on the top layer, they are displayed in order of each top layer in front of each base screen.

Example: When layering Base Screen 2 on the of Base Screen 1

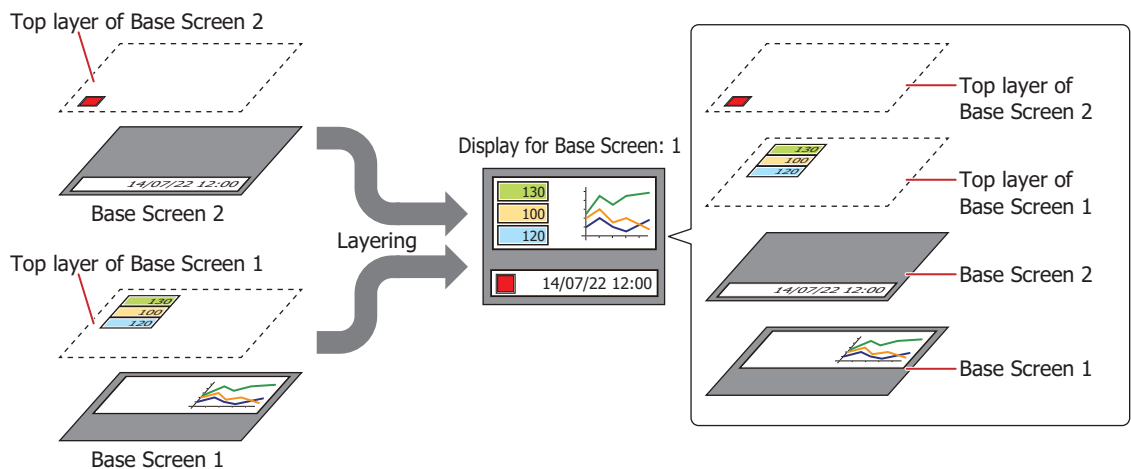

For displaying of drawings and parts placed on the top layer, refer to Chapter 6 "4 Drawings and Parts Overlapping" on page 6-5.

4 Popup Screen

HG2J-7U HG5G-V HG4G-V HG4G HG3G-V HG3G HG2G-V HG2G-5F HG2G-5T HG1G HG1P

The Popup Screen that is displayed on the Base Screen when the MICRO/I is in Run Mode. The size and coordinates of the screen can be specified and this screen can also be moved on the Base Screen.

4.1 Properties of Popup Screen Dialog Box

● General Tab

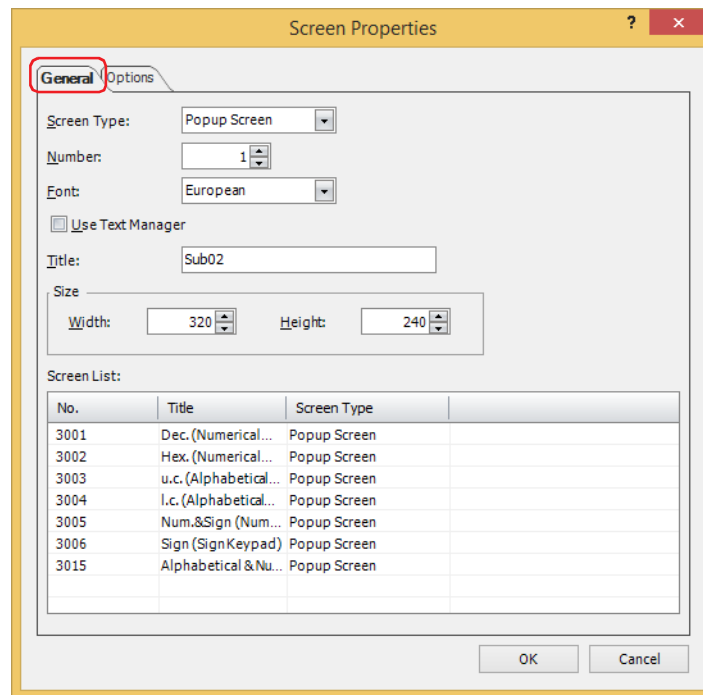

■ Screen Type

Select **Popup Screen** for the screen type.

You can only select the screen type when creating a new screen.

■ Number

Enter the Popup Screen's screen number (1 to 3015).

However, screen numbers 3001 to 3015 are Popup Screens for standard Keypads for Numerical Input and Character Input.

■ Font

Select the font to use for the title from the following items:

Western, Japanese, Simplified Chinese, Traditional Chinese, Hangul, Central European, Baltic, Cyrillic

This option can only be selected when **Use Text Manager** is cleared.

■ Use Text Manager

Select this to use text registered in the Text Manager for the screen title.

However, the text color is white, not the color set in the Text Manager.



If the characters displayed in the title contain a newline, the text after the newline will not be displayed. However, if using a Windows font for the selected text ID, the text after the newline will still be displayed.

■ Text ID

Specify the Text Manager ID number (1 to 32000) to use text registered in the Text Manager. Click  to display the Text Manager.

This option can only be set when **Use Text Manager** is selected.

■ Title

Enter the Popup Screen's title. Maximum number is 40 characters. This title is displayed in the Popup Screen's title bar. This option can only be entered when **Use Text Manager** is cleared.

■ Size

Width, Height: Specify the width (40 dots to Base Screen width) and the height (40 dots to Base Screen height) of the Popup Screen.

■ Screen List

This list shows screens that have already been created. It is only displayed when creating a new screen.

● Options Tab

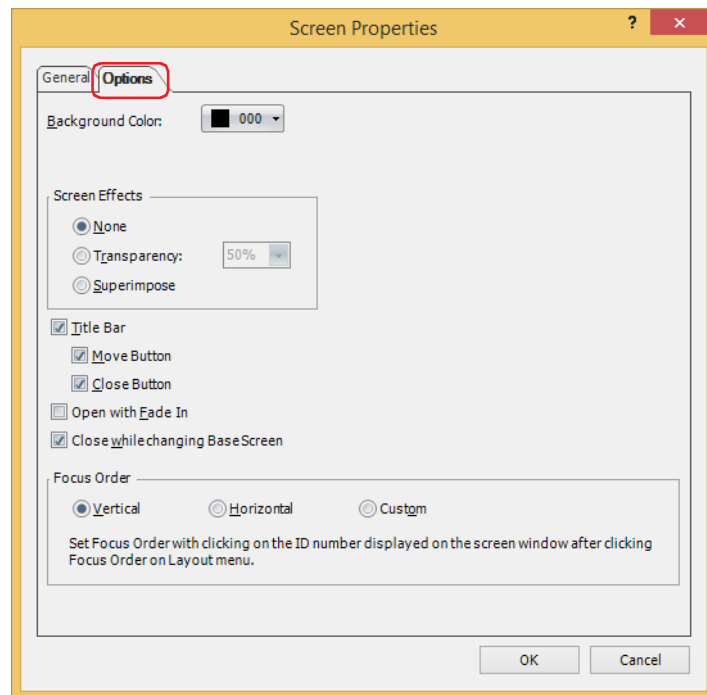

■ Background Color

Select the screen's background color (color: 256 colors, monochrome: 16 shades). Click this button to open the color palette. Select the color with the color palette.

■ Screen Effects

None: Displays the Popup Screen's background with the color specified in **Background Color**.

Transparency: Displays the Popup Screen's background as transparent. The amount of transparency can be selected from **10%** to **90%** in 10% increments.

Superimpose: Displays the Popup Screen's background as completely transparent. The screen underneath the Popup Screen can be seen.



For the Popup Screen set to **Superimpose** as **Screen Effects**, note the following points:

- Magenta (R:255, G:4, B:255) is treated as a transparent color. If you place pictures on the Popup Screen set to superimpose that use this color, those areas are completely transparent.
- The buttons underneath the Popup Screen are active.
- When you place the following objects, the text is displayed with a color mixed with magenta. If the text color causes a problem, set the Background Color of the text or change it to a Windows font.
 - Text with **Background Color** set to **None**
 - Parts with **Image Type** set to **None**
 - Parts for which **Not Display Image** is selected
 - Parts using the pictures with the background of the texts replaced with a **Transparent Color**

■ Title Bar

Select this to display the title bar on the Popup Screen. The text set in **Title** on the **General** tab is displayed in the title bar.

The title bar is not displayed if superimpose is set.

Move Button: Select this to display the  (Move) button on the title bar.

Close Button: Select this to display the  (Close) button on the title bar.

■ Open with Fade In

When opening a Popup Screen, select this to gradually fade in the popup screen from nothing to the transparency specified in **Transparency**.

■ Close while changing Base Screen

Select this to close the displayed popup screen when changing the Base Screen.

■ Focus Order

Sets the focus order for Numerical Input and Character Input. The focus order is the order the focus moves between Numerical Input or Character Input when the user presses the **ENT** key. Text can be input in Numerical Input or Character Input that has focus. The focus order number starts from 0.

Vertical: The focus moves vertically from top to bottom.

Horizontal: The focus moves horizontally from left to right.

Custom: Sets the desired order for moving the focus.

On the **View** tab, in the **Screens** group, click **Focus Order**, and then click the parts in the order to move the focus.



The focus moves in the following order when Numerical Input and Character Input on the screen is not aligned to the left or top.

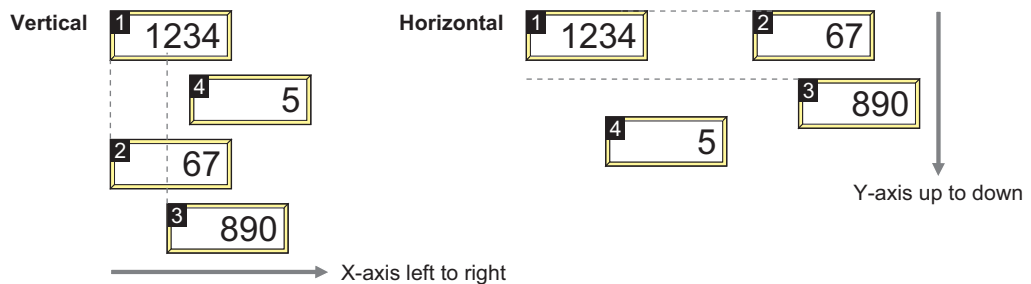

● Security Tab

This tab is used to restrict displaying the screen by security groups.

This option can only be set when **Use Security functions** is selected. The **Use Security functions** check box is set on **General** tab in the **Security** dialog box.

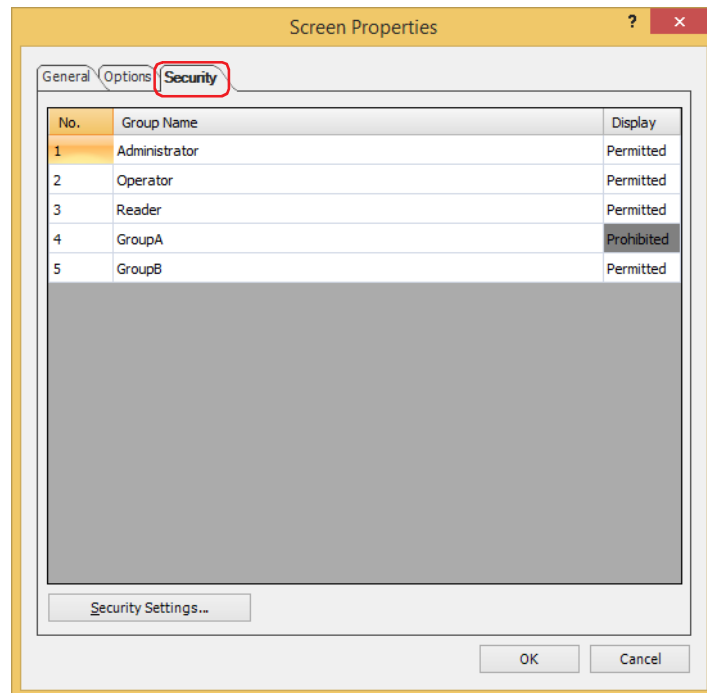

■ (Settings)

Displays the list of security groups used on the MICRO/I.

No.:	Displays the security group numbers (1 to 15).
Group Name:	Displays the name of the security group.
Display:	Displays whether or not there is permission to display the screen. Only Permitted security groups can open this screen. Double clicking the cell switches between Permitted and Prohibited .



You can also switch between **Permitted** and **Prohibited** from the right-click menu on a **Display** cell.

■ Security Settings

The **Security Settings** dialog box is displayed. If you create a security group in the **Security Settings** dialog box, you can select that created group. For details, refer to Chapter 23 "2.2 Adding and Editing Security Groups" on page 23-19.



For details about the security function, refer to Chapter 23 "User Accounts and the Security Function" on page 23-1.

4.2 Popup Screen Configuration

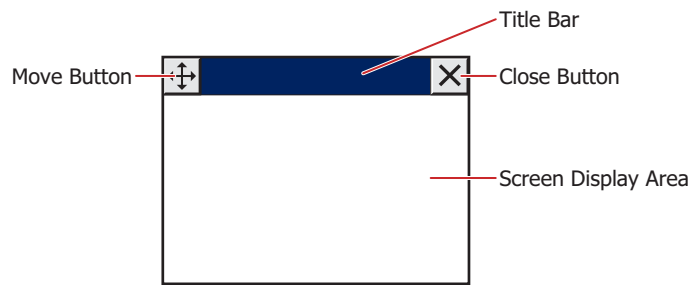

■ Title Bar

Displays buttons and the title of the Popup Screen.

Pressing the title bar of the screen allows you to move the screen to the front.

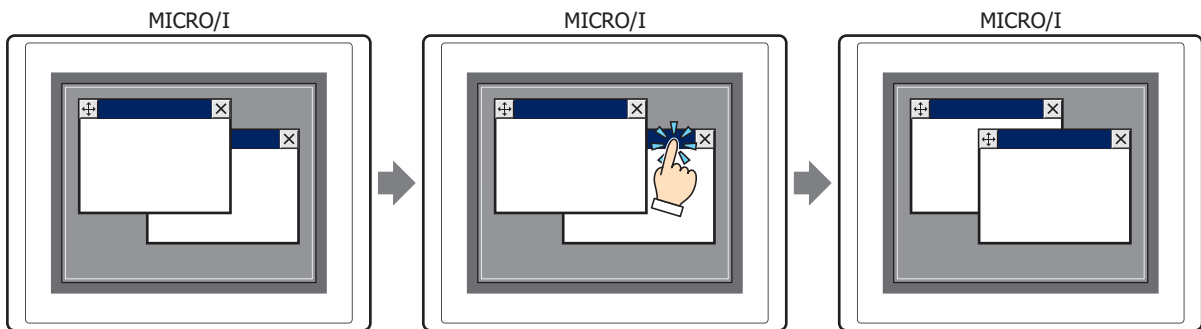

When there is a title bar on the popup screen, touch switches that are within 20 dots of the title bar will not respond.

■ (Move) Button

Moves the Popup Screen.

1 Press 

2 Touch the position where the screen will be moved to

3 The screen will move the position that was touched

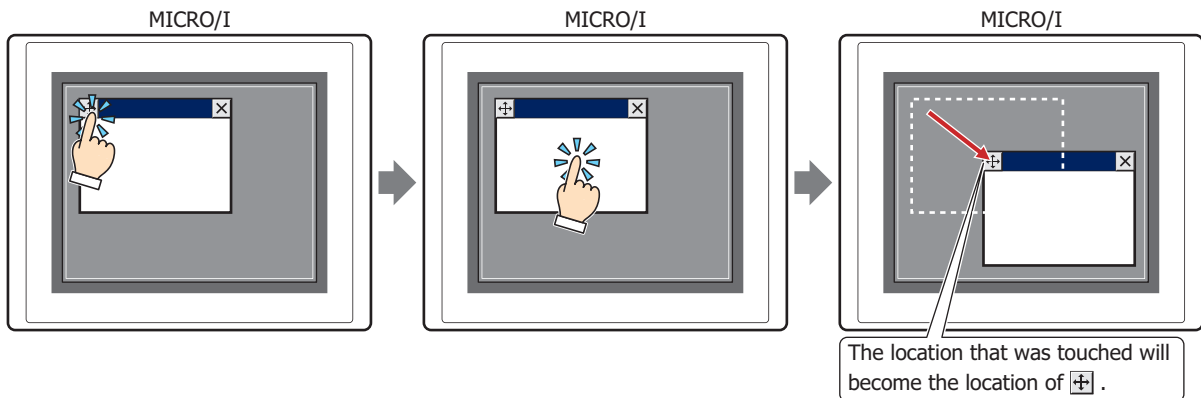

The location that was touched will become the location of .



- The Popup Screen can be moved in the range where the  button can be displayed.

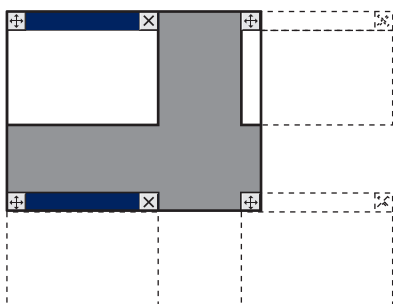

- The Popup Screen will be moved in units of 1 dot.

-  **(Close) Button**
Closes the Popup Screen.

- **Screen Display Area**
The area where drawing objects and parts are placed.

4.3 Standard Keypad Popup Screen

A Popup Screen that places a regular Keypad used for Numerical Input, Character Input, inputting for E-mail and clock settings on screen numbers 3001 to 3015 with the WindO/I-NV4.

Example: HG5G/4G/3G/2G-V

Decimal (Number Value) Keypad

1234567890			
7	8	9	CLR
4	5	6	CAN
1	2	3	ENT
0	+/-	.	

Uppercase (Alphabet) Keypad

ABCDEFGHIJKLMNOPQRSTUVWXYZ							
Lower case	A	B	C	D	E	F	BS
	G	H	I	J	K	L	CLR
	M	N	O	P	Q	R	CAN
Num& Sign	S	T	U	V	W	X	ENT
	Y	Z	SP		<Cur.	Cur.>	



- The Keypad Popup Screen will differ depending on the model selected.
- The Keypad Popup Screen can also place drawing objects and parts in the same manner as Popup Screen numbers 1 to 3000.
- Screen numbers 3001 to 3015 are screen numbers that are empty when a new project has been created and are handled as normal Popup Screens.
- Deleting a Keypad Popup Screen and recreating a new Popup Screen of the same screen number will place the same Keypad.

5 Password Input Screen

HG2J-7U HG5G-V HG4G-V HG4G HG3G-V HG3G HG2G-V HG2G-5F HG2G-5T HG1G HG1P

The Password Input Screen is used to enter the user name and password required for switching user accounts when the MICRO/I is in Run Mode. The size and coordinates of the screen can be specified and this screen can also be moved on the Base Screen. This screen can only be created when the **Use Security functions** check box and the **Customize Password Input Screens** check box in the **Security** dialog box are selected. If you are using the Password Input Screen provided by MICRO/I, you do not need to create the screen. For details, refer to Chapter 23 "4.1 Entering the Password on the MICRO/I" on page 23-47.

5.1 Properties of Password Input Screen Dialog Box

● General Tab

■ Screen Type

Select **Password Input Screen** for the screen type.

You can only select the screen type when creating a new screen.

■ Number

Enter the screen number (3026 to 3033) of the Password Input Screen.

■ Font

Select the font to use for the title from the following items:

Western, Japanese, Simplified Chinese, Traditional Chinese, Hangul, Central European, Baltic, Cyrillic

This option can only be selected when **Use Text Manager** is cleared.

■ Use Text Manager

Select this to use text registered in the Text Manager for the screen title.

However, the text color is white, not the color set in the Text Manager.

■ Text ID

Specify the Text Manager ID number (1 to 32000) to use text registered in the Text Manager. Click  to display the Text Manager.

This option can only be set when **Use Text Manager** is selected.

■ Title

Enter the Password Input Screen's title. Maximum number is 40 characters. This title is displayed in the Password Input Screen's title bar.

This option can only be entered when **Use Text Manager** is cleared.

■ Size

Width, Height: Specify the width (40 dots to Base Screen width) and the height (40 dots to Base Screen height) of the Password Input Screen.

■ Screen List

This list shows screens that have already been created. It is only displayed when creating a new screen.

● Options Tab

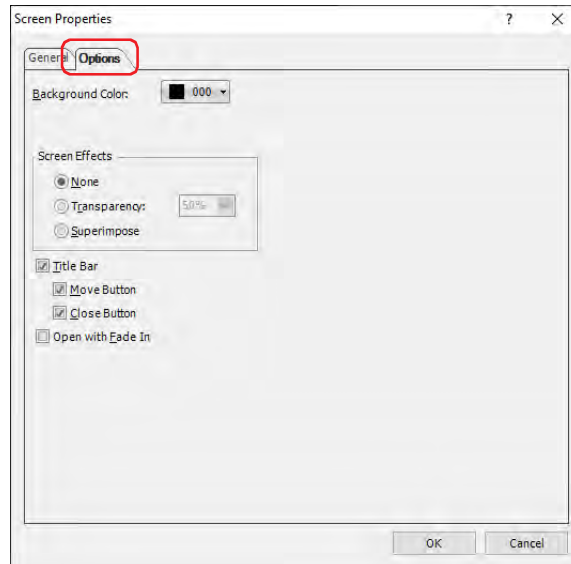

■ Background Color

Select the screen's background color (color: 256 colors, monochrome: 16 shades). Click this button to open the color palette. Select the color with the color palette.

■ Screen Effects

None: Displays the Password Input Screen's background with the color specified in **Background Color**.

Transparency: Displays the Password Input Screen's background as transparent. The amount of transparency can be selected from **10%** to **90%** in 10% increments.

Superimpose: Displays the Password Input Screen's background as completely transparent. The screen underneath the Password Input Screen can be seen.



For the password input screen set to **Superimpose** as **Screen Effects**, note the following points:

- Magenta (R:255, G:4, B:255) is treated as a transparent color. If you place pictures on the Popup Screen set to superimpose that use this color, those areas are completely transparent.
- The buttons underneath the Popup Screen are active.
- When you place the following objects, the text is displayed with a color mixed with magenta. If the text color causes a problem, set the Background Color of the text or change it to a Windows font.
 - Text with **Background Color** set to **None**
 - Parts with **Image Type** set to **None**
 - Parts for which **Not Display Image** is selected
 - Parts using the pictures with the background of the texts replaced with a **Transparent Color**

■ Title Bar

Select this to display the title bar on the Password Input Screen. The text set in **Title** on the **General** tab is displayed in the title bar.

The title bar is not displayed if superimpose is set.

Move Button: Select this to display the  (Move) button on the title bar.

Close Button: Select this to display the  (Close) button on the title bar.

■ Open with Fade In

When opening a Password Input Screen, select this to gradually fade in the Password Input Screen from nothing to the transparency specified in **Transparency**.

5.2 Password Input Screen Configuration

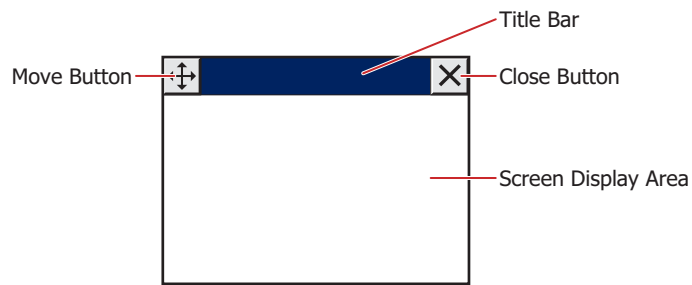

■ Title Bar

Displays buttons and the title of the Password Input Screen.



When there is a title bar on the Password Input Screen, touch switches that are within 20 dots of the title bar will not respond.

■ (Move) Button

Moves the Password Input Screen.

1 Press 

2 Touch the position where the screen will be moved to

3 The screen will move the position that was touched

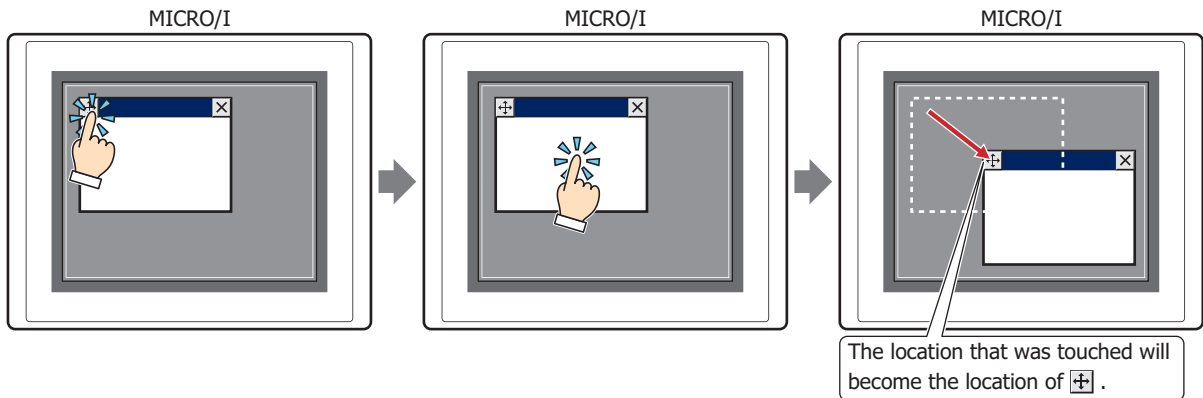

- The Password Input Screen can be moved in the range where the  button can be displayed.

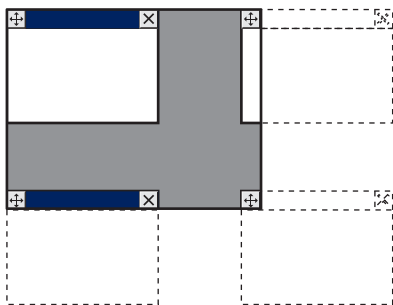

- The Password Input Screen will be moved in units of 1 dot.

■ (Close) Button

Closes the Password Input Screen.

■ Screen Display Area

The area where drawing objects and parts are placed.

5.3 Standard Password Input Screen

WindO/I-NV4 provides standard Password Input Screens for screen numbers 3026 to 3028.

Example: HG5G/4G/3G/2G-V

Upper Case (Alphanumerical)

ABCDEFGHIJKLMN											↑	↓
ABCDEFGHIJKLMN												
1	2	3	4	5	6	7	8	9	0	BS		
Q	W	E	R	T	Y	U	I	O	P	CLR		
123 abc	A	S	D	F	G	H	J	K	L	CAN		
!/?#	Z	X	C	V	B	N	M	ENT				

Lower Case (Alphanumerical)

ABCDEFGHIJKLMN											↑	↓
ABCDEFGHIJKLMN												
1	2	3	4	5	6	7	8	9	0	BS		
q	w	e	r	t	y	u	i	o	p	CLR		
123 abc	a	s	d	f	g	h	j	k	l	CAN		
!/?#	z	x	c	v	b	n	m	ENT				

Sign

ABCDEFGHIJKLMN											↑	↓
ABCDEFGHIJKLMN												
@	#	\$	_	&	-	+	()	/	BS		
*	"	'	:	;	!	?	,	.	~	CLR		
123 ABC	`		^	=	{	}	¥	<	>	CAN		
123 abc	%	[]	ENT								



- The Standard Password Input Screen varies based on the model selected.
- Deleting a Standard Password Input Screen and recreating a new Password Input Screen of the same screen number will place the same keypad.

6 Screen Restrictions

HG2J-7U HG5G-V HG4G-V HG4G HG3G-V HG3G HG2G-V HG2G-5F HG2G-5T HG1G HG1P

6.1 Screen Number

The number of screens and layered screens that can be created in a single project and the number of Popup Screens and Password Input Screens that can be displayed on the Base Screen are as follows:

■ Base Screen

Item	Number of screens
Number of screens that can be created	3,000 max.
Number of layered screens	5 max.

■ Popup Screen

Item	Number of screens
Number of screens that can be created	3,015 max.
Number of screens that can be displayed on the Base Screen	3 max. (Password Input Screen, Including the Device Monitor ^{*1})

■ Password Input Screen

Item	Number of screens
Number of screens that can be created	8 max.
Number of screens that can be displayed on the Base Screen	1 max.

6.2 Maximum Number of Parts

■ Number of Parts That Can be Placed on a Single Screen

Screen	Number of Parts
Base Screen	960 max.
Popup Screen	960 max.
Password Input Screen	960 max.

■ Number of Parts That Can be Displayed on a Single Screen

In addition to the currently displayed Base Screen, this includes layered screens and currently displayed Popup Screens and Password Input Screens.

Parts	Number of Parts
Potentiometer	32 max.
Numerical Input	256 max.
Character Input	256 max.
Numerical Inputs and Character Inputs in a constant state of input	Limit to 1. Either one but can't be both.
Video Display	1 max.
Alarm List Display, Alarm Log Display	Limit to 1. Either one but can't be both.
Data Log Display	1 max.

*1 The maintenance screen is not included.

6.3 Maximum Number of External Device Addresses

The maximum number of Read/Write device addresses of external devices is 512 for base screens (including overlay screens) and popup screens.



If the same device address is used in multiple device address settings, the used number of device addresses will be counted as 1 device address. It will not be counted as 1 point per device address setting.

6.4 Text and Messages

Follow the rules below, otherwise text and messages on the MICRO/I may not be displayed or may be partially missing.

Popup screen title, Password Input Screen title:	Make shorter than the title bar
Text on drawings:	Make smaller than the text area
Text and messages used in parts:	Make smaller than the size of the parts

6.5 Vertical Installation

Even if you choose for them to be installed and displayed vertically, the screens in the System Mode will be the same as horizontal installation and display.

Chapter 6 Drawings and Parts

This chapter contains an overview of drawings and parts that are used when creating a screen and a description of the types of drawings and parts, and the Part Library function.

1 Overview

HG2J-7U HG5G-V HG4G-V HG4G HG3G-V HG3G HG2G-V HG2G-5F HG2G-5T HG1G HG1P

Drawings and parts can be used by placing them on base screens and popup screens. The parts library is a function to register and reuse objects placed on the screen.

Drawings include objects such as straight lines, polygons, circles, pictures, and static text.

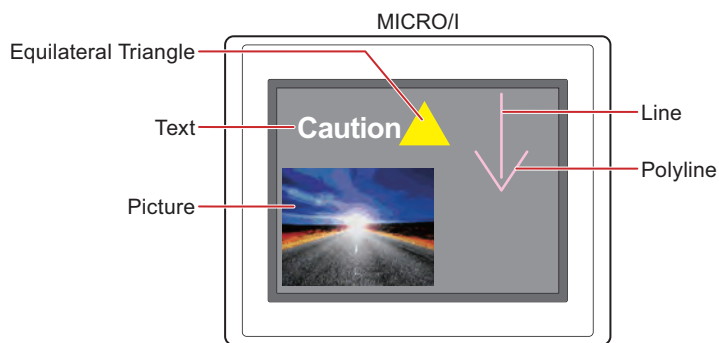

Parts are objects that generate a variety of events when triggered by a change in values of device addresses or by touch.

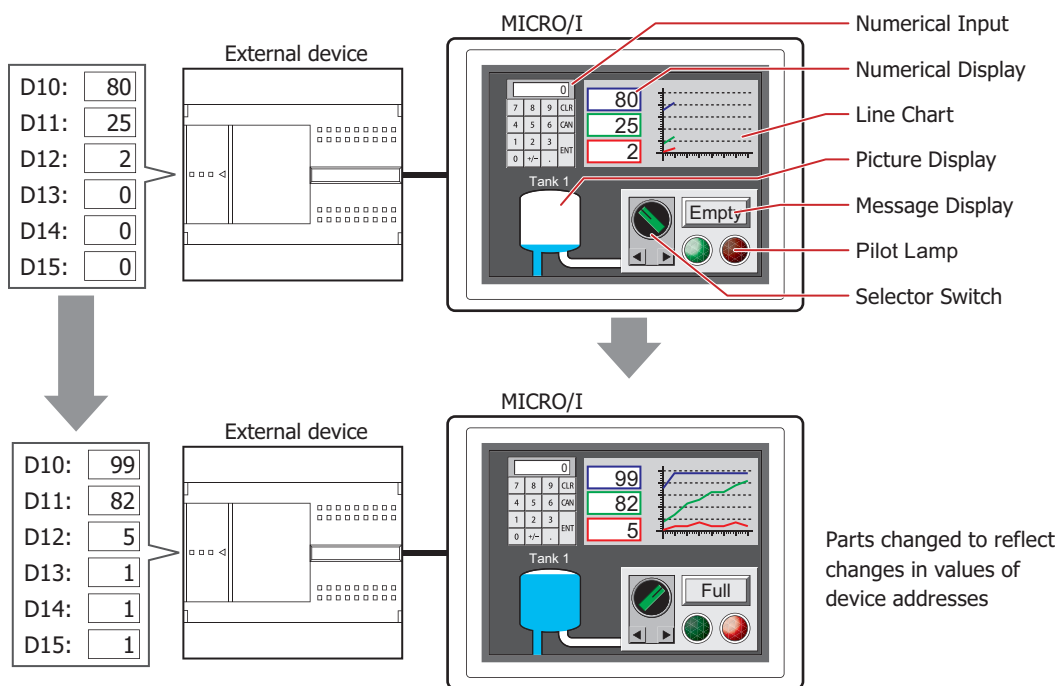

2 Drawing objects

HG2J-7U HG5G-V HG4G-V HG4G HG3G-V HG3G HG2G-V HG2G-5F HG2G-5T HG1G HG1P

This section describes the drawing objects that can be drawn in WindO/I-NV4.

2.1 Shapes

Shapes		Function
Basic Shapes	Line	Draws a line.
	Polyline	Draws a polyline.
	Polygon	Draws an object that connects two or more vertices with straight lines.
	Rectangle	Draws a rectangle.
	Circle/Ellipse	Draws a circle or ellipse.
	Arc	Draws an elliptical arc.
	Pie	Draws a pie.
Equilateral Polygon		Draws an equilateral polygon. (triangle, diamond, pentagon, hexagon, or octagon)
Paint* ¹		Paints the closed region of the drawing object.

2.2 Picture

Loads drawing objects that are registered in the Picture Manager onto the edit screen.

2.3 Text

Draws text. The maximum number is 3,750 characters.

Loads text that is registered in the Text Manager.

*1 HG5G/4G/3G/2G-V, HG4G/3G, HG2G-5F/-5T, HG1G/1P only

3 Part Types

HG2J-7U HG5G-V HG4G-V HG4G HG3G-V HG3G HG2G-V HG2G-5F HG2G-5T HG1G HG1P

This section describes the parts that can be used on the MICRO/I.

3.1 Buttons

Part	Description
Bit Button	Writes a 0 or 1 to a bit device.
Word Button	Writes a value to a word device. Can be used to indirectly specify the destination address number or to perform operations on the written value.
Goto Screen Button	Switches to another screen or displays a window.
Print Button	Outputs a screenshot to a printer or external memory devices.
Key Button	Performs a variety of functions including uploading and downloading, copying files, and operating other parts.
Multi-Button	Executes multiple commands at once.
Keypad	A part comprised of Key Buttons. Enters numbers and characters into numerical or character input parts.
Selector Switch*1	Writes a 0 or 1 to a bit device. This is an exclusive control that only writes a single value as 1 and all other values as 0.
Potentiometer*1	Writes a value selected by pressing a slider button to a word device.

3.2 Lamps

Part	Description
Pilot Lamp	Displays images. Switches the displayed image according to the value of a bit device.
Multi-State Lamp	Displays images. Switches the displayed image according to the value of a word device.

3.3 Data Displays

Part	Description
Numerical Input	Uses either a Keypad or Key Button to write entered numbers.
Character Input	Uses either a Keypad or Key Button to write the character code for entered characters.
Picture Display	Displays images. Switches, moves or enlarges/reduces the displayed image according to the value of a device address, the bit status within a word device or at a fixed period.
Video Display*2	Displays images and plays movie files.
Message Display	Loads fixed text strings and word device values as character codes and displays them on the screen.
Message Switching Display	Switches the displayed fixed text string according to the value of a word device or the bit status within a word device.
Alarm List Display	Switches the displayed fixed text string according to the value of a device address. Can display alarms and multiple fixed text strings.
Alarm Log Display	Displays the alarm log stored in the internal memory of the MICRO/I.
Data Log Display	Displays the data log stored in the internal memory of the MICRO/I or the external memory device.
Numerical Display	Displays the numerical in the specified format.
Calendar	Displays the date and time using the MICRO/I's calendar data.

*1 HG5G/4G/3G/2G-V, HG4G/3G, HG2G-5F/-5T, HG1G/1P only

*2 This is applicable for models with a video interface only.

3.4 Charts

Part	Description
Bar Chart	Displays values of word devices in a Bar Chart.
Line Chart	Displays data logs and values of word devices in a Line Chart.
Pie Chart	Displays values of word devices in a Pie Chart.
Meter	Displays a value of a word device using a needle gauge.

3.5 Commands

Part	Description
Bit Write Command	Writes a 0 or 1 to a bit device when certain trigger conditions are satisfied.
Word Write Command	Writes a value to a word device when certain trigger conditions are satisfied. Can be used to indirectly specify the destination address number or to perform operations on the written value.
Goto Screen Command	Switches to another screen or displays a window when certain trigger conditions are satisfied.
Print Command	Outputs a screenshot to a printer or external memory devices when certain trigger conditions are satisfied.
Script Command	Executes a script when certain trigger conditions are satisfied.
Multi-Command	Executes multiple commands at once when certain trigger conditions are satisfied.
Timer	Starts a countdown when certain trigger conditions are satisfied, and writes 1 to an internal device (HMI Timer Relay LTC) after the set time has elapsed.

4 Drawings and Parts Overlapping

HG2J-7U HG5G-V HG4G-V HG4G HG3G-V HG3G HG2G-V HG2G-5F HG2G-5T HG1G HG1P

This section describes when drawing and parts overlap.

4.1 Overview

Place the drawings and parts on the top layer to have precedence when these objects overlap on base screens and popup screens.

Configure the **Properties** dialog box of the drawings or parts if they need to be placed on the top layer. For details, refer to the settings for the drawings or part.

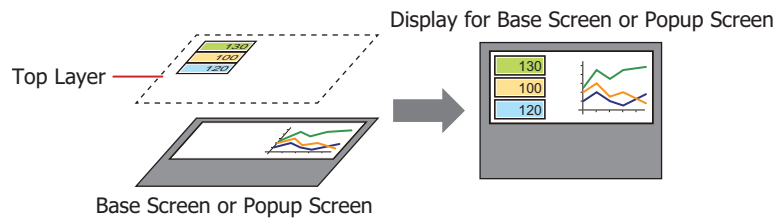

Select behind objects

To select an object that is under other objects, press and hold CTRL while you click the stacked objects. To select an object that is the front of the stacks, press and hold CTRL while you click the selected object that is the back.

4.2 Displaying Overlapping Drawings and Parts

The display when drawings and parts overlap on base screens and popup screens varies based on the location where they are placed.

● Display order of overlapping parts

- If two parts overlap on a base screen or popup screen, the part last modified is displayed in the front.
Example: A Numerical Display is placed on the base screen and a Bit Button is placed in front of it.

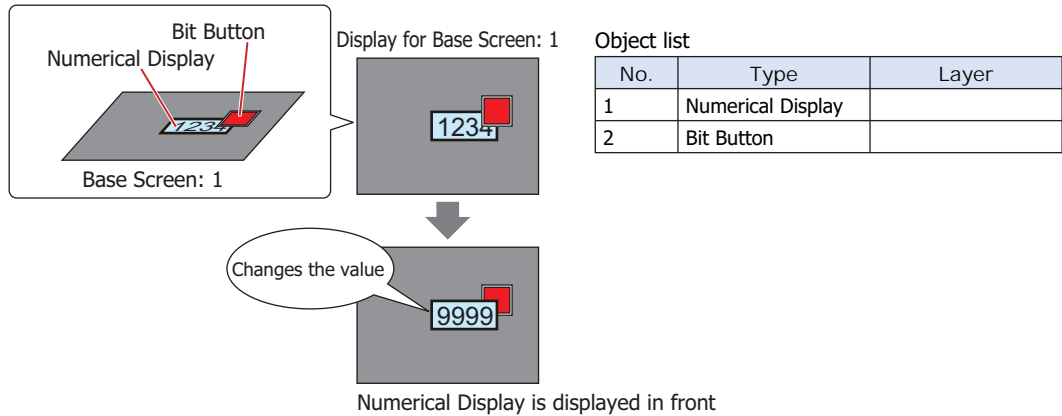

- If two parts are overlapping each other on a base screen or popup screen, the part which is configured in the Properties dialog box as a top layer, will keep displaying in the front.
Example: A Numerical Display is placed on the base screen and a Bit Button is placed on the top layer.

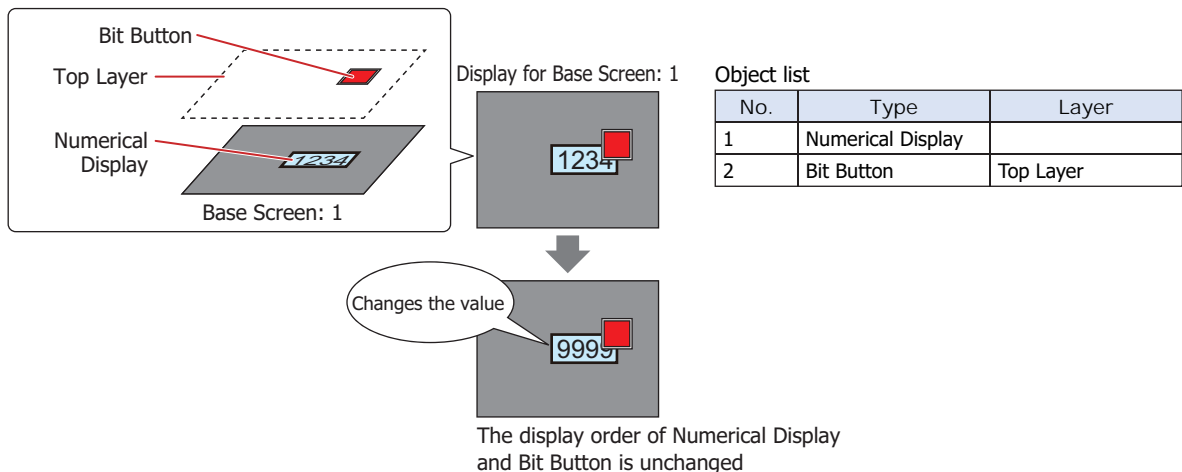

- If parts placed on the top layer overlap, the display order of the parts does not change.
Example: A Numerical Display is placed on the top layer and a Bit Button is placed in front of it.

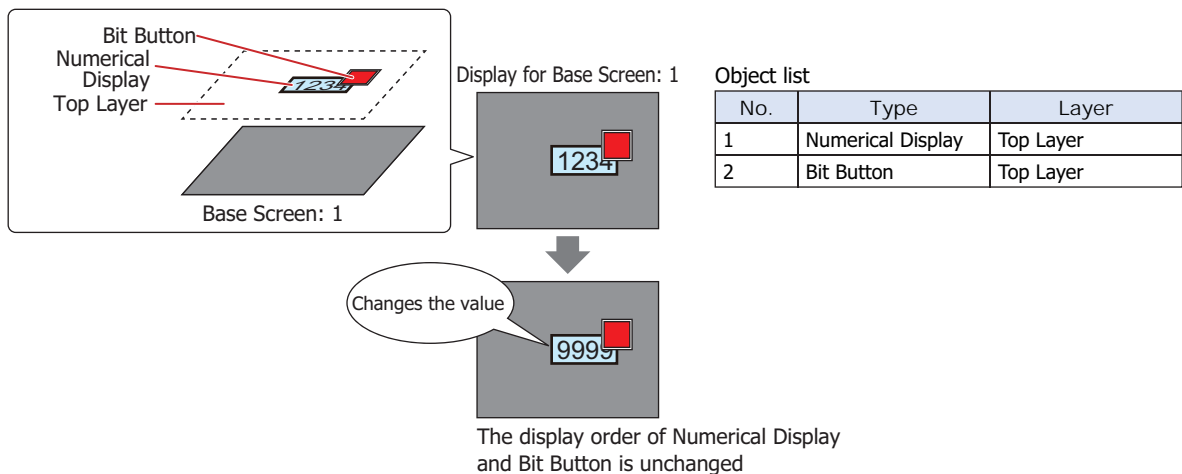

- Display order of drawing and parts overlapping

- If a drawing and part are overlapping with each other on a base screen or popup screen, the drawing or part configured in the Properties dialog box as a top layer, then it will be displayed in the front over the other.
Example: An equilateral hexagon is placed on the base screen and a Numerical Display is placed in front of it.

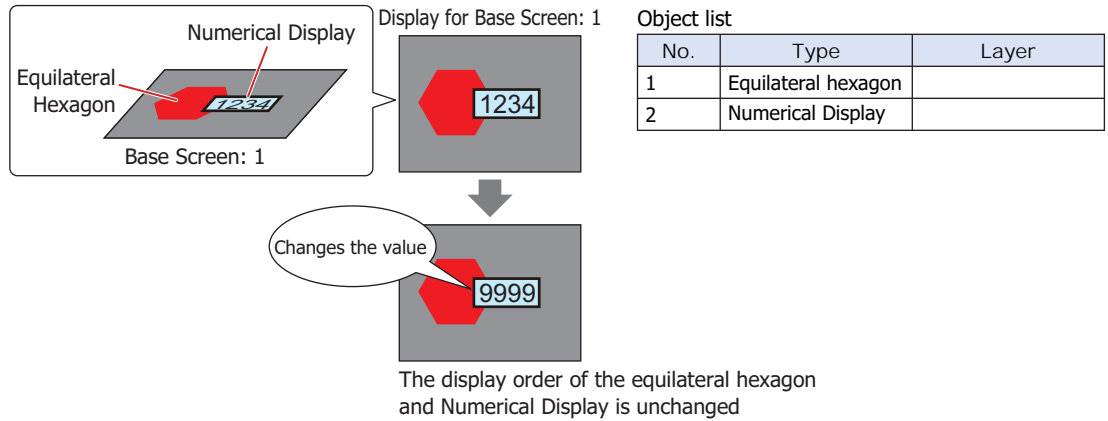

- If a part placed on a base screen or popup screen and a drawing placed on the top layer overlap, the drawing placed on the top layer is always displayed in front.

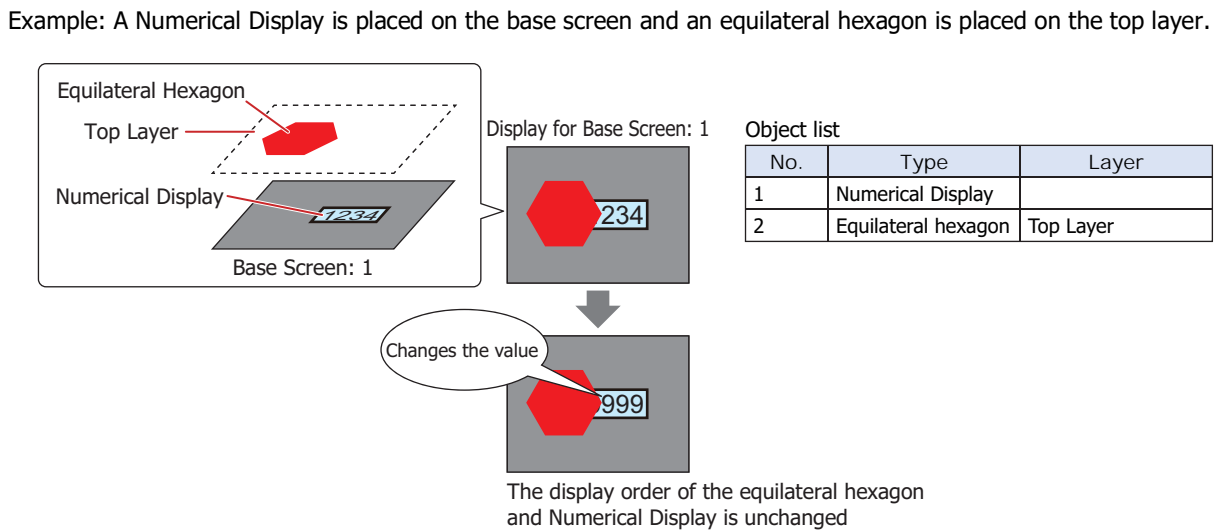

● Drawing and Parts are hidden



In the following situations, the drawing and the part image type are hidden.

- When the drawing or part is flashing
- When the hidden condition is satisfied in a part configured with display conditions
- When a lamp is off that has its **Not Display Image** check box selected on the **View** tab
- When an unregistered state or number is selected for the image type in a Multi-State Lamp or Picture Display
- When moving a Picture Display

- When a drawing and another drawing or part placed on a base screen or popup screen overlap, if the drawing or part in front becomes hidden, the portion of the background drawing that was overlapped remains missing.
Example: A rectangle is placed on the base screen and a Picture Display is placed in front of it.

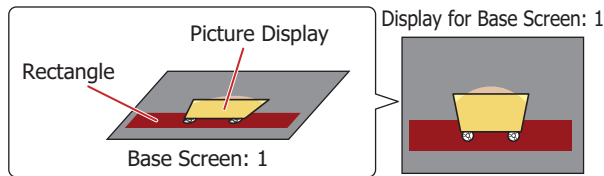

Object list

No.	Type	Layer
1	Rectangle	
2	Picture Display	

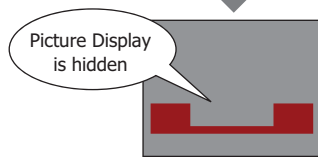

Overlapping part for the rectangle and Picture Display is the background for the screen and the rectangle remains missing.

- When a drawing placed on a base screen or popup screen and a drawing or part placed on the top layer overlap, if the drawing or part placed on the top layer becomes hidden, only the drawing that was placed on the base screen or popup screen is displayed.

Example: A rectangle is placed on the base screen and a Picture Display is placed on the top layer.

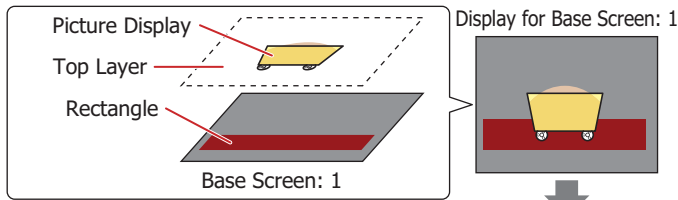

Object list

No.	Type	Layer
1	Rectangle	
2	Picture Display	Top Layer

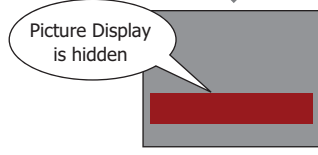

Rectangle remains

- When a drawing and another drawing or part placed on the top layer overlap, if the drawing or part in front becomes hidden, only the background drawing is displayed.

Example: A rectangle is placed on the top layer and a Picture Display is placed in front of it.

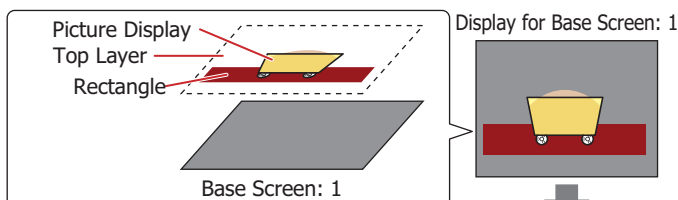

Object list

No.	Type	Layer
1	Rectangle	Top Layer
2	Picture Display	Top Layer

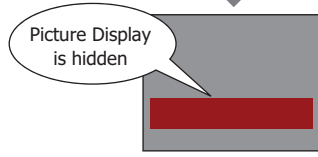

Rectangle remains

● Display order of overlapping parts that have **None** selected for **Image Type**

- When a drawing and a part that has **None** selected for **Image Type** placed on a base screen or popup screen overlap, if the value for the part changes or if the picture for the part changes, the portion of the background drawing that was overlapped remains missing.

Example: An equilateral hexagon is placed on the base screen and a Numerical Display is placed in front of it.

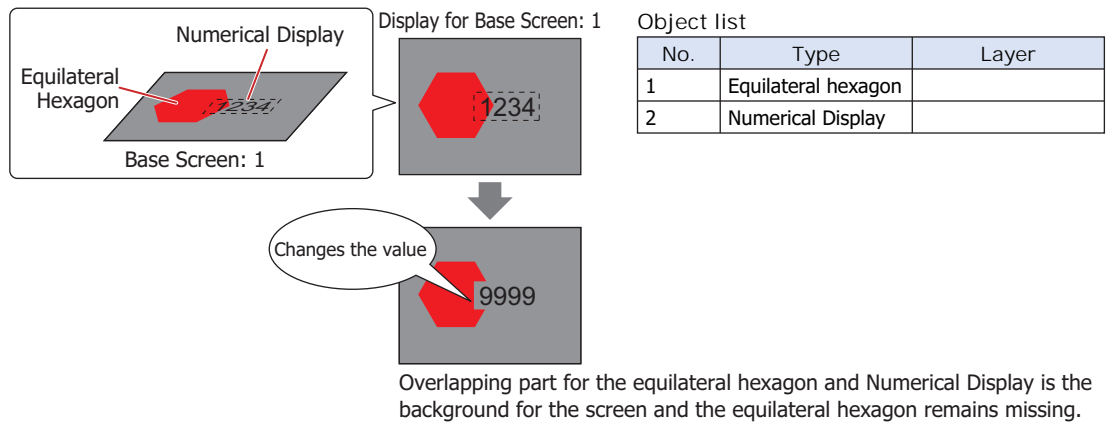

- When a drawing placed on a base screen or popup screen and a part that has **None** selected for **Image Type** placed on the top layer overlap, if the value for the part changes or if the picture for the part changes, no part of the drawing on the base screen will be missing.

Example: An equilateral hexagon is placed on the base screen and a Numerical Display is placed on the top layer.

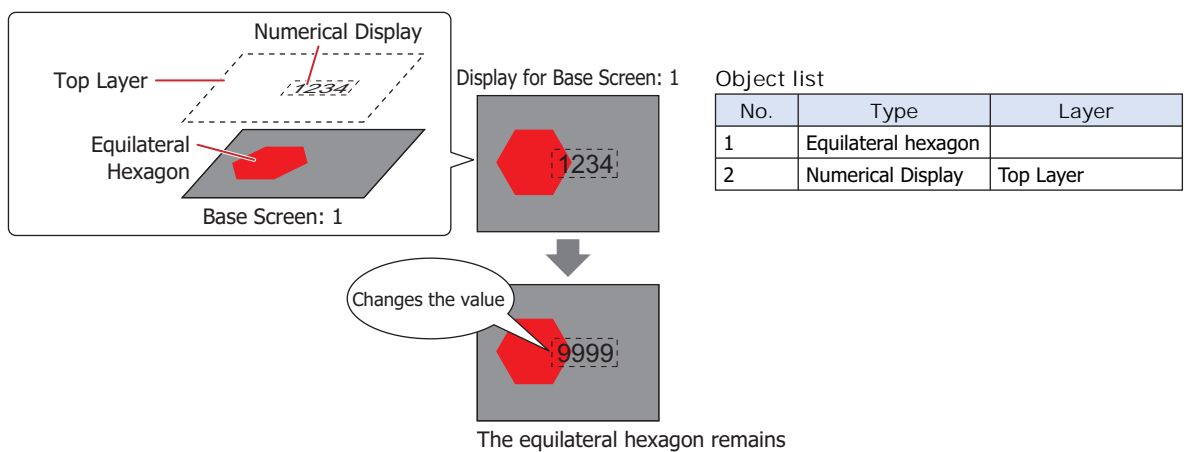

- When a drawing and a part that has **None** selected for **Image Type** placed on the top layer overlap, if the value for the top layer part changes or if the picture for the part changes, no part of the background drawing will be missing.

Example: An equilateral hexagon is placed on the top layer and a Numerical Display is placed in front of it.

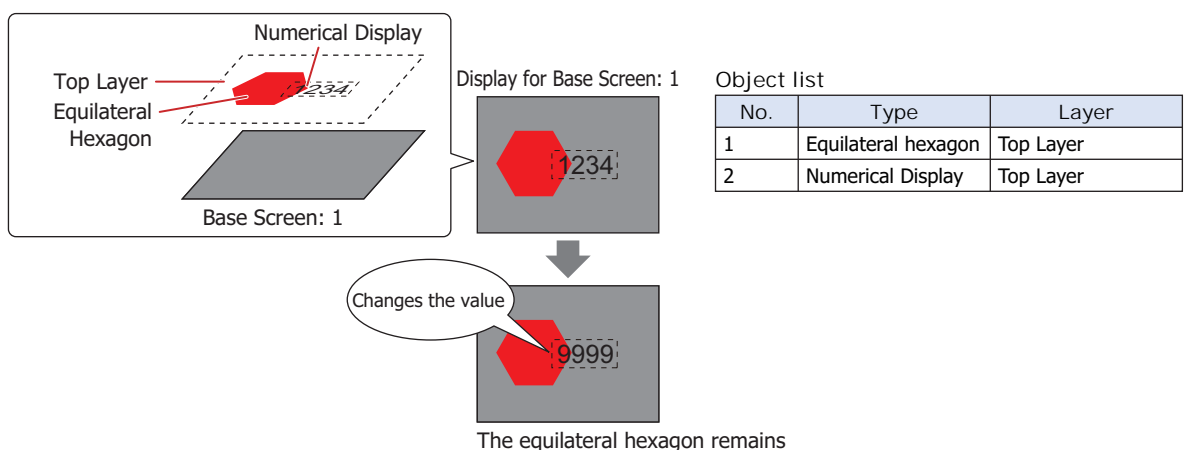

4.3 Restrictions

- To place overlapping drawings and parts on a screen, we recommend they be placed on the top layer. If the number of objects placed on the top layer exceeds the limit, only the objects that exceed the limit will be placed on the base screen or popup screen. At this time, the value of HMI Special Internal Relay LSM33 is 1. For details, refer to Chapter 33 "HMI Special Relay (LSM)" on page 33-2.
- When the Message Display, Message Switching Display, and Alarm List Display have their **Scroll** check box selected on the **Format** tab in the **Properties** dialog box and they are placed on the top layer, the scrolling speed of the text will be slower.
- On the Top Layer, magenta (R:255, G:4, B:255) is treated as the transparent color. If you place pictures used this color on a Top Layer, those areas are completely transparent.
- When the following objects are placed on the Top Layer, the text is displayed with a color mixed with magenta. If the text color causes a problem, set the Background Color of the text or change it to Windows font.
 - Texts with **Background Color** set to **None**
 - Parts with **Image Type** set to **None**
 - Parts for which **Not Display Image** is selected
 - Parts using the pictures with the background of the texts replaced with a **Transparent Color**.

5 Part Library Function

HG2J-7U HG5G-V HG4G-V HG4G HG3G-V HG3G HG2G-V HG2G-5F HG2G-5T HG1G HG1P

5.1 What Can Be Done with the Part Library Function

The part library is a window that manages all the objects registered as a library. Objects registered as a library are called library parts.

You can easily create a screen by selecting the library parts listed in the part library and dragging and dropping them onto the editing screen.

The part library has a standard library and a custom library, and the standard library displays library parts of images provided by WindO/I-NV4. The type of parts and the registered parts cannot be edited.

The custom library allow you to register objects created on the editing screen as library parts and reuse them. The custom library can be saved to a file for use in other projects or on other computers.

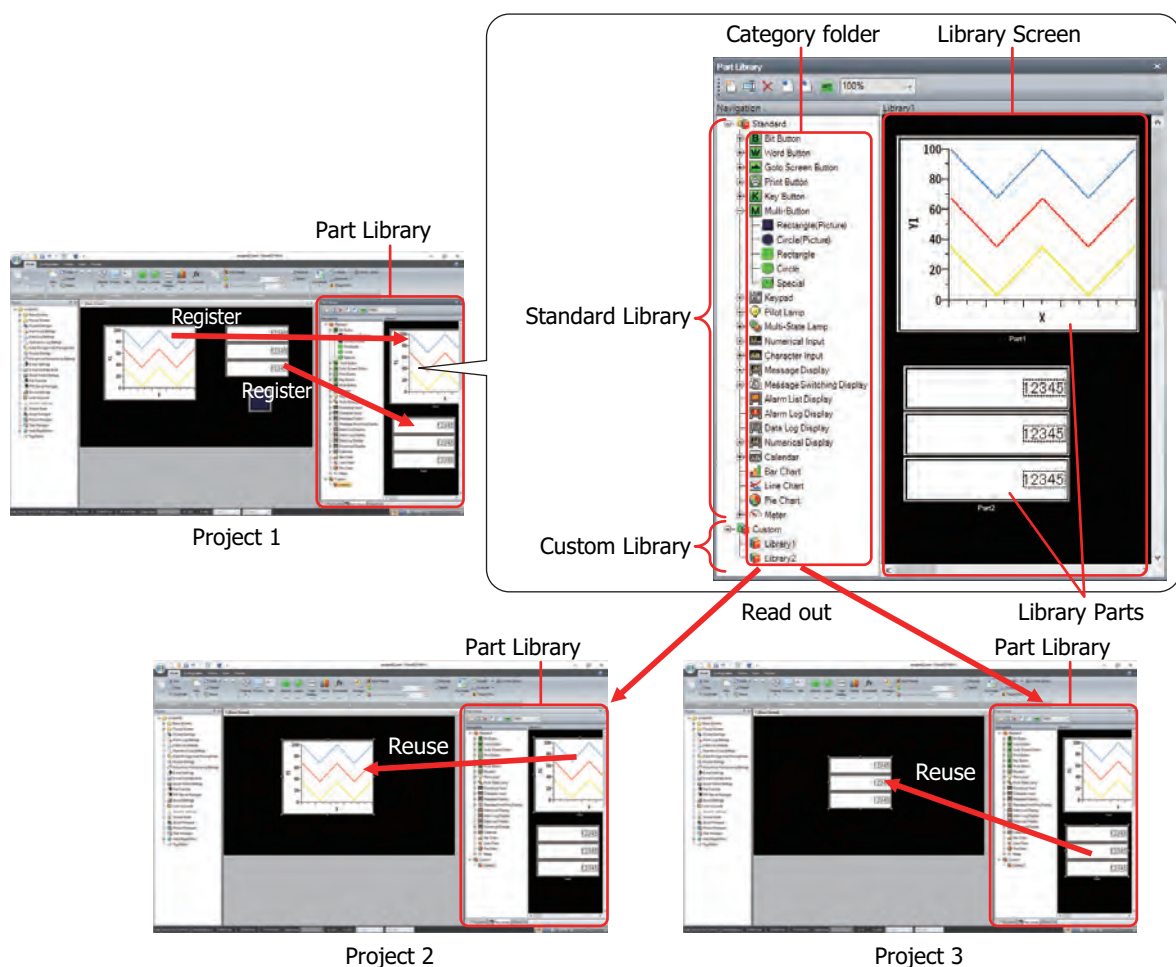

If you edit multiple projects on the same computer at the same time, you can use the same parts library. However, you cannot create, delete, import, export, rename, register objects, or edit a library part in the custom library of the part library on the WindO/I-NV4 opened after the second one.



If you want to use library parts of the custom library on another computer, save the category folder as a file and import the file in another project.

Right-click **Category Folder** in the **Part Library** window to export and import the file.

5.2 How to use the Library Part in a project

- 1 Double click the category folder that contains the library part you want to use.
Images of library parts are displayed on the library screen.

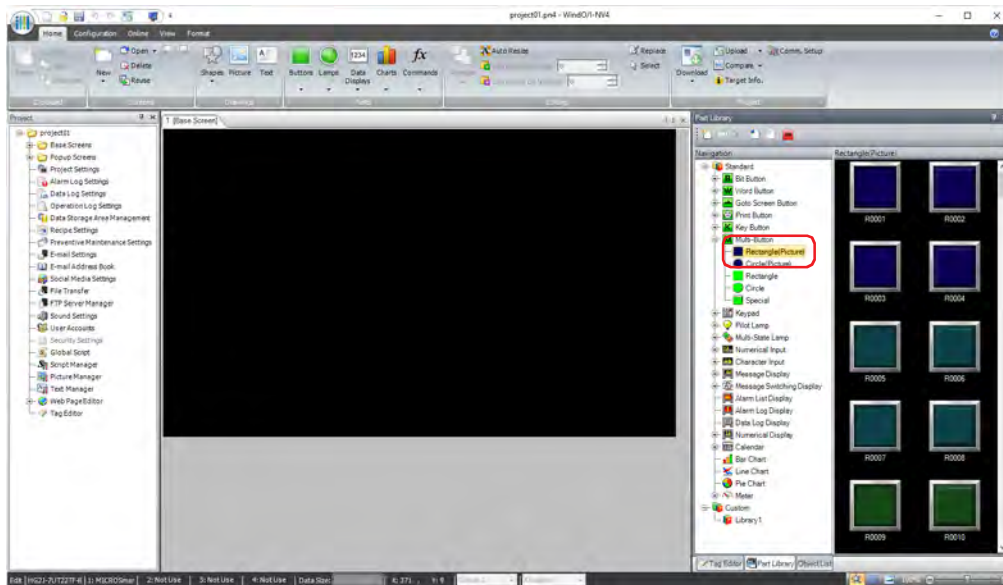

- 2 Select the library part and drag and drop it on the editing screen.

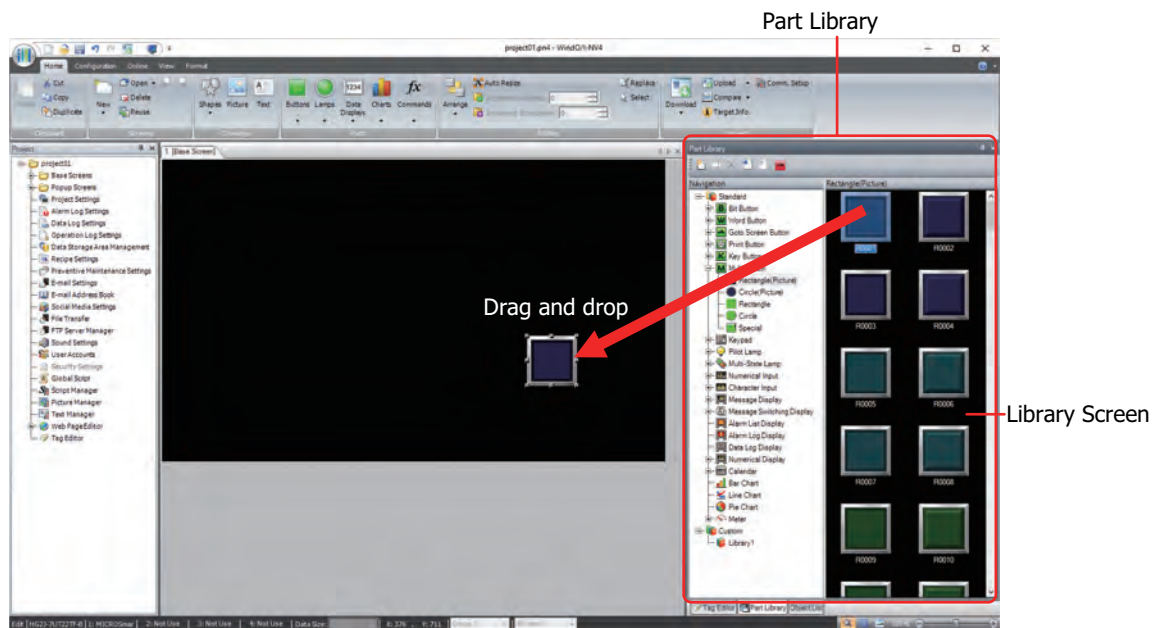

If the library part is placed on the editing screen and the corresponding project does not recognize the device address, the device address setting associated with the part becomes blank.

Example: When a bit button (Destination Device Address: #M0), registered as a library part and is created by using the HG5G-V project, is placed on the HG2J-7U project, the Destination Device Address becomes blank.

5.3 How to register an object in the parts library

- 1 Select the destination to register an object from the parts library.

Double click "Library1" in the custom library.

To create a new destination to register it, click  (New).

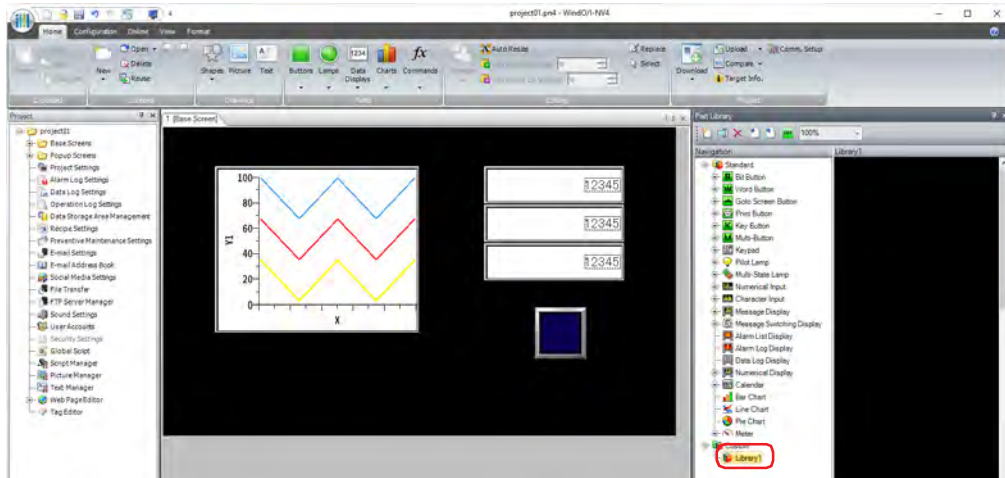

"Library1" is a category folder prepared as default. It can be renamed or deleted.

- 2 Select an object on the editing screen, and drag and drop it onto the library screen to register.

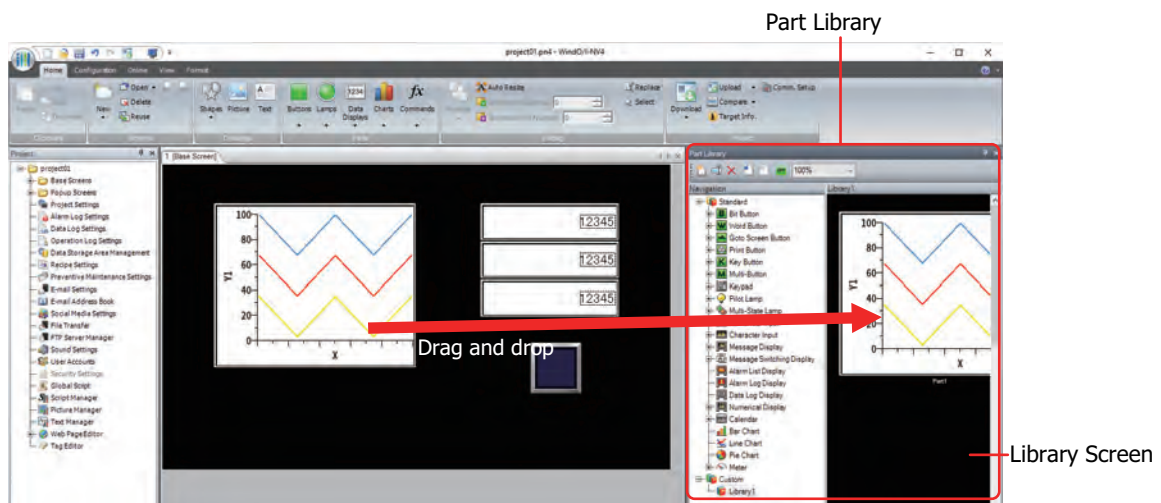

- Object settings are registered in the library, however the settings in the Security tab, the tag names and the comments of device addresses are not registered.
- Device address cannot be registered when following external device is used.
 - Manufacturer is ABB
 - Manufacturer is Allen-Bradley and Communication Driver is "Logix Native Tag(Ethernet)"
- Objects that group drawings and parts cannot be registered.
- For HG2J-7U, objects using NMF files cannot be registered.



Right-click an object on the editing screen, and select the category folder displayed by clicking **Register in Part Library**, it can be registered as a library part.

This concludes registering in the part library.



When a library part is placed on the editing screen, the text set in the library part is registered in the Text Manager of the project being edited, image files in the Picture Manager, and scripts in the Script Manager. However, if the device address set in the library part does not correspond to the project in which the library part will be placed, the device address setting is deleted when placing it to the editing screen.

5.4 How to use a registered library part on another computer

To use the library part registered in the custom library on another project, save it as a part library file (*.plf), and then import it to a project. Parts library files are per category folder of the custom library.



Export and import the parts library file (*.plf) to use library parts created by other user as well.

● Exporting library parts

- 1 Select the category folder to export from the custom library in the part library navigation, and click  (Export) on the toolbar.

The **Save As** dialog box is displayed.

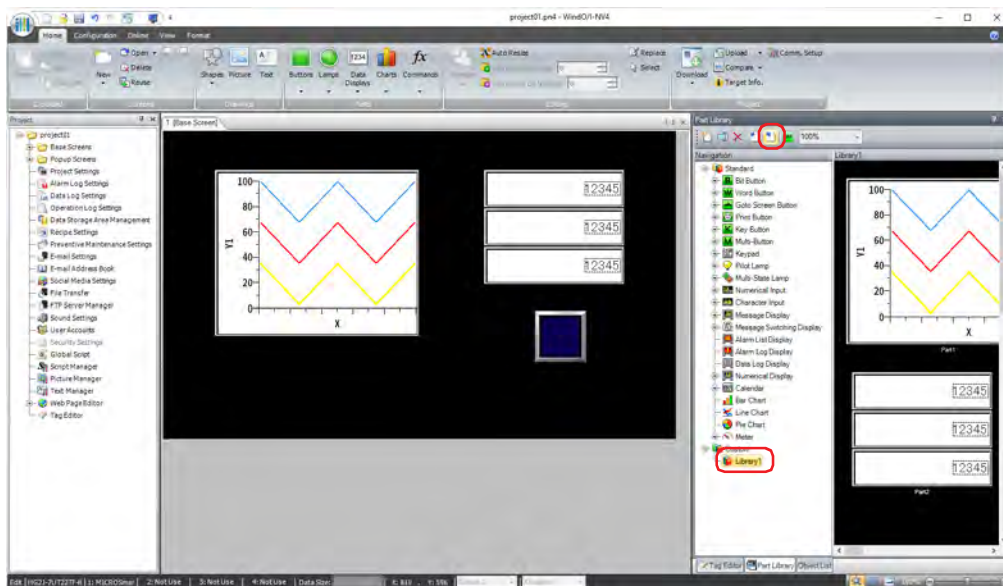

- 2 Specify the save location and the file name, and then click **Save**.

The maximum number for the part library file name is 255 characters.



You cannot use periods and the following characters in the part library file name.

" * . / : < > ? \ |

This concludes exporting part library file.

● Importing library parts

- 1 Click  (Import) on the toolbar of the part library.

The **Open** dialog box is displayed.

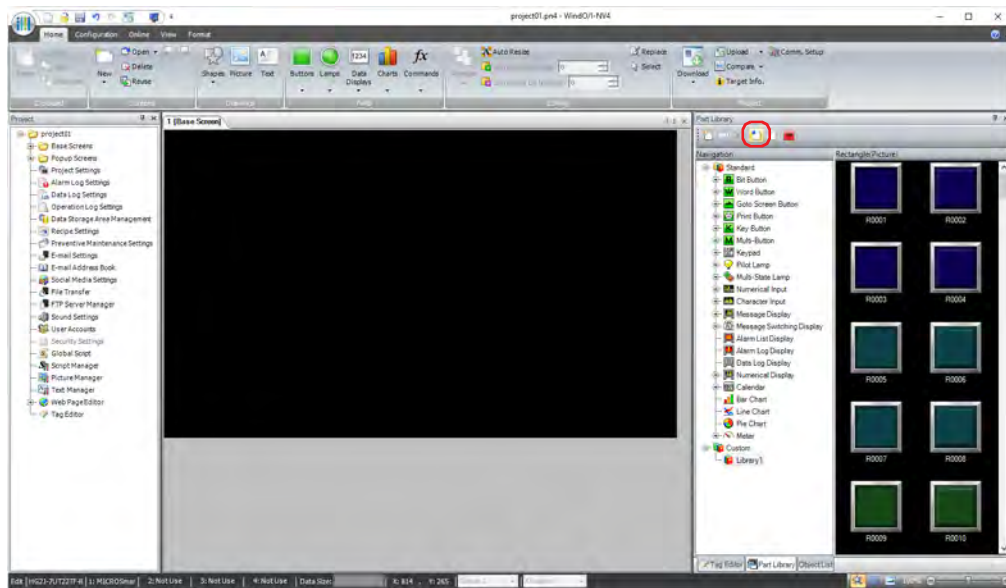

- 2 Select a part library file (*.plf), and then click **Open**.

The category folder of the imported part library file is displayed in the custom library.



If there are already 64 custom libraries in the part library, it cannot be imported. Click Cancel to close the Open dialog box, delete an existing custom library, and then import it.

This concludes importing the part library file.

5.5 Part Library

This section describes items and buttons on the Part Library.



■ (Toolbar)



(New):

Creates a new category folder in the custom library. A maximum of 64 folders can be created.

The default is "Library**" (**: number).



(Rename):

Select the category folder or the library parts of the selected custom library and click this button to change the name.



(Delete):

Deletes the category folder or the library parts of the selected custom library.



(Import):

Loads the category folder of the custom library saved as a part library file (*.plf) into the part library. For details, refer to "Importing library parts" on page 6-15.

Click this button to display the **Open** dialog box.



(Export):

Exports and saves the category folder of the custom library as a part library file (*.plf). Click this button to display the **Save As** dialog box. For details, refer to "Exporting library parts" on page 6-14.

The saved part library file can be imported with (Import).



(ON/OFF):

Switches between the ON image and the OFF image for parts on the library screen.



(Zoom Level): Enter the display magnification (50% to 400%) of the library screen, or select from the following.

400%, 300%, 200%, 100%, 50%

■ (Standard Library)

The library of the default parts contained within WindO/I-NV4 is displayed. Double click to display the part images contained in the selected category folder on the library screen.

■ (Custom Library)

Displays the created library. Double click to display the part image registered in the selected category folder on the library screen.

Clicking allows you to change the custom library name.

You can create up to 64 custom libraries and register up to 128 parts in one custom library.

■ (Library Screen)

Displays the image of the library parts in this window.

When you have selected the category folder of the custom library, you can drag and drop objects placed on the editing screen to this screen to register them in the custom library.

You can also drag and drop library parts from the library screen onto the editing screen to use them in the current project.

Chapter 7 Drawings

This chapter describes the procedures for drawing with shapes and the procedures for configuring pictures and text.

1 Shapes

1.1 Line

HG2J-7U HG5G-V HG4G-V HG4G HG3G-V HG3G HG2G-V HG2G-5F HG2G-5T HG1G HG1P

● Line Drawing Procedure

This section describes the procedure for drawing lines.

- 1 On the **Home** tab, in the **Drawings** group, click **Shapes**, and then click  (Line) under **Basic Shapes**.

The mouse cursor changes to  (pencil).

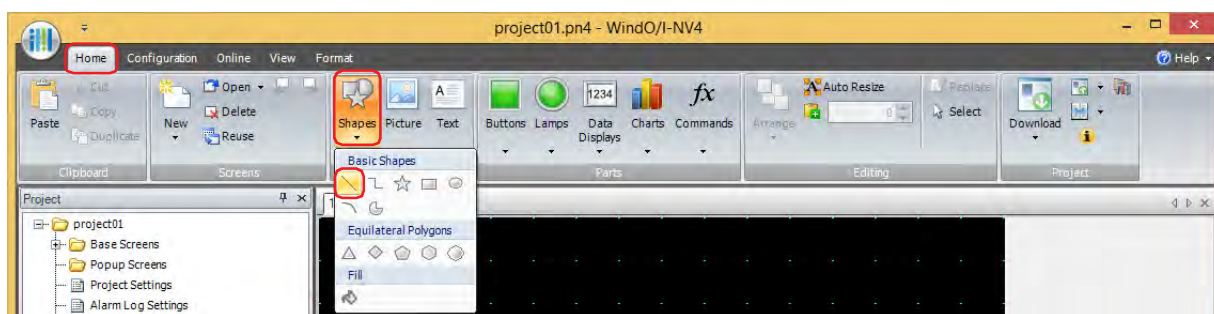

- 2 Click and hold the mouse button at the location (start point) to start drawing the line on the edit screen.

- 3 Drag the mouse to the stop point location.

A line is drawn that connects the start point and stop point.

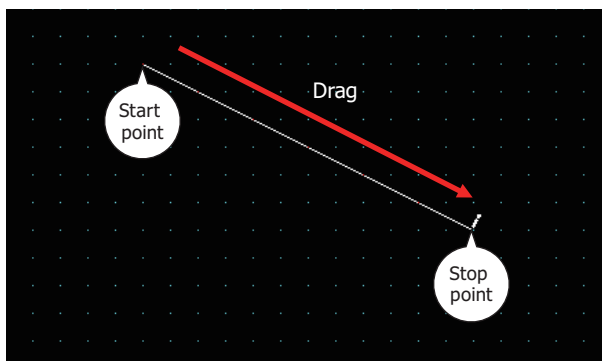

To change the style of the drawn line, perform one of the following operations.

- Double click the line to open the Properties dialog box
- Select the line and select the style with **Shape Style** on the **Format** tab
- Select the line and open the right click menu

● Properties of Line Dialog Box

This section describes items and buttons in the Properties dialog box.

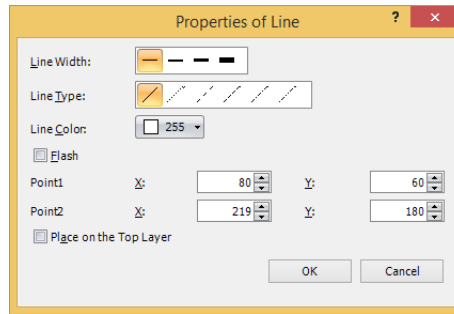

■ Line Width

Selects the line width for the line from the following.

1 dot, 2 dots, 3 dots, 5 dots

3 dots and **5 dots** can only be configured when **Solid** is selected for **Line Type**.

■ Line Type

Selects the line type for the line from the following.

Solid, Dot, Dash, Long Dash, Long Dash Dot, Long Dash Dot Dot

Dot, Dash, Long Dash, Long Dash Dot, and Long Dash Dot Dot can only be configured when **1 dot** or **2 dots** is selected for **Line Width**.

■ Line Color

Selects the line color for the line (color: 256 colors, monochrome: 16 shades).

Click this button to display the Color Palette. Select a color from the Color Palette.

■ Flash

Select this check box to make the line flash.

The flash interval is specified with **Flashing Cycle** on the **System** tab in the **Project Settings** dialog box.

■ Point1, Point2

X, Y: Specifies the start point and stop point of the line in coordinates.
The upper-left corner of the screen is the origin.

X: 0 to (base screen horizontal size - 1)

Y: 0 to (base screen vertical size - 1)

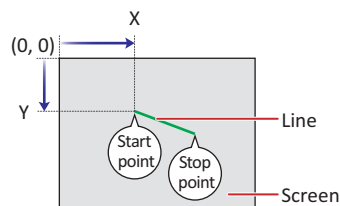

■ Place on the Top Layer

Select this check box to display the line on the top layer. The line will have precedence when other drawings and parts are overlapping with it. For details, refer to Chapter 6 "4 Drawings and Parts Overlapping" on page 6-5.

1.2 Polyline

HG2J-7U HG5G-V HG4G-V HG4G HG3G-V HG3G HG2G-V HG2G-5F HG2G-5T HG1G HG1P

● Polyline Drawing Procedure

This section describes the procedure for drawing polylines.

- 1 On the **Home** tab, in the **Drawings** group, click **Shapes**, and then click  (Polyline) under **Basic Shapes**.

The mouse cursor changes to  (pencil).

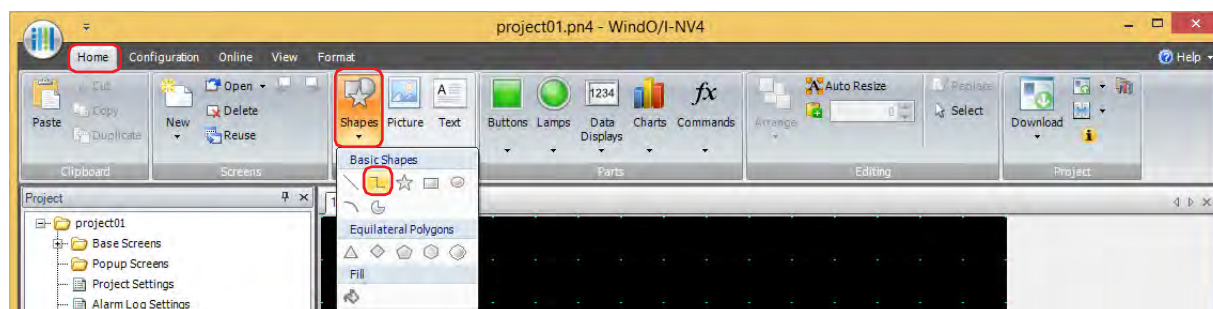

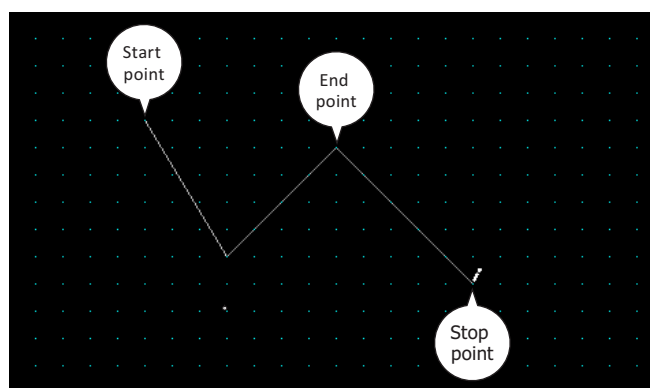

- 2 Click at the location (start point) to start drawing the polyline on the edit screen.
- 3 Click the end point locations in order.
A line is drawn that connects the start point and the various end point locations in the order that they were created.
- 4 Double click at the stop point location.
A line is drawn that connects the last end point and the stop point.



The maximum number of end points in a polyline, including the start point and the stop point, is 300 points.



- To change the style of the drawn polyline, perform one of the following operations.
 - Double click the polyline to open the Properties dialog box
 - Select the polyline and select the style with **Shape Style** on the **Format** tab
 - Select the polyline and open the right click menu
- To change the start point, end points, or the stop point of the drawn polyline, select the polyline and right click on it, then click **Reshape**.  is displayed on the polyline. Drag  to the desired location. Double click the edit screen or press the **Esc** key to finish changing the shape.

● Properties of Polyline Dialog Box

This section describes items and buttons in the Properties dialog box.

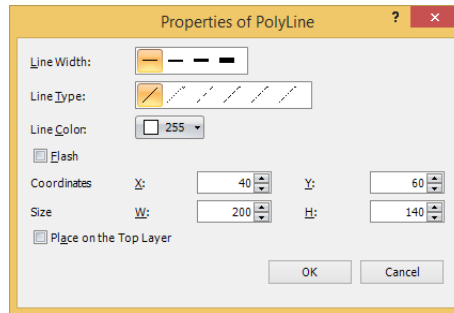

■ Line Width

Selects the line width for the polyline from the following.

1 dot, 2 dots, 3 dots, 5 dots

3 dots and **5 dots** can only be configured when **Solid** is selected for **Line Type**.

■ Line Type

Selects the line type for the polyline from the following.

Solid, Dot, Dash, Long Dash, Long Dash Dot, Long Dash Dot Dot

Dot, Dash, Long Dash, Long Dash Dot, and Long Dash Dot Dot can only be configured when **1 dot** or **2 dots** is selected for **Line Width**.

■ Line Color

Selects the line color for the polyline (color: 256 colors, monochrome: 16 shades).

Click this button to display the Color Palette. Select a color from the Color Palette.

■ Flash

Select this check box to make the polyline flash.

The flash interval is specified with **Flashing Cycle** on the **System** tab in the **Project Settings** dialog box.

■ Coordinates

X, Y: Specifies the display position of the polyline in coordinates. With the upper-left corner of the screen as the origin, the upper-left corner of the rectangle that circumscribes the polyline is the X and Y coordinates.
 X: 0 to (base screen horizontal size - 1)
 Y: 0 to (base screen vertical size - 1)

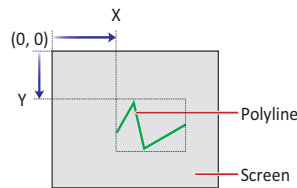

■ Size

W, H: Specifies the size of the polyline in width and height.
 W: 1 to (base screen horizontal size)
 H: 1 to (base screen vertical size)

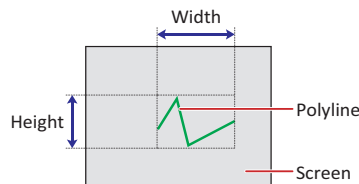

■ Place on the Top Layer

Select this check box to display the polyline on the top layer. The polyline will have precedence when other drawings and parts are overlapping with it. For details, refer to Chapter 6 "4 Drawings and Parts Overlapping" on page 6-5.

1.3 Polygon

HG2J-7U HG5G-V HG4G-V HG4G HG3G-V HG3G HG2G-V HG2G-5F HG2G-5T HG1G HG1P

● Polygon Drawing Procedure

This section describes the procedure for drawing polygons.

- 1 On the **Home** tab, in the **Drawings** group, click **Shapes**, and then click ☆ (Polygon) under **Basic Shapes**.

The mouse cursor changes to ✎ (pencil).

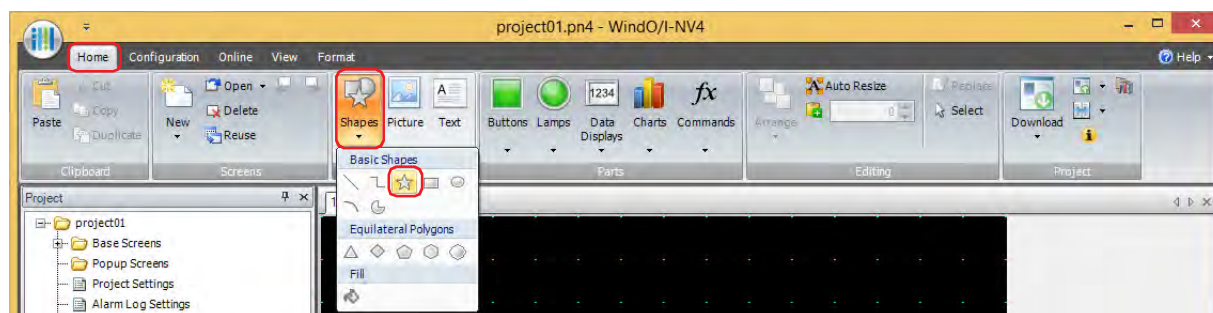

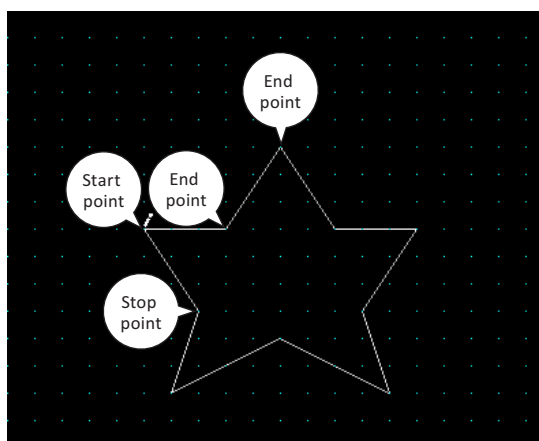

- 2 Click at the location (start point) to start drawing the polygon on the edit screen.
- 3 Click the end point locations in order.
A line is drawn that connects the start point and the various end point locations in the order that they were created.
- 4 Double click at the stop point location.
A polygon is drawn with the start point and stop point connected.



The maximum number of end points in the polygon, including the start point and the stop point, is 300 points.



- To change the style of the drawn polygon, perform one of the following operations.
 - Double click the polygon to open the Properties dialog box
 - Select the polygon and select the style with **Shape Style** on the **Format** tab
 - Select the polygon and open the right click menu
- To change the start point, end points, or the stop point of the drawn polygon, select the polygon and right click on it, then click **Reshape**.  is displayed on the polygon. Drag  to the desired location. Double click the edit screen or press the key to finish changing the shape.

● Properties of Polygon Dialog Box

This section describes items and buttons in the Properties dialog box.

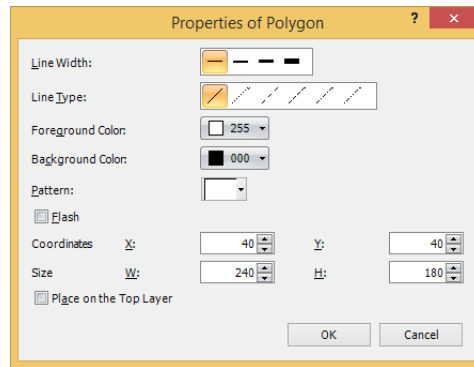

■ Line Width

Selects the line width for the polygon from the following.

1 dot, 2 dots, 3 dots, 5 dots

3 dots and **5 dots** can only be configured when **Solid** is selected for **Line Type**.

■ Line Type

Selects the line type for the polygon from the following.

Solid, Dot, Dash, Long Dash, Long Dash Dot, Long Dash Dot Dot

Dot, Dash, Long Dash, Long Dash Dot, and Long Dash Dot Dot can only be configured when **1 dot** or **2 dots** is selected for **Line Width**.

■ Foreground Color, Background Color

Selects the foreground color and the background color to use for the polygon (color: 256 colors, monochrome: 16 shades).

Click either button to display the Color Palette. Select a color from the Color Palette.

■ Pattern

Selects the pattern or tonal gradation for the polygon.

Click this button to display the Pattern Palette. Select a pattern or tonal gradation from the Pattern Palette.

■ Flash

Select this check box to make the polygon flash.

The flash interval is specified with **Flashing Cycle** on the **System** tab in the **Project Settings** dialog box.

■ Coordinates

X, Y: Specifies the display position of the polygon in coordinates.

With the upper-left corner of the screen as the origin, the upper-left corner of the rectangle that circumscribes the polygon is the X and Y coordinates.

X: 0 to (base screen horizontal size - 1)

Y: 0 to (base screen vertical size - 1)

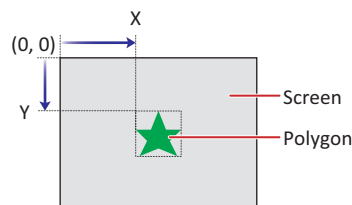

■ Size

W, H: Specifies the size of the polygon in width and height.

W: 1 to (base screen horizontal size)

H: 1 to (base screen vertical size)

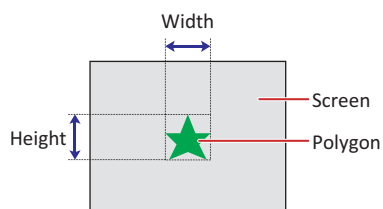
**■ Place on the Top Layer**

Select this check box to display the polygon on the top layer. The polygon will have precedence when other drawings and parts are overlapping with it. For details, refer to Chapter 6 "4 Drawings and Parts Overlapping" on page 6-5.

1.4 Rectangle

HG2J-7U HG5G-V HG4G-V HG4G HG3G-V HG3G HG2G-V HG2G-5F HG2G-5T HG1G HG1P

● Rectangle Drawing Procedure

This section describes the procedure for drawing rectangles.

- 1 On the **Home** tab, in the **Drawings** group, click **Shapes**, and then click  (Rectangle) under **Basic Shapes**. The mouse cursor changes to  (pencil).

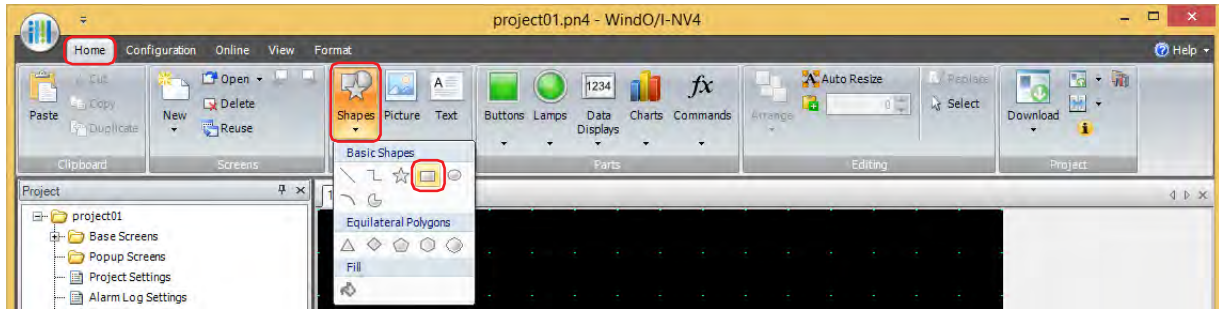

- 2 Click and hold the mouse button at the location (start point) to start drawing the rectangle on the edit screen.
- 3 Drag the mouse to the stop point location so that location becomes the opposite angle of the rectangle. A rectangle is drawn with the start point and stop point set to opposite angles.

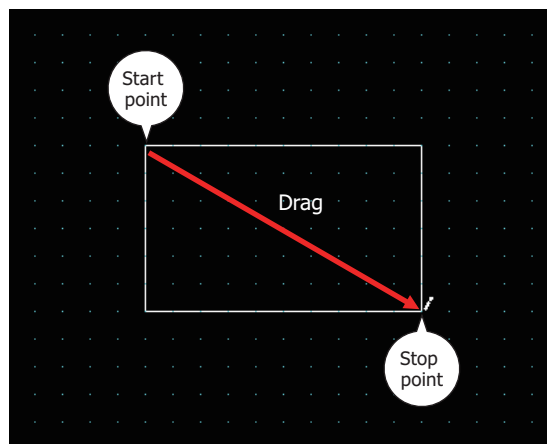

To change the style of the drawn rectangle, perform one of the following operations.

- Double click the rectangle to open the Properties dialog box
- Select the rectangle and select the style with **Shape Style** on the **Format** tab
- Select the rectangle and open the right click menu

● Properties of Rectangle Dialog Box

This section describes items and buttons in the Properties dialog box.

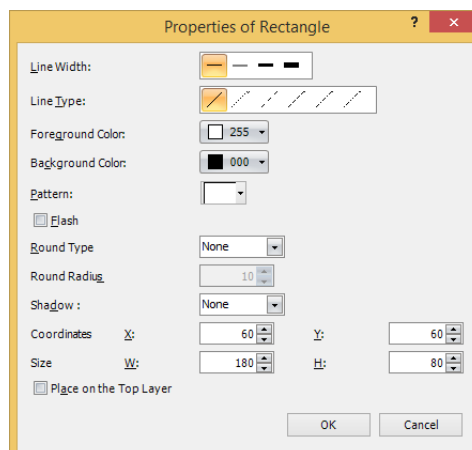

■ Line Width

Selects the line width for the rectangle from the following.

1 dot, 3 dots, 5 dots

3 dots and **5 dots** can only be configured when **Solid** is selected for **Line Type**.

■ Line Type

Selects the line type for the rectangle from the following.

Solid, Dot, Dash, Long Dash, Long Dash Dot, Long Dash Dot Dot

Dot, Dash, Long Dash, Long Dash Dot, and Long Dash Dot Dot can only be configured when **1 dot** is selected for **Line Width**.

■ Foreground Color, Background Color

Selects the foreground color and the background color to use for the rectangle (color: 256 colors, monochrome: 16 shades).

Click either button to display the Color Palette. Select a color from the Color Palette.

■ Pattern

Selects the pattern or tonal gradation for the rectangle.

Click this button to display the Pattern Palette. Select a pattern or tonal gradation from the Pattern Palette.

■ Flash

Select this check box to make the rectangle flash.

The flash interval is specified with **Flashing Cycle** on the **System** tab in the **Project Settings** dialog box.

■ Round Type

Selects the style of the rectangle's corners from the following.

None, Curve, Straight

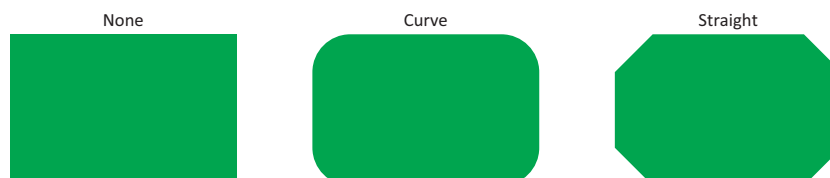

■ **Round Radius**

Specifies the rounding radius (1 to 200). However, the range that can be configured is where round radius x 2 is a value smaller than **Size W** and **Size H**.

This option can only be configured when **Curve** or **Straight** is selected for **Round Type**.

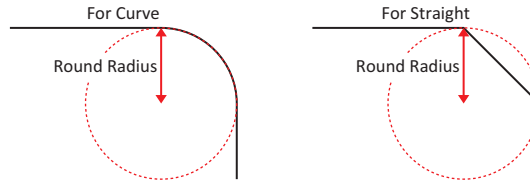

■ **Shadow**

Selects the style of shadow attached to the rectangle from the following. This option draws the rectangle in a three-dimensional manner.

None, Convex, Concave

This option can only be configured when **1 dot** is selected for **Line Width** and **Solid** is selected for **Line Type**.

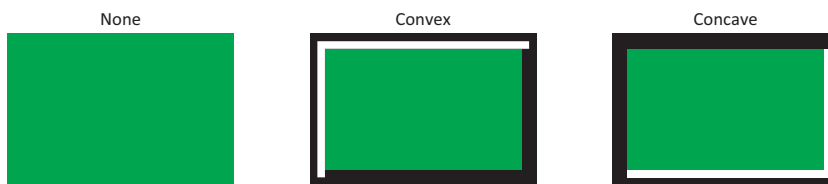

■ **Coordinates**

X, Y: Specifies the display position of the rectangle in coordinates.

With the upper-left corner of the screen as the origin, the upper-left corner of the rectangle is the X and Y coordinates.

X: 0 to (base screen horizontal size - 1)

Y: 0 to (base screen vertical size - 1)

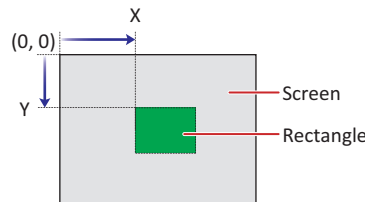

■ **Size**

W, H: Specifies the size of the rectangle in width and height.

W: 1 to (base screen horizontal size)

H: 1 to (base screen vertical size)

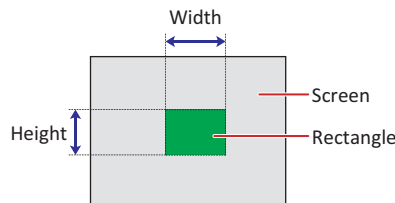

■ **Place on the Top Layer**



Select this check box to display the rectangle on the top layer. The rectangle will have precedence when other drawings and parts are overlapping with it. For details, refer to Chapter 6 "4 Drawings and Parts Overlapping" on page 6-5.

1.5 Circle/Ellipse

HG2J-7U HG5G-V HG4G-V HG4G HG3G-V HG3G HG2G-V HG2G-5F HG2G-5T HG1G HG1P

● Circle/Ellipse Drawing Procedure

This section describes the procedure for drawing circles and ellipses.

- 1 On the **Home** tab, in the **Drawings** group, click **Shapes**, and then click  (Circle/Ellipse) under **Basic Shapes**. The mouse cursor changes to  (pencil).

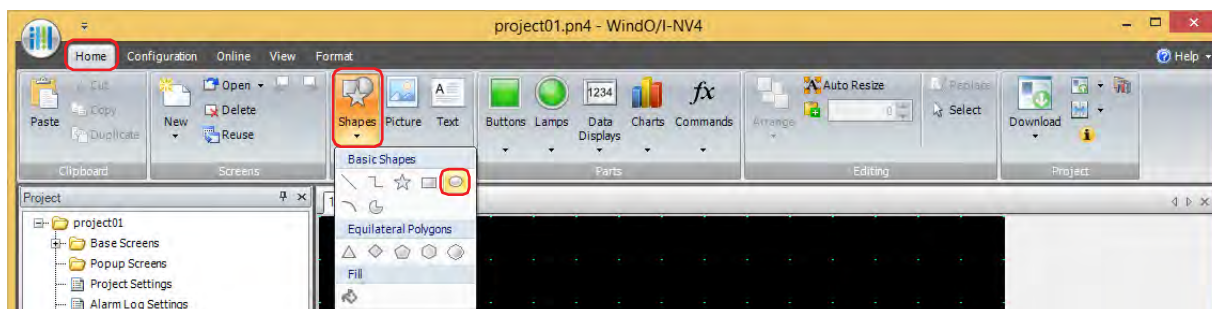

- 2 Click and hold the mouse button at the location (start point) to start drawing the circle or ellipse on the edit screen.
- 3 Drag the mouse to the stop point location so that location becomes the opposite angle of the rectangle. A circle or ellipse is drawn that inscribes the rectangle made from the opposite angles of the start point and the stop point.

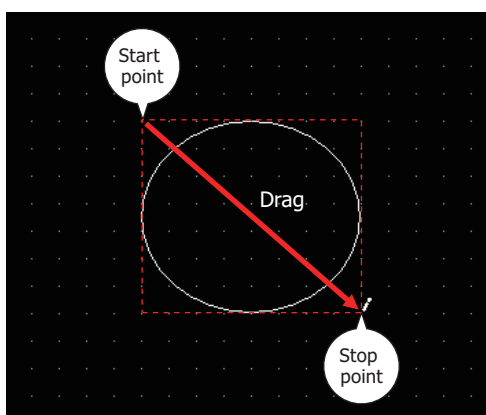

To change the style of the drawn circle or ellipse, perform one of the following operations.

- Double click the circle or ellipse to open the Properties dialog box
- Select the circle or ellipse and select the style with **Shape Style** on the **Format** tab
- Select the circle or ellipse and open the right click menu

● Properties of Circle/Ellipse Dialog Box

This section describes items and buttons in the Properties dialog box.

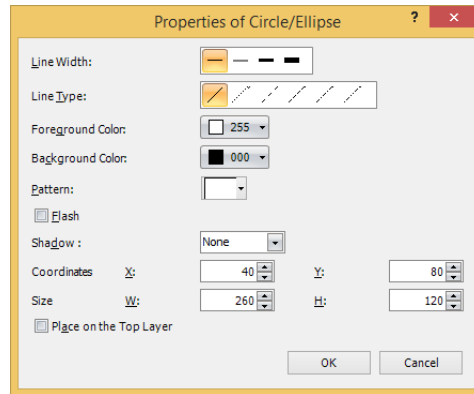

■ Line Width

Selects the line width for the circle or ellipse from the following.

1 dot, 3 dots, 5 dots

3 dots and **5 dots** can only be configured when **Solid** is selected for **Line Type**.

■ Line Type

Selects the line type for the circle or ellipse from the following.

Solid, Dot, Dash, Long Dash, Long Dash Dot, Long Dash Dot Dot

Dot, Dash, Long Dash, Long Dash Dot, and Long Dash Dot Dot can only be configured when **1 dot** is selected for **Line Width**.

■ Foreground Color, Background Color

Selects the foreground color and the background color to use for the circle or ellipse (color: 256 colors, monochrome: 16 shades).

Click either button to display the Color Palette. Select a color from the Color Palette.

■ Pattern

Selects the pattern or tonal gradation for the circle or ellipse.

Click this button to display the Pattern Palette. Select a pattern or tonal gradation from the Pattern Palette.

■ Flash

Select this check box to make the circle or ellipse flash.

The flash interval is specified with **Flashing Cycle** on the **System** tab in the **Project Settings** dialog box.

■ Shadow

Selects the style of shadow attached to the circle or ellipse from the following. This option draws the circle or ellipse in a three-dimensional manner.

None, Convex, Concave

This option can only be configured when **1 dot** is selected for **Line Width** and **Solid** is selected for **Line Type**.

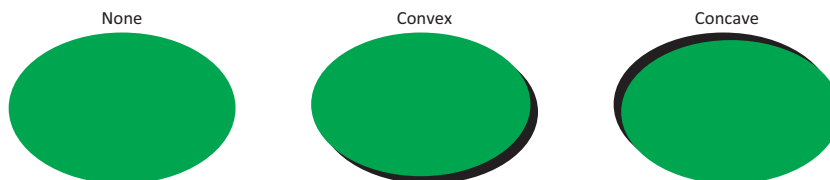

■ Coordinates

X, Y: Specifies the display position of the circle or ellipse in coordinates.
With the upper-left corner of the screen as the origin, the upper-left corner of the rectangle that circumscribes the circle or ellipse is the X and Y coordinates.

X: 0 to (base screen horizontal size - 1)

Y: 0 to (base screen vertical size - 1)

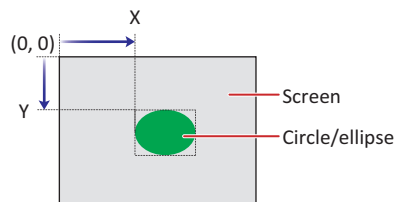

■ Size

W, H: Specifies the size of the circle or ellipse in width and height.

W: 1 to (base screen horizontal size)

H: 1 to (base screen vertical size)

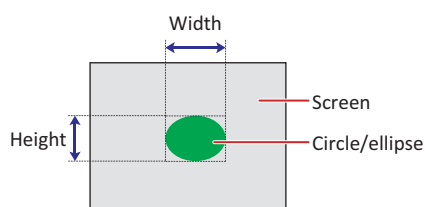

■ Place on the Top Layer

Select this check box to display the circle or ellipse on the top layer. The circle or ellipse will have precedence when other drawings and parts are overlapping with it. For details, refer to Chapter 6 "4 Drawings and Parts Overlapping" on page 6-5.

1.6 Arc

HG2J-7U HG5G-V HG4G-V HG4G HG3G-V HG3G HG2G-V HG2G-5F HG2G-5T HG1G HG1P

● Arc Drawing Procedure

This section describes the procedure for drawing arcs.

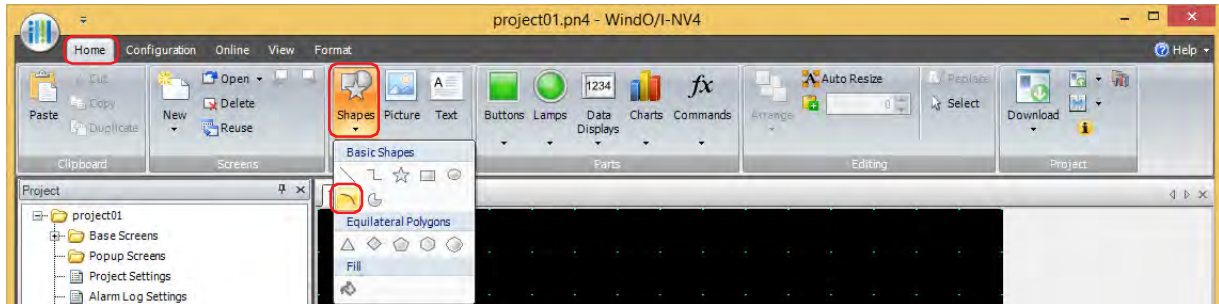

- 1 On the **Home** tab, in the **Drawings** group, click **Shapes**, and then click  (Arc) under **Basic Shapes**.

The mouse cursor changes to  (pencil).

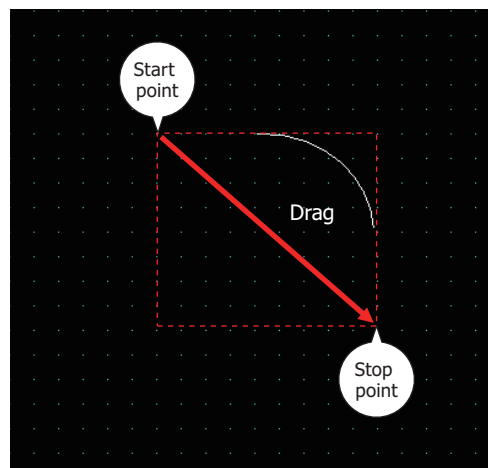

- 2 Click and hold the mouse button at the location (start point) to start drawing the arc on the edit screen.
- 3 Drag the mouse to the stop point location so that location becomes the opposite angle of the rectangle. An arc is drawn that inscribes the rectangle made from the opposite angles of the start point and the stop point.



- To change the style of the drawn arc, perform one of the following operations.
 - Double click the arc to open the Properties dialog box
 - Select the arc and select the style with **Shape Style** on the **Format** tab
 - Select the arc and open the right click menu
- To change the start point or the stop point of the drawn arc, select the arc and right click on it, then click **Reshape**.  is displayed on the arc. Drag  to the desired location. Double click the edit screen or press the **Esc** key to finish changing the shape.

● Properties of Arc Dialog Box

This section describes items and buttons in the Properties dialog box.

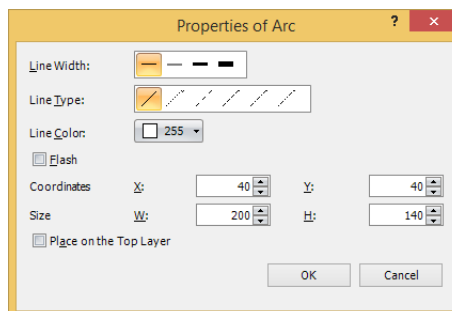

■ Line Width

Selects the line width for the arc from the following.

1 dot, 3 dots, 5 dots

3 dots and **5 dots** can only be configured when **Solid** is selected for **Line Type**.

■ Line Type

Selects the line type for the arc from the following.

Solid, Dot, Dash, Long Dash, Long Dash Dot, Long Dash Dot Dot

Dot, Dash, Long Dash, Long Dash Dot, and Long Dash Dot Dot can only be configured when **1 dot** is selected for **Line Width**.

■ Line Color

Selects the line color for the arc (color: 256 colors, monochrome: 16 shades).

Click this button to display the Color Palette. Select a color from the Color Palette.

■ Flash

Select this check box to make the arc flash.

The flash interval is specified with **Flashing Cycle** on the **System** tab in the **Project Settings** dialog box.

■ Coordinates

X, Y: Specifies the display position of the arc in coordinates.

With the upper-left corner of the screen as the origin, the upper-left corner of the rectangle that circumscribes the arc is the X and Y coordinates.

X: 0 to (base screen horizontal size - 1)

Y: 0 to (base screen vertical size - 1)

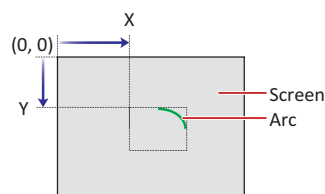

■ Size

W, H: Specifies the size of the arc in width and height.

W: 1 to (base screen horizontal size)

H: 1 to (base screen vertical size)

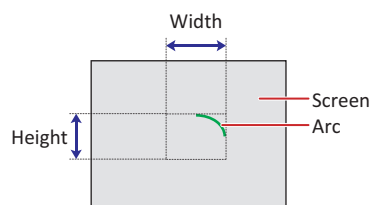

■ Place on the Top Layer

Select this check box to display the arc on the top layer. The arc will have precedence when other drawings and parts are overlapping with it. For details, refer to Chapter 6 "4 Drawings and Parts Overlapping" on page 6-5.

1.7 Pie

HG2J-7U HG5G-V HG4G-V HG4G HG3G-V HG3G HG2G-V HG2G-5F HG2G-5T HG1G HG1P

● Pie Drawing Procedure

This section describes the procedure for drawing pies.

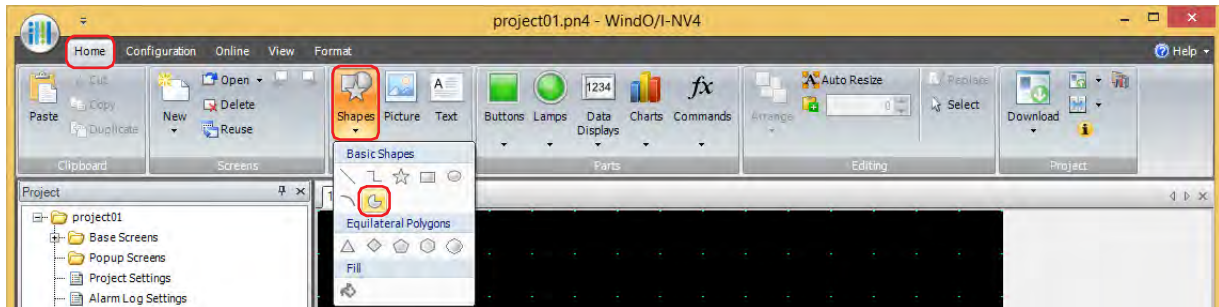

- 1 On the **Home** tab, in the **Drawings** group, click **Shapes**, and then click  (Pie) under **Basic Shapes**.

The mouse cursor changes to  (pencil).

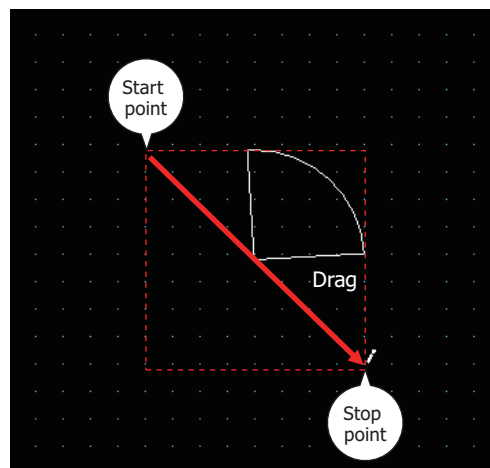

- 2 Click and hold the mouse button at the location (start point) to start drawing the pie on the edit screen.
- 3 Drag the mouse to the stop point location so that location becomes the opposite angle of the rectangle. A pie is drawn that inscribes the rectangle made from the opposite angles of the start point and the stop point.



- To change the style of the drawn pie, perform one of the following operations.
 - Double click the pie to open the Properties dialog box
 - Select the pie and select the style with **Shape Style** on the **Format** tab
 - Select the pie and open the right click menu
- To change the central angle of the drawn pie, select the pie and right click on it, then click **Reshape**.  is displayed on the pie. Drag  to the desired location. Double click the edit screen or press the key to finish changing the shape.

● Properties of Pie Dialog Box

This section describes items and buttons in the Properties dialog box.

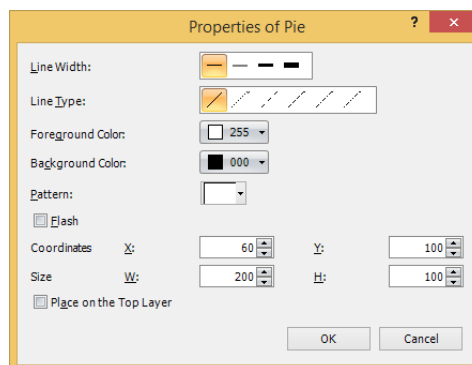

■ Line Width

Selects the line width for the pie from the following.

1 dot, 3 dots, 5 dots

3 dots and **5 dots** can only be configured when **Solid** is selected for **Line Type**.

■ Line Type

Selects the line type for the pie from the following.

Solid, Dot, Dash, Long Dash, Long Dash Dot, Long Dash Dot Dot

Dot, Dash, Long Dash, Long Dash Dot, and Long Dash Dot Dot can only be configured when **1 dot** is selected for **Line Width**.

■ Foreground Color, Background Color

Selects the foreground color and the background color to use for the pie (color: 256 colors, monochrome: 16 shades). Click either button to display the Color Palette. Select a color from the Color Palette.

■ Pattern

Selects the pattern or tonal gradation for the pie.

Click this button to display the Pattern Palette. Select a pattern or tonal gradation from the Pattern Palette.

■ Flash

Select this check box to make the pie flash.

The flash interval is specified with **Flashing Cycle** on the **System** tab in the **Project Settings** dialog box.

■ Coordinates

X, Y: Specifies the display position of the pie in coordinates.

With the upper-left corner of the screen as the origin, the upper-left corner of the rectangle that circumscribes the circle with the same center as the pie is the X and Y coordinates.

X: 0 to (base screen horizontal size - 1)

Y: 0 to (base screen vertical size - 1)

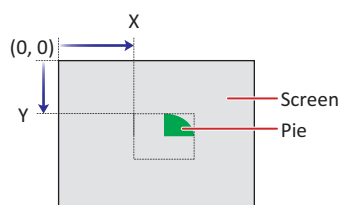

■ **Size**

W, H: Specifies the size of the pie in width and height.

W: 1 to (base screen horizontal size)

H: 1 to (base screen vertical size)

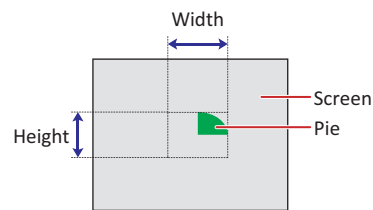

■ **Place on the Top Layer**





Select this check box to display the pie on the top layer. The pie will have precedence when other drawings and parts are overlapping with it. For details, refer to Chapter 6 "4 Drawings and Parts Overlapping" on page 6-5.

1.8 Equilateral Polygons

HG2J-7U HG5G-V HG4G-V HG4G HG3G-V HG3G HG2G-V HG2G-5F HG2G-5T HG1G HG1P

● Equilateral Polygons Drawing Procedure

This section describes the procedure to draw equilateral polygons (equilateral triangle, equilateral diamond, equilateral pentagon, equilateral hexagon, equilateral octagon).

- 1 On the **Home** tab, in the **Drawings** group, click **Shapes**, and then click  (Equilateral Triangle),  (Equilateral Diamond),  (Equilateral Pentagon),  (Equilateral Hexagon), or  (Equilateral Octagon) under **Equilateral Polygons**.

The mouse cursor changes to  (pencil).



- 2 Click and hold the mouse button at the location (start point) on the edit screen to start drawing the square that will circumscribe the equilateral polygon.
- 3 Drag the mouse to the stop point location so that location becomes the opposite angle of the square.

An equilateral polygon is drawn that inscribes the square made from the opposite angles of the start point and the stop point.

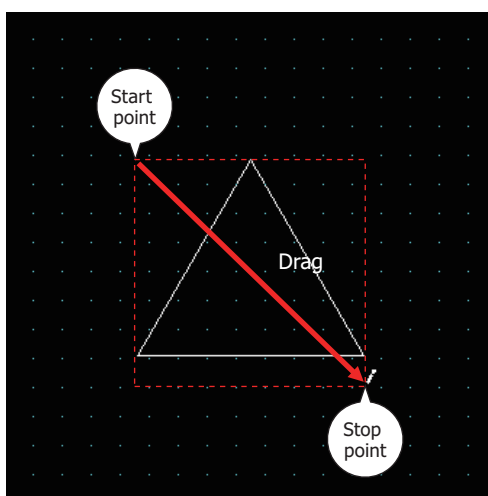

To change the style of the drawn square, perform one of the following operations.

- Double click the square to open the Properties dialog box
- Select the square and select the style with **Shape Style** on the **Format** tab
- Select the square and open the right click menu

● Properties of Equilateral Polygon Dialog Box

This section describes items and buttons in the Properties dialog box.

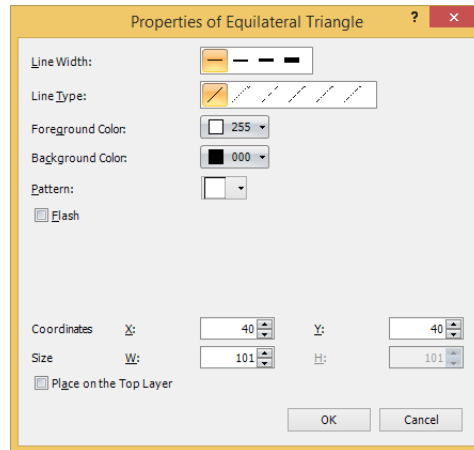

■ Line Width

Selects the line width for the equilateral polygon from the following.

1 dot, 2 dots, 3 dots, 5 dots

3 dots and **5 dots** can only be configured when **Solid** is selected for **Line Type**.

■ Line Type

Selects the line type for the equilateral polygon from the following.

Solid, Dot, Dash, Long Dash, Long Dash Dot, Long Dash Dot Dot

Dot, Dash, Long Dash, Long Dash Dot, and Long Dash Dot Dot can only be configured when **1 dot** or **2 dots** is selected for **Line Width**.

■ Foreground Color, Background Color

Selects the foreground color and the background color to use for the equilateral polygon (color: 256 colors, monochrome: 16 shades).

Click either button to display the Color Palette. Select a color from the Color Palette.

■ Pattern

Selects the pattern or tonal gradation for the equilateral polygon.

Click this button to display the Pattern Palette. Select a pattern or tonal gradation from the Pattern Palette.

■ Flash

Select this check box to make the equilateral polygon flash.

The flash interval is specified with **Flashing Cycle** on the **System** tab in the **Project Settings** dialog box.

■ Coordinates

X, Y: Specifies the display position of the equilateral polygon in coordinates.

With the upper-left corner of the screen as the origin, the upper-left corner of the square that circumscribes the equilateral polygon is the X and Y coordinates.

X: 0 to (base screen horizontal size - 1)

Y: 0 to (base screen vertical size - 1)

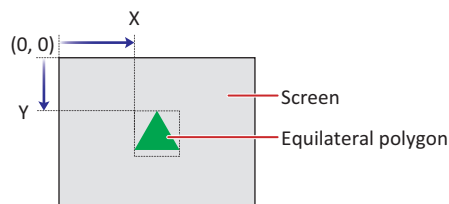

■ Size

W: Sets width to define the size of the equilateral polygon. The maximum size varies based on the item selected for Installation.

Horizontal: 1 to (base screen vertical size)

Vertical: 1 to (base screen horizontal size)

H: Displays the same as the width.

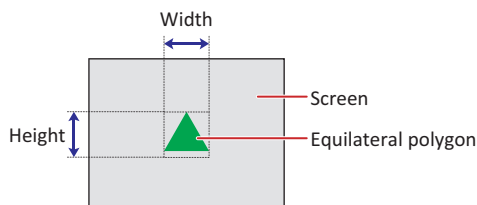
**■ Place on the Top Layer**

Select this check box to display the equilateral polygon on the top layer. The equilateral polygon will have precedence when other drawings and parts are overlapping with it. For details, refer to Chapter 6 "4 Drawings and Parts Overlapping" on page 6-5.

1.9 Fill

HG2J-7U HG5G-V HG4G-V HG4G HG3G-V HG3G HG2G-V HG2G-5F HG2G-5T HG1G HG1P

● Fill Configuration Procedure

This section describes the fill configuration procedure.

- 1 On the **Home** tab, in the **Drawings** group, click **Shapes**, and then click  (Fill) under **Fill**.

The mouse cursor changes to  (pencil).

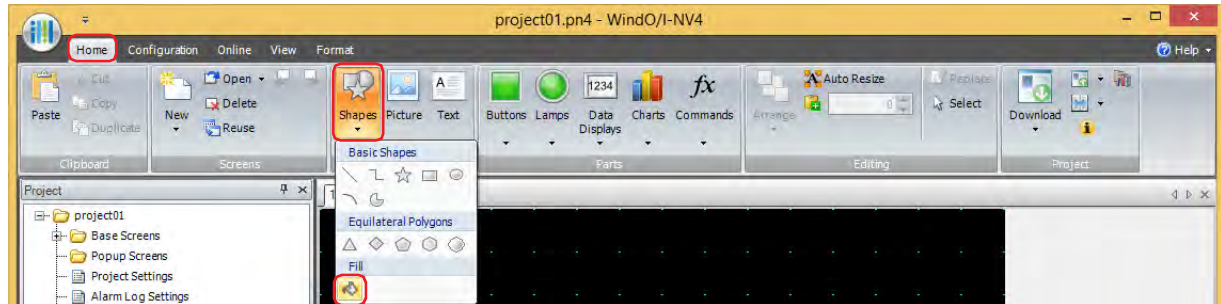

- 2 Click on a section where multiple shapes overlap on the edit screen.

The section where multiple shapes overlap is filled with the **Foreground Color**, **Background Color**, and **Pattern** of the shape last drawn or the shape that last had its style changed. The clicked location is the fill start point.

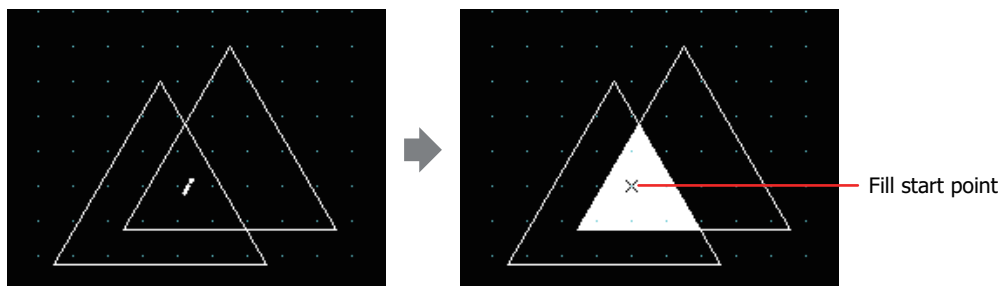

- To change the fill style, perform one of the following operations.
 - Double click the fill start point to open the Properties dialog box
 - Select the fill start point and select the style with **Shape Style** on the **Format** tab
 - Select the fill start point and open the right click menu
- If you move the fill start point, the closed region where it was moved to is filled.

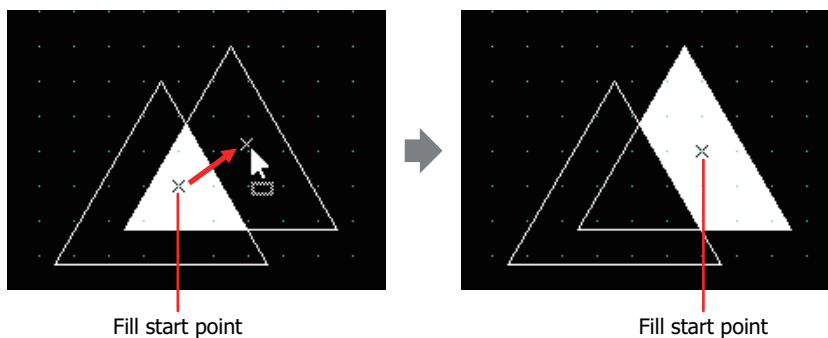

- To select the fill start point, click **X** on the edit screen or select **Fill** on the **Object List** window.

● Properties of Fill Dialog Box

This section describes items and buttons in the Properties dialog box.

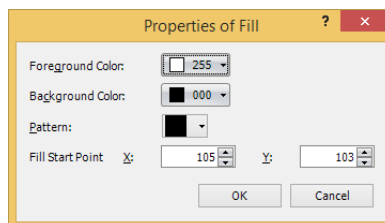

■ Foreground Color, Background Color

Selects the foreground color and the background color to fill with (color: 256 colors, monochrome: 16 shades). Click either button to display the Color Palette. Select a color from the Color Palette.

■ Pattern

Selects the pattern to fill with.

Click this button to display the Pattern Palette. Select a pattern from the Pattern Palette.

■ Fill Start Point

X, Y: Specifies the display position of the fill start point in coordinates. The upper-left corner of the screen is the origin.

X: 0 to (base screen horizontal size - 1)

Y: 0 to (base screen vertical size - 1)

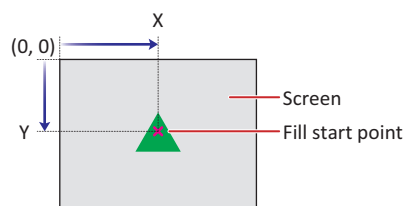

The fill range is not affected by drawing objects placed on the top layer.

2 Picture

HG2J-7U HG5G-V HG4G-V HG4G HG3G-V HG3G HG2G-V HG2G-5F HG2G-5T HG1G HG1P

2.1 Picture Configuration Procedure

This section describes the picture configuration procedure.

- 1 On the **Home** tab, in the **Drawings** group, click **Picture**.

The mouse cursor changes to  (picture).

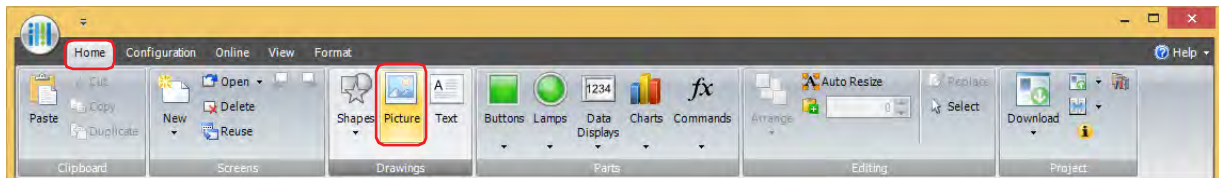

- 2 Click the location on the edit screen to place the picture.

Picture Manager is displayed.

- 3 Select a picture and click **Select**.

The selected picture is placed on the screen.

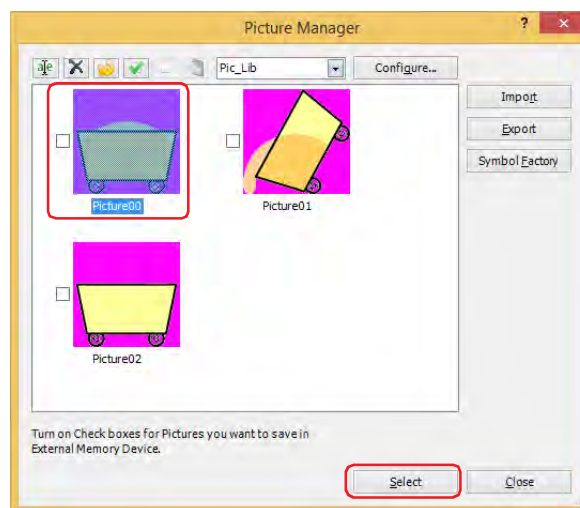

To change the picture that was placed on the screen, perform one of the following operations.

- Double click the picture to open the Properties dialog box, then click **Browse**
- Replace the picture in Picture Manager

2.2 Properties of Picture Dialog Box

This section describes items and buttons in the Properties dialog box.

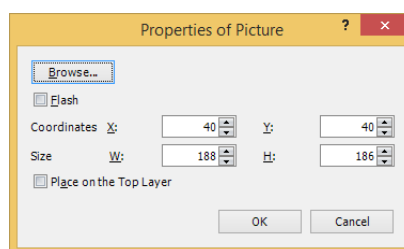

■ Browse

Changes the picture placed on the screen. Click this button to display Picture Manager.

■ Flash

Select this check box to make the picture flash.

The flash interval is specified with **Flashing Cycle** on the **System** tab in the **Project Settings** dialog box.

■ Coordinates

X, Y: Specifies the display position of the picture in coordinates.

With the upper-left corner of the screen as the origin, the upper-left corner of the rectangle that circumscribes the picture is the X and Y coordinates.

X: 0 to (base screen horizontal size - 1)

Y: 0 to (base screen vertical size - 1)

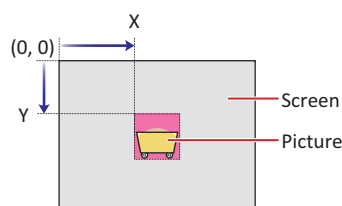

■ Size

W, H: Specifies the size of the picture in width and height.

W: 1 to (base screen horizontal size)

H: 1 to (base screen vertical size)

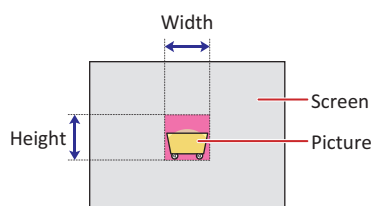

■ Place on the Top Layer

Select this check box to display the picture on the top layer. The picture will have precedence when other drawings and parts are overlapping with it. For details, refer to Chapter 6 "4 Drawings and Parts Overlapping" on page 6-5.

3 Text

HG2J-7U HG5G-V HG4G-V HG4G HG3G-V HG3G HG2G-V HG2G-5F HG2G-5T HG1G HG1P

3.1 Text Configuration Procedure

This section describes the configuration procedure for text.

- 1 On the **Home** tab, in the **Drawings** group, click **Text**.

The mouse cursor changes to ^+A (text).

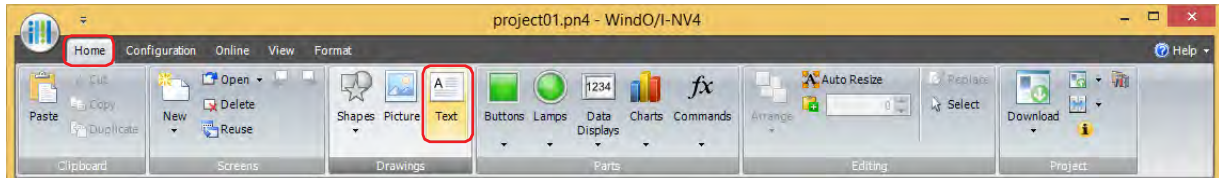

- 2 Click the location on the edit screen to place the text.
The Properties of Text dialog box is displayed.
- 3 Enter the text to display in **Text** and configure the options as necessary.
The maximum number is 3750 characters.

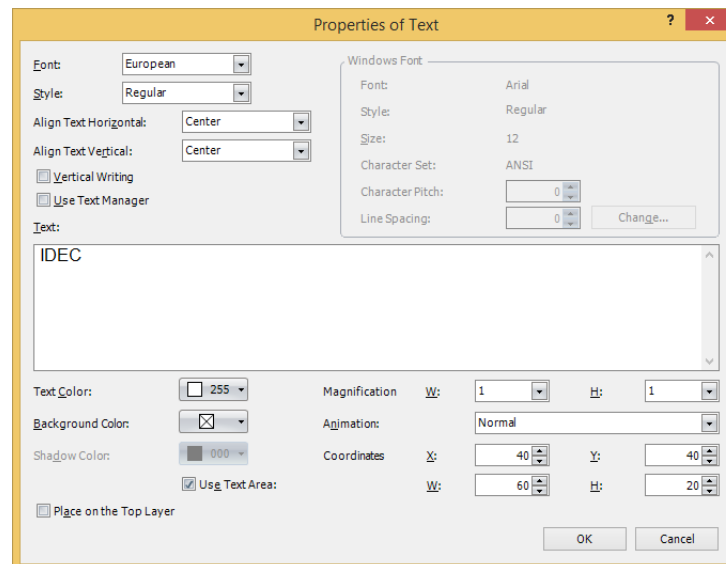

- 4 Click **OK**.

The text is placed on the screen.



To change the style of the text placed on the screen, perform one of the following operations. You can change the entered text in the Properties dialog box.

- Double click the text to open the Properties dialog box
- Select the text and select the style with **Text Style** on the **Format** tab
- Select the text and open the right click menu

3.2 Properties of Text Dialog Box

This section describes items and buttons in the Properties dialog box.

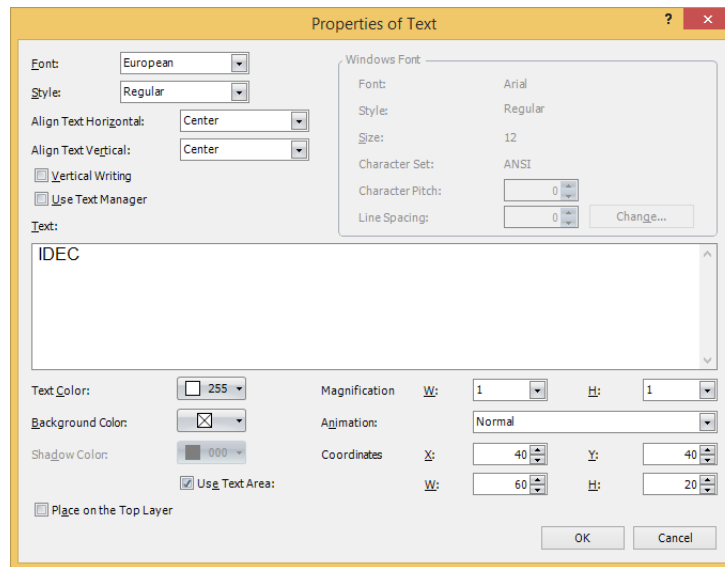

- **Font**

Selects the font to use to display text from the following.

Western, Japanese, Simplified Chinese, Traditional Chinese, Hangul, Central European, Baltic, Cyrillic, Windows, Stroke*1

This option can only be configured if the **Use Text Manager** check box is cleared.

- **Style***1

Selects the style of text from the following.

Regular, Bold, Shadow

This option can only be configured when **Western, Japanese, Simplified Chinese, Traditional Chinese, Hangul, Central European, Baltic, Cyrillic** is selected for **Font**.

- **Align Text Horizontal**

Selects text alignment in the horizontal direction.

Left, Center, Right, Center-Left

For details, refer to Appendix "5 Text Alignment" on page A-7.

- **Align Text Vertical**

Selects text alignment in the vertical direction.

Top, Center, Bottom

Top when the **Vertical Writing** check box is selected.

For details, refer to Appendix "5 Text Alignment" on page A-7.

*1 HG5G/4G/3G/2G-V, HG4G/3G, HG2G-5F/-5T, HG1G/1P only

Vertical Writing

Select this check box to display text vertically.

This option can only be configured when **Western, Japanese, Simplified Chinese, Traditional Chinese, Hangul, Central European, Baltic, Cyrillic, Windows** is selected for **Font**.



When the **Vertical Writing** check box is selected, take care about the following points. This is applicable for installations of Windows that support East Asian characters.

- When there is a mixture of double-byte and single-byte characters, the half-width characters are left-aligned.

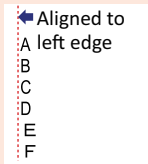

- Dashes are displayed horizontally. Symbols representing voiced and semi-voiced sounds of single-byte characters are shown as follows.

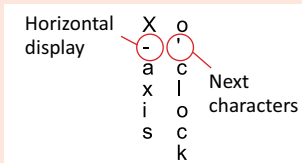

Windows Font

Configures the font to use as the Windows Font.

Select **Windows** for **Font** to display the current settings. You can specify the character spacing (0 to 100) and the line spacing (0 to 100). To change the settings other than the character spacing and line spacing, click **Change** to display the **Font Settings** dialog box.

This option can only be configured if the **Use Text Manager** check box is cleared.

For details, refer to Chapter 2 “Windows Font” on page 2-13.

Use Text Manager

Select this check box to use text registered in Text Manager.

Text ID

Specifies the Text Manager ID number (1 to 32000) when using text registered in Text Manager.

Click to display Text Manager.

This option can only be configured when the **Use Text Manager** check box is selected.

Text

Enter the text to display. The maximum number is 3750 characters.

The characters that can be entered vary based on the font selected by **Font**. For details, refer to Chapter 2 “1.2 Available Text” on page 2-6.

This option can only be configured if the **Use Text Manager** check box is cleared.



A newline is counted as two characters.

Text Color

Selects the color for the displayed text (color: 256 colors, monochrome: 16 shades).

Click this button to display the Color Palette. Select a color from the Color Palette.

Size

Specifies the text size to be displayed. The fonts and sizes that can be set vary based on the model.

Model	Font	Size
HG2J-7U	Western, Japanese, Simplified Chinese, Traditional Chinese, Hangul, Central European, Baltic, Cyrillic	8 to 512
HG5G/4G/3G/2G-V, HG4G/3G, HG2G-5F/-5T, HG1G/1P	Stroke	8 to 128

■ Magnification *1

W, H: Selects the zoom factor for characters (0.5, 1 to 8).

This option can only be configured when **Western, Japanese, Simplified Chinese, Traditional Chinese, Hangul, Central European, Baltic, Cyrillic** is selected for **Font**.

■ Background Color

Selects the background color for the text (color: 256 colors, monochrome: 16 shades).

Click this button to display the Color Palette. Select a color from the Color Palette.

■ Animation

Selects whether or not to make the text flash.

Normal: The text does not flash.

Flash: The text flashes.

■ Shadow Color *1

Selects the shadow color for the text (color: 256 colors, monochrome: 16 shades).

Click this button to display the Color Palette. Select a color from the Color Palette.

This option can only be configured when **Shadow** is selected for **Style**.

■ Coordinates

X, Y: Specifies the display position of the text or the text area in coordinates.

With the upper-left corner of the screen as the origin, the upper-left corner of the rectangle that circumscribes the text or the upper-left corner of the text area is the X and Y coordinates.

When the **Use Text Area** check box is cleared, the coordinates are for the text. When the **Use Text Area** check box is selected, the coordinates are for the text area.

X: 0 to (base screen horizontal size - 1)

Y: 0 to (base screen vertical size - 1)

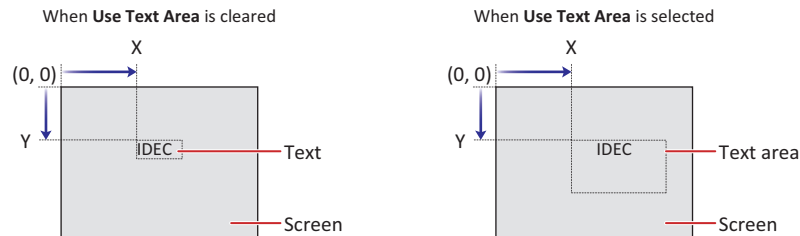

■ Use Text Area

Select this check box to specify a text area and adjust the display position of the text with the specified text area.

W, H: Specifies the size of the text area in width and height.

W: 5 to (base screen horizontal size)

H: 5 to (base screen vertical size)

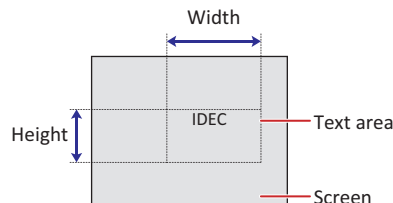

■ Place on the Top Layer

Select this check box to display the text on the top layer. The text will have precedence when other drawings and parts are overlapping with it. For details, refer to Chapter 6 "4 Drawings and Parts Overlapping" on page 6-5.

*1 HG5G/4G/3G/2G-V, HG4G/3G, HG2G-5F/-5T, HG1G/1P only

Chapter 8 Buttons

This chapter describes the setup for the button parts and related MICRO/I operations.

1 Bit Button

HG2J-7U HG5G-V HG4G-V HG4G HG3G-V HG3G HG2G-V HG2G-5F HG2G-5T HG1G HG1P

1.1 How the Bit Button is Used

Writes a 0 or 1 to a bit device.

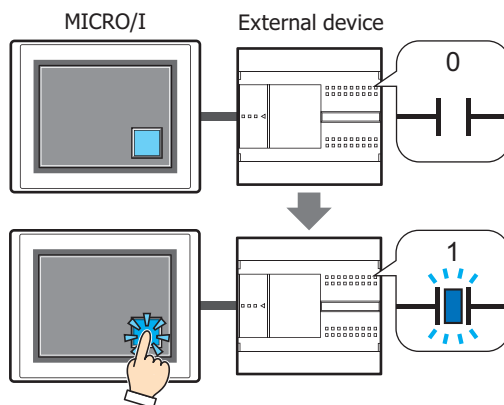

■ Set

Pressing the button writes a 1 to the bit device.

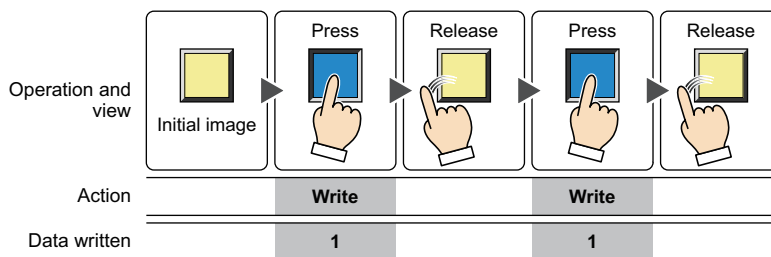

■ Reset

Pressing the button writes a 0 to the bit device.

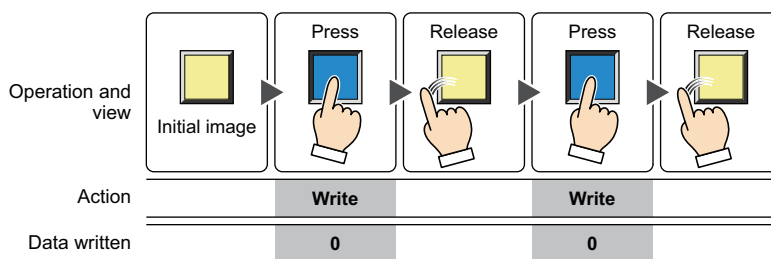

■ **Momentary**

Pressing the button writes a 1 to the bit device.
 Releasing the button writes a 0 to the bit device.

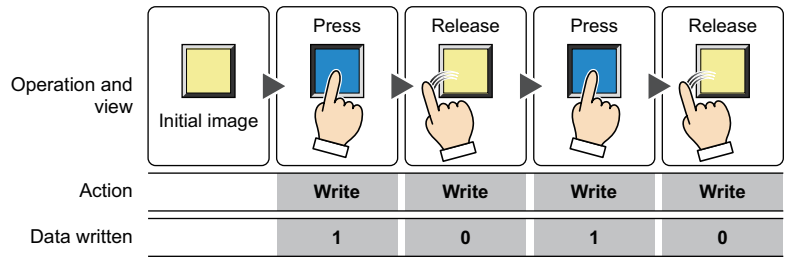

Pressing and holding the button until the screen changes causes a 0 to be written to the bit device.

■ **Alternate**

Each press of the button alternately writes a 1 or 0 to the bit device.

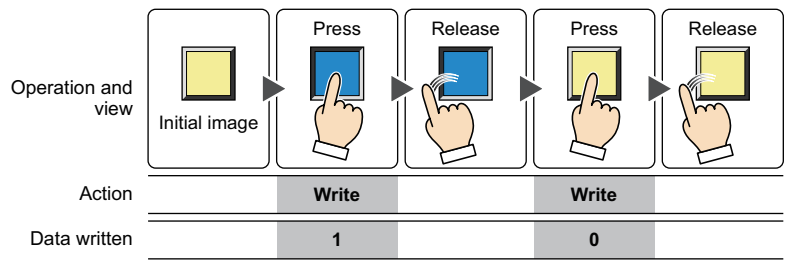

■ **Toggle**

Pressing the button inverts the value of the bit device.
 If the value of the bit device is 0 it changes to 1, and vice versa.

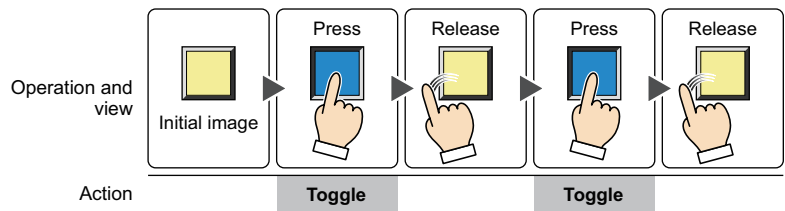

■ **Move**

Pressing the button writes the value in the source bit device to the value in the destination bit device.

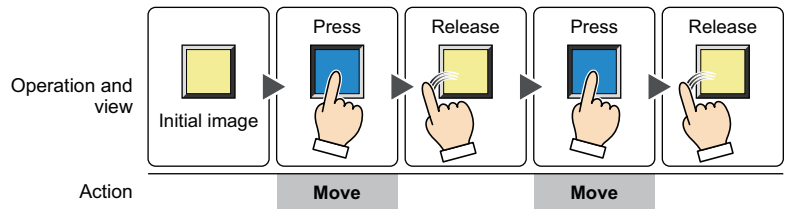

1.2 Bit Button Configuration Procedure

This section describes the configuration procedure for Bit Buttons.

- 1 On the **Home** tab, in the **Parts** group, click **Buttons**, and then click **Bit Button**.

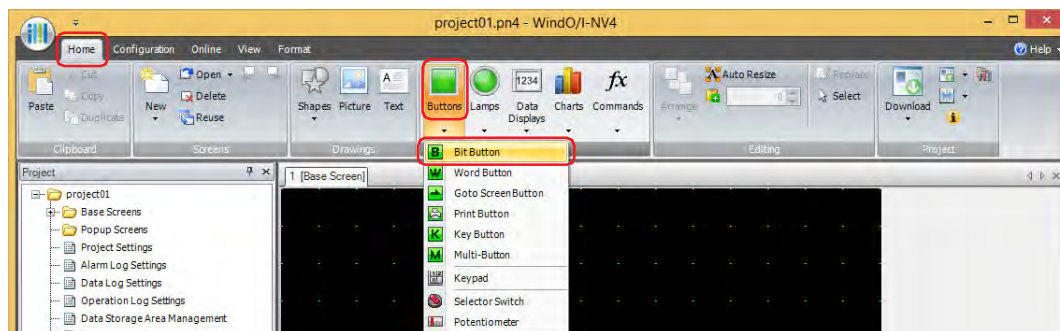

- 2 Click a point on the edit screen where you wish to place the Bit Button.
- 3 Double-click the placed Bit Button and a Properties dialog box will be displayed.
- 4 Change the settings on each tab as necessary.

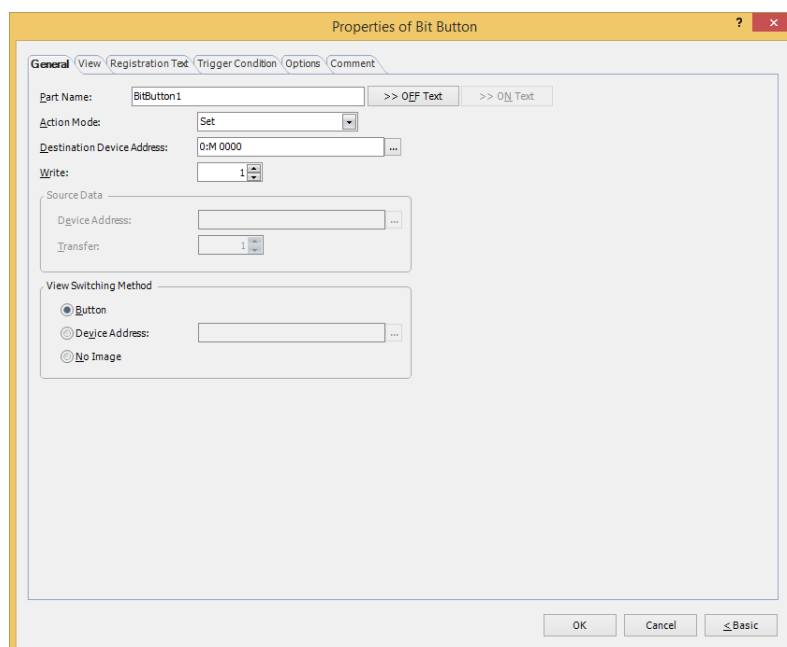

The **Trigger Condition** tab and **Options** tab only appear in Advanced mode.



You can set the default for the Bit Button on the **Default Preferences** tab of the **WindO/I-NV4 Options** dialog box. For details, refer to Chapter 2 "Default Preferences Tab" on page 2-63.

1.3 Properties of Bit Button Dialog Box

This section describes items and buttons in the Properties dialog box.

● General Tab

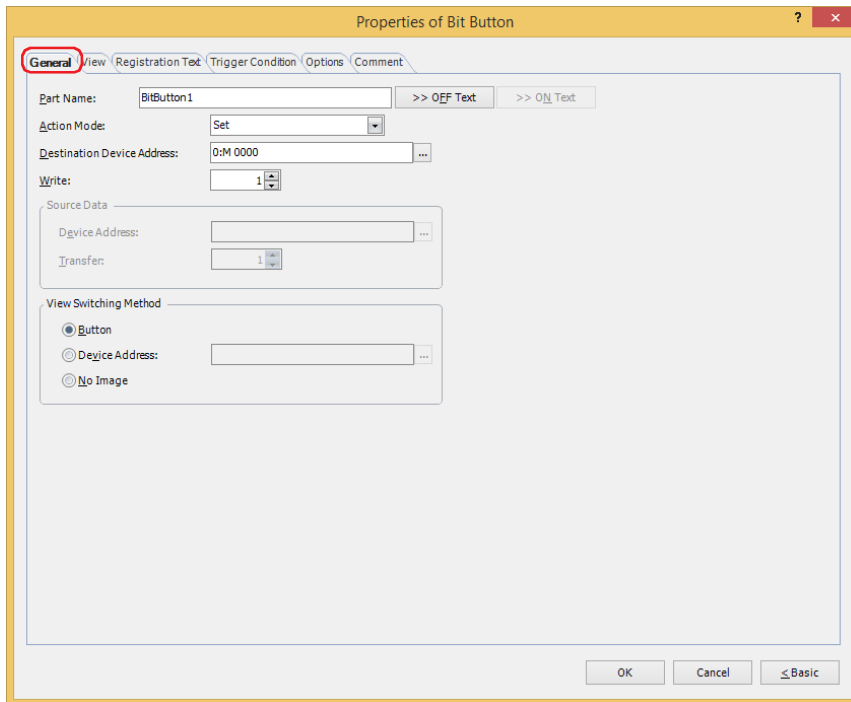

■ Part Name

Enter a name for the part. The maximum number is 20 characters.

■ >>OFF Text, >>ON Text

Applies the text entered in the **Part Name** field to the **Text** field under the **OFF** or **ON** fields on the **Registration Text** tab. This is used as the Registration Text when the button is OFF or ON.



To specify the Registration Text to use when the button is ON, select the **Set by State** check box on the **Registration Text** tab. If left unchecked, the same Registration Text assigned for the OFF state is displayed for the ON state as well.

■ Action Mode

Select the behavior of the button from the following:

Set: Pressing the button writes a 1 to the bit device.

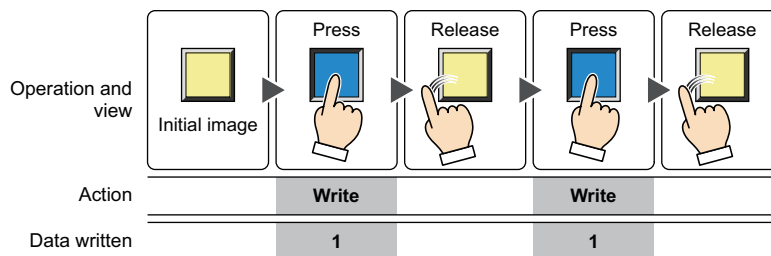

Reset: Pressing the button writes a 0 to the bit device.

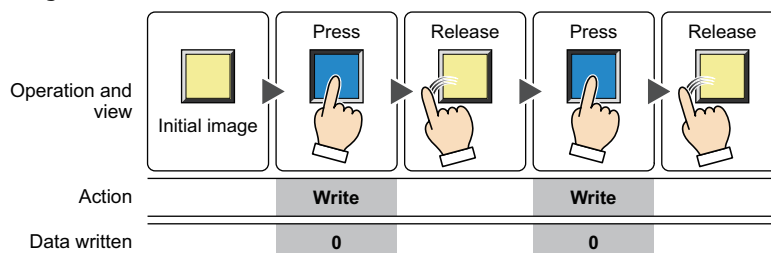

Momentary: Pressing the button writes a 1 to the bit device.
 Releasing the button writes a 0 to the bit device.

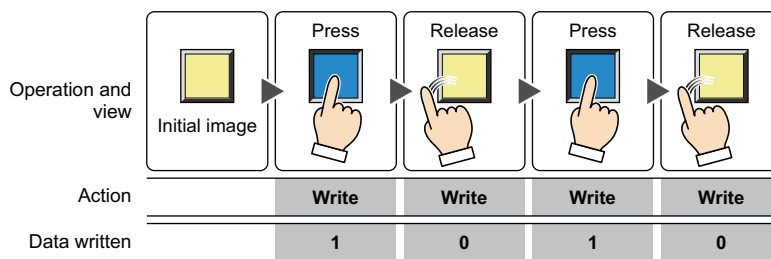

Pressing and holding the button until the screen changes causes a 0 to be written to the bit device.

Alternate: Each press of the button alternately writes a 1 or 0 to the bit device.

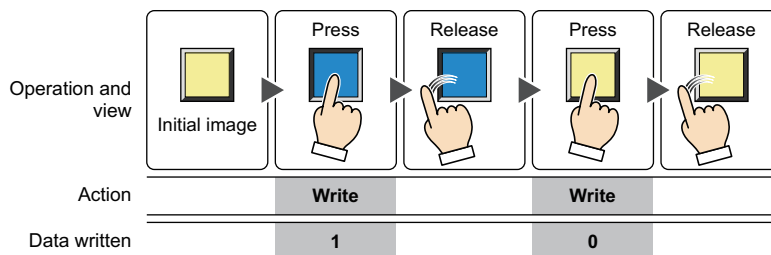

Toggle: Pressing the button inverts the value of the bit device.
 If the value of the bit device is 0 it changes to 1, and vice versa.

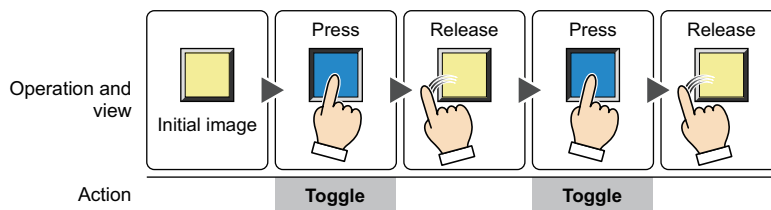

Move: Pressing the button writes the value in the source bit device to the value in the destination bit device.

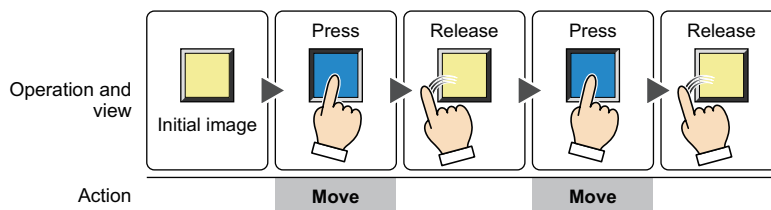

Destination Device Address

Specify the destination bit device.

Click to display the Tag Editor. For the device address configuration procedure, refer to Chapter 2 "5.1 Device Address Settings" on page 2-70.

■ **Write** *1

Specify the number of bit devices (1 to 64) at the destination.

This setting is enabled only if **Action Mode** is set to **Set** or **Reset**.

Example: This fills a contiguous block of bit devices with the same value.

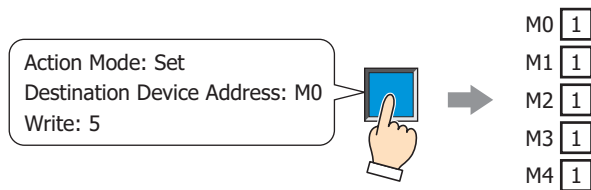

If the bit number in a word device is specified, the same value is written to same bit number of contiguous word devices.

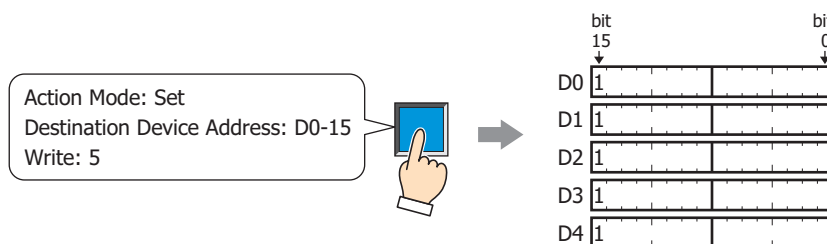

■ **Source Data**

Specifies the device address that stores the data to be written.

This setting is enabled only if **Action Mode** is set to **Move**.

Device Address: Specify the source bit device.

Click **...** to display the Tag Editor. For the device address configuration procedure, refer to Chapter 2 "5.1 Device Address Settings" on page 2-70.

Transfer: Specify the number of bit devices (1 to 64) to transfer.

Example: This button writes the values in a contiguous block of bit devices to a contiguous block of device addresses at the destination.

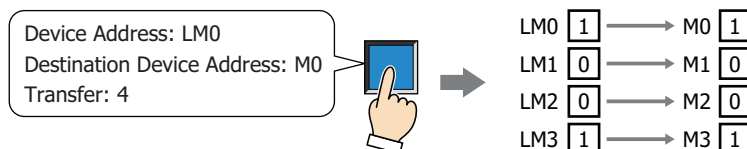

*1 Advanced mode only

■ View Switching Method*1

Select how to display the ON/OFF status of the button.

Button: Pressing the button changes the drawing object displayed.

Device Address: The drawing objects assigned to the OFF and ON states are displayed when the value of the device address is 0 and 1, respectively. Specifies the device address used to switch the drawing object display.

Click  to display the Tag Editor. For the device address configuration procedure, refer to Chapter 2 "5.1 Device Address Settings" on page 2-70.

No Image: The button is not displayed on the screen. The button appears as a dashed line frame on the edit screen. Pressing the corresponding area on the MICRO/I activates the assigned function. If **No Image** is selected, the settings for **View** and **Registration Text** are disabled.



Selecting **Device Address** in **View Switching Method** allows you to create an illuminated pushbutton.

The illuminated pushbutton switches state (or image) according to ON or OFF state of the device address, allowing you to display the state of a device that is being operated.

Example: When you set an external device address 'M0' as **Device Address** in **View Switching Method**, if the value of M0 changes, the display image will switch according to the value of M0 even if the button is not pressed.

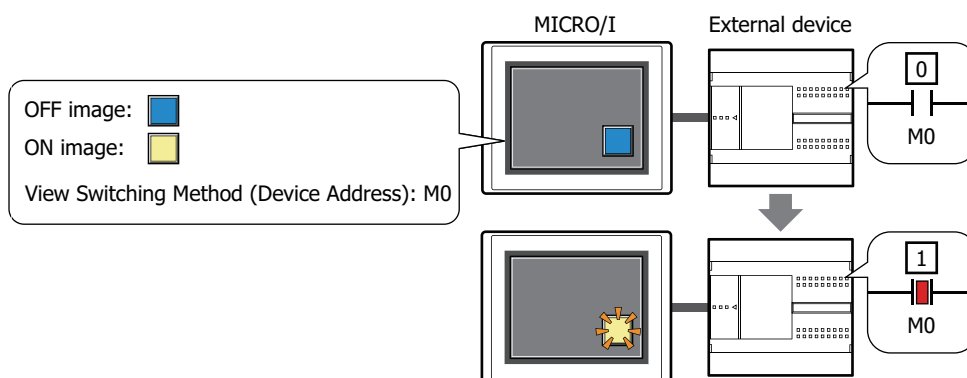

*1 Advanced mode only

● View Tab

Only **Coordinates** and **Size** can be configured when **No Image** is selected for **View Switching Method** on the **General** tab.

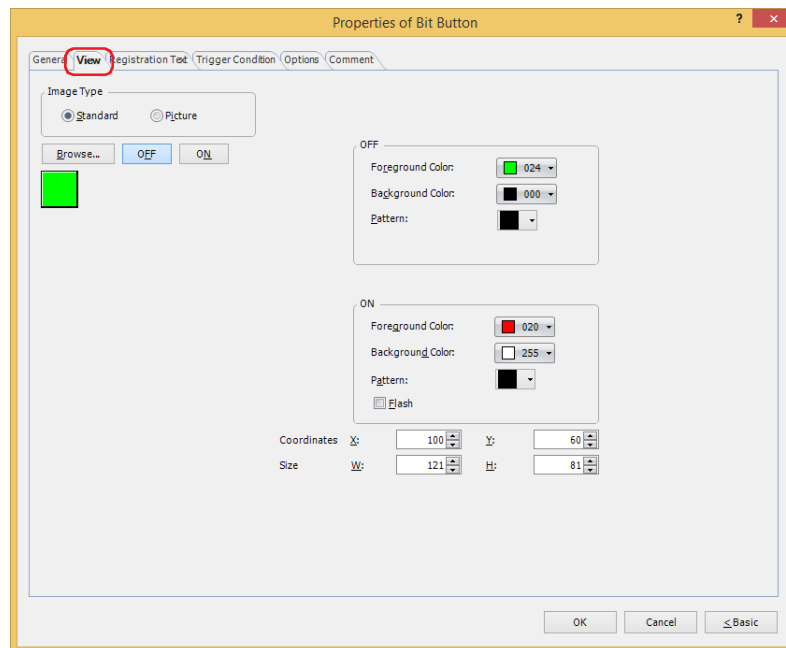

■ Image Type

Select the type of graphic to be used to represent the part.

Standard: Uses the default graphics contained within WindO/I-NV4.

Picture: Uses an image file saved in the Picture Manager.

For details about image file restrictions, refer to Chapter 2 "1.4 Available Image Files" on page 2-20.

■ Browse

Select the type of graphic to be used to represent the part from the list of graphics. Click this button to display the View Browser or Picture Manager, depending on the setting for **Image Type**.

■ OFF button, ON button

Displays the graphic when ON or OFF. Clicking **ON** or **OFF** switches the image displayed on the **View** tab.

■ OFF, ON

Selects the color and pattern of the standard graphic when ON and OFF.

Foreground Color, Background Color: Selects the foreground and background colors of the standard graphic (color: 256 colors, monochrome: 16 shades).

Click **Color** to display the Color Palette. Select a color from the Color Palette.

Pattern: Selects a pattern or tonal gradation for the standard graphic.

Click **Pattern** to display the Pattern Palette. Select a pattern or tonal gradation from the Pattern Palette.

■ Flash

Select this check box if flashing is desired (alternating ON and OFF) when a part is ON.

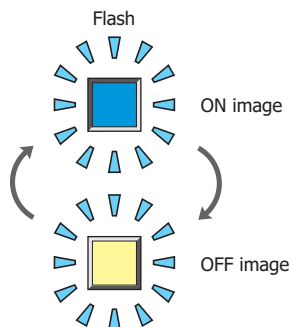

■ Coordinates

X, Y: Sets the display position of parts using coordinates.

The X and Y coordinates of parts are defined relative to an origin at the top-left corner of the screen.

X: 0 to (base screen horizontal size - 1)

Y: 0 to (base screen vertical size - 1)

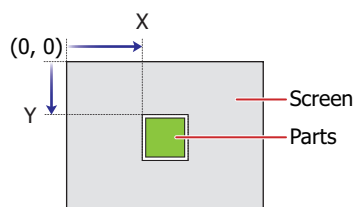

■ Size

W, H: Sets width and height to define the size of parts.

W: 20 to (base screen horizontal size)

H: 20 to (base screen vertical size)

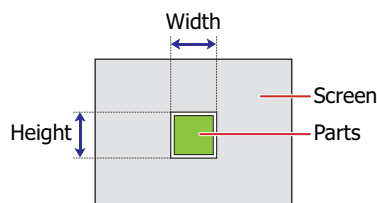

● Registration Text Tab

These options can only be configured when **Button** or **Device Address** is selected for **View Switching Method** on the **General** tab.

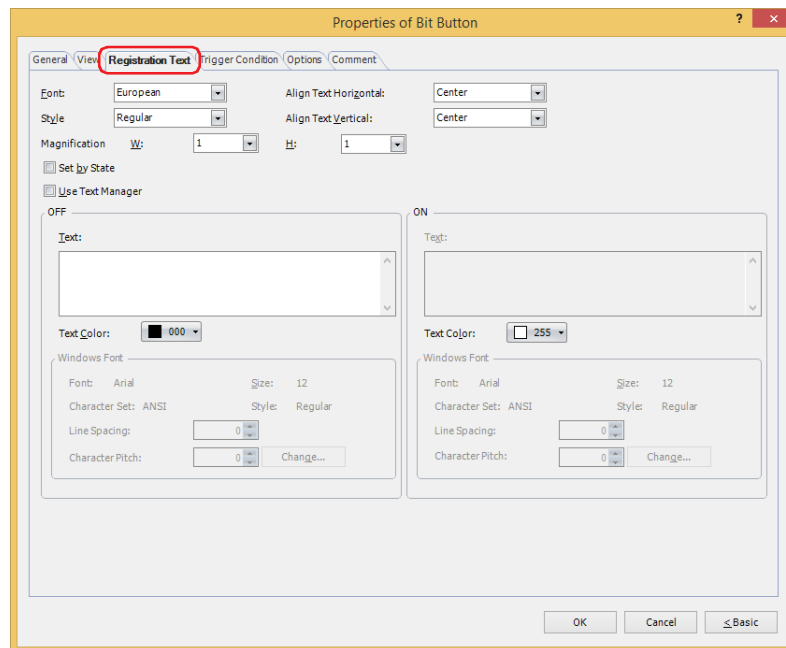

■ Font

Selects the font used for displaying text from the following.

Western, Japanese, Simplified Chinese, Traditional Chinese, Hangul, Central European, Baltic, Cyrillic, Windows, Stroke*1

Can only be set when the **Use Text Manager** check box is cleared.

The characters that can be displayed depend on the font. For details, refer to Chapter 2 "1.2 Available Text" on page 2-6.

■ Style*1

Selects **Regular** or **Bold** for text style.

Can only be set when **Font** is set to **Western, Japanese, Simplified Chinese, Traditional Chinese, Hangul, Central European, Baltic, Cyrillic**.

■ Size

Specifies the text size to be displayed. The fonts and sizes that can be set vary based on the model.

Model	Font	Size
HG2J-7U	Western, Japanese, Simplified Chinese, Traditional Chinese, Hangul, Central European, Baltic, Cyrillic	8 to 512
HG5G/4G/3G/2G-V, HG4G/3G, HG2G-5F/-5T, HG1G/1P	Stroke	8 to 128

■ Magnification*1

W, H: Selects the magnification (0.5, 1 to 8) for text display.

Can only be set when **Font** is set to **Western, Japanese, Simplified Chinese, Traditional Chinese, Hangul, Central European, Baltic, Cyrillic**.

■ Align Text Horizontal

Selects text alignment in the horizontal direction.

Left, Center, Right, Center-Left

For details, refer to Appendix "5 Text Alignment" on page A-7.

*1 HG5G/4G/3G/2G-V, HG4G/3G, HG2G-5F/-5T, HG1G/1P only

■ **Align Text Vertical**

Selects text alignment in the vertical direction.

Top, Center, Bottom

This option can only be configured when **Left, Center, or Right** is selected for **Align Text Horizontal**. If **Center-Left** is selected for **Align Text Horizontal, Center-Top** is set as this option.

For details, refer to Appendix "5 Text Alignment" on page A-7.

■ **Set by State**

Select this check box if displaying different text when ON and OFF.

■ **Use Text Manager**

Select this check box if using the text registered in Text Manager for text display.

■ **OFF, ON**

- Text:** Inputs characters to be displayed on parts. The maximum number is 3,750 characters. The characters that can be entered depend on the font selected using **Font**. For details, refer to Chapter 2 "1.2 Available Text" on page 2-6.
- Text ID:** Specifies the Text Manager ID No. (1 to 32000) when using the text registered in the Text Manager. Click  to display Text Manager. Can only be set when the **Use Text Manager** check box is selected.
- Text Color:** Selects the color of the text displayed on the part (color: 256 colors, monochrome: 16 shades). Click **Color** to display the Color Palette. Select a color from the Color Palette.
- Windows Font:** Sets the font to be used as the Windows Font. Select **Windows** using **Font** to display the current setting. You can specify the character spacing (0 to 100) and the line spacing (0 to 100). To change the settings other than the character spacing and line spacing, click **Change** to display the **Font Settings** dialog box. Can only be set when the **Use Text Manager** check box is cleared. For details, refer to Chapter 2 "Windows Font" on page 2-13.

● **Trigger Condition Tab**

The **Trigger Condition** tab is displayed in Advanced mode.

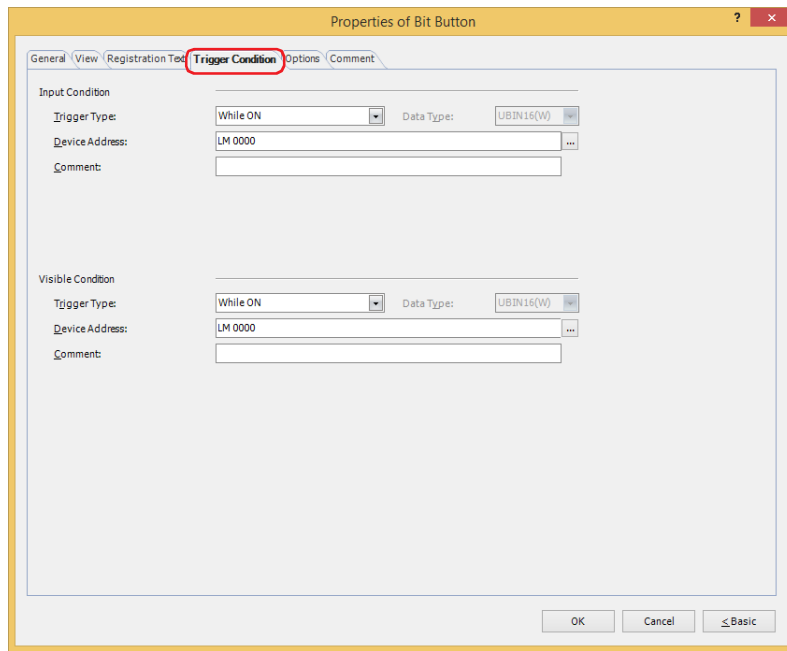

■ **Input Condition**

The Button is enabled and operational while the condition is satisfied. The Button is disabled and not operational while the condition is not satisfied.

Example: When **Trigger Type** is **While ON** and **Device Address** is **LM0**

While LM0 is 0, the condition is not satisfied and the Button is not operational.

While LM0 is 1, the condition is satisfied and the Button is operational.

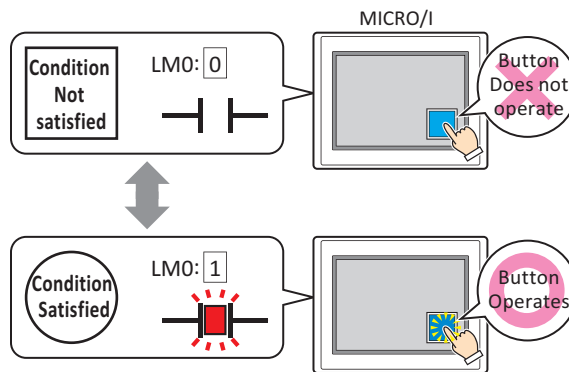

Trigger Type: Selects the condition to enable the Button from the following.

Always enable: The Button is always enabled.



While ON: Enables the Button when the value of device address is 1.

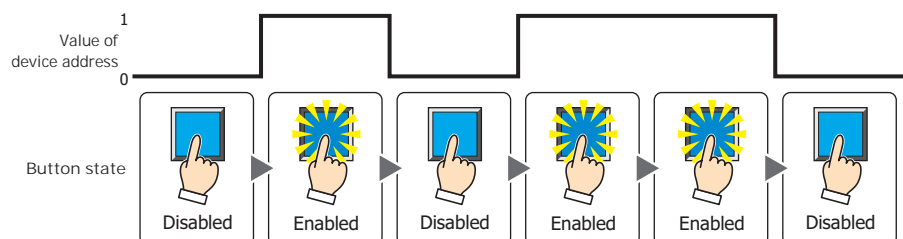

While OFF: Enables the Button when the value of device address is 0.

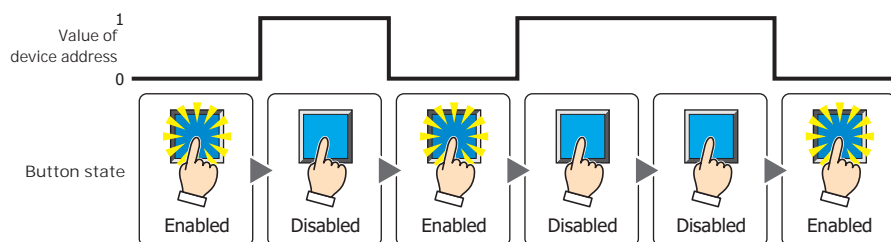

While satisfying the condition:

Enables the Button when the condition is satisfied.

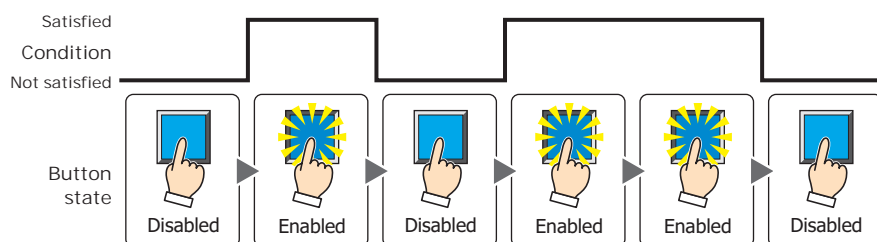

Data Type: Selects the type of data handled by the conditional expression for the input condition. This option can only be configured if **While satisfying the condition** is selected for **Trigger Type**. For details, refer to Chapter 2 "1.1 Available Data" on page 2-1.

Device Address: Specifies the bit device or the bit number of the word device to serve as the input condition. This option can only be configured when **While ON** or **While OFF** is selected for **Trigger Type**. Click to display the Tag Editor. For the device address configuration procedure, refer to Chapter 2 "5.1 Device Address Settings" on page 2-70.

Condition: Specifies the conditional expression for the input condition. This option can only be configured when **While satisfying the condition** is selected for **Trigger Type**.

Click to display the **Trigger Condition Settings** dialog box. For the conditional expression configuration procedure, refer to Chapter 2 "5.2 Setting Conditional Expressions" on page 2-73.

Comment: Used for entering a comment for the input condition. The maximum number is 80 characters.

■ Visible Condition

The Button is displayed while the condition is satisfied. The Button is hidden while the condition is not satisfied.

Example: When **Trigger Type** is **While ON** and **Device Address** is **LM0**
 While LM0 is 0, the condition is not satisfied and the Button is hidden.
 While LM0 is 1, the condition is satisfied and the Button is displayed.

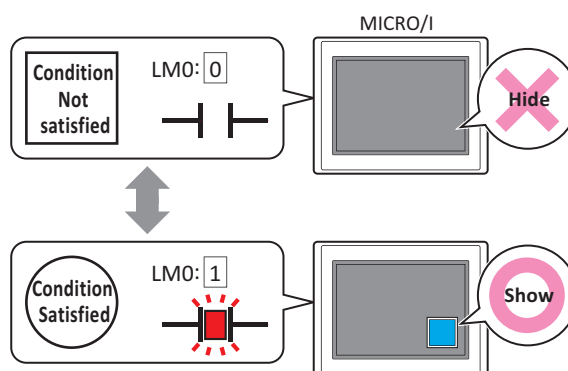

- When **Alternate** is selected for **Action Mode** on the **General** tab, the button remains on when hidden in the on state.
- When the **ON delay** check box is selected on the **Options** tab, if the button is hidden before the set time elapses from when the button begins to be pressed, the on delay is reset and the button does not operate.

Trigger Type: Selects the condition to display the Button from the following.

Always visible: The Button is always displayed.

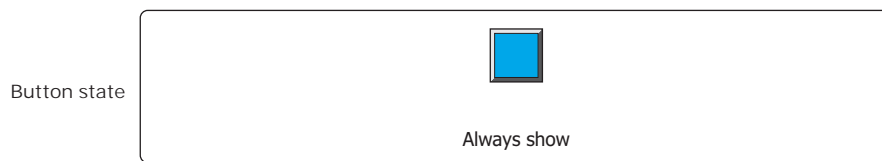

While ON: Displays the Button when the value of device address is 1.

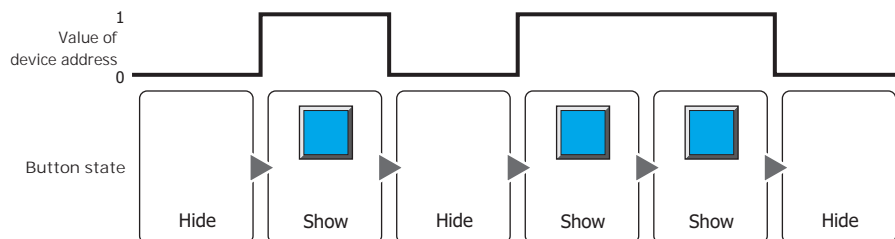

While OFF: Displays the Button when the value of device address is 0.

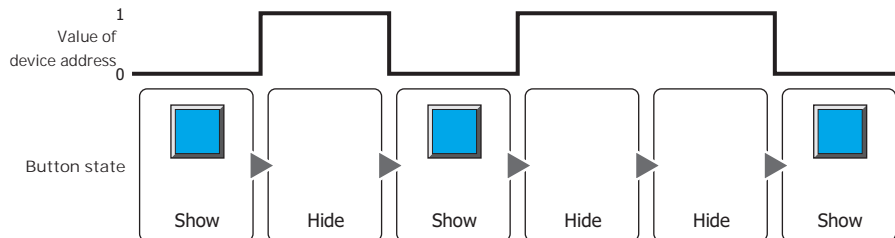

While satisfying the condition: Displays the Button when the condition is satisfied.

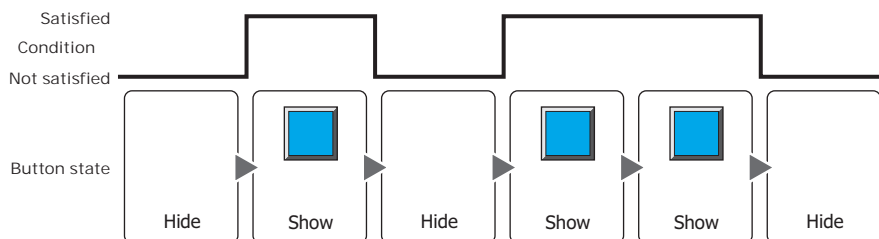

Data Type: Selects the type of data handled by the conditional expression for the visible condition. This option can only be configured if **While satisfying the condition** is selected for **Trigger Type**. For details, refer to Chapter 2 "1.1 Available Data" on page 2-1.

Device Address: Specifies the bit device or the bit number of the word device to serve as the visible condition. This option can only be configured when **While ON** or **While OFF** is selected for **Trigger Type**. Click to display the Tag Editor. For the device address configuration procedure, refer to Chapter 2 "5.1 Device Address Settings" on page 2-70.

Condition: Specifies the conditional expression for the visible condition. This option can only be configured when **While satisfying the condition** is selected for **Trigger Type**. Click to display the **Trigger Condition Settings** dialog box. For the conditional expression configuration procedure, refer to Chapter 2 "5.2 Setting Conditional Expressions" on page 2-73.

Comment: Used for entering a comment for the visible condition. The maximum number is 80 characters.

● Options Tab

The **Options** tab is displayed in Advanced mode.

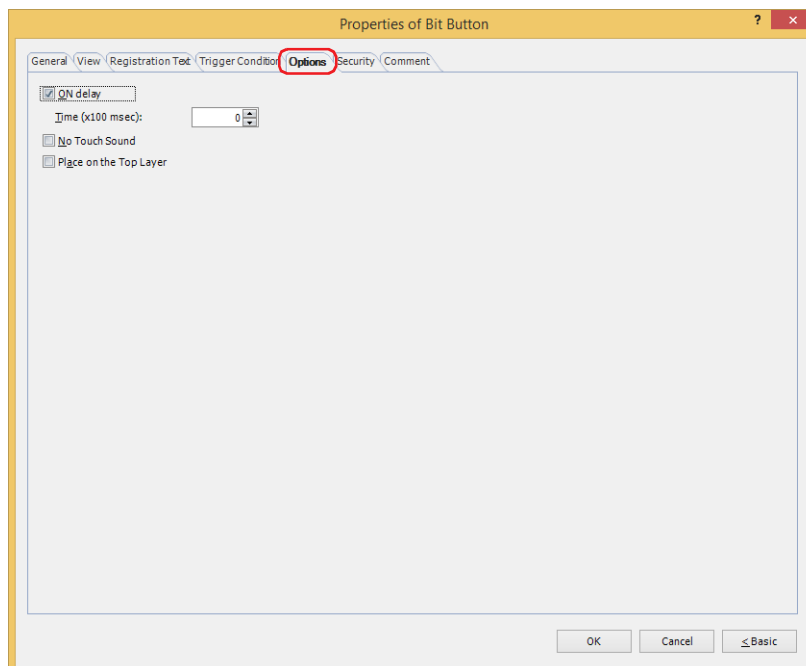

■ ON delay

Select this check box to use the ON delay function.

Time (x100 msec): Specify the length of time that the button must be held down before activation by selecting a value from 0 to 600 (units of 10 ms).
The button activates after it is held down for a specified period of time.

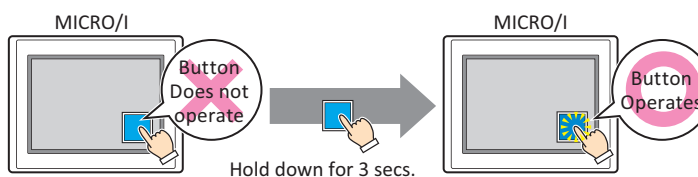

This feature protects against mistaken operation by ensuring that the button will not be activated if touched accidentally.

■ No Touch Sound

This function is to disable touch sounds only for specified parts when the MICRO/I makes touch sounds.

Select this check box to display disable touch sounds for this part.



To enable touch sounds on the MICRO/I, select the **Enable Touch Sound** check box under the **System** tab of the **Project Settings** dialog box.

■ Place on the Top Layer

Select this check box to display the parts on the top layer. The parts will have precedence when other drawings and parts are overlapping with it. For details, refer to Chapter 6 "4 Drawings and Parts Overlapping" on page 6-5.

● Security Tab

This tab is used to restrict displaying and using the part by security groups.

This option can only be set when **Use Security functions** is selected. The **Use Security functions** check box is set on **General** tab in the **Security** dialog box.

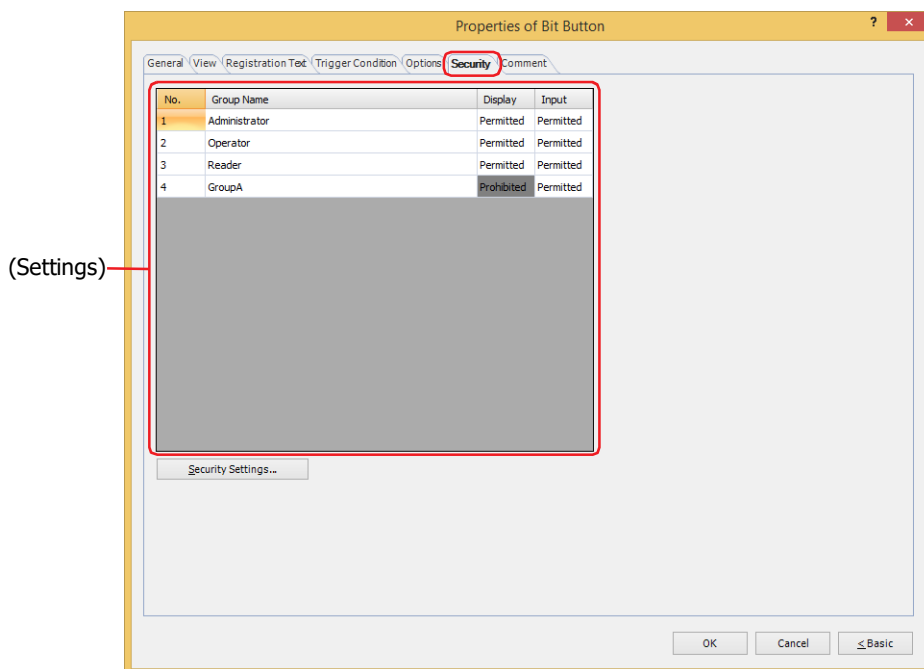

■ (Settings)

Displays the list of security groups used on the MICRO/I.

No.: Displays the security group numbers (1 to 15).

Group Name: Displays the name of the security group.

Display: Displays whether or not there is permission to display the part. Only **Permitted** security groups can display this part. If all security groups are set to **Permitted**, this part will be displayed even if no user account has been selected. Double clicking the cell switches between **Permitted** and **Prohibited**.

Input: Displays whether or not there is permission to use the part. Only **Permitted** security groups can use this part. If all security groups are set to **Permitted**, this part can be used even if no user account has been selected. Double clicking the cell switches between **Permitted** and **Prohibited**.



- You can also switch between **Permitted** and **Prohibited** by right-clicking on a **Display** or **Input** cell.
- Restricting the display and use of the part by switching between **Permitted** and **Prohibited** in **Display** and **Input** cells is similar to using the **Trigger Condition** tab.



■ Security Settings

The Security Settings dialog box is displayed. If you create a security group in the **Security Settings** dialog box, you can select that created group. For details, refer to Chapter 23 “2.2 Adding and Editing Security Groups” on page 23-19.



For details about security functions, refer to Chapter 23 “User Accounts and the Security Function” on page 23-1.

Example: If the user and security group for a part are set as follows:

User Name	 User1	 User2	 User3
Security Group	Reader	Operator	Administrator

Line Chart and Bar Chart

No.	Group Name	Display
1	Administrator	Permitted
2	Operator	Permitted
3	Reader	Prohibited

MICRO/I

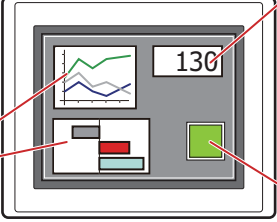

Numerical Display

No.	Group Name	Display
1	Administrator	Permitted
2	Operator	Permitted
3	Reader	Permitted

Button

No.	Group Name	Display	Input
1	Administrator	Permitted	Permitted
2	Operator	Permitted	Prohibited
3	Reader	Prohibited	Prohibited

For User1 in the **Reader** security group, the parts for which **Display** has been set to **Prohibited** for **Reader** will not be displayed.

If the password screen is opened and the user switches to User2 in the **Operator** security group, the parts for which **Display** has been set to **Permitted** for **Operator** will be displayed.

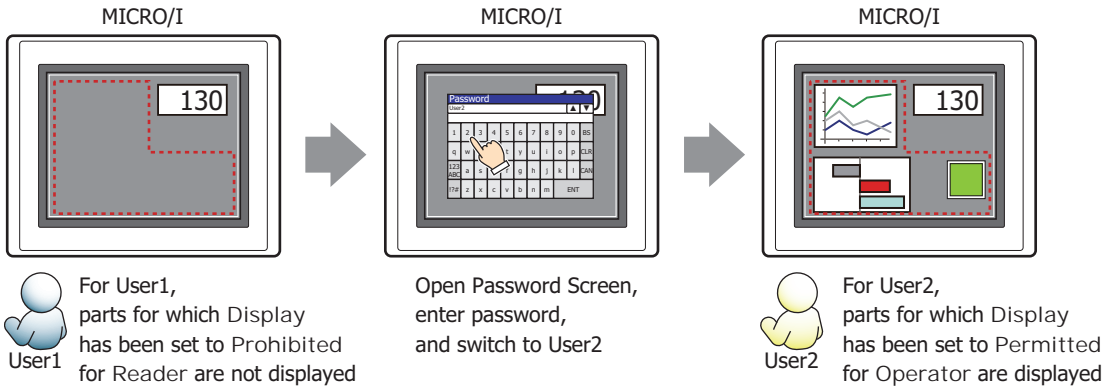

For User2 in **Operator**, **Display** has been set to **Permitted** for **Operator**, but **Input** is **Prohibited**, so the part cannot be used.

If the password screen is opened and the user switches to User3 in the **Administrator** security group, the parts for which **Display** has been set to **Permitted** for **Administrator** will be displayed, and the parts for which **Input** has been set to **Permitted** for **Administrator** can be used.

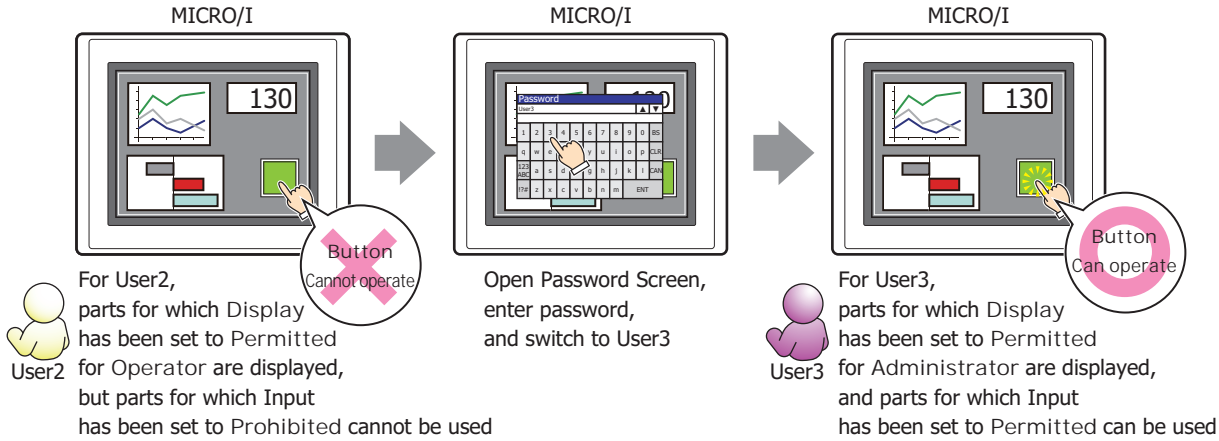

● Comment Tab

The **Comment** tab is used to specify the parts placed on the editing screen, and the popup text displayed when the mouse pointer is placed close to **No.**, **Name**, or **Type** in the object list.



When there are multiple parts of the same shape on the screen, this feature makes it possible to distinguish between the parts without displaying the Properties dialog box for each part, by just mousing over the part.

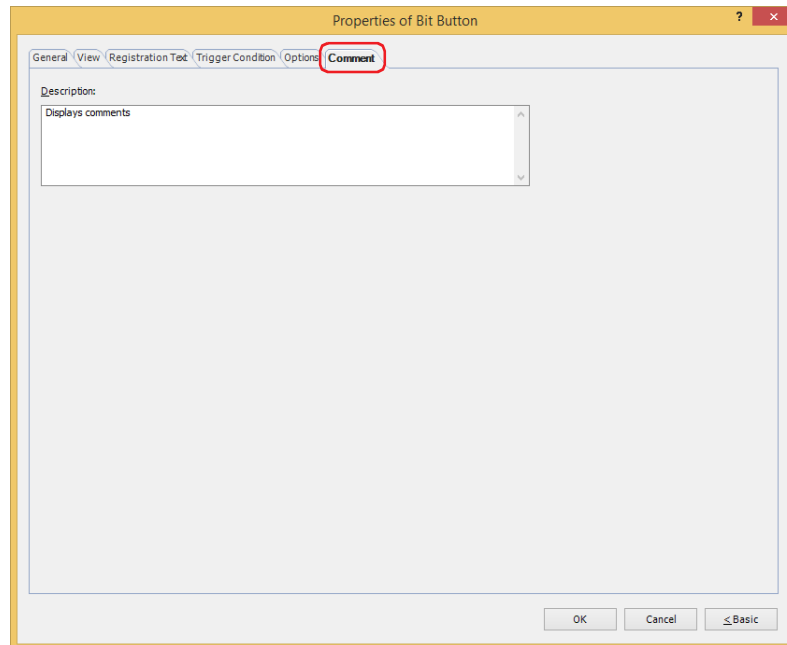

■ Description

Used for entering comments about parts. The maximum number is 80 characters.

Example: When mousing over the Button on the editing screen

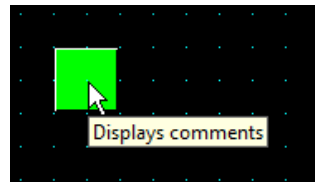

2 Word Button

HG2J-7U HG5G-V HG4G-V HG4G HG3G-V HG3G HG2G-V HG2G-5F HG2G-5T HG1G HG1P

2.1 How the Word Button is Used

Writes a value to a word device. Can be used to indirectly specify the destination address or to perform operations on the written value.

- Pressing the button writes a fixed value to a word device.

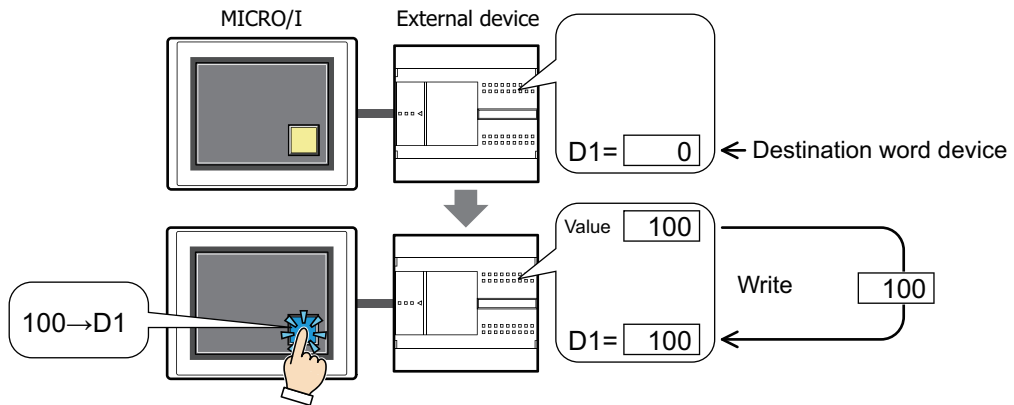

- Pressing the button writes the value of device address to a word device.

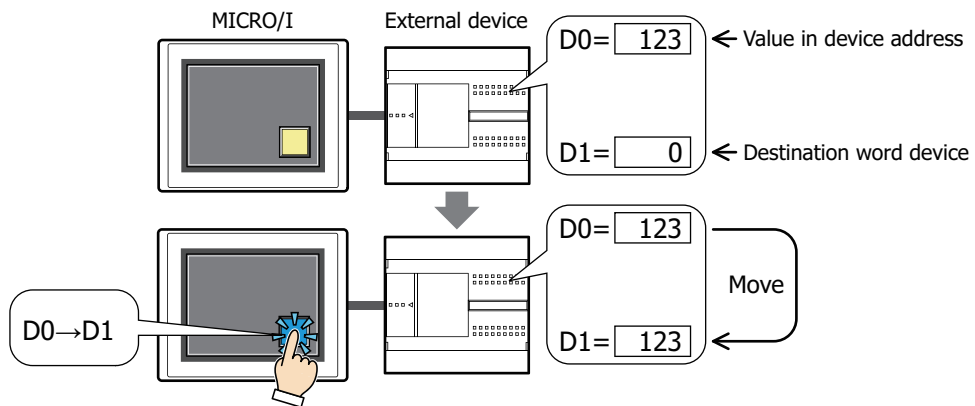

- Pressing the button performs arithmetic on the value to write before writing it to a word device.

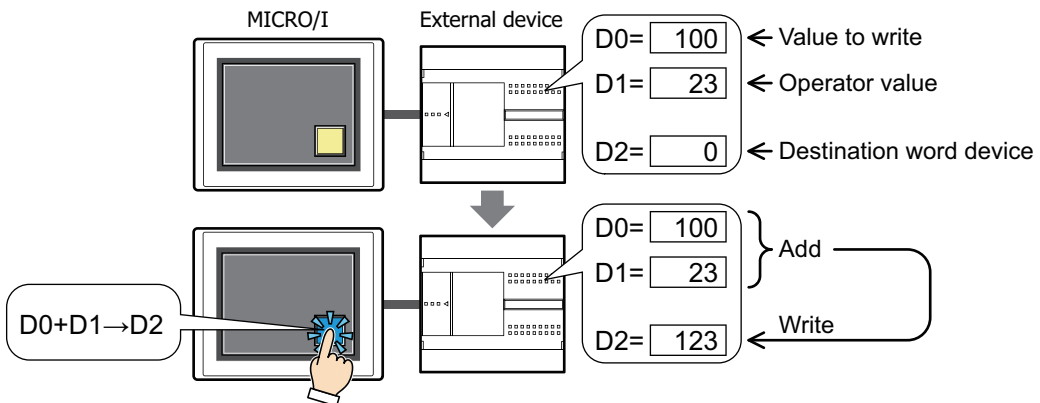

■ **Set**

Pressing the button writes a fixed value to a word device.

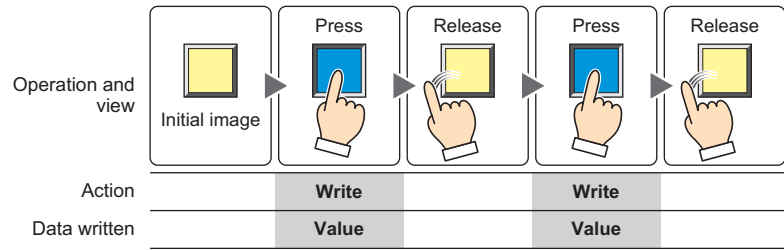

■ **Move**

Pressing the button writes the value of source device address to the destination word device.

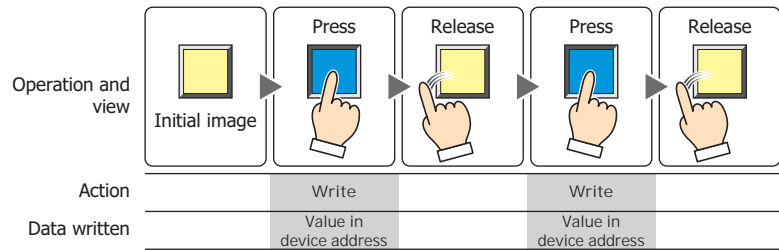

■ **Momentary**

Pressing the button writes the fixed value of ON Data to a word device.
Releasing the button writes the fixed value of OFF Data to a word device.

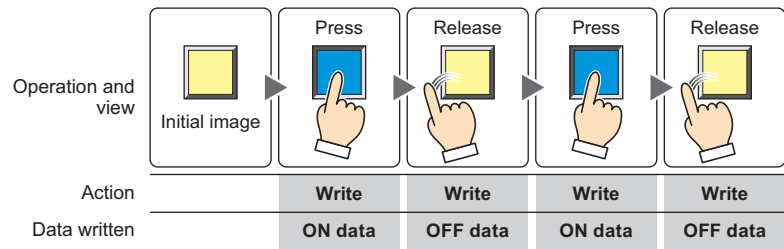

Pressing and holding the button until the screen changes causes the OFF data to be written to the word device.

■ **Alternate**

Each press of the button alternately writes the fixed value of ON data and OFF data to the word device.

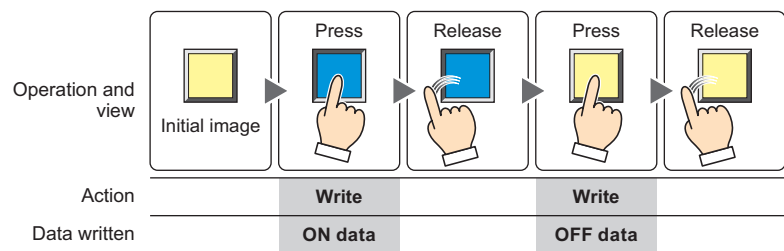

■ **Add, Sub, Multi, Div, Mod, OR, AND, XOR**

Pressing the button performs arithmetic on the value of source device address and a fixed value, or a value of device address and writes the result to a word device.

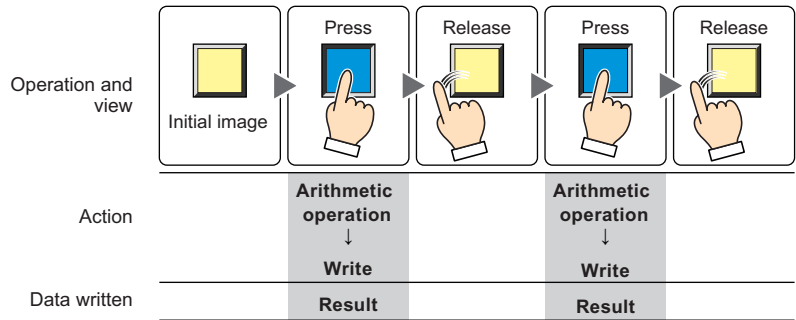

Example: Add (Addition)

Pressing the button adds the value in the **Source 1** to the **Source 2** value and writes the sum in the word device.

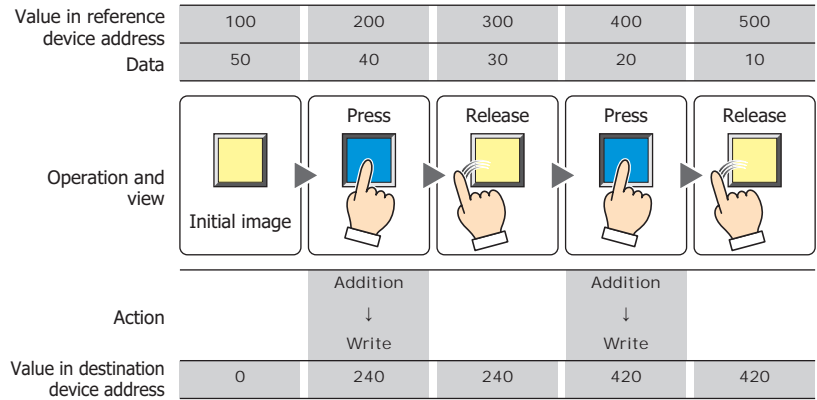

2.2 Word Button Configuration Procedure

This section describes the configuration procedure for Word Buttons.

- 1 On the **Home** tab, in the **Parts** group, click **Buttons**, and then click **Word Button**.

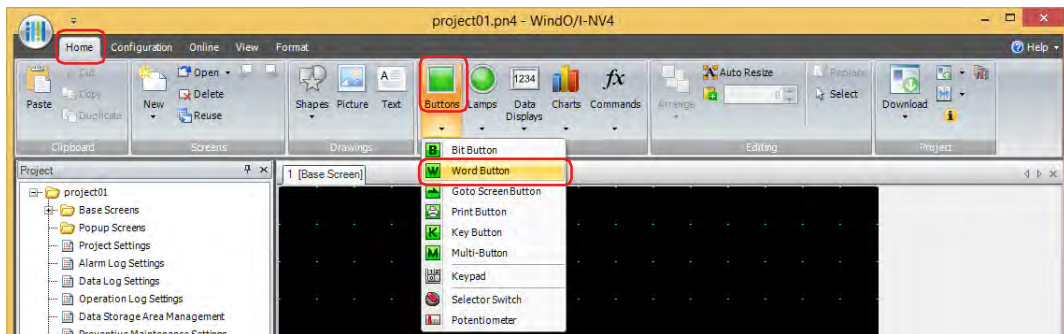

- 2 Click a point on the edit screen where you wish to place the Word Button.
- 3 Double-click the placed Word Button and a Properties dialog box will be displayed.
- 4 Change the settings on each tab as necessary.

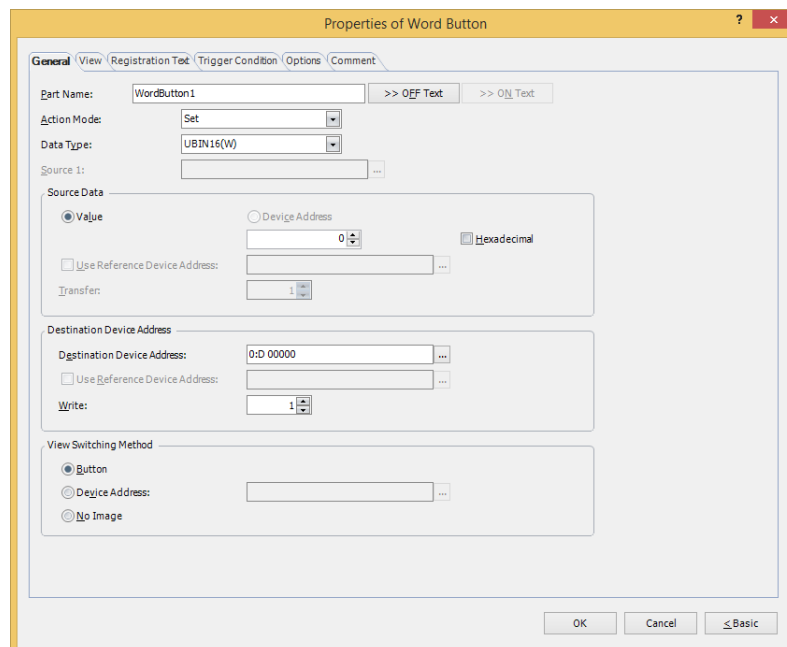

The **Trigger Condition** tab and **Options** tab only appear in Advanced mode.



You can set the default for the Word Button on the **Default Preferences** tab of the **WindO/I-NV4 Options** dialog box. For details, refer to Chapter 2 "Default Preferences Tab" on page 2-63.

2.3 Properties of Word Button Dialog Box

This section describes items and buttons in the Properties dialog box.

● General Tab

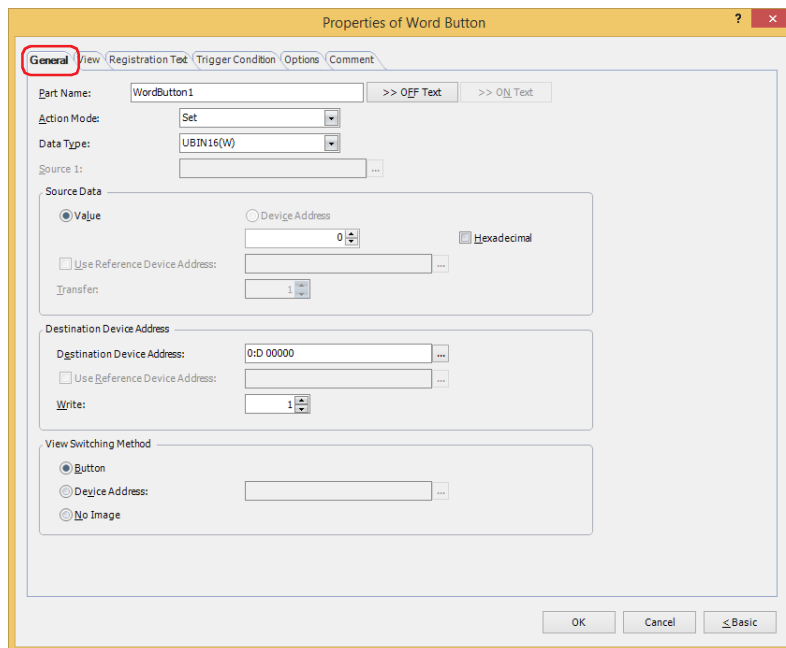

■ Part Name

Enter a name for the part. The maximum number is 20 characters.

■ >>OFF Text, >>ON Text

Applies the text entered in the **Part Name** field to the **Text** field under the **OFF** or **ON** fields on the **Registration Text** tab. This is used as the Registration Text when the button is OFF or ON.



To specify the Registration Text to use when the button is ON, select the **Set by State** check box on the **Registration Text** tab. If left unchecked, the same Registration Text assigned for the OFF state is displayed for the ON state as well.

■ Action Mode

Select the behavior of the button from the following:

Set: Pressing the button writes a constant value to a word device.

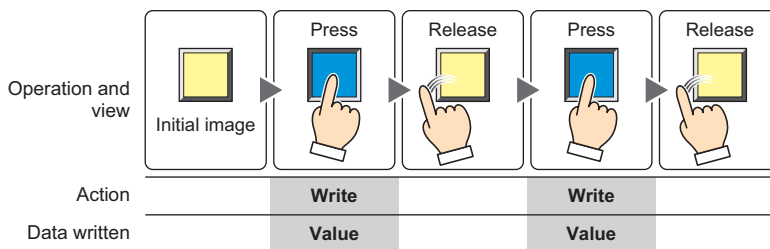

Move: Pressing the button writes the value in the source device address to the destination word device.

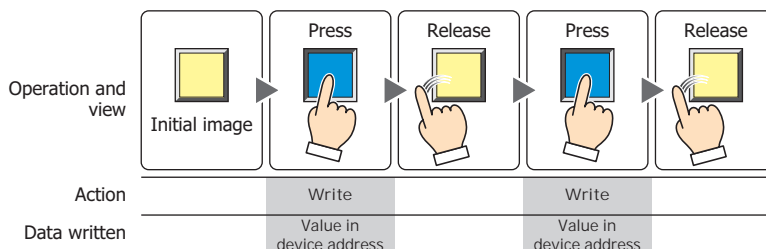

Momentary: Pressing the button writes the constant value of ON data to a word device.
 Releasing the button writes the constant value of OFF data to a word device.

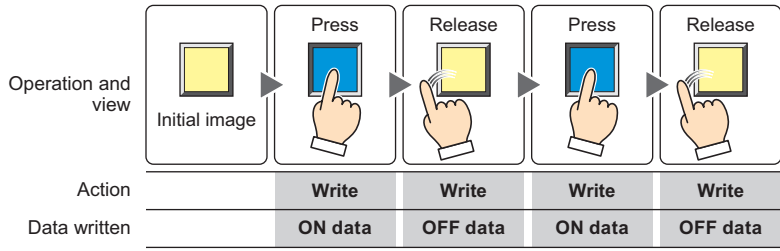

Pressing and holding the button until the screen changes causes the OFF data to be written to the word device.

Alternate: Each press of the button alternately writes the fixed value of ON data and OFF data to the word device.

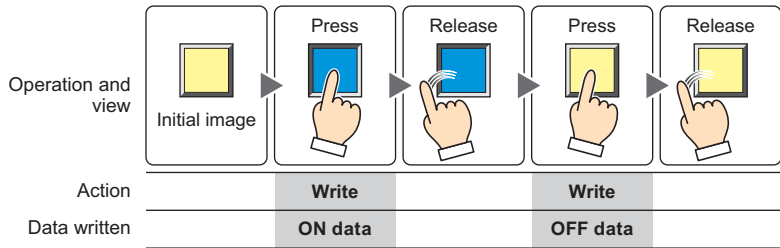

Add, Sub, Multi, Div, Mod, OR, AND, XOR:

Pressing the button performs arithmetic on a value of source device address and a constant value or the value of device address and writes the result to a word device.

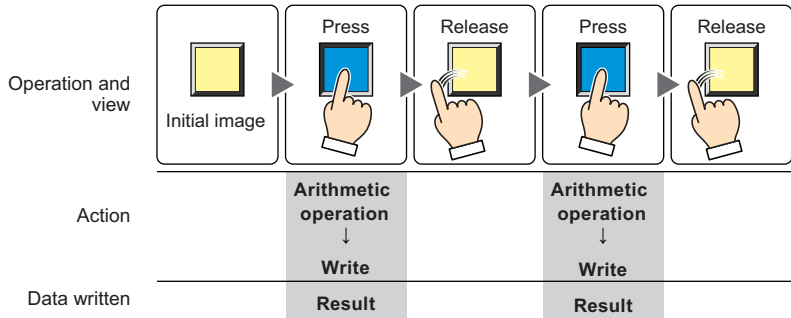

Example: Add (Addition)

Pressing the button adds the value in the **Source 1** to the **Source 2** value and writes the sum in the word device.

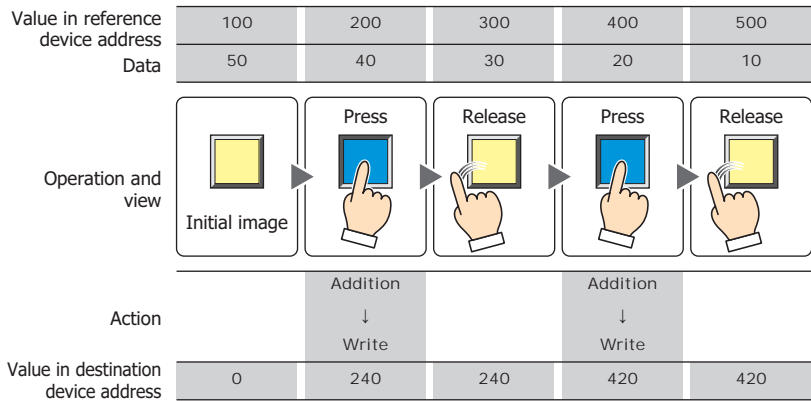

■ **Data Type**

Select the data type to be handled by the operation selected for **Action Mode**.
For details, refer to Chapter 2 "1.1 Available Data" on page 2-1.

UBIN16(W) and **UBIN32(D)** can only be set if **Action Mode** is set to **OR, AND, or XOR**.



UBIN16(W) and **UBIN32(D)** can only be set if **Action Mode** is set to **Move**. Because the number of device addresses to transfer is specified in Advanced mode, you do not need to set Data Type.



If **BCD4(B)**, **BCD8(EB)**, or **Float32(F)** is selected and the arithmetic data contains a value inexpressible in BCD, a 1 is written to the System Area 2 Processing error bit (address number+2, bit 5) and an error message is displayed. For details, refer to Chapter 4 "Processing error" on page 4-32 and Chapter 36 "Processing error" on page 36-3.

■ **Source 1**

Specify the source word device.

Click to display the Tag Editor. For the device address configuration procedure, refer to Chapter 2 "5.1 Device Address Settings" on page 2-70.

This setting is enabled only if **Action Mode** is set to **Add, Sub, Multi, Div, Mod, OR, AND, or XOR**.

■ **Source Data**

Select the data to be handled by the operation selected for **Action Mode**.

Value:

Use a constant value.

Only a **Value** can be handled if **Action Mode** is set to **Set, Momentary, or Alternate**.

If **Action Mode** is set to **Momentary** or **Alternate**, the value in the **ON Data** is written when the button is ON, and the value in the **OFF Data** is written when the button is OFF.

Hexadecimal:

Select this check box to enter the **ON Data** and **OFF Data** values in hexadecimal.

Device Address: Use a value of device address.
Specify the device address.

Click to display the Tag Editor. For the device address configuration procedure, refer to Chapter 2 "5.1 Device Address Settings" on page 2-70.

Use Reference Device Address*1: Select this check box and specify a device address to change the source word device according to the value of the specified device address.

This setting is enabled only if **Action Mode** is set to **Move**.

For details, refer to Chapter 2 "Indirect Read and Indirect Write Settings" on page 2-5.

Transfer*1:

Specify the number of word devices (1 to 64) to transfer.

This setting is enabled only if **Action Mode** is set to **Move**.

Example: If **Transfer** is set to **2** and **Write** is set to **3**, the same data in 2 continuous word device addresses will be written to the destination device address 3 times.

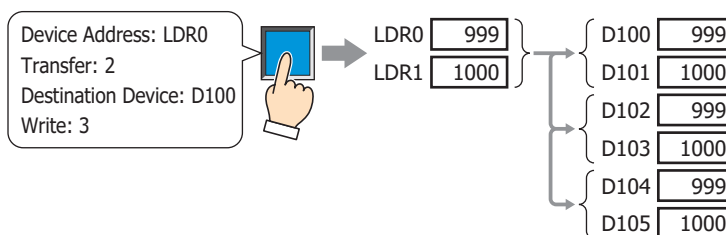

*1 Advanced mode only

■ **Destination Device Address**

Destination Device Address: Specify the destination word device.

Click  to display the Tag Editor. For the device address configuration procedure, refer to Chapter 2 "5.1 Device Address Settings" on page 2-70.

Use Reference Device Address*¹: Select this check box and specify a device address to change the destination word device according to the value of the specified device address.

This setting is enabled only if **Action Mode** is set to **Move**.

For details, refer to Chapter 2 "Indirect Read and Indirect Write Settings" on page 2-5.

Write*¹: Specify the number of word devices (1 to 64) at the destination.

For **Move**, specify how many times to write.

This setting is enabled only if **Action Mode** is set to **Set, Momentary, Alternate, or Move**.

Example: If **Data Type** is set to **UBIN16(W)** and **Write** is set to 5, the same data will be written to 5 continuous word addresses.

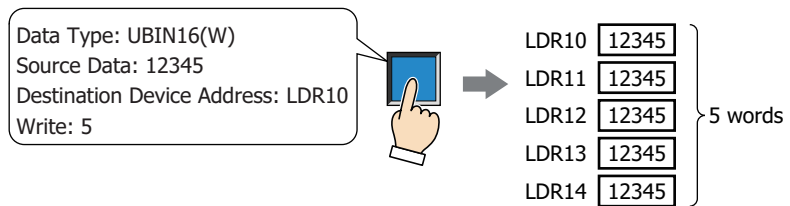

Example: If **Data Type** is set to **UBIN32(D)** and **Write** is set to 5, the same data will be written to a total of 10 word addresses (2 words 5 times).

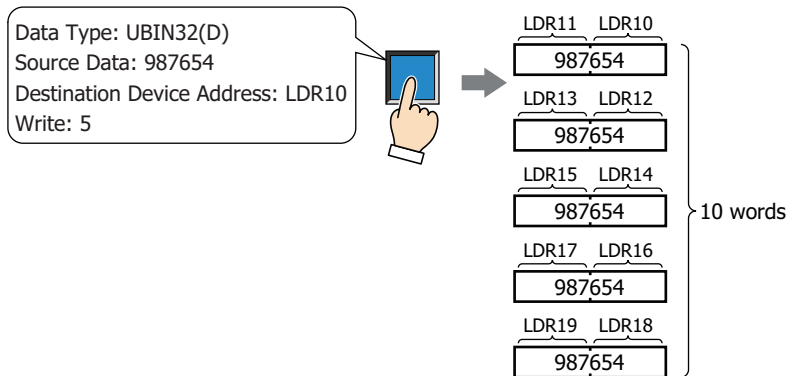

*1 Advanced mode only

■ View Switching Method*1

Select how to display the ON/OFF status of the button.

Button: Pressing the button changes the drawing object displayed.

Device Address: The drawing objects assigned to the OFF and ON states are displayed when the value of the device address is 0 and 1, respectively. Specifies the device address used to switch the drawing object display.

Click  to display the Tag Editor. For the device address configuration procedure, refer to Chapter 2 "5.1 Device Address Settings" on page 2-70.

No Image: The button is not displayed on the screen. The button appears as a dashed line frame on the edit screen. Pressing the corresponding area on the MICRO/I activates the assigned function. If **No Image** is selected, the settings for **View** and **Registration Text** are disabled.



Selecting **Device Address** in **View Switching Method** allows you to create an illuminated pushbutton. The illuminated pushbutton switches state (or image) according to ON or OFF state of the device address, allowing you to display the state of a device that is being operated.

Example: When you set an external device address 'M0' as **Device Address** in **View Switching Method**, if the value of M0 changes, the display image will switched according to the value of M0 even if the button is not pressed.

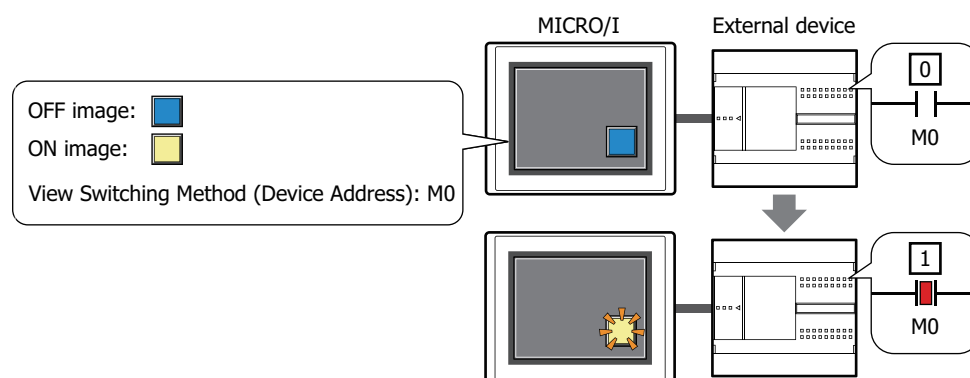

*1 Advanced mode only

● View Tab

Only **Coordinates** and **Size** can be configured when **No Image** is selected for **View Switching Method** on the **General** tab.

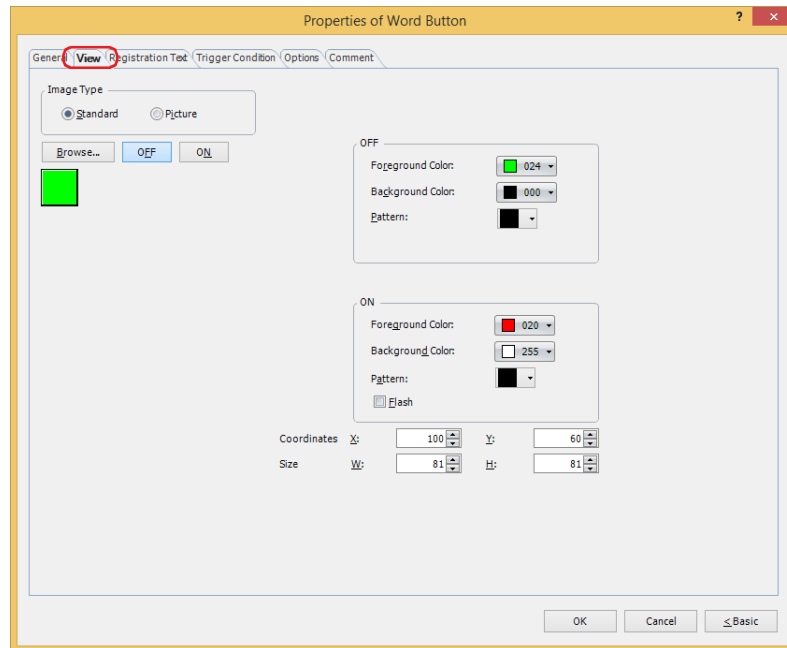

■ Image Type

Select the type of graphic to be used to represent the part.

Standard: Uses the default graphics contained within WindO/I-NV4.

Picture: Uses an image file saved in the Picture Manager.

For details about image file restrictions, refer to Chapter 2 "1.4 Available Image Files" on page 2-20.

■ Browse

Select the type of graphic to be used to represent the part from the list of graphics. Click this button to display the View Browser or Picture Manager, depending on the setting for **Image Type**.

■ OFF button, ON button

Displays the graphic when ON or OFF. Clicking **ON** or **OFF** switches the image displayed on the **View** tab.

■ OFF, ON

Selects the color and pattern of the standard graphic when ON and OFF.

Foreground Color, Background Color: Selects the foreground and background colors of the standard graphic (color: 256 colors, monochrome: 16 shades).

Click **Color** to display the Color Palette. Select a color from the Color Palette.

Pattern: Selects a pattern or tonal gradation for the standard graphic.

Click **Pattern** to display the Pattern Palette. Select a pattern or tonal gradation from the Pattern Palette.

Flash

Select this check box if flashing is desired (alternating ON and OFF) when a part is ON.

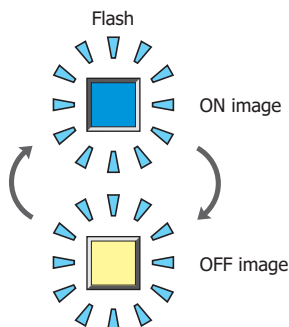

Coordinates

X, Y: Sets the display position of parts using coordinates.

The X and Y coordinates of parts are defined relative to an origin at the top-left corner of the screen.

X: 0 to (base screen horizontal size - 1)

Y: 0 to (base screen vertical size - 1)

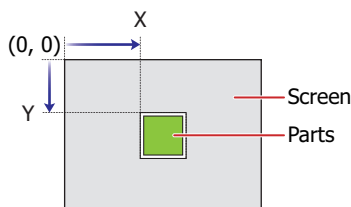

Size

W, H: Sets width and height to define the size of parts.

W: 20 to (base screen horizontal size)

H: 20 to (base screen vertical size)

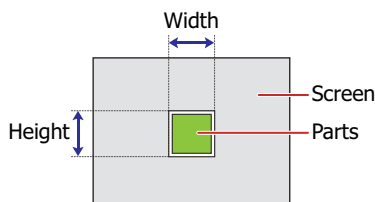

● **Registration Text** Tab

These options can only be configured when **Button** or **Device Address** is selected for **View Switching Method** on the **General** tab.

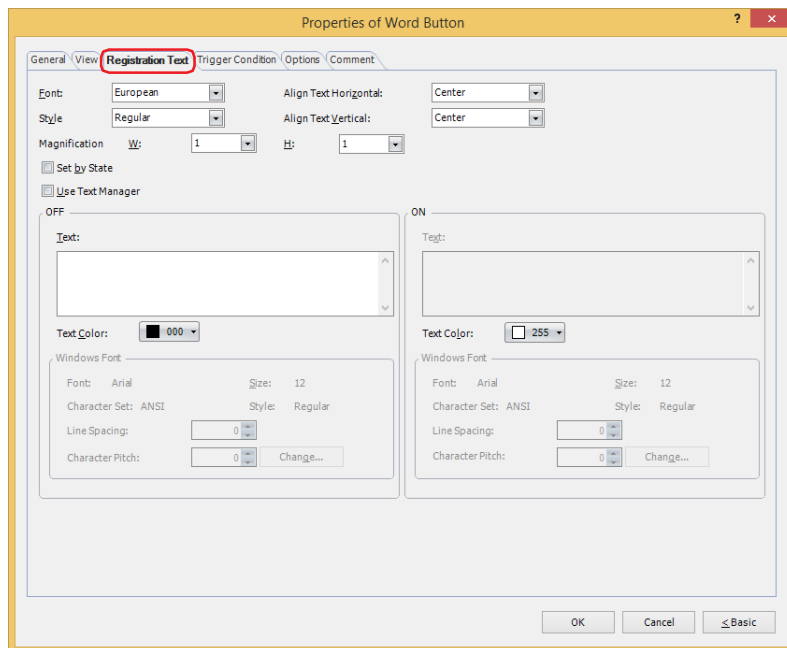

■ **Font**

Selects the font used for displaying text from the following.

Western, Japanese, Simplified Chinese, Traditional Chinese, Hangul, Central European, Baltic, Cyrillic, Windows, Stroke*1

Can only be set when the **Use Text Manager** check box is cleared.

The characters that can be displayed depend on the font. For details, refer to Chapter 2 "1.2 Available Text" on page 2-6.

■ **Style***1

Selects **Regular** or **Bold** for text style.

Can only be set when **Font** is set to **Western, Japanese, Simplified Chinese, Traditional Chinese, Hangul, Central European, Baltic, Cyrillic**.

■ **Size**

Specifies the text size to be displayed. The fonts and sizes that can be set vary based on the model.

Model	Font	Size
HG2J-7U	Western, Japanese, Simplified Chinese, Traditional Chinese, Hangul, Central European, Baltic, Cyrillic	8 to 512
HG5G/4G/3G/2G-V, HG4G/3G, HG2G-5F/-5T, HG1G/1P	Stroke	8 to 128

■ **Magnification***1

W, H: Selects the magnification (0.5, 1 to 8) for text display.

Can only be set when **Font** is set to **Western, Japanese, Simplified Chinese, Traditional Chinese, Hangul, Central European, Baltic, Cyrillic**.

■ **Align Text Horizontal**

Selects text alignment in the horizontal direction.

Left, Center, Right, Center-Left

For details, refer to Appendix "5 Text Alignment" on page A-7.

*1 HG5G/4G/3G/2G-V, HG4G/3G, HG2G-5F/-5T, HG1G/1P only

- **Align Text Vertical**

Selects text alignment in the vertical direction.

- **Top, Center, Bottom**

For details, refer to Appendix "5 Text Alignment" on page A-7.

- **Set by State**

Select this check box if displaying different text when ON and OFF.

- **Use Text Manager**

Select this check box if using the text registered in Text Manager for text display.

- **OFF, ON**

- Text:** Inputs characters to be displayed on parts. The maximum number is 3,750 characters.
The characters that can be entered depend on the font selected using **Font**. For details, refer to Chapter 2 "1.2 Available Text" on page 2-6.
- Text ID:** Specifies the Text Manager ID No. (1 to 32000) when using the text registered in the Text Manager.
Click to display Text Manager.
Can only be set when the **Use Text Manager** check box is selected.
- Text Color:** Selects the color of the text displayed on the part (color: 256 colors, monochrome: 16 shades).
Click **Color** to display the Color Palette. Select a color from the Color Palette.
- Windows Font:** Sets the font to be used as the Windows Font.
Select **Windows** using **Font** to display the current setting. You can specify the character spacing (0 to 100) and the line spacing (0 to 100). To change the settings other than the character spacing and line spacing, click **Change** to display the **Font Setting** dialog box.
Can only be set when the **Use Text Manager** check box is cleared.
For details, refer to Chapter 2 "Windows Font" on page 2-13.

● **Trigger Condition Tab**

The **Trigger Condition** tab is displayed in Advanced mode.

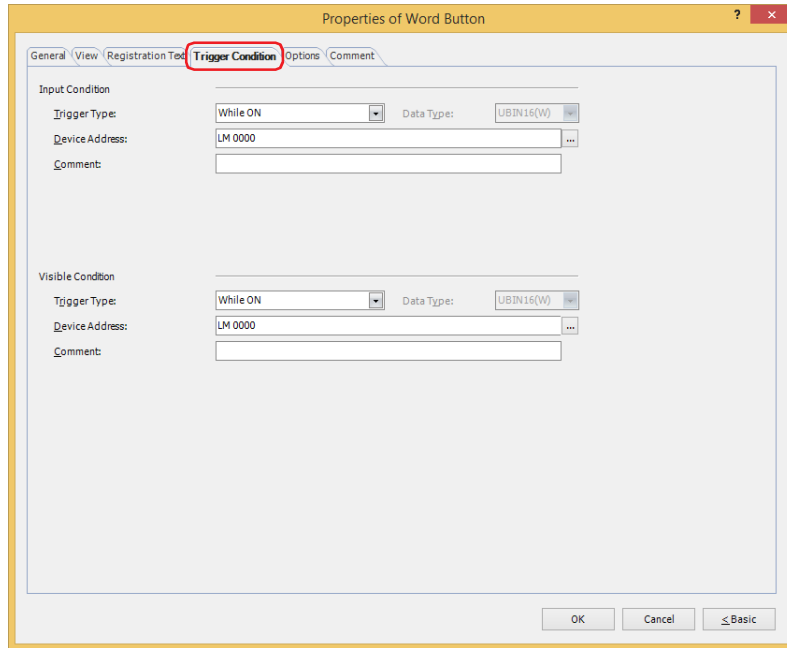

■ **Input Condition**

The Button is enabled and operational while the condition is satisfied. The Button is disabled and not operational while the condition is not satisfied.

Example: When **Trigger Type** is **While ON** and **Device Address** is **LM0**

While LM0 is 0, the condition is not satisfied and the Button is not operational.

While LM0 is 1, the condition is satisfied and the Button is operational.

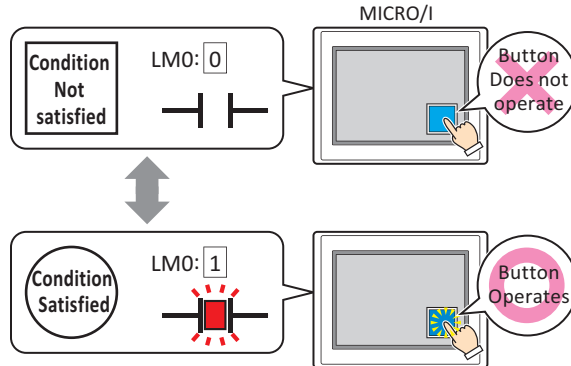

Trigger Type: Selects the condition to enable the Button from the following.

Always enable: The Button is always enabled.



While ON: Enables the Button when the value of device address is 1.

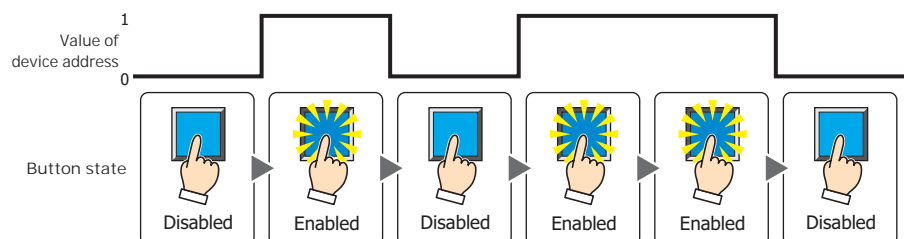

While OFF: Enables the Button when the value of device address is 0.

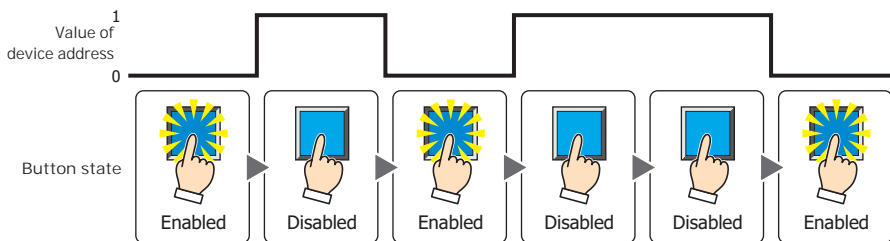

While satisfying the condition: Enables the Button when the condition is satisfied.

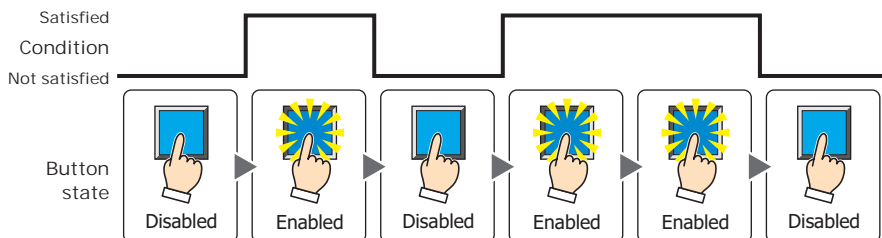

- Data Type:** Selects the type of data handled by the conditional expression for the input condition. This option can only be configured if **While satisfying the condition** is selected for **Trigger Type**. For details, refer to Chapter 2 "1.1 Available Data" on page 2-1.
- Device Address:** Specifies the bit device or the bit number of the word device to serve as the input condition. This option can only be configured when **While ON** or **While OFF** is selected for **Trigger Type**. Click to display the Tag Editor. For the device address configuration procedure, refer to Chapter 2 "5.1 Device Address Settings" on page 2-70.
- Condition:** Specifies the conditional expression for the input condition. This option can only be configured when **While satisfying the condition** is selected for **Trigger Type**. Click to display the **Trigger Condition Settings** dialog box. For the conditional expression configuration procedure, refer to Chapter 2 "5.2 Setting Conditional Expressions" on page 2-73.
- Comment:** Used for entering a comment for the input condition. The maximum number is 80 characters.

■ **Visible Condition**

The Button is displayed while the condition is satisfied. The Button is hidden while the condition is not satisfied.

Example: When **Trigger Type** is **While ON** and **Device Address** is **LM0**
 While LM0 is 0, the condition is not satisfied and the Button is hidden.
 While LM0 is 1, the condition is satisfied and the Button is displayed.

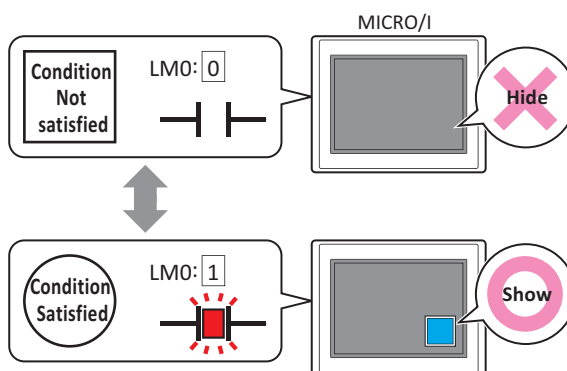

- When **Alternate** is selected for **Action Mode** on the **General** tab, the button remains on when hidden in the on state.
- When the **ON delay** check box is selected on the **Options** tab, if the button is hidden before the set time elapses from when the button begins to be pressed, the on delay is reset and the button does not operate.

Trigger Type: Selects the condition to display the Button from the following.

Always visible: The Button is always displayed.

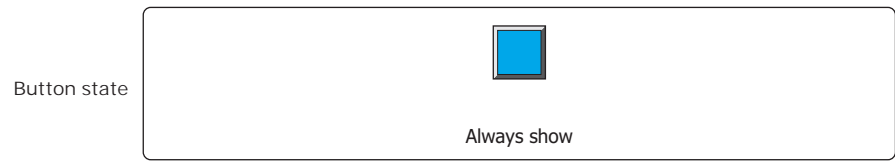

While ON: Displays the Button when the value of device address is 1.

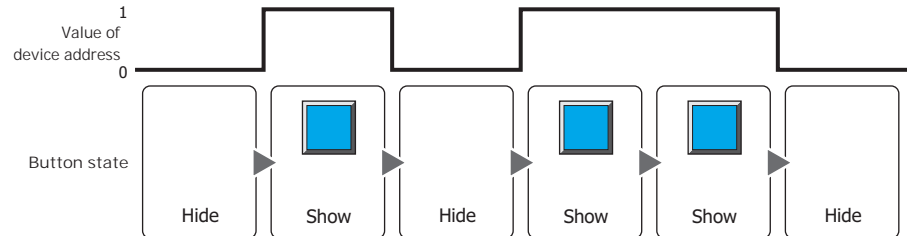

While OFF: Displays the Button when the value of device address is 0.

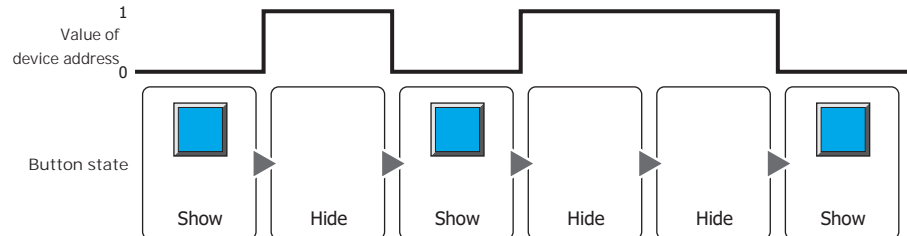

While satisfying the condition: Displays the Button when the condition is satisfied.

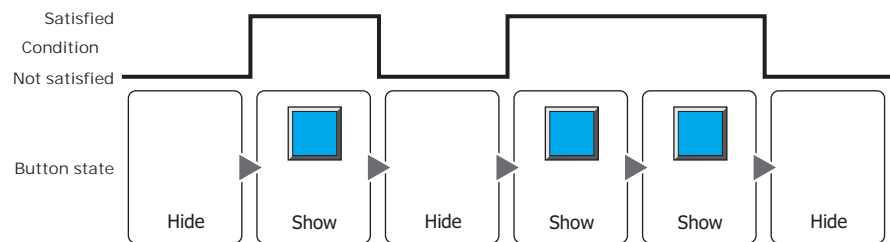

Data Type: Selects the type of data handled by the conditional expression for the visible condition. This option can only be configured if **While satisfying the condition** is selected for **Trigger Type**. For details, refer to Chapter 2 "1.1 Available Data" on page 2-1.

Device Address: Specifies the bit device or the bit number of the word device to serve as the visible condition. This option can only be configured when **While ON** or **While OFF** is selected for **Trigger Type**.

Click  to display the Tag Editor. For the device address configuration procedure, refer to Chapter 2 "5.1 Device Address Settings" on page 2-70.

Condition: Specifies the conditional expression for the visible condition. This option can only be configured when **While satisfying the condition** is selected for **Trigger Type**.

Click  to display the **Trigger Condition Settings** dialog box. For the conditional expression configuration procedure, refer to Chapter 2 "5.2 Setting Conditional Expressions" on page 2-73.

Comment: Used for entering a comment for the visible condition. The maximum number is 80 characters.

● Options Tab

The **Options** tab is displayed in Advanced mode.

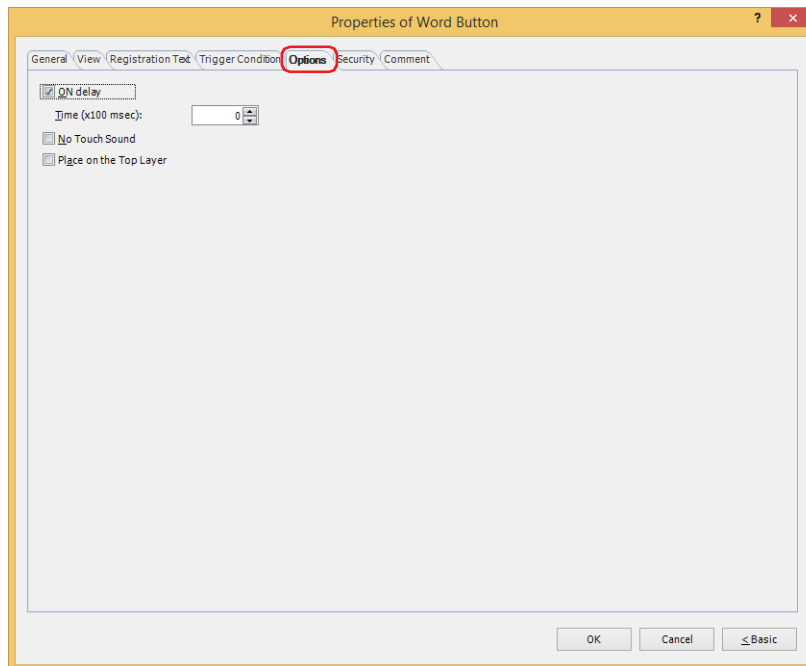

■ ON delay

Select this check box to use the ON delay function.

Time (x100 msec): Specify the length of time that the button must be held down before activation by selecting a value from 0 to 600 (units of 10 ms).
The button activates after it is held down for a specified period of time.

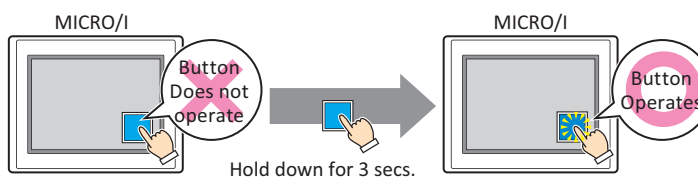

This feature protects against mistaken operation by ensuring that the button will not be activated if touched accidentally.

■ No Touch Sound

This function is to disable touch sounds only for specified parts when the MICRO/I makes touch sounds.

Select this check box to display disable touch sounds for this part.



To enable touch sounds on the MICRO/I, select the **Enable Touch Sound** check box under the **System** tab of the **Project Settings** dialog box.

■ Place on the Top Layer

Select this check box to display the parts on the top layer. The parts will have precedence when other drawings and parts are overlapping with it. For details, refer to Chapter 6 "4 Drawings and Parts Overlapping" on page 6-5.

● Security Tab

This tab is used to restrict displaying and using the part by security groups.

This option can only be set when **Use Security functions** is selected. The **Use Security functions** check box is set on **General** tab in the **Security** dialog box.

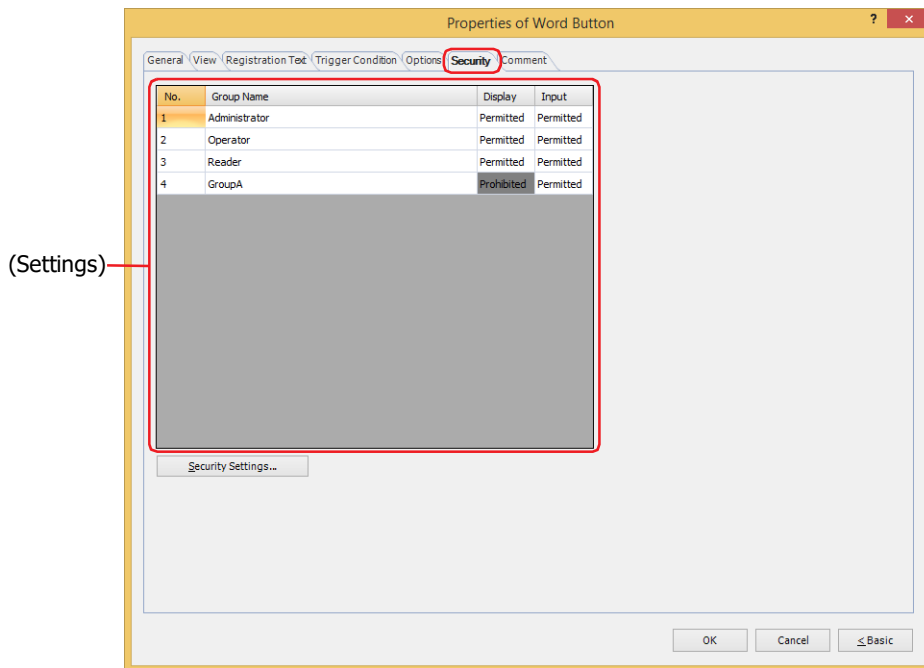

■ (Settings)

Displays the list of security groups used on the MICRO/I.

No.: Displays the security group numbers (1 to 15).

Group Name: Displays the name of the security group.

Display: Displays whether or not there is permission to display the part. Only **Permitted** security groups can display this part. If all security groups are set to **Permitted**, this part will be displayed even if no user account has been selected. Double clicking the cell switches between **Permitted** and **Prohibited**.

Input: Displays whether or not there is permission to use the part. Only **Permitted** security groups can use this part. If all security groups are set to **Permitted**, this part can be used even if no user account has been selected. Double clicking the cell switches between **Permitted** and **Prohibited**.



- You can also switch between **Permitted** and **Prohibited** by right-clicking on a **Display** or **Input** cell.
- Restricting the display and use of the part by switching between **Permitted** and **Prohibited** in **Display** and **Input** cells is similar to using the **Trigger Condition** tab.



■ Security Settings

The Security Settings dialog box is displayed. If you create a security group in the **Security Settings** dialog box, you can select that created group. For details, refer to Chapter 23 “2.2 Adding and Editing Security Groups” on page 23-19.



For details about security functions, refer to Chapter 23 “User Accounts and the Security Function” on page 23-1.

Example: If the user and security group for a part are set as follows:

User Name	 User1	 User2	 User3
Security Group	Reader	Operator	Administrator

Line Chart and Bar Chart

No.	Group Name	Display
1	Administrator	Permitted
2	Operator	Permitted
3	Reader	Prohibited

MICRO/I

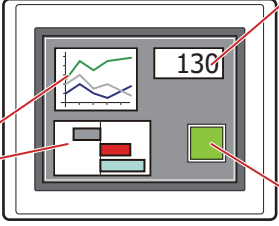

Numerical Display

No.	Group Name	Display
1	Administrator	Permitted
2	Operator	Permitted
3	Reader	Permitted

Button

No.	Group Name	Display	Input
1	Administrator	Permitted	Permitted
2	Operator	Permitted	Prohibited
3	Reader	Prohibited	Prohibited

For User1 in the **Reader** security group, the parts for which **Display** has been set to **Prohibited** for **Reader** will not be displayed.

If the password screen is opened and the user switches to User2 in the **Operator** security group, the parts for which **Display** has been set to **Permitted** for **Operator** will be displayed.

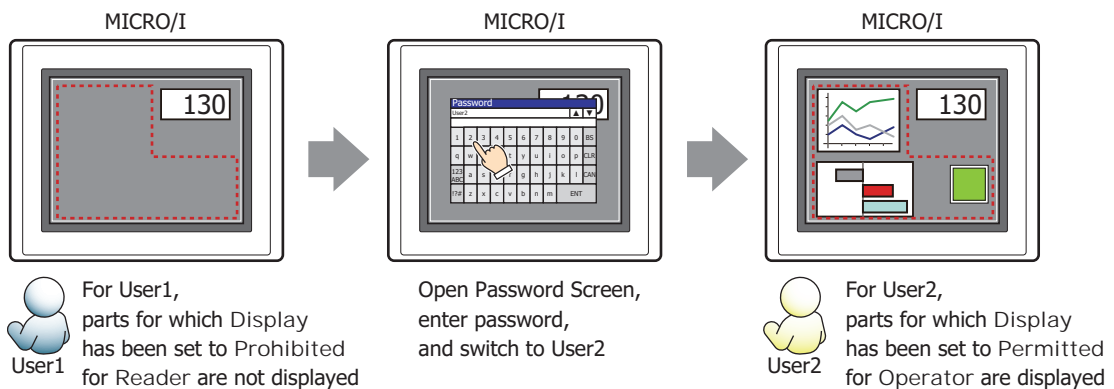

For User2 in **Operator**, **Display** has been set to **Permitted** for **Operator**, but **Input** is **Prohibited**, so the part cannot be used.

If the password screen is opened and the user switches to User3 in the **Administrator** security group, the parts for which **Display** has been set to **Permitted** for **Administrator** will be displayed, and the parts for which **Input** has been set to **Permitted** for **Administrator** can be used.

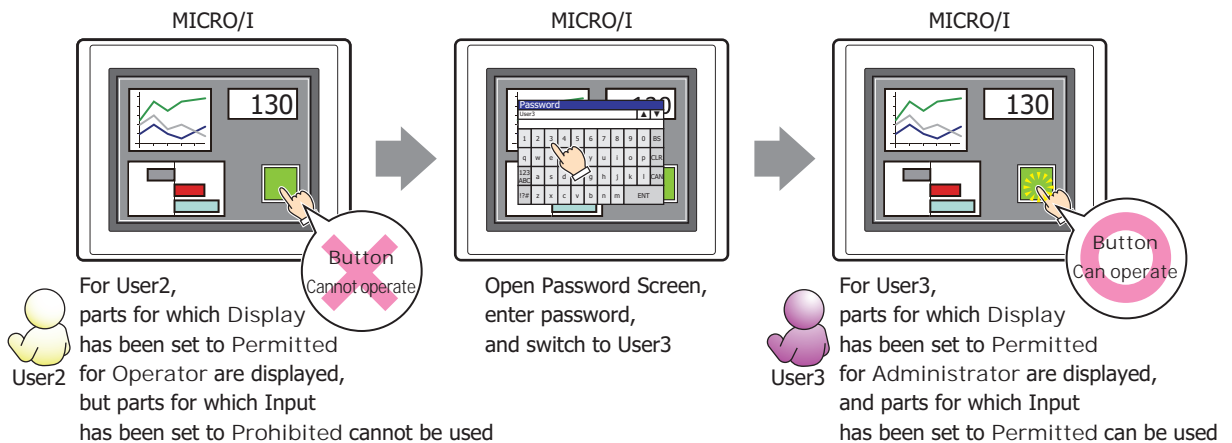

● Comment Tab

The **Comment** tab is used to specify the parts placed on the editing screen, and the popup text displayed when the mouse pointer is placed close to **No.**, **Name**, or **Type** in the object list.



When there are multiple parts of the same shape on the screen, this feature makes it possible to distinguish between the parts without displaying the Properties dialog box for each part, by just mousing over the part.

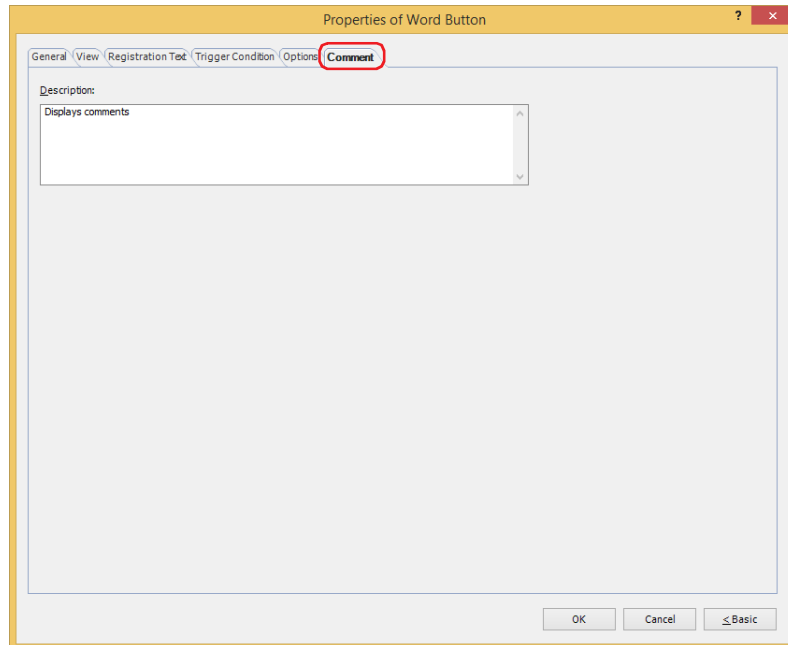

■ Description

Used for entering comments about parts. The maximum number is 80 characters.

Example: When mousing over the Button on the editing screen

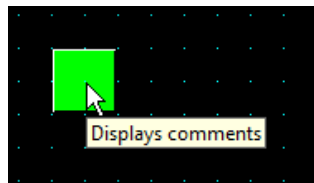

3 Goto Screen Button

HG2J-7U HG5G-V HG4G-V HG4G HG3G-V HG3G HG2G-V HG2G-5F HG2G-5T HG1G HG1P

3.1 How the Goto Screen Button is Used

Switches to another screen or displays a window.

- Pressing the button switches between Base Screens.

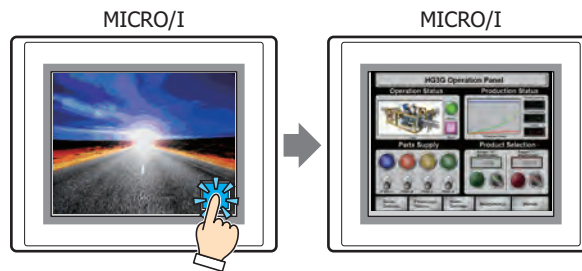

- Pressing the button opens and closes other windows (such as the Popup Screen, Device Monitor, Password Screen, Adjust Brightness Screen, File Screen, and Open User Account Setting Screen).

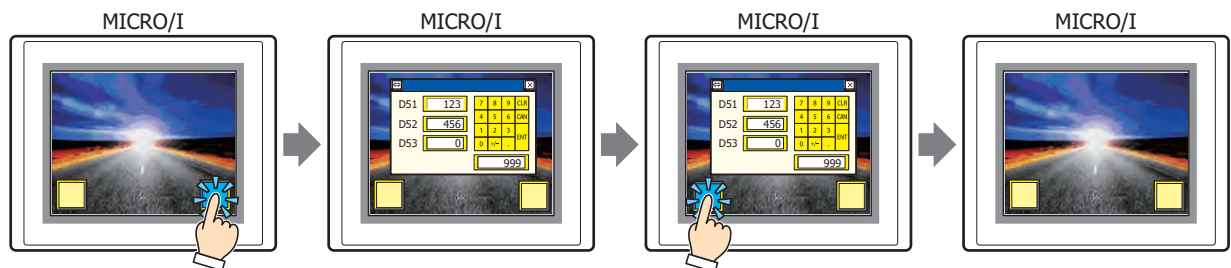

- Pressing the button switches to the System Mode.

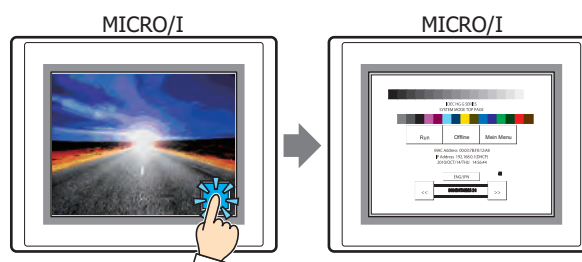

- Pressing the button resets the current screen.

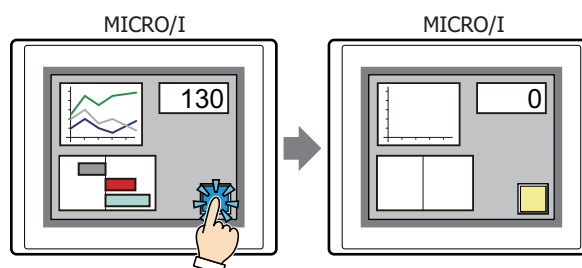

3.2 Goto Screen Button Configuration Procedure

This section describes the configuration procedure for Goto Screen Buttons.

- 1 On the **Home** tab, in the **Parts** group, click **Buttons**, and then click **Goto Screen Button**.

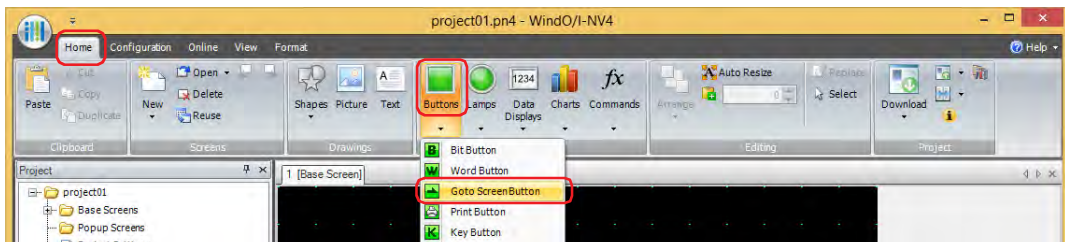

- 2 Click a point on the edit screen where you wish to place the Goto Screen Button.
- 3 Double-click the placed Goto Screen Button and a Properties dialog box will be displayed.
- 4 Change the settings on each tab as necessary.

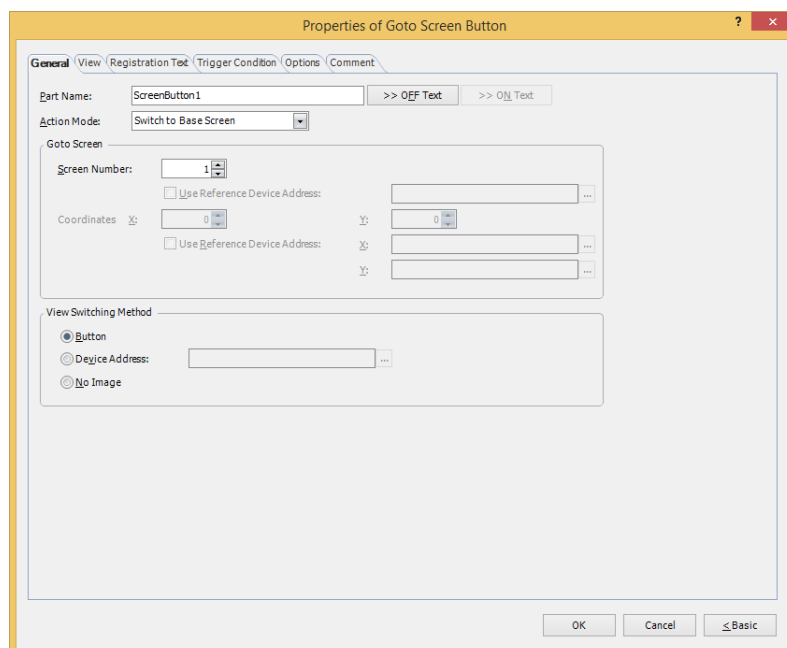

The **Trigger Condition** tab and **Options** tab only appear in Advanced mode.



You can set the default for the Goto Screen Button on the **Default Preferences** tab of the **WindO/I-NV4 Options** dialog box. For details, refer to Chapter 2 "Default Preferences Tab" on page 2-63.

3.3 Properties of Goto Screen Button Dialog Box

This section describes items and buttons in the Properties dialog box.

● General Tab

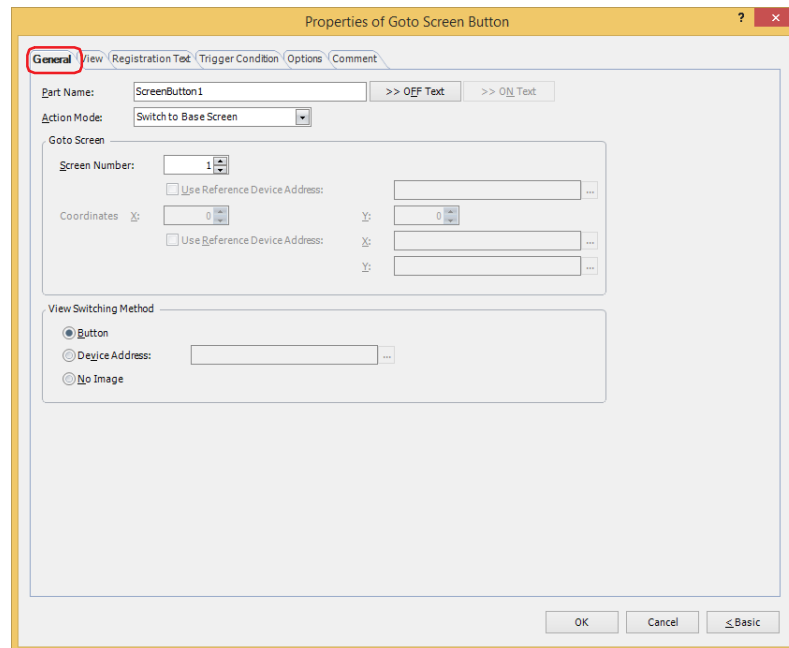

■ Part Name

Enter a name for the part. The maximum number is 20 characters.

■ >>OFF Text, >>ON Text

Applies the text entered in the **Part Name** field to the **Text** field under the **OFF** or **ON** fields on the **Registration Text** tab. This is used as the Registration Text when the button is OFF or ON.



To specify the Registration Text to use when the button is ON, select the **Set by State** check box on the **Registration Text** tab. If left unchecked, the same Registration Text assigned for the OFF state is displayed for the ON state as well.

■ Action Mode

Select the behavior of the button from the following:

Back to previous Screen:	Switches to the previous screen. Returns to up to 16 earlier screens.
Switch to Base Screen:	Switches between Base Screen. For details, refer to Chapter 5 "3 Base Screen" on page 5-14.
Open Popup Screen:	Opens a Popup Screen. For details, refer to Chapter 5 "4 Popup Screen" on page 5-20.
Close Popup Screen:	Closes a Popup Screen. For details, refer to Chapter 5 "4 Popup Screen" on page 5-20.
Open Device Monitor Screen:	Opens the Device Monitor Screen. For details, refer to Chapter 25 "2.2 Device Monitor" on page 25-21.
Close Device Monitor Screen:	Closes the Device Monitor Screen. For details, refer to Chapter 25 "2.2 Device Monitor" on page 25-21.
Open Password Screen:	Opens the Password Screen. For details, refer to Chapter 23 "4.1 Entering the Password on the MICRO/I" on page 23-47.
Close Password Screen:	Closes the Password Screen. For details, refer to Chapter 23 "4.1 Entering the Password on the MICRO/I" on page 23-47.
Open Adjust Brightness Screen:	Opens the Adjust Brightness Screen. For details, refer to Chapter 34 "1.3 Adjusting Screen Brightness" on page 34-2.
Close Adjust Brightness Screen:	Closes the Adjust Brightness Screen. For details, refer to Chapter 34 "1.3 Adjusting Screen Brightness" on page 34-2.
Open File Screen for movie files*1:	Opens the File Screen. For details, refer to Chapter 10 "4.4 File Screen" on page 10-92.
Close File Screen for movie files*1:	Closes the File Screen. For details, refer to Chapter 10 "4.4 File Screen" on page 10-92.
Switch to System Mode:	Switches to the Top Page in the System Mode. For details, refer to Chapter 34 "2 System Mode Overview" on page 34-3.
Reset current screen:	Resets the current Base Screen. When the current screen is reset, the displayed Popup Screen is closed and the following internal devices restart as if the Base Screen is switched. <ul style="list-style-type: none"> • HMI Temporary Relay LBM0 to 127 • HMI Special Internal Relay LSM1, 2, 3, 11 • HMI Temporary Register LBR0 to 127
Open User Account Setting Screen:	Opens the User Account Setting Screen. For details, refer to Chapter 23 "5 Editing User Accounts on the MICRO/I" on page 23-50. When User Account Setting Screen is selected, the Configure Processing Area of User Account Setting Screen dialog box will be displayed. For details, refer to "Configure Processing Area of User Account Setting Screen Dialog Box" on page 8-44. Specify the word device to use as the processing area of the User Account Setting Screen and click OK . When you return to the properties dialog box, Edit will be displayed. Edit: Click this button to display the Configure Processing Area of User Account Setting Screen dialog box.

*1 This is applicable for models with a video interface only.

■ Goto Screen

Screen Number: If **Action Mode** is set to **Switch to Base Screen**, specify the Base Screen number to switch to (from 1 to 3000). If **Action Mode** is set to **Open Popup Screen** or **Close Popup Screen**, specify the number of the Popup Screen to open or close (from 1 to 3015). This setting is enabled only if **Action Mode** is set to **Switch to Base Screen**, **Open Popup Screen**, or **Close Popup Screen**.

Use Reference Device Address*²: Select this check box and specify a device address to specify the screen number using the value of the specified device address.

Click  to display the Tag Editor. For the device address configuration procedure, refer to Chapter 2 "5.1 Device Address Settings" on page 2-70.

This setting is enabled only if **Action Mode** is set to **Open Popup Screen** or **Close Popup Screen**.

Coordinates X, Y: Specify the coordinates on the Base Screen for displaying a window.

X and Y specify the upper left corner of the window using the upper left corner of the screen as the origin.

This setting is enabled only if **Action Mode** is set to **Open Popup Screen**, **Open Device Monitor Screen**, **Open Password Screen**, **Open Adjust Brightness Screen**, or **Open File Screen for Movie Files***¹.

Use Reference Device Address*²: Select this check box and specify a device address to specify the coordinates using the value of the specified device address.

Click  to display the Tag Editor. For the device address configuration procedure, refer to Chapter 2 "5.1 Device Address Settings" on page 2-70.

This setting is enabled only if **Action Mode** is set to **Open Popup Screen**.

■ View Switching Method*²

Select how to display the ON/OFF status of the button.

Button: Pressing the button changes the drawing object displayed.

Device Address: The drawing objects assigned to the OFF and ON states are displayed when the value of the device address is 0 and 1, respectively. Specifies the device used to switch the drawing object display.

Click  to display the Tag Editor. For the device address configuration procedure, refer to Chapter 2 "5.1 Device Address Settings" on page 2-70.

No Image: The button is not displayed on the screen. The button appears as a dashed line frame on the edit screen. Pressing the corresponding area on the MICRO/I activates the assigned function. If **No Image** is selected, the settings for **View** and **Registration Text** are disabled.



Selecting **Device Address** in **View Switching Method** allows you to create an illuminated pushbutton. The illuminated pushbutton switches state (or image) according to ON or OFF state of the device address, allowing you to display the state of a device that is being operated.

Example: When you set an external device address 'M0' as **Device Address** in **View Switching Method**, if the value of M0 changes, the display image will switched according to the value of M0 even if the button is not pressed.

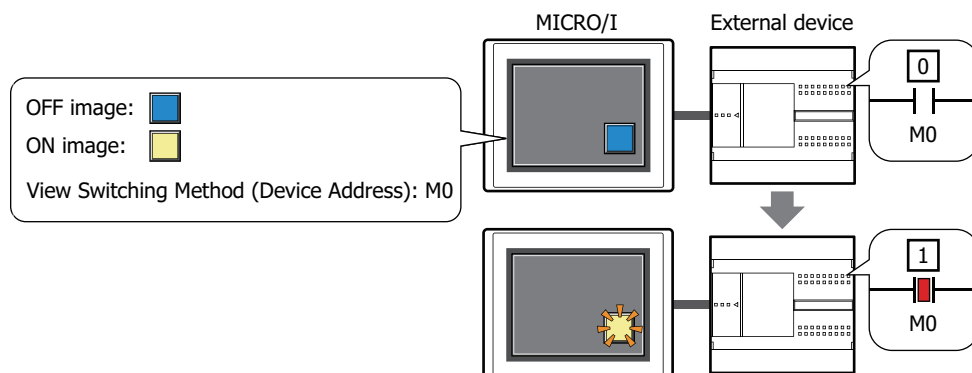

*1 This is applicable for models with a video interface only.

*2 Advanced mode only

Configure Processing Area of User Account Setting Screen Dialog Box

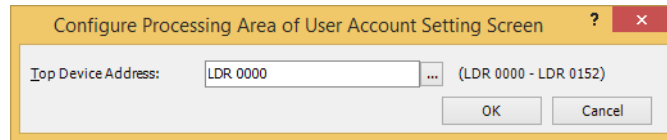

■ **Top Device Address**

Specifies a word device to use Processing Area of User Account Setting Screen. This option uses 152 words of address numbers starting from the address number of the specified device address. You can only specify an internal device.

Click to display the Tag Editor. For the device address configuration procedure, refer to Chapter 2 "5.1 Device Address Settings" on page 2-70.

● View Tab

Only **Coordinates** and **Size** can be configured when **No Image** is selected for **View Switching Method** on the **General** tab.

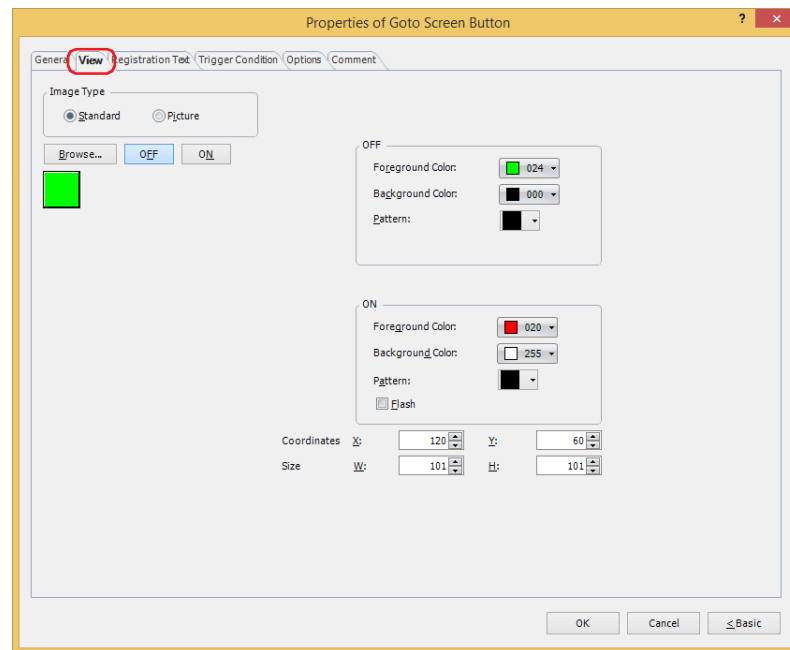

■ Image Type

Select the type of graphic to be used to represent the part.

Standard: Uses the default graphics contained within WindO/I-NV4.

Picture: Uses an image file saved in the Picture Manager.

For details about image file restrictions, refer to Chapter 2 "1.4 Available Image Files" on page 2-20.

■ Browse

Select the type of graphic to be used to represent the part from the list of graphics. Click this button to display the View Browser or Picture Manager, depending on the setting for **Image Type**.

■ OFF button, ON button

Displays the graphic when ON or OFF. Clicking **ON** or **OFF** switches the image displayed on the **View** tab.

■ OFF, ON

Selects the color and pattern of the standard graphic when ON and OFF.

Foreground Color, Background Color: Selects the foreground and background colors of the standard graphic (color: 256 colors, monochrome: 16 shades).

Click **Color** to display the Color Palette. Select a color from the Color Palette.

Pattern: Selects a pattern or tonal gradation for the standard graphic.

Click **Pattern** to display the Pattern Palette. Select a pattern or tonal gradation from the Pattern Palette.

■ **Flash**

Select this check box if flashing is desired (alternating ON and OFF) when a part is ON.

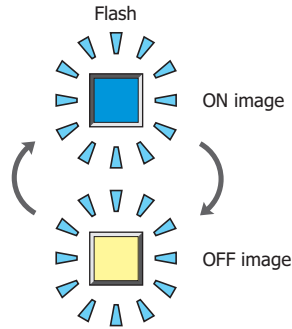

■ **Coordinates**

X, Y: Sets the display position of parts using coordinates.

The X and Y coordinates of parts are defined relative to an origin at the top-left corner of the screen.

X: 0 to (base screen horizontal size - 1)

Y: 0 to (base screen vertical size - 1)

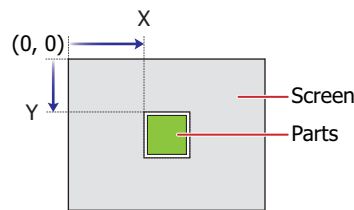

■ **Size**

W, H: Sets width and height to define the size of parts.

W: 20 to (base screen horizontal size)

H: 20 to (base screen vertical size)

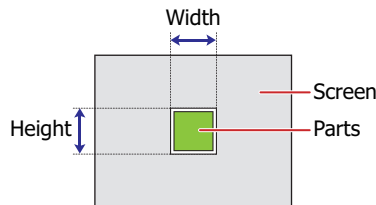

● Registration Text Tab

These options can only be configured when **Button** or **Device Address** is selected for **View Switching Method** on the **General** tab.

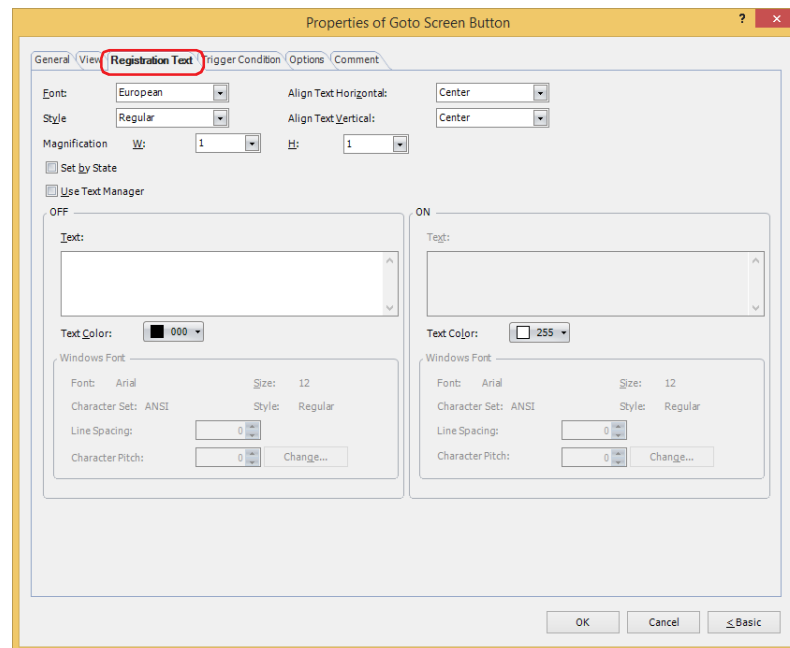

■ Font

Selects the font used for displaying text from the following.

Western, Japanese, Simplified Chinese, Traditional Chinese, Hangul, Central European, Baltic, Cyrillic, Windows, Stroke^{*1}

Can only be set when the **Use Text Manager** check box is cleared.

The characters that can be displayed depend on the font. For details, refer to Chapter 2 "1.2 Available Text" on page 2-6.

■ Style^{*1}

Selects **Regular** or **Bold** for text style.

Can only be set when **Font** is set to **Western, Japanese, Simplified Chinese, Traditional Chinese, Hangul, Central European, Baltic, Cyrillic**.

■ Size

Specifies the text size to be displayed. The fonts and sizes that can be set vary based on the model.

Model	Font	Size
HG2J-7U	Western, Japanese, Simplified Chinese, Traditional Chinese, Hangul, Central European, Baltic, Cyrillic	8 to 512
HG5G/4G/3G/2G-V, HG4G/3G, HG2G-5F/-5T, HG1G/1P	Stroke	8 to 128

■ Magnification^{*1}

W, H: Selects the magnification (0.5, 1 to 8) for text display.

Can only be set when **Font** is set to **Western, Japanese, Simplified Chinese, Traditional Chinese, Hangul, Central European, Baltic, Cyrillic**.

■ Align Text Horizontal

Selects text alignment in the horizontal direction.

Left, Center, Right, Center-Left

For details, refer to Appendix "5 Text Alignment" on page A-7.

*1 HG5G/4G/3G/2G-V, HG4G/3G, HG2G-5F/-5T, HG1G/1P only

■ Align Text Vertical

Selects text alignment in the vertical direction.

Top, Center, Bottom

This option can only be configured when **Left**, **Center**, or **Right** is selected for **Align Text Horizontal**. If **Center-Left** is selected for **Align Text Horizontal**, **Center-Top** is set as this option.

For details, refer to Appendix "5 Text Alignment" on page A-7.

■ Set by State

Select this check box if displaying different text when ON and OFF.

■ Use Text Manager

Select this check box if using the text registered in Text Manager for text display.

■ OFF, ON

- Text:** Inputs characters to be displayed on parts. The maximum number is 3,750 characters.
The characters that can be entered depend on the font selected using **Font**. For details, refer to Chapter 2 "1.2 Available Text" on page 2-6.
- Text ID:** Specifies the Text Manager ID No. (1 to 32000) when using the text registered in the Text Manager.
Click  to display Text Manager.
Can only be set when the **Use Text Manager** check box is selected.
- Text Color:** Selects the color of the text displayed on the part (color: 256 colors, monochrome: 16 shades).
Click **Color** to display the Color Palette. Select a color from the Color Palette.
- Windows Font:** Sets the font to be used as the Windows Font.
Select **Windows** using **Font** to display the current setting. You can specify the character spacing (0 to 100) and the line spacing (0 to 100). To change the settings other than the character spacing and line spacing, click **Change** to display the **Font Setting** dialog box.
Can only be set when the **Use Text Manager** check box is cleared.
For details, refer to Chapter 2 "Windows Font" on page 2-13.

● Trigger Condition Tab

The **Trigger Condition** tab is displayed in Advanced mode.

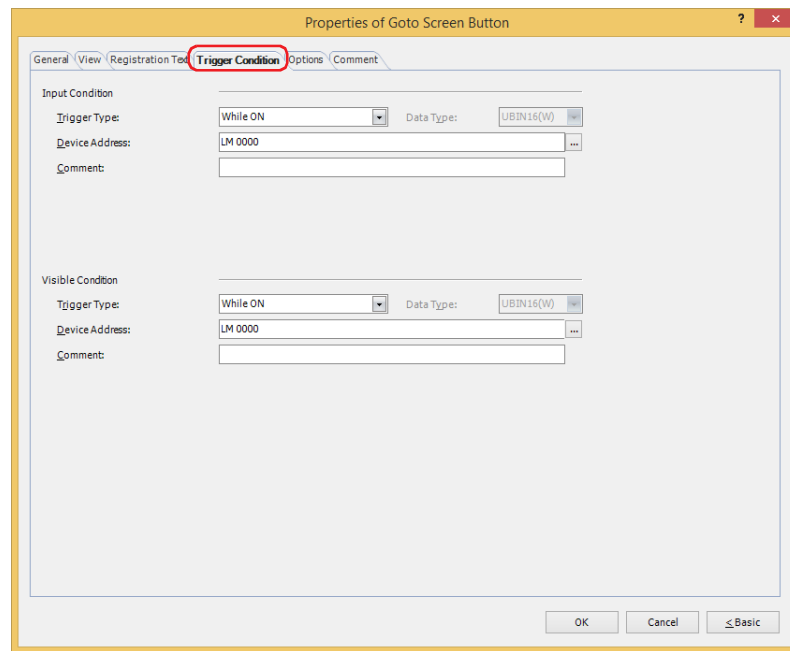

■ Input Condition

The Button is enabled and operational while the condition is satisfied. The Button is disabled and not operational while the condition is not satisfied.

Example: When **Trigger Type** is **While ON** and **Device Address** is **LM0**

While LM0 is 0, the condition is not satisfied and the Button is not operational.

While LM0 is 1, the condition is satisfied and the Button is operational.

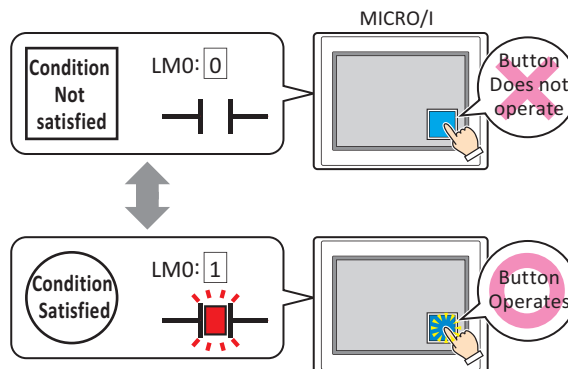

Trigger Type: Selects the condition to enable the Button from the following.

Always enable: The Button is always enabled.



While ON: Enables the Button when the value of device address is 1.

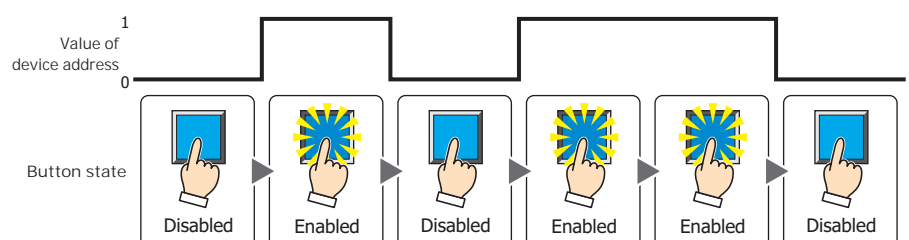

While OFF: Enables the Button when the value of device address is 0.

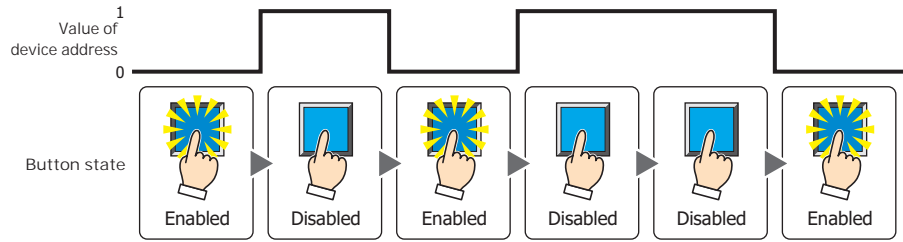

While satisfying the condition: Enables the Button when the condition is satisfied.

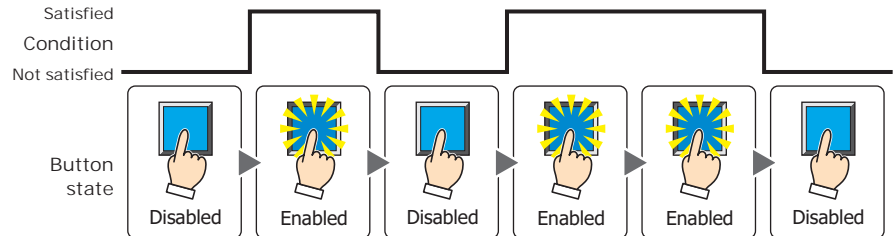

- Data Type:** Selects the type of data handled by the conditional expression for the input condition. This option can only be configured if **While satisfying the condition** is selected for **Trigger Type**. For details, refer to Chapter 2 "1.1 Available Data" on page 2-1.
- Device Address:** Specifies the bit device or the bit number of the word device to serve as the input condition. This option can only be configured when **While ON** or **While OFF** is selected for **Trigger Type**. Click to display the Tag Editor. For the device address configuration procedure, refer to Chapter 2 "5.1 Device Address Settings" on page 2-70.
- Condition:** Specifies the conditional expression for the input condition. This option can only be configured when **While satisfying the condition** is selected for **Trigger Type**. Click to display the **Trigger Condition Settings** dialog box. For the conditional expression configuration procedure, refer to Chapter 2 "5.2 Setting Conditional Expressions" on page 2-73.
- Comment:** Used for entering a comment for the input condition. The maximum number is 80 characters.

■ **Visible Condition**

The Button is displayed while the condition is satisfied. The Button is hidden while the condition is not satisfied.

Example: When **Trigger Type** is **While ON** and **Device Address** is **LM0**
 While LM0 is 0, the condition is not satisfied and the Button is hidden.
 While LM0 is 1, the condition is satisfied and the Button is displayed.

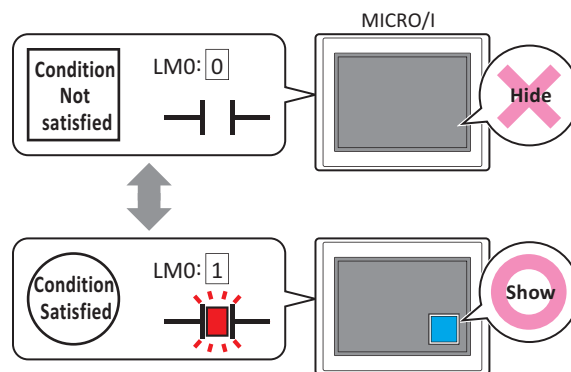

When the **ON delay** check box is selected on the **Options** tab, if the button is hidden before the set time elapses from when the button begins to be pressed, the on delay is reset and the button does not operate.

Trigger Type: Selects the condition to display the Button from the following.

Always visible: The Button is always displayed.

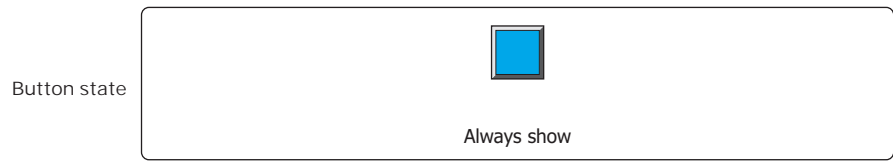

While ON: Displays the Button when the value of device address is 1.

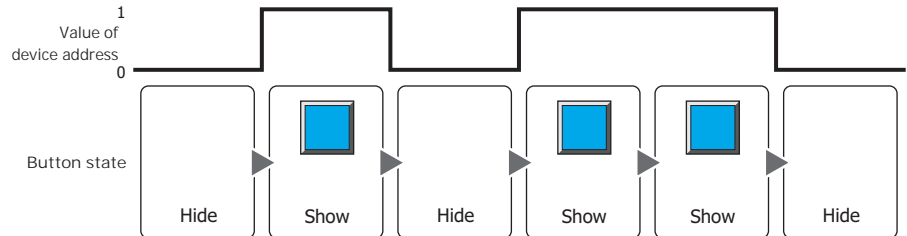

While OFF: Displays the Button when the value of device address is 0.

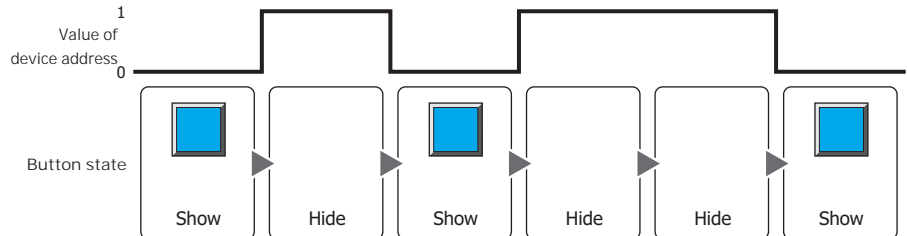

While satisfying the condition: Displays the Button when the condition is satisfied.

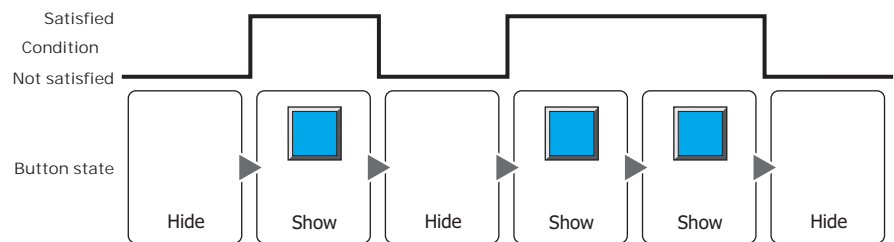

Data Type: Selects the type of data handled by the conditional expression for the visible condition.

This option can only be configured if **While satisfying the condition** is selected for **Trigger Type**.

For details, refer to Chapter 2 "1.1 Available Data" on page 2-1.

Device Address: Specifies the bit device or the bit number of the word device to serve as the visible condition.

This option can only be configured when **While ON** or **While OFF** is selected for **Trigger Type**.

Click to display the Tag Editor. For the device address configuration procedure, refer to Chapter 2 "5.1 Device Address Settings" on page 2-70.

Condition: Specifies the conditional expression for the visible condition.

This option can only be configured when **While satisfying the condition** is selected for **Trigger Type**.

Click to display the **Trigger Condition Settings** dialog box. For the conditional expression configuration procedure, refer to Chapter 2 "5.2 Setting Conditional Expressions" on page 2-73.

Comment: Used for entering a comment for the visible condition. The maximum number is 80 characters.

● Options Tab

The **Options** tab is displayed in Advanced mode.

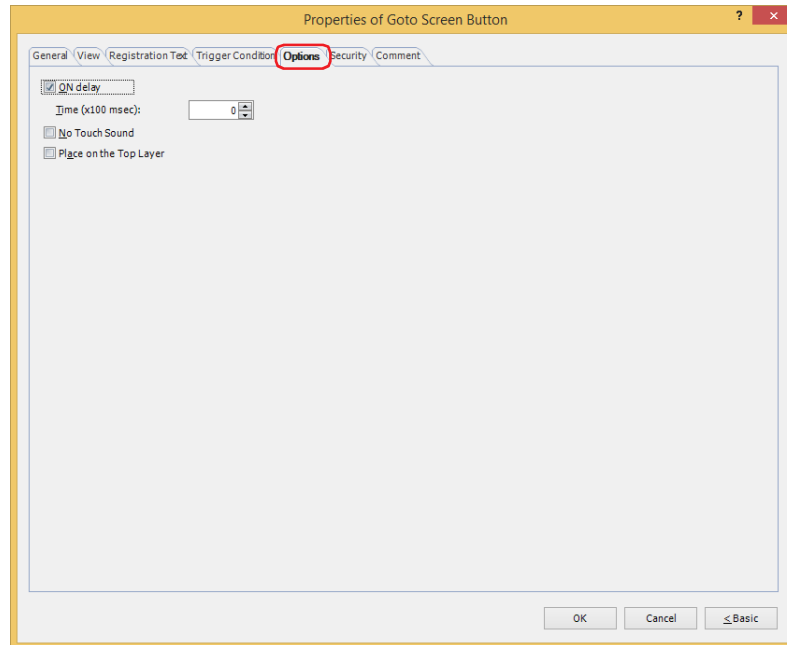

■ ON delay

Select this check box to use the ON delay function.

Time (x100 msec): Specify the length of time that the button must be held down before activation by selecting a value from 0 to 600 (units of 10 ms).
The button activates after it is held down for a specified period of time.

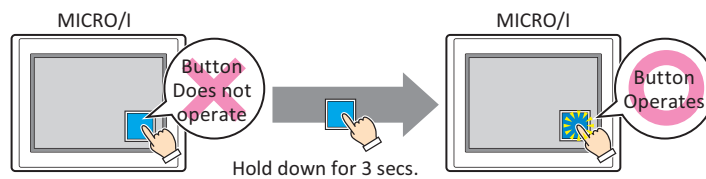

This feature protects against mistaken operation by ensuring that the button will not be activated if touched accidentally.

■ No Touch Sound

This function is to disable touch sounds only for specified parts when the MICRO/I makes touch sounds. Select this check box to display disable touch sounds for this part.



To enable touch sounds on the MICRO/I, select the **Enable Touch Sound** check box under the **System** tab of the **Project Settings** dialog box.

■ Place on the Top Layer

Select this check box to display the parts on the top layer. The parts will have precedence when other drawings and parts are overlapping with it. For details, refer to Chapter 6 "4 Drawings and Parts Overlapping" on page 6-5.

● Security Tab

This tab is used to restrict displaying and using the part by security groups.

This option can only be set when **Use Security functions** is selected. The **Use Security functions** check box is set on **General** tab in the **Security** dialog box.

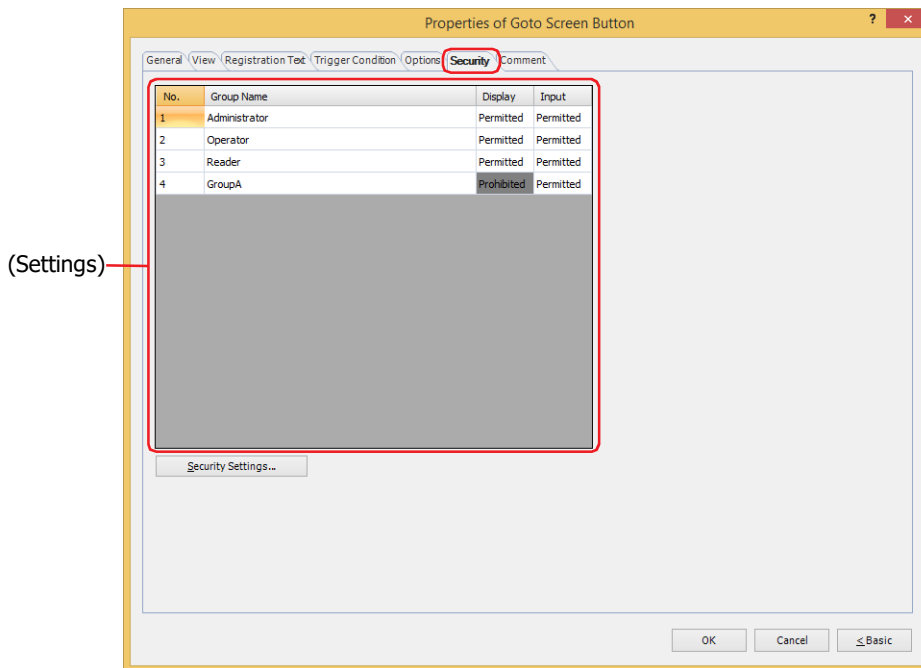

■ (Settings)

Displays the list of security groups used on the MICRO/I.

- No.:
- Displays the security group numbers (1 to 15).
- Group Name:
- Displays the name of the security group.
- Display:
- Displays whether or not there is permission to display the part. Only **Permitted** security groups can display this part. If all security groups are set to **Permitted**, this part will be displayed even if no user account has been selected. Double clicking the cell switches between **Permitted** and **Prohibited**.
- Input:
- Displays whether or not there is permission to use the part. Only **Permitted** security groups can use this part. If all security groups are set to **Permitted**, this part can be used even if no user account has been selected. Double clicking the cell switches between **Permitted** and **Prohibited**.



- You can also switch between **Permitted** and **Prohibited** by right-clicking on a **Display** or **Input** cell.
- Restricting the display and use of the part by switching between **Permitted** and **Prohibited** in **Display** and **Input** cells is similar to using the **Trigger Condition** tab.



■ Security Settings

The Security Settings dialog box is displayed. If you create a security group in the **Security Settings** dialog box, you can select that created group. For details, refer to Chapter 23 “2.2 Adding and Editing Security Groups” on page 23-19.



For details about security functions, refer to Chapter 23 “User Accounts and the Security Function” on page 23-1.

Example: If the user and security group for a part are set as follows:

User Name	 User1	 User2	 User3
Security Group	Reader	Operator	Administrator

MICRO/I

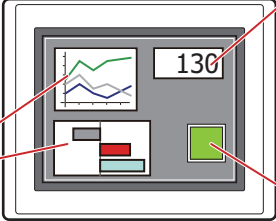

Line Chart and Bar Chart

No.	Group Name	Display
1	Administrator	Permitted
2	Operator	Permitted
3	Reader	Prohibited

Numerical Display

No.	Group Name	Display
1	Administrator	Permitted
2	Operator	Permitted
3	Reader	Permitted

Button

No.	Group Name	Display	Input
1	Administrator	Permitted	Permitted
2	Operator	Permitted	Prohibited
3	Reader	Prohibited	Prohibited

For User1 in the **Reader** security group, the parts for which **Display** has been set to **Prohibited** for **Reader** will not be displayed.

If the password screen is opened and the user switches to User2 in the **Operator** security group, the parts for which **Display** has been set to **Permitted** for **Operator** will be displayed.

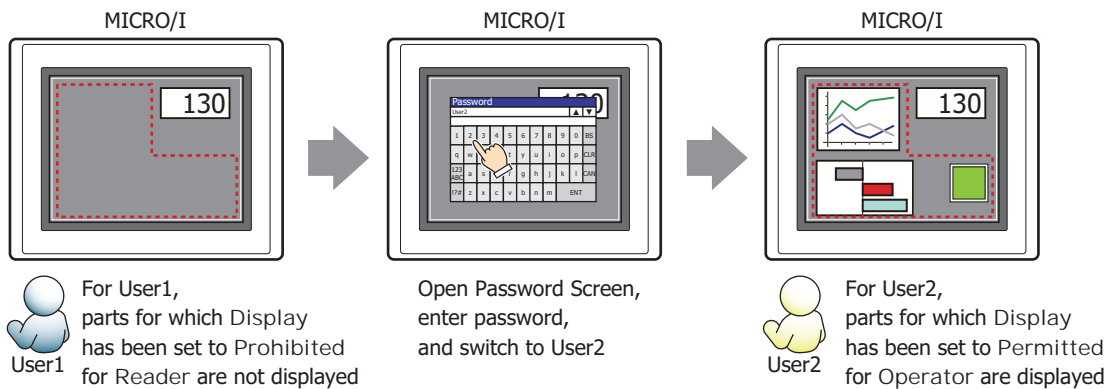

For User2 in **Operator**, **Display** has been set to **Permitted** for **Operator**, but **Input** is **Prohibited**, so the part cannot be used.

If the password screen is opened and the user switches to User3 in the **Administrator** security group, the parts for which **Display** has been set to **Permitted** for **Administrator** will be displayed, and the parts for which **Input** has been set to **Permitted** for **Administrator** can be used.

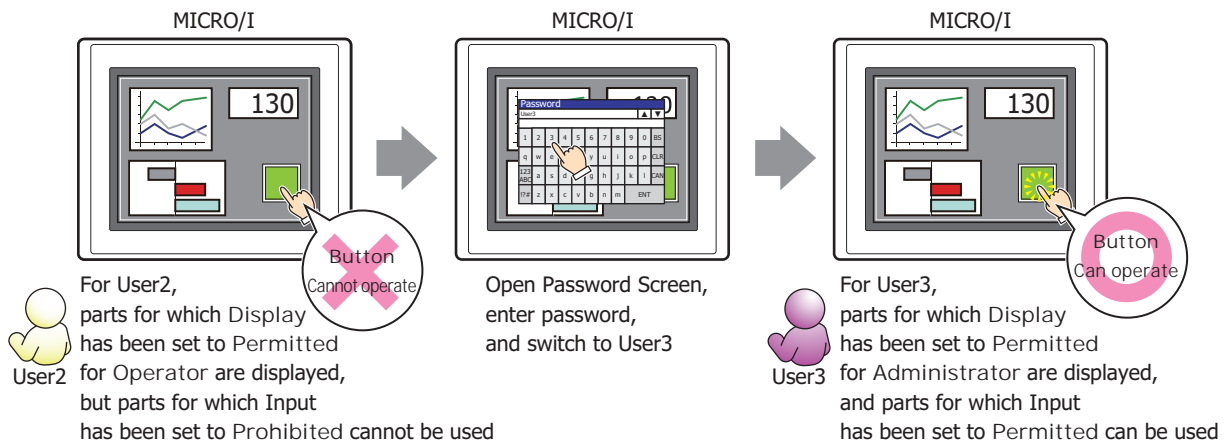

● Comment Tab

The **Comment** tab is used to specify the parts placed on the editing screen, and the popup text displayed when the mouse pointer is placed close to **No.**, **Name**, or **Type** in the object list.



When there are multiple parts of the same shape on the screen, this feature makes it possible to distinguish between the parts without displaying the Properties dialog box for each part, by just mousing over the part.

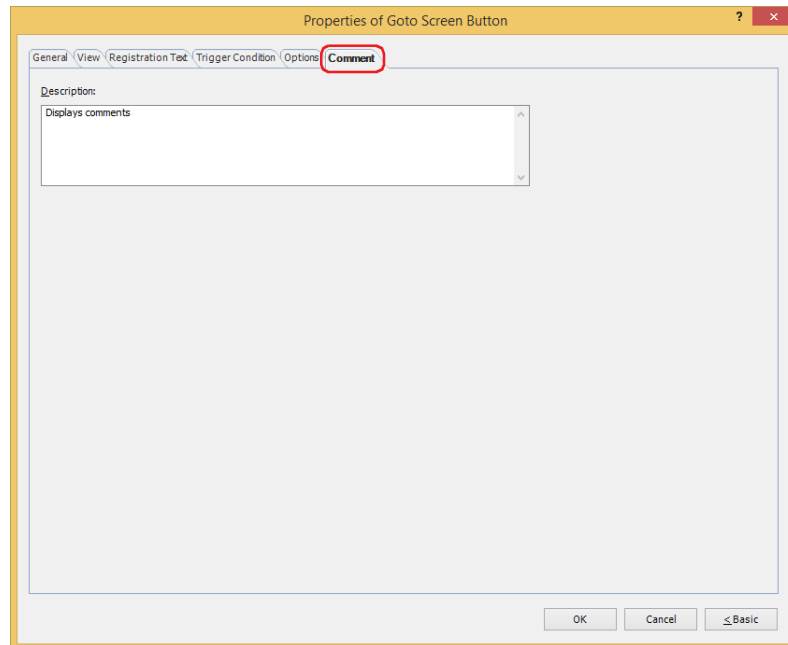

■ Description

Used for entering comments about parts. The maximum number is 80 characters.

Example: When mousing over the Button on the editing screen

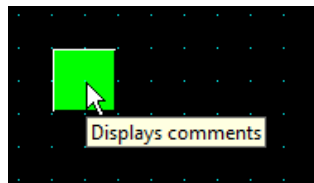

4 Print Button

HG2J-7U HG5G-V HG4G-V HG4G HG3G-V HG3G HG2G-V HG2G-5F HG2G-5T HG1G HG1P

4.1 How the Print Button is Used

Outputs a screenshot to a printer*1 or an external memory device*2.

- Pressing the Print Button outputs a screenshot of the current screen to the printer*1.

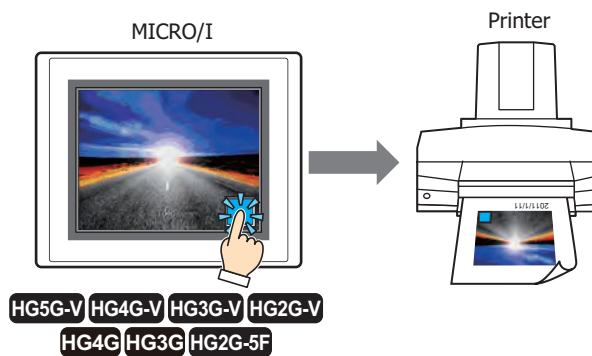

Refer to Chapter 32 "1.2 Connecting a Printer to MICRO/I" on page 32-1 for compatible printers and instructions on how to connect one to the MICRO/I.

- Pressing the Print Button outputs a screenshot of the current screen to an external memory device*2.

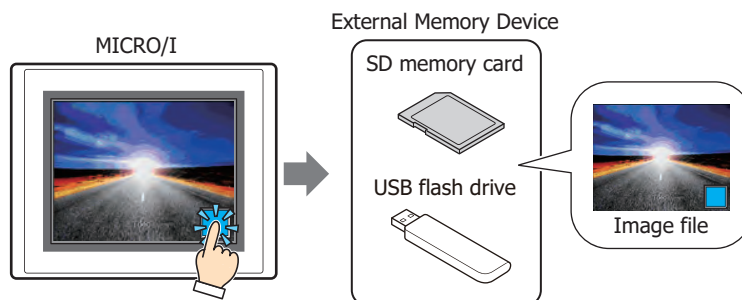

*1 HG5G/4G/3G/2G-V, HG4G/3G, HG2G-5F only

*2 USB flash drive inserted in USB1 for HG2J-7U, SD memory card for HG5G/4G/3G/2G-V, HG4G/3G and HG2G-5F, USB flash drive for HG2G-5T and HG1G/1P

4.2 Print Button Configuration Procedure

This section describes the configuration procedure for Print Buttons.

- 1 On the **Home** tab, in the **Parts** group, click **Buttons**, and then click **Print Button**.

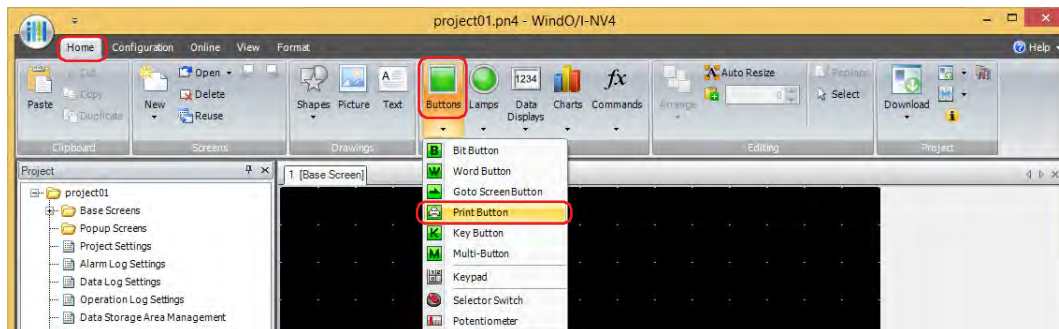

- 2 Click a point on the edit screen where you wish to place the Print Button.
- 3 Double-click the placed Print Button and a Properties dialog box will be displayed.
- 4 Change the settings on each tab as necessary.

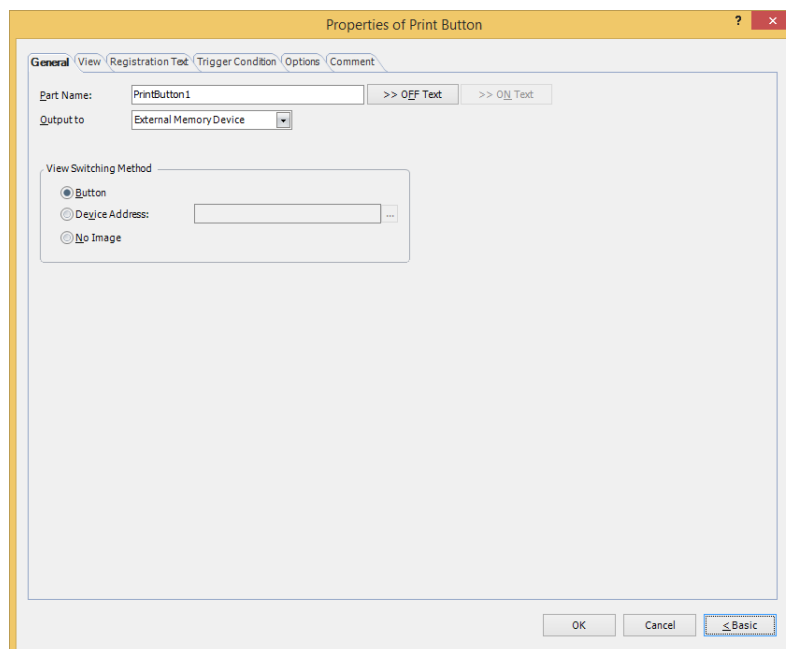

The **Trigger Condition** tab and **Options** tab only appear in Advanced mode.



You can set the default for the Print Button on the **Default Preferences** tab of the **WindO/I-NV4 Options** dialog box. For details, refer to Chapter 2 "Default Preferences Tab" on page 2-63.

4.3 Properties of Print Button Dialog Box

This section describes items and buttons in the Properties dialog box.

● General Tab

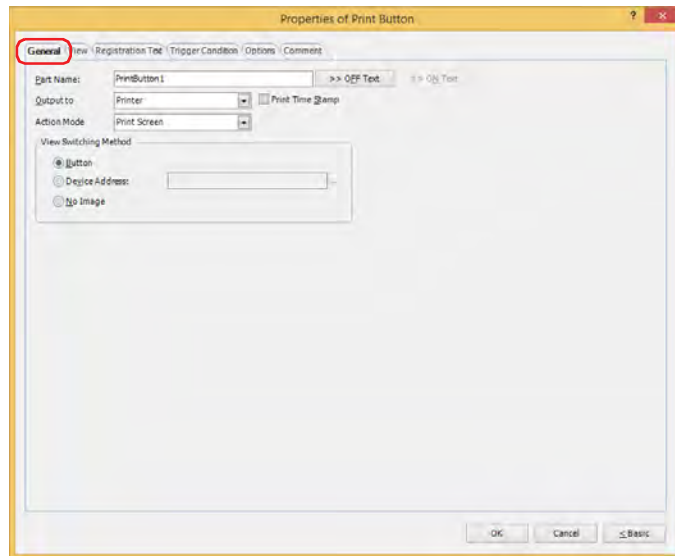

■ Part Name

Enter a name for the part. The maximum number is 20 characters.

■ >>OFF Text, <<ON Text

Applies the text entered in the **Part Name** field to the **Text** field under the **OFF** or **ON** fields on the **Registration Text** tab. This is used as the Registration Text when the button is OFF or ON.



To specify the Registration Text to use when the button is ON, place a check in the **Set by State** check box on the **Registration Text** tab. If left unchecked, the same Registration Text assigned for the OFF state is displayed for the ON state as well.

■ Output to

Select where to direct the screenshot to.

Printer^{*1}:

Outputs the screenshot to the printer connected to the MICRO/I.

Print Time Stamp: Adds the date and time of printing to the screenshot before sending it to the printer.

The date and time format depends on the language selected in **Language**. **Language** is available on the **Project Details** tab of the **Project Settings** dialog box.

The display formats are shown below:

- Japanese: YYYY/MM/DD hh:mm
- English: MM/DD/YYYY hh:mm

YYYY: year, MM: month, DD: day, hh: hour, mm: minute

External Memory Device^{*2}: Outputs the screenshot as a file to the external memory device inserted in the MICRO/I. Files are output as follows:

File format	File name	File size
JPEG	CAP***.JPG (***: date and time when file was output) Example: A file created at 18:50:25 on June 30, 2011 will be named "CAP110630_185025.JPG".	Depends on image being displayed.



- For details about printers, refer to Chapter 32 "Printer" on page 32-1.
- For details about external memory devices, refer to Chapter 31 "External Memory Devices" on page 31-1.

*1 HG5G/4G/3G/2G-V, HG4G/3G, HG2G-5F only

*2 USB flash drive inserted in USB1 for HG2J-7U, SD memory card for HG5G/4G/3G/2G-V, HG4G/3G and HG2G-5F, USB flash drive for HG2G-5T and HG1G/1P

■ Action Mode

Select the behavior of the button from the following. This option is displayed only when **Printer** is selected in **Output to**.

Print Screen: Outputs a screenshot of the current screen to the printer or the external memory device

Cancel Printing*¹: Cancels printout to the printer.

■ View Switching Method*³

Select how to display the ON/OFF status of the button.

Button: Pressing the button changes the drawing object displayed.

Device Address: The drawing objects assigned to the OFF and ON states are displayed when the value of the device address is 0 and 1, respectively. Specifies the device address used to switch the drawing object display.

Click  to display the Tag Editor. For the device address configuration procedure, refer to Chapter 2 "5.1 Device Address Settings" on page 2-70.

No Image: The button is not displayed on the screen. The button appears as a dashed line frame on the edit screen. Pressing the corresponding area on the MICRO/I activates the assigned function. If **No Image** is selected, the settings for **View** and **Registration Text** are disabled.



Selecting **Device Address** in **View Switching Method** allows you to create an illuminated pushbutton. The illuminated pushbutton switches state (or image) according to ON or OFF state of the device address, allowing you to display the state of a device that is being operated.

Example: When you set an external device address 'M0' as **Device Address** in **View Switching Method**, if the value of M0 changes, the display image will be switched according to the value of M0 even if the button is not pressed.

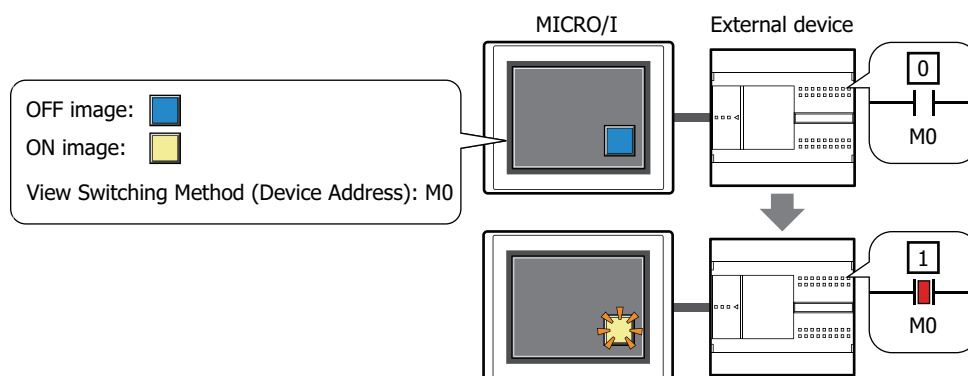

- These operations cannot be performed simultaneously.
 - Outputting to the external memory device by pressing the Print Button.
 - Outputting to the printer by pressing the Print Button*¹.
 - Printing alarm logs
- While the screenshot is being output to the external memory device, the Print Button or Print Command cannot output to one. Also, during these situations, the value of HMI Special Relay LSM24 or LSM25 changes to 1. For details, refer to Chapter 33 "HMI Special Relay (LSM)" on page 33-2.
- It may take some time to output screenshots when copying files using the USB Autorun function or a Key Button.
- MICRO/I cannot stop printing in the middle of a page, even when the print job is canceled. Print jobs after the current print job are canceled after the current page finishes printing.



The maximum number of screenshots that can be captured (1 to 999) can be set in HMI Special Data Registers LSD65. (Default: 99)

*1 HG5G/4G/3G/2G-V, HG4G/3G, HG2G-5F only

*3 Advanced mode only



The methods to erase screenshot files saved on the external memory device are as follows.

- To erase files during operation using parts, on the **External Memory Device** tab on the **Project Settings** dialog box, select the **Remove Files** check box and the **All Screenshot data** check box, and then configure the trigger device address. Assign that trigger device address to a part.
 - To erase files with WindO/I-NV4, click **Clear** on the **Online** tab, and then click **Stored Data in External Memory Device** to open the **Clear Data** dialog box. Select the **Screenshot Data** check box and click **OK**.
 - To erase files on the HG5G/4G/3G/2G-V, HG4G/3G and the HG2G-5F, go to the System Mode - File Manager. In the File Manager, select the files to be deleted by pressing **DEL**.
-

● View Tab

Only **Coordinates** and **Size** can be configured when **No Image** is selected for **View Switching Method** on the **General** tab.

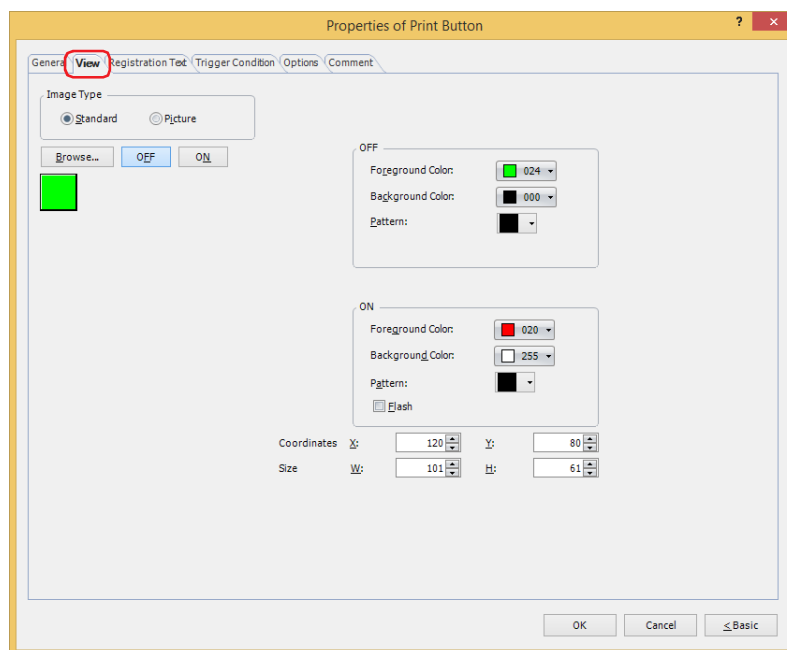

■ Image Type

Select the type of graphic to be used to represent the part.

Standard: Uses the default graphics contained within WindO/I-NV4.

Picture: Uses an image file saved in the Picture Manager.
For details about image file restrictions, refer to Chapter 2 "1.4 Available Image Files" on page 2-20.

■ Browse

Select the type of graphic to be used to represent the part from the list of graphics. Click this button to display the View Browser or Picture Manager, depending on the setting for **Image Type**.

■ OFF button, ON button

Displays the graphic when ON or OFF. Clicking **ON** or **OFF** switches the image displayed on the **View** tab.

■ OFF, ON

Selects the color and pattern of the standard graphic when ON and OFF.

Foreground Color, Background Color: Selects the foreground and background colors of the standard graphic (color: 256 colors, monochrome: 16 shades).
Click **Color** to display the Color Palette. Select a color from the Color Palette.

Pattern: Selects a pattern or tonal gradation for the standard graphic.
Click **Pattern** to display the Pattern Palette. Select a pattern or tonal gradation from the Pattern Palette.

■ Flash

Select this check box if flashing is desired (alternating ON and OFF) when a part is ON.

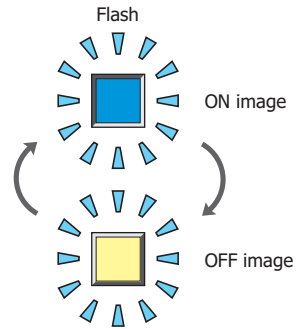

■ Coordinates

X, Y: Sets the display position of parts using coordinates.

The X and Y coordinates of parts are defined relative to an origin at the top-left corner of the screen.

X: 0 to (base screen horizontal size - 1)

Y: 0 to (base screen vertical size - 1)

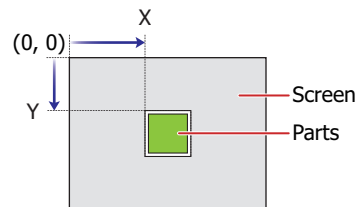

■ Size

W, H: Sets width and height to define the size of parts.

W: 20 to (base screen horizontal size)

H: 20 to (base screen vertical size)

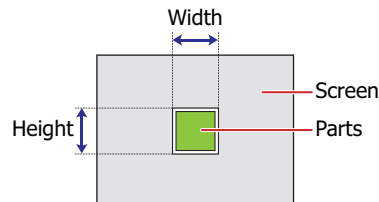

● **Registration Text Tab**

These options can only be configured when **Button** or **Device Address** is selected for **View Switching Method** on the **General** tab.

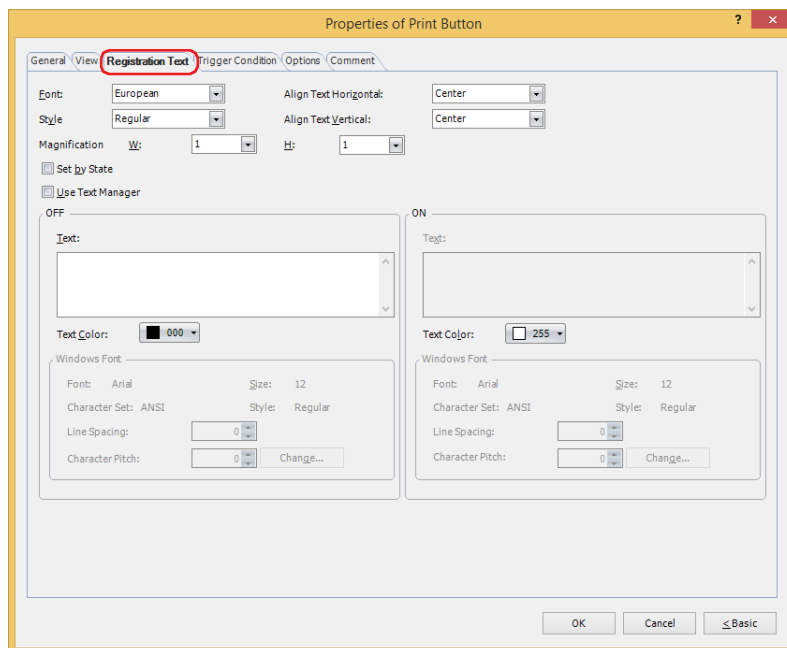

■ **Font**

Selects the font used for displaying text from the following.

Western, Japanese, Simplified Chinese, Traditional Chinese, Hangul, Central European, Baltic, Cyrillic, Windows, Stroke*1

Can only be set when the **Use Text Manager** check box is cleared.

The characters that can be displayed depend on the font. For details, refer to Chapter 2 "1.2 Available Text" on page 2-6.

■ **Style***1

Selects **Regular** or **Bold** for text style.

Can only be set when **Font** is set to **Western, Japanese, Simplified Chinese, Traditional Chinese, Hangul, Central European, Baltic, Cyrillic**.

■ **Size**

Specifies the text size to be displayed. The fonts and sizes that can be set vary based on the model.

Model	Font	Size
HG2J-7U	Western, Japanese, Simplified Chinese, Traditional Chinese, Hangul, Central European, Baltic, Cyrillic	8 to 512
HG5G/4G/3G/2G-V, HG4G/3G, HG2G-5F/-5T, HG1G/1P	Stroke	8 to 128

■ **Magnification***1

W, H: Selects the magnification (0.5, 1 to 8) for text display.

Can only be set when **Font** is set to **Western, Japanese, Simplified Chinese, Traditional Chinese, Hangul, Central European, Baltic, Cyrillic**.

■ **Align Text Horizontal**

Selects text alignment in the horizontal direction.

Left, Center, Right, Center-Left

For details, refer to Appendix "5 Text Alignment" on page A-7.

*1 HG5G/4G/3G/2G-V, HG4G/3G, HG2G-5F/-5T, HG1G/1P only

■ Align Text Vertical

Selects text alignment in the vertical direction.

Top, Center, Bottom

This option can only be configured when **Left**, **Center**, or **Right** is selected for **Align Text Horizontal**. If **Center-Left** is selected for **Align Text Horizontal**, **Center-Top** is set as this option.

For details, refer to Appendix "5 Text Alignment" on page A-7.

■ Set by State

Select this check box if displaying different text when ON and OFF.

■ Use Text Manager

Select this check box if using the text registered in Text Manager for text display.

■ OFF, ON

- Text:** Inputs characters to be displayed on parts. The maximum number is 3,750 characters.
The characters that can be entered depend on the font selected using **Font**. For details, refer to Chapter 2 "1.2 Available Text" on page 2-6.
- Text ID:** Specifies the Text Manager ID No. (1 to 32000) when using the text registered in the Text Manager.
Click  to display Text Manager.
Can only be set when the **Use Text Manager** check box is selected.
- Text Color:** Selects the color of the text displayed on the part (color: 256 colors, monochrome: 16 shades).
Click **Color** to display the Color Palette. Select a color from the Color Palette.
- Windows Font:** Sets the font to be used as the Windows Font.
Select **Windows** using **Font** to display the current setting. You can specify the character spacing (0 to 100) and the line spacing (0 to 100). To change the settings other than the character spacing and line spacing, click **Change** to display the **Font Settings** dialog box.
Can only be set when the **Use Text Manager** check box is cleared.
For details, refer to Chapter 2 "Windows Font" on page 2-13.

● Trigger Condition Tab

The **Trigger Condition** tab is displayed in Advanced mode.

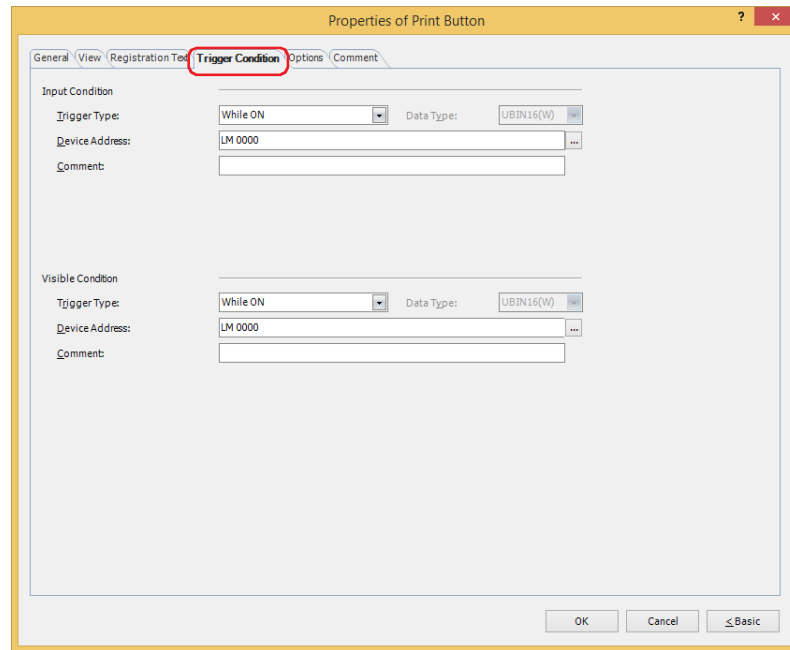

■ Input Condition

The Button is enabled and operational while the condition is satisfied. The Button is disabled and not operational while the condition is not satisfied.

Example: When **Trigger Type** is **While ON** and **Device Address** is **LM0**

While LM0 is 0, the condition is not satisfied and the Button is not operational.

While LM0 is 1, the condition is satisfied and the Button is operational.

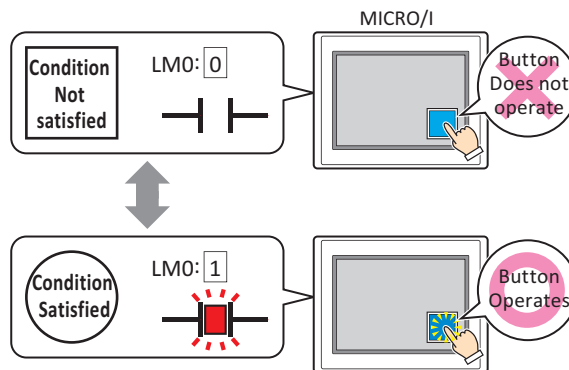

Trigger Type: Selects the condition to enable the Button from the following.

Always enable: The Button is always enabled.



While ON: Enables the Button when the value of device address is 1.

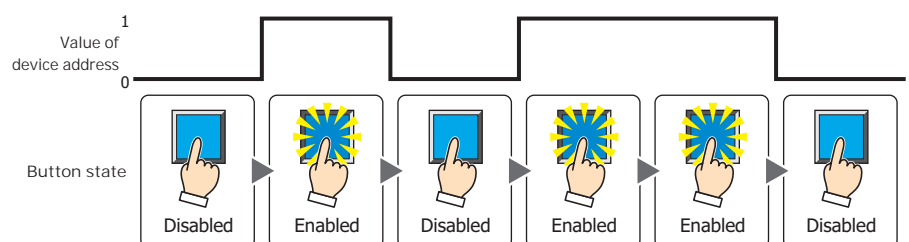

While OFF: Enables the Button when the value of device address is 0.

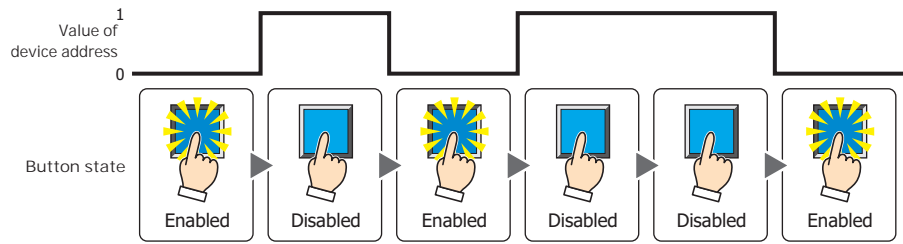

While satisfying the condition: Enables the Button when the condition is satisfied.

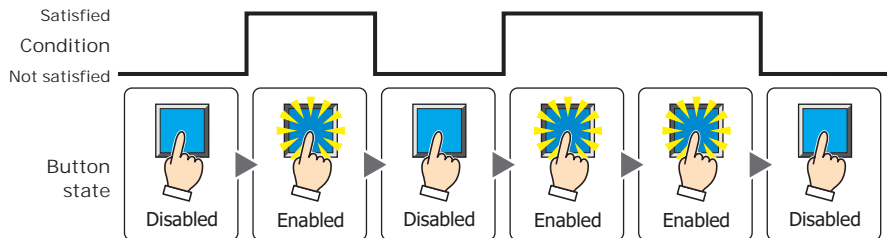

- Data Type:** Selects the type of data handled by the conditional expression for the input condition. This option can only be configured if **While satisfying the condition** is selected for **Trigger Type**. For details, refer to Chapter 2 "1.1 Available Data" on page 2-1.
- Device Address:** Specifies the bit device or the bit number of the word device to serve as the input condition. This option can only be configured when **While ON** or **While OFF** is selected for **Trigger Type**. Click **...** to display the Tag Editor. For the device address configuration procedure, refer to Chapter 2 "5.1 Device Address Settings" on page 2-70.
- Condition:** Specifies the conditional expression for the input condition. This option can only be configured when **While satisfying the condition** is selected for **Trigger Type**. Click **...** to display the **Trigger Condition Settings** dialog box. For the conditional expression configuration procedure, refer to Chapter 2 "5.2 Setting Conditional Expressions" on page 2-73.
- Comment:** Used for entering a comment for the input condition. The maximum number is 80 characters.

■ **Visible Condition**

The Button is displayed while the condition is satisfied. The Button is hidden while the condition is not satisfied.

Example: When **Trigger Type** is **While ON** and **Device Address** is **LM0**
 While LM0 is 0, the condition is not satisfied and the Button is hidden.
 While LM0 is 1, the condition is satisfied and the Button is displayed.

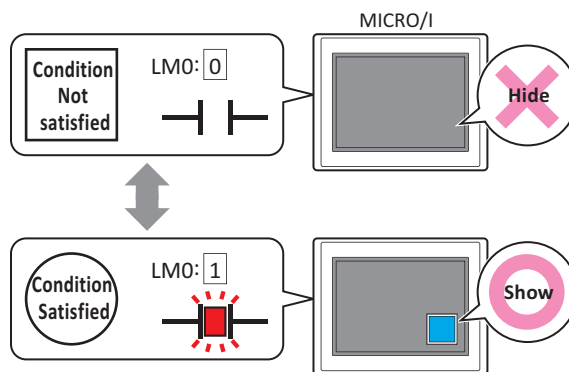

When the **ON delay** check box is selected on the **Options** tab, if the button is hidden before the set time elapses from when the button begins to be pressed, the on delay is reset and the button does not operate.

Trigger Type: Selects the condition to display the Button from the following.

Always visible: The Button is always displayed.

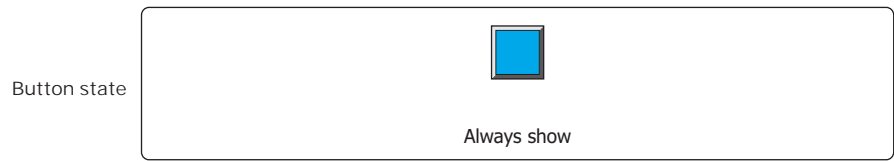

While ON: Displays the Button when the value of device address is 1.

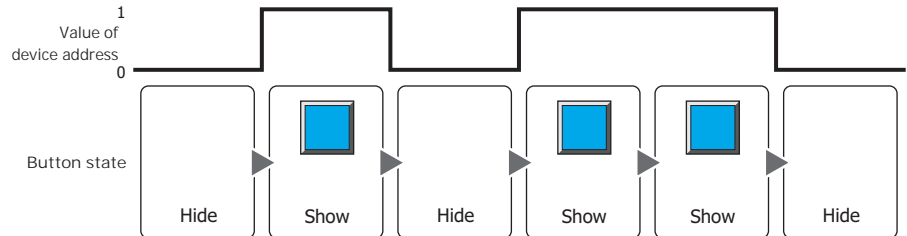

While OFF: Displays the Button when the value of device address is 0.

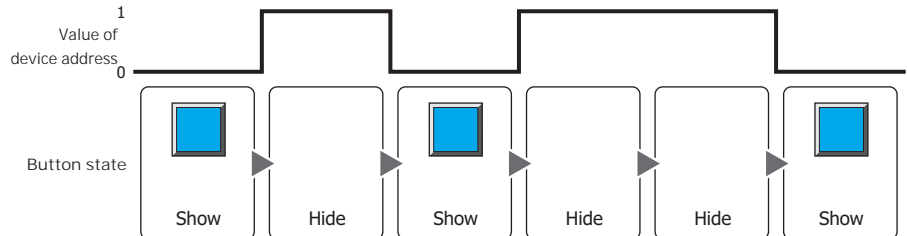

While satisfying the condition: Displays the Button when the condition is satisfied.

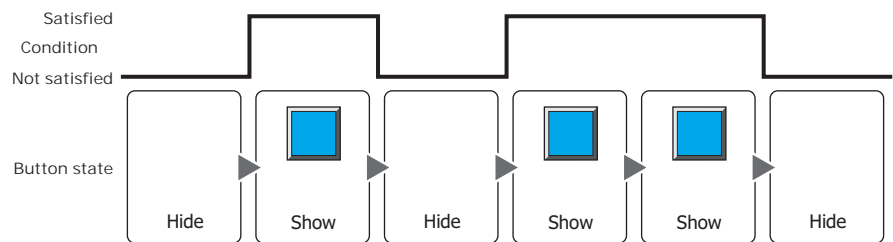

Data Type: Selects the type of data handled by the conditional expression for the visible condition. This option can only be configured if **While satisfying the condition** is selected for **Trigger Type**. For details, refer to Chapter 2 "1.1 Available Data" on page 2-1.

Device Address: Specifies the bit device or the bit number of the word device to serve as the visible condition. This option can only be configured when **While ON** or **While OFF** is selected for **Trigger Type**.

Click to display the Tag Editor. For the device address configuration procedure, refer to Chapter 2 "5.1 Device Address Settings" on page 2-70.

Condition: Specifies the conditional expression for the visible condition. This option can only be configured when **While satisfying the condition** is selected for **Trigger Type**.

Click to display the **Trigger Condition Settings** dialog box. For the conditional expression configuration procedure, refer to Chapter 2 "5.2 Setting Conditional Expressions" on page 2-73.

Comment: Used for entering a comment for the visible condition. The maximum number is 80 characters.

● Options Tab

The **Options** tab is displayed in Advanced mode.

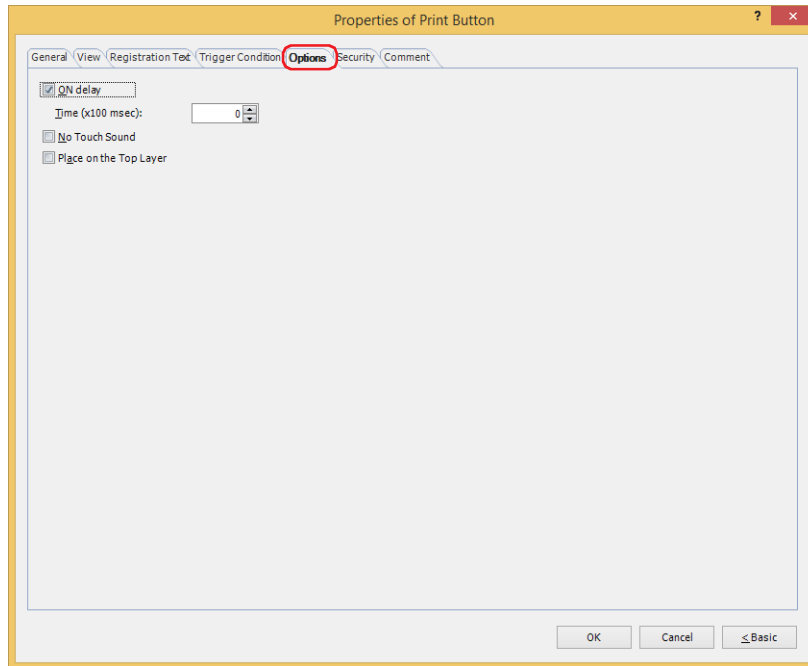

■ ON delay

Select this check box to use the ON delay function.

Time (x100 msec): Specify the length of time that the button must be held down before activation by selecting a value from 0 to 600 (units of 10 ms).
The button activates after it is held down for a specified period of time.

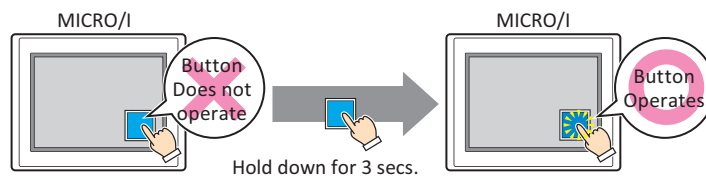

This feature protects against mistaken operation by ensuring that the button will not be activated if touched accidentally.

■ No Touch Sound

This function is to disable touch sounds only for specified parts when the MICRO/I makes touch sounds.

Select this check box to display disable touch sounds for this part.



To enable touch sounds on the MICRO/I, select the **Enable Touch Sound** check box under the **System** tab of the **Project Settings** dialog box.

■ Place on the Top Layer

Select this check box to display the parts on the top layer. The parts will have precedence when other drawings and parts are overlapping with it. For details, refer to Chapter 6 "4 Drawings and Parts Overlapping" on page 6-5.

● Security Tab

This tab is used to restrict displaying and using the part by security groups.

This option can only be set when **Use Security functions** is selected. The **Use Security functions** check box is set on **General** tab in the **Security** dialog box.

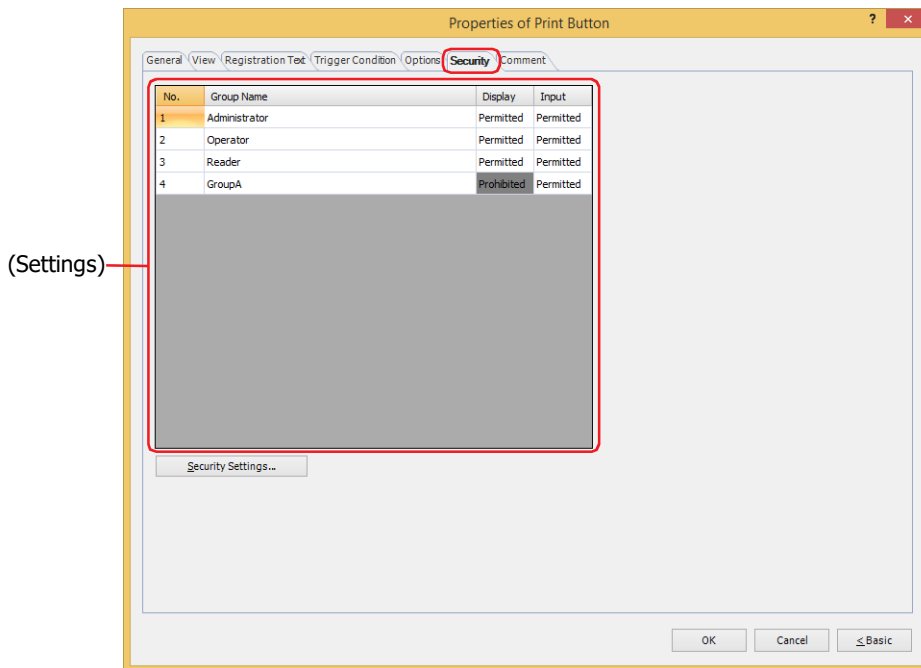

■ (Settings)

Displays the list of security groups used on the MICRO/I.

- No.:
- Displays the security group numbers (1 to 15).
- Group Name:
- Displays the name of the security group.
- Display:
- Displays whether or not there is permission to display the part. Only **Permitted** security groups can display this part. If all security groups are set to **Permitted**, this part will be displayed even if no user account has been selected. Double clicking the cell switches between **Permitted** and **Prohibited**.
- Input:
- Displays whether or not there is permission to use the part. Only **Permitted** security groups can use this part. If all security groups are set to **Permitted**, this part can be used even if no user account has been selected. Double clicking the cell switches between **Permitted** and **Prohibited**.



- You can also switch between **Permitted** and **Prohibited** by right-clicking on a **Display** or **Input** cell.
- Restricting the display and use of the part by switching between **Permitted** and **Prohibited** in **Display** and **Input** cells is similar to using the **Trigger Condition** tab.



■ Security Settings

The Security Settings dialog box is displayed. If you create a security group in the **Security Settings** dialog box, you can select that created group. For details, refer to Chapter 23 "2.2 Adding and Editing Security Groups" on page 23-19.



For details about security functions, refer to Chapter 23 "User Accounts and the Security Function" on page 23-1.

Example: If the user and security group for a part are set as follows:

User Name	 User1	 User2	 User3
Security Group	Reader	Operator	Administrator

MICRO/I

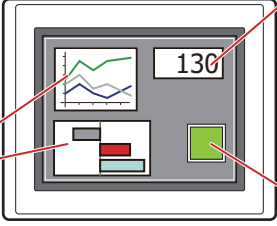

Line Chart and Bar Chart

No.	Group Name	Display
1	Administrator	Permitted
2	Operator	Permitted
3	Reader	Prohibited

Numerical Display

No.	Group Name	Display
1	Administrator	Permitted
2	Operator	Permitted
3	Reader	Permitted

Button

No.	Group Name	Display	Input
1	Administrator	Permitted	Permitted
2	Operator	Permitted	Prohibited
3	Reader	Prohibited	Prohibited

For User1 in the **Reader** security group, the parts for which **Display** has been set to **Prohibited** for **Reader** will not be displayed.

If the password screen is opened and the user switches to User2 in the **Operator** security group, the parts for which **Display** has been set to **Permitted** for **Operator** will be displayed.

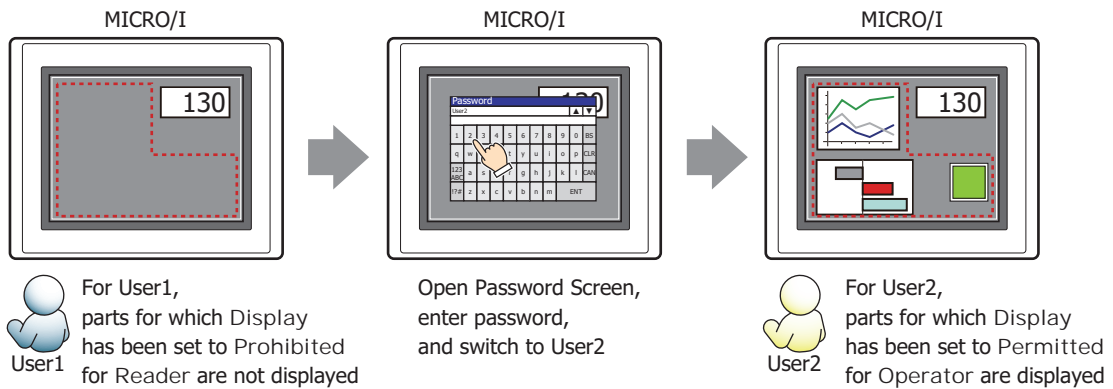

For User2 in **Operator**, **Display** has been set to **Permitted** for **Operator**, but **Input** is **Prohibited**, so the part cannot be used.

If the password screen is opened and the user switches to User3 in the **Administrator** security group, the parts for which **Display** has been set to **Permitted** for **Administrator** will be displayed, and the parts for which **Input** has been set to **Permitted** for **Administrator** can be used.

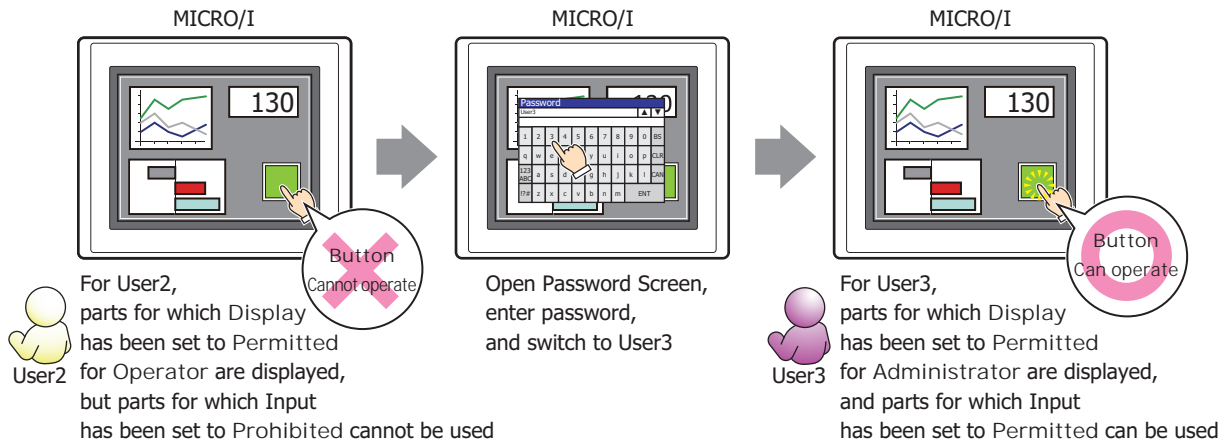

● Comment Tab

The **Comment** tab is used to specify the parts placed on the editing screen, and the popup text displayed when the mouse pointer is placed close to **No.**, **Name**, or **Type** in the object list.



When there are multiple parts of the same shape on the screen, this feature makes it possible to distinguish between the parts without displaying the Properties dialog box for each part, by just mousing over the part.

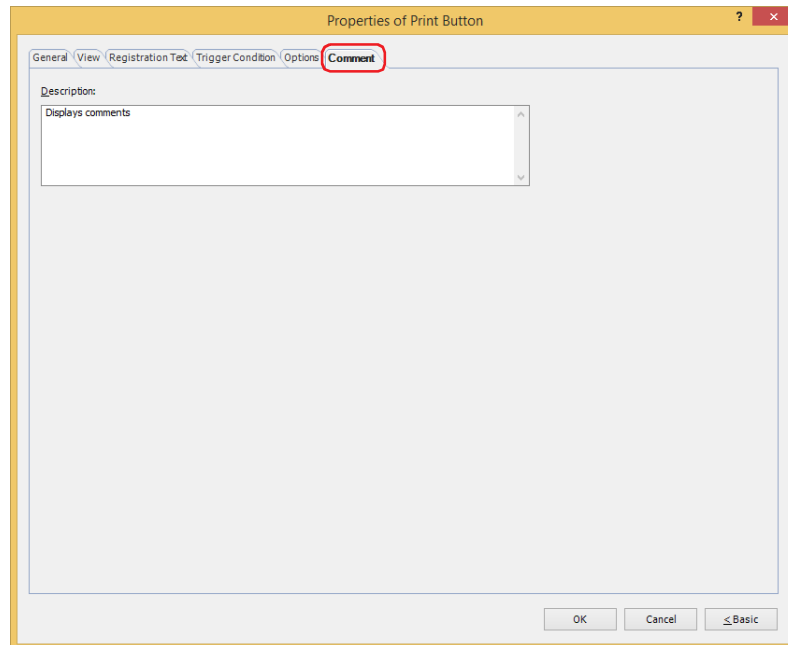

■ Description

Used for entering comments about parts. The maximum number is 80 characters.

Example: When mousing over the Button on the editing screen

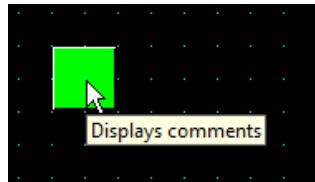

5 Key Button

HG2J-7U HG5G-V HG4G-V HG4G HG3G-V HG3G HG2G-V HG2G-5F HG2G-5T HG1G HG1P

5.1 How the Key Button is Used

Performs a variety of functions including uploading and downloading, copying files, and operating other parts.

- Entering numbers in the Numerical Input

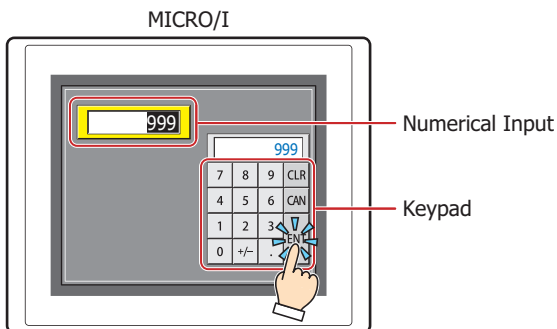

- Entering characters in the Character Input

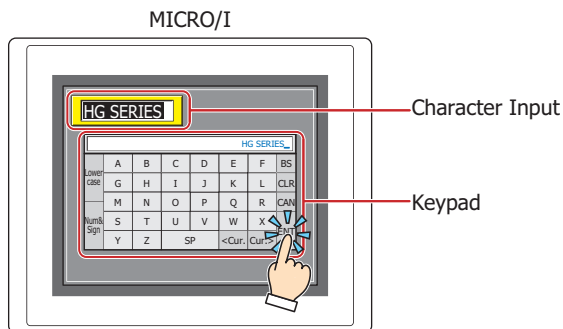

- Operating the Alarm List Display or Alarm Log Display

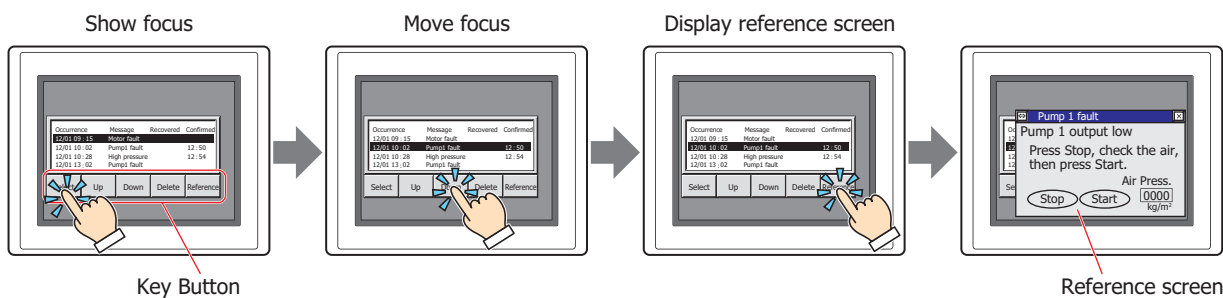

- Copying and recovering data archived on the SD memory card, inserted in the MICRO/I, to the USB flash drive.

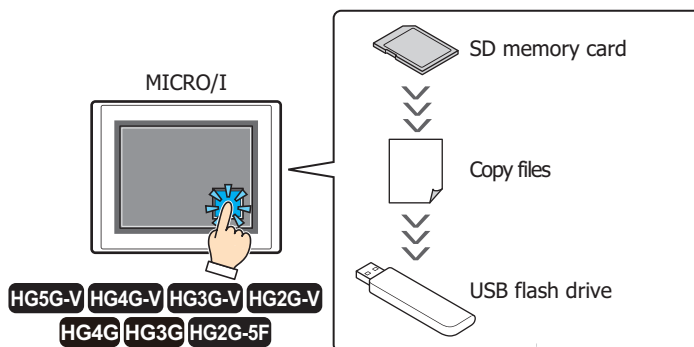

- Operating the Video Display*¹

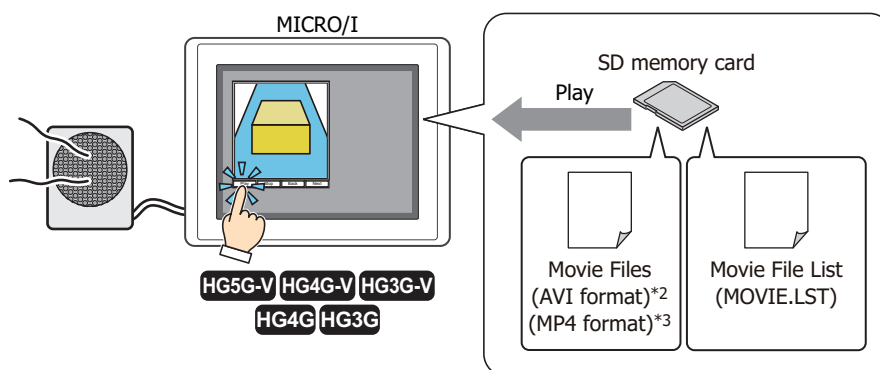

- Record images from a video camera and microphone audio*⁴ to an external memory device*¹

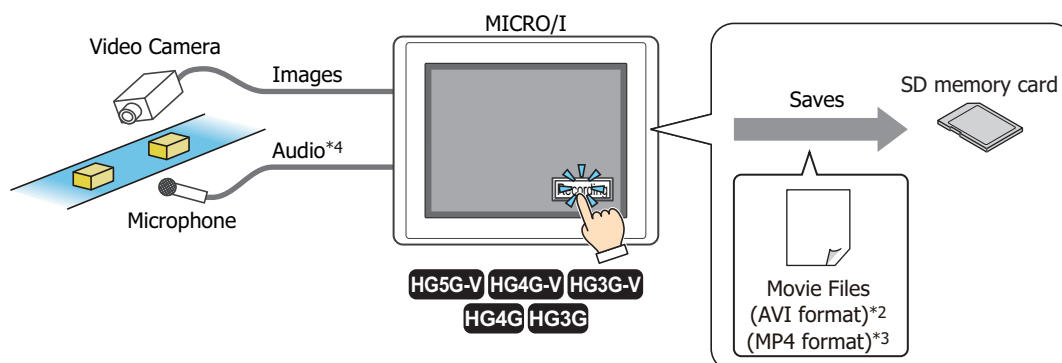

*¹ This is applicable for models with a video interface only.

*² HG5G/4G/3G-V only

*³ HG4G/3G only

*⁴ Recording sound function is for HG4G/3G only

5.2 Key Button Configuration Procedure

This section describes the configuration procedure for Key Buttons.

- 1 On the **Home** tab, in the **Parts** group, click **Buttons**, and then click **Key Button**.

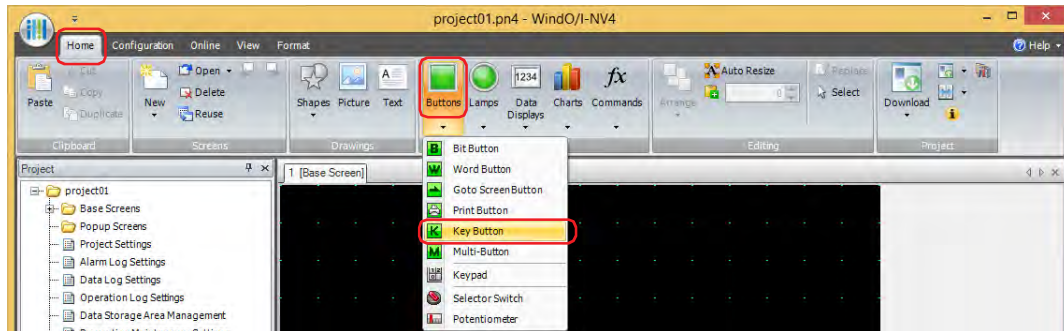

- 2 Click a point on the edit screen where you wish to place the Key Button.
- 3 Double-click the placed Key Button and a Properties dialog box will be displayed.
- 4 Change the settings on each tab as necessary.

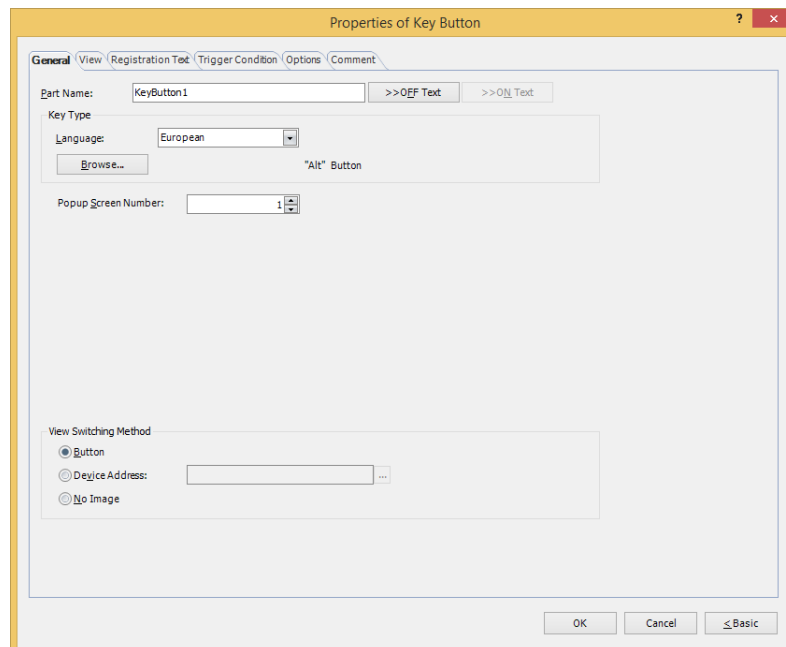

The **Trigger Condition** tab and **Options** tab only appear in Advanced mode.



You can set the default for the Key Button on the **Default Preferences** tab of the **WindO/I-NV4 Options** dialog box. For details, refer to Chapter 2 "Default Preferences Tab" on page 2-63.

5.3 Properties of Key Button Dialog Box

This section describes items and buttons on the properties dialog box.

● General Tab

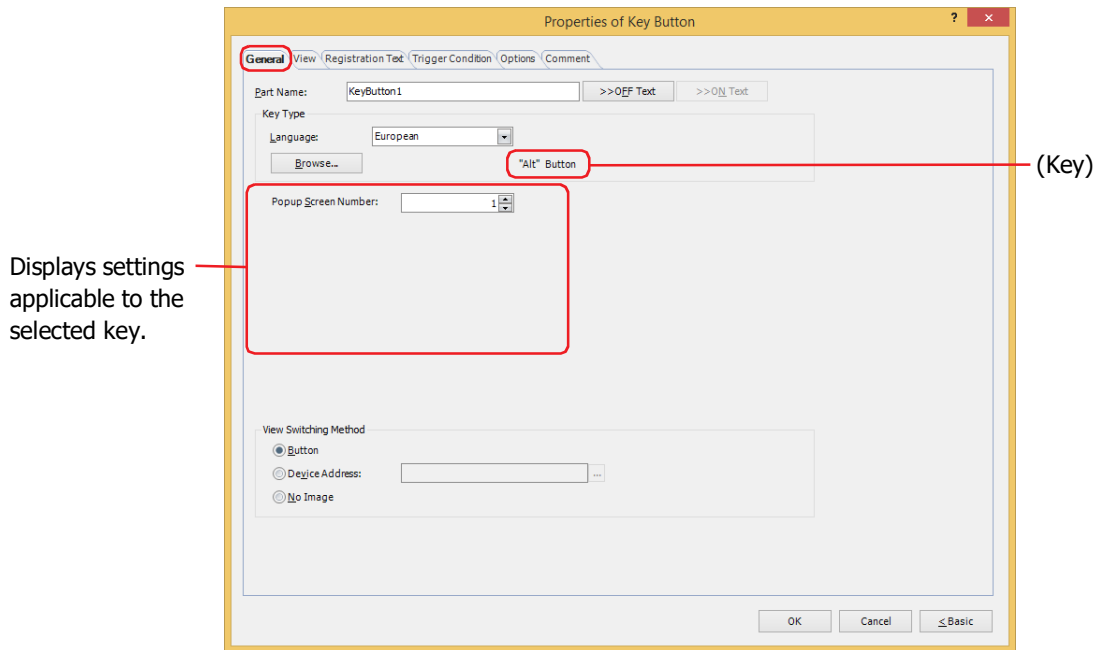

■ Part Name

Enter a name for the part. The maximum number is 20 characters.

■ >>OFF Text, >>ON Text

Applies the text entered in the **Part Name** field to the **Text** field under the **OFF** or **ON** fields on the **Registration Text** tab. This is used as the Registration Text when the button is OFF or ON.



To specify the Registration Text to use when the button is ON, select the **Set by State** check box on the **Registration Text** tab. If left unchecked, the same Registration Text assigned for the OFF state is displayed for the ON state as well.

■ Key Type

Select the function for the Key Button.

Language: Switches the display of the key that is displayed when **Keypad** is selected in Key Browser. These languages are available:

Western, Japanese, Central European, Baltic, Cyrillic.

Browse: Opens the Key Browser when clicked. Select a key.
For details, refer to "5.5 Key Browser" on page 8-99.

(Key): Displays the name of the key selected using the Key Browser.



- When you select a key, the label for that key is assigned as the Registration Text.
- The function of Key Button will affect on the next scan when the trigger condition is satisfied.

The settings explained below appear depending on the type of key selected.

■ Popup Screen Number

The **Alt** key switches the current Popup Screen used as a Keypad when this button is pressed. Specify the Popup Screen number to open a Keypad for. This setting is enabled only if **Alt** was selected using the Key Browser.

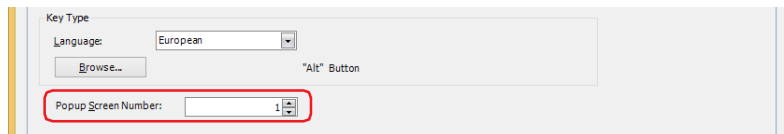

■ Scroll Size

Key Buttons **Page Up** and **Page Down** scroll the list up and down, respectively. Key Buttons **Up** and **Down** move the focus up and down, respectively. This settings specifies the number of pages or lines (1 to 1023 lines) to scroll or move the focus per each press of the button. This setting is enabled only if **Page Up**, **Page Down**, **Up**, and **Down** are selected using the Key Browser.

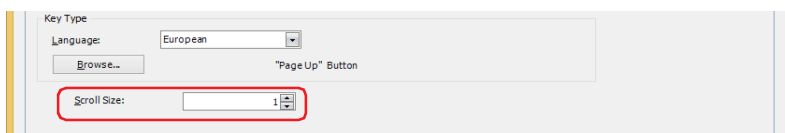

■ Transfer Setting

Key Buttons **Download Project**, **Upload Project**, **Copy Files**, **Download PLC Program**, and **Upload PLC Program**, perform the data transfer function specified by their names. These settings specify the source, data to be transferred, and destination. This setting is enabled only if one of these keys is selected after clicking **Data Transfer** in the Key Browser.

Download Project is selected.

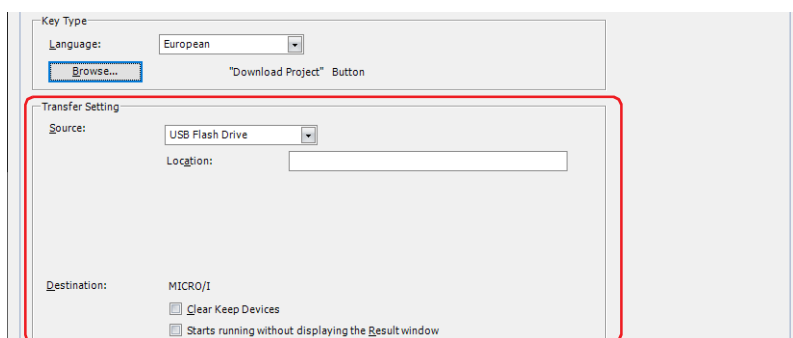

Source: Select the external memory where the project (ZNV Project File) to be transferred is stored: **SD Memory Card**^{*1}, **USB Flash Drive**^{*2}, **USB1**^{*3} or **USB2**^{*3}.

Location: Specify the location of the ZNV Project File (.znv). The maximum number is 247 characters. Only alphanumeric characters and symbols can be used. Path delimiters and characters that cannot be used vary based on the model.

Model	Delimiter	Characters that cannot be used
HG2J-7U	/	" # \$ & ' () * ; < > ? \ ` ~
HG5G/4G/3G/2G-V, HG4G/3G, HG2G-5F/-5T, HG1G/1P	\	" * ; < > ?

Example: To set "HG3G_DEMO_1.ZNV", a ZNV Project File, to be saved on the root directory of an external memory device:
HG3G_DEMO_1.ZNV

*1 HG5G/4G/3G/2G-V, HG4G/3G, HG2G-5F only
*2 HG5G/4G/3G/2G-V, HG4G/3G, HG2G-5F/-5T, HG1G/1P only
*3 HG2J-7U only

Destination: Displays a download destination of the project.

Clear Keep Devices:

Select this check box to clear keep devices after the project data is downloaded. However, when project data that changes the system software or settings of the data storage area is downloaded, the keep devices are always cleared.

 When project data is downloaded, the alarm log data, data log data, and operation log data is deleted regardless of the state of the **Clear Keep Devices** check box.

Starts running without displaying the Result window:

Select this check box to start running MICRO/I without displaying the execution result screen after the project data is downloaded.

Upload Project is selected.

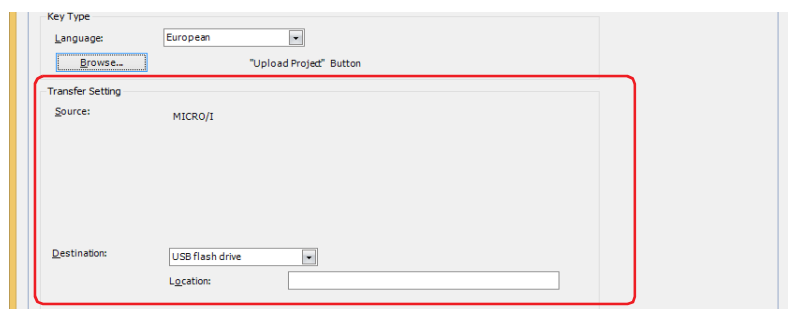

Destination: Specify where to save the project uploaded from MICRO/I. Select the location:

SD Memory Card^{*1}, USB Flash Drive^{*2}, USB1^{*3} or USB2^{*3}.

Location: Specify the location where the uploaded project will be saved. The maximum number is 247 characters. Only alphanumeric characters and symbols can be used. Path delimiters and characters that cannot be used vary based on the model.

Model	Delimiter	Characters that cannot be used
HG2J-7U	/	" # \$ & ' () * : ; < > ? \ ` ~
HG5G/4G/3G/2G-V, HG4G/3G, HG2G-5F/-5T, HG1G/1P	\	" * : ; < > ?

Example: To save project to the folder "Uploaded_Project" in an external memory device:
 Uploaded_Project

 A uploaded project using the Data Transfer function is saved as a ZNV Project File(.znv).

*1 HG5G/4G/3G/2G-V, HG4G/3G, HG2G-5F only
 *2 HG5G/4G/3G/2G-V, HG4G/3G, HG2G-5F/-5T, HG1G/1P only
 *3 HG2J-7U only

Copy Files^{*4} is selected.

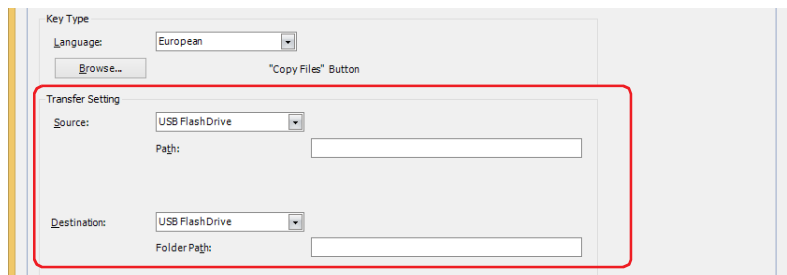

Source: Select the source external memory: **SD Memory Card**^{*1}, **USB Flash Drive**^{*1}, **USB1**^{*3} or **USB2**^{*3}.

Location: Specify the location of the file to be transferred. The maximum number is 247 characters. Only alphanumeric characters and symbols can be used. Path delimiters and characters that cannot be used vary based on the model.

Model	Delimiter	Characters that cannot be used
HG2J-7U	/	" # \$ & ' () * : ; < > ? \ ` ~
HG5G/4G/3G/2G-V, HG4G/3G, HG2G-5F	\	" * : ; < > ?

Example: Copy a file "Error.wav" to the root directory of an external memory device:
Error.wav

Destination: Select the destination external memory: **SD Memory Card**^{*1}, **USB Flash Drive**^{*1}, **USB1**^{*3} or **USB2**^{*3}.

Location: Specify the location where the file will be transferred. The maximum number is 247 characters. Only alphanumeric characters and symbols can be used. Path delimiters and characters that cannot be used vary based on the model.

Model	Delimiter	Characters that cannot be used
HG2J-7U	/	" # \$ & ' () * : ; < > ? \ ` ~
HG5G/4G/3G/2G-V, HG4G/3G, HG2G-5F	\	" * : ; < > ?

Example: Save file to the "SOUND" folder under "HGDATA01" folder in an external memory device:

HG2J-7U: HGDATA01/SOUND
HG5G/4G/3G/2G-V, HG4G/3G, HG2G-5F: HGDATA01\SOUND



- If a file name is specified as the source location, the specified file is copied. If a folder name is specified, all of the files and subfolders contained in the folder, and all of the files in the subfolders, are copied.
- The subfolders can be copied up to five levels.
- To prevent copying the subfolders and the files contained in the subfolders, HMI Special Internal Relay LSM30 must be set to 1 before executing the copy.
- To stop copying files during the copy operation, write 1 to HMI Special Internal Relay LSM31. However, it will continue to copy the file until it is finished then it will stop copying.

*1 HG5G/4G/3G/2G-V, HG4G/3G, HG2G-5F only

*3 HG2J-7U only

*4 HG2J-7U, HG5G/4G/3G/2G-V, HG4G/3G, HG2G-5F only

Download PLC Program is selected.

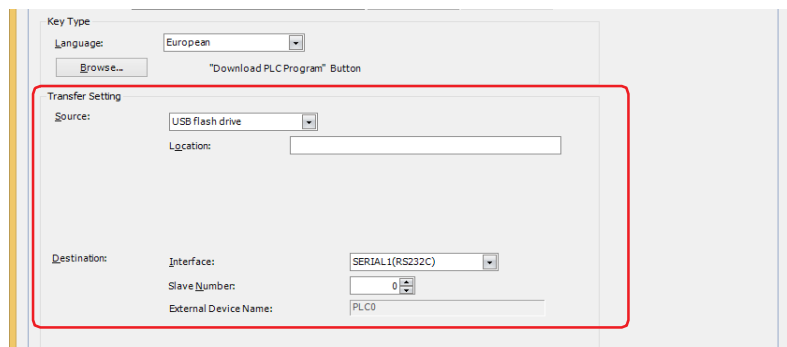

Source: Select the external memory where the PLC program (ZLD Project File) to be transferred is stored:
SD Memory Card*¹, USB Flash Drive*², USB1*³ or USB2*³.

Location: Specify the location of the ZLD Project File(.zld). The maximum number is 247 characters. Only alphanumeric characters and symbols can be used. Path delimiters and characters that cannot be used vary based on the model.

Model	Delimiter	Characters that cannot be used
HG2J-7U	/	" # \$ & ' () * : ; < > ? \ ` ~
HG5G/4G/3G/2G-V, HG4G/3G, HG2G-5F/-5T, HG1G/1P	\	" * : ; < > ?

Example: To set "LDR_PROGRAM.ZLD", a ZLD Project File, to be saved in folder "LDRDATA" of an external memory device:

HG2J-7U: LDRDATA/LDR_PROGRAM.ZLD

HG5G/4G/3G/2G-V, HG4G/3G, HG2G-5F/-5T, HG1G/1P: LDRDATA\LDR_PROGRAM.ZLD

Destination: Specify the destination PLC connected to the MICRO/I. The PLC type is configured in the **Project Settings** dialog box, on the **Communication Driver Network** tab. For details, refer to Chapter 4 "3.4 Communication Driver Network Tab" on page 4-52.

Interface: Select the communication interface in which the MICRO/I is connecting to the download destination PLC from serial interface or Ethernet. For details, refer to Chapter 4 "Interface Configuration" on page 4-35.

If serial interface is selected for **Interface**.

Slave Number: Specify the slave number of the download destination PLC (0 to 31).

External Device Name: The name of the specified PLC is displayed here.

If **Ethernet** is selected for **Interface**.

Select from the following method:

Specify External Device ID: Specify the External Device ID (0 to 31) of the destination PLC. This is the External Device ID number set in the **Project Settings** dialog box, on the **Communication Driver Network** tab.

External Device Name: The name of the specified PLC is displayed here.

Specify IP Address: Specify the IP address and port number of the destination PLC.

*1 HG5G/4G/3G/2G-V, HG4G/3G, HG2G-5F only

*2 HG5G/4G/3G/2G-V, HG4G/3G, HG2G-5F/-5T, HG1G/1P only

*3 HG2J-7U only

Upload PLC Program is selected.

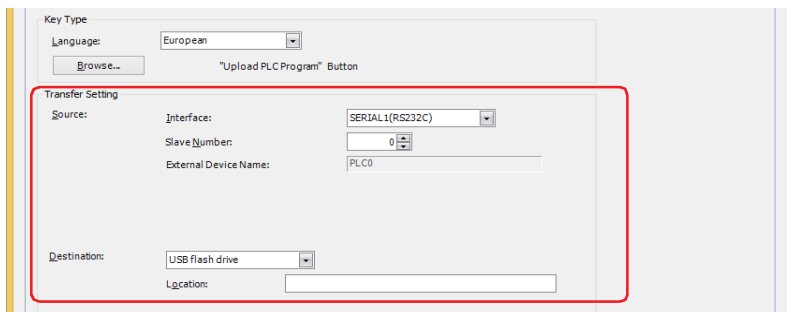

Source: Specify the source PLC connected to the MICRO/I. The PLC type is configured in the **Project Settings** dialog box, on the **Communication Driver Network** tab. For details, refer to Chapter 4 "3.4 Communication Driver Network Tab" on page 4-52.

Interface: Select the communication interface in which the MICRO/I is connecting to the upload source PLC from serial interface or Ethernet. For details, refer to Chapter 4 "Interface Configuration" on page 4-35.

If serial interface is selected for **Interface**.

Slave Number: Specify the slave number of the upload source PLC (0 to 31).

External Device Name: The name of the specified PLC is displayed here.

If **Ethernet** is selected for **Interface**.

Select from the following method:

Specify External Device ID: Specify the External Device ID (0 to 31) of the upload source PLC. This is the External Device ID number set in the **Project Settings** dialog box, on the **Communication Driver Network** tab.

External Device Name: The name of the specified PLC is displayed here.

Specify IP Address: Specify the IP address and port number of the upload source PLC.

Destination: Specify where to save the PLC program uploaded from the PLC connected to the MICRO/I. Select the type of external memory: **SD Memory Card**^{*1}, **USB Flash Drive**^{*2}, **USB1**^{*3} or **USB2**^{*3}.

Location: Specify the location of the folder where the uploaded PLC program will be saved. The maximum number is 247 characters. Only alphanumeric characters and symbols can be used. Path delimiters and characters that cannot be used vary based on the model.

Model	Delimiter	Characters that cannot be used
HG2J-7U	/	" # \$ & ' () * : ; < > ? \ ` ~
HG5G/4G/3G/2G-V, HG4G/3G, HG2G-5F/-5T, HG1G/1P	\	" * : ; < > ?

Example: To save program to the folder "Uploaded_Program" in an external memory device:
 Uploaded_Program



A uploaded PLC program using the Data Transfer function is saved as a ZLD Project File(.zld).

*1 HG5G/4G/3G/2G-V, HG4G/3G, HG2G-5F only
 *2 HG5G/4G/3G/2G-V, HG4G/3G, HG2G-5F/-5T, HG1G/1P only
 *3 HG2J-7U only

■ Recording Channel*5

The recording of images starts.

Selects **Channel 1** or **Channel 2** to record a video only (no audio) out of the signals input from the device. This setting is enabled only if **Rec.** was selected using the Key Browser.

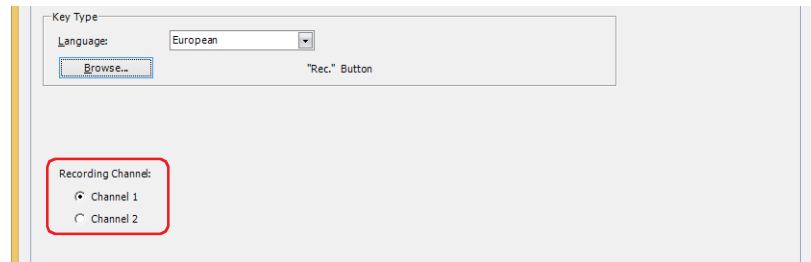

- Movie files cannot be recorded during playback.
- While data is being recorded after an event occurs with the event recording function and while data is being saved to the external memory device, recording cannot be executed with a Key Button, Multi-Button, or Multi-Command configured with the recording function. Also, during these situations, the value of HMI Special Data Register LSD155-0 changes to 1. For details, refer to Chapter 33 "HMI Special Data Register (LSD)" on page 33-8.

■ Recording Target*6

The recording of images and sound starts.

Select the target to record out of the signals input from the device. This setting is enabled only if **Rec.** was selected using the Key Browser.

Video and Audio: Records images and sound.

Video only (No Audio): Records images only.

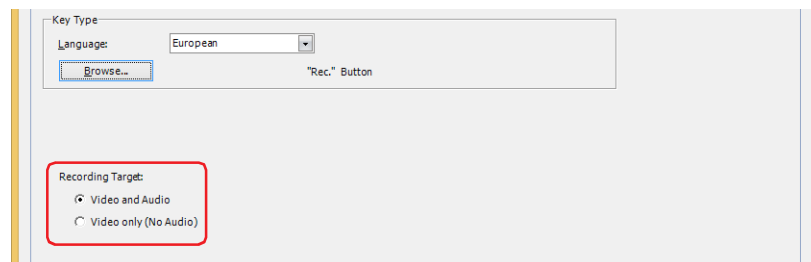

- Movie files cannot be recorded during playback.
- While data is being recorded after an event occurs with the event recording function and while data is being saved to the external memory device, recording cannot be executed with a Key Button, Multi-Button, or Multi-Command configured with the recording function. Also, during these situations, the value of HMI Special Data Register LSD155-0 changes to 1. For details, refer to Chapter 33 "HMI Special Data Register (LSD)" on page 33-8.

*5 HG5G/4G/3G-V only

*6 This is applicable for HG4G/3G with a video interface only.

■ View Switching Method*7

Select how to display the ON/OFF status of the button.

Button: Pressing the button changes the drawing object displayed.

Device Address: The drawing objects assigned to the OFF and ON states are displayed when the value of the device address is 0 and 1, respectively. Specifies the device address used to switch the drawing object display.

Click  to display the Tag Editor. For the device address configuration procedure, refer to Chapter 2 "5.1 Device Address Settings" on page 2-70.

No Image: The button is not displayed on the screen. The button appears as a dashed line frame on the edit screen. Pressing the corresponding area on the MICRO/I activates the assigned function. If **No Image** is selected, the settings for **View** and **Registration Text** are disabled.



Selecting **Device Address** in **View Switching Method** allows you to create an illuminated pushbutton. The illuminated pushbutton switches state (or image) according to ON or OFF state of the device address, allowing you to display the state of a device that is being operated.

Example: When you set an external device address 'M0' as **Device Address** in **View Switching Method**, if the value of M0 changes, the display image will switched according to the value of M0 even if the button is not pressed.

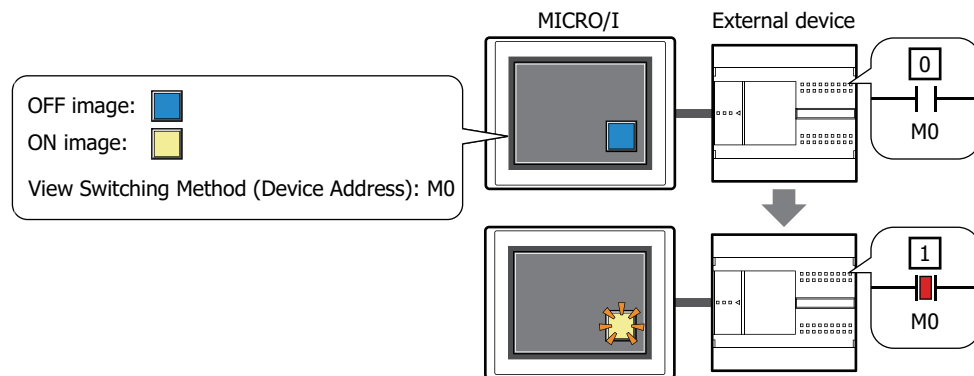

*7 Advanced mode only

● View Tab

Only **Coordinates** and **Size** can be configured when **No Image** is selected for **View Switching Method** on the **General** tab.

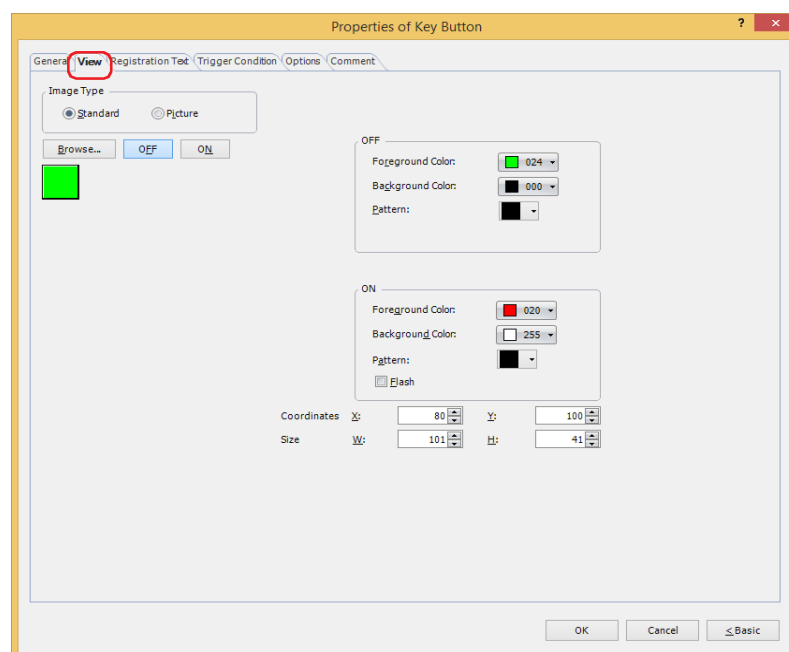

■ Image Type

Select the type of graphic to be used to represent the part.

Standard: Uses the default graphic for WindO/I-NV4.

Picture: Uses an image file saved using Picture Manager.

For details about image file restrictions, refer to Chapter 2 "1.4 Available Image Files" on page 2-20.

■ Browse

Select the type of graphic to be used to represent the part from the list of graphics. Click this button to display the View Browser or Picture Manager, depending on the setting for **Image Type**.

■ OFF button, ON button

Displays the graphic when ON or OFF. Clicking **ON** or **OFF** switches the image displayed on the **View** tab.

■ OFF, ON

Selects the color and pattern of the standard graphic when ON and OFF.

Foreground Color, Background Color: Selects the foreground and background colors of the standard graphic (color: 256 colors, monochrome: 16 shades).

Click **Color** to display the Color Palette. Select a color from the Color Palette.

Pattern: Selects a pattern or tonal gradation for the standard graphic.

Click **Pattern** to display the Pattern Palette. Select a pattern or tonal gradation from the Pattern Palette.

■ Flash

Select this check box if flashing is desired (alternating ON and OFF) when a part is ON.

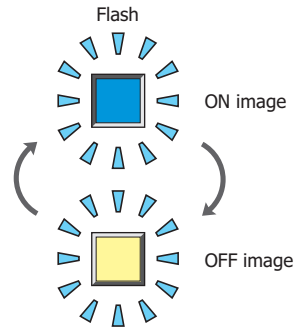

■ Coordinates

X, Y: Sets the display position of parts using coordinates.

The X and Y coordinates of parts are defined relative to an origin at the top-left corner of the screen.

X: 0 to (base screen horizontal size - 1)

Y: 0 to (base screen vertical size - 1)

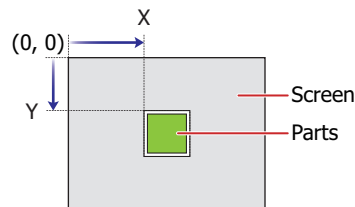

■ Size

W, H: Sets width and height to define the size of parts.

W: 20 to (base screen horizontal size)

H: 20 to (base screen vertical size)

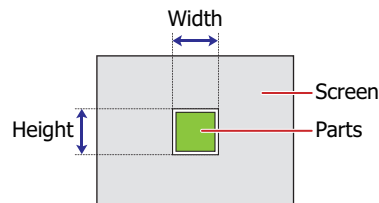

● Registration Text Tab

These options can only be configured when **Button** or **Device Address** is selected for **View Switching Method** on the **General** tab.

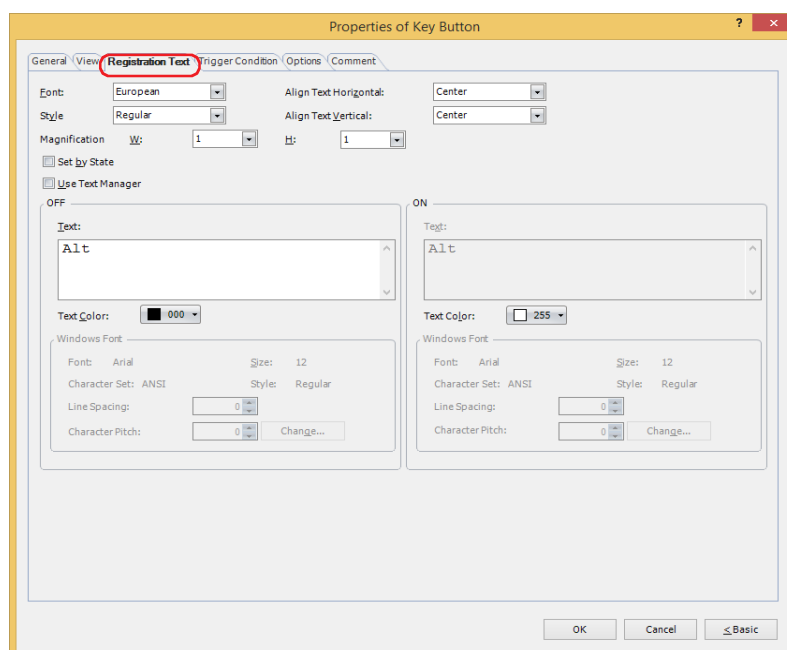

■ Font

Selects the font used for displaying text from the following.

Western, Japanese, Simplified Chinese, Traditional Chinese, Hangul, Central European, Baltic, Cyrillic, Windows, Stroke*1

Can only be set when the **Use Text Manager** check box is cleared.

The characters that can be displayed depend on the font. For details, refer to Chapter 2 "1.2 Available Text" on page 2-6.

■ Style*1

Selects **Regular** or **Bold** for text style.

Can only be set when **Font** is set to **Western, Japanese, Simplified Chinese, Traditional Chinese, Hangul, Central European, Baltic, Cyrillic**.

■ Size

Specifies the text size to be displayed. The fonts and sizes that can be set vary based on the model.

Model	Font	Size
HG2J-7U	Western, Japanese, Simplified Chinese, Traditional Chinese, Hangul, Central European, Baltic, Cyrillic	8 to 512
HG5G/4G/3G/2G-V, HG4G/3G, HG2G-5F/-5T, HG1G/1P	Stroke	8 to 128

■ Magnification*1

W, H: Selects the magnification (0.5, 1 to 8) for text display.

Can only be set when **Font** is set to **Western, Japanese, Simplified Chinese, Traditional Chinese, Hangul, Central European, Baltic, Cyrillic**.

■ Align Text Horizontal

Selects text alignment in the horizontal direction.

Left, Center, Right, Center-Left

For details, refer to Appendix "5 Text Alignment" on page A-7.

*1 HG5G/4G/3G/2G-V, HG4G/3G, HG2G-5F/-5T, HG1G/1P only

■ Align Text Vertical

Selects text alignment in the vertical direction.

Top, Center, Bottom

This option can only be configured when **Left**, **Center**, or **Right** is selected for **Align Text Horizontal**. If **Center-Left** is selected for **Align Text Horizontal**, **Center-Top** is set as this option.

For details, refer to Appendix "5 Text Alignment" on page A-7.

■ Set by State

Select this check box if displaying different text when ON and OFF.

■ Use Text Manager

Select this check box if using the text registered in Text Manager for text display.

■ OFF, ON

- Text:** Inputs characters to be displayed on parts. The maximum number is 3,750 characters.
The characters that can be entered depend on the font selected using **Font**. For details, refer to Chapter 2 "1.2 Available Text" on page 2-6.
- Text ID:** Specifies the Text Manager ID No. (1 to 32000) when using the text registered in the Text Manager.
Click to display Text Manager.
Can only be set when the **Use Text Manager** check box is selected.
- Text Color:** Selects the color of the text displayed on the part (color: 256 colors, monochrome: 16 shades).
Click **Color** to display the Color Palette. Select a color from the Color Palette.
- Windows Font:** Sets the font to be used as the Windows Font.
Select **Windows** using **Font** to display the current setting. You can specify the character spacing (0 to 100) and the line spacing (0 to 100). To change the settings other than the character spacing and line spacing, click **Change** to display the **Font Settings** dialog box.
Can only be set when the **Use Text Manager** check box is cleared.
For details, refer to Chapter 2 "Windows Font" on page 2-13.

● **Trigger Condition Tab**

The **Trigger Condition** tab is displayed in Advanced mode.

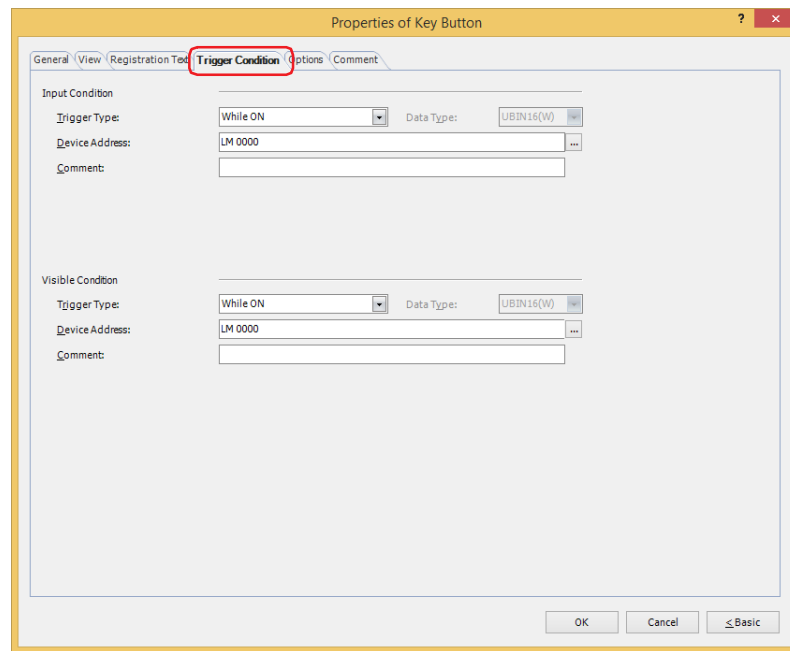

■ **Input Condition**

The Button is enabled and operational while the condition is satisfied. The Button is disabled and not operational while the condition is not satisfied.

Example: When **Trigger Type** is **While ON** and **Device Address** is **LM0**

While LM0 is 0, the condition is not satisfied and the Button is not operational.

While LM0 is 1, the condition is satisfied and the Button is operational.

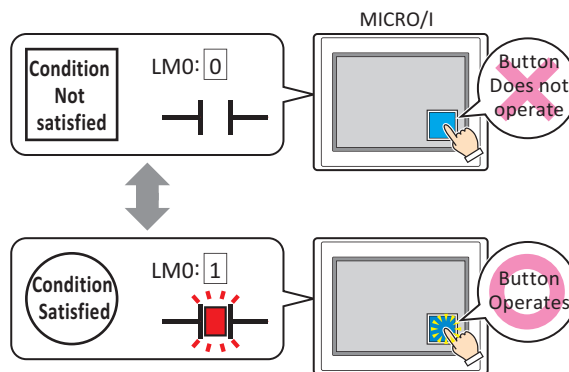

Trigger Type: Selects the condition to enable the Button from the following.

Always enable: The Button is always enabled.

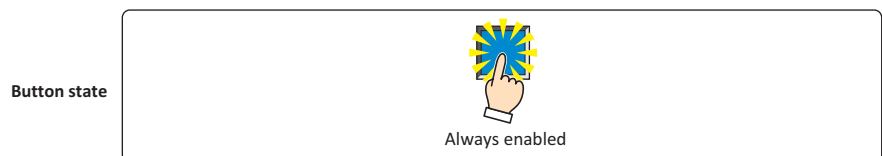

While ON: Enables the Button when the value of device address is 1.

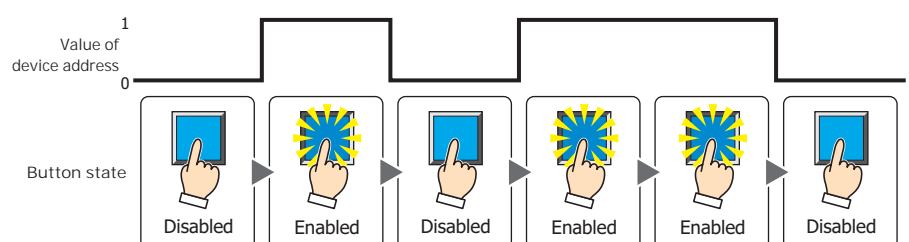

While OFF: Enables the Button when the value of device address is 0.

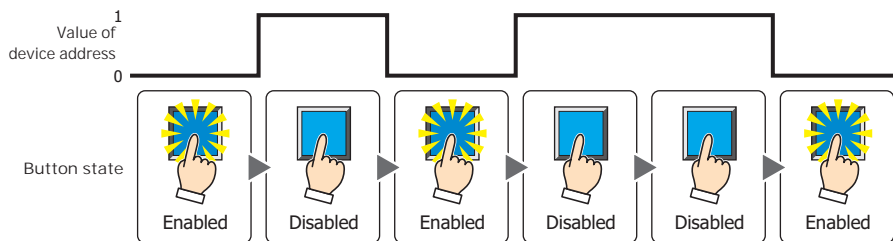

While satisfying the condition: Enables the Button when the condition is satisfied.

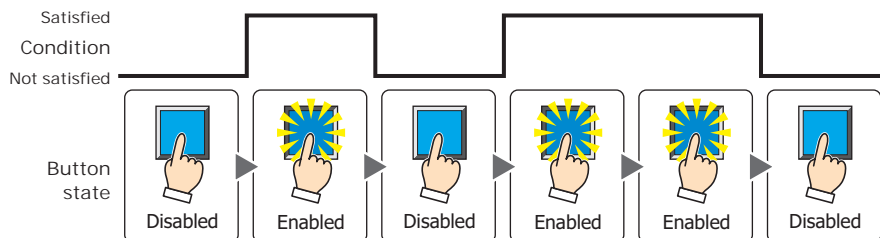

- Data Type:** Selects the type of data handled by the conditional expression for the input condition. This option can only be configured if **While satisfying the condition** is selected for **Trigger Type**. For details, refer to Chapter 2 "1.1 Available Data" on page 2-1.
- Device Address:** Specifies the bit device or the bit number of the word device to serve as the input condition. This option can only be configured when **While ON** or **While OFF** is selected for **Trigger Type**. Click **...** to display the Tag Editor. For the device address configuration procedure, refer to Chapter 2 "5.1 Device Address Settings" on page 2-70.
- Condition:** Specifies the conditional expression for the input condition. This option can only be configured when **While satisfying the condition** is selected for **Trigger Type**. Click **...** to display the **Trigger Condition Settings** dialog box. For the conditional expression configuration procedure, refer to Chapter 2 "5.2 Setting Conditional Expressions" on page 2-73.
- Comment:** Used for entering a comment for the input condition. The maximum number is 80 characters.

■ **Visible Condition**

The Button is displayed while the condition is satisfied. The Button is hidden while the condition is not satisfied.

Example: When **Trigger Type** is **While ON** and **Device Address** is **LM0**
 While LM0 is 0, the condition is not satisfied and the Button is hidden.
 While LM0 is 1, the condition is satisfied and the Button is displayed.

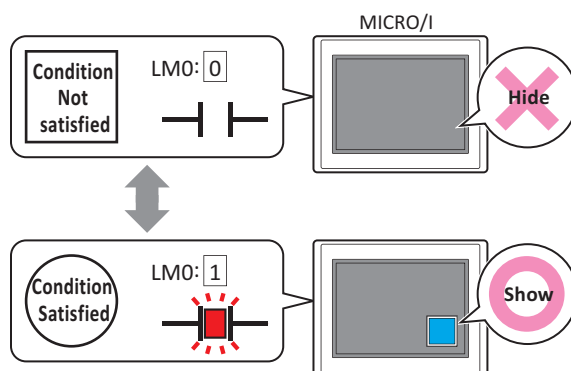

- When **Alternate** is selected for **Action Mode** on the **General** tab, the button remains on when hidden in the on state.
- When the **ON delay** check box is selected on the **Options** tab, if the button is hidden before the set time elapses from when the button begins to be pressed, the on delay is reset and the button does not operate.

Trigger Type: Selects the condition to display the Button from the following.

Always visible: The Button is always displayed.

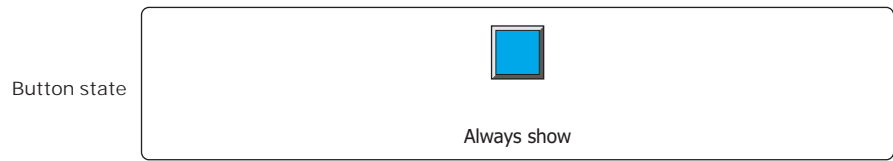

While ON: Displays the Button when the value of device address is 1.

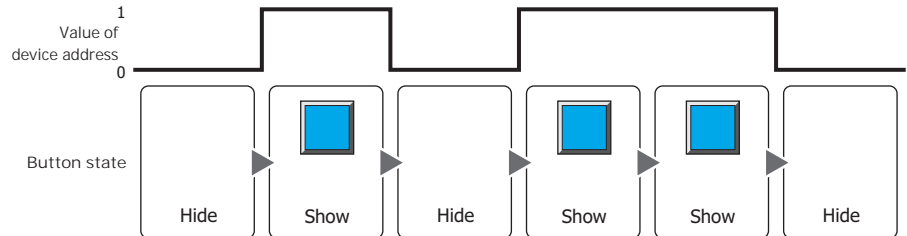

While OFF: Displays the Button when the value of device address is 0.

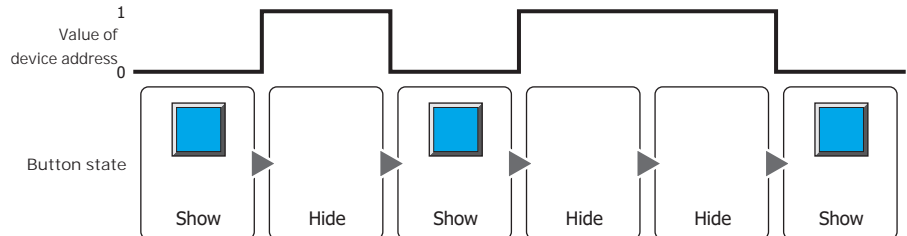

While satisfying the condition: Displays the Button when the condition is satisfied.

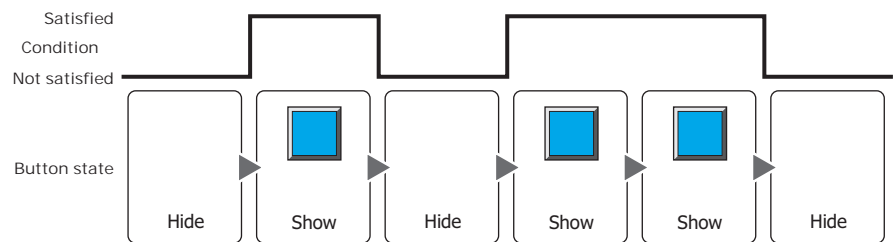

Data Type: Selects the type of data handled by the conditional expression for the visible condition. This option can only be configured if **While satisfying the condition** is selected for **Trigger Type**. For details, refer to Chapter 2 "1.1 Available Data" on page 2-1.

Device Address: Specifies the bit device or the bit number of the word device to serve as the visible condition. This option can only be configured when **While ON** or **While OFF** is selected for **Trigger Type**.

Click to display the Tag Editor. For the device address configuration procedure, refer to Chapter 2 "5.1 Device Address Settings" on page 2-70.

Condition: Specifies the conditional expression for the visible condition. This option can only be configured when **While satisfying the condition** is selected for **Trigger Type**.

Click to display the **Trigger Condition Settings** dialog box. For the conditional expression configuration procedure, refer to Chapter 2 "5.2 Setting Conditional Expressions" on page 2-73.

Comment: Used for entering a comment for the visible condition. The maximum number is 80 characters.

● Options Tab

The **Options** tab is displayed in Advanced mode.

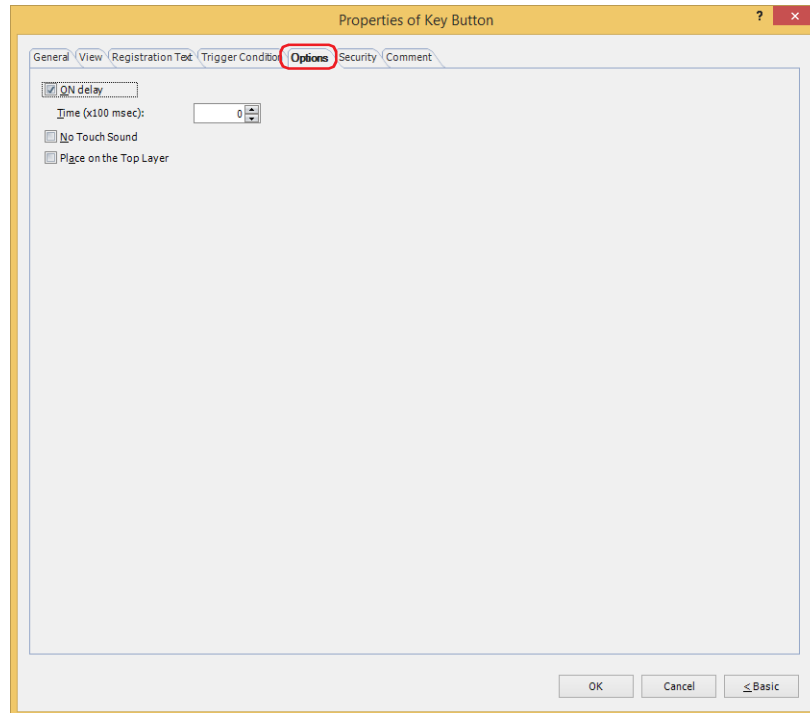

■ ON delay

Select this check box to use the ON delay function.

Time (x100 msec): Specify the length of time that the button must be held down before activation by selecting a value from 0 to 600 (units of 10 ms).

The button activates after it is held down for a specified period of time.

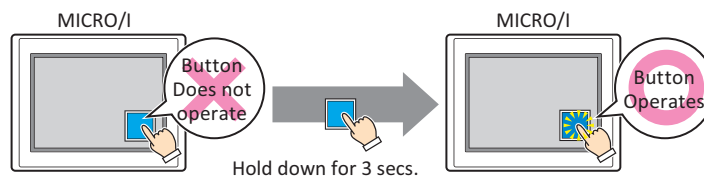

This feature protects against mistaken operation by ensuring that the button will not be activated if touched accidentally.

■ No Touch Sound

This function is to disable touch sounds only for specified parts when the MICRO/I makes touch sounds.

Select this check box to display disable touch sounds for this part.



To enable touch sounds on the MICRO/I, select the **Enable Touch Sound** check box under the **System** tab of the **Project Settings** dialog box.

■ Place on the Top Layer

Select this check box to display the parts on the top layer. The parts will have precedence when other drawings and parts are overlapping with it. For details, refer to Chapter 6 "4 Drawings and Parts Overlapping" on page 6-5.

● Security Tab

This tab is used to restrict displaying and using the part by security groups.

This option can only be set when **Use Security functions** is selected. The **Use Security functions** check box is set on **General** tab in the **Security** dialog box.

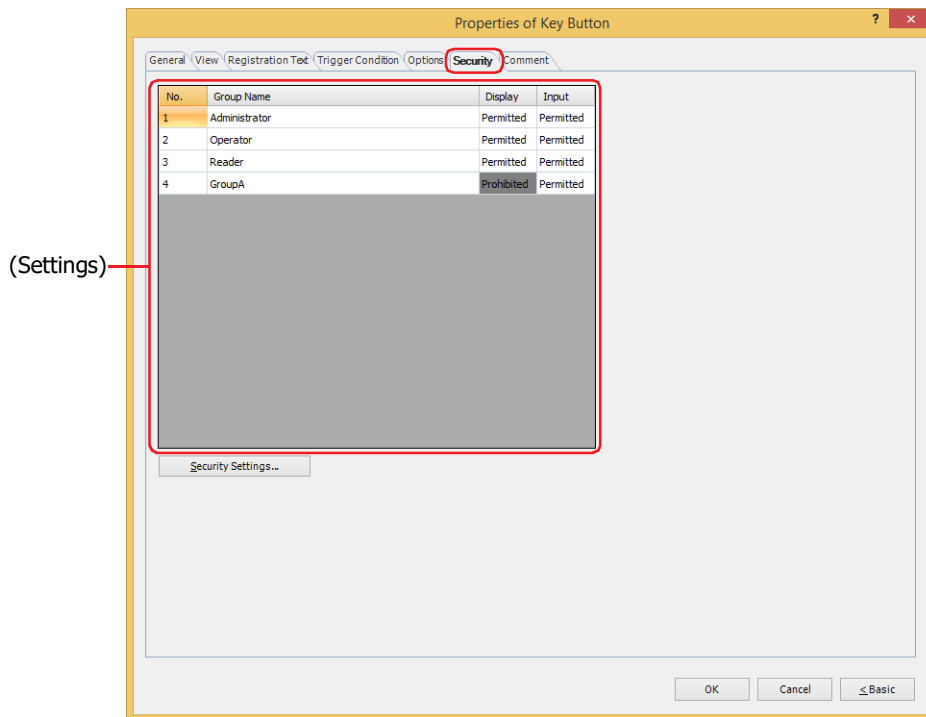

■ (Settings)

Displays the list of security groups used on the MICRO/I.

- No.: Displays the security group numbers (1 to 15).
- Group Name: Displays the name of the security group.
- Display: Displays whether or not there is permission to display the part. Only **Permitted** security groups can display this part. If all security groups are set to **Permitted**, this part will be displayed even if no user account has been selected. Double clicking the cell switches between **Permitted** and **Prohibited**.
- Input: Displays whether or not there is permission to use the part. Only **Permitted** security groups can use this part. If all security groups are set to **Permitted**, this part can be used even if no user account has been selected. Double clicking the cell switches between **Permitted** and **Prohibited**.



- You can also switch between **Permitted** and **Prohibited** by right-clicking on a **Display** or **Input** cell.
- Restricting the display and use of the part by switching between **Permitted** and **Prohibited** in **Display** and **Input** cells is similar to using the **Trigger Condition** tab.



■ Security Settings

The Security Settings dialog box is displayed. If you create a security group in the **Security Settings** dialog box, you can select that created group. For details, refer to Chapter 23 “2.2 Adding and Editing Security Groups” on page 23-19.



For details about security functions, refer to Chapter 23 “User Accounts and the Security Function” on page 23-1.

Example: If the user and security group for a part are set as follows:

User Name	 User1	 User2	 User3
Security Group	Reader	Operator	Administrator

Line Chart and Bar Chart

No.	Group Name	Display
1	Administrator	Permitted
2	Operator	Permitted
3	Reader	Prohibited

MICRO/I

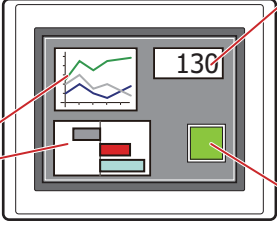

Numerical Display

No.	Group Name	Display
1	Administrator	Permitted
2	Operator	Permitted
3	Reader	Permitted

Button

No.	Group Name	Display	Input
1	Administrator	Permitted	Permitted
2	Operator	Permitted	Prohibited
3	Reader	Prohibited	Prohibited

For User1 in the **Reader** security group, the parts for which **Display** has been set to **Prohibited** for **Reader** will not be displayed.

If the password screen is opened and the user switches to User2 in the **Operator** security group, the parts for which **Display** has been set to **Permitted** for **Operator** will be displayed.

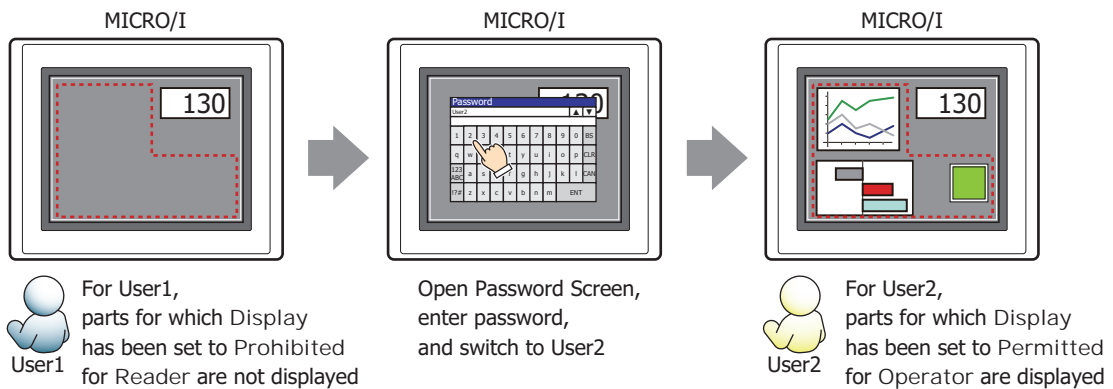

For User2 in **Operator**, **Display** has been set to **Permitted** for **Operator**, but **Input** is **Prohibited**, so the part cannot be used.

If the password screen is opened and the user switches to User3 in the **Administrator** security group, the parts for which **Display** has been set to **Permitted** for **Administrator** will be displayed, and the parts for which **Input** has been set to **Permitted** for **Administrator** can be used.

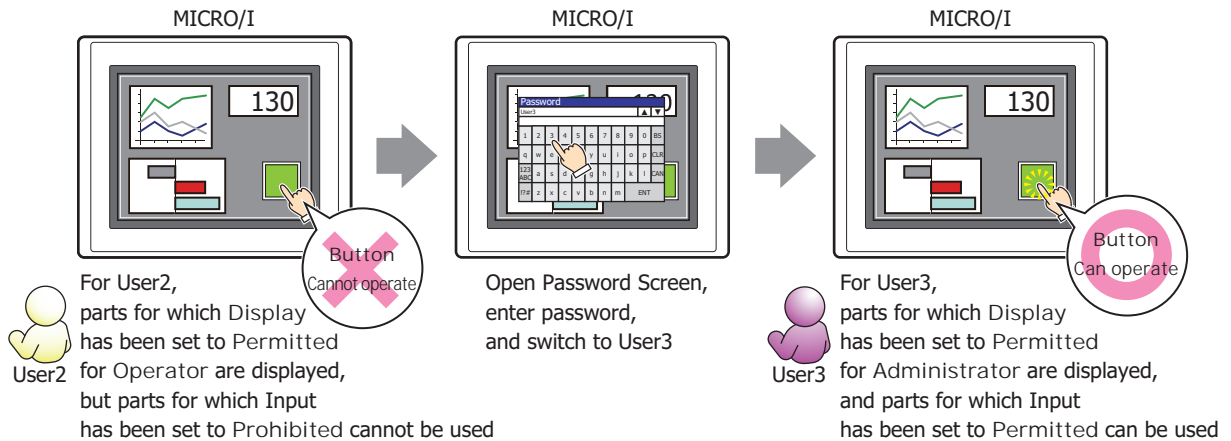

● Comment Tab

The **Comment** tab is used to specify the parts placed on the editing screen, and the popup text displayed when the mouse pointer is placed close to **No.**, **Name**, or **Type** in the object list.



When there are multiple parts of the same shape on the screen, this feature makes it possible to distinguish between the parts without displaying the Properties dialog box for each part, by just mousing over the part.

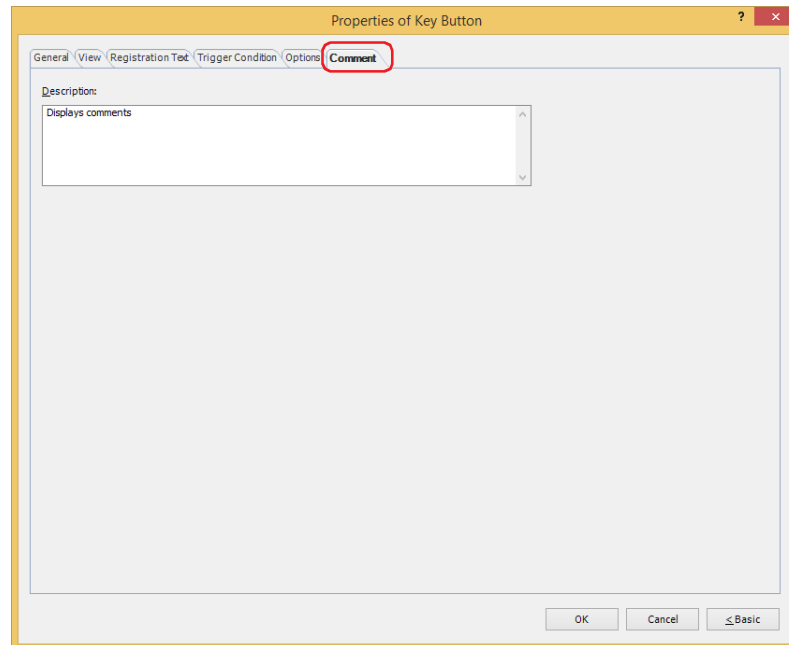

■ Description

Used for entering comments about parts. The maximum number is 80 characters.

Example: When mousing over the Button on the editing screen

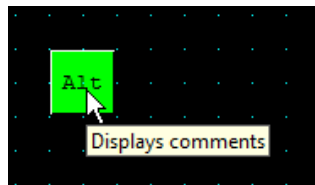

5.4 Key Buttons

● For Keypad(Half-Width Character)

These keys can be used for Numerical Input and Character Input:

■ Numerical Input Keypad

Key	Operation
.	Inputs a decimal point.
0 to 9	Inputs a number from 0 to 9.
A to F	Inputs a character from A to F.
+/-	Toggles the sign.
CAN	Clears the data input thus far and cancels the input. Closes the Popup Screen that is opened as the Keypad, if this key is placed on it.
CLR	Clears the data input thus far and stands by for further input.
BS	Deletes the character to the left of the character at the cursor position.
ENT	Writes the characters input as a numeric value to a device address. After the data is written, the focus can be moved according to the Focus Order setting. Focus Order can be set on the Options tab of the Screen Properties dialog box.
< Fcs.	Moves the focus one item before the current one as per the Focus Order setting. Focus Order can be set on the Options tab of the Screen Properties dialog box.
Fcs. >	Moves the focus one item after the current one as per the Focus Order setting. Focus Order can be set on the Options tab of the Screen Properties dialog box.
Alt	The Alt key switches the Popup Screen opened as a Keypad. Closes the Popup Screen that is opened as the Keypad and opens another Popup Screen as the Keypad.



The **Alt** key can be used, for instance, to switch between a decimal and a hexadecimal Keypad.

■ Character Input Keypad

Key	Operation
!	Inputs a !.
"	Inputs a ".
#	Inputs a #.
\$	Inputs a \$.
%	Inputs a %.
&.	Inputs a &.
'	Inputs a '.
(Inputs a (.
)	Inputs a).
*	Inputs a *.
+	Inputs a +.
,	Inputs a ,.
-	Inputs a -.
.	Inputs a .
/	Inputs a /.
0 to 9	Inputs a number from 0 to 9.
:	Inputs a :.
;	Inputs a ;.
<	Inputs a <.
=	Inputs a =.

Key	Operation
>	Inputs a >.
?	Inputs a ?.
@	Inputs a @.
A to Z	Inputs a character from A to Z.
[Inputs a [.
\	Inputs a \.
]	Inputs a].
^	Inputs a ^.
_	Inputs a _.
'	Inputs a '.
a to z	Inputs a character from a to z.
{	Inputs a {.
	Inputs a .
}	Inputs a }.
~	Inputs a ~.
(Keys dependent on Language setting)	Inputs the text displayed according to the language selected in the Language setting. For a list of the characters input using these keys, refer to Chapter 2 "1.2 Available Text" on page 2-6.
CAN	Clears the data input thus far and cancels the input. Closes the Popup Screen if it is opened as a Keypad.
CLR	Clears the data input thus far and stands by for further input.
DEL	Deletes the character at the cursor.
BS	Deletes the character to the left the cursor.
ENT	Writes the text input in ASCII code form to a device address. After the data is written, the focus can be moved according to the Focus Order setting. Focus Order can be set on the Options tab of the Screen Properties dialog box.
SP	Inputs a space.
Cur. >	Moves the cursor right.
< Cur.	Moves the cursor left.
< Fcs.	Moves the focus one item before the current one as per the Focus Order setting. Focus Order can be set on the Options tab of the Screen Properties dialog box.
Fcs. >	Moves the focus one item after the current one as per the Focus Order setting. Focus Order can be set on the Options tab of the Screen Properties dialog box.
Alt	The Alt key switches the Popup Screen opened as a Keypad. Closes the Popup Screen that is opened as the Keypad and opens another Popup Screen as the Keypad.



- Press and hold the < **Cur.** and **Cur.** > keys for more than one second to cause it to move repeatedly.
- The **Alt** key can be used, for instance, to switch between Keypads for lower case and upper case letters.

● For Keypad(Hiragana) *1

These keys to enter Hiragana and Kanji which can be used for Character Input are as follows.

■ Character Input Keypad

Key	Operation
あ to ん	Inputs a character from あ to ん .
、	Inputs a 、 .
。	Inputs a 。 .
—	Inputs a — .
small ゃ °	Change the hiragana that you entered in order of lower case conversion, voiced sound input, semi - voiced sound input.
Kanji	Toggles the Direct input mode and Kanji input mode. The default is the Direct input mode. Direct input mode: Enter a Hiragana. Kanji input mode: Enter the Kanji that converted the input Hiragana as a reading of Kanji.
Up	When displaying conversion candidates for Kanji, select the conversion candidate one before.
Down	When displaying conversion candidates for Kanji, select the next conversion candidate.
CAN	Clears the data input thus far and cancels the input. Closes the Popup Screen if it is opened as a Keypad.
CLR	Clears the data input thus far and stands by for further input.
DEL	Deletes the character at the cursor.
BS	Deletes the character to the left the cursor.
ENT	Writes the text input in character code form to a device address. After the data is written, the focus can be moved according to the Focus Order setting. Focus Order can be set on the Options tab of the Screen Properties dialog box. When displaying conversion candidates for Kanji in Kanji input mode, input the selected Kanji.
SP	Inputs a space. When reading is entered in Kanji input mode, conversion candidates for Kanji are displayed.
Cur. >	Moves the cursor right. However, you can not move the cursor when entering characters in Kanji input mode and waiting for conversion.
< Cur.	Moves the cursor left. However, you can not move the cursor when entering characters in Kanji input mode and waiting for conversion.
< Fcs.	Moves the focus one item before the current one as per the Focus Order setting. Focus Order can be set on the Options tab of the Screen Properties dialog box.
Fcs. >	Moves the focus one item after the current one as per the Focus Order setting. Focus Order can be set on the Options tab of the Screen Properties dialog box.
Alt	The Alt key switches the Popup Screen opened as a Keypad. Closes the Popup Screen that is opened as the Keypad and opens another Popup Screen as the Keypad.



Press and hold the < **Cur.** and **Cur.** > keys for more than one second to cause it to move repeatedly.

*1 HG5G/4G/3G/2G-V only

● For Data Transfer Keys

These keys can be used to execute Data Transfer functions. For details about Data Transfer functions, refer to Chapter 29 "Data Transfer Function" on page 29-1.

Key	Operation
Download Project	Downloads a project (ZNV Project File) saved on an external memory device to the MICRO/I.
Upload Project	Uploads the project used for operation on the MICRO/I and saves the ZNV Project File(.znv) to an external memory device.
Copy Files* ¹	Copy files between and within external memory inserted in MICRO/I.
Download PLC Program	Downloads a PLC program (ZLD Project File) saved on an external memory device to a PLC connected to the MICRO/I.
Upload PLC Program	Uploads a PLC program from the PLC connected to the MICRO/I and saves the ZLD Project File(.zld) to an external memory device.

● For Alarm Displays

These keys can be used for the Alarm List Display and Alarm Log Display parts.

■ Alarm List Display

Key	Operation
Page Up	Scrolls up the number of lines (1 to 1023) specified in Scroll Size .
Page Down	Scrolls down the number of lines (1 to 1023) specified in Scroll Size .
Up	Moves the focus the number of lines (1 to 1023) specified in Scroll Size . The current point of focus can be shown by pressing Select .
Down	Moves the focus the number of lines (1 to 1023) specified in Scroll Size . The current point of focus can be shown by pressing Select .
Select	Toggles the focus between show and hide.
Reference	The reference screen appears.



Press and hold the **Page Up**, **Page Down**, **< Cur.**, and **Cur. >** keys for more than one second to move the focus repeatedly.

■ Alarm Log Display

Key	Operation
Up	Moves the focus the number of lines (1 to 1023) specified in Scroll Size . The current point of focus can be shown by pressing Select .
Down	Moves the focus the number of lines (1 to 1023) specified in Scroll Size . The current point of focus can be shown by pressing Select .
Select	Toggles the focus between show and hide.
Check	Shows the date and time the alarm that has focus was confirmed.
All Check	Shows the date and time that all alarms were confirmed.
Delete	Clears the alarm that has focus.
Delete All	Clears all alarms.
Reference	Shows the reference screen for the alarm that has focus.
Stop Buzzer and Screen Flashing	Stops the sound of the buzzer and screen flashing when an alarm occurs.



Press and hold the **Up** and **Down** keys for more than one second to move the focus repeatedly.

*1 HG5G/4G/3G/2G-V, HG4G/3G, HG2G-5F only

- For the Data Log Display

The keys that can be used for the Data Log Display part are as follows.

- **Data Log Display**

Key	Operation
Operate	Toggles the display updates between stop and resume.
Up	Scrolls the number of lines (1 to 1023) specified in Scroll Size upward.
Down	Scrolls the number of lines (1 to 1023) specified in Scroll Size downward.
Left	Scrolls data one column to the left.
Right	Scrolls data one column to the right.
Page Up	Scrolls data up one page.
Page Down	Scrolls data down one page.
Page Left	Scrolls data left one page.
Page Right	Scrolls data right one page.



Press and hold the **Up, Down, Left** and **Right** keys for more than one second to cause it to move repeatedly.

- For the Multimedia Function*¹

- **Recording**

Key	Operation
Stop	Stops recording images and sound* ² .
Rec.	Records images and sound* ² .

- **Video Display**

The keys that can be used with the Video Display are given below.

Key	Operation
Play	Play movie file and display images from the video input.
Stop	Stops movie file playback.
Pause	Pauses playback of a movie file.
Next	When this button is pressed during playback, the next movie file is played.
Back	When this button is pressed during playback, the previous movie file is played.
REW	When this button is pressed during playback, the movie file rewinds while being played. Press this button during rewind to return to normal playback. This button cannot be used during fast forward, slow, or when paused.
FF	When this button is pressed during playback, the movie file fast forwards while being played. Press this button during fast forward to return to normal playback. This button cannot be used during rewind, slow, or when paused.
Slow	Press this button for slow movie file playback. Press this button during slow playback to return to normal playback. This button cannot be used during fast forward, rewind, or when paused.
Frame Fwd	Press this button to play the movie file one frame at a time. After frame forward, the movie file is paused. This button cannot be used during fast forward, rewind, or slow playback.
Full Screen	Expand the display image to the maximum size of the screen.
Restore	Returns Full Screen to its original display.
Repeat ON	Repeats playback from the top of the list when the movie file list or playlist is played until the end.
Repeat OFF	Stops playback after the movie file list or playlist is played until the end.

- For Password Inputs

Key	Operation
Up	Switch to the previous user.
Down	Switch to the next user.

*1 This is applicable for models with a video interface only.

*2 Recording sound function is for HG4G/3G only

5.5 Key Browser

Select the key using the Key Browser. The Key Browser closes when a key is selected. The name of the key is shown in **Key Type**. Settings that apply to the selected key are displayed.



When you select a key, the label for that key is assigned as the Registration Text.

Select the key type from the following uses:

Keypad(Half-Width Character), Keypad(Hiragana)*¹, Data Transfer, Alarm Display, Multimedia Function*²

■ Keypad(Half-Width Character)

These buttons are used for Numerical Input and Character Input:

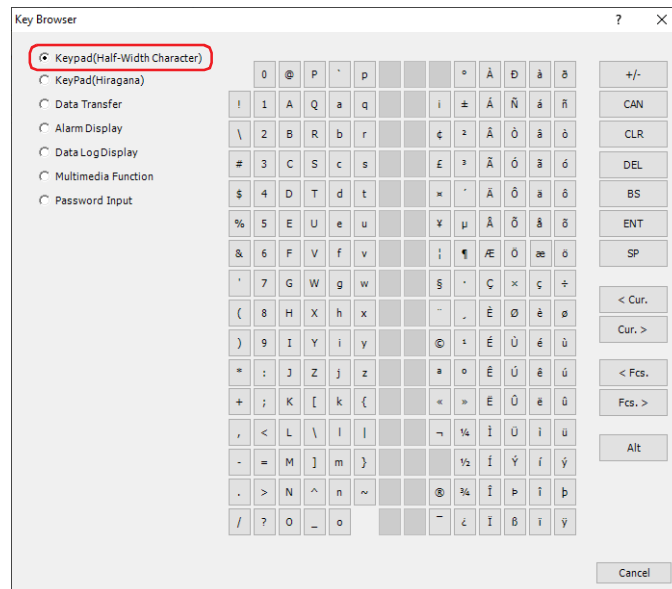

■ Keypad(Hiragana)*¹

These buttons are used for Character Input to enter Hiragana and Kanji:

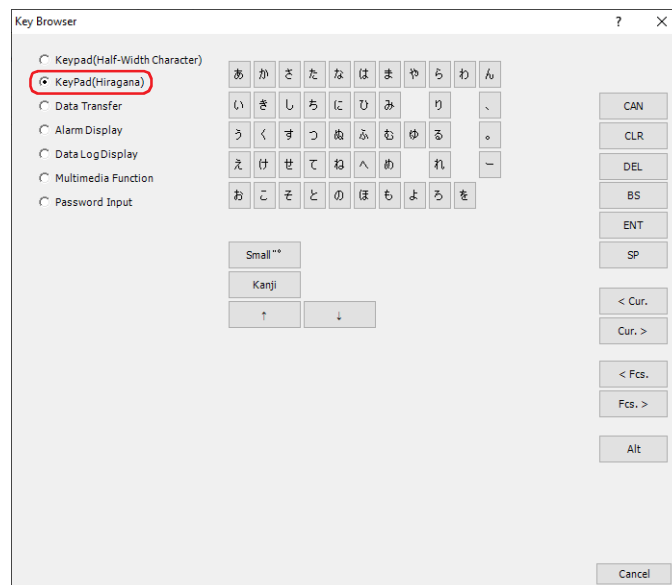

*1 HG5G/4G/3G/2G-V only

*2 This is applicable for models with a video interface only.

■ Data Transfer

These buttons are used to execute Data Transfer functions.

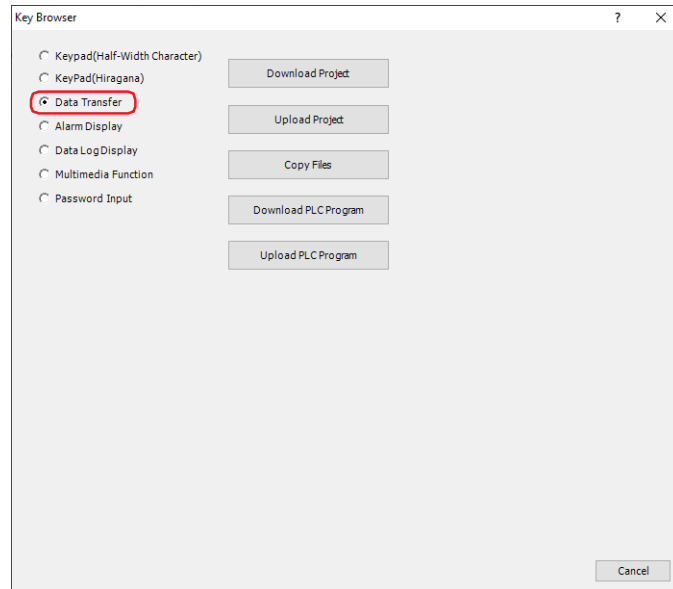

■ Alarm Display

These buttons are used to manipulate the Alarm List Display and Alarm Log Display parts.

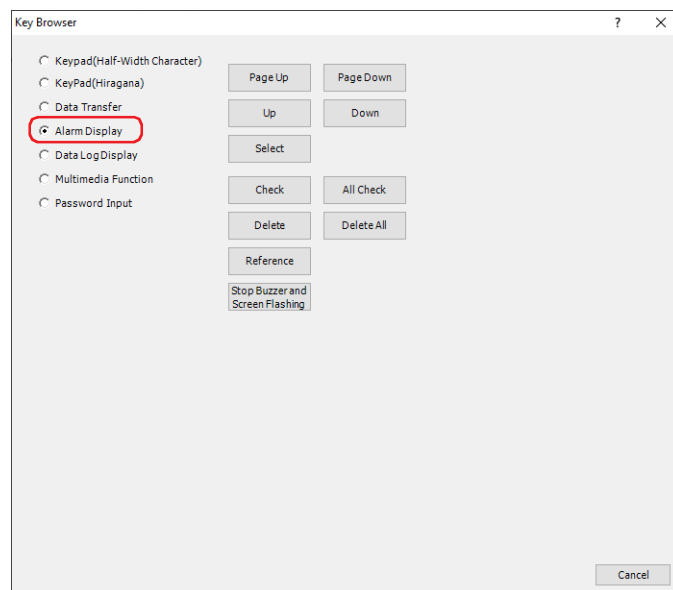

■ Data Log Display

These keys operate the Data Log Display.

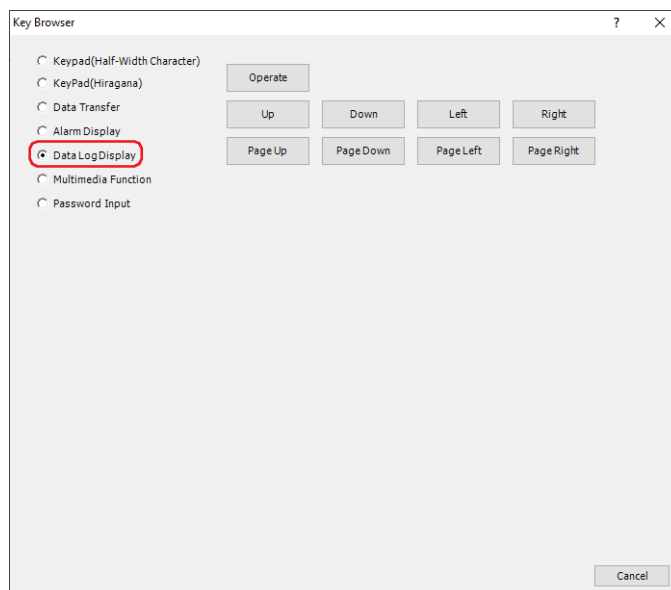

■ Multimedia Function *2

These buttons are used to start and stop recording and to operate the Video Display.

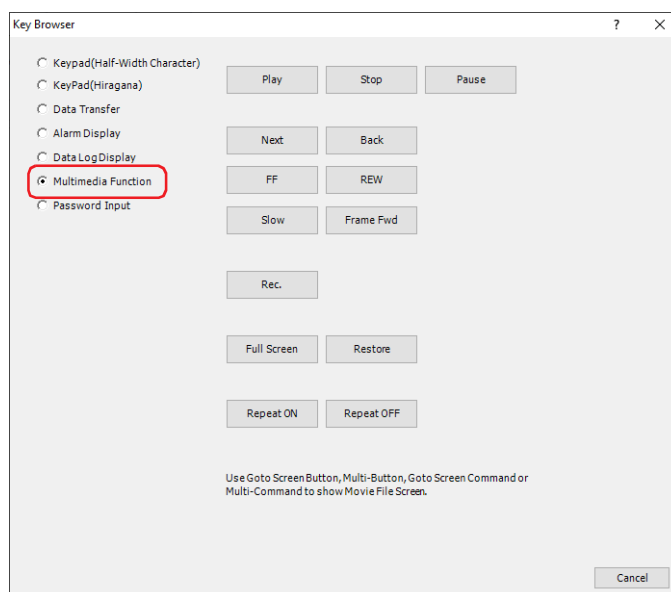

*2 This is applicable for models with a video interface only.

■ **Password Input**

These keys switch the user on the Password Input Screen.

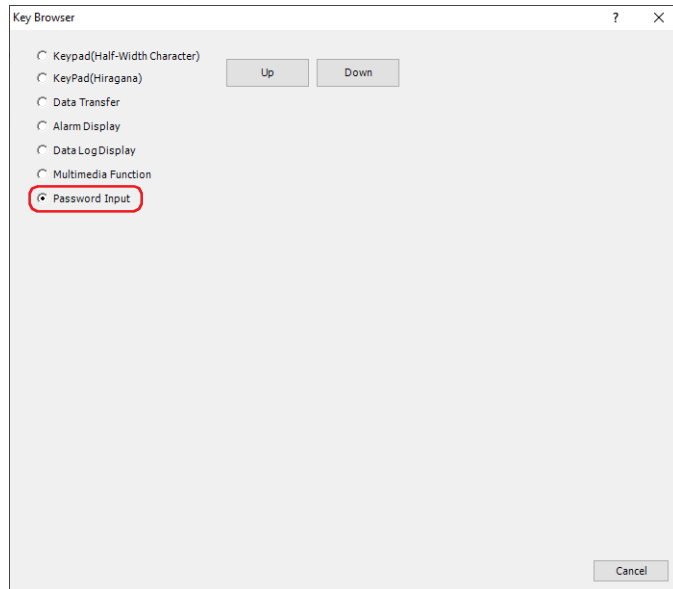

5.6 Key Button Usage Examples

● Recording Images and Sound*1

HG2J-7U HG5G-V HG4G-V HG4G HG3G-V HG3G HG2G-V HG2G-5F HG2G-5T HG1G HG1P

This section describes how to record using the **Rec.** and **Stop** key buttons.

Configuration Procedure

- 1 On the **Home** tab, in the **Parts** group, click **Buttons**, and then click **Key Button**.

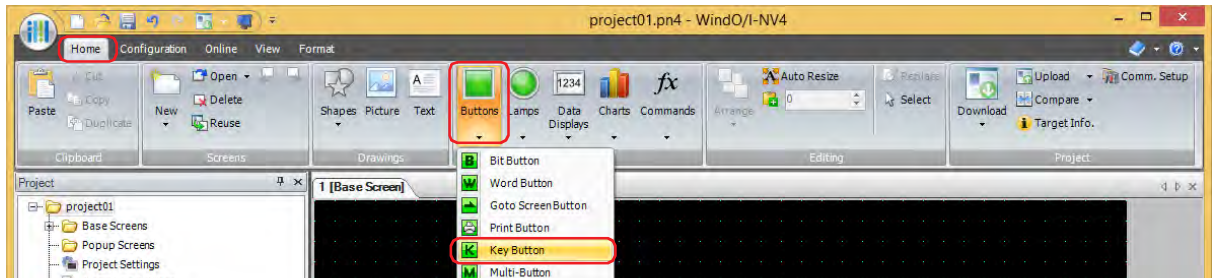

- 2 Click a point on the edit screen where you wish to place the Key Button.
- 3 Double-click the placed Key Button and a Properties dialog box will be displayed.

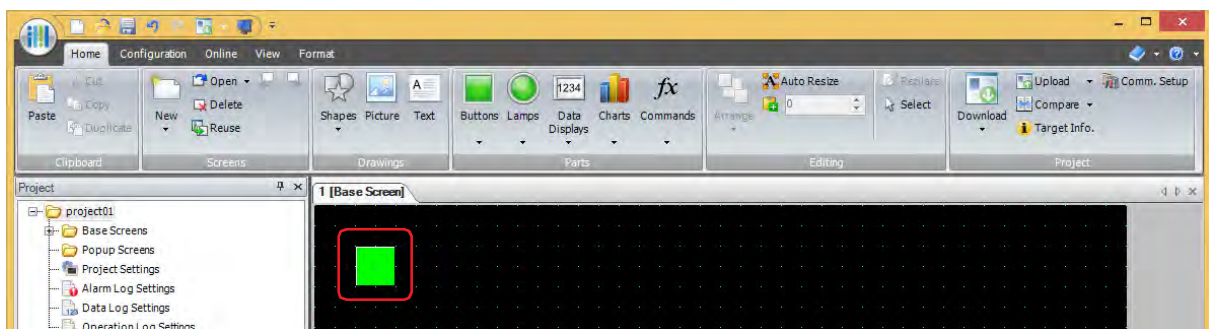

- 4 On the **General** tab, under **Key Type**, click **Browse**.
Key Browser is displayed.

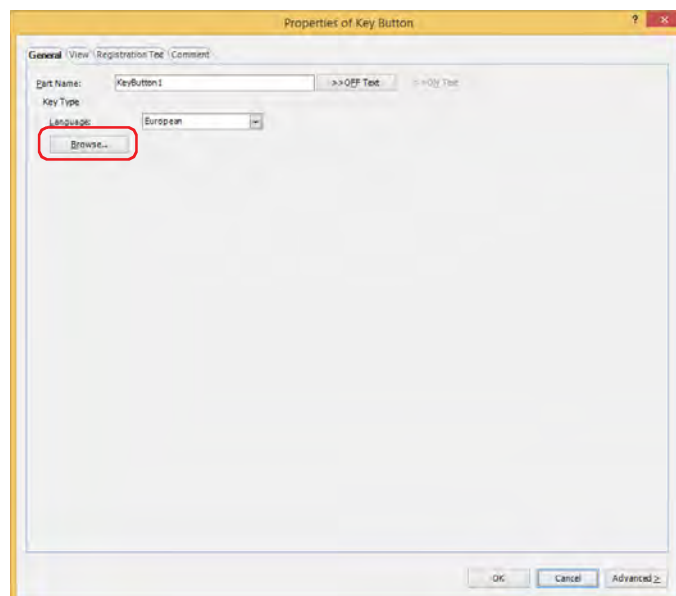

*1 Recording sound function is for HG4G/3G only

5 Select **Multimedia Function** and click **Rec.**

You are returned to the Properties of Key Button dialog box.

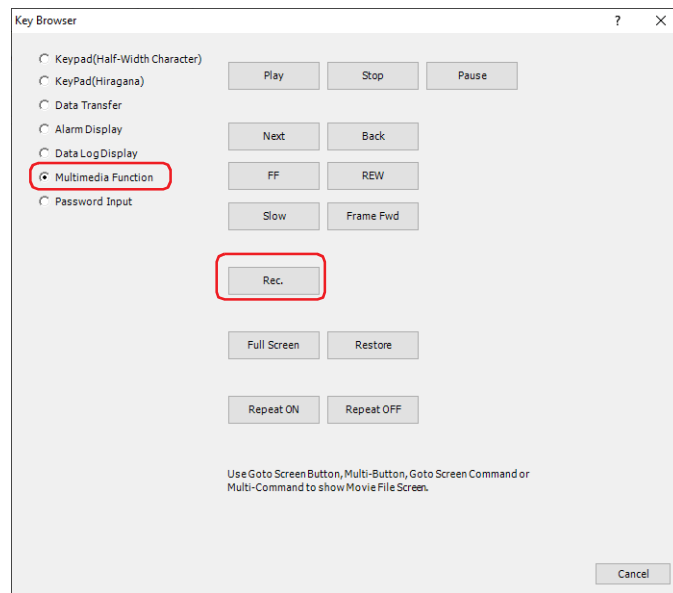

6 Select a recording channel*² or a recording target*³.

■ **Recording Channel***²

Selects **Channel 1** or **Channel 2** to record a video only (no audio) out of the signals input from the device. This setting is enabled only if **Rec.** was selected using the Key Browser.

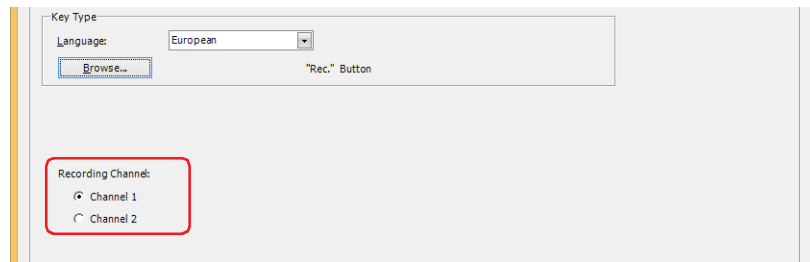

■ **Recording Target***³

In the signals input from the device, select **Video and Audio** or **Video only (No Audio)** as the recording target.

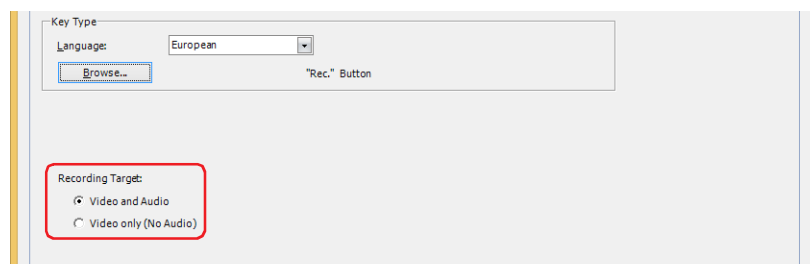

7 Click **OK**.

Close the Properties of Key Button dialog box.

8 Repeat steps 1 through 4.

*2 HG5G/4G/3G-V only

*3 This is applicable for HG4G/3G with a video interface only.

9 Select **Multimedia Function** and click **Stop**.

You are returned to the Properties of Key Button dialog box.

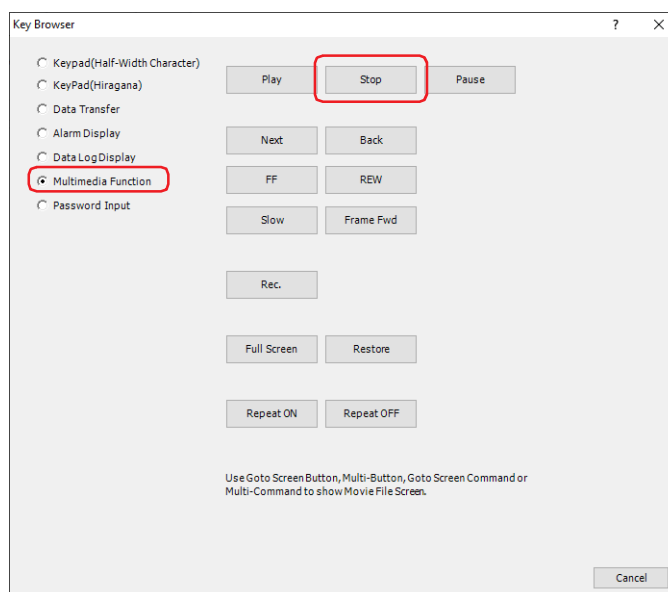

10 Click **OK**.

Close the Properties of Key Button dialog box.

This concludes configuring the record function and key buttons.

Operating Procedure

The MICRO/I must be connected to a video camera and microphone*1.

1 Press the **Rec.** button.

The MICRO/I starts recording images and sound*1.

2 Press the **Stop** button.

The MICRO/I stops recording images and sound*1.



Recording stops when the maximum recording time (30 sec.) has elapsed, even if the **Stop** button is not pressed.

The recorded images and sound*1 are saved as a file*2 in the following folder on the external memory device.

\External Memory Device folder\RECORD\Year month day (format: YYYYMMDD)

The External Memory Device folder name is configured in the **Project Settings** dialog box. For details, refer to Chapter 31 "1.6 Setting the External Memory Device Folder" on page 31-12.

The "year month day" folder name is the date the file was recorded.

The file name for the recorded file is the time the file was saved.



- Movie files cannot be recorded during playback.
- While data is being recorded after an event occurs with the event recording function and while recorded data is being saved to the external memory device, recording cannot be executed with a Key Button, Multi-Button, or Multi-Command configured with the recording function. Also, during these situations, the value of HMI Special Data Register LSD155-0 changes to 1. For details, refer to Chapter 33 "HMI Special Data Register (LSD)" on page 33-8.



The signal standard for the video camera connected to the MICRO/I is configured in the **Multimedia Settings** dialog box, on the **Video Input** tab. For details, refer to Chapter 22 "2.3 Configuring the Video Input" on page 22-11.

*1 Recording sound function is for HG4G/3G only

*2 AVI format for HG5G/4G/3G-V, MP4 format for HG4G/3G

● Playing Recorded Images and Sound

HG2J-7U HG5G-V HG4G-V HG4G HG3G-V HG3G HG2G-V HG2G-5F HG2G-5T HG1G HG1P

This section describes how to select a movie file to play with the Movie File Screen and play it on a Video Display.

Configuration Procedure

- 1 On the **Home** tab, in the **Parts** group, click **Data Displays**, and then click **Video Display**.

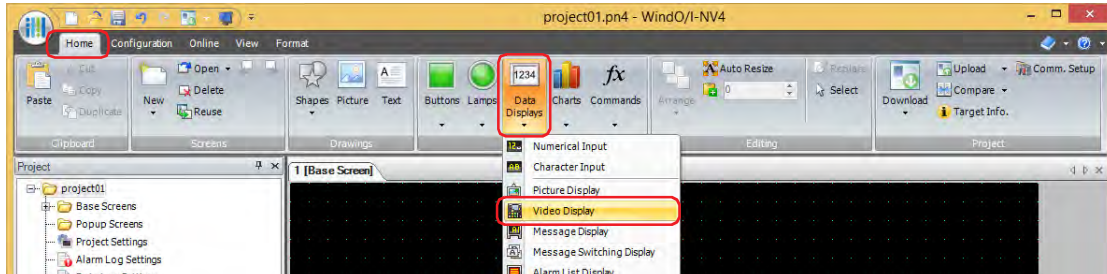

- 2 Click a point on the edit screen where you wish to place the Video Display.
- 3 Double-click the placed Video Display and the Properties dialog box is displayed.

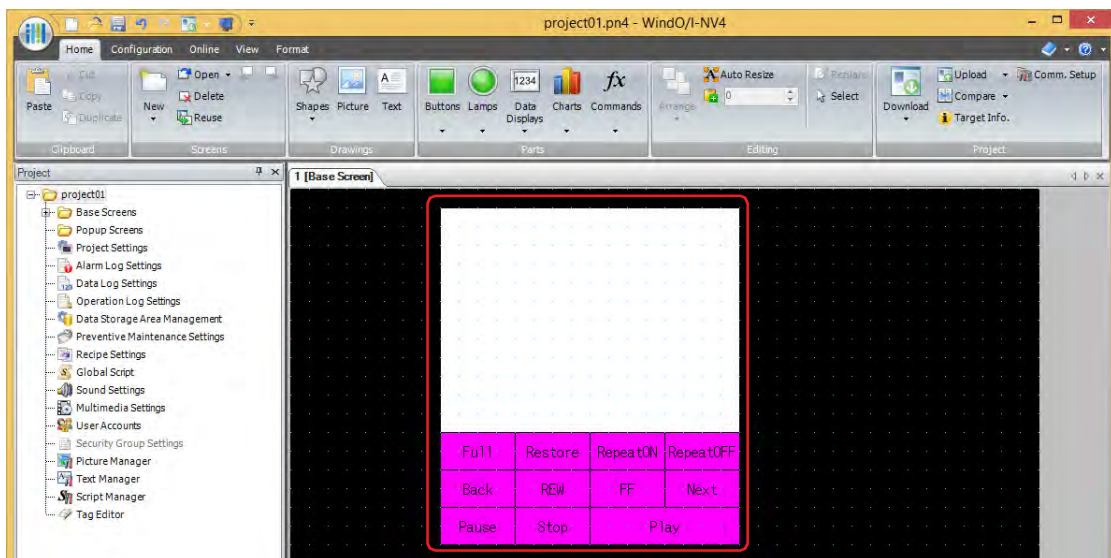

- 4 On the **General** tab, under **Action**, select **Play a movie or recorded file from the File Screen**. This option selects and plays movie files using the File Screen.

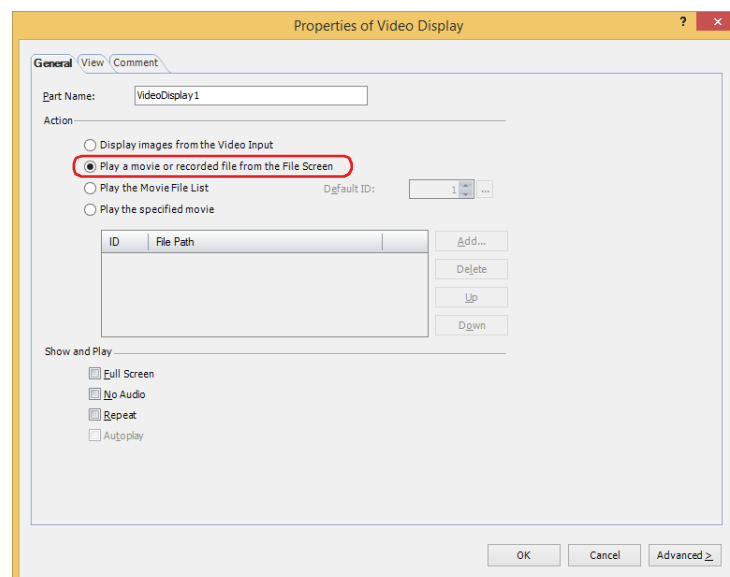

5 Click **OK**.

The Properties of Video Display dialog box closes.

6 Create a button to open the screen to select a recorded images.

On the **Home** tab, in the **Parts** group, click **Buttons**, and then click **Goto Screen Button**.

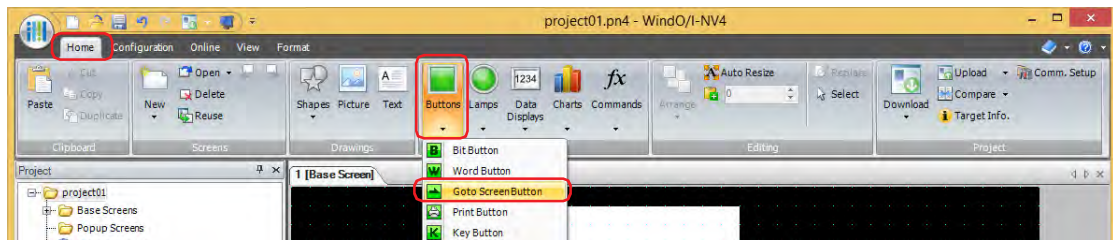

7 Click a point on the edit screen where you wish to place the Goto Screen Button.

8 Double-click the placed Goto Screen Button and a Properties dialog box will be displayed.

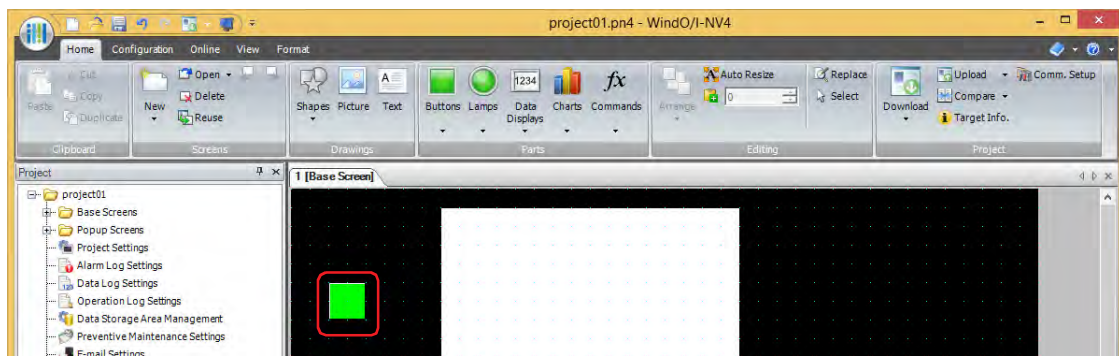

9 Select **Open File Screen for Movie Files** for **Action Mode**.

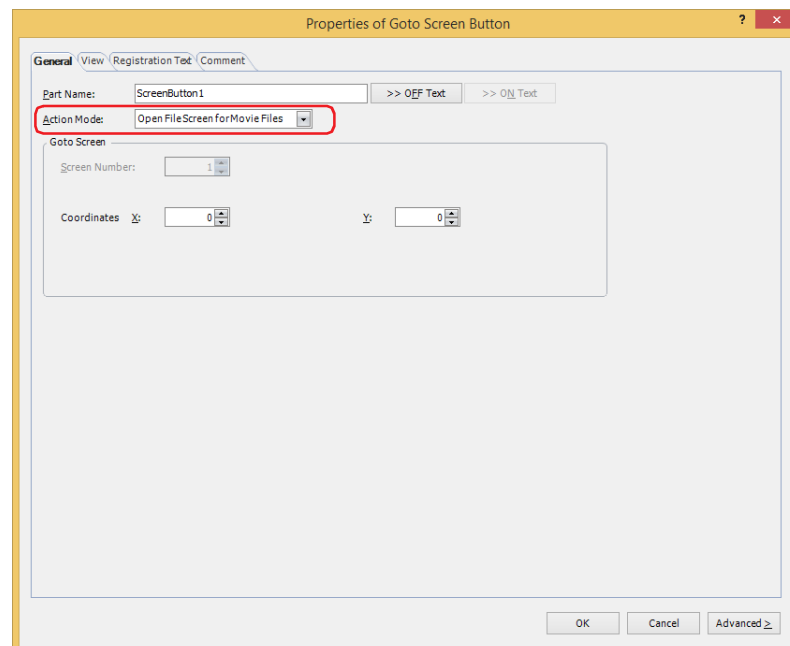

10 Specify the display location in coordinates for the movie file screen to open above the base screen with **Coordinates X, Y**.

With the upper-left corner of the screen as the origin, the upper-left corner of the window is the X and Y coordinates.

X: 0 to (base screen horizontal size - 1)

Y: 0 to (base screen vertical size - 1)

11 Click **OK**.

Close the Properties of Goto Screen Button dialog box.

This concludes configuring playback of recorded images.

Operating Procedure

To play sound, the MICRO/I must be connected to speakers.

This section describes the example of playing the movie file "123000.avi" located in the "20110313" folder under the "RECORD" folder when the External Memory Device folder is "HGDATA01".



Movie files that meet the following specifications can be played with the MICRO/I:

HG5G/4G/3G-V: AVI file (.avi)

HG4G/3G: MP4 file (.mp4)

For details, refer to Chapter 2 "1.6 Available Movie Files" on page 2-37.

1 Press the Goto Screen Button set to **Open File Screen for Movie Files**.

The File Screen is displayed.

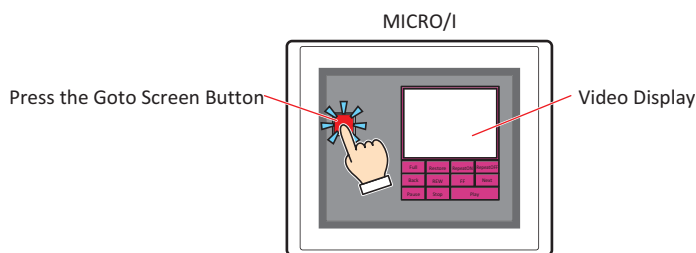

2 Select the folder with the date of the recorded images.

Press **▼** to select **20110313** and then press **Select**.

The contents of the "20110313" folder will be displayed.

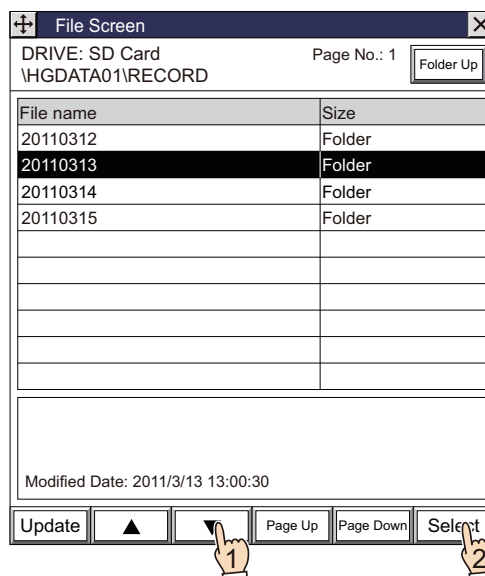

Once the File Screen is opened, the "RECORD" folder in the External Memory Device folder will be displayed. If the "RECORD" folder does not exist, the External Memory Device folder will be displayed.

3 Select a movie file.

Press ▼ to select "123000.avi" and then press **Select**.

The movie file will be selected and the File Screen will close.

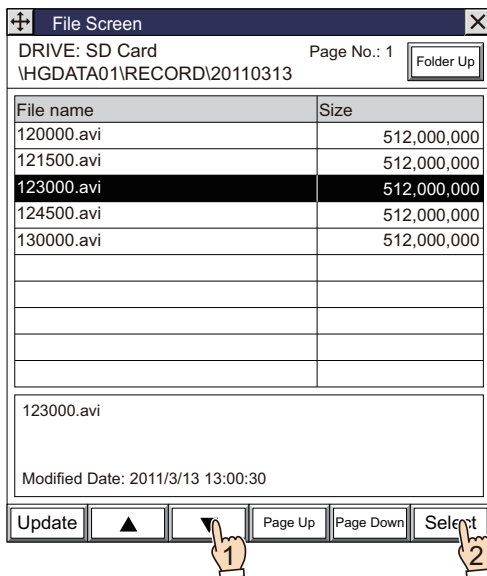

4 Press **Play** on the Video Display.

The movie file is played.

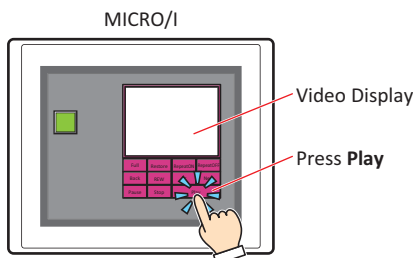

! While data is being recorded after an event occurs with the event recording function, while data is being recorded with a Key Button, Multi-Button, or Multi-Command configured with the recording function, or while data is being saved to the external memory device, movie files cannot be played. While data is recording after an event occurs and while data is being saved to the external memory device, the value of HMI Special Data Register LSD155-0 changes to 1. For details, refer to Chapter 33 "HMI Special Data Register (LSD)" on page 33-8.

6 Multi-Button

HG2J-7U HG5G-V HG4G-V HG4G HG3G-V HG3G HG2G-V HG2G-5F HG2G-5T HG1G HG1P

6.1 How the Multi-Button is Used

Executes multiple commands at once.

These commands can be assigned to a Multi-Button.

Command	Description
Bit Write	Writes a 0 or 1 to the specified bit device when pressed.
Word Write	Writes a value to a word device when pressed. You can specify the destination address number indirectly, and perform arithmetic on the value to be written.
Goto Screen	Switches screens and opens other windows when pressed.
Print	Outputs a screenshot to the printer or the external memory device ^{*1} when pressed.
Key	Performs downloads, uploads, and file copying when pressed. Also used to manipulate other parts.
Script	Executes a script when pressed.

- Pressing the button writes a 1 to a bit device, and the value of word device to another device address.

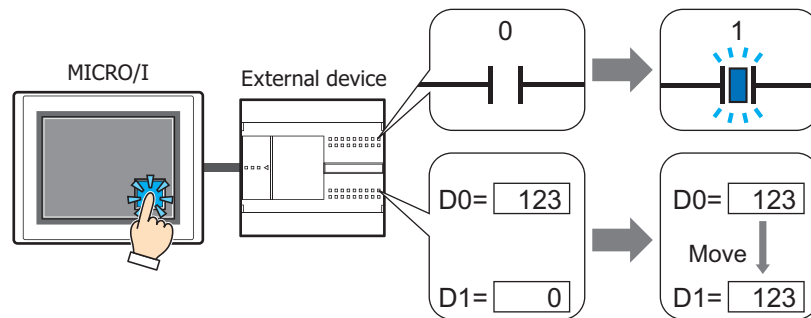

- Pressing the button outputs a screenshot of the current screen to an external memory device ^{*1}, and then switches the Base Screen.

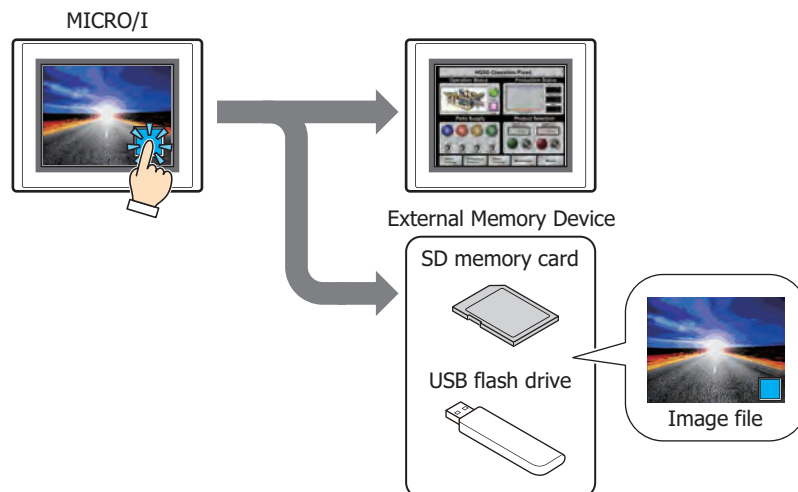

*1 USB flash drive inserted in USB1 for HG2J-7U, SD memory card for HG5G/4G/3G/2G-V, HG4G/3G and HG2G-5F, USB flash drive for HG2G-5T and HG1G/1P

■ Momentary

The button turns ON when pressed, and OFF when released.

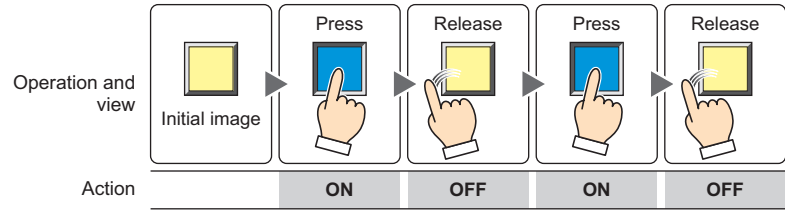

■ Alternate

The button switches between ON and OFF each time it is pressed.

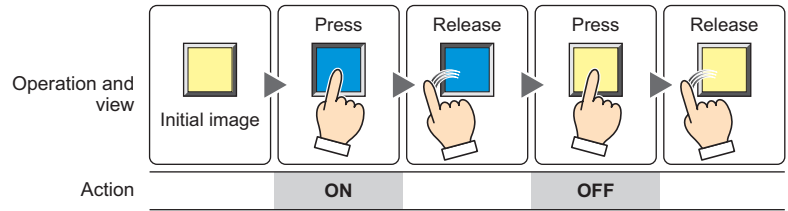

6.2 Multi-Button Configuration Procedure

This section describes the configuration procedure for Multi-Buttons.

- 1 On the **Home** tab, in the **Parts** group, click **Buttons**, and then click **Multi-Button**.

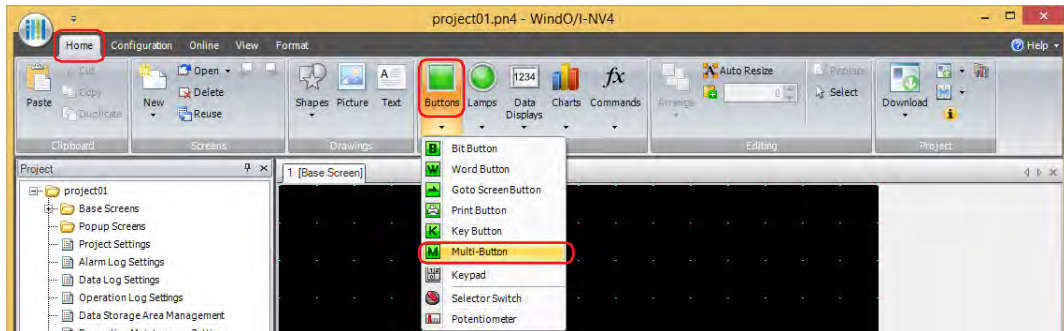

- 2 Click a point on the edit screen where you wish to place the Multi-Button.
- 3 Double-click the placed Multi-Button and a Properties dialog box will be displayed.
- 4 Change the settings on each tab as necessary.

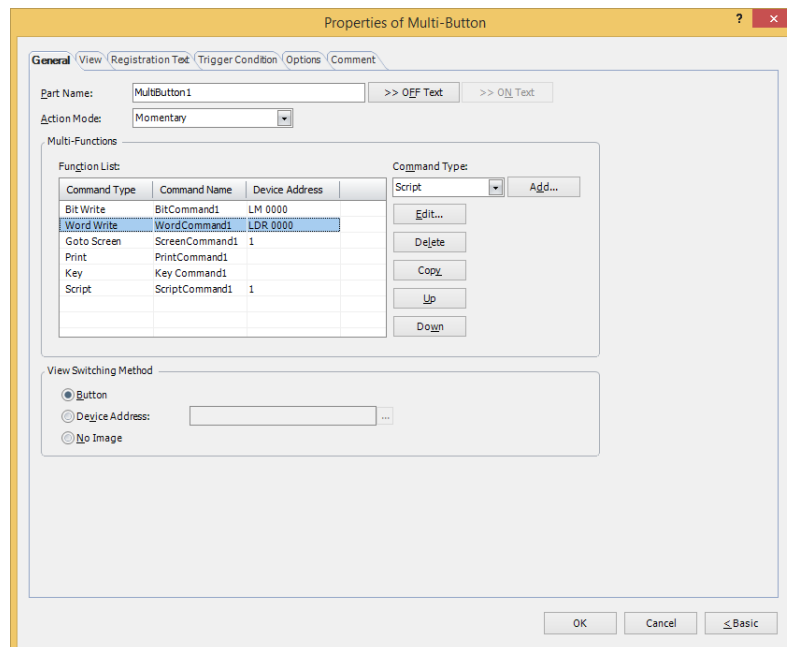

The **Trigger Condition** tab and **Options** tab only appear in Advanced mode.



You can set the default for the Multi-Button on the **Default Preferences** tab of the **WindO/I-NV4 Options** dialog box. For details, refer to Chapter 2 "Default Preferences Tab" on page 2-63.

6.3 Properties of Multi-Button Dialog Box

This section describes items and buttons in the Properties dialog box.

● General Tab

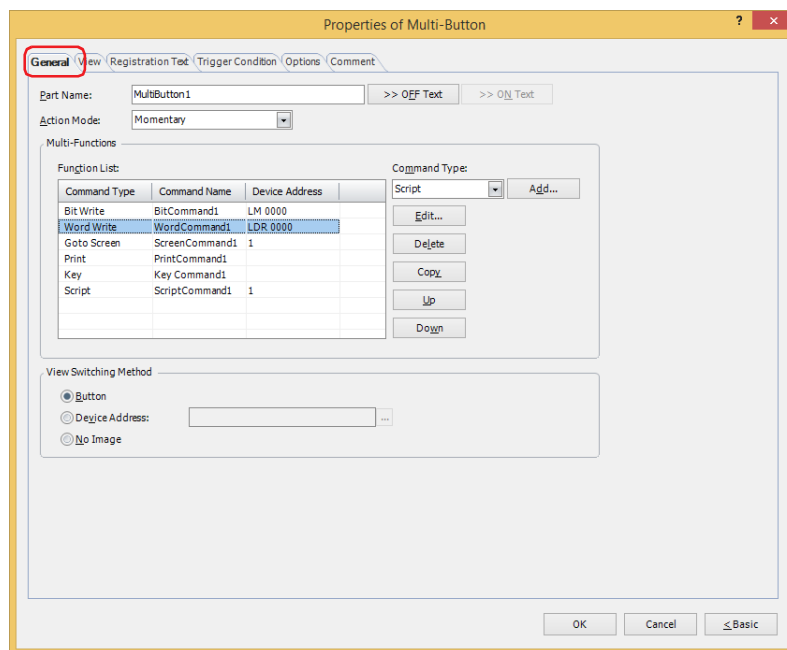

■ Part Name

Enter a name for the part. The maximum number is 20 characters.

■ >>OFF Text, >>ON Text

Applies the text entered in the **Part Name** field to the **Text** field under the **OFF** or **ON** fields on the **Registration Text** tab. This is used as the Registration Text when the button is OFF or ON.



To specify the Registration Text to use when the button is ON, select the **Set by State** check box on the **Registration Text** tab. If left unchecked, the same Registration Text assigned for the OFF state is displayed for the ON state as well.

■ Action Mode

Select the **Action Mode** for the Multi-Button: **Momentary** or **Alternate**.

Momentary: The button turns ON when pressed, and OFF when released.

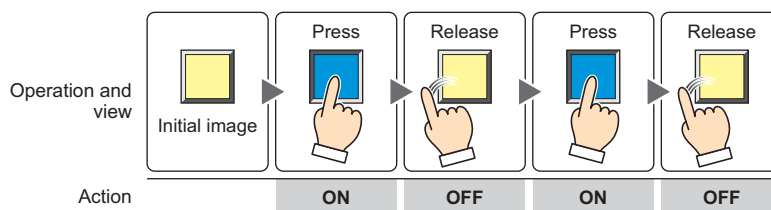

Alternate: The button switches between ON and OFF each time it is pressed.

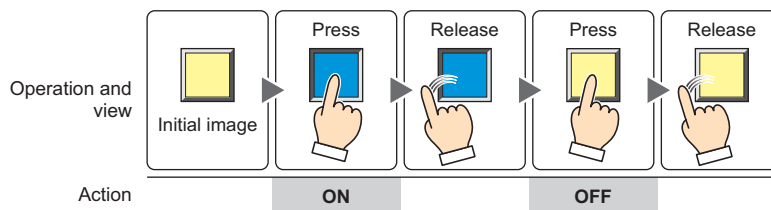

■ Multi-Functions

Use this grid to add or edit commands to execute when the Multi-Button is pressed.

Function List:	Lists the commands to be executed.
Command Type:	Shows the command type.
Command Name:	Shows the command name.
Device Address:	Shows the setting when one of the following Command Type is selected. Shows the destination device address for the Bit Write and Word Write commands. Shows the screen number when Goto Screen is set to Switch to Base Screen, Open Popup Screen, or Close Popup Screen . Shows the script ID for the Script command.



- Executes only the Goto Screen command at the end of the **Function List** when multiple **Switch to Base Screen** type commands are set for **Action Mode**.
- Goto Screen commands are not executed from top to bottom as they appear in the **Function List**. Rather, they are executed at the end of the scan when the Multi-Button is pressed.
- If multiple Key commands are set, only the first and second Key commands in the **Function List** are executed. The third and following Key commands are not executed. Also, only the first Key command that specifies a Data Transfer function in the **Function List** is executed if multiple Key commands are set.
- Key commands are executed in the scan that follows a scan that satisfies the trigger condition.

Command Type: Select the command to add.

Bit Write:	Writes a 0 or 1 to the bit device or the bit number of the word device. For details, refer to "Properties of Bit Write for Multi-Functions Dialog Box" on page 8-116.
Word Write:	Writes a value to a word device. Can be used to indirectly specify the destination address or to perform operations on the written value. For details, refer to "Properties of Word Write for Multi-Functions Dialog Box" on page 8-117.
Goto Screen:	Switches to another screen or displays a window. For details, refer to "Properties of Goto Screen for Multi-Functions Dialog Box" on page 8-119.
Print:	Outputs a screenshot to a printer or an external memory device. For details, refer to "Properties of Print for Multi-Functions Dialog Box" on page 8-121.
Key:	Performs a variety of functions including uploading and downloading, copying files, and operating other parts. For details, refer to "Properties of Key for Multi-Functions Dialog Box" on page 8-123.
Script:	Executes the script. For details, refer to "Properties of Script for Multi-Functions Dialog Box" on page 8-130.
Add:	Adds a command to the list. A maximum of 32 commands may be added. Click this button to display the Properties dialog box for the command selected from Command Type .
Edit:	Changes a command in the list. Click this button to display the Properties dialog box for the command selected in Function List .
Delete:	Deletes a command from the list. Select the command in the list and click this button.
Copy:	Copies a command in the list. Select a command in the list and click this button. A copy of the selected command is added to the end of the list.
Up:	Shifts the selected command upward in the list.
Down:	Shifts the selected command downward in the list.

■ View Switching Method*1

Select how to display the ON/OFF status of the button.

Button: Pressing the button changes the drawing object displayed.

Device Address: The drawing objects assigned to the OFF and ON states are displayed when the value of the device address is 0 and 1, respectively. Specifies the device address used to switch the drawing object display.

Click  to display the Tag Editor. For the device address configuration procedure, refer to Chapter 2 "5.1 Device Address Settings" on page 2-70.

No Image: The button is not displayed on the screen. The button appears as a dashed line frame on the edit screen. Pressing the corresponding area on the MICRO/I activates the assigned function. If **No Image** is selected, the settings for View and Registration Text are disabled.



Selecting **Device Address** in **View Switching Method** allows you to create an illuminated pushbutton. The illuminated pushbutton switches state (or image) according to ON or OFF state of the device address, allowing you to display the state of a device that is being operated.

Example: When you set an external device address 'M0' as **Device Address** in **View Switching Method**, if the value of M0 changes, the display image will be switched according to the value of M0 even if the button is not pressed.

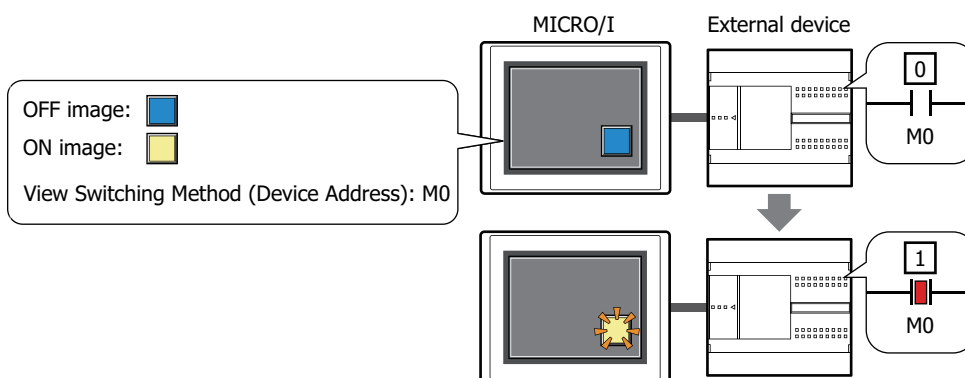

*1 Advanced mode only

Properties of Bit Write for Multi-Functions Dialog Box

Sets the Bit Write command for the Multi-Button.

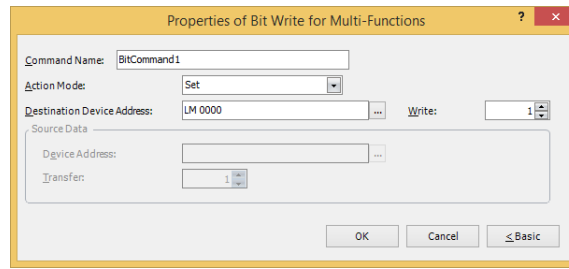

■ Command Name

Enter a name for the command. The maximum number is 20 characters.

■ Action Mode

Select the behavior of the Multi-Button from the following:

- Set: Pressing the Multi-Button writes a 1 to the bit device.
- Reset: Pressing the Multi-Button writes a 0 to the bit device.
- Set & Reset: Pressing the Multi-Button writes a 1 to the bit device. Releasing the Multi-Button writes a 0 to the bit device.
- Toggle: Pressing the Multi-Button inverts the value of the bit device. If the value of the bit device is 0 it changes to 1, and vice versa.
- Move: Pressing the Multi-Button writes the value in the source bit device to the value in the destination bit device.



For details about the **Action Mode**, refer to "Action Mode" on page 8-4. However, **Set & Reset** for the Multi-Button has the same function as **Momentary** for the Bit Button.

■ Destination Device Address

Specify the destination bit device.

Click to display the Tag Editor. For the device address configuration procedure, refer to Chapter 2 "5.1 Device Address Settings" on page 2-70.

■ Write ^{*1}

Specify the number of bit devices (1 to 64) at the destination.

This setting is enabled only if **Action Mode** is set to **Set** or **Reset**. For details, refer to "Write ^{*1}" on page 8-6.

■ Source Data

Specifies the device address that stores the data to be written.

This setting is enabled only if **Action Mode** is set to **Move**. For details, refer to "Source Data" on page 8-6.

Device Address: Specify the source bit device.

Click to display the Tag Editor. For the device address configuration procedure, refer to Chapter 2 "5.1 Device Address Settings" on page 2-70.

Transfer: Specify the number of bit devices (1 to 64) to transfer.

*1 Advanced mode only

Properties of Word Write for Multi-Functions Dialog Box

Sets the Word Write command for the Multi-Button.

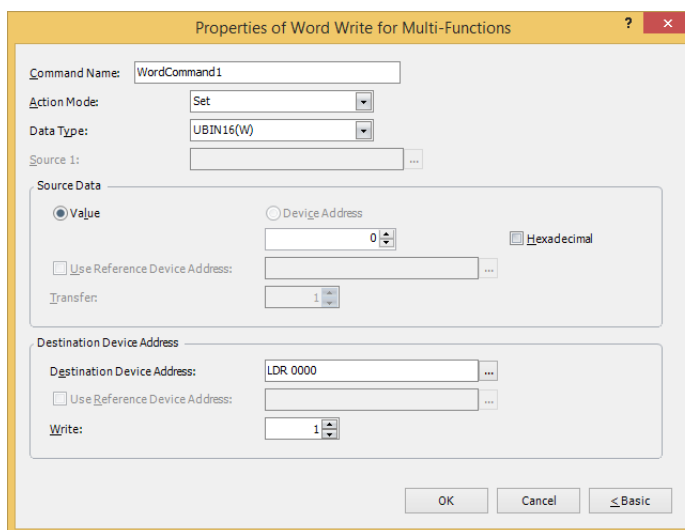

■ Command Name

Enter a name for the command. The maximum number is 20 characters.

■ Action Mode

Select the behavior of the Multi-Button from the following:

Set: Pressing the button writes a fixed value to a word device.

Move: Pressing the button writes a value in a source device address to a destination word device.

Set ON & OFF Data: Pressing the button writes a fixed value of **ON Data** to a word device.
Releasing the button writes a fixed value of **OFF Data** to a word device.

Add, Sub, Multi, Div, Mod, OR, AND, XOR: Pressing the button performs arithmetic on a value of source device address and a fixed value or a value of device address and writes the result to a word device.



For details about the **Action Mode**, refer to "Action Mode" on page 8-23. However, **Set ON & OFF Data** for the Multi-Button has the same function as **Momentary** for the Word Button.

■ Data Type

Select the data type handled by the operation selected for **Action Mode**.

For details, refer to Chapter 2 "1.1 Available Data" on page 2-1

UBIN16(W) and **UBIN32(D)** can only be set if **Action Mode** is set to **OR, AND, or XOR**.



UBIN16(W) and **UBIN32(D)** can only be set if **Action Mode** is set to **Move**. Because the number of device addresses to transfer is specified in Advanced mode, you do not need to set Data Type.



If **BCD4(B)**, **BCD8(EB)**, or **Float32(F)** is selected and the arithmetic data contains a value inexpressible in BCD, a 1 is written to System Area 2 Processing error bit (address+2, bit 5) and an error message is displayed. For details, refer to Chapter 4 "Processing error" on page 4-32 and Chapter 36 "Processing error" on page 36-3.

■ Source 1

Specify the source word device.

Click to display the Tag Editor. For the device address configuration procedure, refer to Chapter 2 "5.1 Device Address Settings" on page 2-70.

This setting is enabled only if **Action Mode** is set to **Add, Sub, Multi, Div, Mod, OR, AND, or XOR**.

■ Source Data

Select the data handled by the operation selected for **Action Mode**.

Value: Use a constant value.

Only a **Value** can be handled if **Action Mode** is set to **Set** or **Set ON & OFF Data**.

If **Action Mode** is set to **Set ON & OFF Data**, the value in the **ON Data** is written when the button is ON, and the value in the **OFF Data** is written when the button is OFF.

Hexadecimal: Select this check box to enter the **ON Data** and **OFF Data** values in hexadecimal.

Device Address: Use a value of device address.

Specify the device.

Click to display the Tag Editor. For the device address configuration procedure, refer to Chapter 2 "5.1 Device Address Settings" on page 2-70.

Use Reference Device Address^{*1}: Select this check box and specify a device address to change the source word device according to the value of the specified device address.

This setting is enabled only if **Action Mode** is set to **Move**.

For details, refer to Chapter 2 "Indirect Read and Indirect Write Settings" on page 2-5.

Transfer^{*1}:

Specify the number of word devices (1 to 64) to transfer.

This setting is enabled only if **Action Mode** is set to **Move**.

For details, refer to "Transfer^{*1}" on page 8-25.

■ Destination Device Address

Destination Device Address: Specify the destination word device.

Click to display the Tag Editor. For the device address configuration procedure, refer to Chapter 2 "5.1 Device Address Settings" on page 2-70.

Use Reference Device Address^{*1}: Select this check box and specify a device address to change the destination word device according to the value of the specified device address.

This setting is enabled only if **Action Mode** is set to **Move**.

For details, refer to Chapter 2 "Indirect Read and Indirect Write Settings" on page 2-5.

Write^{*1}:

Specify the number of word devices (1 to 64) at the destination.

For **Move**, specify how many times to write.

This setting is enabled only if **Action Mode** is set to **Set**, **Move**, or **Set ON & OFF Data**.

For details, refer to "Write^{*1}" on page 8-26.

*1 Advanced mode only

Properties of Goto Screen for Multi-Functions Dialog Box

Sets the Goto Screen command for the Multi-Button.

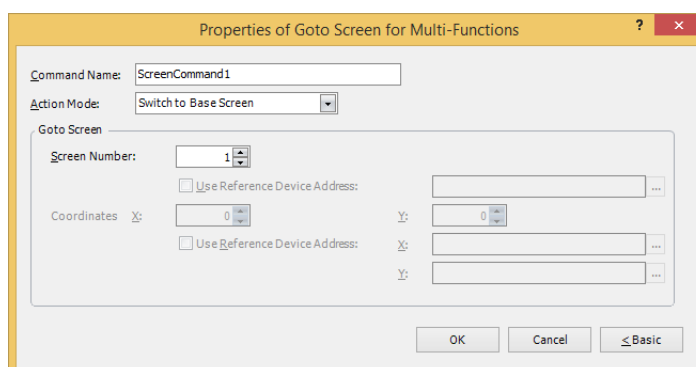

■ Command Name

Enter a name for the command. The maximum number is 20 characters.

■ Action Mode

Select the behavior of the Multi-Button from the following:

- | | |
|---|--|
| Back to previous Screen: | Switches to the previous screen. Returns to up to 16 earlier screens. |
| Switch to Base Screen: | Switches between Base Screen. |
| Open Popup Screen: | Opens a Popup Screen. |
| Close Popup Screen: | Closes a Popup Screen. |
| Open Device Monitor Screen: | Opens the Device Monitor Screen. |
| Close Device Monitor Screen: | Closes the Device Monitor Screen. |
| Open Password Screen: | Opens the Password Screen. |
| Close Password Screen: | Closes the Password Screen. |
| Open Adjust Brightness Screen: | Opens the Adjust Brightness Screen. |
| Close Adjust Brightness Screen: | Closes the Adjust Brightness Screen. |
| Open File Screen for movie files ^{*2} : | Opens the File Screen. |
| Close File Screen for movie files ^{*2} : | Closes the File Screen. |
| Switch to System Mode: | Switches to the Top Page in the System Mode. |
| Reset current screen: | Resets the current Base Screen.
When the current screen is reset, the displayed Popup Screen is closed and the following internal devices restart as if the Base Screen is switched. <ul style="list-style-type: none"> • HMI Temporary Relay LBM0 to 127 • HMI Special Internal Relay LSM1, 2, 3, 11 • HMI Temporary Register LBR0 to 127 |
| Open User Account Setting Screen: | Opens the User Account Setting Screen. For details, refer to Chapter 23 "5 Editing User Accounts on the MICRO/I" on page 23-50.
When User Account Setting Screen is selected, the Configure Processing Area of User Account Setting Screen dialog box will be displayed. For details, refer to "Configure Processing Area of User Account Setting Screen Dialog Box" on page 8-44.
Specify the word device to use as the processing area of the User Account Setting Screen and click OK . When you return to the properties dialog box, Edit will be displayed.
Edit : Click this button to display the Configure Processing Area of User Account Setting Screen dialog box. |

*2 This is applicable for models with a video interface only.

■ Goto Screen

Screen Number: If **Action Mode** is set to **Switch to Base Screen**, specify the Base Screen number to switch to (from 1 to 3000). If **Action Mode** is set to **Open Popup Screen** or **Close Popup Screen**, specify the number of the Popup Screen to open or close (from 1 to 3015).

This setting is enabled only if **Action Mode** is set to **Switch to Base Screen**, **Open Popup Screen**, or **Close Popup Screen**.

Use Reference Device Address^{*1}: Select this check box and specify a device address to specify the screen number using the value of the specified device address.

Click  to display the Tag Editor. For the device address configuration procedure, refer to Chapter 2 "5.1 Device Address Settings" on page 2-70.

This setting is enabled only if **Action Mode** is set to **Open Popup Screen** or **Close Popup Screen**.

Coordinates X, Y: Specify the coordinates on the Base Screen for displaying a window.

X and Y specify the upper left corner of the window using the upper left corner of the screen as the origin.

This setting is enabled only if **Action Mode** is set to **Open Popup Screen**, **Open Device Monitor Screen**, **Open Password Screen**, **Open Adjust Brightness Screen**, or **Open File Screen for Movie Files**^{*2}.

Use Reference Device Address^{*1}: Select this check box and specify a device address to specify the coordinates using the value of the specified device address.

Click  to display the Tag Editor. For the device address configuration procedure, refer to Chapter 2 "5.1 Device Address Settings" on page 2-70.

This setting is enabled only if **Action Mode** is set to **Open Popup Screen**.

*1 Advanced mode only

*2 This is applicable for models with a video interface only.

Properties of Print for Multi-Functions Dialog Box

Sets the Print command for the Multi-Button.

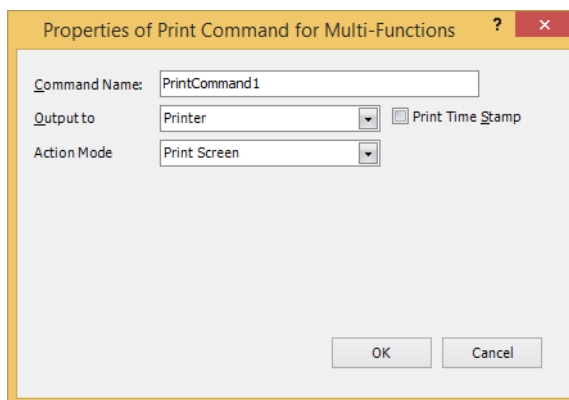

■ Command Name

Enter a name for the command. The maximum number is 20 characters.

■ Output to

Select where to direct the screenshot to.

Printer*¹:

Outputs the screenshot to the printer connected to the MICRO/I.

Print Time Stamp:

Adds the date and time of printing to the screenshot before sending it to the printer.

The date and time format depends on the language selected in **Language**. **Language** is available on the **Project Details** tab of the **Project Settings** dialog box.

The display formats are shown below:

- Japanese: YYYY/MM/DD hh:mm
- English: MM/DD/YYYY hh:mm

YYYY: year, MM: month, DD: day, hh: hour, mm: minute

External Memory Device*²: Outputs the screenshot as a file to the external memory device inserted in the MICRO/I.

Files are output as follows:

File format	File name	File size
JPEG	CAP***.JPG (***: date and time when file was output) Example: A file created at 18:50:25 on June 30, 2011 will be named "CAP110630_185025.JPG".	Depends on image being displayed.



- For details about printers, refer to Chapter 32 "Printer" on page 32-1.
- For details about external memory devices, refer to Chapter 31 "External Memory Devices" on page 31-1.

■ Action Mode

Select the behavior of the button from the following. This option is displayed only when **Printer** is selected in **Output to**.

Print Screen:

Outputs a screenshot of the current screen to the printer or the external memory device.

Cancel Printing*¹:

Cancels printout to the printer.

*1 HG5G/4G/3G/2G-V, HG4G/3G, HG2G-5F only

*2 USB flash drive inserted in USB1 for HG2J-7U, SD memory card for HG5G/4G/3G/2G-V, HG4G/3G and HG2G-5F, USB flash drive for HG2G-5T and HG1G/1P



- These operations cannot be performed simultaneously.
 - Outputting to the external memory device by pressing the Multi-Button.
 - Outputting to the printer by pressing the Multi-Button ^{*1}.
 - Printing alarm logs
- While the screenshot is being output to the external memory device, the Print Button or Print Command cannot output to one. Also, during these situations, the value of HMI Special Relay LSM24 or LSM25 changes to 1. For details, refer to Chapter 33 "HMI Special Relay (LSM)" on page 33-2.
- It may take some time to output screenshots when copying files using the USB Autorun function or a Key Button.
- MICRO/I cannot stop printing in the middle of a page, even when the print job is canceled. Print jobs after the current print job are canceled after the current page finishes printing.



The maximum number of screenshots that can be captured (1 to 999) can be set in HMI Special Data Registers LSD65. (Default: 99)



The methods to erase screenshot files saved on the external memory device are as follows.

- To erase files during operation using parts, on the **External Memory Device** tab on the Project Settings dialog box, select the **Remove Files** check box and the **All Screenshot data** check box, and then configure the trigger device address. Assign that trigger device address to a part.
- To erase files with WindO/I-NV4, click **Clear** on the **Online** tab, and then click **Stored Data in External Memory Device** to open the Clear Data dialog box. Select the **Screenshot Data** check box and click **OK**.
- To erase files on the HG5G/4G/3G/2G-V, HG4G/3G and the HG2G-5F, go to the System Mode - File Manager. In the File Manager, select the files to be deleted by pressing **DEL**.

*1 HG5G/4G/3G/2G-V, HG4G/3G, HG2G-5F only

Properties of Key for Multi-Functions Dialog Box

Sets the Key command for the Multi-Button.

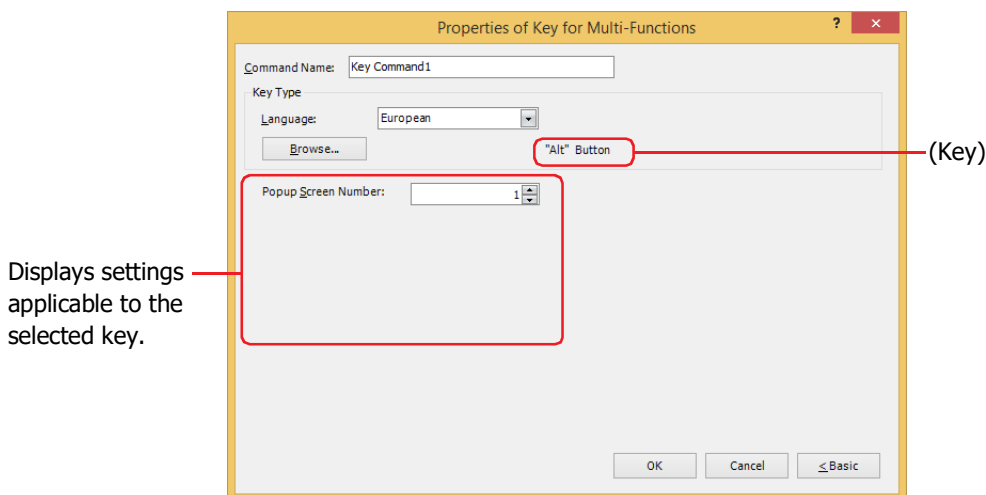

■ **Command Name**

Enter a name for the command. The maximum number is 20 characters.

■ **Key Type**

Select the function for the Key Button.

Language: Switches the display of the key that is displayed when **Keypad** is selected in Key Browser. These languages are available:

Western, Japanese, Central European, Baltic, Cyrillic.

Browse: Opens the Key Browser when clicked. Select a key. For details, refer to "5.5 Key Browser" on page 8-99.

(Key): Displays the name of the key selected using the Key Browser.



- When you select a key for Multi-Button or Multi-Command, the label for that key is not assigned as the Registration Text.
- The function of Key button will affect on the next scan when the trigger condition is satisfied.

The settings explained below appear depending on the type of key selected.

■ **Popup Screen Number**

The **Alt** key switches the current Popup Screen used as a Keypad when this button is pressed. Specify the Popup Screen number to open a Keypad for. This setting is enabled only if **Alt** was selected using the Key Browser.

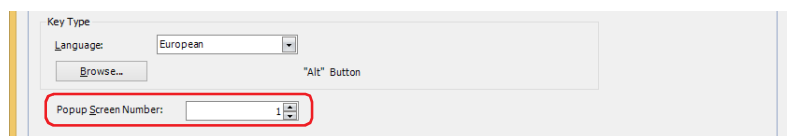

■ Scroll Size

Key Buttons **Page Up** and **Page Down** scroll the list up and down, respectively. Key Buttons **Up** and **Down** move the focus up and down, respectively. This settings specifies the number of pages or lines (1 to 1023 lines) to scroll or move the focus per each press of the button.

This setting is enabled only if **Page Up**, **Page Down**, **Up**, and **Down** are selected using the Key Browser.

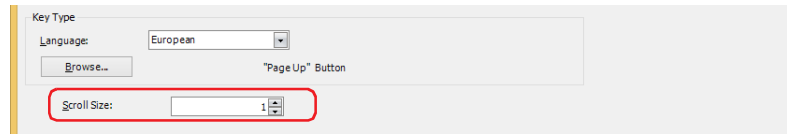

■ Transfer Setting

Key Buttons **Download Project**, **Upload Project**, **Copy Files**, **Download PLC Program**, and **Upload PLC Program**, perform the data transfer function specified by their names. These settings specify the source, data to be transferred, and destination.

This setting is enabled only if one of these keys is selected after clicking **Data Transfer** in the Key Browser.

Download Project is selected.

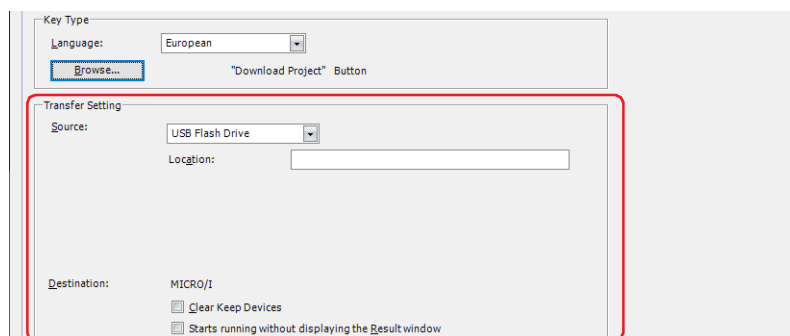

Source: Select the external memory where the project (ZNV Project File) to be transferred is stored:

SD Memory Card*1, USB Flash Drive*2, USB1*3 or USB2*3.

Location: Specify the location of the ZNV Project File (.znv). The maximum number is 247 characters. Only alphanumeric characters and symbols can be used. Path delimiters and characters that cannot be used vary based on the model.

Model	Delimiter	Characters that cannot be used
HG2J-7U	/	" # \$ & ' () * : ; < > ? \ ` ~
HG5G/4G/3G/2G-V, HG4G/3G, HG2G-5F/-5T, HG1G/1P	\	" * : ; < > ?

Example: To set "HG3G_DEMO_1.ZNV", a ZNV Project File, to be saved on the root directory of an external memory device:
HG3G_DEMO_1.ZNV

Destination: Displays a download destination of the project.

Clear Keep Devices:

Select this check box to clear keep devices after the project data is downloaded. However, when project data that changes the system software or settings of the data storage area is downloaded, the keep devices are always cleared.



When project data is downloaded, the alarm log data, data log data, and operation log data is deleted regardless of the state of the **Clear Keep Devices** check box.

Starts running without displaying the Result window:

Select this check box to start running MICRO/I without displaying the execution result screen after the project data is downloaded.

*1 HG5G/4G/3G/2G-V, HG4G/3G, HG2G-5F only

*2 HG5G/4G/3G/2G-V, HG4G/3G, HG2G-5F/-5T, HG1G/1P only

*3 HG2J-7U only

Upload Project is selected.

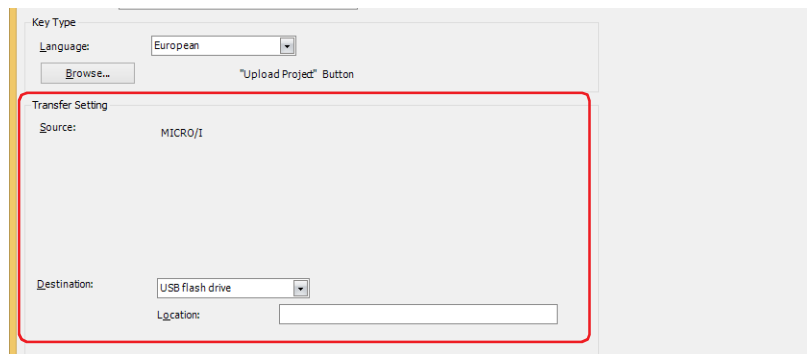

Destination: Specify where to save the project uploaded from MICRO/I. Select the location:

SD Memory Card^{*1}, USB Flash Drive^{*2}, USB1^{*3} or USB2^{*3}.

Location: Specify the location where the uploaded project will be saved. The maximum number is 247 characters. Only alphanumeric characters and symbols can be used. Path delimiters and characters that cannot be used vary based on the model.

Model	Delimiter	Characters that cannot be used
HG2J-7U	/	" # \$ & ' () * : ; < > ? \ ` ~
HG5G/4G/3G/2G-V, HG4G/3G, HG2G-5F/-5T, HG1G/1P	\	" * : ; < > ?

Example: To save project to the folder "Uploaded_Project" in an external memory device:
Uploaded_Project



A uploaded project using the Data Transfer function is saved as a ZNV Project File(.zmv).

*1 HG5G/4G/3G/2G-V, HG4G/3G, HG2G-5F only

*2 HG5G/4G/3G/2G-V, HG4G/3G, HG2G-5F/-5T, HG1G/1P only

*3 HG2J-7U only

Copy Files^{*4} is selected.

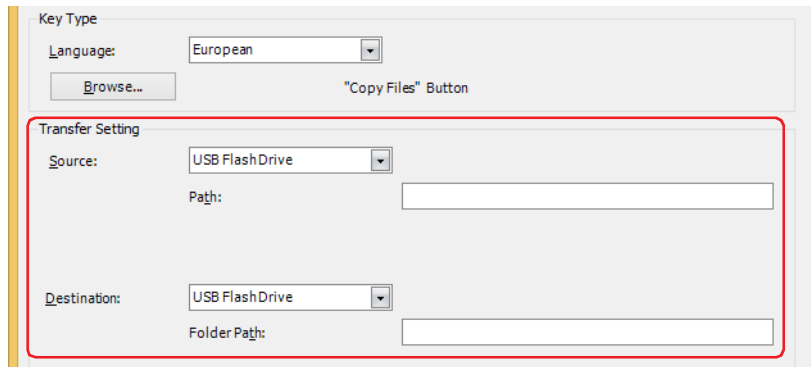

Source: Select the source external memory: **SD Memory Card**^{*1}, **USB Flash Drive**^{*1}, **USB1**^{*3} or **USB2**^{*3}.

Location: Specify the location of the file to be transferred. The maximum number is 247 characters. Only alphanumeric characters and symbols can be used. Path delimiters and characters that cannot be used vary based on the model.

Model	Delimiter	Characters that cannot be used
HG2J-7U	/	" # \$ & ' () * : ; < > ? \ ` ~
HG5G/4G/3G/2G-V, HG4G/3G, HG2G-5F	\	" * : ; < > ?

Example: Copy a file "Error.wav" to the root directory of an external memory device:
Error.wav

Destination: Select the destination external memory: **SD Memory Card**^{*1}, **USB Flash Drive**^{*1}, **USB1**^{*3} or **USB2**^{*3}.

Location: Specify the location where the file will be transferred. The maximum number is 247 characters. Only alphanumeric characters and symbols can be used. Path delimiters and characters that cannot be used vary based on the model.

Model	Delimiter	Characters that cannot be used
HG2J-7U	/	" # \$ & ' () * : ; < > ? \ ` ~
HG5G/4G/3G/2G-V, HG4G/3G, HG2G-5F	\	" * : ; < > ?

Example: Save file to the "SOUND" folder under "HGDATA01" folder in an external memory device:
HG2J-7U: HGDATA01/SOUND
HG5G/4G/3G/2G-V, HG4G/3G, HG2G-5F: HGDATA01\SOUND



- If a file name is specified as the source location, the specified file is copied. If a folder name is specified, all of the files and subfolders contained in the folder, and all of the files in the subfolders, are copied.
- The subfolders can be copied up to five levels.
- To prevent copying the subfolders and the files contained in the subfolders, HMI Special Internal Relay LSM30 must be set to 1 before executing the copy.
- To stop copying files during the copy operation, write 1 to HMI Special Internal Relay LSM31. However, it will continue to copy the file until it is finished then it will stop copying.

*1 HG5G/4G/3G/2G-V, HG4G/3G, HG2G-5F only

*3 HG2J-7U only

*4 HG2J-7U, HG5G/4G/3G/2G-V, HG4G/3G, HG2G-5F only

Download PLC Program is selected.

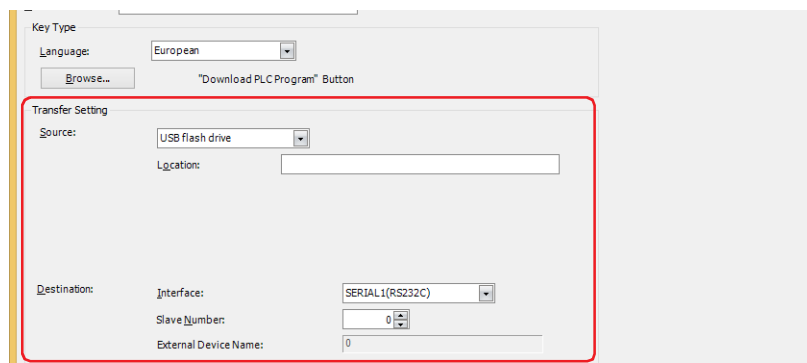

Source: Select the external memory where the PLC program (ZLD Project File) to be transferred is stored:
SD Memory Card*¹, USB Flash Drive*², USB1*³ or USB2*³.

Location: Specify the location of the ZLD Project File(.zld). The maximum number is 247 characters. Only alphanumeric characters and symbols can be used. Path delimiters and characters that cannot be used vary based on the model.

Model	Delimiter	Characters that cannot be used
HG2J-7U	/	" # \$ & ' () * : ; < > ? \ ` ~
HG5G/4G/3G/2G-V, HG4G/3G, HG2G-5F/-5T, HG1G/1P	\	" * : ; < > ?

Example: To set "LDR_PROGRAM.ZLD", a ZLD Project File, to be saved in folder "LDRDATA" of an external memory device:

HG2J-7U: LDRDATA/LDR_PROGRAM.ZLD

HG5G/4G/3G/2G-V, HG4G/3G, HG2G-5F/-5T, HG1G/1P: LDRDATA\LDR_PROGRAM.ZLD

Destination: Specify the destination PLC connected to the MICRO/I. The PLC type is configured in the **Project Settings** dialog box, on the **Communication Driver Network** tab. For details, refer to Chapter 4 "3.4 Communication Driver Network Tab" on page 4-52.

Interface: Select the communication interface in which the MICRO/I is connecting to the download destination PLC from serial interface or Ethernet. For details, refer to Chapter 4 "Interface Configuration" on page 4-35.

If serial interface is selected for **Interface**.

Slave Number: Specify the slave number of the download destination PLC (0 to 31).

External Device Name: The name of the specified PLC is displayed here.

If **Ethernet** is selected for **Interface**.

Select from the following method:

Specify External Device ID: Specify the External Device ID (0 to 31) of the destination PLC. This is the External Device ID number set in the **Project Settings** dialog box, on the **Communication Driver Network** tab.

External Device Name: The name of the specified PLC is displayed here.

Specify IP Address: Specify the IP address and port number of the destination PLC.

*1 HG5G/4G/3G/2G-V, HG4G/3G, HG2G-5F only

*2 HG5G/4G/3G/2G-V, HG4G/3G, HG2G-5F/-5T, HG1G/1P only

*3 HG2J-7U only

Upload PLC Program is selected.

The screenshot shows a software dialog box titled 'Upload PLC Program'. At the top, there is a 'Key Type' section with a 'Language' dropdown set to 'European' and a 'Browse...' button. Below this is the 'Transfer Setting' section, which is highlighted with a red border. It contains the following fields: 'Source' (Interface: SERIAL1(RS232C), Slave Number: 0, External Device Name: PLC0) and 'Destination' (USB flash drive, Location:).

Source: Specify the source PLC connected to the MICRO/I. The PLC type is configured in the **Project Settings** dialog box, on the **Communication Driver Network** tab. For details, refer to Chapter 4 "3.4 Communication Driver Network Tab" on page 4-52.

Interface: Select the communication interface in which the MICRO/I is connecting to the upload source PLC from serial interface or Ethernet. For details, refer to Chapter 4 "Interface Configuration" on page 4-35.

If serial interface is selected for **Interface**.

Slave Number: Specify the slave number of the upload source PLC (0 to 31).

External Device Name: The name of the specified PLC is displayed here.

If **Ethernet** is selected for **Interface**.

Select from the following method:

Specify External Device ID: Specify the External Device ID (0 to 31) of the upload source PLC. This is the External Device ID number set in the **Project Settings** dialog box, on the **Communication Driver Network** tab.

External Device Name: The name of the specified PLC is displayed here.

Specify IP Address: Specify the IP address and port number of the upload source PLC.

Destination: Specify where to save the PLC program uploaded from the PLC connected to the MICRO/I. Select the type of external memory: **SD Memory Card**^{*1}, **USB Flash Drive**^{*2}, **USB1**^{*3} or **USB2**^{*3}.

Location: Specify the location of the folder where the uploaded PLC program will be saved. The maximum number is 247 characters. Only alphanumeric characters and symbols can be used. Path delimiters and characters that cannot be used vary based on the model.

Model	Delimiter	Characters that cannot be used
HG2J-7U	/	" # \$ & ' () * : ; < > ? \ ` ~
HG5G/4G/3G/2G-V, HG4G/3G, HG2G-5F/-5T, HG1G/1P	\	" * : ; < > ?

Example: To save program to the folder "Uploaded_Program" in an external memory device:
Uploaded_Program



A uploaded PLC program using the Data Transfer function is saved as a ZLD Project File(.zld).

*1 HG5G/4G/3G/2G-V, HG4G/3G, HG2G-5F only

*2 HG5G/4G/3G/2G-V, HG4G/3G, HG2G-5F/-5T, HG1G/1P only

*3 HG2J-7U only

■ Recording Channel*5

The recording of images starts.

Selects **Channel 1** or **Channel 2** to record a video only (no audio) out of the signals input from the device. This setting is enabled only if **Rec.** was selected using the Key Browser.

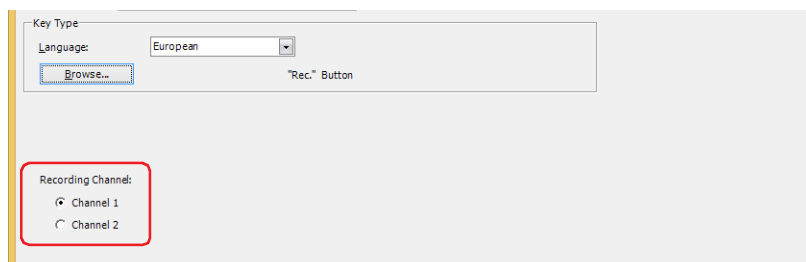

- Movie files cannot be recorded during playback.
- While data is being recorded after an event occurs with the event recording function and while data is being saved to the external memory device, recording cannot be executed with a Key Button, Multi-Button, or Multi-Command configured with the recording function. Also, during these situations, the value of HMI Special Data Register LSD155-0 changes to 1. For details, refer to Chapter 33 "HMI Special Data Register (LSD)" on page 33-8.

■ Recording Target*6

The recording of images and sound starts.

Select the target to record out of the signals input from the device. This setting is enabled only if **Rec.** was selected using the Key Browser.

Video and Audio: Records images and sound.

Video only (No Audio): Records images only.

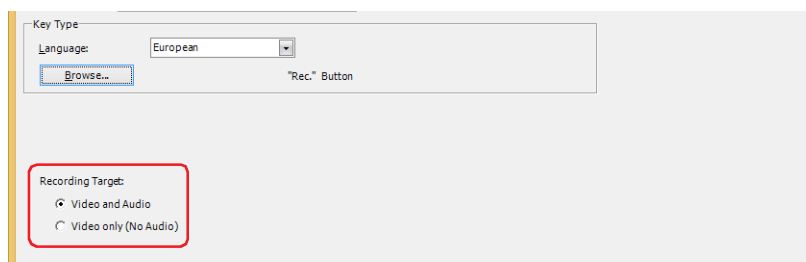

- Movie files cannot be recorded during playback.
- While data is being recorded after an event occurs with the event recording function and while data is being saved to the external memory device, recording cannot be executed with a Key Button, Multi-Button, or Multi-Command configured with the recording function. Also, during these situations, the value of HMI Special Data Register LSD155-0 changes to 1. For details, refer to Chapter 33 "HMI Special Data Register (LSD)" on page 33-8.

*5 HG5G/4G/3G-V only

*6 This is applicable for HG4G/3G with a video interface only.

Properties of Script for Multi-Functions Dialog Box

Sets the script for the Multi-Button.

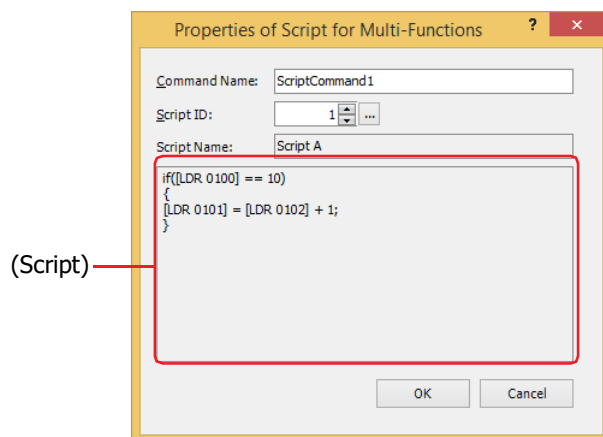

- **Command Name**

Enter a name for the command. The maximum number is 20 characters.

- **Script ID**

Specify the script ID (1 to 32000) of the script to operate.

Script Manager will open when is clicked. Select a script from the script list.

For details, refer to Chapter 20 "2.2 Script Manager" on page 20-7.

- **Script Name**

Displays the name of the script selected in Script Manager.

- **(Script)**

Displays the contents of the script selected in Script Manager.

Once this area is double clicked, the Script Editor will open and editing can be done.

For details, refer to Chapter 20 "2.3 Script Editor" on page 20-12.

● View Tab

Only **Coordinates** and **Size** can be configured when **No Image** is selected for **View Switching Method** on the **General** tab.

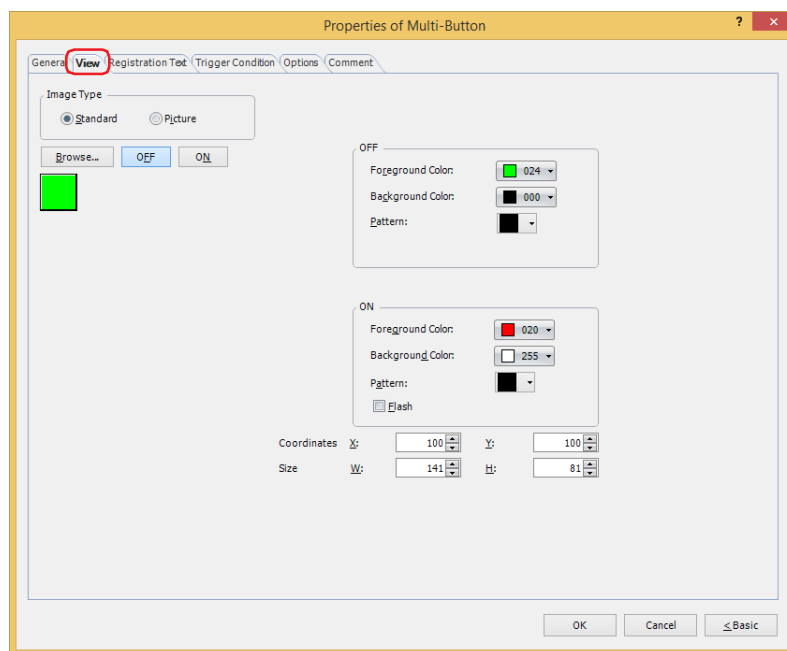

■ Image Type

Select the type of graphic to be used to represent the part.

Standard: Uses the default graphics contained within WindO/I-NV4.

Picture: Uses an image file saved in the Picture Manager.

For details about image file restrictions, refer to Chapter 2 "1.4 Available Image Files" on page 2-20.

■ Browse

Select the type of graphic to be used to represent the part from the list of graphics. Click this button to display the View Browser or Picture Manager, depending on the setting for **Image Type**.

■ OFF button, ON button

Displays the graphic when ON or OFF. Clicking **ON** or **OFF** switches the image displayed on the **View** tab.

■ OFF, ON

Selects the color and pattern of the standard graphic when ON and OFF.

Foreground Color, Background Color: Selects the foreground and background colors of the standard graphic (color: 256 colors, monochrome: 16 shades).

Click **Color** to display the Color Palette. Select a color from the Color Palette.

Pattern: Selects a pattern or tonal gradation for the standard graphic.

Click **Pattern** to display the Pattern Palette. Select a pattern or tonal gradation from the Pattern Palette.

■ Flash

Select this check box if flashing is desired (alternating ON and OFF) when a part is ON.

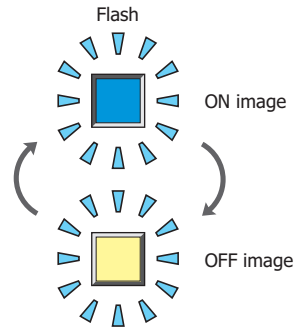

■ Coordinates

X, Y: Sets the display position of parts using coordinates.

The X and Y coordinates of parts are defined relative to an origin at the top-left corner of the screen.

X: 0 to (base screen horizontal size - 1)

Y: 0 to (base screen vertical size - 1)

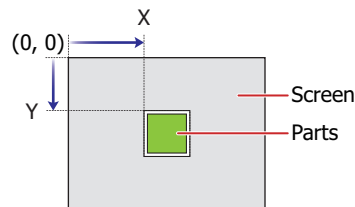

■ Size

W, H: Sets width and height to define the size of parts.

W: 20 to (base screen horizontal size)

H: 20 to (base screen vertical size)

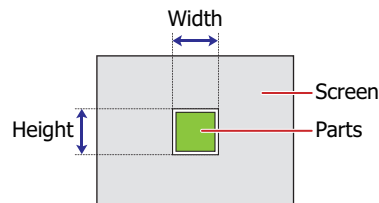

● Registration Text Tab

These options can only be configured when **Button** or **Device Address** is selected for **View Switching Method** on the **General** tab.

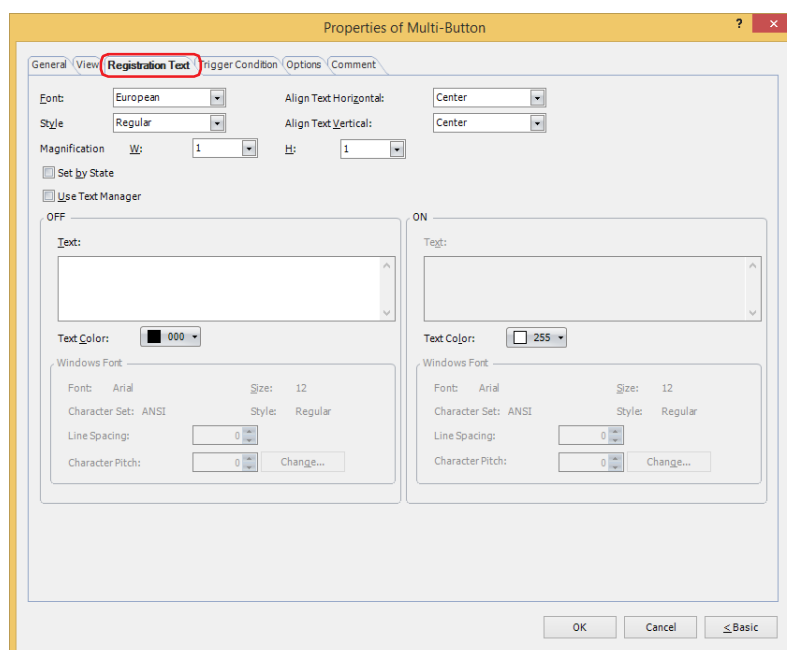

■ Font

Selects the font used for displaying text from the following.

Western, Japanese, Simplified Chinese, Traditional Chinese, Hangul, Central European, Baltic, Cyrillic, Windows, Stroke*1

Can only be set when the **Use Text Manager** check box is cleared.

The characters that can be displayed depend on the font. For details, refer to Chapter 2 "1.2 Available Text" on page 2-6.

■ Style*1

Selects **Regular** or **Bold** for text style.

Can only be set when **Font** is set to **Western, Japanese, Simplified Chinese, Traditional Chinese, Hangul, Central European, Baltic, Cyrillic**.

■ Size

Specifies the text size to be displayed. The fonts and sizes that can be set vary based on the model.

Model	Font	Size
HG2J-7U	Western, Japanese, Simplified Chinese, Traditional Chinese, Hangul, Central European, Baltic, Cyrillic	8 to 512
HG5G/4G/3G/2G-V, HG4G/3G, HG2G-5F/-5T, HG1G/1P	Stroke	8 to 128

■ Magnification*1

W, H: Selects the magnification (0.5, 1 to 8) for text display.

Can only be set when **Font** is set to **Western, Japanese, Simplified Chinese, Traditional Chinese, Hangul, Central European, Baltic, Cyrillic**.

■ Align Text Horizontal

Selects text alignment in the horizontal direction.

Left, Center, Right, Center-Left

For details, refer to Appendix "5 Text Alignment" on page A-7.

*1 HG5G/4G/3G/2G-V, HG4G/3G, HG2G-5F/-5T, HG1G/1P only

- **Align Text Vertical**

Selects text alignment in the vertical direction.

- **Top, Center, Bottom**

This option can only be configured when **Left**, **Center**, or **Right** is selected for **Align Text Horizontal**. If **Center-Left** is selected for **Align Text Horizontal**, **Center-Top** is set as this option.

For details, refer to Appendix "5 Text Alignment" on page A-7.

- **Set by State**

Select this check box if displaying different text when ON and OFF.

- **Use Text Manager**

Select this check box if using the text registered in Text Manager for text display.

- **OFF, ON**

- Text:** Inputs characters to be displayed on parts. The maximum number is 3,750 characters.
The characters that can be entered depend on the font selected using **Font**. For details, refer to Chapter 2 "1.2 Available Text" on page 2-6.
- Text ID:** Specifies the Text Manager ID No. (1 to 32000) when using the text registered in the Text Manager.
Click to display Text Manager.
Can only be set when the **Use Text Manager** check box is selected.
- Text Color:** Selects the color of the text displayed on the part (color: 256 colors, monochrome: 16 shades).
Click **Color** to display the Color Palette. Select a color from the Color Palette.
- Windows Font:** Sets the font to be used as the Windows Font.
Select **Windows** using **Font** to display the current setting. You can specify the character spacing (0 to 100) and the line spacing (0 to 100). To change the settings other than the character spacing and line spacing, click **Change** to display the **Font Settings** dialog box.
Can only be set when the **Use Text Manager** check box is cleared.
For details, refer to Chapter 2 "Windows Font" on page 2-13.

● **Trigger Condition Tab**

The **Trigger Condition** tab is displayed in Advanced mode.

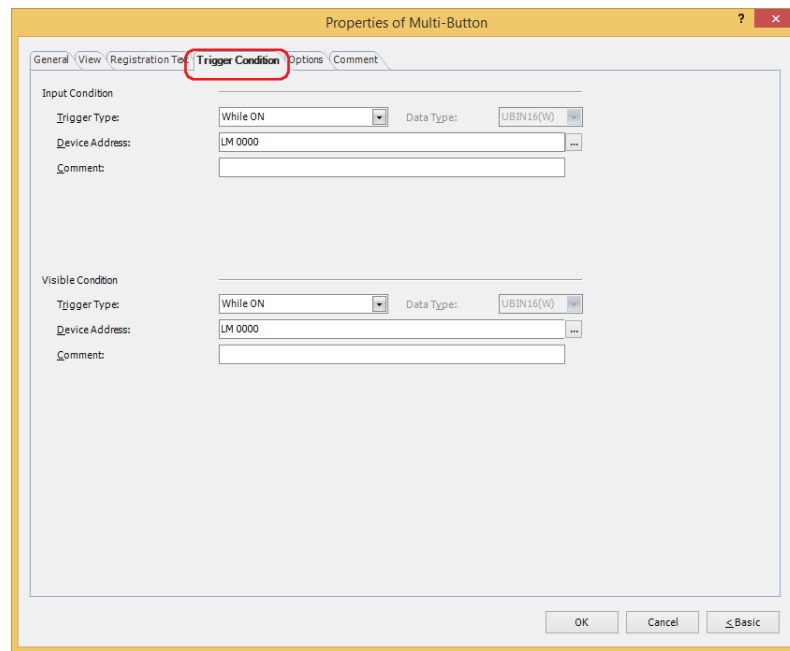

■ **Input Condition**

The Button is enabled and operational while the condition is satisfied. The Button is disabled and not operational while the condition is not satisfied.

Example: When **Trigger Type** is **While ON** and **Device Address** is **LM0**

While LM0 is 0, the condition is not satisfied and the Button is not operational.

While LM0 is 1, the condition is satisfied and the Button is operational.

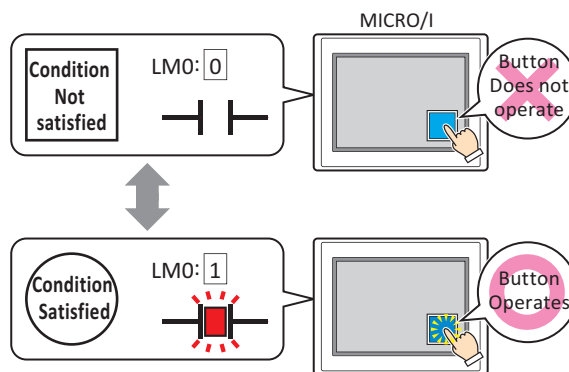

Trigger Type: Selects the condition to enable the Button from the following.

Always enable: The Button is always enabled.



While ON: Enables the Button when the value of device address is 1.

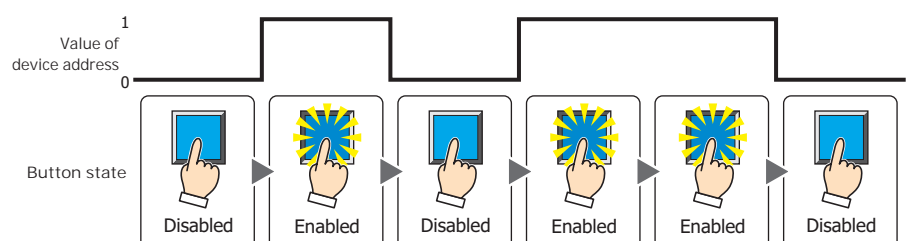

While OFF: Enables the Button when the value of device address is 0.

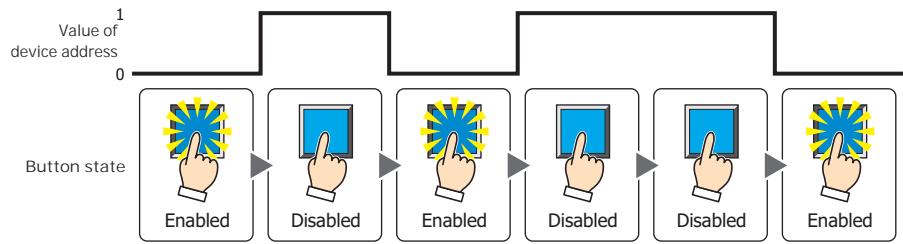

While satisfying the condition: Enables the Button when the condition is satisfied.

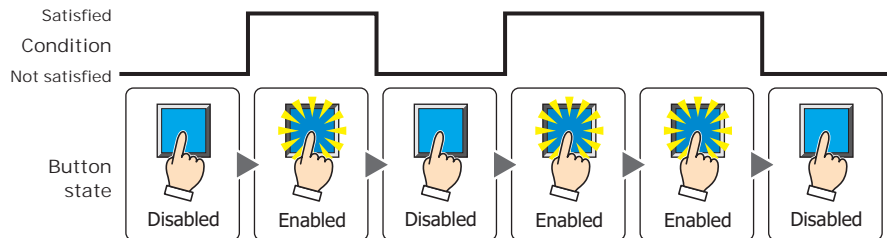

- Data Type:** Selects the type of data handled by the conditional expression for the input condition. This option can only be configured if **While satisfying the condition** is selected for **Trigger Type**. For details, refer to Chapter 2 "1.1 Available Data" on page 2-1.
- Device Address:** Specifies the bit device or the bit number of the word device to serve as the input condition. This option can only be configured when **While ON** or **While OFF** is selected for **Trigger Type**. Click to display the Tag Editor. For the device address configuration procedure, refer to Chapter 2 "5.1 Device Address Settings" on page 2-70.
- Condition:** Specifies the conditional expression for the input condition. This option can only be configured when **While satisfying the condition** is selected for **Trigger Type**. Click to display the **Trigger Condition Settings** dialog box. For the conditional expression configuration procedure, refer to Chapter 2 "5.2 Setting Conditional Expressions" on page 2-73.
- Comment:** Used for entering a comment for the input condition. The maximum number is 80 characters.

■ **Visible Condition**

The Button is displayed while the condition is satisfied. The Button is hidden while the condition is not satisfied.

Example: When **Trigger Type** is **While ON** and **Device Address** is **LM0**
 While LM0 is 0, the condition is not satisfied and the Button is hidden.
 While LM0 is 1, the condition is satisfied and the Button is displayed.

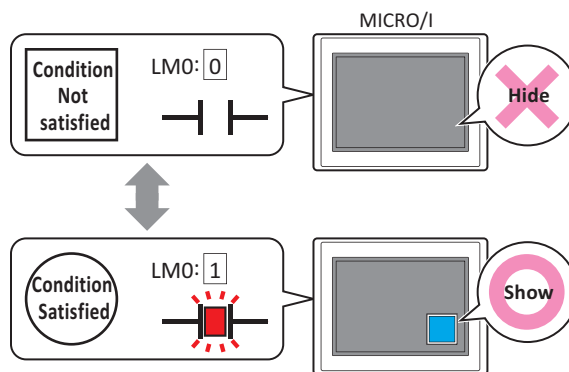

- When **Alternate** is selected for **Action Mode** on the **General** tab, the button remains on when hidden in the on state.
- When the **ON delay** check box is selected on the **Options** tab, if the button is hidden before the set time elapses from when the button begins to be pressed, the on delay is reset and the button does not operate.

Trigger Type: Selects the condition to display the Button from the following.

Always visible: The Button is always displayed.

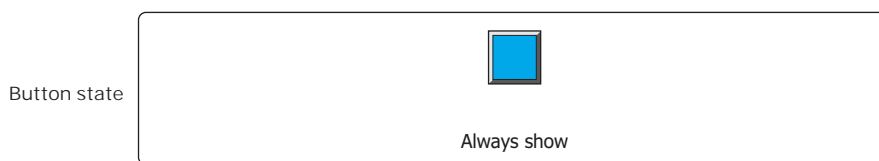

While ON: Displays the Button when the value of device address is 1.

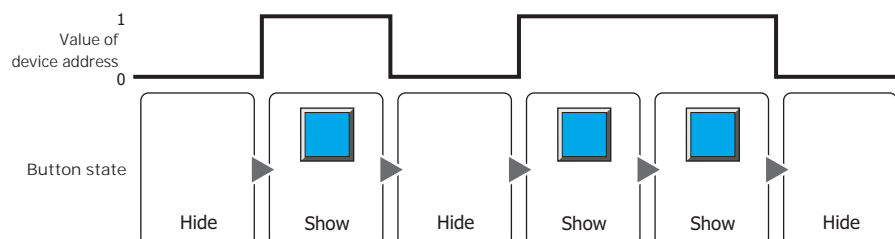

While OFF: Displays the Button when the value of device address is 0.

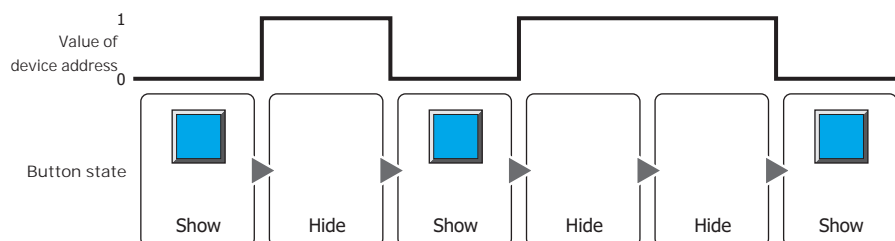

While satisfying the condition: Displays the Button when the condition is satisfied.

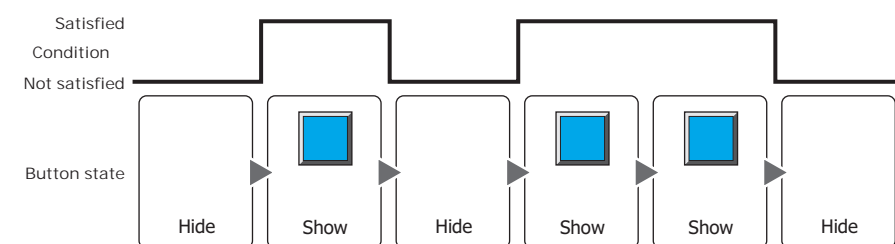

Data Type: Selects the type of data handled by the conditional expression for the visible condition. This option can only be configured if **While satisfying the condition** is selected for **Trigger Type**. For details, refer to Chapter 2 "1.1 Available Data" on page 2-1.

Device Address: Specifies the bit device or the bit number of the word device to serve as the visible condition. This option can only be configured when **While ON** or **While OFF** is selected for **Trigger Type**.

Click to display the Tag Editor. For the device address configuration procedure, refer to Chapter 2 "5.1 Device Address Settings" on page 2-70.

Condition: Specifies the conditional expression for the visible condition. This option can only be configured when **While satisfying the condition** is selected for **Trigger Type**.

Click to display the **Trigger Condition Settings** dialog box. For the conditional expression configuration procedure, refer to Chapter 2 "5.2 Setting Conditional Expressions" on page 2-73.

Comment: Used for entering a comment for the visible condition. The maximum number is 80 characters.

● Options Tab

The **Options** tab is displayed in Advanced mode.

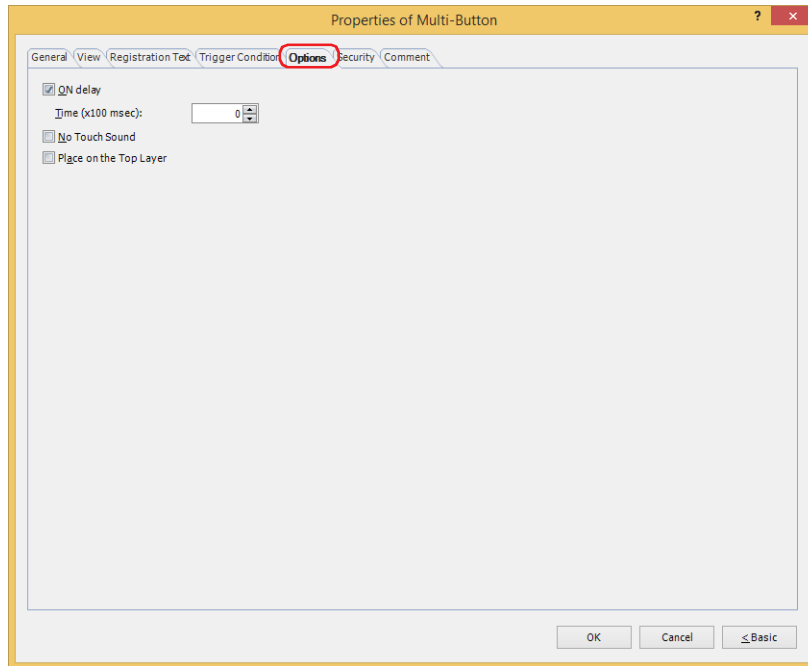

■ ON delay

Select this check box to use the ON delay function.

Time (x100 msec): Specify the length of time that the button must be held down before activation by selecting a value from 0 to 600 (units of 10 ms).
The button activates after it is held down for a specified period of time.

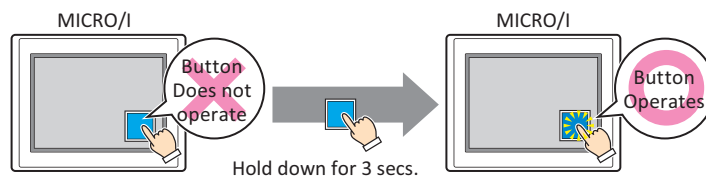

This feature protects against mistaken operation by ensuring that the button will not be activated if touched accidentally.

■ No Touch Sound

This function is to disable touch sounds only for specified parts when the MICRO/I makes touch sounds.

Select this check box to display disable touch sounds for this part.



To enable touch sounds on the MICRO/I, select the **Enable Touch Sound** check box under the **System** tab of the **Project Settings** dialog box.

■ Place on the Top Layer

Select this check box to display the parts on the top layer. The parts will have precedence when other drawings and parts are overlapping with it. For details, refer to Chapter 6 "4 Drawings and Parts Overlapping" on page 6-5.



Even if a Multi-Button is placed on the top layer, drawing objects that are drawn with scripts executed by the Multi-Button are not drawn on the top layer. They are drawn on the Base Screen. For details, refer to Chapter 6 "4 Drawings and Parts Overlapping" on page 6-5.

● Security Tab

This tab is used to restrict displaying and using the part by security groups.

This option can only be set when **Use Security functions** is selected. The **Use Security functions** check box is set on **General** tab in the **Security** dialog box.

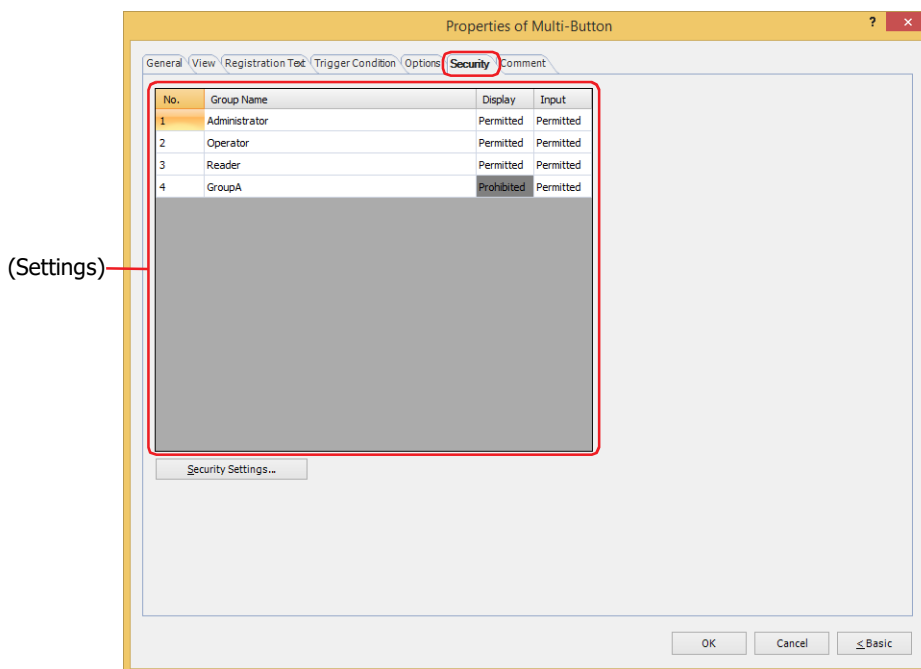

■ (Settings)

Displays the list of security groups used on the MICRO/I.

- No.:
- Displays the security group numbers (1 to 15).
- Group Name:
- Displays the name of the security group.
- Display:
- Displays whether or not there is permission to display the part. Only **Permitted** security groups can display this part. If all security groups are set to **Permitted**, this part will be displayed even if no user account has been selected. Double clicking the cell switches between **Permitted** and **Prohibited**.
- Input:
- Displays whether or not there is permission to use the part. Only **Permitted** security groups can use this part. If all security groups are set to **Permitted**, this part can be used even if no user account has been selected. Double clicking the cell switches between **Permitted** and **Prohibited**.



- You can also switch between **Permitted** and **Prohibited** by right-clicking on a **Display** or **Input** cell.
- Restricting the display and use of the part by switching between **Permitted** and **Prohibited** in **Display** and **Input** cells is similar to using the **Trigger Condition** tab.



■ Security Settings

The Security Settings dialog box is displayed. If you create a security group in the **Security Settings** dialog box, you can select that created group. For details, refer to Chapter 23 “2.2 Adding and Editing Security Groups” on page 23-19.



For details about security functions, refer to Chapter 23 “User Accounts and the Security Function” on page 23-1.

Example: If the user and security group for a part are set as follows:

User Name	 User1	 User2	 User3
Security Group	Reader	Operator	Administrator

MICRO/I

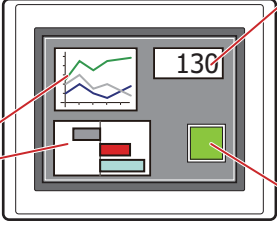

Line Chart and Bar Chart

No.	Group Name	Display
1	Administrator	Permitted
2	Operator	Permitted
3	Reader	Prohibited

Numerical Display

No.	Group Name	Display
1	Administrator	Permitted
2	Operator	Permitted
3	Reader	Permitted

Button

No.	Group Name	Display	Input
1	Administrator	Permitted	Permitted
2	Operator	Permitted	Prohibited
3	Reader	Prohibited	Prohibited

For User1 in the **Reader** security group, the parts for which **Display** has been set to **Prohibited** for **Reader** will not be displayed.

If the password screen is opened and the user switches to User2 in the **Operator** security group, the parts for which **Display** has been set to **Permitted** for **Operator** will be displayed.

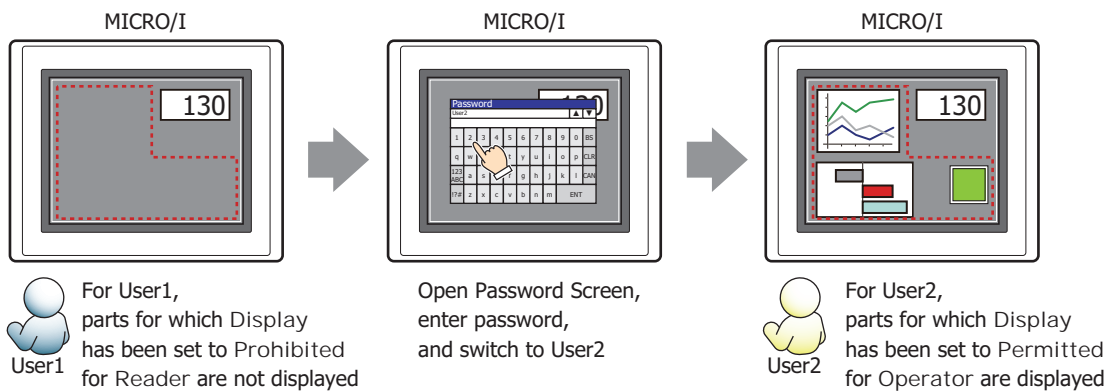

For User2 in **Operator**, **Display** has been set to **Permitted** for **Operator**, but **Input** is **Prohibited**, so the part cannot be used.

If the password screen is opened and the user switches to User3 in the **Administrator** security group, the parts for which **Display** has been set to **Permitted** for **Administrator** will be displayed, and the parts for which **Input** has been set to **Permitted** for **Administrator** can be used.

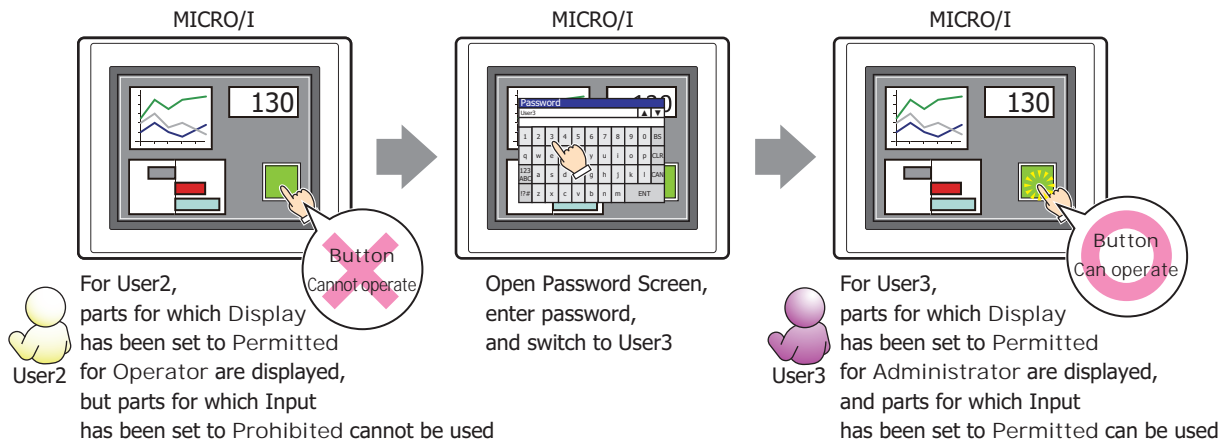

● Comment Tab

The **Comment** tab is used to specify the parts placed on the editing screen, and the popup text displayed when the mouse pointer is placed close to **No.**, **Name**, or **Type** in the object list.



When there are multiple parts of the same shape on the screen, this feature makes it possible to distinguish between the parts without displaying the Properties dialog box for each part, by just mousing over the part.

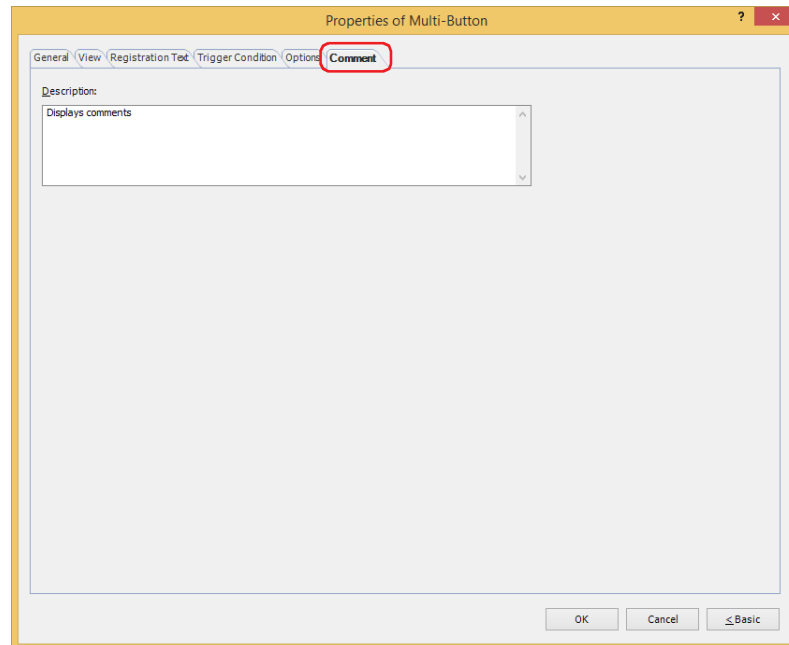

■ Description

Used for entering comments about parts. The maximum number is 80 characters.

Example: When mousing over the Button on the editing screen

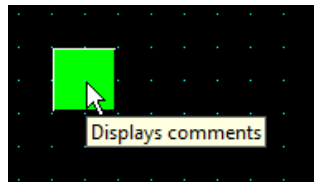

7 Keypad

HG2J-7U HG5G-V HG4G-V HG4G HG3G-V HG3G HG2G-V HG2G-5F HG2G-5T HG1G HG1P

7.1 How the Keypad is Used

A part comprised of Key Buttons. Enters numbers and characters into Numerical or Character Input parts.

- Entering numbers in the Numerical Input

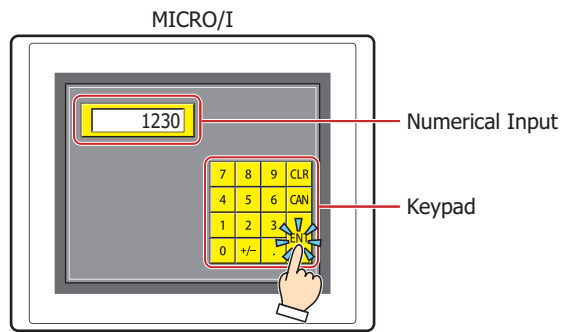

- Entering characters in the Character Input

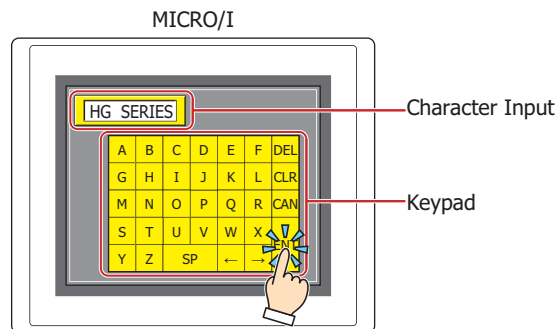

Do not use the Keypad part with the Goto Screen Button or a combination of Goto Screen Commands. For details, refer to "5 Key Button" on page 8-72.

7.2 Keypad Configuration Procedure

This section describes the configuration procedure for Keypads.

- 1 On the **Home** tab, in the **Parts** group, click **Buttons**, and then click **Keypad**.

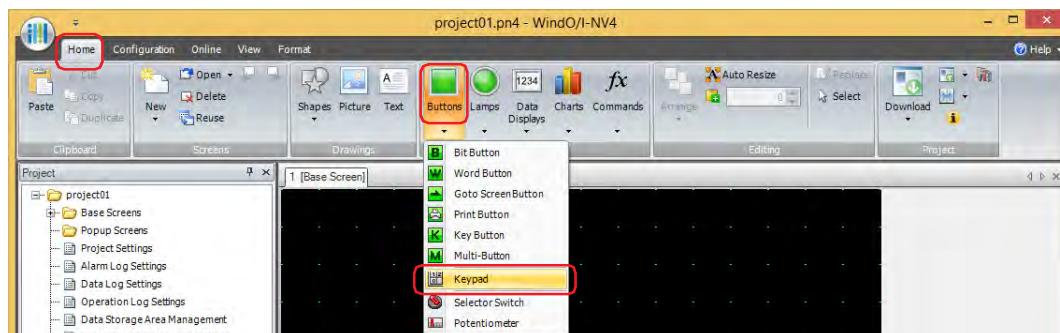

- 2 Click a point on the edit screen where you wish to place the Keypad.
- 3 Double-click the placed Keypad and a Properties dialog box will be displayed.
- 4 Change the settings on each tab as necessary.

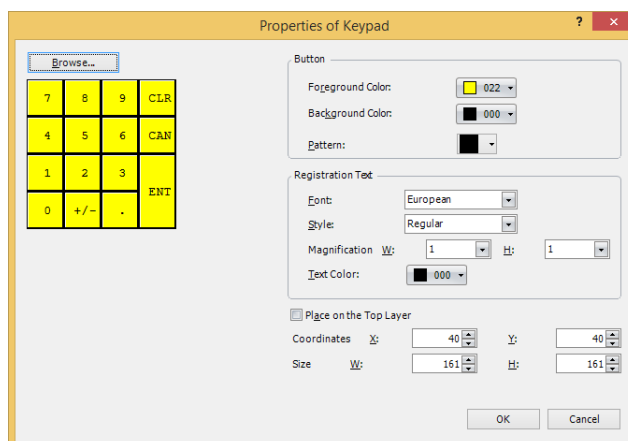

The Keypad Properties dialog box is displayed until **OK** is clicked.

☞ Refer to "7.3 Properties of Keypad Dialog Box" on page 8-144.



- After **OK** on the Keypad Properties dialog box is clicked, double clicking the Keypad thereafter calls up the Properties dialog box for the Key Buttons as a group. This allows editing of settings common to each button.
 - View: "View Tab" on page 8-83
 - Registration Text: "Registration Text Tab" on page 8-85
 - Options: "Options Tab" on page 8-90
- You can set the default for the Keypad on the **Default Preferences** tab of the **WindO/I-NV4 Options** dialog box. For details, refer to Chapter 2 "Default Preferences Tab" on page 2-63.

7.3 Properties of Keypad Dialog Box

This section describes items and buttons in the Properties dialog box.

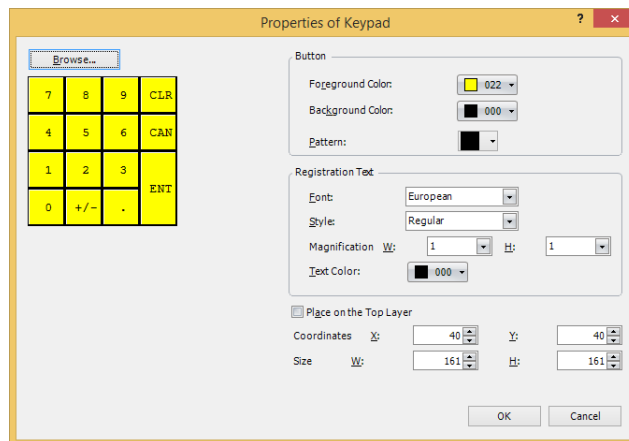

■ Browse

Select a prebuilt Keypad within WindO/I-NV4.

Displays the Standard Browser when clicked. Select numeric keys or character keys registered in the Standard Browser.

■ Button

Foreground Color, Background Color:

Select the foreground and background color to use for the Keypad (color: 256 colors, monochrome: 16 shades).

Displays the Color Palette when **Color** is clicked. Select a color from the Color Palette.

Pattern:

Select a pattern to use or tonal gradation for the Keypad.

Displays the Pattern Palette when **Pattern** is clicked. Select a pattern or tonal gradation from the Pattern Palette.

■ Registration Text

Font:

Select one of the following fonts to use for the text on the buttons.

Western, Japanese, Simplified Chinese, Traditional Chinese, Hangul, Central European, Baltic, Cyrillic, Stroke*1

The characters that can be displayed depend on the font. For details, refer to Chapter 2 "1.2 Available Text" on page 2-6.

Style*1:

Select a character style: **Regular** or **Bold**.

Size:

Specifies the text size to be displayed. The fonts and sizes that can be set vary based on the model.

Model	Font	Size
HG2J-7U	Western, Japanese, Simplified Chinese, Traditional Chinese, Hangul, Central European, Baltic, Cyrillic	8 to 512
HG5G/4G/3G/2G-V, HG4G/3G, HG2G-5F/-5T, HG1G/1P	Stroke	8 to 128

Magnification*1: W, H: Select the zoom factor (0.5, 1 to 8) to use on the text.

This setting is only enabled when **Font** is set to **Western, Japanese, Simplified Chinese, Traditional Chinese, Hangul, Central European, Baltic, Cyrillic**.

Text Color:

Select the text color (color: 256 colors, monochrome: 16 shades).

Displays the Color Palette when **Color** is clicked. Select a color from the Color Palette.

*1 HG5G/4G/3G/2G-V, HG4G/3G, HG2G-5F/-5T, HG1G/1P only

■ Place on the Top Layer

Select this check box to display the parts on the top layer. The parts will have precedence when other drawings and parts are overlapping with it. For details, refer to Chapter 6 "4 Drawings and Parts Overlapping" on page 6-5.

■ Coordinates

X, Y: Specify the display coordinates of the Keypad.

X and Y specify the upper left corner of the Keypad using the upper left corner of the screen as the origin.

X: 0 to (base screen horizontal size - 1)

Y: 0 to (base screen vertical size - 1)

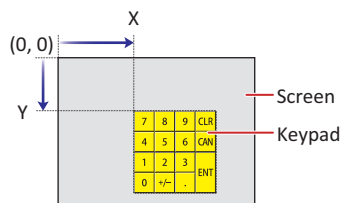

■ Size

W, H: Specify the size of the Keypad by specifying width and height.

W: 20 to (base screen horizontal size)

H: 20 to (base screen vertical size)

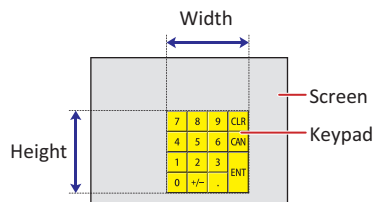

8 Selector Switch

HG2J-7U HG5G-V HG4G-V HG4G HG3G-V HG3G HG2G-V HG2G-5F HG2G-5T HG1G HG1P

8.1 How the Selector Switch is Used

Writes a 0 or 1 to a bit device. This is an exclusive control that only writes a single value as 1 and all other values as 0.

- Switching between two Run Modes (Manual and Auto)

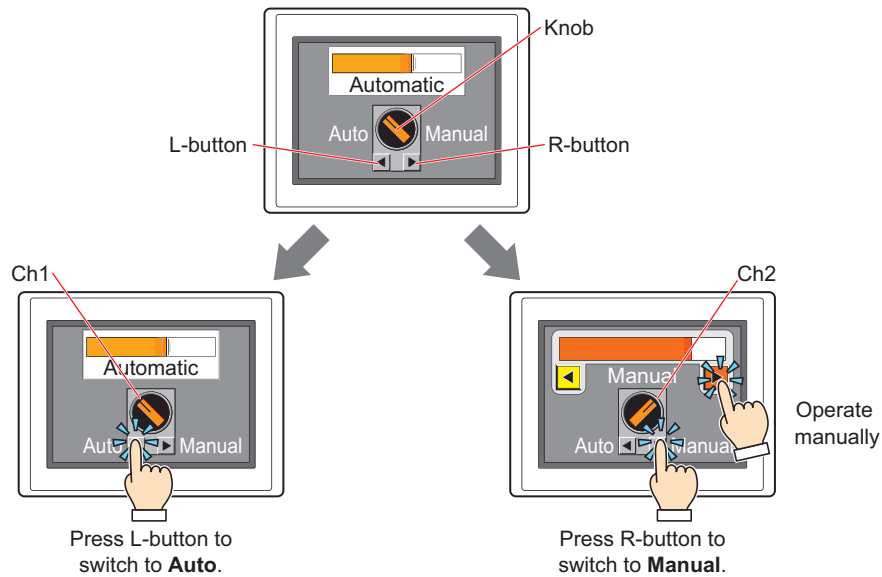

- Switching between three Run Modes (Filling - Stop - Discharge)

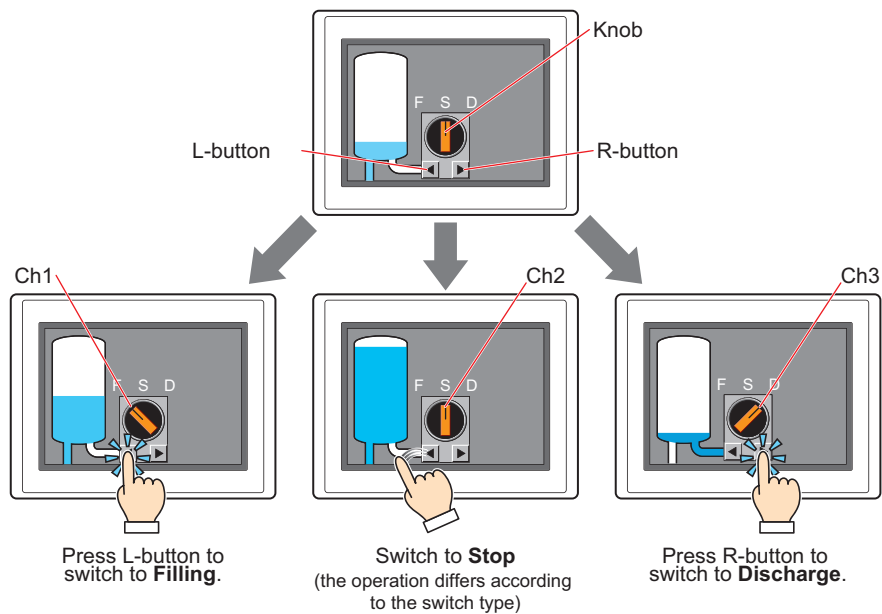

8.2 Selector Switch Configuration Procedure

This section describes the configuration procedure for Selector Switch buttons.

- 1 On the **Home** tab, in the **Parts** group, click **Buttons**, and then click **Selector Switch**.

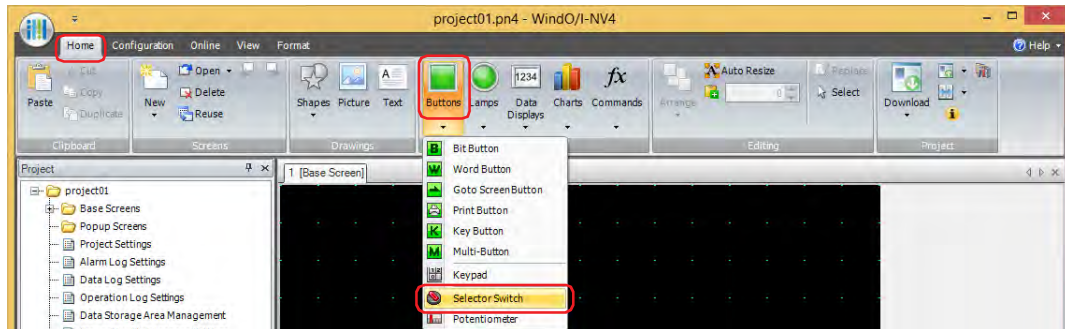

- 2 Click a point on the edit screen where you wish to place the Selector Switch.
- 3 Double-click the placed Selector Switch and a Properties dialog box will be displayed.
- 4 Change the settings on each tab as necessary.

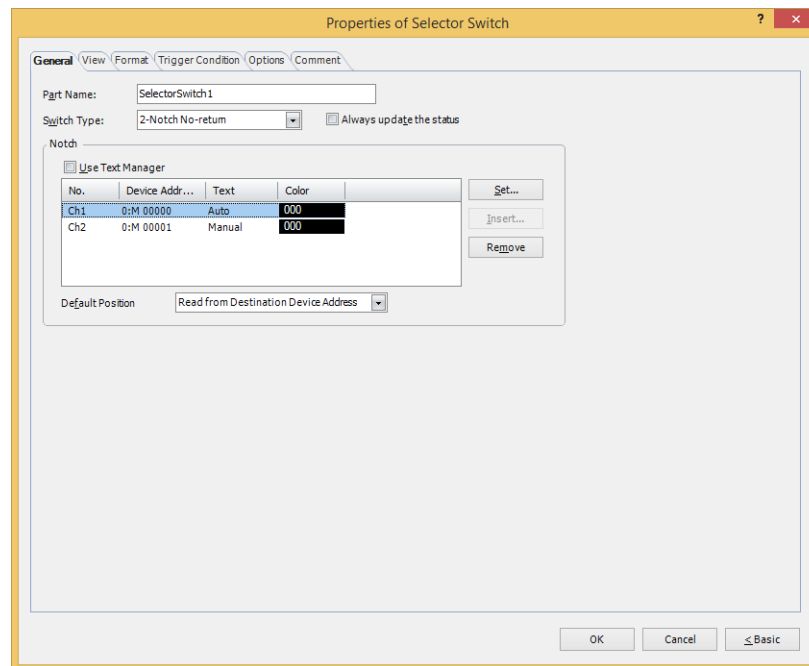

The **Trigger Condition** tab and **Options** tab only appear in **Advanced mode**.



You can set the default for the Selector Switch on the **Default Preferences** tab of the **WindO/I-NV4 Options** dialog box. For details, refer to Chapter 2 "Default Preferences Tab" on page 2-63.

8.3 Properties of Selector Switch Dialog Box

This section describes items and buttons in the Properties dialog box.

● General Tab

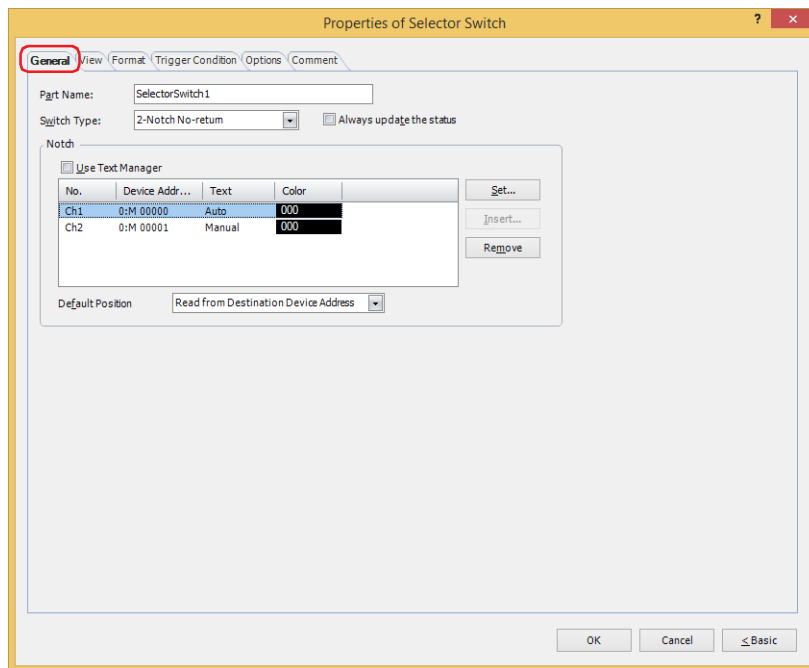

■ Part Name

Enter a name for the part. The maximum number is 20 characters.

■ Switch Type

The 2-Notch action is as follows.

- When the knob is at Ch1 (left), pressing the right button switches the selector knob to Ch2 (right). During this action, the device address for Ch1 is set to 0 and Ch2 is set to 1.
- When the knob is at Ch2 (right), pressing the left button switches the selector knob to Ch1 (left). During this action, the device address for Ch1 is set to 1 and Ch2 is set to 0.

The 3-Notch action is as follows.

- The knob behaves as follows for **3-Notch No-return**, **3-Notch R-return**, and **3-Notch L-return** button:
 - Press R-button: knob switches from Ch1 (left) -> Ch2 (middle) -> Ch3 (right), in that order.
 - Press L-button: knob switches from Ch3 (right) -> Ch2 (middle) -> Ch1 (left), in that order.
- Switching the knob writes 1 to the device address for the new knob position, and 0 to the device addresses for the other two channels.

Whether the knob returns and the direction it returns depends on the switch type.

Select the switch type from the following.

2-Notch No-return: The knob does not return when the operator's finger is released.

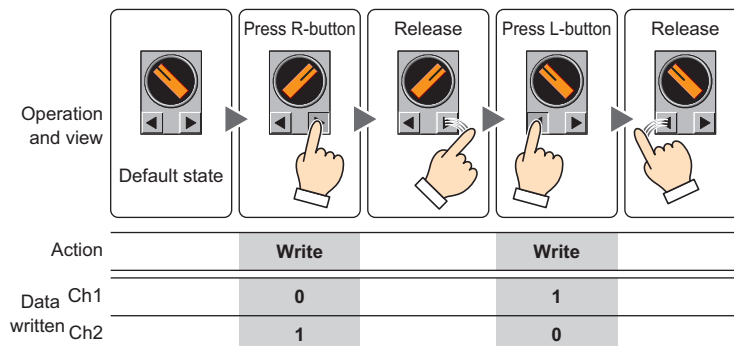

2-Notch R-return: After the knob switches from Ch1 to Ch2, it returns to Ch1 when the R-button is released.

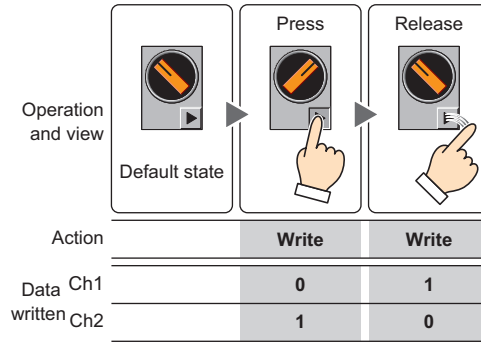

2-Notch L-return: After the knob switches from Ch2 to Ch1, it returns to Ch2 when the L-button is released.

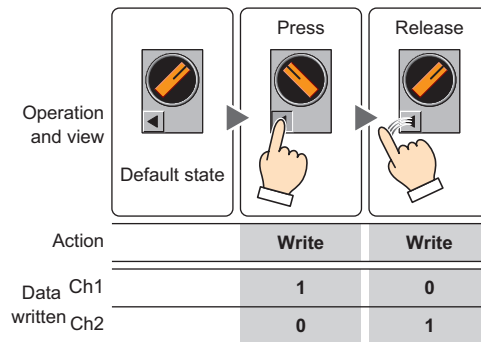

3-Notch No-return: The knob does not return when the operator's finger is released.

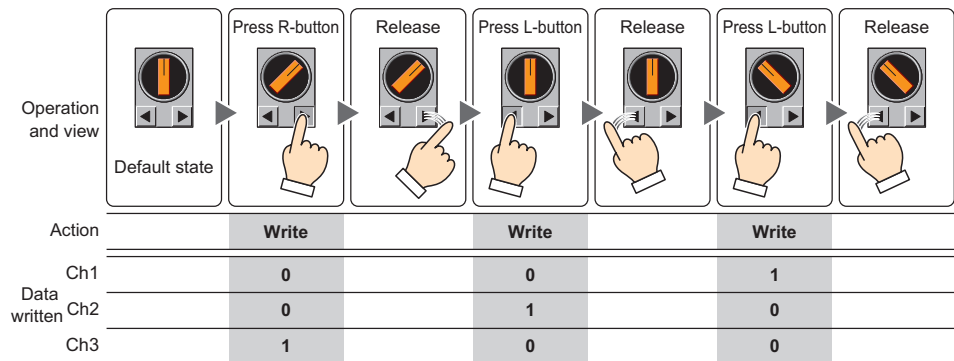

3-Notch R-return:

- If the knob is switched to Ch3, it returns to Ch2 when the button is released.
- If the knob is switched to Ch1, or from Ch1 to Ch2, it stays where it is even if the button is released.

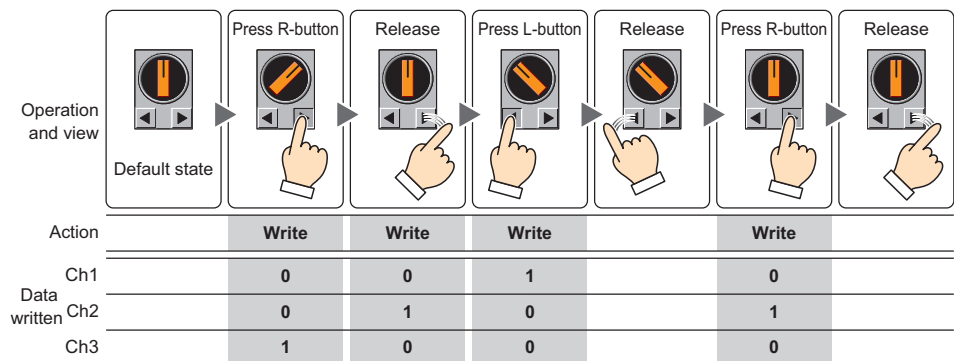

- 3-Notch L-return:
- If the knob is switched to Ch1, it returns to Ch2 when the button is released.
 - If the knob is switched to Ch2, or from Ch3 to Ch2, it stays where it is even if the button is released.

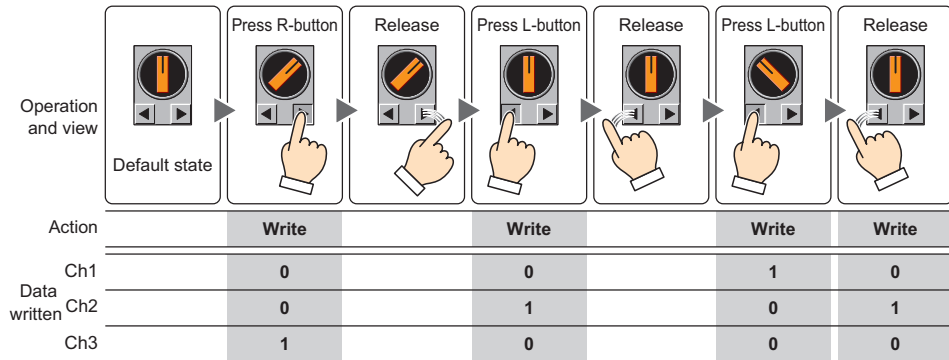

3-Notch Both-return: If the knob is switched to Ch1 or Ch3, it returns to Ch2 when the button is released.

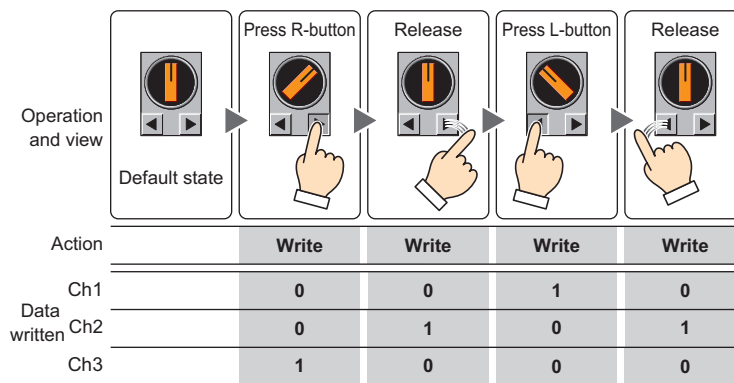

■ **Always update the status**

Select this check box to change the position of the knob with the values of device addresses.



The position of the knob will not be updated when the values of the device addresses set for the Selector Switch are the following states.

- When values of multiple device addresses are 1
- When values of all device addresses are 0
- When the value of the device address of the return channel is 1

■ **Notch**

Register and edit the settings for each notch to each channel.

Use Text Manager: Select this check box to use the text registered in the Text Manager as the Registration Text for each channel.

(List of Notch settings): This list shows the notch settings for each channel.

- No.:
- Shows the channel to be output. The number of notches selected in the **Switch Type** determines the number of channels. Double clicking the cell displays the **Notch Settings** dialog box where you can edit the notch settings. For details, refer to "Notch Settings Dialog Box" on page 8-152.
- Device Address:
- Shows the destination bit device or the bit number in the destination word device. Double clicking the cell displays the Tag Editor where you can edit the device address. For the device address configuration procedure, refer to Chapter 2 "5.1 Device Address Settings" on page 2-70.
- Text:
- Shows the Registration Text for the channel. Double clicking the cell allows you to edit the Registration Text. Can only be set when the **Use Text Manager** check box is cleared.

Text ID:	Shows the Text ID. Double clicking the cell displays the Text Manager where you can change the Text ID. Can only be set when the Use Text Manager check box is selected.
Color:	Shows the color of the Registration Text for the channel. Double clicking the cell displays Color Palette where you can change the Text Color
Set:	Registers or changes the notch settings. Selecting a number that has already been registered changes the existing notch settings. Clicking Set displays the Notch Settings dialog box where you can configure the notch. For details, refer to "Notch Settings Dialog Box" on page 8-152.
Insert:	Inserts a notch setting entry above the currently selected position. Select the channel number from the list where you wish to insert the notch setting and click Insert . This displays the Notch Settings dialog box where you can configure the notch. The notch settings at the point of insertion shift down one line. Notch settings cannot be inserted if all channel numbers have a notch setting.
Remove:	Deletes the registered notch setting from the list. Select the channel number in the list and click Remove .
Default Position:	Selects the default position of the knob when the MICRO/I starts operation and the Selector Switch is first displayed on the screen. Ch1: Makes Ch1 the default knob position. Writes 1 to the device address configured for Ch1, writes 0 to the device addresses configured for the other channels. Ch2: Makes Ch2 the default knob position. Writes 1 to the device address configured for Ch2, writes 0 to the device addresses configured for the other channels. Ch3: Makes Ch3 the default knob position. Writes 1 to the device address configured for Ch3, writes 0 to the device addresses configured for the other channels. Read from Destination Device Address: The position of the knob is determined by the value of device address.



The default knob position is fixed for these two switch types because of the return functionality.

2-Notch R-return: Ch1
2-Notch L-return, 3-Notch Both-return: Ch2



- If **Default Position** is **Ch1**, **Ch2**, or **Ch3**, the position of the knob does not change even if the value in the device address configured for the channel changes, unless the change is caused by the buttons on the Selector Switch. If **Default Position** is **Read from Destination Device Address**, the position of the knob changes according to the value of the device address configured for the channel.
- When a Selector Switch is redisplayed immediately after switching the screen or when a hidden Selector Switch is redisplayed, values are not written to the destination device addresses for the channels.
- If the value in the device address used to determine the default knob position contains an illegal value, the knob will be shown as follows:
 - 2-Notch No-return: Ch1
 - 3-Notch: Ch2

Notch Settings Dialog Box

This dialog configures a notch for a channel. If the channel has already been set with a notch, the setting is overwritten.

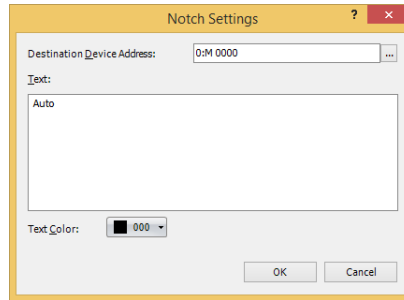

■ **Destination Device Address**

Specify the destination bit device or the bit number in the destination word device.

Click to display the Tag Editor. For the device address configuration procedure, refer to Chapter 2 "5.1 Device Address Settings" on page 2-70.

■ **Text**

Enter the Registration Text for the channel.

The characters that can be entered depends on the font selected for **Font** on the **Format** tab. For details, refer to Chapter 2 "1.2 Available Text" on page 2-6.

■ **Text ID**

To use the text registered in the Text Manager as the Registration Text for the channel, specify the ID number from 1 to 32000.

Click to display Text Manager.

The text ID setting is only enabled if you select the **Use Text Manager** check box.

■ **Text Color**

Select the Registration Text color for the channel (color: 256 colors, monochrome: 16 shades).

Displays the Color Palette when **Color** is clicked. Select a color from the Color Palette.

● View Tab

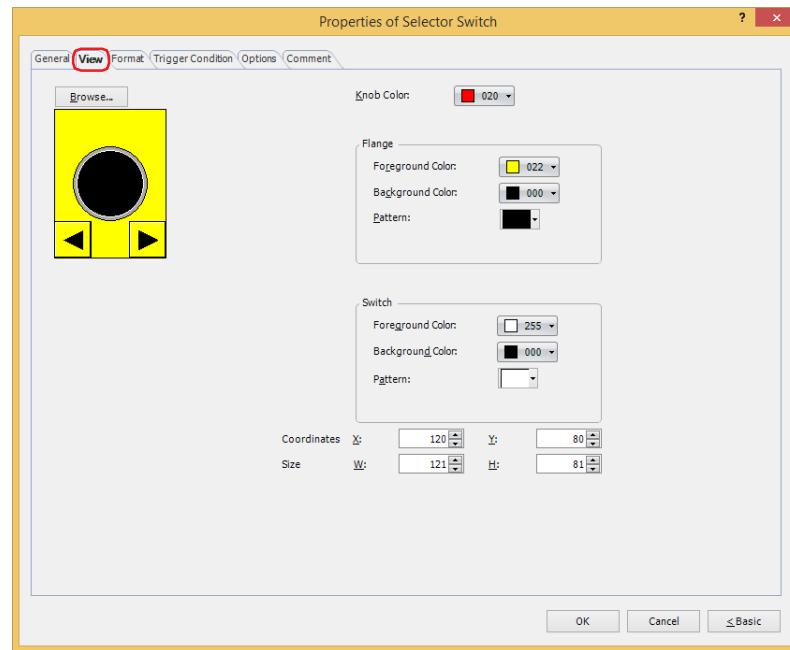

■ Browse

Select the type of graphic to be used to represent the part from the list of graphics. Click this button to display the View Browser.

■ Knob Color

Selects the knob color of the Selector Switch (color: 256 colors, monochrome: 16 shades). Click **Color** to display the Color Palette. Select a color from the Color Palette.



■ Flange

Foreground Color, Background Color: Selects the foreground and background colors of the flange (color: 256 colors, monochrome: 16 shades). Click **Color** to display the Color Palette. Select a color from the Color Palette.

Pattern: Selects a pattern for the flange. Click **Pattern** to display the Pattern Palette. Select a pattern from the Pattern Palette.



■ Switch

Foreground Color, Background Color: Selects the foreground and background colors of the buttons (color: 256 colors, monochrome: 16 shades). Click **Color** to display the Color Palette. Select a color from the Color Palette.

Pattern: Selects a pattern or tonal gradation for the button. Click **Pattern** to display the Pattern Palette. Select a pattern or tonal gradation from the Pattern Palette.



■ Coordinates

X, Y: Sets the display position of parts using coordinates.

The X and Y coordinates of parts are defined relative to an origin at the top-left corner of the screen.

X: 0 to (base screen horizontal size - 1)

Y: 0 to (base screen vertical size - 1)

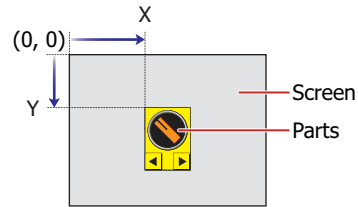

■ Size

W, H: Sets width and height to define the size of parts.

W: 20 to (base screen horizontal size)

H: 20 to (base screen vertical size)

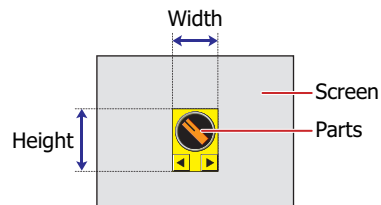

● Format Tab

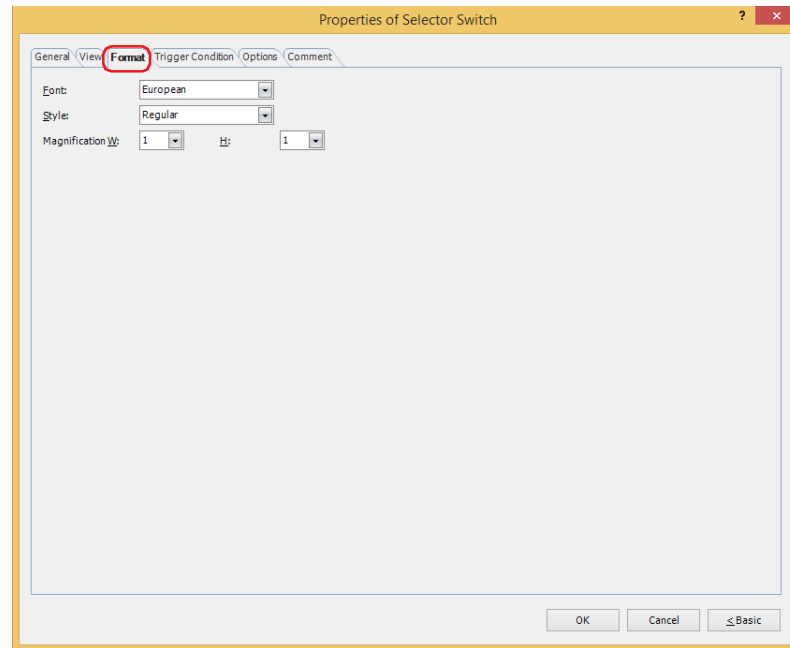

■ Font

Selects the font used for displaying text from the following.

Western, Japanese, Simplified Chinese, Traditional Chinese, Hangul, Central European, Baltic, Cyrillic, Stroke

Can only be set when the **Use Text Manager** check box is cleared.

The characters that can be displayed depend on the font. For details, refer to Chapter 2 "1.2 Available Text" on page 2-6.

■ Style

Selects **Regular** or **Bold** for text style.

Can only be set when **Font** is set to **Western, Japanese, Simplified Chinese, Traditional Chinese, Hangul, Central European, Baltic, Cyrillic**.

■ Size

Sets the character size (8 to 128).

Can only be set when **Stroke** is selected.

■ Magnification

W, H: Selects the magnification (0.5, 1 to 8) for text display.

Can only be set when **Font** is set to **Western, Japanese, Simplified Chinese, Traditional Chinese, Hangul, Central European, Baltic, Cyrillic**.

● **Trigger Condition Tab**

The **Trigger Condition** tab is displayed in Advanced mode.

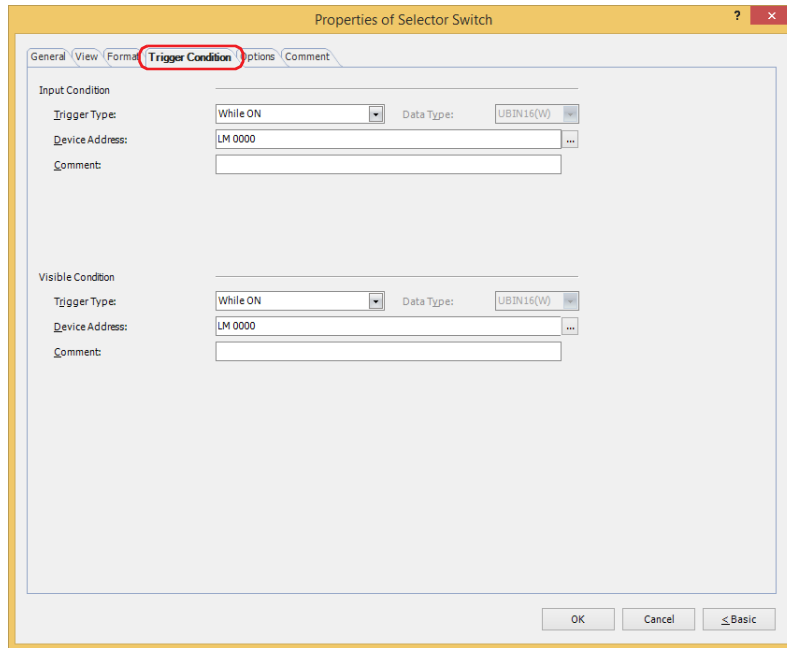

■ **Input Condition**

The Selector Switch is enabled and operational while the condition is satisfied. The Selector Switch is disabled and not operational while the condition is not satisfied.

Example: When **Trigger Type** is **While ON** and **Device Address** is **LM0**

While LM0 is 0, the condition is not satisfied and the Selector Switch is not operational.

While LM0 is 1, the condition is satisfied and the Selector Switch is operational.

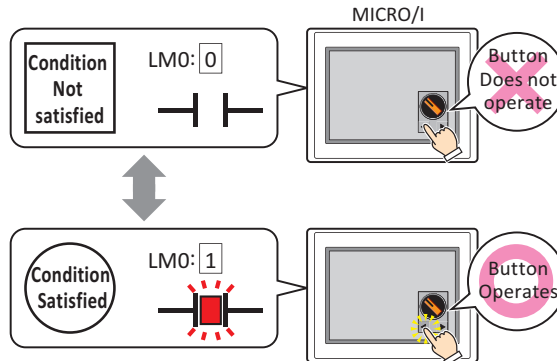

Trigger Type: Selects the condition to enable the Selector Switch from the following.

Always enable: The Selector Switch is always enabled.

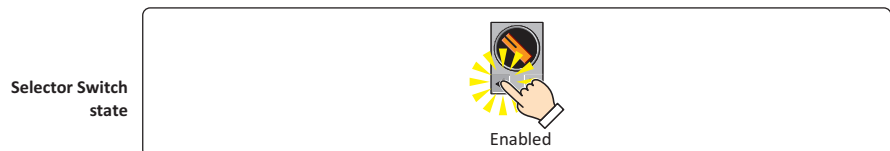

While ON: Enables the Selector Switch when the value of device address is 1.

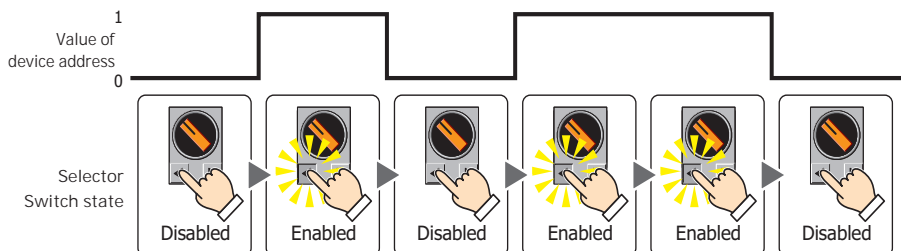

While OFF: Enables the Selector Switch when the value of device address is 0.

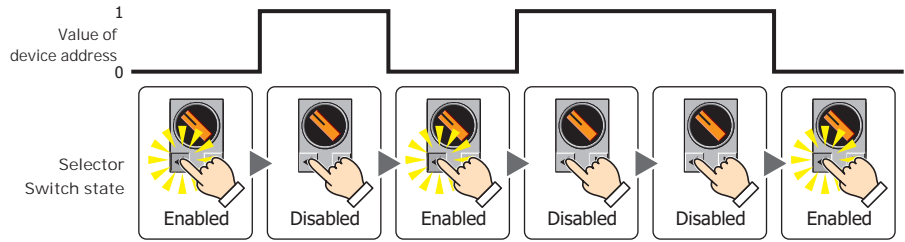

While satisfying the condition: Enables the Selector Switch when the condition is satisfied.

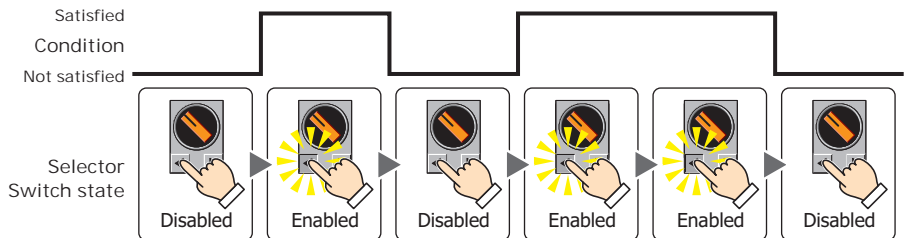

- Data Type:** Selects the type of data handled by the conditional expression for the input condition. This option can only be configured if **While satisfying the condition** is selected for **Trigger Type**. For details, refer to Chapter 2 "1.1 Available Data" on page 2-1.
- Device Address:** Specifies the bit device or the bit number of the word device to serve as the input condition. This option can only be configured when **While ON** or **While OFF** is selected for **Trigger Type**. Click to display the Tag Editor. For the device address configuration procedure, refer to Chapter 2 "5.1 Device Address Settings" on page 2-70.
- Condition:** Specifies the conditional expression for the input condition. This option can only be configured when **While satisfying the condition** is selected for **Trigger Type**. Click to display the **Trigger Condition Settings** dialog box. For the conditional expression configuration procedure, refer to Chapter 2 "5.2 Setting Conditional Expressions" on page 2-73.
- Comment:** Used for entering a comment for the input condition. The maximum number is 80 characters.

■ Visible Condition

The Selector Switch is displayed while the condition is satisfied. The Selector Switch is hidden while the condition is not satisfied.

Example: When **Trigger Type** is **While ON** and **Device Address** is **LM0**

While LM0 is 0, the condition is not satisfied and the Selector Switch is hidden.
While LM0 is 1, the condition is satisfied and the Selector Switch is displayed.

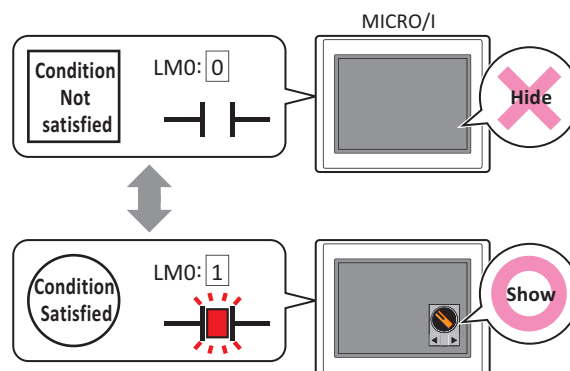

If a hidden Selector Switch is redisplayed on the screen when **Read from Destination Device Address** is selected for **Default Position** on the **General** tab, the display position of the knob changes according to the value of the device address configured for the channel. When **Ch1**, **Ch2**, or **Ch3** is selected, the knob is displayed at the same position as before it was hidden, regardless of the value of device address configured for the channel.

Trigger Type: Selects the condition to display the Selector Switch from the following.

Always visible: The Selector Switch is always displayed.



While ON: Displays the Selector Switch when the value of device address is 1.

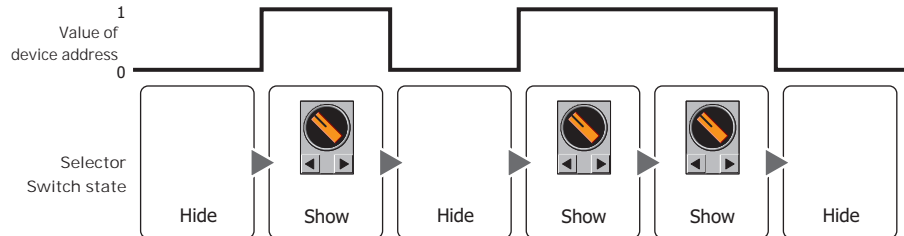

While OFF: Displays the Selector Switch when the value of device address is 0.

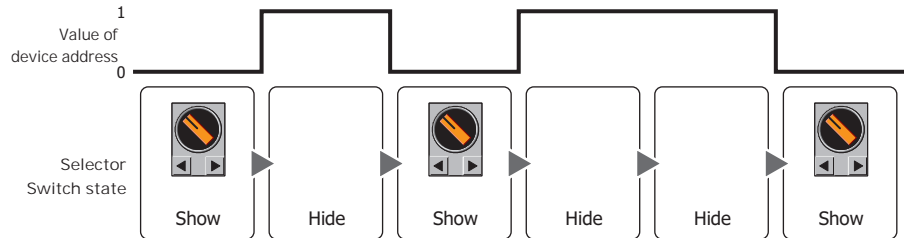

While satisfying the condition: Displays the Selector Switch when the condition is satisfied.

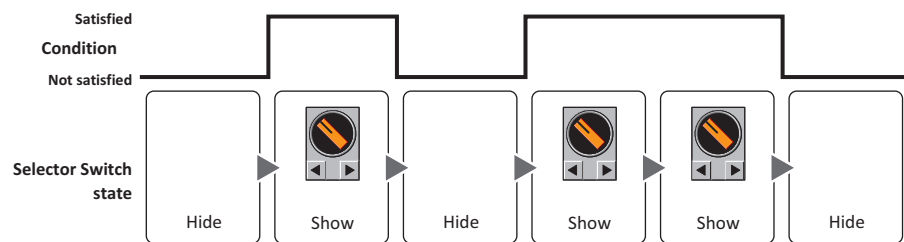

Data Type: Selects the type of data handled by the conditional expression for the visible condition. This option can only be configured if **While satisfying the condition** is selected for **Trigger Type**. For details, refer to Chapter 2 "1.1 Available Data" on page 2-1.

Device Address: Specifies the bit device or the bit number of the word device to serve as the visible condition. This option can only be configured when **While ON** or **While OFF** is selected for **Trigger Type**. Click to display the Tag Editor. For the device address configuration procedure, refer to Chapter 2 "5.1 Device Address Settings" on page 2-70.

Condition: Specifies the conditional expression for the visible condition. This option can only be configured when **While satisfying the condition** is selected for **Trigger Type**. Click to display the **Trigger Condition Settings** dialog box. For the conditional expression configuration procedure, refer to Chapter 2 "5.2 Setting Conditional Expressions" on page 2-73.

Comment: Used for entering a comment for the visible condition. The maximum number is 80 characters.

● Options Tab

The **Options** tab is displayed in Advanced mode.

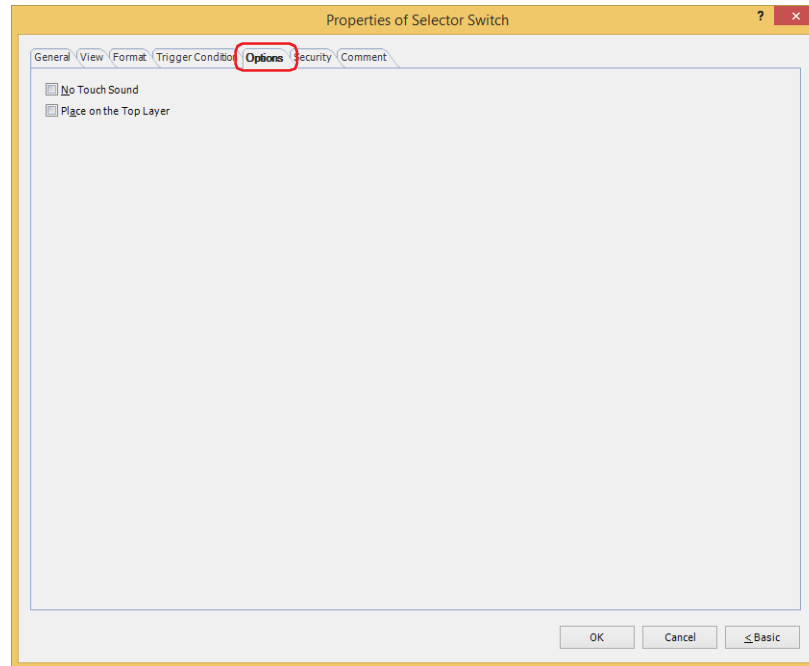

■ No Touch Sound

This function is to disable touch sounds only for specified parts when the MICRO/I makes touch sounds. Select this check box to display disable touch sounds for this part.



To enable touch sounds on the MICRO/I, select the **Enable Touch Sound** check box under the **System** tab of the **Project Settings** dialog box.

■ Place on the Top Layer

Select this check box to display the parts on the top layer. The parts will have precedence when other drawings and parts are overlapping with it. For details, refer to Chapter 6 "4 Drawings and Parts Overlapping" on page 6-5.

● Security Tab

This tab is used to restrict displaying and using the part by security groups.

This option can only be set when **Use Security functions** is selected. The **Use Security functions** check box is set on **General** tab in the **Security** dialog box.

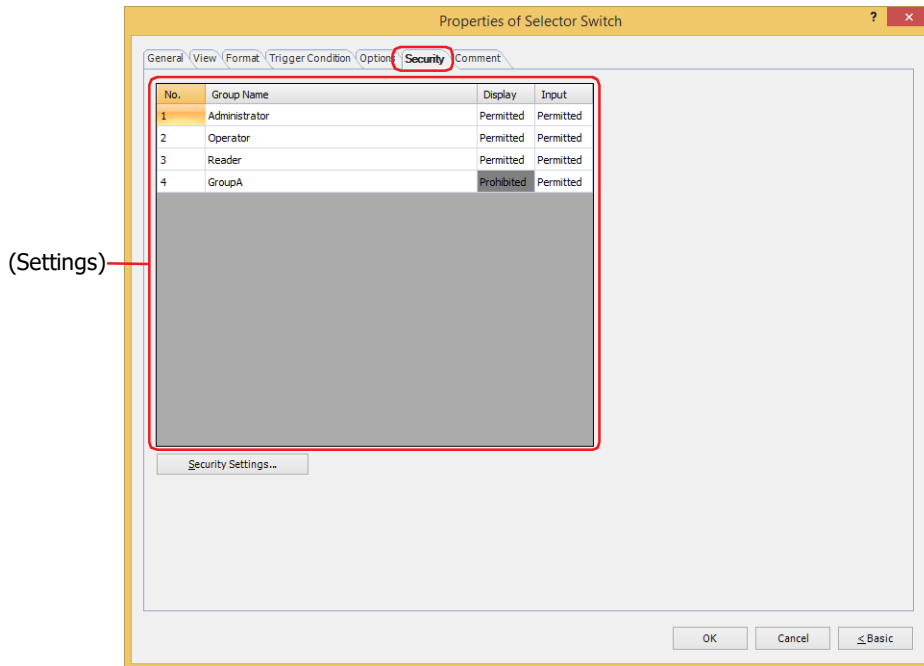

■ (Settings)

Displays the list of security groups used on the MICRO/I.

No.: Displays the security group numbers (1 to 15).

Group Name: Displays the name of the security group.

Display: Displays whether or not there is permission to display the part. Only **Permitted** security groups can display this part. If all security groups are set to **Permitted**, this part will be displayed even if no user account has been selected. Double clicking the cell switches between **Permitted** and **Prohibited**.

Input: Displays whether or not there is permission to use the part. Only **Permitted** security groups can use this part. If all security groups are set to **Permitted**, this part can be used even if no user account has been selected. Double clicking the cell switches between **Permitted** and **Prohibited**.



- You can also switch between **Permitted** and **Prohibited** by right-clicking on a **Display** or **Input** cell.
- Restricting the display and use of the part by switching between **Permitted** and **Prohibited** in **Display** and **Input** cells is similar to using the **Trigger Condition** tab.



■ Security Settings

The Security Settings dialog box is displayed. If you create a security group in the **Security Settings** dialog box, you can select that created group. For details, refer to Chapter 23 “2.2 Adding and Editing Security Groups” on page 23-19.



For details about security functions, refer to Chapter 23 “User Accounts and the Security Function” on page 23-1.

Example: If the user and security group for a part are set as follows:

User Name	 User1	 User2	 User3
Security Group	Reader	Operator	Administrator

Line Chart and Bar Chart

No.	Group Name	Display
1	Administrator	Permitted
2	Operator	Permitted
3	Reader	Prohibited

MICRO/I

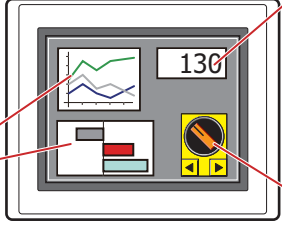

Numerical Display

No.	Group Name	Display
1	Administrator	Permitted
2	Operator	Permitted
3	Reader	Permitted

Selector Switch

No.	Group Name	Display	Input
1	Administrator	Permitted	Permitted
2	Operator	Permitted	Prohibited
3	Reader	Prohibited	Prohibited

For User1 in the **Reader** security group, the parts for which **Display** has been set to **Prohibited** for **Reader** will not be displayed.

If the password screen is opened and the user switches to User2 in the **Operator** security group, the parts for which **Display** has been set to **Permitted** for **Operator** will be displayed.

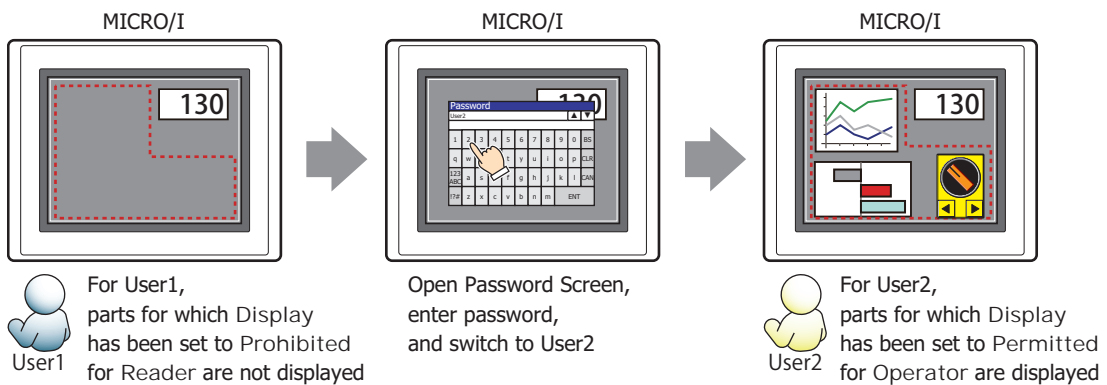

For User2 in **Operator**, **Display** has been set to **Permitted** for **Operator**, but **Input** is **Prohibited**, so the Selector Switch cannot be used.

If the password screen is opened and the user switches to User3 in the **Administrator** security group, the parts for which **Display** has been set to **Permitted** for **Administrator** will be displayed, and the parts for which **Input** has been set to **Permitted** for **Administrator** can be used.

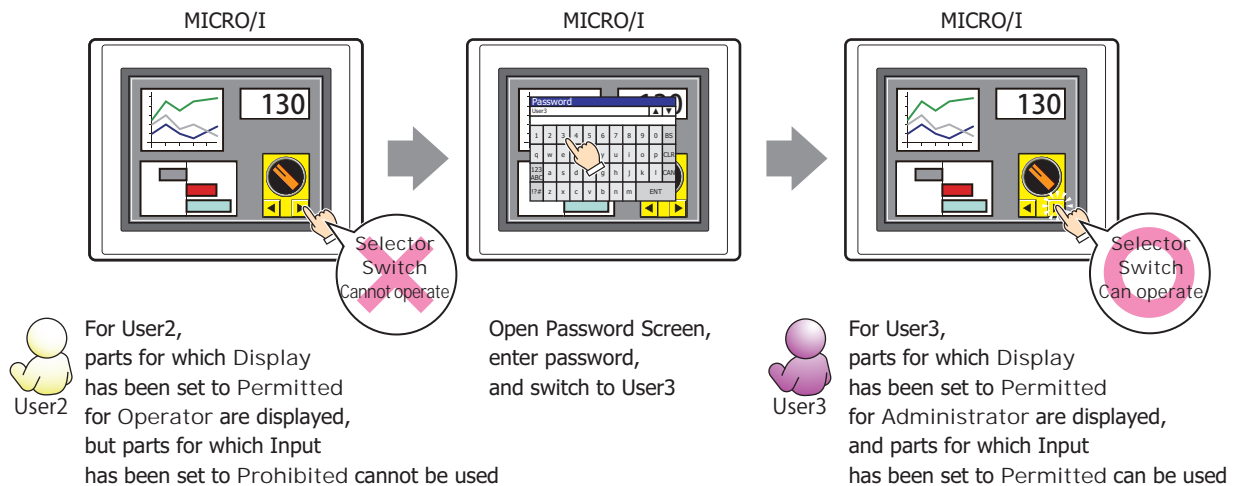

● Comment Tab

The **Comment** tab is used to specify the parts placed on the editing screen, and the popup text displayed when the mouse pointer is placed close to **No.**, **Name**, or **Type** in the object list.



When there are multiple parts of the same shape on the screen, this feature makes it possible to distinguish between the parts without displaying the Properties dialog box for each part, by just mousing over the part.

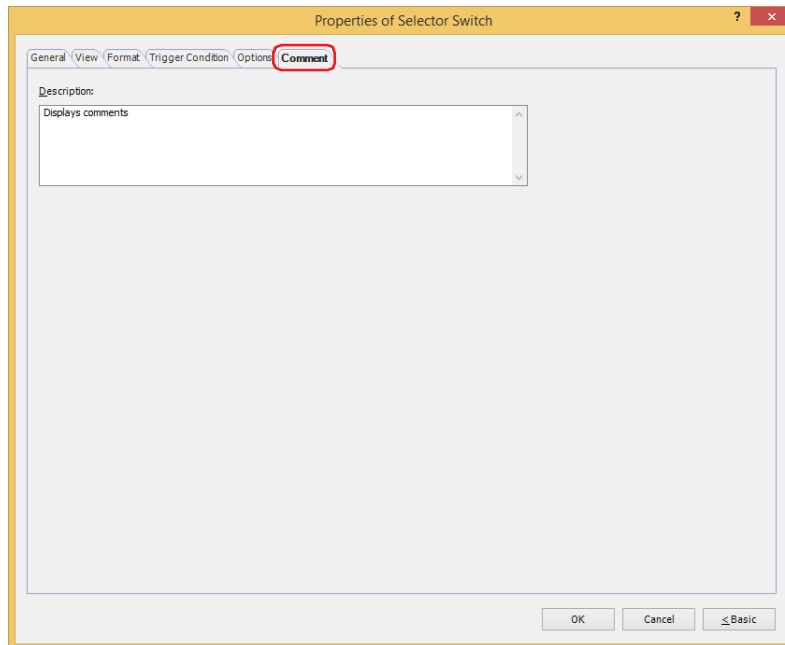

■ Description

Used for entering comments about parts. The maximum number is 80 characters.

Example: When mousing over the Selector Switch on the editing screen

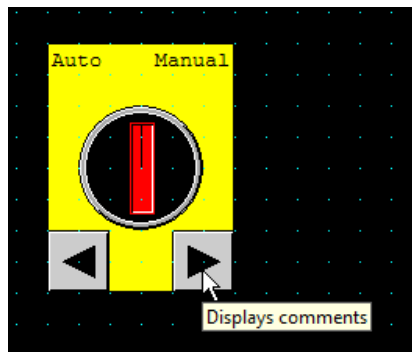

9 Potentiometer

HG2J-7U HG5G-V HG4G-V HG4G HG3G-V HG3G HG2G-V HG2G-5F HG2G-5T HG1G HG1P

9.1 How the Potentiometer is Used

Writes a value to a word device by pressing a slider button.

- The slider display position increases and decreases while the button is depressed. The value of the slider at the displayed position is written to the device address when the button is released.

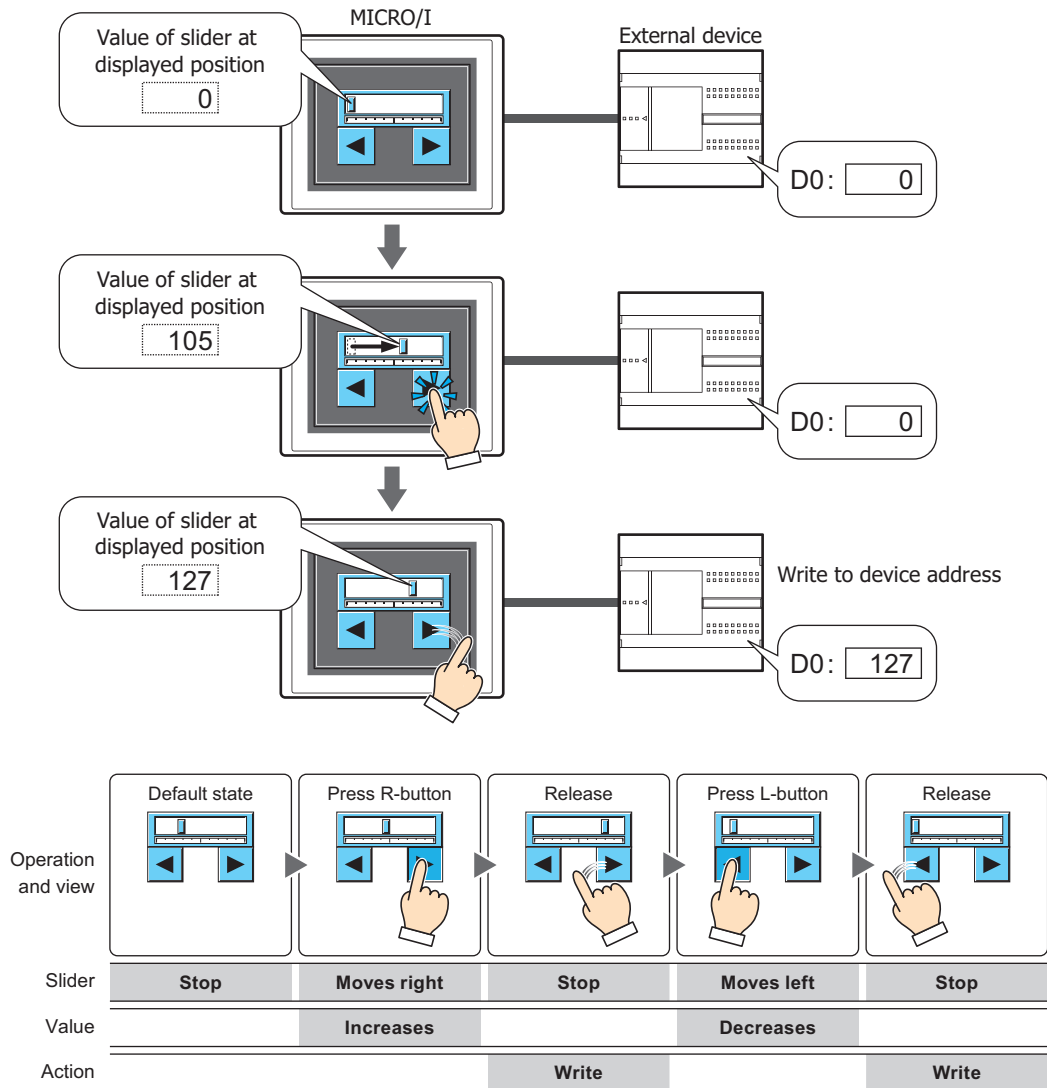

The slider indicates the value written to the device address. When the value is increased or decreased, the slider display position also changes.

The slider moves between a user-defined minimum and maximum value.

The input value increases and decreases while the button is depressed. The value of the slider at the displayed position is written to the device address when the button is released.

! The slider display position does not change when the destination device address value changes unless it was changed by the Potentiometer buttons. However, immediately after the screen is switched and immediately after the part is displayed on the screen, the slider is displayed at the position specified by the value of the destination device address.

9.2 Potentiometer Configuration Procedure

This section describes the configuration procedure for Potentiometer parts.

- 1 On the **Home** tab, in the **Parts** group, click **Buttons**, and then click **Potentiometer**.

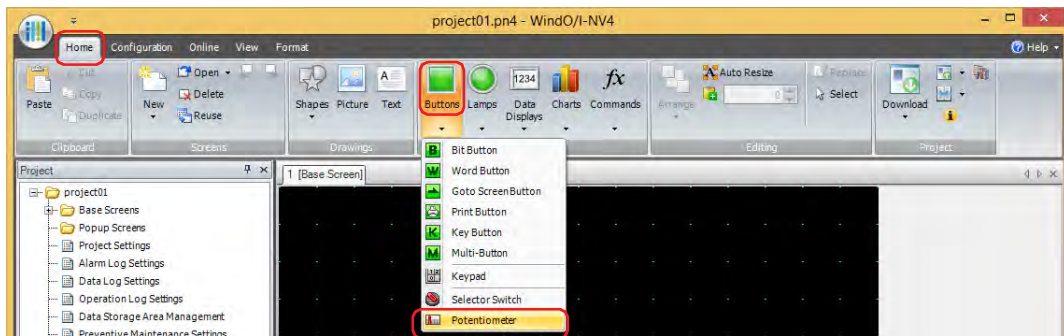

- 2 Click a point on the edit screen where you wish to place the Potentiometer.
- 3 Double-click the placed Potentiometer and a Properties dialog box will be displayed.
- 4 Change the settings on each tab as necessary.

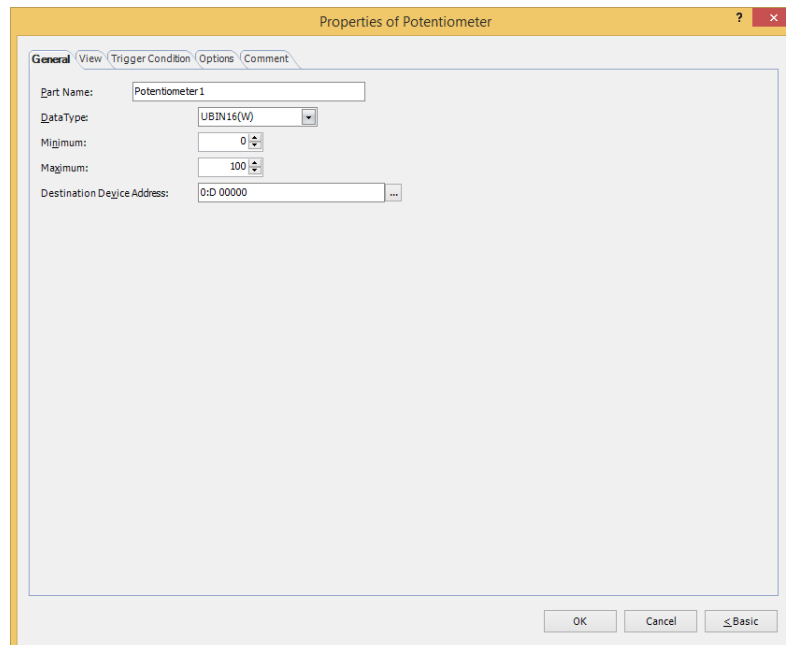

The **Trigger Condition** tab and **Options** tab only appear in Advanced mode.



You can set the default for the Potentiometer on the **Default Preferences** tab of the **WindO/I-NV4 Options** dialog box. For details, refer to Chapter 2 "Default Preferences Tab" on page 2-63.

9.3 Properties of Potentiometer Dialog Box

This section describes items and buttons in the Properties dialog box.

● General Tab

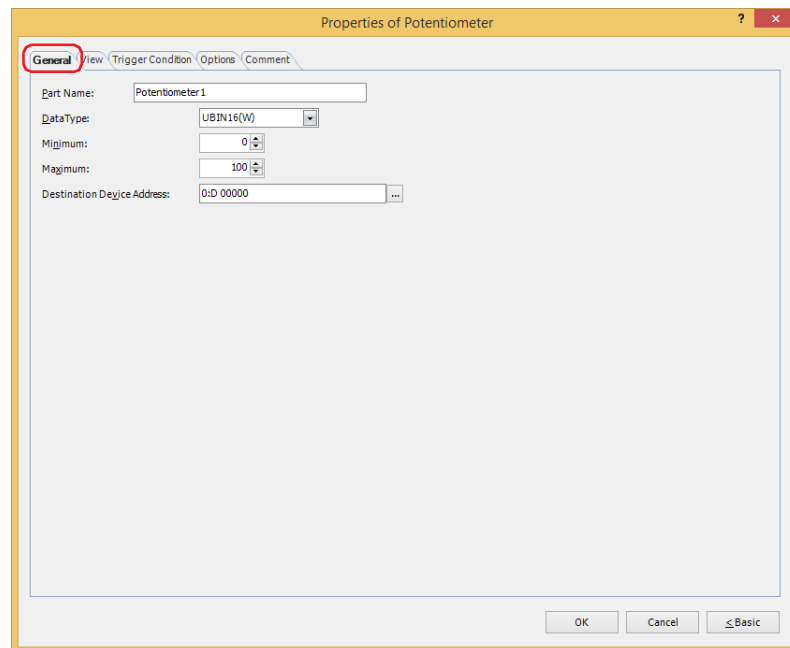

■ Part Name

Enter a name for the part. The maximum number is 20 characters.

■ Data Type

Select the data type to be handled by the Potentiometer.

For details, refer to Chapter 2 "1.1 Available Data" on page 2-1.

■ Minimum

Specify the minimum value that can be entered. The minimum value differs depending on the data type.

■ Maximum

Specify the maximum value that can be entered. The maximum value differs depending on the data type.

■ Destination Device Address

Specify the destination word device.

Click to display the Tag Editor. For the device address configuration procedure, refer to Chapter 2 "5.1 Device Address Settings" on page 2-70.

● **View Tab**

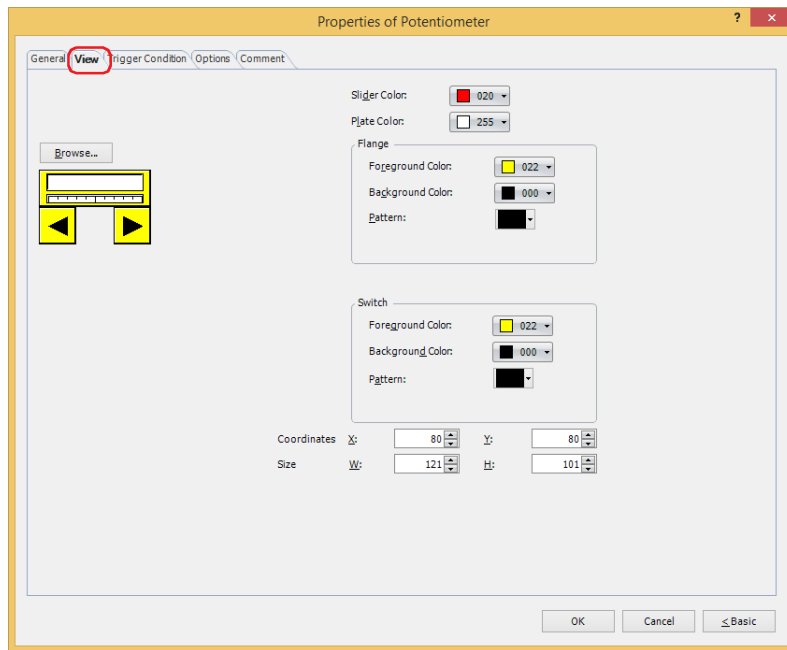

■ **Browse**

Select the type of graphic to be used to represent the part from the list of graphics. Click this button to display the View Browser.

■ **Slider Color**

Selects the slider color of the Potentiometer (color: 256 colors, monochrome: 16 shades).
Click **Color** to display the Color Palette. Select a color from the Color Palette.

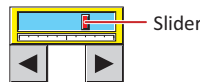

■ **Plate Color**

Selects the plate color (color: 256 colors, monochrome: 16 shades).
Click **Color** to display the Color Palette. Select a color from the Color Palette.



■ **Flange**

Foreground Color, Background Color: Selects the foreground and background colors of the flange (color: 256 colors, monochrome: 16 shades).
Click **Color** to display the Color Palette. Select a color from the Color Palette.

Pattern: Selects a pattern for the flange.
Click **Pattern** to display the Pattern Palette. Select a pattern from the Pattern Palette.

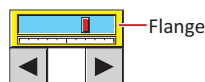

■ Switch

Foreground Color, Background Color: Selects the foreground and background colors of the buttons (color: 256 colors, monochrome: 16 shades).
Click **Color** to display the Color Palette. Select a color from the Color Palette.

Pattern: Selects a pattern or tonal gradation for the button.
Click **Pattern** to display the Pattern Palette. Select a pattern or tonal gradation from the Pattern Palette.



■ Coordinates

X, Y: Sets the display position of parts using coordinates.

The X and Y coordinates of parts are defined relative to an origin at the top-left corner of the screen.

X: 0 to (base screen horizontal size - 1)

Y: 0 to (base screen vertical size - 1)

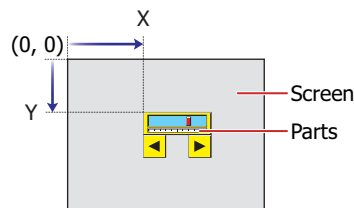

■ Size

W, H: Sets width and height to define the size of parts.

W: 20 to (base screen horizontal size)

H: 20 to (base screen vertical size)

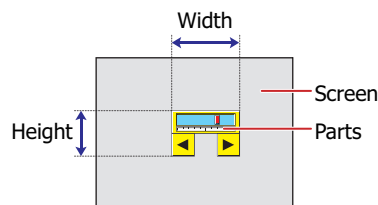

● **Trigger Condition Tab**

The **Trigger Condition** tab is displayed in Advanced mode.

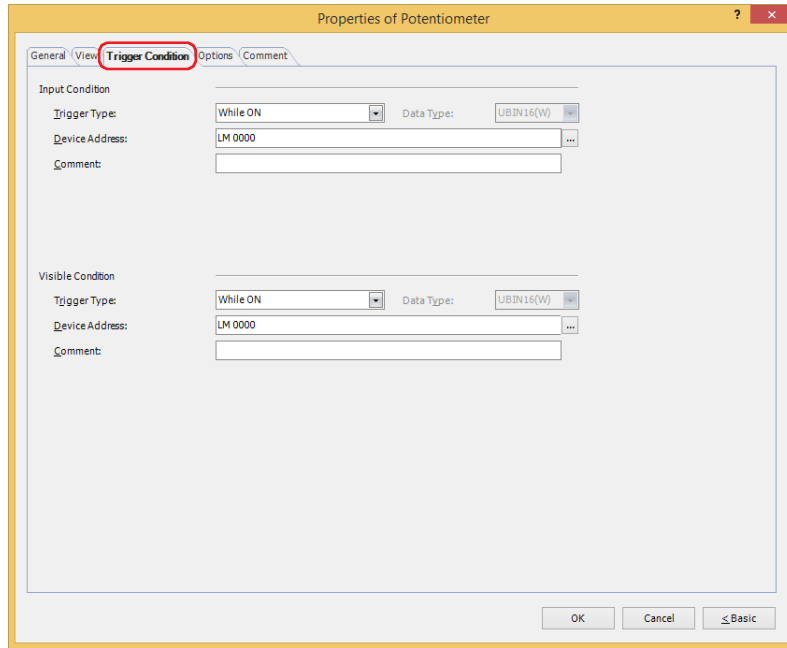

■ **Input Condition**

The Potentiometer is enabled and operational while the condition is satisfied. The Potentiometer is disabled and not operational while the condition is not satisfied.

Example: When **Trigger Type** is **While ON** and **Device Address** is **LM0**

While LM0 is 0, the condition is not satisfied and the Potentiometer is not operational.

While LM0 is 1, the condition is satisfied and the Potentiometer is operational.

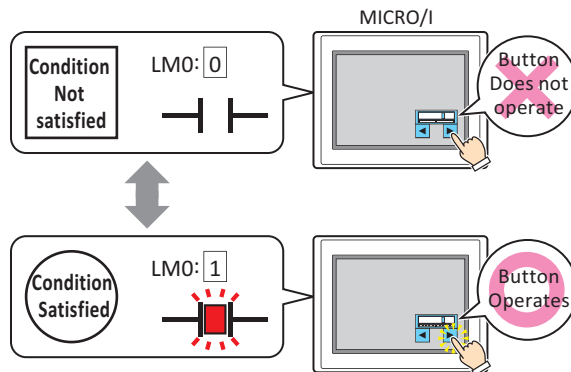

Trigger Type: Selects the condition to enable the Potentiometer from the following.

Always enable: The Potentiometer is always enabled.

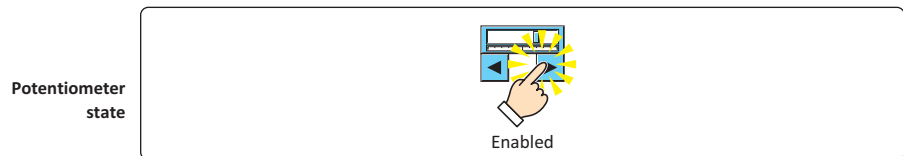

While ON: Enables the Potentiometer when the value of device address is 1.

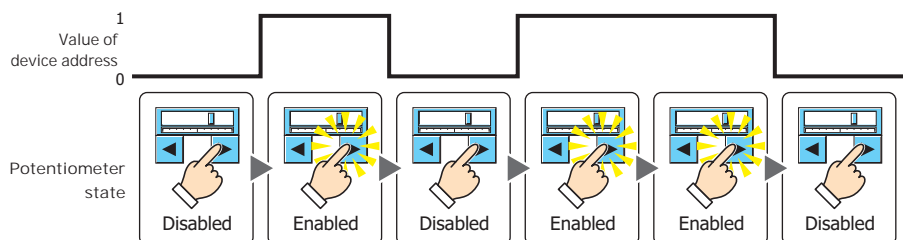

While OFF: Enables the Potentiometer when the value of device address is 0.

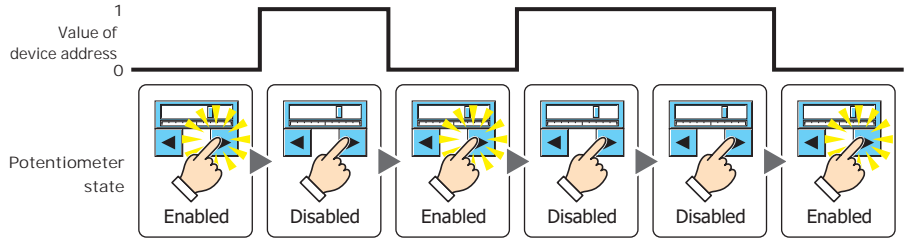

While satisfying the condition: Enables the Potentiometer when the condition is satisfied.

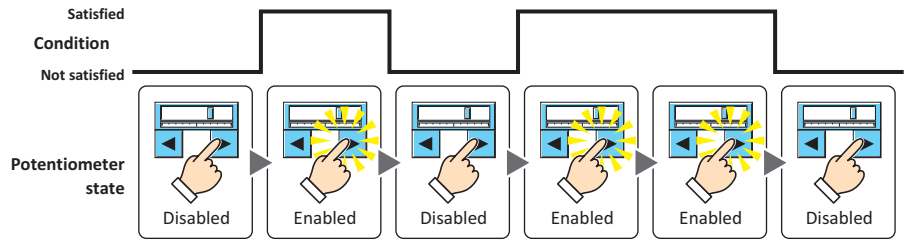

- Data Type:** Selects the type of data handled by the conditional expression for the input condition. This option can only be configured if **While satisfying the condition** is selected for **Trigger Type**. For details, refer to Chapter 2 "1.1 Available Data" on page 2-1.
- Device Address:** Specifies the bit device or the bit number of the word device to serve as the input condition. This option can only be configured when **While ON** or **While OFF** is selected for **Trigger Type**. Click to display the Tag Editor. For the device address configuration procedure, refer to Chapter 2 "5.1 Device Address Settings" on page 2-70.
- Condition:** Specifies the conditional expression for the input condition. This option can only be configured when **While satisfying the condition** is selected for **Trigger Type**. Click to display the **Trigger Condition Settings** dialog box. For the conditional expression configuration procedure, refer to Chapter 2 "5.2 Setting Conditional Expressions" on page 2-73.
- Comment:** Used for entering a comment for the input condition. The maximum number is 80 characters.

■ **Visible Condition**

The Potentiometer is displayed while the condition is satisfied. The Potentiometer is hidden while the condition is not satisfied.

Example: When **Trigger Type** is **While ON** and **Device Address** is **LM0**

While LM0 is 0, the condition is not satisfied and the Potentiometer is hidden.
While LM0 is 1, the condition is satisfied and the Potentiometer is displayed.

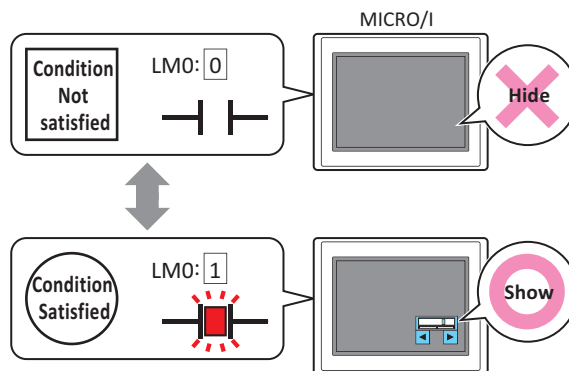

When a hidden Potentiometer is redisplayed, the slider is displayed at the position specified by the value of device address.

Trigger Type: Selects the condition to display the Potentiometer from the following.

Always visible: The Potentiometer is always displayed.

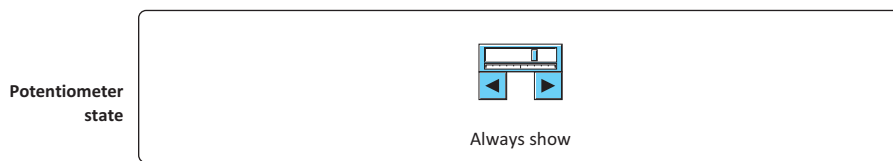

While ON: Displays the Potentiometer when the value of device address is 1.

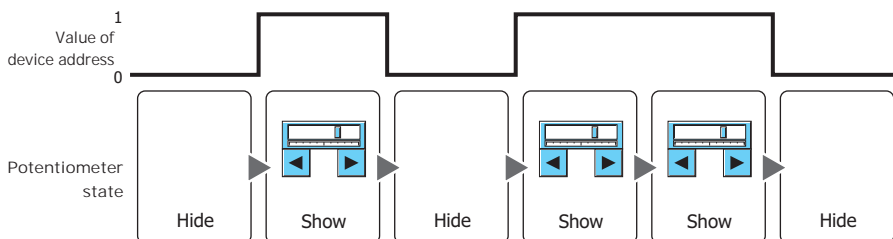

While OFF: Displays the Potentiometer when the value of device address is 0.

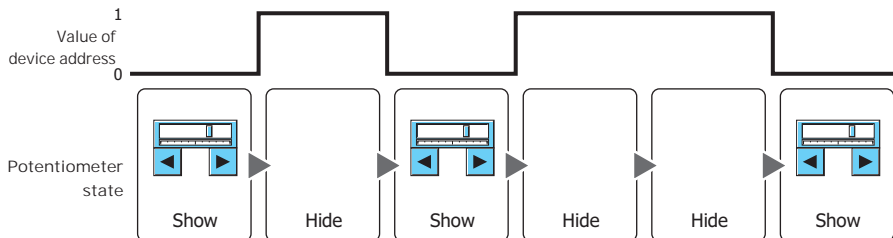

While satisfying the condition: Displays the Potentiometer when the condition is satisfied.

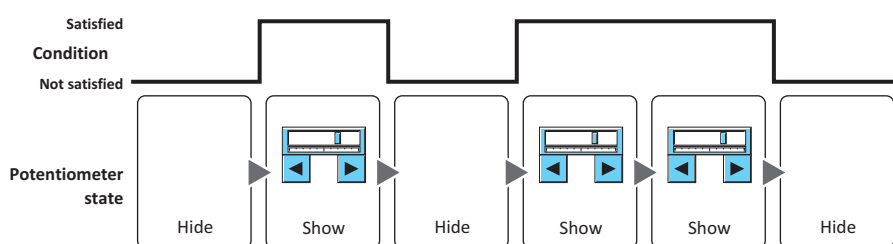

Data Type: Selects the type of data handled by the conditional expression for the visible condition. This option can only be configured if **While satisfying the condition** is selected for **Trigger Type**. For details, refer to Chapter 2 "1.1 Available Data" on page 2-1.

Device Address: Specifies the bit device or the bit number of the word device to serve as the visible condition. This option can only be configured when **While ON** or **While OFF** is selected for **Trigger Type**. Click to display the Tag Editor. For the device address configuration procedure, refer to Chapter 2 "5.1 Device Address Settings" on page 2-70.

Condition: Specifies the conditional expression for the visible condition. This option can only be configured when **While satisfying the condition** is selected for **Trigger Type**. Click to display the **Trigger Condition Settings** dialog box. For the conditional expression configuration procedure, refer to Chapter 2 "5.2 Setting Conditional Expressions" on page 2-73.

Comment: Used for entering a comment for the visible condition. The maximum number is 80 characters.

● Options Tab

The **Options** tab is displayed in Advanced mode.

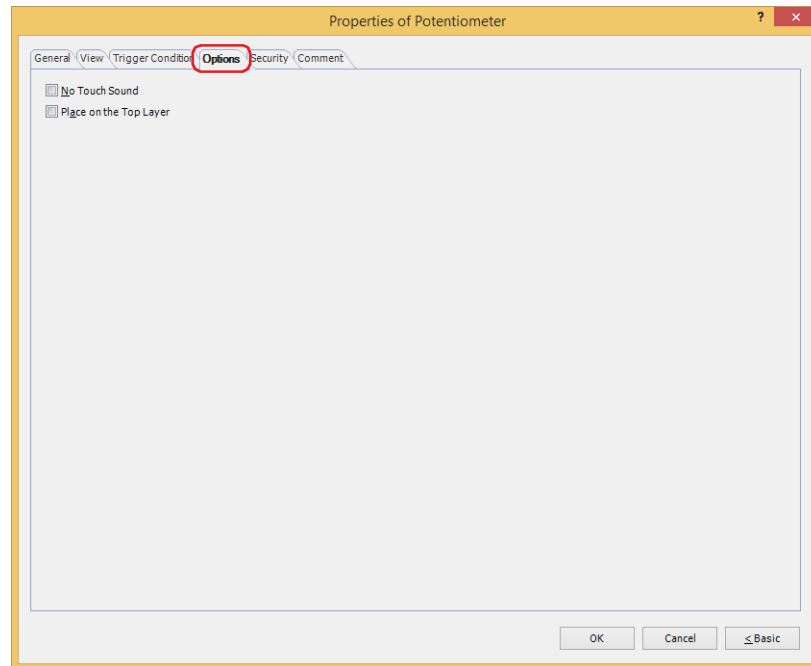

■ No Touch Sound

This function is to disable touch sounds only for specified parts when the MICRO/I makes touch sounds. Select this check box to display disable touch sounds for this part.



To enable touch sounds on the MICRO/I, select the **Enable Touch Sound** check box under the **System** tab of the **Project Settings** dialog box.

■ Place on the Top Layer

Select this check box to display the parts on the top layer. The parts will have precedence when other drawings and parts are overlapping with it. For details, refer to Chapter 6 "4 Drawings and Parts Overlapping" on page 6-5.

● Security Tab

This tab is used to restrict displaying and using the part by security groups.

This option can only be set when **Use Security functions** is selected. The **Use Security functions** check box is set on **General** tab in the **Security** dialog box.

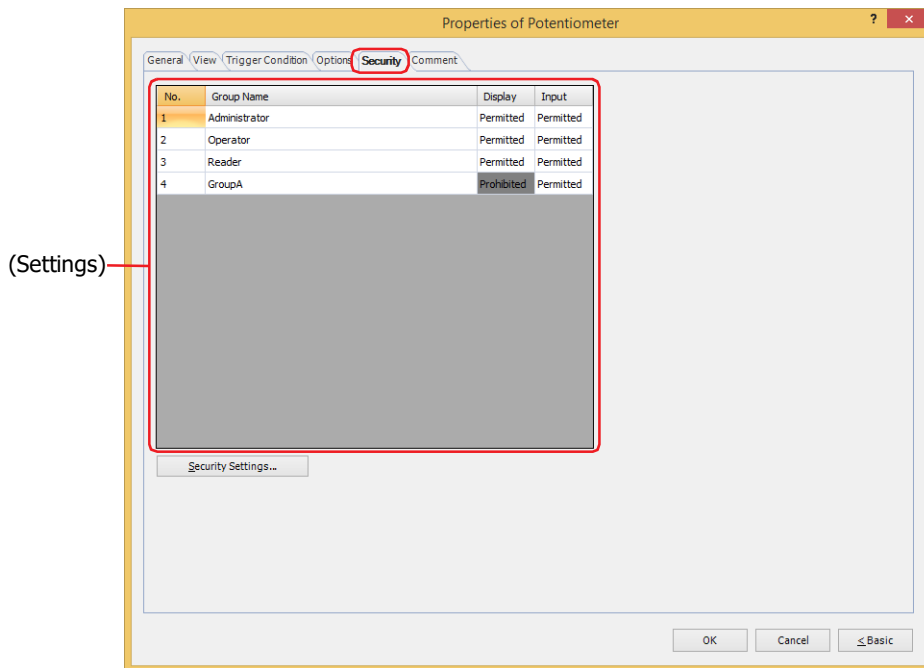

(Settings)

■ (Settings)

Displays the list of security groups used on the MICRO/I.

No.: Displays the security group numbers (1 to 15).

Group Name: Displays the name of the security group.

Display: Displays whether or not there is permission to display the part. Only **Permitted** security groups can display this part. If all security groups are set to **Permitted**, this part will be displayed even if no user account has been selected. Double clicking the cell switches between **Permitted** and **Prohibited**.

Input: Displays whether or not there is permission to use the part. Only **Permitted** security groups can use this part. If all security groups are set to **Permitted**, this part can be used even if no user account has been selected. Double clicking the cell switches between **Permitted** and **Prohibited**.



- You can also switch between **Permitted** and **Prohibited** by right-clicking on a **Display** or **Input** cell.
- Restricting the display and use of the part by switching between **Permitted** and **Prohibited** in **Display** and **Input** cells is similar to using the **Trigger Condition** tab.



■ Security Settings

The Security Settings dialog box is displayed. If you create a security group in the **Security Settings** dialog box, you can select that created group. For details, refer to Chapter 23 "2.2 Adding and Editing Security Groups" on page 23-19.



For details about security functions, refer to Chapter 23 "User Accounts and the Security Function" on page 23-1.

Example: If the user and security group for a part are set as follows:

User Name	 User1	 User2	 User3
Security Group	Reader	Operator	Administrator

Line Chart and Bar Chart

No.	Group Name	Display
1	Administrator	Permitted
2	Operator	Permitted
3	Reader	Prohibited

MICRO/I

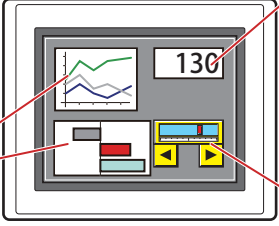

Numerical Display

No.	Group Name	Display
1	Administrator	Permitted
2	Operator	Permitted
3	Reader	Permitted

Potentiometer

No.	Group Name	Display	Input
1	Administrator	Permitted	Permitted
2	Operator	Permitted	Prohibited
3	Reader	Prohibited	Prohibited

For User1 in the **Reader** security group, the parts for which **Display** has been set to **Prohibited** for **Reader** will not be displayed.

If the password screen is opened and the user switches to User2 in the **Operator** security group, the parts for which **Display** has been set to **Permitted** for **Operator** will be displayed.

MICRO/I

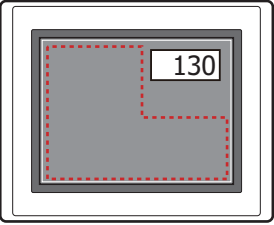

 For User1, parts for which Display has been set to Prohibited for Reader are not displayed

MICRO/I



Open Password Screen, enter password, and switch to User2

MICRO/I

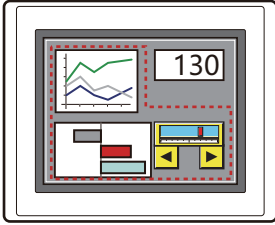



 For User2, parts for which Display has been set to Permitted for Operator are displayed

For User2 in **Operator**, **Display** has been set to **Permitted** for **Operator**, but **Input** is **Prohibited**, so the Potentiometer cannot be used.

If the password screen is opened and the user switches to User3 in the **Administrator** security group, the parts for which **Display** has been set to **Permitted** for **Administrator** will be displayed, and the parts for which **Input** has been set to **Permitted** for **Administrator** can be used.

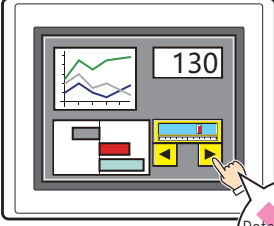
MICRO/I



 For User2, parts for which Display has been set to Permitted for Operator are displayed, but parts for which Input has been set to Prohibited cannot be used

MICRO/I

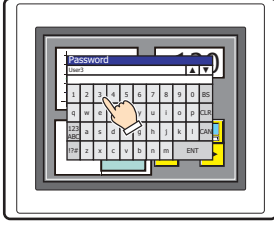

Open Password Screen, enter password, and switch to User3

MICRO/I

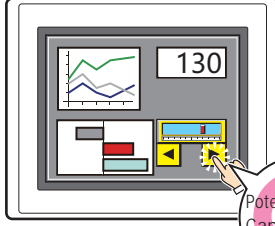

 For User3, parts for which Display has been set to Permitted for Administrator are displayed, and parts for which Input has been set to Permitted can be used

● Comment Tab

The **Comment** tab is used to specify the parts placed on the editing screen, and the popup text displayed when the mouse pointer is placed close to **No.**, **Name**, or **Type** in the object list.



When there are multiple parts of the same shape on the screen, this feature makes it possible to distinguish between the parts without displaying the Properties dialog box for each part, by just mousing over the part.

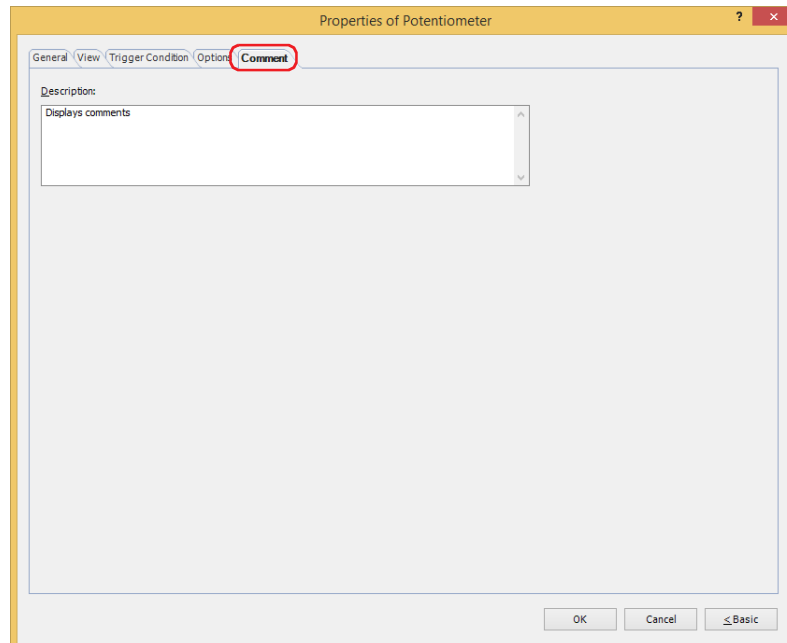

■ Description

Used for entering comments about parts. The maximum number is 80 characters.

Example: When mousing over the Potentiometer on the editing screen

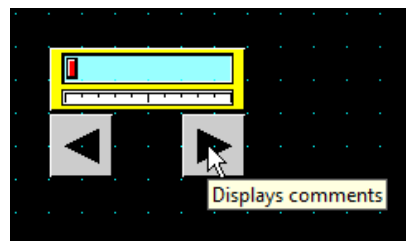

Chapter 9 Lamps

This chapter describes the setup for the lamp parts and related MICRO/I operations.

1 Pilot Lamp

HG2J-7U HG5G-V HG4G-V HG4G HG3G-V HG3G HG2G-V HG2G-5F HG2G-5T HG1G HG1P

1.1 How the Pilot Lamp is Used

Pilot Lamp parts display drawing objects. The value of a bit device is used to switch the drawing object displayed.

- Switch and display pictures by values of device addresses

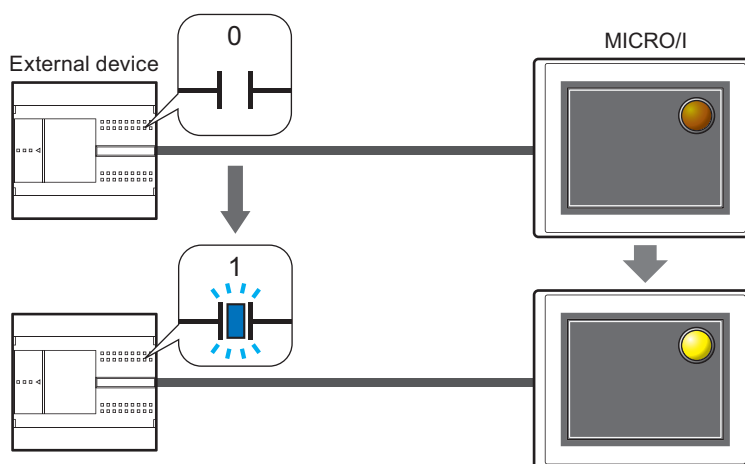

1.2 Pilot Lamp Configuration Procedure

This section describes the configuration procedure for Pilot Lamps.

- 1 On the **Home** tab, in the **Parts** group, click **Lamps**, and then click **Pilot Lamp**.

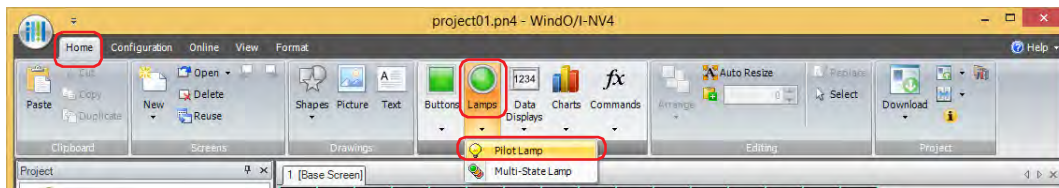

- 2 Click a point on the Edit screen where you wish to place the Pilot Lamp.
- 3 Double-click the placed Pilot Lamp and a Properties dialog box will be displayed.
- 4 Change the settings on each tab as necessary.

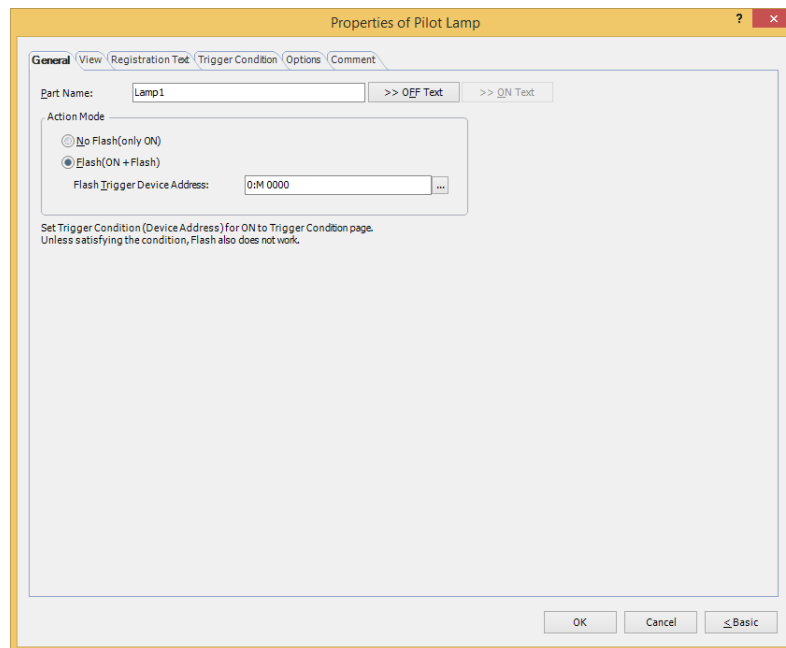

The **Options** tab only appears in Advanced mode.



You can set the default for the Pilot Lamp on the **Default Preferences** tab of the **WindO/I-NV4 Options** dialog box. For details, refer to Chapter 2 "Default Preferences Tab" on page 2-63.

1.3 Properties of Pilot Lamp Dialog Box

This section describes items and buttons on the properties dialog box.

● General Tab

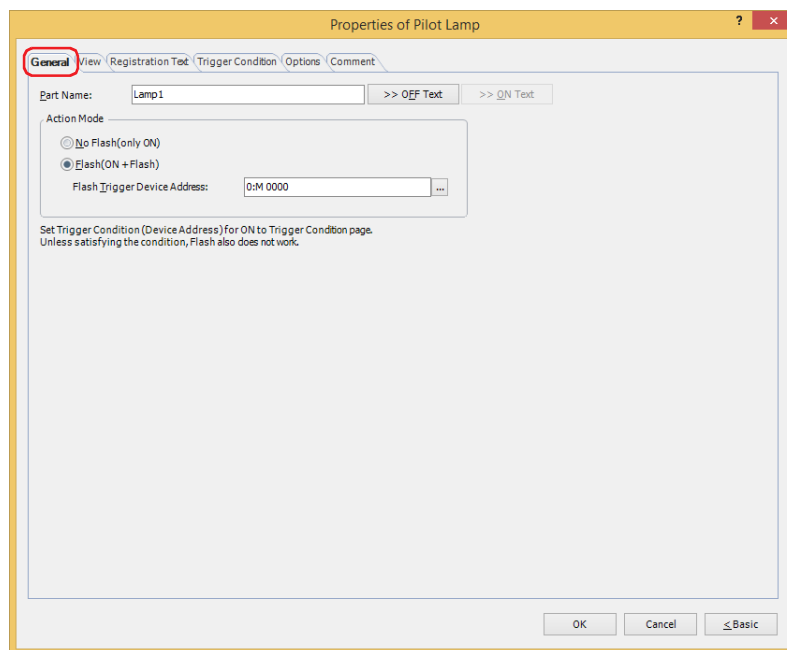

■ Part Name

Enter a name for the part. The maximum number is 20 characters.

■ >>OFF Text, >>ON Text

Applies the text entered in the **Part Name** field to the **Text** field under the **OFF** or **ON** fields on the **Registration Text** tab. This is used as the Registration Text when the lamp is OFF or ON.



To specify the Registration Text to use when the button is ON, select the **Set by State** check box on the **Registration Text** tab. If left unchecked, the same Registration Text assigned for the OFF state is displayed for the ON state as well.

■ Action Mode

Select the action when the part is ON.

No Flash (only ON): Displays the drawing object for the ON state when the trigger condition is satisfied.



Flash (ON + Flash): When the condition is satisfied and the value of the trigger device address is 1, the object flashes (alternates between the drawing object for the ON and OFF states at fixed intervals). The flashing interval can be set with the **Flashing Cycle** setting on the **System** tab of the **Project Settings** dialog box.

Flash Trigger Device Address: Specify the bit device to cause the lamp to flash.

The lamp flashes when the value of the device address is 1. The action for **No Flash (only ON)** applies when the value is 0.

Click to display the Tag Editor. For the device address configuration procedure, refer to Chapter 2 "5.1 Device Address Settings" on page 2-70.

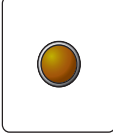
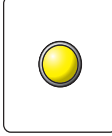
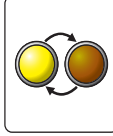
Example: When **Action Mode** is **Flash (ON + Flash)**, **Flash Trigger Device Address** is M0, and on the **Trigger Condition** tab, **Trigger Type** is **While ON**, **Device Address** is LM0

Trigger Condition: Device Address LM0 value	0	1	1	0
Action Mode: Value of Flash Trigger Device Address M0	0	0	1	1
Displayed drawing object				
Action	Displays OFF drawing object	Displays ON drawing object	Flashing	Displays OFF drawing object



The lamp will neither turn on or flash if the trigger conditions are not met. Lamp trigger conditions are configured on the **Trigger Condition** tab.

● View Tab

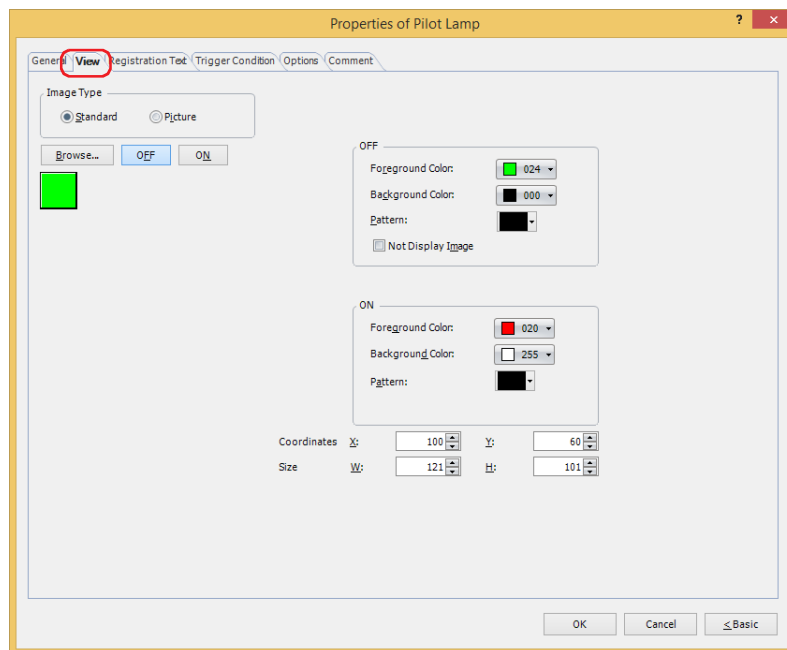

■ Image Type

Select the type of graphic to be used to represent the part.

Standard: Uses the default graphic for WindO/I-NV4.

Picture: Uses an image file saved using Picture Manager.

For details about image file restrictions, refer to Chapter 2 "1.4 Available Image Files" on page 2-20.

■ Browse

Select the type of graphic to be used to represent the part from the list of graphics. Click this button to display the View Browser or Picture Manager, depending on the setting for **Image Type**.

■ OFF button, ON button

Displays the graphic when ON or OFF. Clicking **ON** or **OFF** switches the image displayed on the **View** tab.

■ OFF, ON

Selects the color and pattern of the standard graphic when ON and OFF.

Foreground Color, Background Color:

Selects the foreground and background colors of the standard graphic (color: 256 colors, monochrome: 16 shades).

Click **Color** to display the Color Palette. Select a color from the Color Palette.

Pattern: Selects a pattern or tonal gradation for the standard graphic.

Click **Pattern** to display the Pattern Palette. Select a pattern or tonal gradation from the Pattern Palette.

■ Not Display Image^{*1}

Select this check box to display no drawing object in the OFF state.



If the **Not Display Image** check box is selected, Text set as registration text for the OFF state will be displayed.

*1 Advanced mode only

■ Coordinates

- X, Y: Sets the display position of parts using coordinates.
The X and Y coordinates of parts is defined relative to an origin at the top-left corner of the screen.
- X: 0 to (base screen horizontal size - 1)
- Y: 0 to (base screen vertical size - 1)

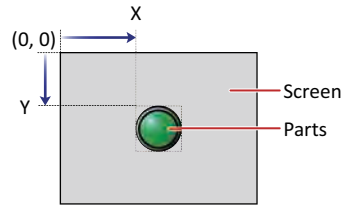

■ Size

- Sets width and height to define the size of parts. The minimum size varies based on the item selected for Image Type.
- Standard: The minimum size varies based on the selected item and the maximum size is a base screen size.
- Picture: W: 2 to (base screen horizontal size)
- H: 2 to (base screen vertical size)

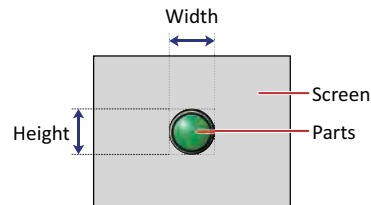

● **Registration Text Tab**

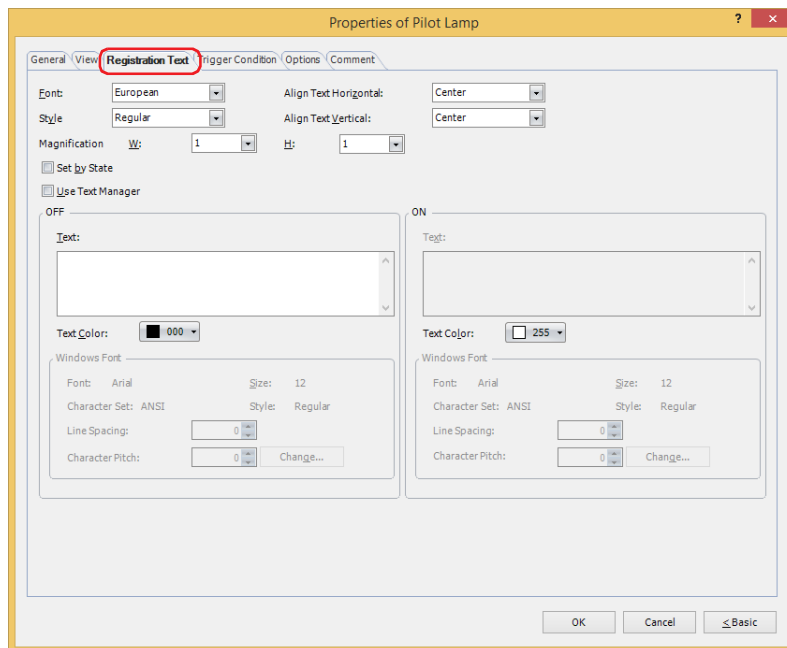

■ **Font**

Selects the font used for displaying text from the following.

Western, Japanese, Simplified Chinese, Traditional Chinese, Hangul, Central European, Baltic, Cyrillic, Windows, Stroke^{*1}

Can only be set when the **Use Text Manager** check box is cleared.

The characters that can be displayed depend on the font. For details, refer to Chapter 2 “1.2 Available Text” on page 2-6.

■ **Style**^{*1}

Selects **Regular** or **Bold** for text style.

Can only be set when **Font** is set to **Western, Japanese, Simplified Chinese, Traditional Chinese, Hangul, Central European, Baltic, Cyrillic**.

■ **Size**

Specifies the text size to be displayed. The fonts and sizes that can be set vary based on the model.

Model	Font	Size
HG2J-7U	Western, Japanese, Simplified Chinese, Traditional Chinese, Hangul, Central European, Baltic, Cyrillic	8 to 512
HG5G/4G/3G/2G-V, HG4G/3G, HG2G-5F/-5T, HG1G/1P	Stroke	8 to 128

■ **Magnification**^{*1}

W, H: Selects the magnification (0.5, 1 to 8) for text display.

Can only be set when **Font** is set to **Western, Japanese, Simplified Chinese, Traditional Chinese, Hangul, Central European, Baltic, Cyrillic**.

■ **Align Text Horizontal**

Selects text alignment in the horizontal direction.

Left, Center, Right, Center-Left

For details, refer to Appendix “5 Text Alignment” on page A-7.

*1 HG5G/4G/3G/2G-V, HG4G/3G, HG2G-5F/-5T, HG1G/1P only

■ Align Text Vertical

Selects text alignment in the vertical direction.

Top, Center, Bottom

This option can only be configured when **Left**, **Center**, or **Right** is selected for **Align Text Horizontal**. If **Center-Left** is selected for **Align Text Horizontal**, **Center-Top** is set as this option.

For details, refer to Appendix "5 Text Alignment" on page A-7.

■ Set by State

Select this check box if displaying different text when ON and OFF.

■ Use Text Manager

Select this check box if using the text registered in Text Manager for text display.

■ OFF, ON

- Text:** Inputs characters to be displayed on parts. The maximum number is 3,750 characters.
The characters that can be entered depend on the font selected using **Font**. For details, refer to Chapter 2 "1.2 Available Text" on page 2-6.
- Text ID:** Specifies the Text Manager ID No. (1 to 32000) when using the text registered in the Text Manager.
Click to display Text Manager.
Can only be set when the **Use Text Manager** check box is selected.
- Text Color:** Selects the color of the text displayed on the part (color: 256 colors, monochrome: 16 shades).
Click **Color** to display the Color Palette. Select a color from the Color Palette.
- Windows Font:** Sets the font to be used as the Windows Font.
Select **Windows** using **Font** to display the current setting. You can specify the character spacing (0 to 100) and the line spacing (0 to 100). To change the settings other than the character spacing and line spacing, click **Change** to display the **Font Settings** dialog box.
Can only be set when the **Use Text Manager** check box is cleared.
For details, refer to Chapter 2 "Windows Font" on page 2-13.

● **Trigger Condition Tab**

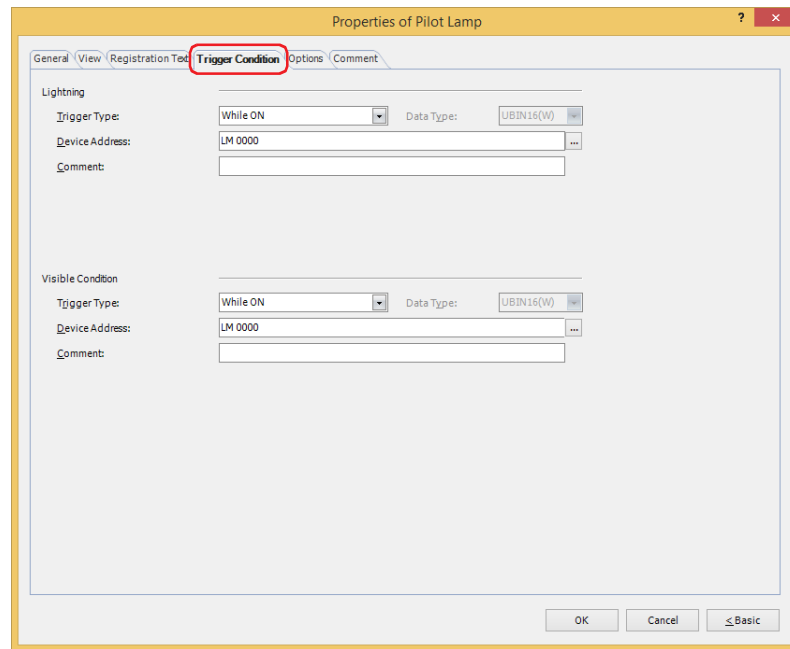

■ **Lightning**

The Pilot Lamp is on while the condition is satisfied, and it is off while the condition is not satisfied. The Pilot Lamp displays the ON graphic when on and it displays the OFF graphic when off.

Example: When **Trigger Type** is **While ON** and **Device Address** is **LM0**

When LM0 is 0, condition is not satisfied, so Lamp displays OFF graphic.

When LM0 is 1, condition is satisfied, so Lamp displays ON graphic.

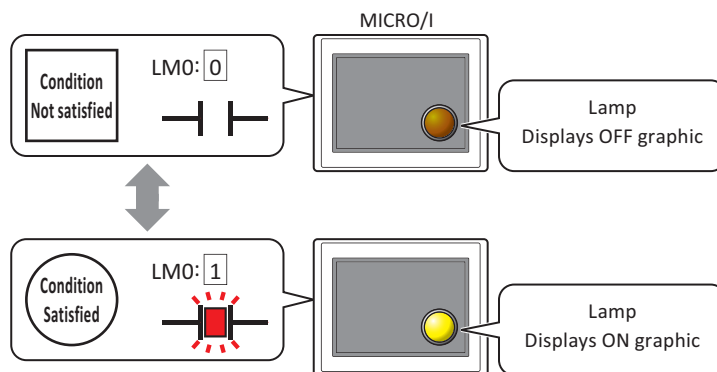

Trigger Type: Selects the condition to turn on the Pilot Lamp from the following.

While ON: Turns on the Pilot Lamp when the value of device address is 1.

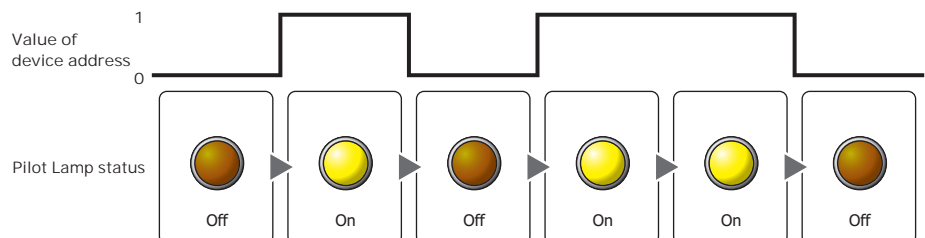

While OFF: Turns on the Pilot Lamp when the value of device address is 0.

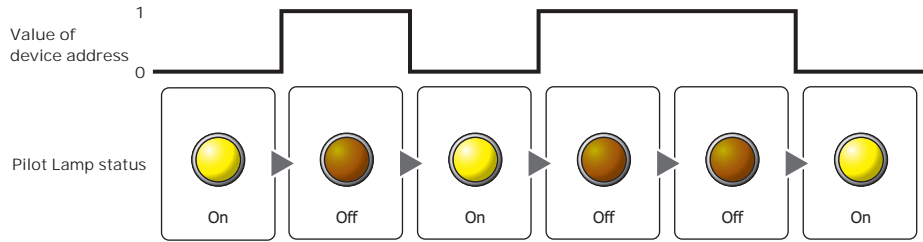

While satisfying the condition:

Turns on the Pilot Lamp when the condition is satisfied.

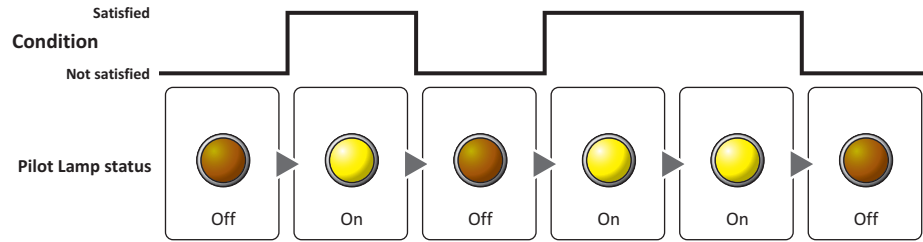

- Data Type:** Selects the type of data handled by the conditional expression for the ON condition. This option can only be configured if **While satisfying the condition** is selected for **Trigger Type**. For details, refer to Chapter 2 "1.1 Available Data" on page 2-1.
- Device Address:** Specifies the bit device or the bit number of the word device to serve as the ON condition. This option can only be configured when **While ON** or **While OFF** is selected for **Trigger Type**. Click to display the Tag Editor. For the device address configuration procedure, refer to Chapter 2 "5.1 Device Address Settings" on page 2-70.
- Condition:** Specifies the conditional expression for the ON condition. This option can only be configured when **While satisfying the condition** is selected for **Trigger Type**. Click to display the **Trigger Condition Settings** dialog box. For the conditional expression configuration procedure, refer to Chapter 2 "5.2 Setting Conditional Expressions" on page 2-73.
- Comment:** Used for entering a comment for the ON condition. The maximum number is 80 characters.

■ **Visible Condition**

The Pilot Lamp is displayed while the condition is satisfied. The Pilot Lamp is hidden while the condition is not satisfied.

Example: When **Trigger Type** is **While ON** and **Device Address** is **LM0**
 While LM0 is 0, the condition is not satisfied and the Pilot Lamp is hidden.
 While LM0 is 1, the condition is satisfied and the Pilot Lamp is displayed.

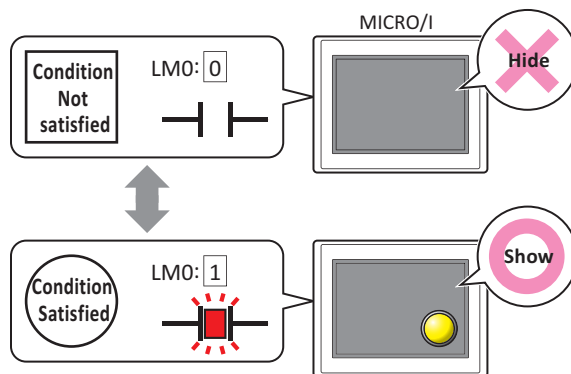

Trigger Type: Selects the condition to display the Pilot Lamp from the following.

Always visible: The Pilot Lamp is always displayed.

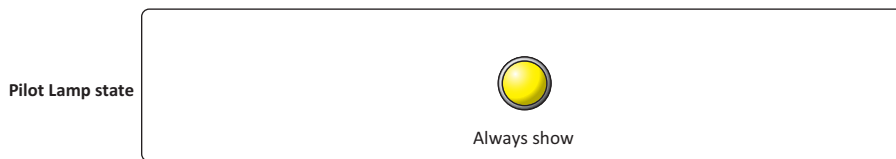

While ON: Displays the Pilot Lamp when the value of device address is 1.

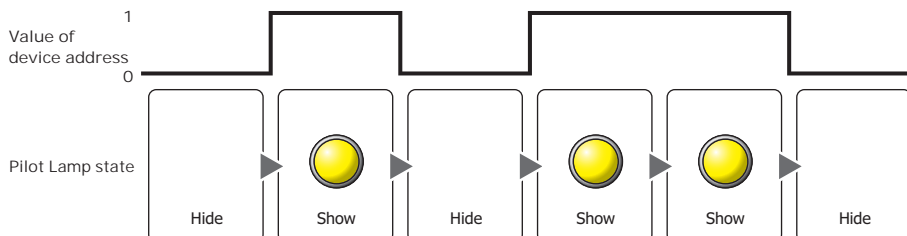

While OFF: Displays the Pilot Lamp when the value of device address is 0.

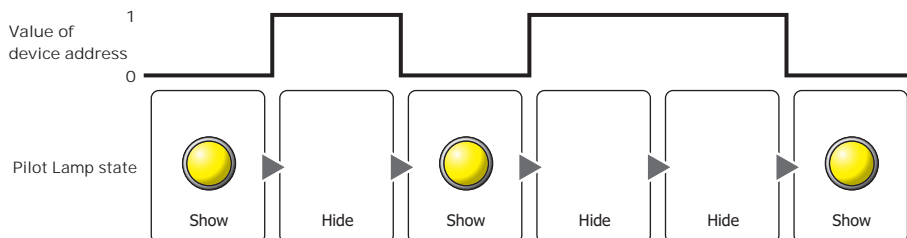

While satisfying the condition: Displays the Pilot Lamp when the condition is satisfied.

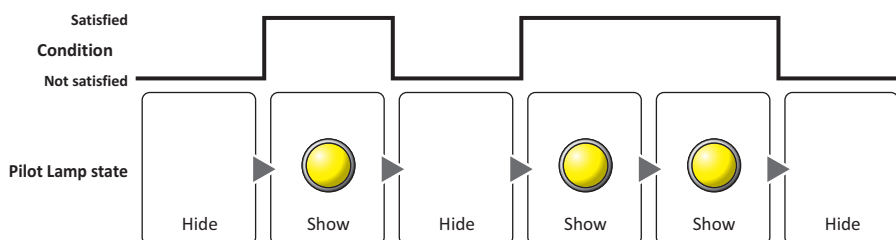

Data Type: Selects the type of data handled by the conditional expression for the visible condition. This option can only be configured if **While satisfying the condition** is selected for **Trigger Type**. For details, refer to Chapter 2 "1.1 Available Data" on page 2-1.

Device Address: Specifies the bit device or the bit number of the word device to serve as the visible condition. This option can only be configured when **While ON** or **While OFF** is selected for **Trigger Type**. Click to display the Tag Editor. For the device address configuration procedure, refer to Chapter 2 "5.1 Device Address Settings" on page 2-70.

Condition: Specifies the conditional expression for the visible condition. This option can only be configured when **While satisfying the condition** is selected for **Trigger Type**. Click to display the **Trigger Condition Settings** dialog box. For the conditional expression configuration procedure, refer to Chapter 2 "5.2 Setting Conditional Expressions" on page 2-73.

Comment: Used for entering a comment for the visible condition. The maximum number is 80 characters.

● Options Tab

The **Options** tab is displayed in Advanced mode.

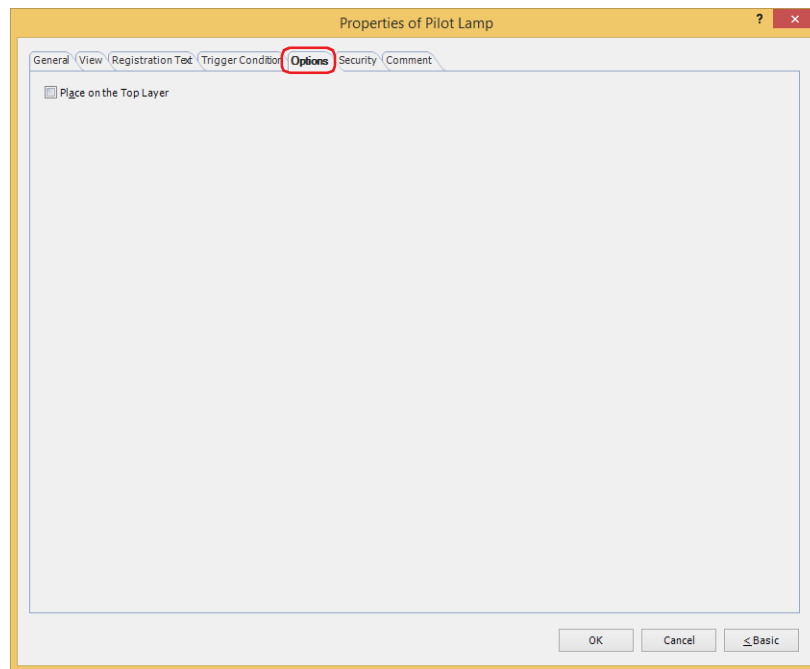

■ Place on the Top Layer

Select this check box to display the parts on the top layer. The parts will have precedence when other drawings and parts are overlapping with it. For details, refer to Chapter 6 "4 Drawings and Parts Overlapping" on page 6-5.

● **Security Tab**

This tab is used to restrict displaying and using the part by security groups.

This option can only be set when **Use Security functions** is selected. The **Use Security functions** check box is set on **General** tab in the **Security** dialog box.

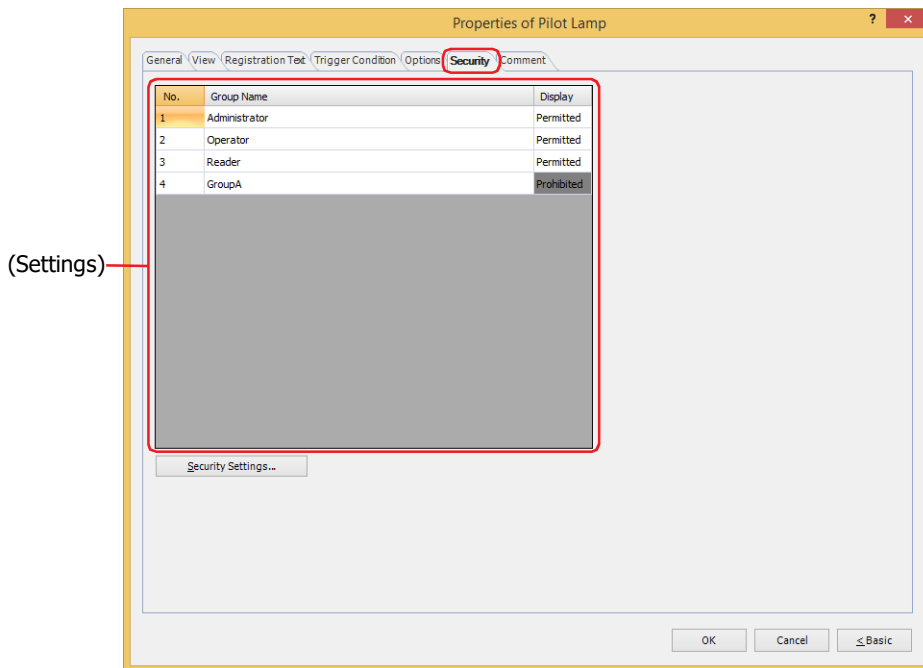

■ **(Settings)**

Displays the list of security groups used on the MICRO/I.

No.: Displays the security group numbers (1 to 15).

Group Name: Displays the name of the security group.

Display: Displays whether or not there is permission to display the part. Only **Permitted** security groups can display this part. If all security groups are set to **Permitted**, this part will be displayed even if no user account has been selected. Double clicking the cell switches between **Permitted** and **Prohibited**.



You can also switch between **Permitted** and **Prohibited** by right-clicking on a **Display** cell.



■ **Security Settings**

The Security Settings dialog box is displayed. If you create a security group in the **Security Settings** dialog box, you can select that created group. For details, refer to Chapter 23 "2.2 Adding and Editing Security Groups" on page 23-19.



For details about security functions, refer to Chapter 23 "User Accounts and the Security Function" on page 23-1.

Example: If the user and security group for a part are set as follows:

User Name	 User1	 User2
Security Group	Reader	Operator

Line Chart and Bar Chart

No.	Group Name	Display
1	Administrator	Permitted
2	Operator	Permitted
3	Reader	Prohibited

MICRO/I

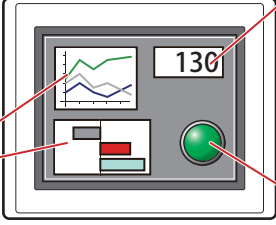

Numerical Display

No.	Group Name	Display
1	Administrator	Permitted
2	Operator	Permitted
3	Reader	Permitted

Pilot Lamp

No.	Group Name	Display
1	Administrator	Permitted
2	Operator	Permitted
3	Reader	Prohibited

For User1 in the **Reader** security group, the parts for which **Display** has been set to **Prohibited** for **Reader** will not be displayed.

If the password screen is opened and the user switches to User2 in the **Operator** security group, the parts for which **Display** has been set to **Permitted** for **Operator** will be displayed.

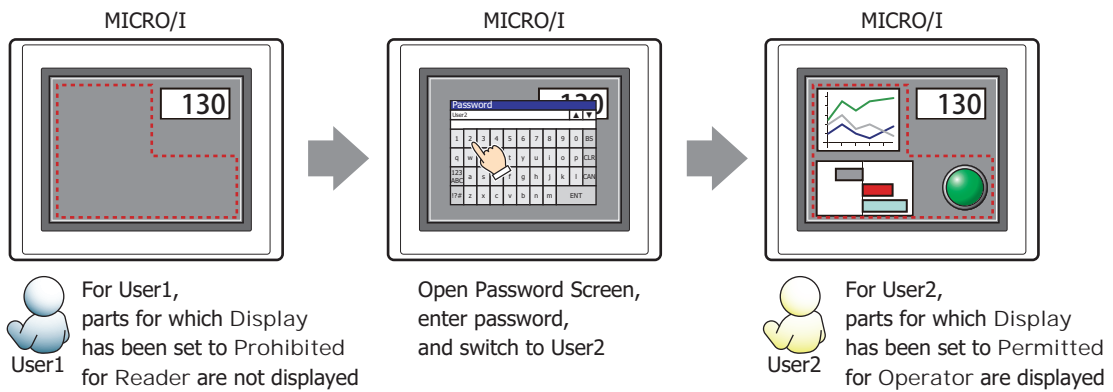

● Comment Tab

The **Comment** tab is used to specify the parts placed on the editing screen, and the popup text displayed when the mouse pointer is placed close to **No.**, **Name**, or **Type** in the object list.



When there are multiple parts of the same shape on the screen, this feature makes it possible to distinguish between the parts without displaying the Properties dialog box for each part, by just mousing over the part.

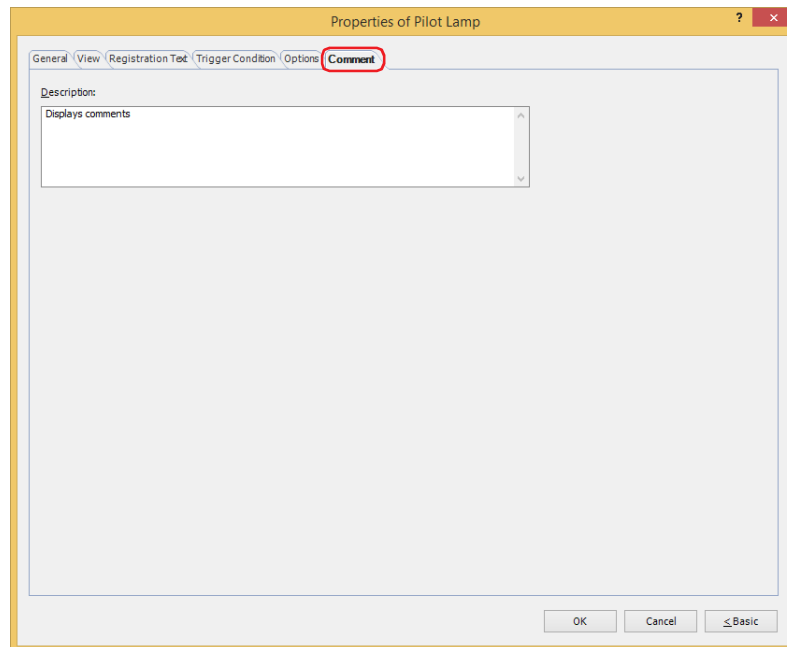

■ Description

Used for entering comments about parts. The maximum number is 80 characters.

Example: When mousing over the Pilot Lamp on the editing screen

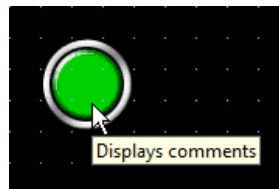

2 Multi-State Lamp

HG2J-7U HG5G-V HG4G-V HG4G HG3G-V HG3G HG2G-V HG2G-5F HG2G-5T HG1G HG1P

2.1 How the Multi-State Lamp is Used

Multi-state lamp parts display drawing objects. The value of a specified word device is used to switch the drawing object to be displayed.

- Switch and display pictures by values of device addresses

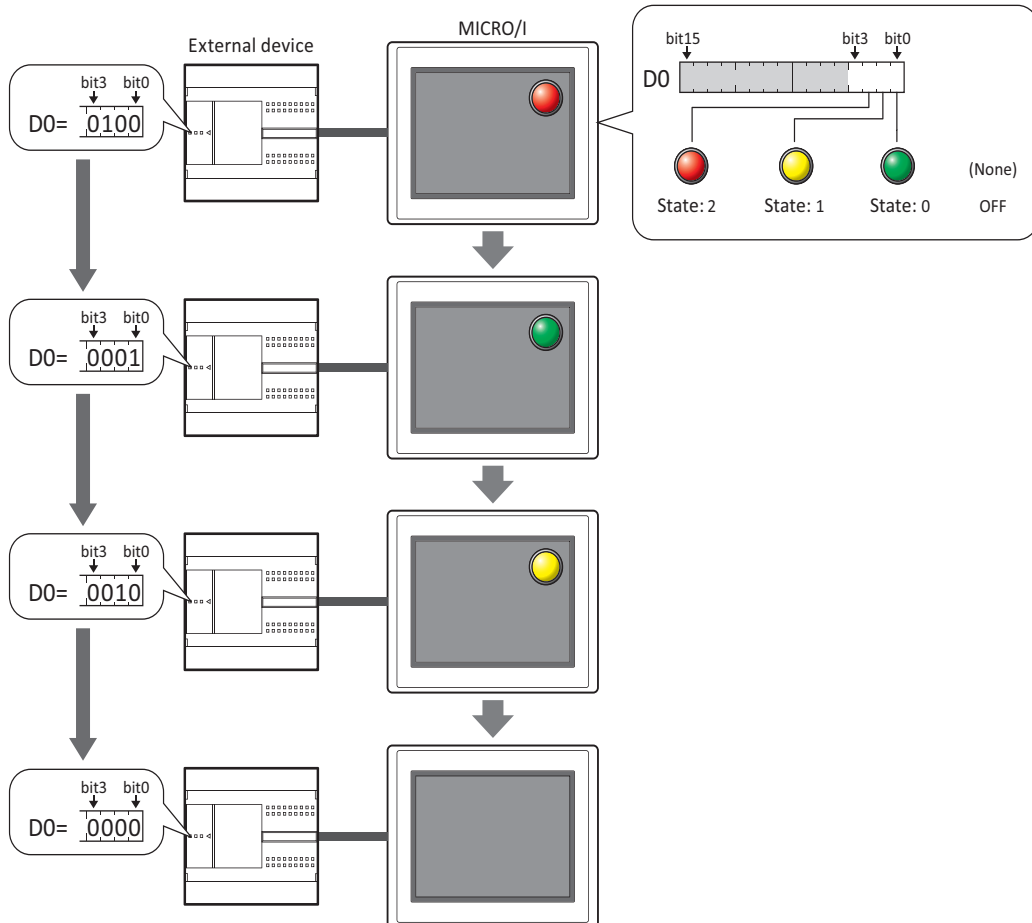

- Display a picture when in the OFF state.

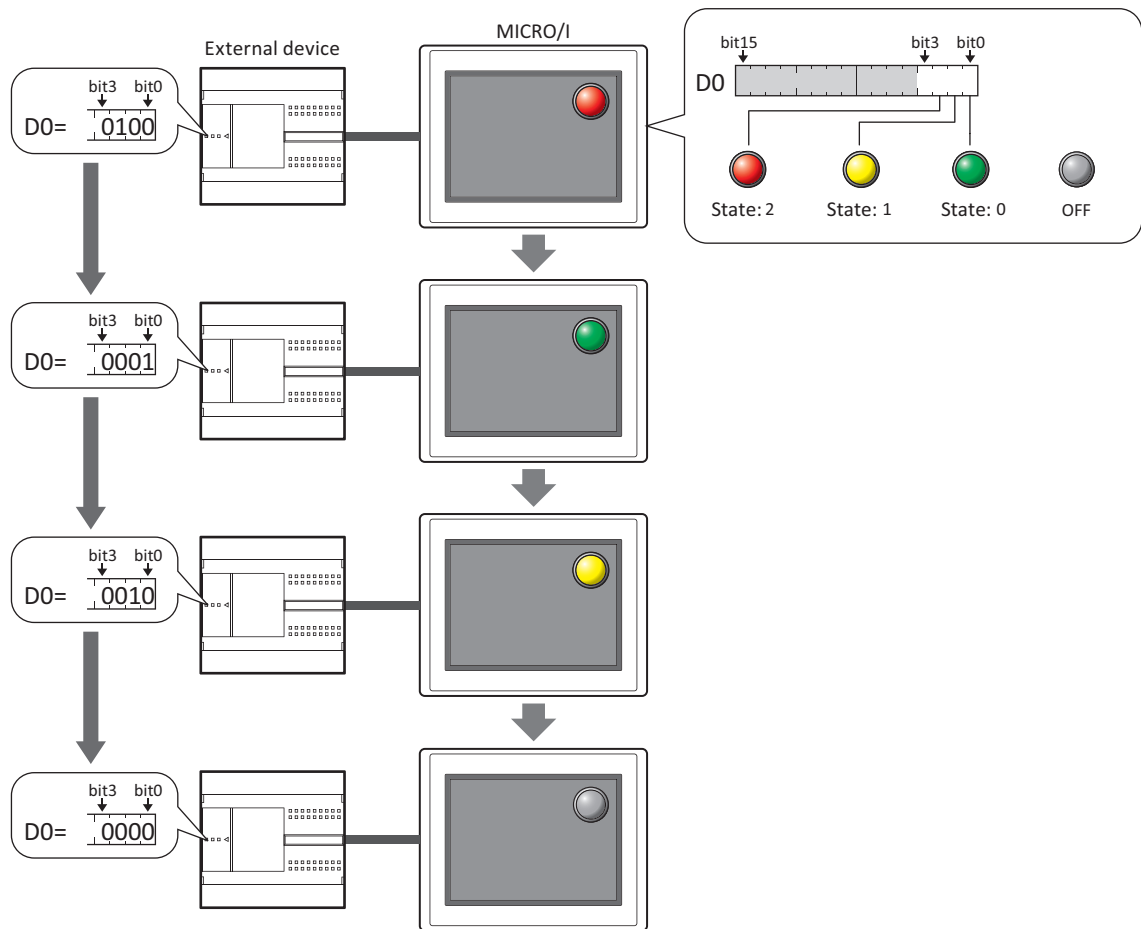

The conditions to display the picture set by the OFF state on the screen are as follows.

- **Y** is selected under **Flash** on the **State** tab and the trigger condition is not satisfied.
- **Switching Method** on the **General** tab is **Bit Number**, and the all bit in the device address are 0 or a bit not allocated a picture is 1.
- **Switching Method** on the **General** tab is **Value**, and the value of device address is a number not allocated a picture.

2.2 Multi-State Lamp Configuration Procedure

This section describes the configuration procedure for Multi-State Lamps.

- 1 On the **Home** tab, in the **Parts** group, click **Lamps**, and then click **Multi-State Lamp**.

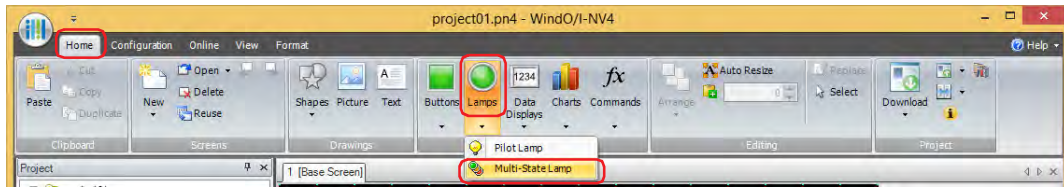

- 2 Click a point on the edit screen where you wish to place the Multi-State Lamp.
- 3 Double-click the placed Multi-State Lamp and a Properties dialog box will be displayed.
- 4 Change the settings on each tab as necessary.

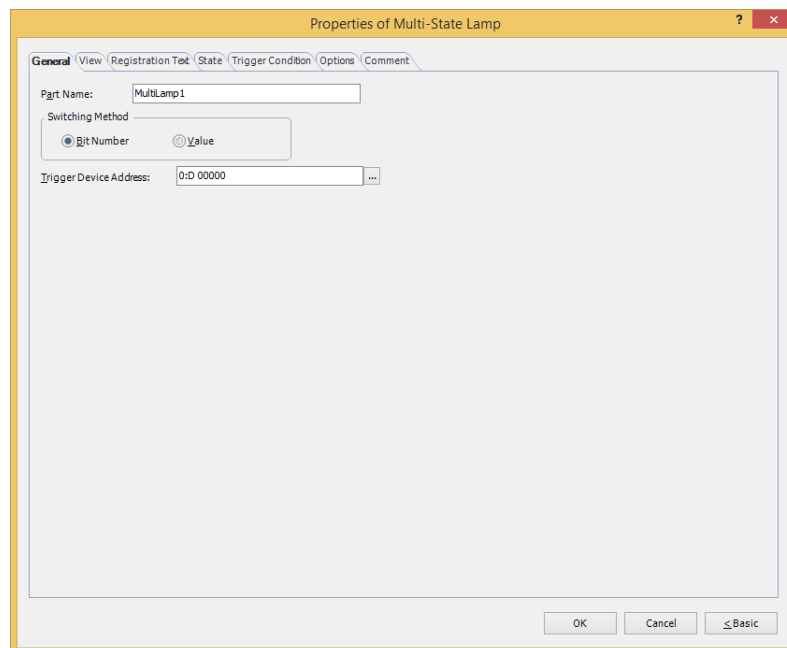

The **Options** tab only appears in Advanced mode.



You can set the default for the Multi-State Lamp on the **Default Preferences** tab of the **WindO/I-NV4 Options** dialog box. For details, refer to Chapter 2 "Default Preferences Tab" on page 2-63.

2.3 Properties of Multi-State Lamp Dialog Box

This section describes items and buttons on the properties dialog box.

● General Tab

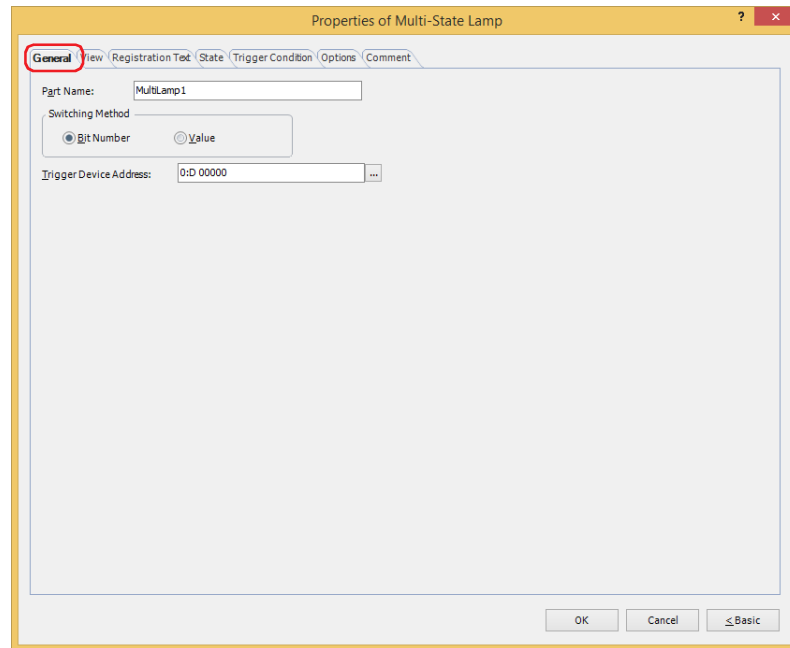

■ Part Name

Enter a name for the part. The maximum number is 20 characters.

■ Switching Method

Specify the method to switch drawing objects from the following:

Bit Number: Switches the drawing object displayed, according to the status of the bits.

Example 1: **Bit Number** is selected. The bits triggered in device address D0 corresponds to the following pictures and the OFF state is **None**.

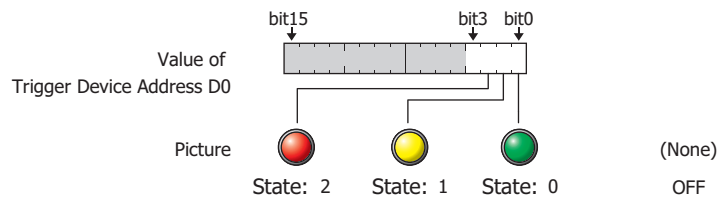

Switches the picture to display according to the status of the bits.

Bit state of Trigger Device Address D0	0001	0010	0100	1000	1110	1100
Picture to display	 State: 0	 State: 1	 State: 2		 State: 1	 State: 2
Action	Display picture for bit 0	Display picture for bit 1	Display picture for bit 2	No picture	Display picture for bit 1	Display picture for bit 2

If multiple bits are 1, display the picture for the lowest order bit.

If all bits in the device address are 0 or if a bit with no associated picture becomes 1, display nothing.

Example 2: **Bit Number** is selected. The bits of trigger device address D0 and the OFF state are allocated to the following pictures.

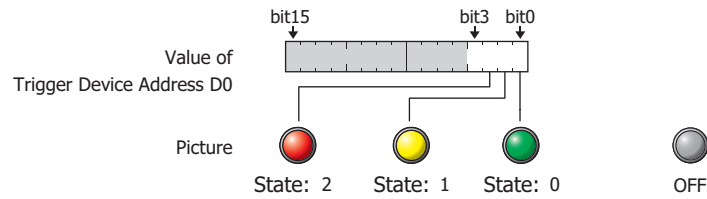

Switches the picture to display according to the status of the bits.

Bit state of Trigger Device Address D0	0001	0010	0100	1000	1110	1100
Picture to display	State: 0	State: 1	State: 2	OFF	State: 1	State: 2
Action	Display picture for bit 0	Display picture for bit 1	Display picture for bit 2	Display picture for OFF state	Display picture for bit 1	Display picture for bit 2

If multiple bits are 1, display the picture for the lowest order bit.

If all bits in the device address are 0 or if a bit with no associated picture becomes 1, display the picture for OFF state.

Value: Switches the drawing object displayed, according to the value of the device address.

Example 3: Value is selected. The value assigned to the trigger device address D0 are allocated to the following pictures and the OFF state is **None**.

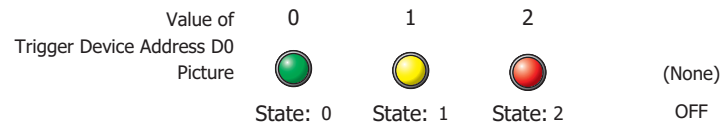

Switches the picture to display according to the value of the device address.

Value of Trigger Device Address D0	0	1	2	3
Picture to display	State: 0	State: 1	State: 2	
Action	Display picture for 0	Display picture for 1	Display picture for 2	No picture

If the value of device address has no picture associated with it, display nothing.

Example 4: Value is selected. The values assigned in trigger device address D0 and the OFF state are allocated to the following pictures.

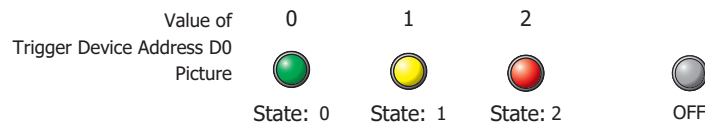

Switches the picture to display according to the value of the device address.

Value of Trigger Device Address D0	0	1	2	3
Picture to display	State: 0	State: 1	State: 2	OFF
Action	Display picture for 0	Display picture for 1	Display picture for 2	Display picture for OFF state

If the value of device address has no picture associated with it, display the picture for OFF state.

■ Trigger Device Address

Specifies the word device to use as the condition for switching the drawing object.

Click  to display the Tag Editor. For the device address configuration procedure, refer to Chapter 2 "5.1 Device Address Settings" on page 2-70.

● View Tab

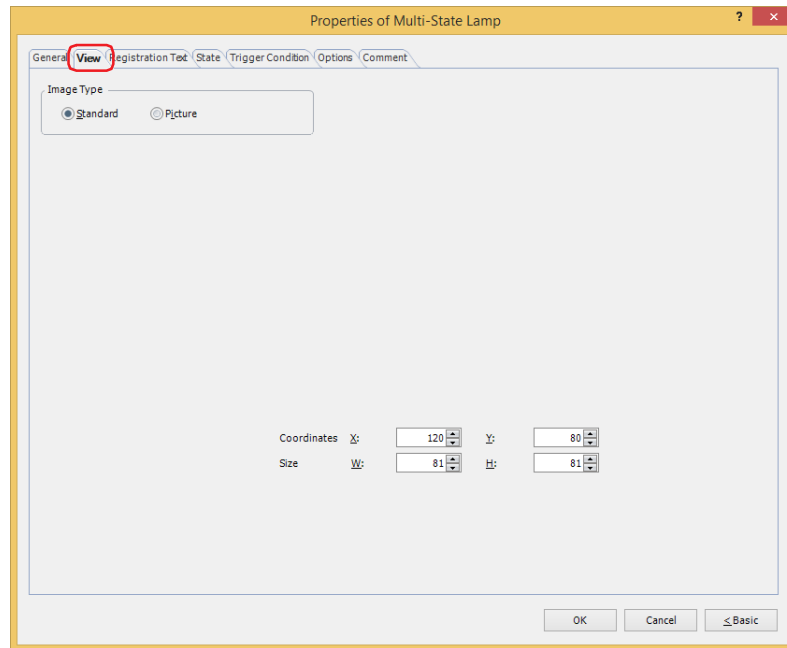

■ Image Type

Select the type of graphic to be used to represent the part.

Standard: Uses the default graphic for WindO/I-NV4.

Picture: Uses an image file saved using Picture Manager.
For details about image file restrictions, refer to Chapter 2 "1.4 Available Image Files" on page 2-20.

■ Coordinates

X, Y: Sets the display position of parts using coordinates.

The X and Y coordinates of parts is defined relative to an origin at the top-left corner of the screen.

X: 0 to (base screen horizontal size - 1)

Y: 0 to (base screen vertical size - 1)

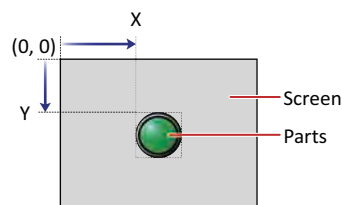

■ Size

Sets width and height to define the size of parts. The minimum size varies based on the item selected for Image Type.

Standard: The minimum size varies based on the selected item and the maximum size is a base screen size.

Picture: W: 2 to (base screen horizontal size)

H: 2 to (base screen vertical size)

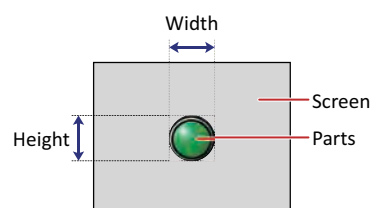

● Registration Text Tab

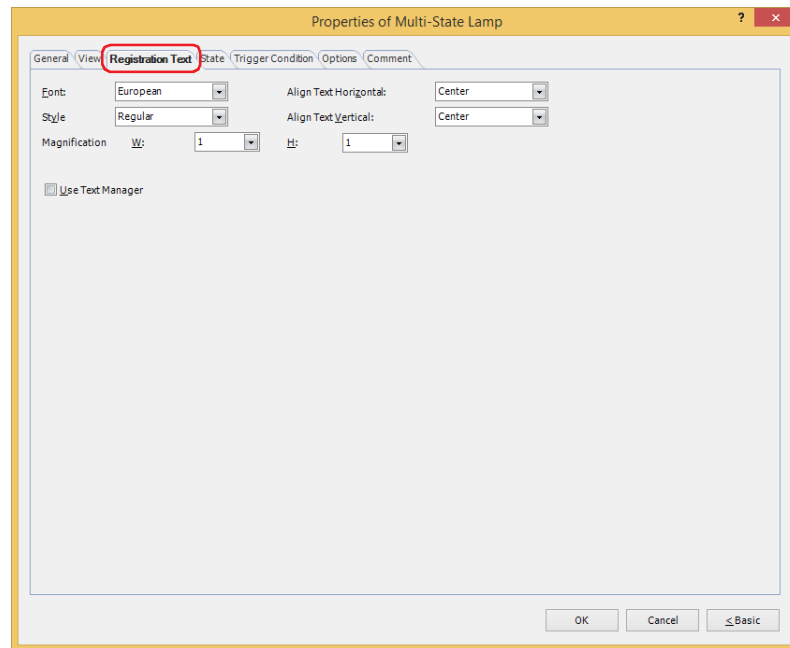

■ Font

Selects the font used for displaying text from the following.

Western, Japanese, Simplified Chinese, Traditional Chinese, Hangul, Central European, Baltic, Cyrillic, Windows, Stroke^{*1}

Can only be set when the **Use Text Manager** check box is cleared.

The characters that can be displayed depend on the font. For details, refer to Chapter 2 “1.2 Available Text” on page 2-6.

■ Style^{*1}

Selects **Regular** or **Bold** for text style.

Can only be set when **Font** is set to **Western, Japanese, Simplified Chinese, Traditional Chinese, Hangul, Central European, Baltic, Cyrillic**.

■ Size

Specifies the text size to be displayed. The fonts and sizes that can be set vary based on the model.

Model	Font	Size
HG2J-7U	Western, Japanese, Simplified Chinese, Traditional Chinese, Hangul, Central European, Baltic, Cyrillic	8 to 512
HG5G/4G/3G/2G-V, HG4G/3G, HG2G-5F/-5T, HG1G/1P	Stroke	8 to 128

■ Magnification^{*1}

W, H: Selects the magnification (0.5, 1 to 8) for text display.

Can only be set when **Font** is set to **Western, Japanese, Simplified Chinese, Traditional Chinese, Hangul, Central European, Baltic, Cyrillic**.

■ Align Text Horizontal

Selects text alignment in the horizontal direction.

Left, Center, Right, Center-Left

For details, refer to Appendix “5 Text Alignment” on page A-7.

*1 HG5G/4G/3G/2G-V, HG4G/3G, HG2G-5F/-5T, HG1G/1P only

- **Align Text Vertical**

Selects text alignment in the vertical direction.

- **Top, Center, Bottom**

This option can only be configured when **Left**, **Center**, or **Right** is selected for **Align Text Horizontal**. If **Center-Left** is selected for **Align Text Horizontal**, **Center-Top** is set as this option.

For details, refer to Appendix "5 Text Alignment" on page A-7.

- **Use Text Manager**

Select this check box if using the text registered in Text Manager for text display.

● State Tab

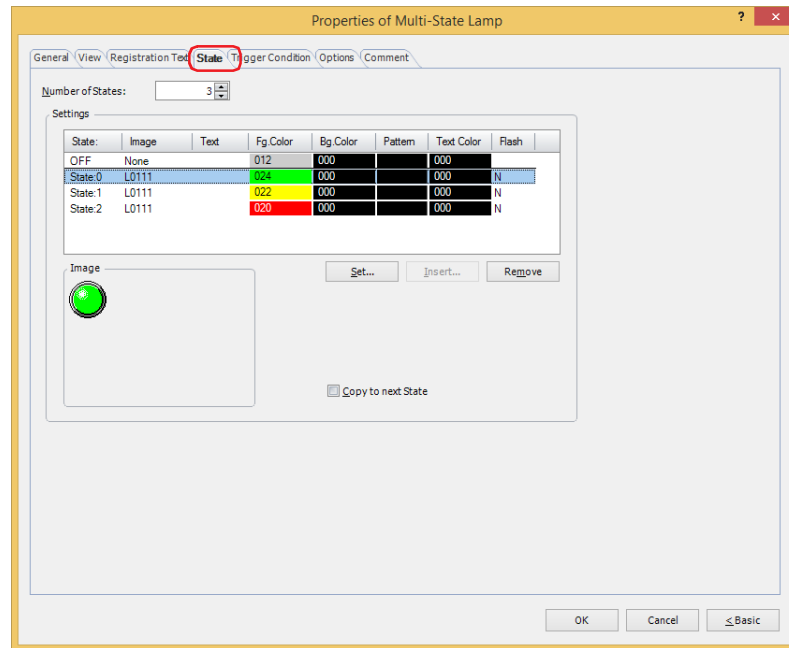

■ Number of States

Specify the number of drawing objects (1 to 16) to display by switching.

■ Settings

Lists the state settings. The list shows various settings such as the state number and file name for the drawing object.

State: Shows the OFF state and state number.

Double clicking the cell displays the **State Settings** dialog box where you can edit the state settings. For details, refer to "State Settings Dialog Box" on page 9-27.

Image: Shows the name or a file name for a drawing object.

Double clicking the cell opens the View Browser if **Standard** is selected under Image Type on the **View** tab, or Picture Manager if **Picture** is selected. This allows you to change the drawing object to display.

Text: Shows the registration text.

Double clicking the cell allows you to edit the Registration Text.

Can only be set when the **Use Text Manager** check box is cleared.

Text ID: Shows the Text ID.

Double clicking the cell displays the Text Manager where you can change the Text ID.

Can only be set when the **Use Text Manager** check box is selected.

Fg.Color, Bg.Color: Shows the foreground and background colors for standard images.

Double clicking the cell opens the Color Palette where you can change the foreground and background colors. This setting can only be changed if Image Type is set to **Standard** on the **View** tab.

- Pattern:** Shows the pattern or tonal gradation for standard images. Double clicking the cell opens the Pattern Palette where you can change the pattern or tonal gradation of the image. This setting can only be changed if Image Type is set to **Standard** on the **View** tab.
- Text Color:** Shows the color of the registration text. Double clicking the cell opens the Color Palette where you can change the color of the text.
- Flash:** Indicates whether to display the drawing object flashing or constantly lit. Double clicking the cell toggles between **Y** for yes and **N** for no. If **Y** is selected, the picture which corresponds to a bit state or value of device is alternately shown and hidden at a fixed time interval. However, if the OFF state is set, the picture that corresponds to a bit state or value of device and the picture set for the OFF state are alternately displayed at a fixed time interval.

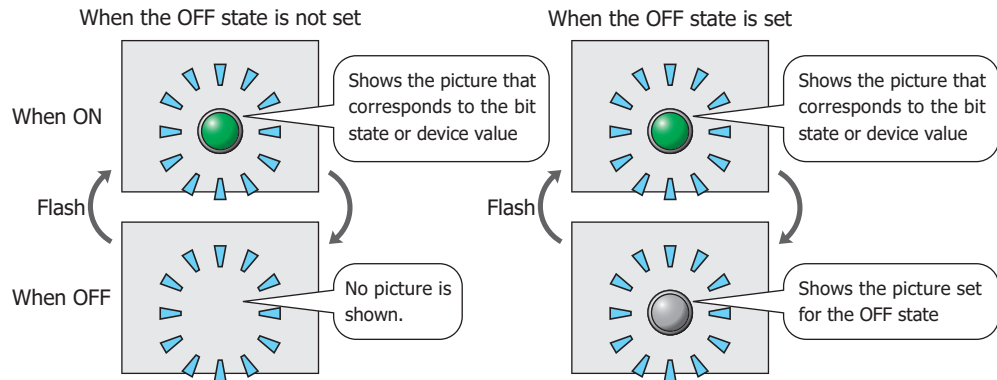

- Windows Font:** Shows the currently set Windows Font. Double clicking the cell displays the **Font Settings** dialog box where you can change the Windows Font. This setting can only be changed when **Windows** is selected for **Font** on the **Registration Text** tab.
- Line Spacing:** Shows the line spacing for Windows Font. Double clicking the cell allows you to change the line spacing (0 to 100). This setting can only be changed when **Windows** is selected for **Font** on the **Registration Text** tab.
- Character Pitch:** Shows the character spacing for Windows Font. Double clicking the cell allows you to change the character spacing (0 to 100). This setting can only be changed when **Windows** is selected for **Font** on the **Registration Text** tab.
- Set:** Registers the state settings to the list. If you select the OFF state or state number that is already registered, that number is overwritten with the new settings. Click this button to display the **State Settings** dialog box. For details, refer to "State Settings Dialog Box" on page 9-27.
- Insert:** Inserts the settings in the position selected on the list. Select a state number in the list and click this button to display the **State Settings** dialog box. The settings at the insertion point shift down one line. Settings cannot be inserted if all state numbers are configured.
- Remove:** Deletes the registered settings from the list. Select the OFF state or state number and click this button to delete the selected settings from the list.

■ Image

Shows the image for the OFF state or state number selected in the **Settings** list.

■ Copy to next State

Select this check box to register or change all state settings at once.

This option copies the current settings to all state numbers after the selected state number when the settings are set or changed. This option can only be set when a state number is selected.

State Settings Dialog Box

This dialog box sets the drawing object and registration text to display.

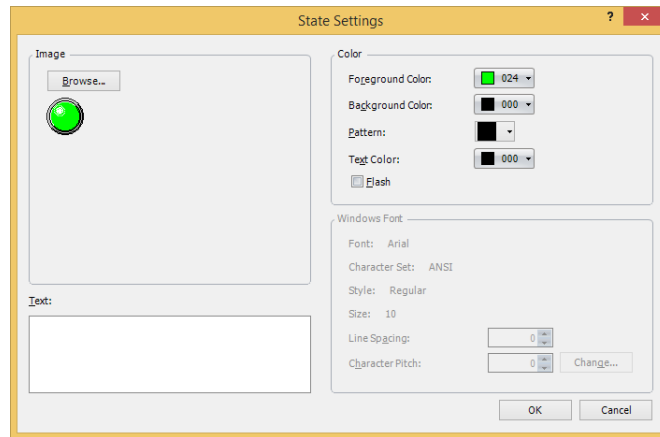

■ Image

Browse: Select the drawing object to use for the lamp part. Clicking this button opens the View Browser if **Standard** is selected under Image Type on the **View** tab, or Picture Manager if **Picture** is selected.

Image: Shows the selected drawing object.

■ Text

Enter the text to display. The maximum number is 3,750 characters.

The characters that can be entered depends on the font selected for **Font** on the **Registration Text** tab. For details, refer to Chapter 2 "1.2 Available Text" on page 2-6.

This setting is only enabled when the **Use Text Manager** check box is cleared on the **Registration Text** tab.

■ Text ID

To use the text registered in the Text Manager, specify the ID number from 1 to 32000.

This setting is only enabled when the **Use Text Manager** check box is selected on the **Registration Text** tab.

■ Color

Foreground Color, Background Color:

Select the foreground and background color to use for standard images (color: 256 colors, monochrome: 16 shades).

Clicking button opens the Color Palette. Select a color from the Color Palette.

Pattern: Select the pattern or tonal gradation for a standard image.

Clicking this button opens the Pattern Palette. Select a pattern or tonal gradation from the Pattern Palette.

Text Color: Select the text color (color: 256 colors, monochrome: 16 shades) for the registration text. Clicking this button opens the Color Palette. Select a color from the Color Palette.

Flash: Select this check box to make the picture flash (alternately show and hide the picture that corresponds to the bit state or device value at a fixed time interval).

The flashing interval can be set with the **Flashing Cycle** setting on the **System** tab of the **Project Settings** dialog box. This option cannot be set for the OFF state.

■ Windows Font

Specify the Windows Font to use.

The current settings are displayed by selecting **Windows** in the **Font** property on the **Registration Text** tab. You can specify the character spacing (0 to 100) and the line spacing (0 to 100). To change the settings other than the character spacing and line spacing, click **Change** to display the **Font Settings** dialog box.

The text ID setting is only enabled if the **Use Text Manager** check box is cleared.

For details, refer to Chapter 2 "Windows Font" on page 2-13.

● **Trigger Condition Tab**

The **Trigger Condition** tab is displayed in Advanced mode.

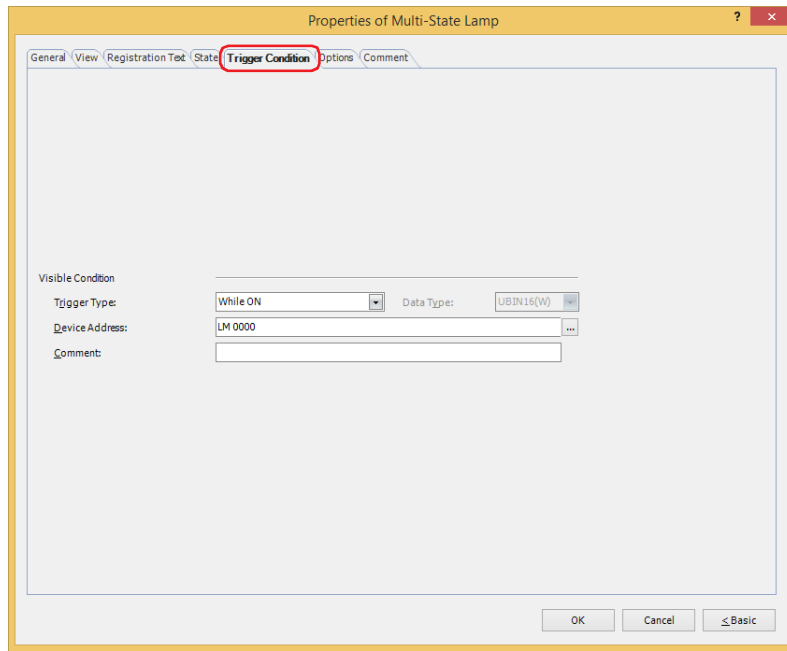

■ **Visible Condition**

The Multi-State Lamp is displayed while the condition is satisfied. The Multi-State Lamp is hidden while the condition is not satisfied.

Example: When **Trigger Type** is **While ON** and **Device Address** is **LM0**

While LM0 is 0, the condition is not satisfied and the Multi-State Lamp is hidden.
 While LM0 is 1, the condition is satisfied and the Multi-State Lamp is displayed.

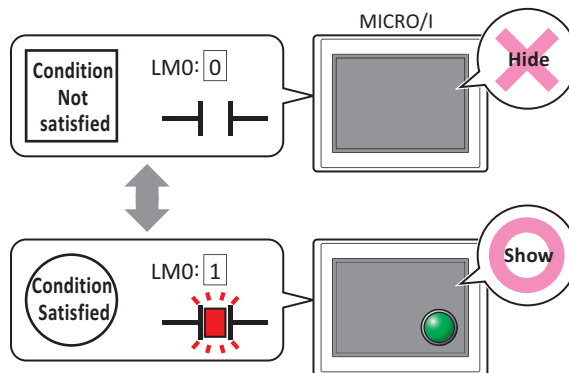

Trigger Type: Selects the condition to display the Multi-State Lamp from the following.

Always visible: The Multi-State Lamp is always displayed.

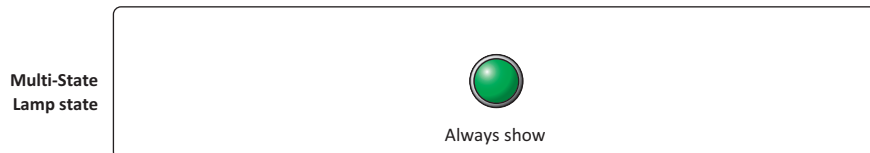

While ON: Displays the Multi-State Lamp when the value of device address is 1.

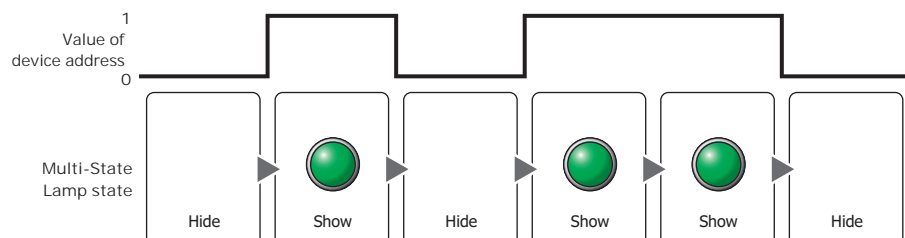

While OFF: Displays the Multi-State Lamp when the value of device address is 0.

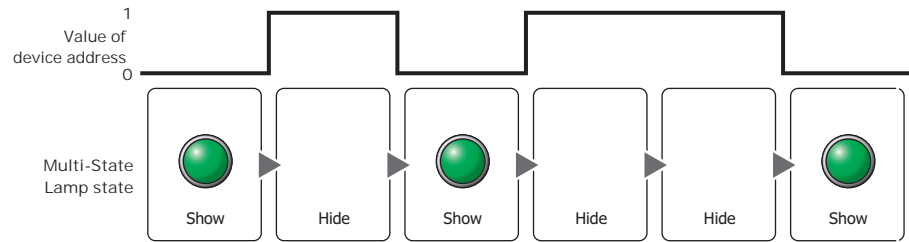

While satisfying the condition:

Displays the Multi-State Lamp when the condition is satisfied.

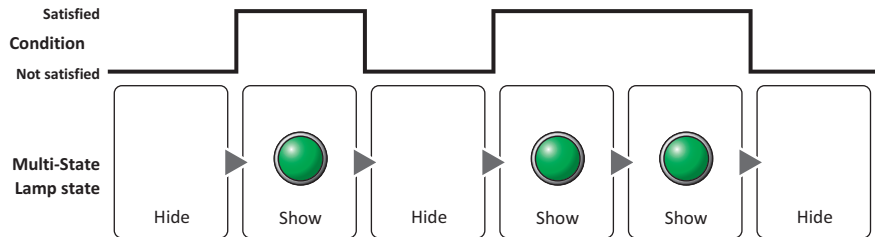

- Data Type:** Selects the type of data handled by the conditional expression for the visible condition. This option can only be configured if **While satisfying the condition** is selected for **Trigger Type**. For details, refer to Chapter 2 “1.1 Available Data” on page 2-1.
- Device Address:** Specifies the bit device or the bit number of the word device to serve as the visible condition. This option can only be configured when **While ON** or **While OFF** is selected for **Trigger Type**. Click to display the Tag Editor. For the device address configuration procedure, refer to Chapter 2 “5.1 Device Address Settings” on page 2-70.
- Condition:** Specifies the conditional expression for the visible condition. This option can only be configured when **While satisfying the condition** is selected for **Trigger Type**. Click to display the **Trigger Condition Settings** dialog box. For the conditional expression configuration procedure, refer to Chapter 2 “5.2 Setting Conditional Expressions” on page 2-73.
- Comment:** Used for entering a comment for the visible condition. The maximum number is 80 characters.

● **Options Tab**

The **Options** tab is displayed in Advanced mode.

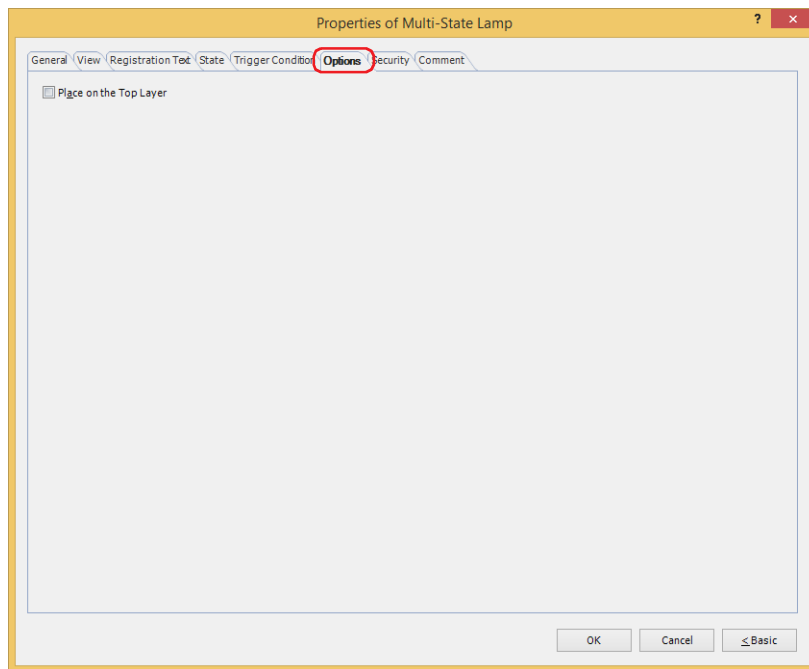

■ **Place on the Top Layer**

Select this check box to display the parts on the top layer. The parts will have precedence when other drawings and parts are overlapping with it. For details, refer to Chapter 6 “4 Drawings and Parts Overlapping” on page 6-5.

● Security Tab

This tab is used to restrict displaying and using the part by security groups.

This option can only be set when **Use Security functions** is selected. The **Use Security functions** check box is set on **General** tab in the **Security** dialog box.

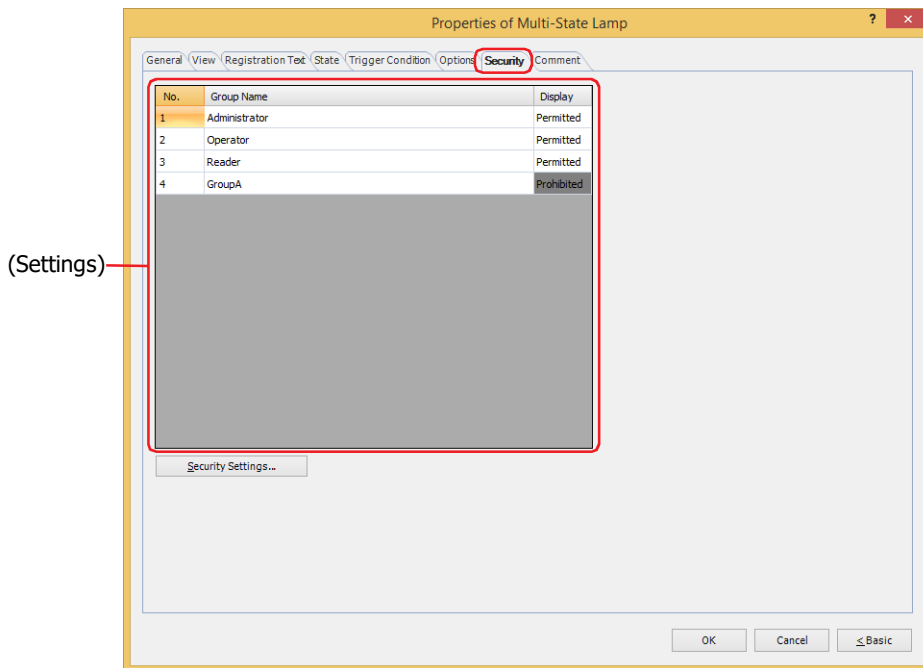

■ (Settings)

Displays the list of security groups used on the MICRO/I.

No.: Displays the security group numbers (1 to 15).

Group Name: Displays the name of the security group.

Display: Displays whether or not there is permission to display the part. Only **Permitted** security groups can display this part. If all security groups are set to **Permitted**, this part will be displayed even if no user account has been selected. Double clicking the cell switches between **Permitted** and **Prohibited**.



You can also switch between **Permitted** and **Prohibited** by right-clicking on a **Display** cell.



■ Security Settings

The Security Settings dialog box is displayed. If you create a security group in the **Security Settings** dialog box, you can select that created group. For details, refer to Chapter 23 "2.2 Adding and Editing Security Groups" on page 23-19.



For details about security functions, refer to Chapter 23 "User Accounts and the Security Function" on page 23-1.

Example: If the user and security group for a part are set as follows:

User Name	 User1	 User2
Security Group	Reader	Operator

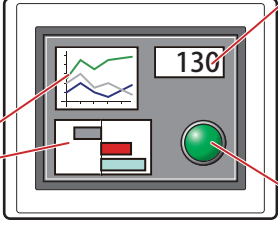

Numerical Display

No.	Group Name	Display
1	Administrator	Permitted
2	Operator	Permitted
3	Reader	Permitted

Line Chart and Bar Chart

No.	Group Name	Display
1	Administrator	Permitted
2	Operator	Permitted
3	Reader	Prohibited

Multi-State Lamp

No.	Group Name	Display
1	Administrator	Permitted
2	Operator	Permitted
3	Reader	Prohibited

For User1 in the **Reader** security group, the parts for which **Display** has been set to **Prohibited** for **Reader** will not be displayed.

If the password screen is opened and the user switches to User2 in the **Operator** security group, the parts for which **Display** has been set to **Permitted** for **Operator** will be displayed.

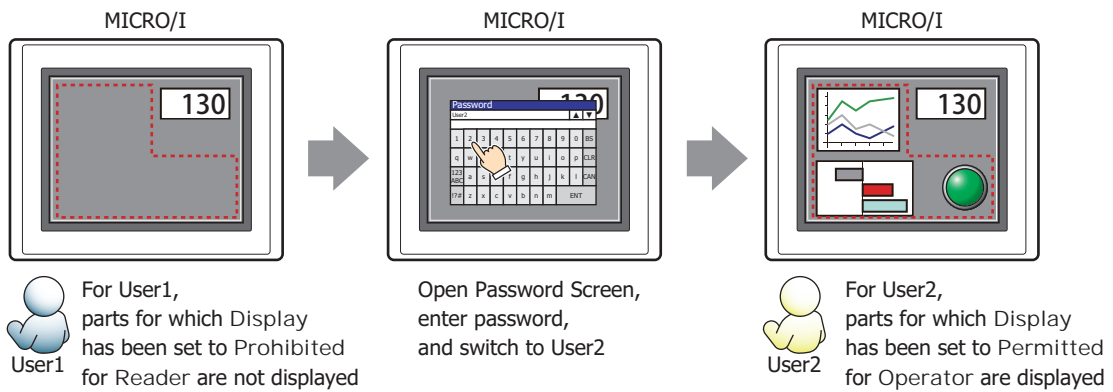

● Comment Tab

The **Comment** tab is used to specify the parts placed on the editing screen, and the popup text displayed when the mouse pointer is placed close to **No.**, **Name**, or **Type** in the object list.



When there are multiple parts of the same shape on the screen, this feature makes it possible to distinguish between the parts without displaying the Properties dialog box for each part, by just mousing over the part.

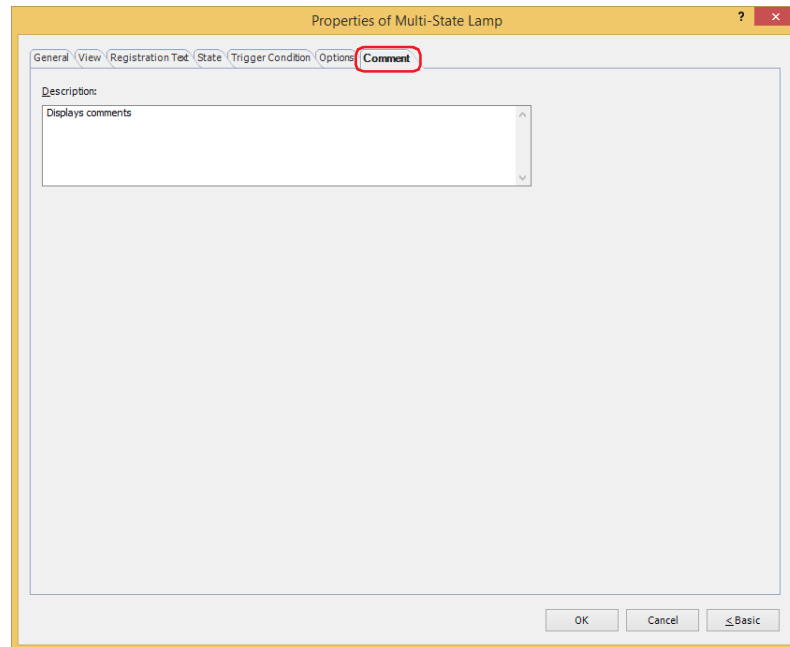

■ Description

Used for entering comments about parts. The maximum number is 80 characters.

Example: When mousing over the Multi-State Lamp on the editing screen



Chapter 10 Data Displays

This chapter describes how to configure the Data Display parts and their operation on the MICRO/I.

1 Numerical Input

HG2J-7U HG5G-V HG4G-V HG4G HG3G-V HG3G HG2G-V HG2G-5F HG2G-5T HG1G HG1P

1.1 How the Numerical Input is Used

The Numerical Input features a display mode that displays the current value of a device address and an entry mode that enters a value using the keypad or key buttons and writes that value to a device address. When the part is displayed on the screen, the Numerical Input is in display mode. To enter a value by pressing the keypad or key buttons, touch the Numerical Input to switch it to entry mode. In entry mode, the value of device address is displayed until a value is entered.

The Numerical Input can perform the following functions.

- Write a value entered with the keypad or key buttons to a device address

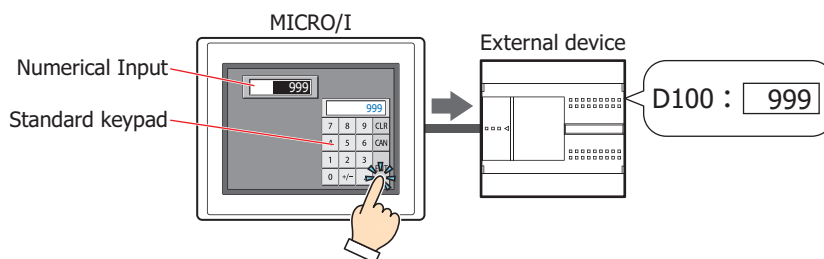

- Display the current value of a device address

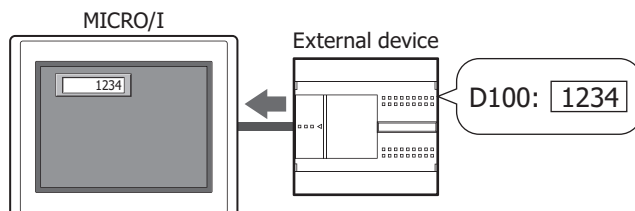

- Enter and display decimal numbers

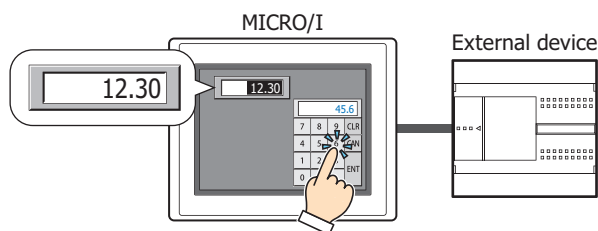

- Display the entered value as * (asterisk)

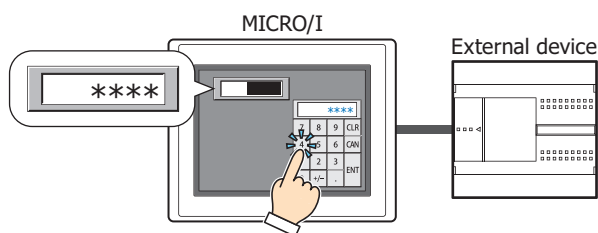

1.2 Numerical Input Configuration Procedure

This section describes the configuration procedure for Numerical Inputs.

- 1 On the **Home** tab, in the **Parts** group, click **Data Displays**, and then click **Numerical Input**.

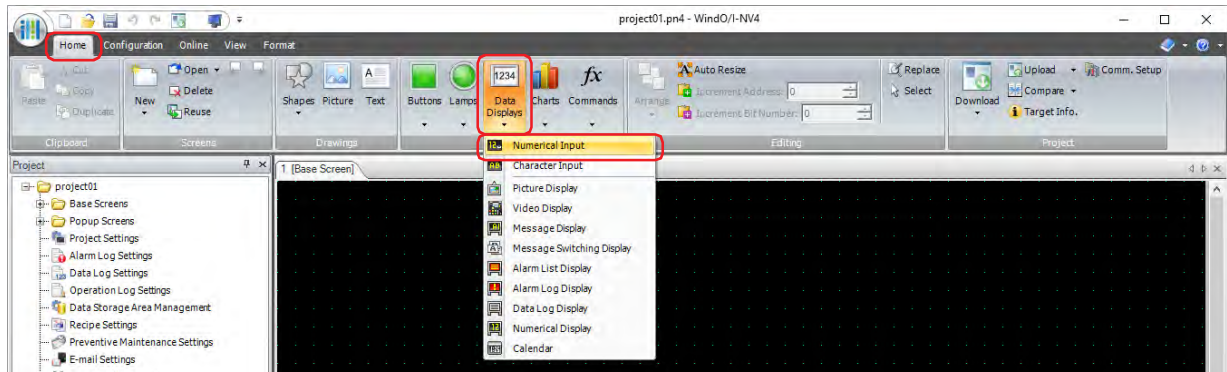

- 2 Click a point on the edit screen where you wish to place the Numerical Input.
- 3 Double-click the placed Numerical Input and a Properties dialog box will be displayed.
- 4 Change the settings on each tab as necessary.

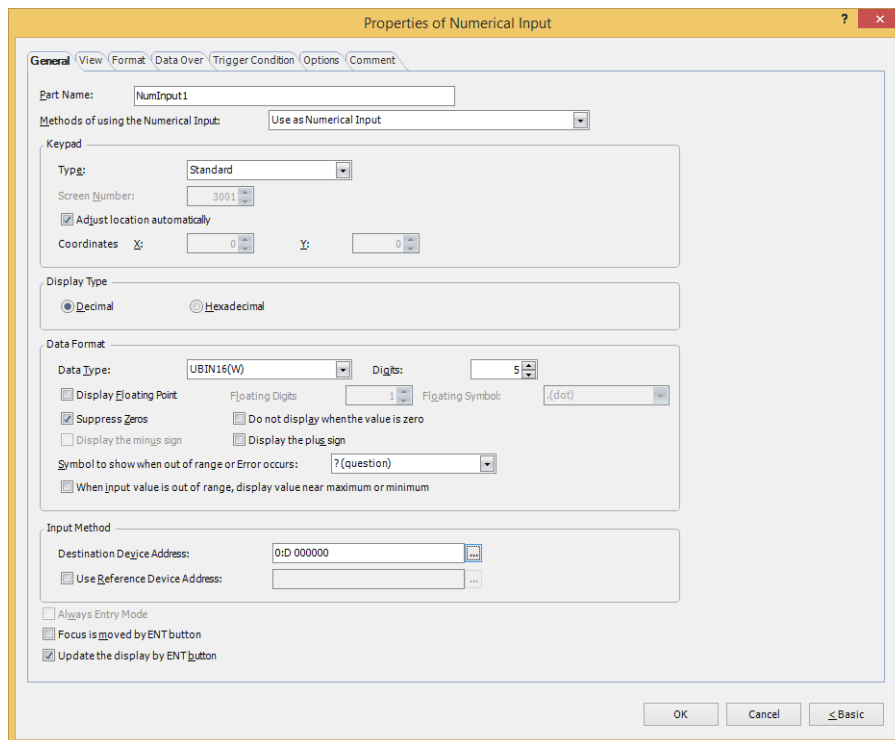

The **Data Over** tab, **Trigger Condition** tab and **Options** tab only appear in Advanced mode.



You can set the default for the Numerical Input on the **Default Preferences** tab of the **WindO/I-NV4 Options** dialog box. For details, refer to Chapter 2 "Default Preferences Tab" on page 2-63.

1.3 Properties of Numerical Input Dialog Box

This section describes items and buttons on the properties dialog box.

● General Tab

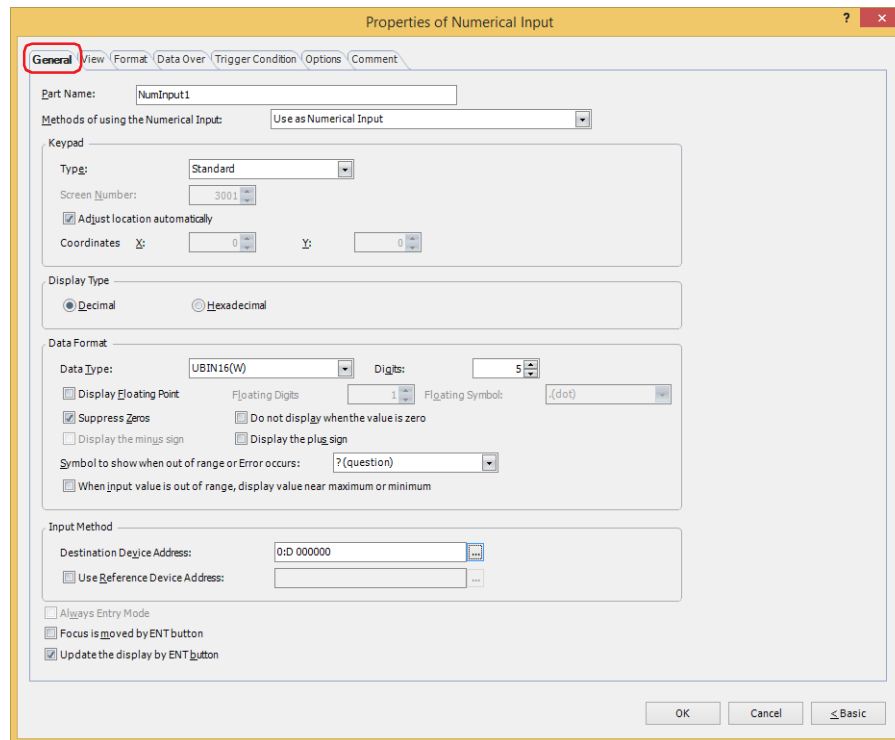

■ Part Name

Enter a name for the part. The maximum number is 20 characters.

■ Methods of using the Numerical Input

Selects how to use the Numerical Input:

- | | |
|---|--|
| Use as Numerical Input: | Uses the Numerical Input to enter or display values. |
| Use as Display for Keypad: | Uses the Numerical Input as a part to display the value entered with a Keypad. |
| Display the Minimum value specified with Data Over: | Uses the Numerical Input as a part to display the minimum value of a Numerical Input switched to input mode. |
| Display the Maximum value specified with Data Over: | Uses the Numerical Input as a part to display the maximum value of a Numerical Input switched to input mode. |

■ Keypad

Configures the keypad for entering values in the Numerical Input.

- Type: According to the location where the keypad is configured, selects the type from the following.
- Standard: Uses the standard keypad. The standard keypad is the keypad configured as the popup screen for the standard keypad (screen number 3000 to 3015). This is the keypad for the type configured by **Display Type**.
 - Popup: Uses a keypad configured as a popup screen.
 - Current Screen: Uses the keypad configured on the same screen as the Numerical Input.
- Screen Number: Specifies the screen number of the popup screen configured as the keypad (1 to 3015). This option can only be configured if **Popup** is selected for **Type**.
- Adjust location automatically: Select this check box to display the popup screen configured as the keypad in a location where it will not overlap the Numerical Input. This option can only be configured if **Standard** or **Popup** is selected for **Type**.
- Coordinates X, Y: Specifies the display location of the popup screen configured as the keypad. With the upper-left corner of the screen as the origin, the X and Y coordinates are the upper-left corner of the popup screen. This option can only be configured when **Standard** or **Popup** is selected for **Type** and the **Adjust location automatically** check box is cleared. Specify the coordinates in 1 dot units.
X: 0 to (base screen horizontal size - 1)
Y: 0 to (base screen vertical size - 1)

■ Display Type

Selects the display type for the value as **Decimal** or **Hexadecimal**.

■ Data Format

- Data Type: Selects the type of data for the value. For details, refer to Chapter 2 "1.1 Available Data" on page 2-1.
- Digits: Specifies the digits to display. The range of digits that can be set varies based on the display type and data type. The digits that can be set are as follows.

Display Type	Data Type	Digits
Decimal display	UBIN16(W), BIN16(I)	1 to 5
	UBIN32(D), BIN32(L)	1 to 10
	BCD4(B)	1 to 4
	BCD8(EB)	1 to 8
	Float32(F)	1 to 10
Hexadecimal display	UBIN16(W)	1 to 4
	UBIN32(D)	1 to 8

Display Floating Point: Select this check box to display the decimal point.



If **Data Type** is **UBIN16(W)**, **BIN16(I)**, **UBIN32(D)**, **BIN32(L)**, **BCD4(B)**, or **BCD8(EB)** and the **Display Floating Point** check box is selected, a decimal value will be displayed on the Numerical Input when a decimal value is entered on the keypad in entry mode, but an integer is written to the device address. In display mode, source data is an integer, but the value is displayed with a decimal point added at the number of floating digits configured for the Numerical Input.

However, if **Float32(F)** is selected for **Data Type**, both the destination data and the source data are decimal values.

Example: When **Display Type** is configured as **Decimal**, **Data Type** is **UBIN16(W)**, the **Display Floating Point** check box is selected, **Digits** is 5, **Floating Digits** is 3, and **Destination Device Address** is D100

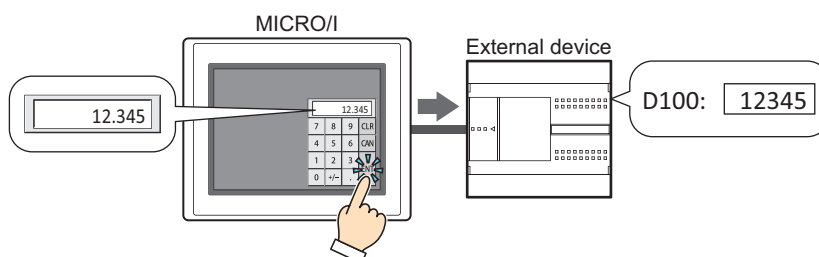

Floating Digits: Specifies the number of digits for the fractional part of the decimal value out of the number of digits specified by **Digits**.
This option can only be configured when the Display Floating Point check box is selected. The range of digits that can be set for the fractional part varies based on the display type and data type. The range of digits that can be set for the fractional part is as follows.

Display Type	Data Type	Floating Digits
Decimal display	UBIN16(W), BIN16(I)	1 to Digits
	UBIN32(D), BIN32(L)	1 to Digits
	BCD4(B)	1 to Digits
	BCD8(EB)	1 to Digits
	Float32(F)	1 to Digits or 8
Hexadecimal display	UBIN16(W)	--
	UBIN32(D)	--

Floating Symbol*1: Selects the decimal point symbol from the following.
.(dot), :(colon), ;(semicolon), ,(comma), /(slash)
This option can only be configured when the **Display Floating Point** check box is selected.
Example: When **Digits** is 4 and **Floating Digits** is 2
When **Floating Symbol** is **.(dot)** 12.34
When **Floating Symbol** is **/(slash)** 12/34



Floating Symbol is not reflected on the standard keypad. To change the decimal point symbol on the standard keypad, please change the keypad button.

Suppress Zeros: Select this check box to hide "0" for the upper digits of the integer part.
Example: **Suppress Zeros** selected: 1234
Suppress Zeros cleared: 00001234

Do not display when the value is zero: Select this check box to show a blank display if the value is "0".



- If the value is zero and it is not displayed, the unit set on the **Format** tab is also not displayed.
- Even if the **Do not display when the value is zero** check box is selected, "0" is displayed when the value is not 0.

Display the minus sign: Select this check box to display the - (negative) sign when displaying negative values. This option can only be configured when **Decimal** is selected for **Display Type**.
Display the plus sign: Select this check box to display the + (positive) sign when displaying positive values. This option can only be configured when **Decimal** is selected for **Display Type**.

Symbol to show when out of range or Error occurs:

Selects the following symbols to be displayed when a value exceeding the **Data Type** in the **General** tab or the **Range** in the **Data Over** tab is entered, or an error occurs.
"? (question mark)", " (space)", "# (pound)", "% (percent)", "\$ (dollar)", "- (minus)", "@ (at sign)", "\" (backslash)", "*" (asterisk)", "! (exclamation mark)", "+" (plus)"



In the following cases, it is handled as an error and the symbol selected in **Symbol to show when out of range or Error occurs** is displayed.

- If the **Data Type** is **BCD4(B)**, **BCD8(EB)**, or **Float32(F)** and the value entered in device address doesn't comply with the data type.
- If a value entered in the Numerical Input exceeds the maximum or minimum of the Data Over.
- A value that exceeds the maximum numeric value that can be processed with the data type selected for **Data Format** was entered with the input mode of the Numerical Input.
- If a value divided by zero operation was executed with **Display with Arithmetic Operation** on the **Options** tab.

*1 Advanced mode only

When input value is out of range, display value near maximum or minimum *1:

Select this check box to display the nearest value of the minimum or maximum when a value out of range is entered.

Example: The **When input value is out of range, display value near maximum or minimum** check box is selected, the Value under the **Range** on the **Data Over** tab is selected and the **Minimum** is 0 and the **Maximum** is 10000.

- Enter the value "99999" larger than the maximum

The diagram illustrates the process of entering a value out of range and the system's response. It consists of six stages:

- Display value of device address (Display mode):** The numerical input field shows 1234.
- Press Numerical Input:** A hand presses the '1234' button on the keypad.
- Enter a value:** The numerical input field shows 1234, and the keypad display shows 99999.
- Press ENT:** A hand presses the ENT key. The numerical input field shows 1234, and the keypad display shows 10000.
- Press ENT:** A hand presses the ENT key again. The numerical input field shows 10000, and the keypad display shows 10000.
- Display value of device address (Display mode):** The numerical input field shows 10000.

Action	Display value of device address (Display mode)	Display focus (Entry mode)	Display value of device address (Entry mode)	Corrects the value of device address to maximum value (Entry mode)	Write value to device address (Entry mode)	Display value of device address (Display mode)
Value of Destination Device Address	1234	1234	1234	1234	10000	10000
Numerical Input display	1234	1234	1234	1234	10000	10000
Keypad display	-	1234	99999	10000	10000	-

- Enter the value "-1" smaller than the minimum

The diagram illustrates the process of entering a value out of range and the system's response. It consists of five stages:

- Display value of device address (Display mode):** The numerical input field shows 1234.
- Press Numerical Input:** A hand presses the '1234' button on the keypad.
- Enter a value:** The numerical input field shows 1234, and the keypad display shows -1.
- Press ENT:** A hand presses the ENT key. The numerical input field shows 0, and the keypad display shows 0.
- Display value of device address (Display mode):** The numerical input field shows 0.

Action	Display value of device address (Display mode)	Display focus (Entry mode)	Display value of device address (Entry mode)	Write value to device address (Entry mode)	Display value of device address (Display mode)
Value of Destination Device Address	1234	1234	1234	0	0
Numerical Input display	1234	1234	1234	0	0
Keypad display	-	1234	-1	0	-

*1 Advanced mode only

Input Method

These options specify the destination for entered values.

Destination Device Address: Specifies the word device to write the entered value to.

Click to display the Tag Editor. For the device address configuration procedure, refer to Chapter 2 "5.1 Device Address Settings" on page 2-70.

Use Reference Device Address*1: Select this check box and specify a device address to change the destination word device by the value of this device address.

Click to display the Tag Editor. For the device address configuration procedure, refer to Chapter 2 "5.1 Device Address Settings" on page 2-70.

For details on indirect writing, refer to Chapter 2 "Indirect Read and Indirect Write Settings" on page 2-5.

Always Entry Mode*1

Select this check box to enter values by pressing the keypad and key buttons without touching the Numerical Input displayed on the screen.

To display 0 on the Numerical Input until a value is entered, select the **Start from 0 in Always Entry Mode of Numerical Input** check box on the **System** tab in the **Project Settings** dialog box. To display the value of device address, clear the **Start from 0 in Always Entry Mode of Numerical Input** check box.

This option can only be configured if **Current Screen** is selected for **Type**.

Example: When the **Always Entry Mode** check box is selected and the **Start from 0 in Always Entry Mode of Numerical Input** check box is selected on the **System** tab in the **Project Settings** dialog box

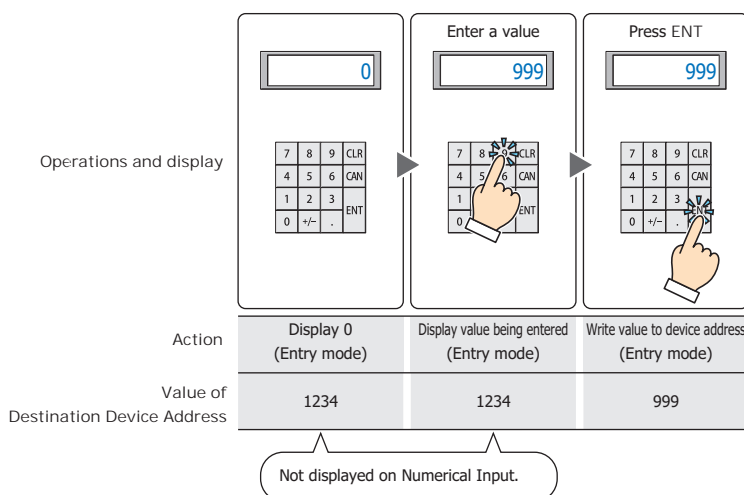

If you use a Numerical Input or a Character Input set to **Always Entry Mode**, other Numerical Input and Character Input configured on the same screen will not work.

Example: When the **Always Entry Mode** check box is cleared

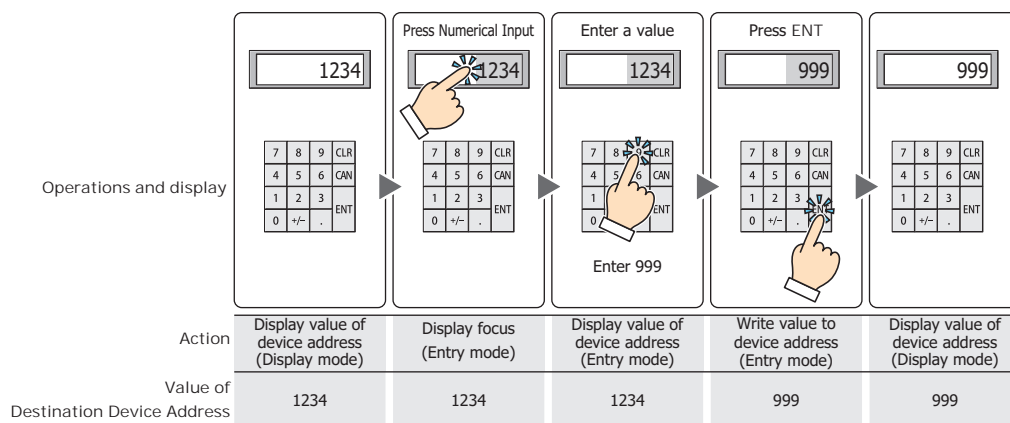

*1 Advanced mode only

■ **Focus is moved by ENT button***1

When multiple Numerical Inputs are configured on the screen, select this check box to continue entering values on each of the Numerical Inputs.

Each time **ENT** is pressed, the focus moves between the Numerical Inputs according to **Focus Order**. On the **View** tab, in the **Screens** group, click **Focus Order**, and then click the Numerical Inputs in the order to move the focus.

Example: When Numerical Input A and B are configured and the **Focus is moved by ENT button** check box for Numerical Input A is selected and the **Focus is moved by ENT button** check box for Numerical Input B is cleared

Numerical Input A action	Display value of device address (Display mode)	Display focus (Entry mode)	Display value of device address (Entry mode)	Write value to device address (Entry mode)	Display value of device address (Display mode)			
Numerical Input B action	Display value of device address (Display mode)				Display focus (Entry mode)	Display value of device address (Entry mode)	Write value to device address (Entry mode)	Display value of device address (Display mode)
Numerical Input A Value of Destination Device Address	1234	1234	1234	999	999	999	999	999
Numerical Input B Value of Destination Device Address	567	567	567	567	567	567	333	333

■ **Update the display by ENT button***1

Select this check box to display the current value unchanged and update the display when a value is entered and **ENT** is pressed.

When this check box is cleared, the display updates with each press of a number button to display the number being entered.

Action	Display value of device address (Display mode)	Display focus (Entry mode)	Display value of device address (Entry mode)	Write value to device address (Entry mode)	Display value of device address (Display mode)
Value of Destination Device Address	1234	1234	1234	999	999
Numerical Input display	1234	1234	1234	999	999
Keypad display	-	1234	999	999	-



When a value outside the input range is entered and **ENT** is pressed, the symbol selected under **Symbol to show when out of range or Error occurs** is displayed. The value is not written to the device address.

*1 Advanced mode only

● View Tab

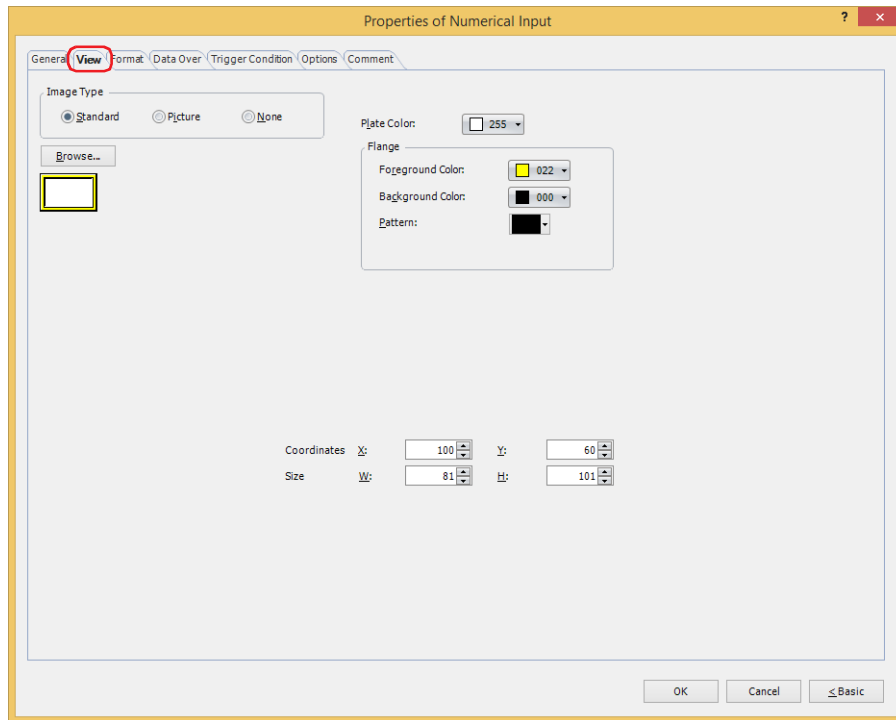

■ Image Type

Select the type of graphic to be used to represent the part.

Standard: Uses the default graphic for WindO/I-NV4.

Picture: Uses an image file saved using Picture Manager.

For details about image file restrictions, refer to Chapter 2 "1.4 Available Image Files" on page 2-20.

None: The plate and the flange of the part are not displayed. Only the text is displayed.

■ Browse

Select the type of graphic to be used to represent the part from the list of graphics. Click this button to display the View Browser or Picture Manager, depending on the setting for **Image Type**.

■ Plate Color

Selects the plate color of the standard graphic (color: 256 colors, monochrome: 16 shades).

Click **Color** to display the Color Palette. Select a color from the Color Palette.

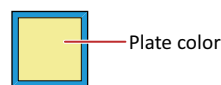

■ Flange

Foreground Color, Background Color: Selects the foreground and background colors of the flange of the standard graphic (color: 256 colors, monochrome: 16 shades).

Click **Color** to display the Color Palette. Select a color from the Color Palette.

Pattern: Selects a pattern for the flange of the standard graphic.

Click **Pattern** to display the Pattern Palette. Select a pattern from the Pattern Palette.



■ Coordinates

X, Y: Sets the display position of parts using coordinates.

The X and Y coordinates of parts is defined relative to an origin at the top-left corner of the screen.

X: 0 to (base screen horizontal size - 1)

Y: 0 to (base screen vertical size - 1)

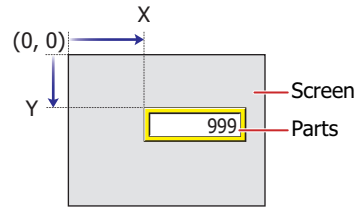

■ Size

W, H: Sets width and height to define the size of parts.

W: 20 to (base screen horizontal size)

H: 20 to (base screen vertical size)

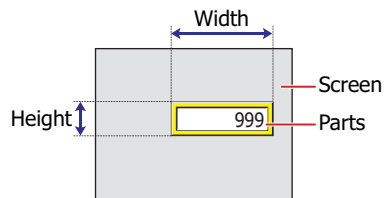

● Format Tab

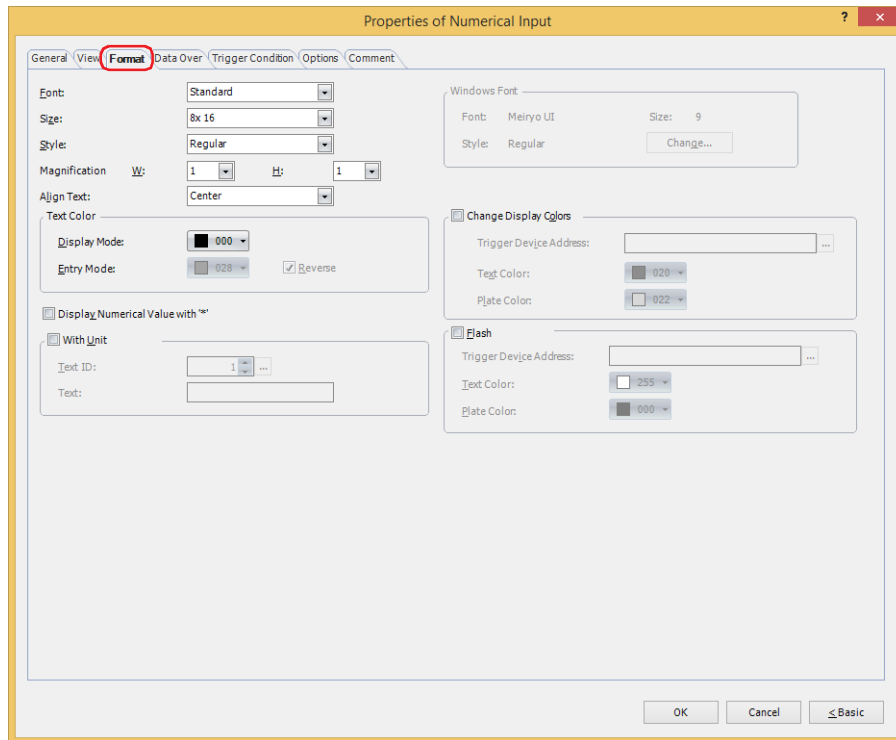

■ Font

Selects the font used for displaying text from the following.

Western*1, Standard*2, Stroke*2, 7-Segment, Windows

The characters that can be displayed depend on the font. For details, refer to Chapter 2 "1.2 Available Text" on page 2-6.

■ Size

Specifies the text size to be displayed. The fonts and sizes that can be set vary based on the model.

Model	Font	Size
HG2J-7U	Western, 7-Segment	8 to 512
HG5G/4G/3G/2G-V, HG4G/3G, HG2G-5F/-5T, HG1G/1P	Standard	8x16, 16x16
	Stroke, 7-Segment	8 to 128

■ Style*2

Selects **Regular** or **Bold** for text style.

Can only be set when **Standard** is selected for **Font**.

■ Magnification*2

W, H: Selects text magnification (0.5, 1 to 8).

Can only be set when **Standard** is selected for **Font**.

■ Align Text

Selects the text alignment in the horizontal direction from the following.

Left, Center, Right

For details, refer to Appendix "5 Text Alignment" on page A-7.

■ Text Color

Selects the color of displayed text (color: 256 colors, monochrome: 16 shades).

Click **Color** to display the Color Palette. Select a color from the Color Palette.

This option can configure the text color in display mode and in entry mode. However, for **Entry Mode** text color can be set only when the **Reverse** check box is cleared.

*1 HG2J-7U only

*2 HG5G/4G/3G/2G-V, HG4G/3G, HG2G-5F/-5T, HG1G/1P only

■ **Reverse**

Select this check box to reverse the text color and plate color during display mode when in entry mode.
Can only be set when **Standard** is selected for **Image Type** under the **View** tab.

■ **Display Numerical Value with "*" *3**

Select this check box to display the entered value as * (asterisks).

Nothing is displayed if the value of device address is 0 when this check box is selected and the **Suppress Zeros** check box is selected on the **General** tab. When this check box is selected in entry mode, nothing is displayed until a value is entered from the key buttons or keypad. If **ENT** is pressed with nothing displayed, 0 is written to the destination device address.

■ **With Unit***3

Select this check box to display units or other characters at the end of a number. Displayed characters must be registered in Text Manager. The displayed text color will be as set for **Text Color** under the **Format** tab.

Text ID: Specifies the Text Manager ID No. (1 to 32000).

Click  to display Text Manager.

Text: Displays the characters of the specified Text ID.



- The maximum number that can be displayed with this function is 4 characters. The fifth and subsequent characters of a character string are not displayed. However, if using a Windows font for the selected text ID, the fifth and subsequent characters of a character string will still be displayed.
- If a carriage return (CR) is included the characters after the CR are not displayed.

■ **Windows Font**

Configures the font to use as the Windows Font.

Select **Windows** for **Font** to display the current settings. To change the settings, click **Change** to display the **Font** dialog box. For details, refer to Chapter 2 "Windows Font" on page 2-13.

■ **Change Display Colors***3

To switch the text and plate colors, select this check box and select the method to the display colors from the following.

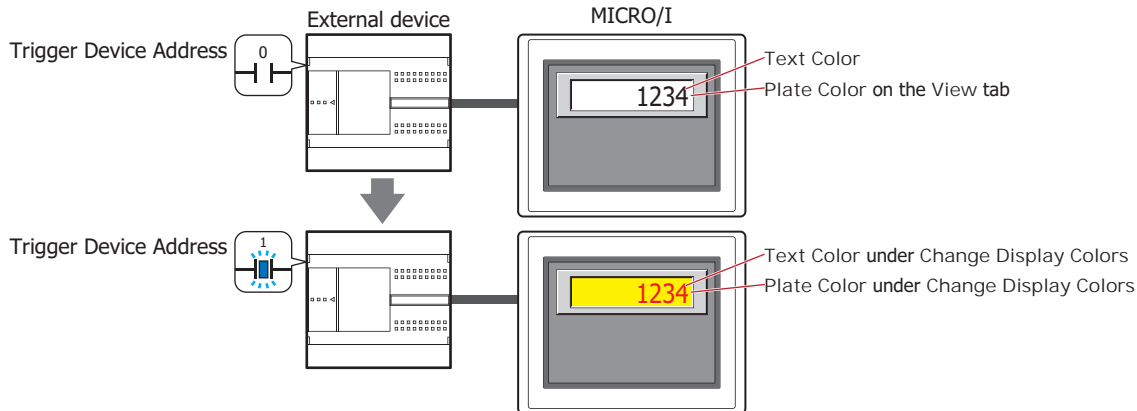

Trigger Device Address: Specifies the bit device or the bit number of the word device to use as the trigger to switch the text and plate colors.

Click  to display the Tag Editor. For the device address configuration procedure, refer to Chapter 2 "5.1 Device Address Settings" on page 2-70.

When the value of device address is 0, the color specified in **Text Color** or in **Plate Color** on the **View** tab will be displayed.

When the value of device address is 1, the color displayed and specified in **Text Color** or **Plate Color** under the **Change Display Colors**.

Text Color: Selects the color (color: 256 colors, monochrome: 16 shades) of the text when switching. Click this button to display the Color Palette. Select a color from the Color Palette.

Plate Color: Selects the plate color (color: 256 colors, monochrome: 16 shades) when switching. Click this button to display the Color Palette. Select a color from the Color Palette.

This option can only be configured when **Standard** is selected for **Image Type** on the **View** tab.

*3 Advanced mode only

Flash *3

Select this check box to make the text and plate colors flash.

The flashing will occur as follows:

- The **Change Display Colors** check box is cleared, then the colors specified by **Text Color** and **Plate Color** on the **View** tab and the colors specified by **Text Color** and **Plate Color** under **Flash** are alternately displayed.

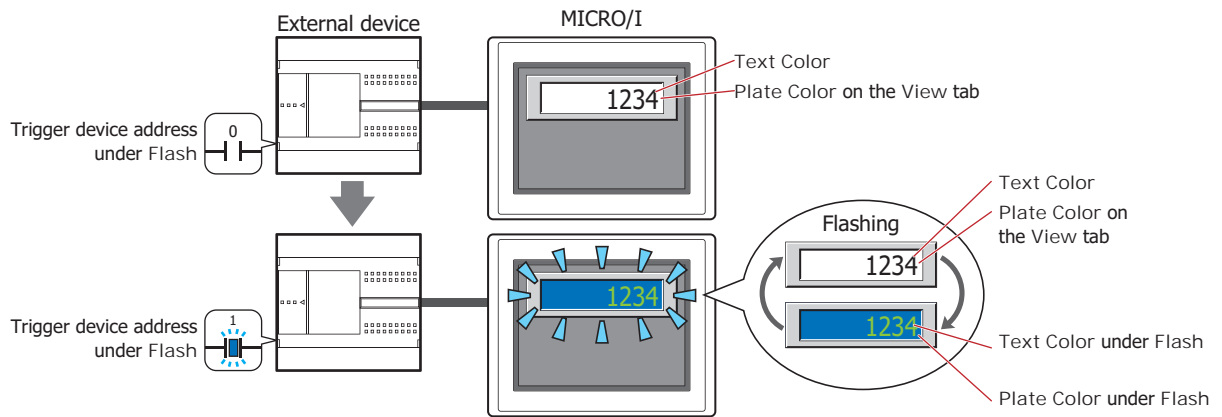

- The **Change Display Colors** check box is selected and the value of the trigger device address for **Change Display Colors** is 0, then the colors specified by **Text Color** and **Plate Color** on the **View** tab and the colors specified by **Text Color** and **Plate Color** under **Flash** are alternately displayed.

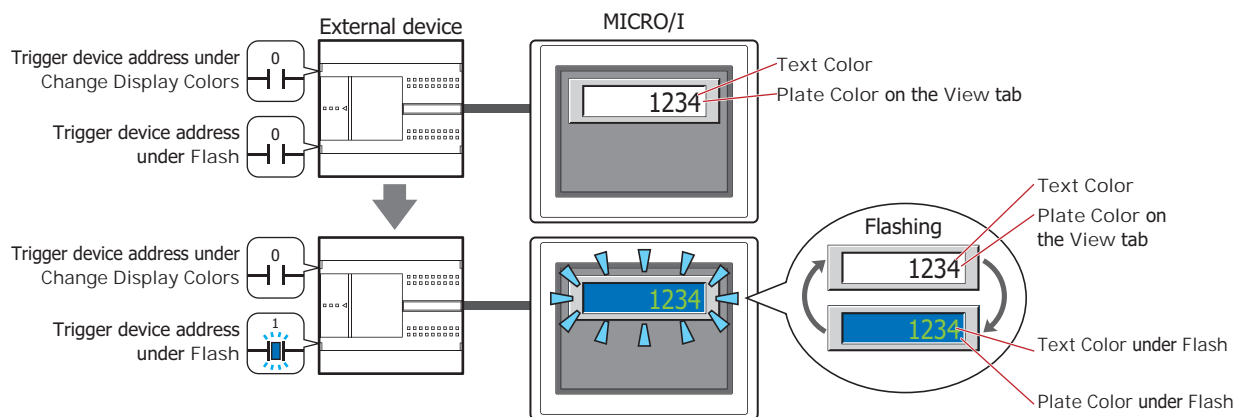

- The **Change Display Colors** check box is selected and the value of the trigger device address for **Change Display Colors** is 1, then the colors specified by **Text Color** and **Plate Color** under **Change Display Colors** and the colors specified by **Text Color** and **Plate Color** under **Flash** are alternately displayed.

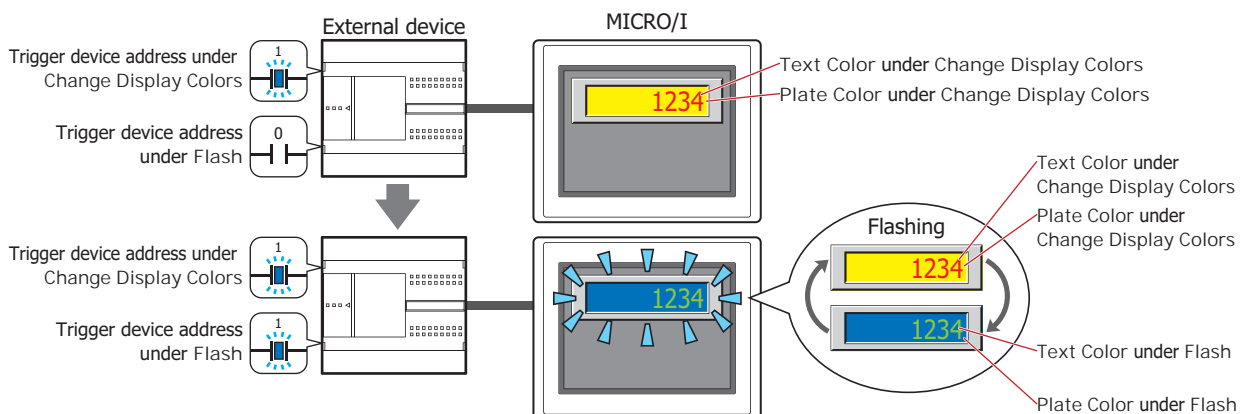

*3 Advanced mode only

- Trigger Device Address: Specifies the bit device or the bit number of the word device that will be used to trigger flash.
Click  to display the Tag Editor. For the device address configuration procedure, refer to Chapter 2 "5.1 Device Address Settings" on page 2-70.
Flash intervals are set in the **Flashing Cycle** on the **System** tab in the **Project Settings** dialog box.
- Text Color: Selects the color (color: 256 colors, monochrome: 16 shades) of text when flashing.
Click this button to display the Color Palette. Select a color from the Color Palette.
- Plate Color: Selects the plate color (color: 256 colors, monochrome: 16 shades) when flashing.
Click this button to display the Color Palette. Select a color from the Color Palette.
This option can only be configured when **Standard** is selected for **Image Type** on the **View** tab.

● Data Over Tab

The **Data Over** tab is displayed in Advanced mode.

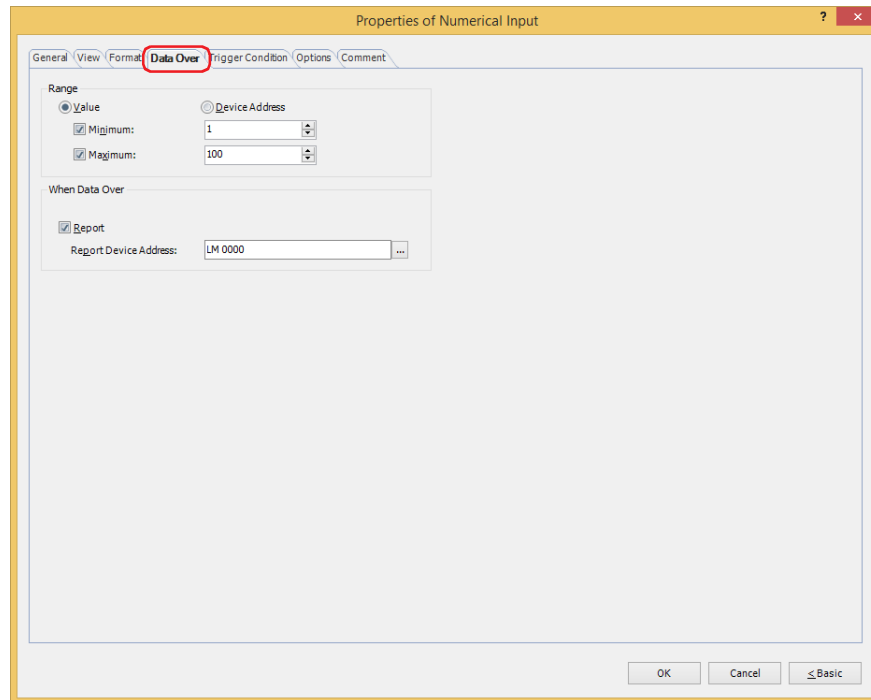

■ Range

Select data type.

Value: Specifies the minimum and/or the maximum as a constant.

Device Address: Specifies the minimum and/or the maximum as a value of word device.

Specifies the allowable range of values to enter or display.

Minimum, Maximum: Select these check boxes to specify the minimum and/or maximum.

The minimum and maximum that can be specified when **Value** is selected vary based on the data type selected with **Data Format** on the **General** tab. For details on data types, refer to Chapter 2 "1.1 Available Data" on page 2-1.

When **Device Address** is selected, these options specify the source word devices.

Click  to display the Tag Editor. For the device address configuration procedure, refer to Chapter 2 "5.1 Device Address Settings" on page 2-70.



- Select **UBIN16(W)**, **BIN16(I)**, **UBIN32(D)**, **BIN32(L)**, **BCD4(B)**, or **BCD8(EB)** for **Data Type** under the **General** tab, and to display a fractional number specify the values of **Minimum** and **Maximum** as an integer.
Example: To set a value of "1.25" for the upper limit, enter "125".
- If the value of the device address to display exceeds the data range that can be processed for the data type selected under **Data Format** on the **General** tab, the symbol selected under **Symbol to show when out of range or Error occurs** on the **General** tab is displayed.
- If the entered value exceeds the allowable range or if it exceeds the data range that can be processed for the data type selected under **Data Format** on the **General** tab, the symbol selected under **Symbol to show when out of range or Error occurs** on the **General** tab is displayed and the value is not written to the device. However, if the **When input value is out of range, display value near maximum or minimum** check box is selected on the **General** tab and a value out of range is entered, the nearest value of the minimum or maximum is displayed.

■ When Data Over

These options configure the operation of the part when the value entered with the keypad exceeds the allowable range.

These options can only be configured when the **Minimum** or **Maximum** check boxes are selected under **Range**.

Report: Select this check box to write 1 in the Report Device Address when the entered value or the value of the device address to display exceeds the allowable range.

Report Device Address: Specifies the Report Device Address.

Click  to display the Tag Editor. For the device address configuration procedure, refer to Chapter 2 "5.1 Device Address Settings" on page 2-70.

Example: If you attempt to enter "140", which is higher than the maximum of "100", or "-10", which is lower than the minimum of "0", the value is not written and the symbol selected under **Symbol to show when out of range or Error occurs** on the **General** tab is displayed. 1 is written to the **Report Device Address LMO** under **When Data Over**.

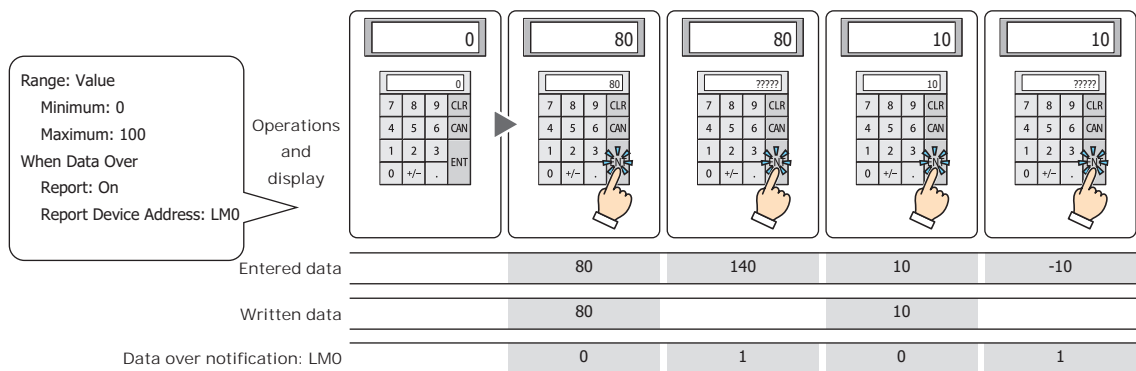

When the **When input value is out of range, display value near maximum or minimum** check box is selected on the **General** tab and a value out of range is entered, 1 is written to the **Report Device Address** under the **When Data Over**.

● **Trigger Condition Tab**

The **Trigger Condition** tab is displayed in Advanced mode.

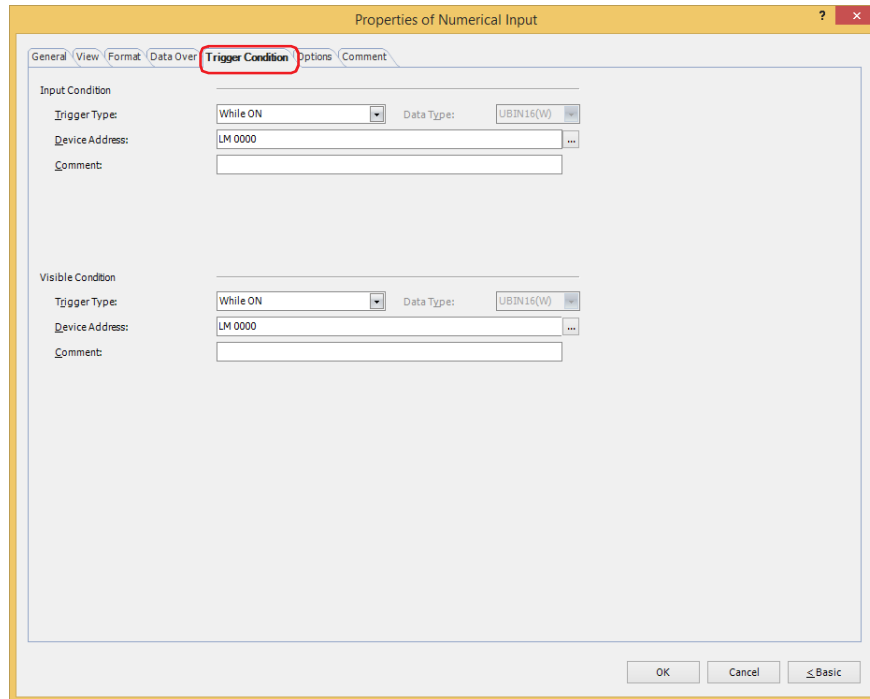

■ **Input Condition**

The Numerical Input is enabled and operational while the condition is satisfied. The Numerical Input is disabled and not operational while the condition is not satisfied.

Example: When **Trigger Type** is **While ON** and **Device Address** is **LM0**

While LM0 is 0, the condition is not satisfied and the Numerical Input is not operational.

While LM0 is 1, the condition is satisfied and the Numerical Input is operational.

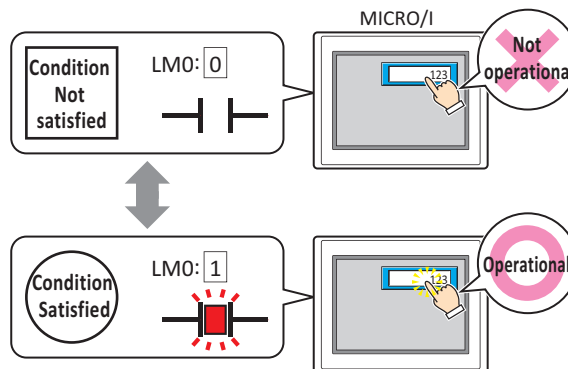

Trigger Type: Selects the condition to enable the Numerical Input from the following.

Always enable: The Numerical Input is always enabled.

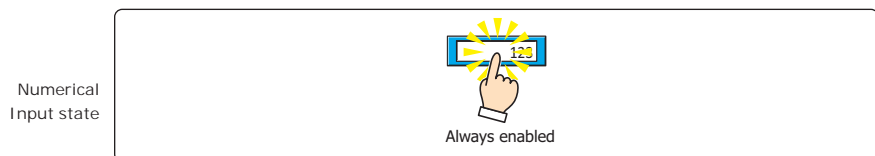

While ON: Enables the Numerical Input when the value of device address is 1.

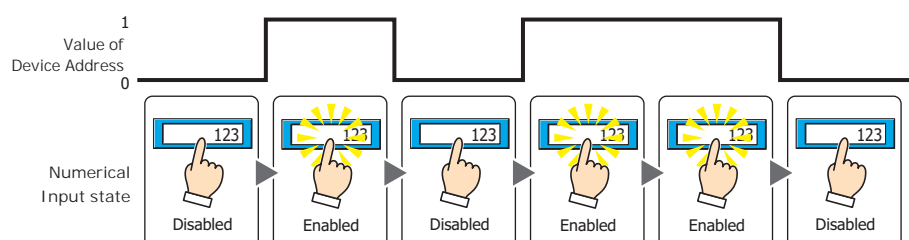

While OFF: Enables the Numerical Input when the value of device address is 0.

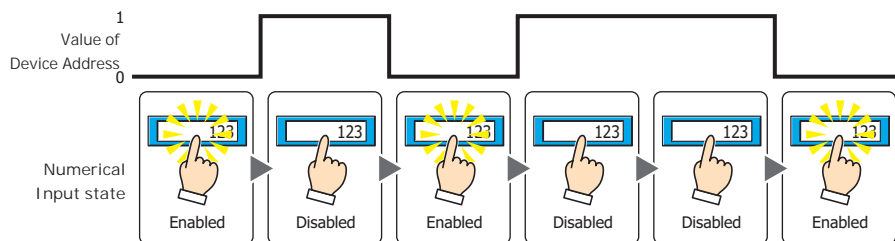

While satisfying the condition: Enables the Numerical Input when the condition is satisfied.

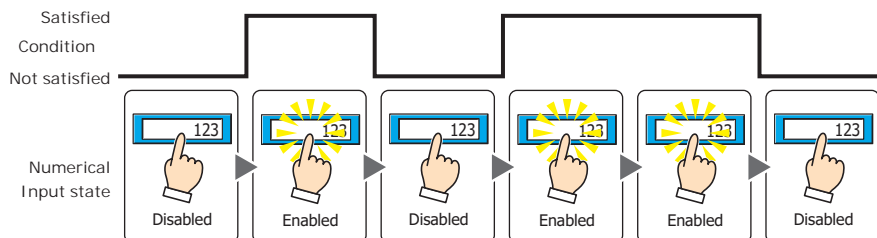

- Data Type:** Selects the type of data handled by the conditional expression for the input condition. This option can only be configured if **While satisfying the condition** is selected for **Trigger Type**. For details, refer to Chapter 2 "1.1 Available Data" on page 2-1.
- Device Address:** Specifies the bit device or the bit number of the word device to serve as the input condition. This option can only be configured when **While ON** or **While OFF** is selected for **Trigger Type**.
Click to display the Tag Editor. For the device address configuration procedure, refer to Chapter 2 "5.1 Device Address Settings" on page 2-70.
- Condition:** Specifies the conditional expression for the input condition. This option can only be configured when **While satisfying the condition** is selected for **Trigger Type**.
Click to display the **Trigger Condition Settings** dialog box. For the conditional expression configuration procedure, refer to Chapter 2 "5.2 Setting Conditional Expressions" on page 2-73.
- Comment:** Used for entering a comment for the input condition. The maximum number is 80 characters.

Visible Condition

The Numerical Input is displayed while the condition is satisfied. The Numerical Input is hidden while the condition is not satisfied.

Example: When **Trigger Type** is **While ON** and **Device Address** is **LM0**
 While LM0 is 0, the condition is not satisfied and the Numerical Input is hidden.
 While LM0 is 1, the condition is satisfied and the Numerical Input is displayed.

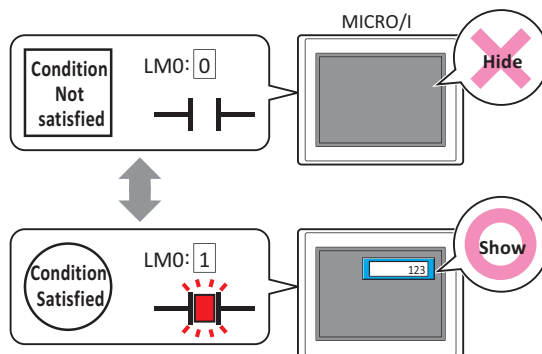

- If the Numerical Input is hidden while entering a value, the input is canceled. If a popup screen configured as the standard keypad or a keypad is displayed, these screens are closed.
- When multiple Numerical Inputs are arranged on the screen and the **Focus is moved by ENT button** check box is selected, entry mode is canceled if the Numerical Input is hidden while entering a value.

Trigger Type: Selects the condition to display the Numerical Input from the following.

Always visible: The Numerical Input is always displayed.

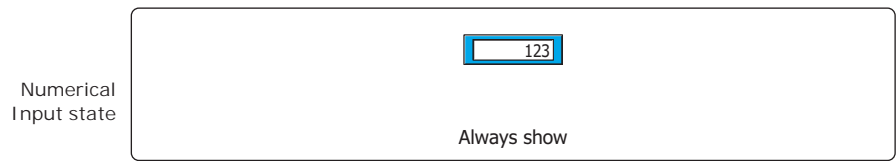

While ON: Displays the Numerical Input when the value of device address is 1.

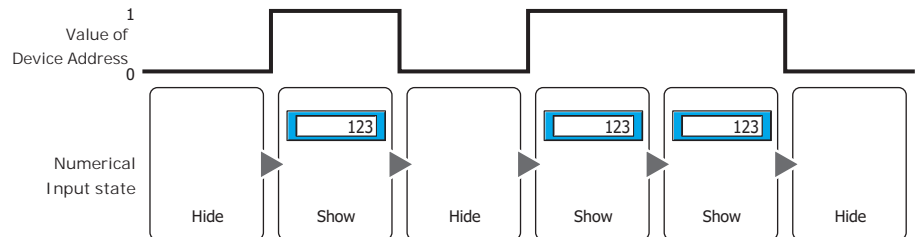

While OFF: Displays the Numerical Input when the value of device address is 0.

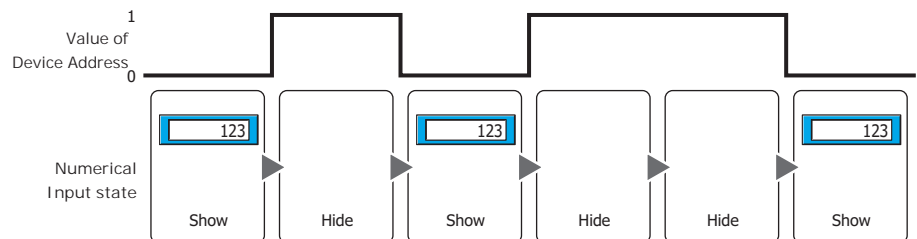

While satisfying the condition: Displays the Numerical Input when the condition is satisfied.

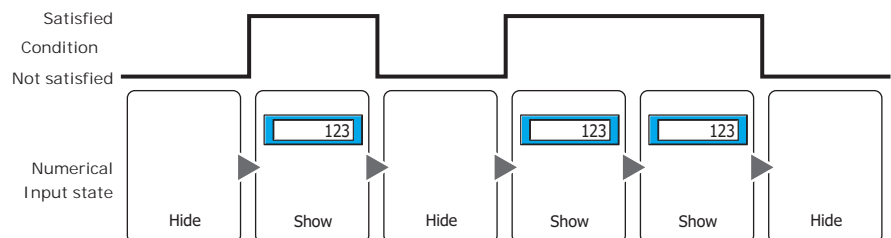

Data Type: Selects the type of data handled by the conditional expression for the visible condition.

This option can only be configured if **While satisfying the condition** is selected for **Trigger Type**. For details, refer to Chapter 2 "1.1 Available Data" on page 2-1.

Device Address: Specifies the bit device or the bit number of the word device to serve as the visible condition.

This option can only be configured when **While ON** or **While OFF** is selected for **Trigger Type**.

Click to display the Tag Editor. For the device address configuration procedure, refer to Chapter 2 "5.1 Device Address Settings" on page 2-70.

Condition: Specifies the conditional expression for the visible condition.

This option can only be configured when **While satisfying the condition** is selected for **Trigger Type**.

Click to display the **Trigger Condition Settings** dialog box. For the conditional expression configuration procedure, refer to Chapter 2 "5.2 Setting Conditional Expressions" on page 2-73.

Comment: Used for entering a comment for the visible condition. The maximum number is 80 characters.

● **Options Tab**

The **Options** tab is displayed in Advanced mode.

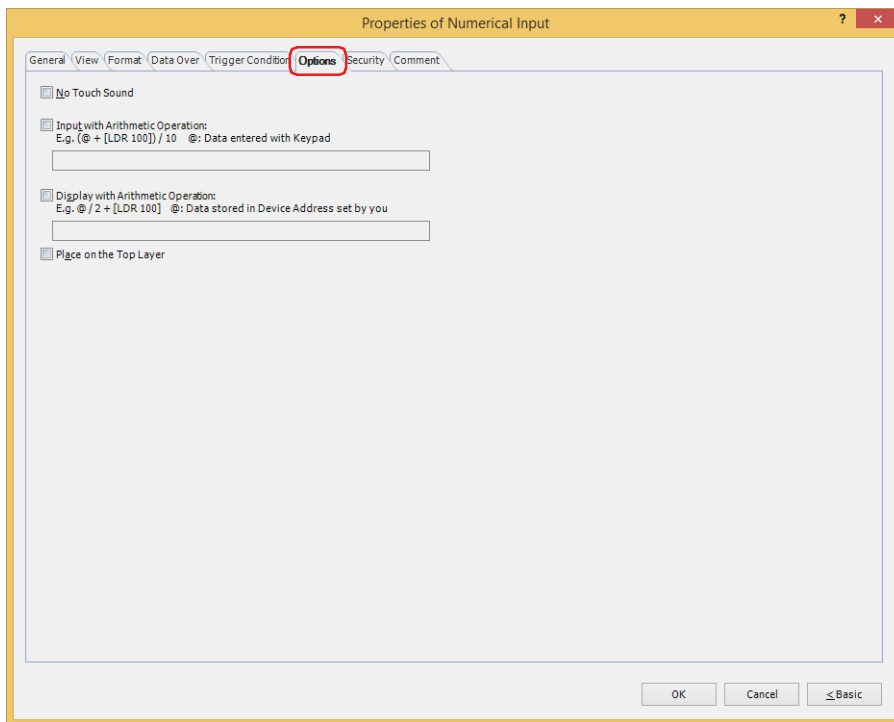

■ **Input with Arithmetic Operation**

To apply arithmetic operations to values entered using a keypad and writing the results, select this check box and input the arithmetic formula.

Example: To divide the value of device address when entered by 60

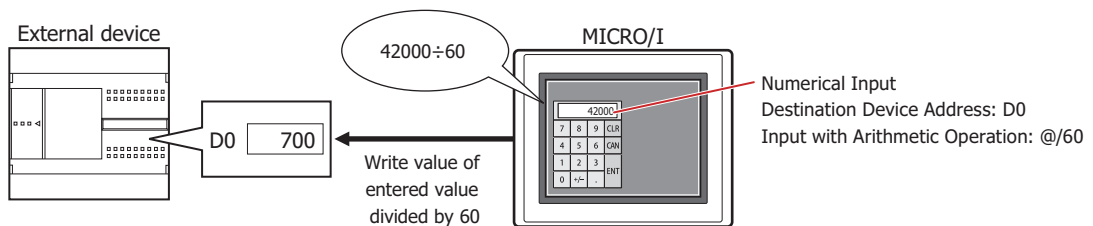

■ **Display with Arithmetic Operation**

To apply arithmetic operations to values of device addresses and writing the results, select this check box and input the arithmetic formula.

Example: To multiply the value of device address when displayed by 60

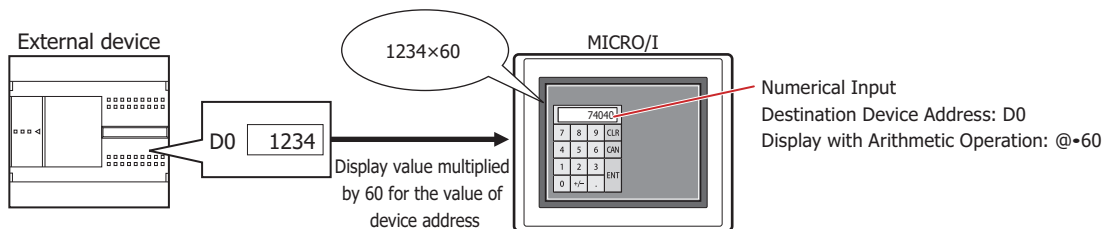

Arithmetic Formulas

Arithmetic formulas can be specified by freely combining multiple kinds of data and operators in the following format.



- There is no limit on the number of data items or number of operators. However, the maximum number is 120 characters.
- Round brackets can be used.

Data

Item	Description
@	The device address on which the arithmetic operation is performed is specified in the arithmetic formula. Only one device address can be set for an arithmetic operation. The device address is as specified for Destination Device Address under the General tab.
Value	Sets the constant values for the arithmetic formula. The values that can be set depend on the data type selected using Data Format under the General tab. For details, refer to Chapter 2 "1.1 Available Data" on page 2-1.
Device Address	Specifies the bit device or the word device for the arithmetic formula. Always enter the device address enclosed in square brackets, "[]".

Operators

Specify the type of arithmetic operation to be performed on the data. The operator priority is the same as for scripts. For details, refer to Chapter 20 "6.5 About the Priority of the Operator" on page 20-62.

Item	Description		
Arithmetic operators	Sets the arithmetic operators.		
	+	Addition	Adds [a] and [b] .
	-	Subtraction	Subtracts [b] from [a] .
	*	Multiplication	Multiplies [a] and [b] .
	/	Division	Divides [a] by [b] .
	%	Modulo	Calculates remainder after dividing [a] by [b] .
Bit operator	Sets the bit operator.		
	&	Logical AND	Calculates the logical product (AND) of each bit of [a] and [b] .
		Logical OR	Calculates the logical sum (OR) of each bit of [a] and [b] .
	^	Logical XOR (exclusive OR)	Calculates the exclusive logical sum (XOR) of each bit of [a] and [b] .
	<<	Left shift	Shifts each bit of [a] to left by [b] bit(s).
	>>	Right shift	Shifts each bit of [a] to right by [b] bit(s).

Examples of Arithmetic Formula Input

Input Examples	Description
@ + 1	To perform the arithmetic operation and input the result, add 1 to the value entered using the Keypad and write the result to the device address. To perform the arithmetic operation and display the result, add 1 to the value of device address and display the result.
[LDR 0] + @ + 100	To perform the arithmetic operation and input the result, add the value of LDR0 to the value entered using the Keypad and add 100, and write the result to the device address. To perform the arithmetic operation and display the result, add the value of LDR0 to the value of device address and add 100, then display the result.
@ & 3	To perform the arithmetic operation and input the result, write the logical product of the value entered using the Keypad and 3 to the device address. To perform the arithmetic operation and display the result, add 3 to the value of device address and display the result.

- No Touch Sound**

This function is to disable touch sounds only for specified parts when the MICRO/I makes touch sounds.

Select this check box to display disable touch sounds for this part.



To enable touch sounds on the MICRO/I, select the **Enable Touch Sound** check box under the **System** tab of the **Project Settings** dialog box.

- Place on the Top Layer**

Select this check box to display the parts on the top layer. The parts will have precedence when other drawings and parts are overlapping with it. For details, refer to Chapter 6 "4 Drawings and Parts Overlapping" on page 6-5.

● Security Tab

This tab is used to restrict displaying and using the part by security groups.

This option can only be set when **Use Security functions** is selected. The **Use Security functions** check box is set on **General** tab in the **Security** dialog box.

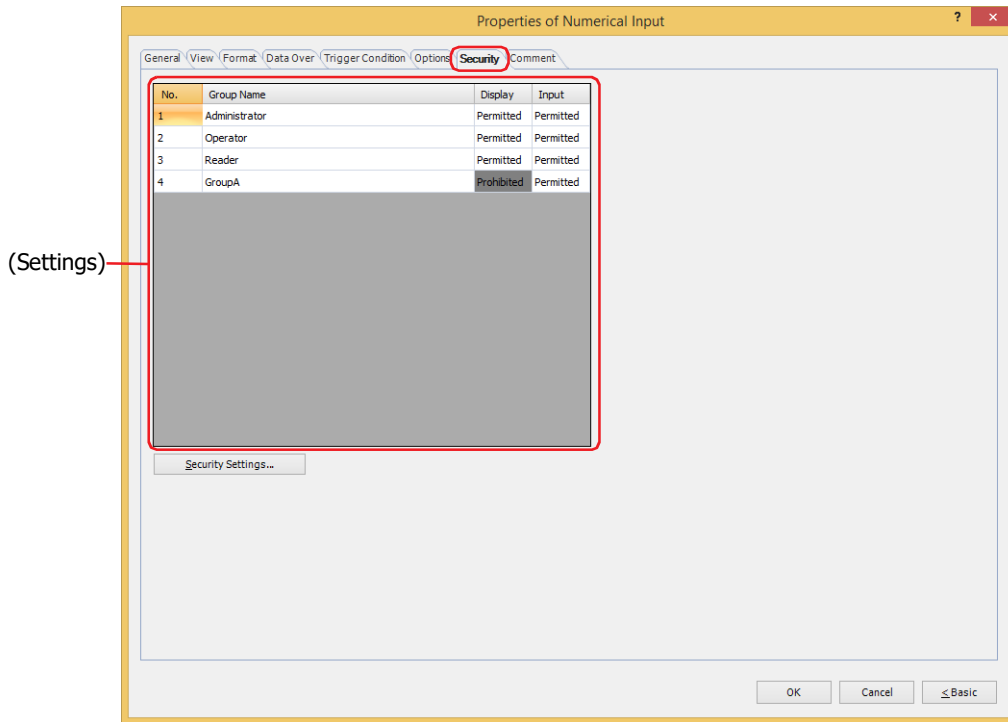

■ (Settings)

Displays the list of security groups used on the MICRO/I.

No.: Displays the security group numbers (1 to 15).

Group Name: Displays the name of the security group.

Display: Displays whether or not there is permission to display the part. Only **Permitted** security groups can display this part. If all security groups are set to **Permitted**, this part will be displayed even if no user account has been selected. Double clicking the cell switches between **Permitted** and **Prohibited**.

Input: Displays whether or not there is permission to use the part. Only **Permitted** security groups can use this part. If all security groups are set to **Permitted**, this part can be used even if no user account has been selected. Double clicking the cell switches between **Permitted** and **Prohibited**.



- You can also switch between **Permitted** and **Prohibited** by right-clicking on a **Display** or **Input** cell.
- Restricting the display and use of the part by switching between **Permitted** and **Prohibited** in **Display** and **Input** cells is similar to using the **Trigger Condition** tab.



■ Security Settings

The Security Settings dialog box is displayed. If you create a security group in the **Security Settings** dialog box, you can select that created group. For details, refer to Chapter 23 "2.2 Adding and Editing Security Groups" on page 23-19.



For details about security functions, refer to Chapter 23 "User Accounts and the Security Function" on page 23-1.

Example: If the user and security group for a part are set as follows:

User Name	 User1	 User2	 User3
Security Group	Reader	Operator	Administrator

Line Chart and Bar Chart

No.	Group Name	Display
1	Administrator	Permitted
2	Operator	Permitted
3	Reader	Prohibited

MICRO/I

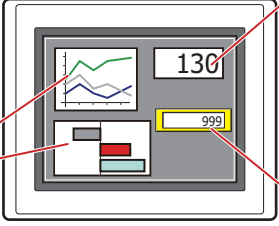

Numerical Display

No.	Group Name	Display
1	Administrator	Permitted
2	Operator	Permitted
3	Reader	Permitted

Numerical Input

No.	Group Name	Display	Input
1	Administrator	Permitted	Permitted
2	Operator	Permitted	Prohibited
3	Reader	Prohibited	Prohibited

For User1 in the **Reader** security group, the parts for which **Display** has been set to **Prohibited** for **Reader** will not be displayed.

If the password screen is opened and the user switches to User2 in the **Operator** security group, the parts for which **Display** has been set to **Permitted** for **Operator** will be displayed.

MICRO/I

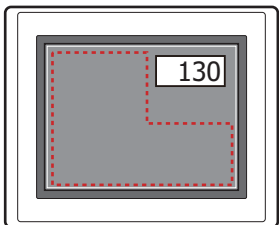

 For User1, parts for which Display has been set to Prohibited for Reader are not displayed

MICRO/I

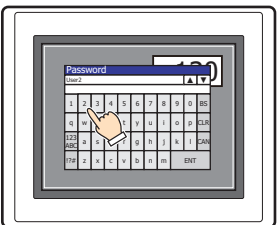

Open Password Screen, enter password, and switch to User2

MICRO/I

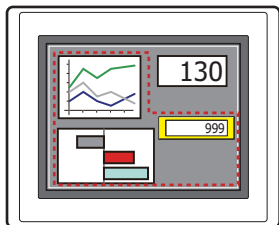



 For User2, parts for which Display has been set to Permitted for Operator are displayed

For User2 in **Operator**, **Display** has been set to **Permitted** for **Operator**, but **Input** is **Prohibited**, so the Numerical Input cannot be used.

If the password screen is opened and the user switches to User3 in the **Administrator** security group, the parts for which **Display** has been set to **Permitted** for **Administrator** will be displayed, and the parts for which **Input** has been set to **Permitted** for **Administrator** can be used.

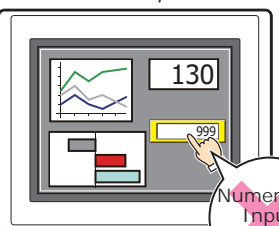
MICRO/I



 For User2, parts for which Display has been set to Permitted for Operator are displayed, but parts for which Input has been set to Prohibited cannot be used

MICRO/I

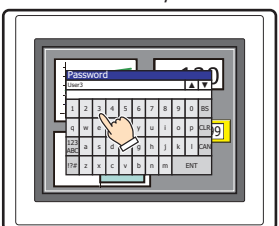

Open Password Screen, enter password, and switch to User3

MICRO/I

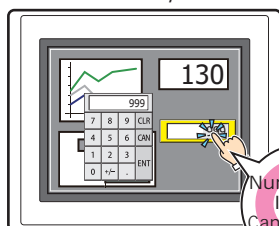

 For User3, parts for which Display has been set to Permitted for Administrator are displayed, and parts for which Input has been set to Permitted can be used

● Comment Tab

The **Comment** tab is used to specify the parts placed on the editing screen, and the popup text displayed when the mouse pointer is placed close to **No.**, **Name**, or **Type** in the object list.



When there are multiple parts of the same shape on the screen, this feature makes it possible to distinguish between the parts without displaying the Properties dialog box for each part, by just mousing over the part.

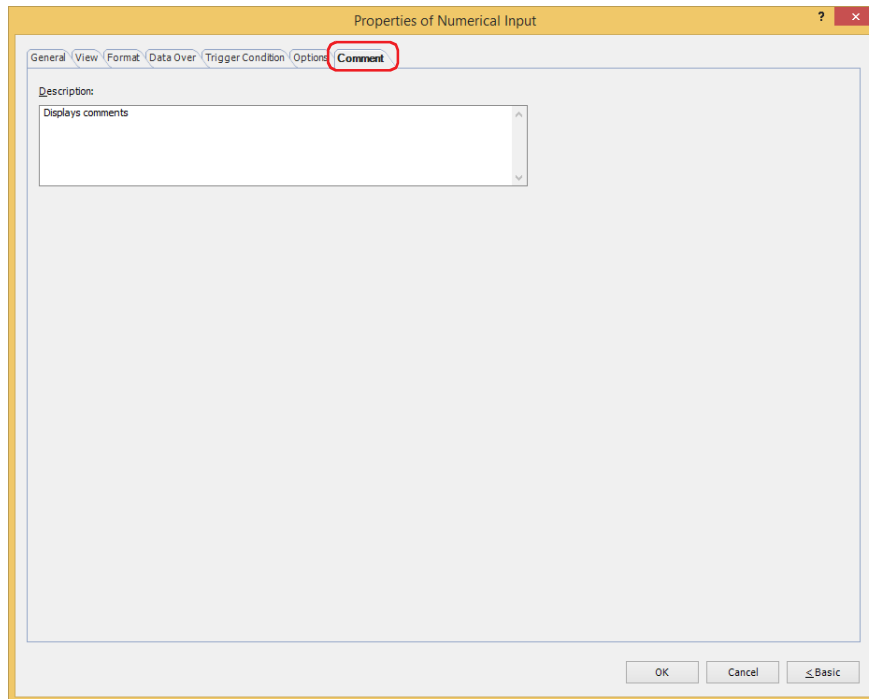

■ Description

Used for entering comments about parts. Maximum number is 80 characters.

Example: When mousing over the Numerical Input on the editing screen

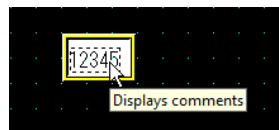

1.4 How to Enter Values

Use the keypad or key buttons to write a value to a device address with the Numerical Input. The input methods are as follows.

■ Pressing the Numerical Input and Entering Values from the Standard Keypad

Arrange a Numerical Input on the screen and in its properties dialog box, on the **General** tab, under **Keypad**, select **Standard** for **Type**.

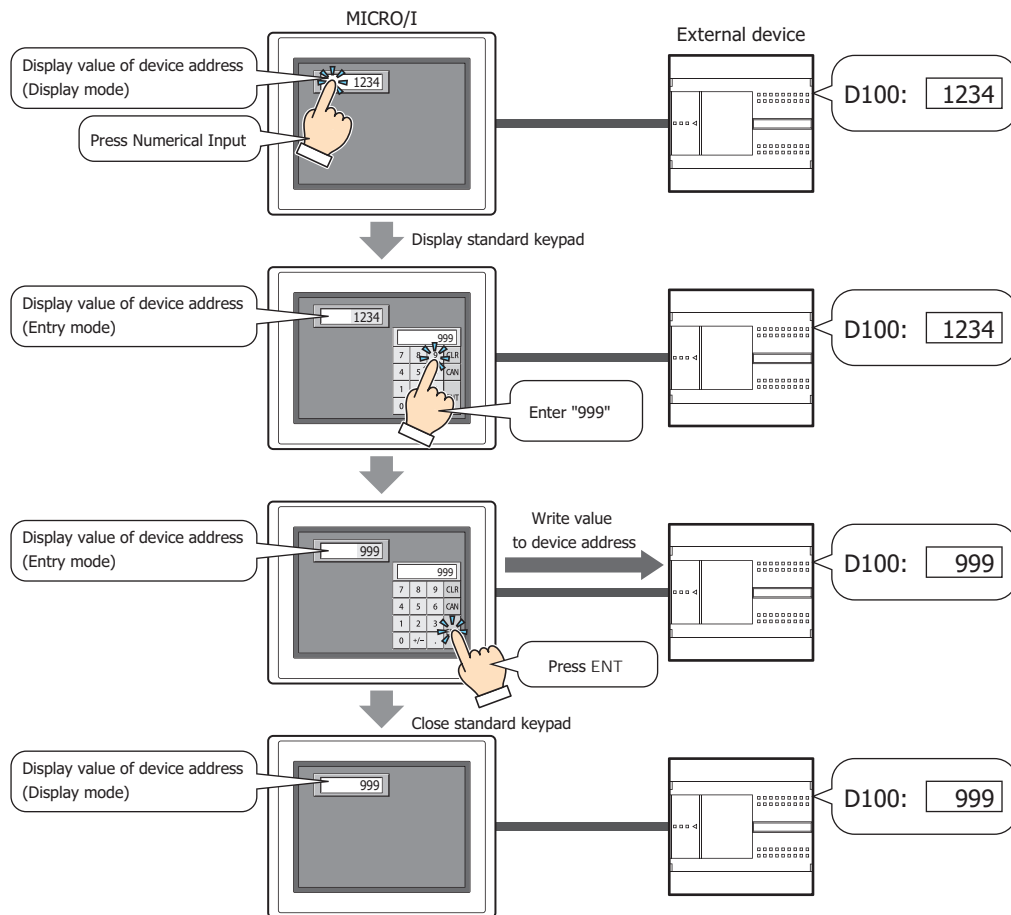

When the following operations are performed, entry mode is canceled and the current value of device address is displayed in the Numerical Input. To enter a value, press the Numerical Input again to set it to entry mode.

- **CAN** was pressed
- When the **Focus is moved by ENT button** check box on the **General** tab is cleared and **ENT** was pressed and a value was written to the device address

■ Without Pressing the Numerical Input, Directly Entering Values from a Keypad on the Same Screen

Arrange a Numerical Input and a keypad on the same screen. In the properties dialog box for the Numerical Input, on the **General** tab, under **Keypad**, select **Current Screen** for **Type** and select the **Always Entry Mode** check box.

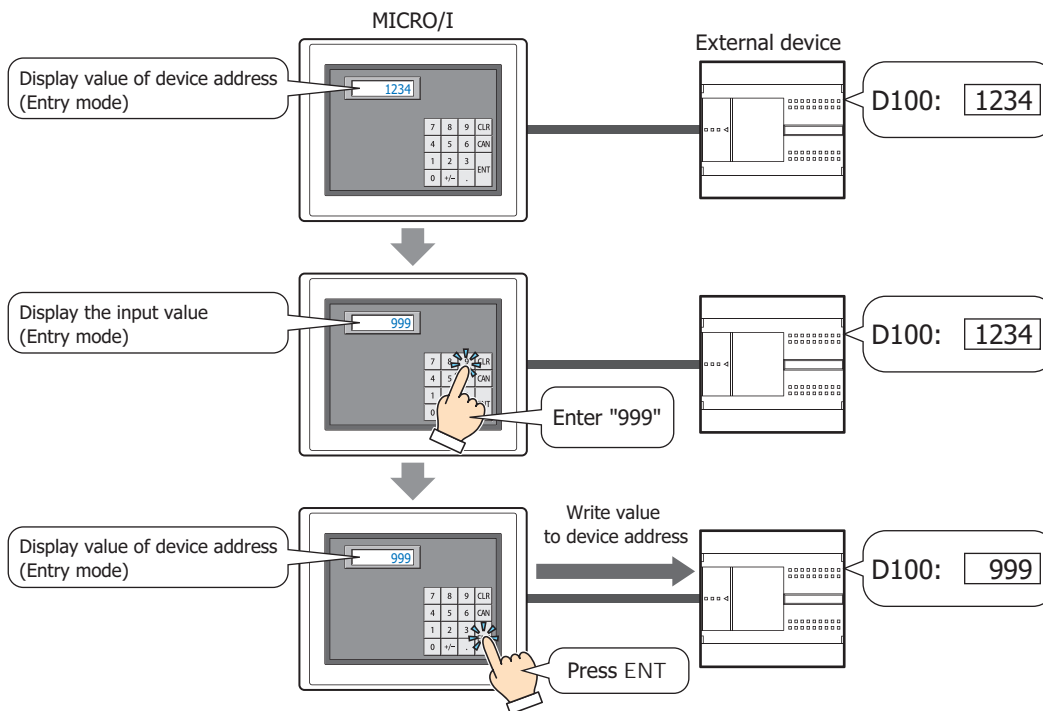

1.5 Advanced Usage

● Using the System Area

- When finished entering a value by pressing **ENT**, 1 is written to the System Area 2 Numerical Input Setting Complete bit (address number+3, bit 0).



If the System Area 2 Numerical Input Setting Complete Bit (address number+3, bit 0) is set to another function's execution condition, that function can be executed when **ENT** is pressed.

Example: To simultaneously close a popup screen when **ENT** is pressed

In the Properties of Goto Screen Command dialog box, on the **General** tab, select **Close Popup Screen** for **Action Mode**. On the **Trigger Condition** tab, select **Rising-edge** for **Trigger Type**, and configure **Device Address** as the System Area 2 Numerical Input Setting Complete bit (address number+3, bit 0).

- When **CAN** is pressed, entry mode is canceled and 1 is written to the System Area 2 Numerical Input Setting Cancel bit (address number+3, bit 1). However, if the keypad is closed by pressing **⌫** (close) on the popup screen's title bar or another Numerical Input is pressed before finished entering the value by pressing **ENT**, entry mode is canceled and 1 is not written to the System Area 2 Numerical Input Setting Cancel bit (address number+3, bit 1).
- To clear the System Area 2 numerical input setting complete bit or the numerical input setting cancel bit, write 1 to System Area 1 Numerical Input Setting Clear bit (address number+1, bit 10). To automatically clear these bits when the Numerical Input keypad is pressed in entry mode, select the **Clear Keypad bit in System Area automatically** check box on the **System** tab in the **Project Settings** dialog box.

2 Character Input

HG2J-7U HG5G-V HG4G-V HG4G HG3G-V HG3G HG2G-V HG2G-5F HG2G-5T HG1G HG1P

2.1 How the Character Input is Used

The Character Input features a display mode that displays the character codes in current values of device addresses as text and an entry mode that enters text using the keypad or key buttons and writes the character codes for the entered text to device addresses. When the part is displayed on the screen, the Character Input is in display mode. To enter text by pressing the keypad or key buttons, touch the Character Input to switch it to entry mode. The Character Input can perform the following functions.

- Write the character codes for text entered with the keypad or key buttons to device addresses

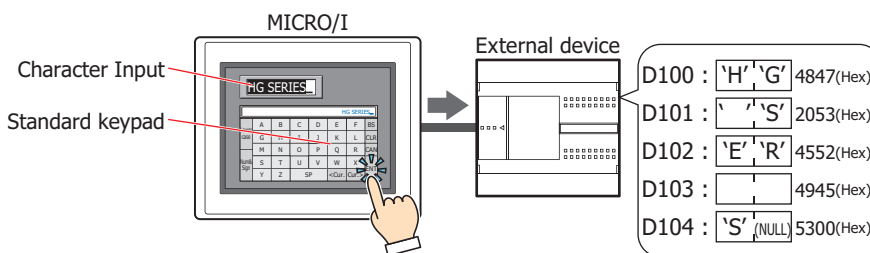

- Display the character codes in current values of device addresses as text

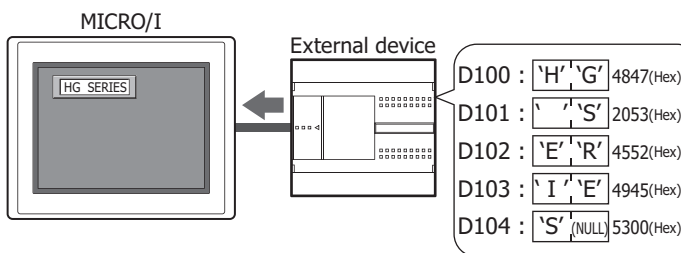

- Display entered text as * (asterisk)

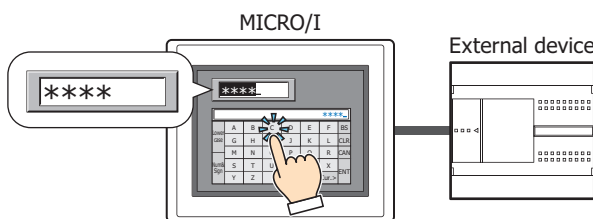

- Enter Kanji characters

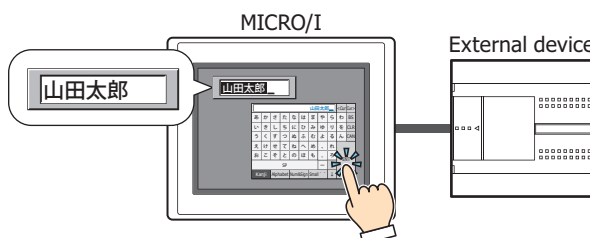

2.2 Character Input Configuration Procedure

This section describes the configuration procedure for Character Inputs.

- 1 On the **Home** tab, in the **Parts** group, click **Data Displays**, and then click **Character Input**.

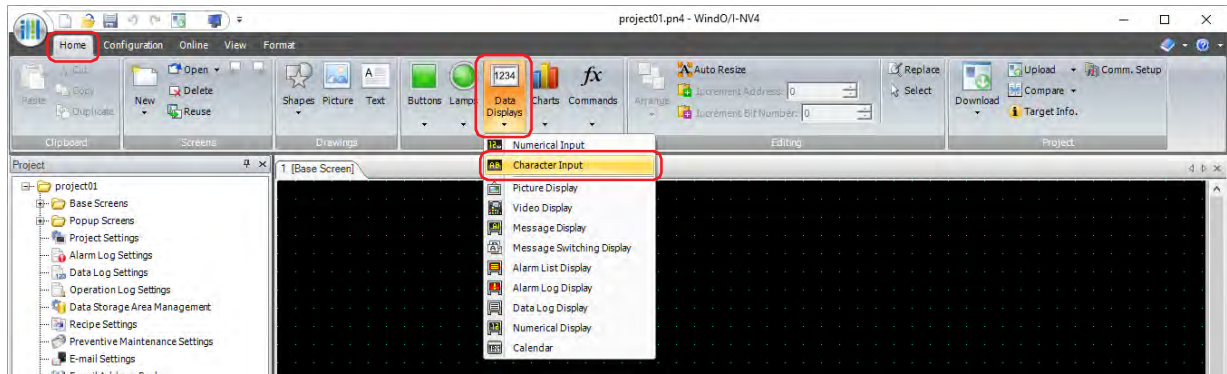

- 2 Click a point on the edit screen where you wish to place the Character Input.
- 3 Double-click the placed Character Input and a Properties dialog box will be displayed.
- 4 Change the settings on each tab as necessary.

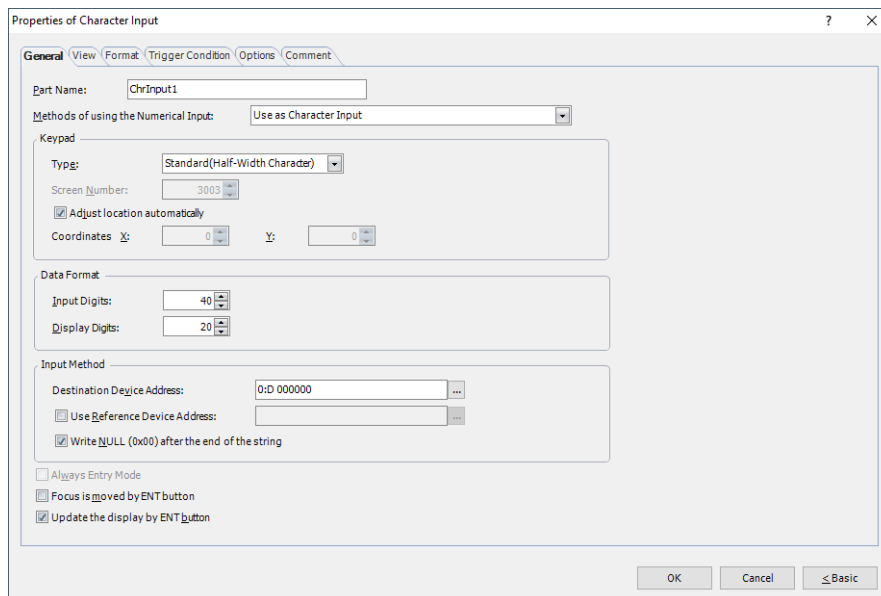

The **Trigger Condition** tab and **Options** tab only appear in Advanced mode.



You can set the default for the Character Input on the **Default Preferences** tab of the **WindO/I-NV4 Options** dialog box. For details, refer to Chapter 2 "Default Preferences Tab" on page 2-63.

2.3 Properties of Character Input Dialog Box

This section describes items and buttons on the properties dialog box.

● General Tab

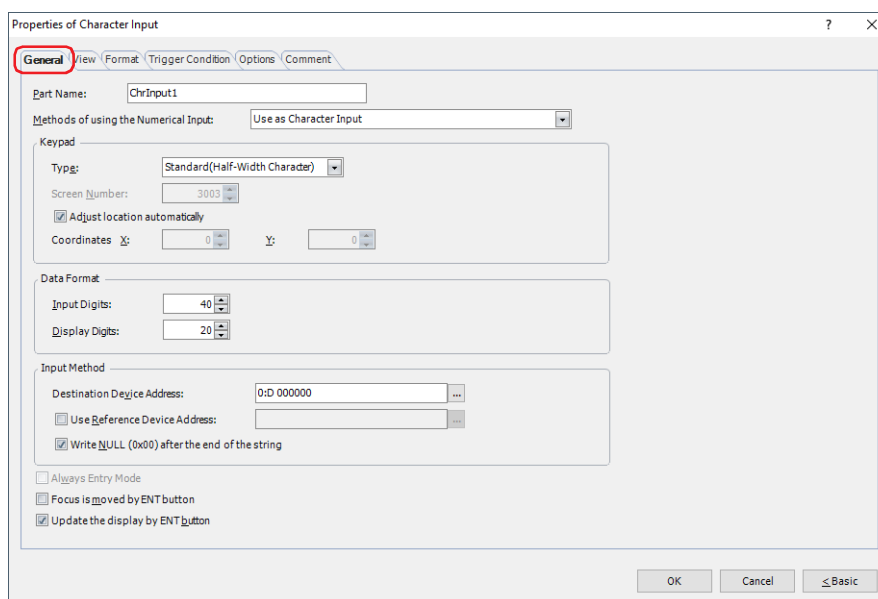

■ Part Name

Enter a name for the part. The maximum number is 20 characters.

■ Methods of using the Character Input

Selects how to use the Character Input:

Use as Character Input:

Uses the Character Input as a part to write the character code of the characters entered with a Keypad or a key button to the word device.

Use as Display for Keypad:

Uses the Character Input as a part to display the value entered with a Keypad.

Use as Display for User Name in Password Input Screen: Uses the Character Input as a part to display the user name on the Password Input Screen.

Use as Display for Password in Password Input Screen: Uses the Character Input as a part to display the password on the Password Input Screen.

■ Keypad

Configures the keypad for entering text in the Character Input.

Use as Display for Keypad*1:

Select this check box to only use the Character Input as a part to display the text entered with the keypad.

Type: According to the location where the keypad is configured, selects the type from the following.

Standard(Half-Width Character): Uses the standard keypad for entering half-width characters. The standard keypad is the keypad configured as the popup screen for the standard keypad. For details, refer to Chapter 5 "4.3 Standard Keypad Popup Screen" on page 5-25.

Standard(Hiragana): Uses the standard keypad for entering full-width characters. The standard keypad is the keypad configured as the popup screen for the standard keypad. For details, refer to Chapter 5 "4.3 Standard Keypad Popup Screen" on page 5-25.

Popup: Uses a keypad configured as a popup screen.

Current Screen: Uses the keypad configured on the same screen as the Character Input.

*1 Advanced mode only

- Screen Number: Specifies the screen number of the popup screen configured as the keypad (1 to 3015). This option can only be configured if **Popup** is selected for **Type**.
- Adjust location automatically: Select this check box to display the popup screen configured as the keypad in a location where it will not overlap the Character Input. This option can only be configured when **Standard(Half-Width Character)**, **Standard(Hiragana)** or **Popup** is selected for **Type**.
- Coordinates X, Y: Specifies the display location of the popup screen configured as the keypad. With the upper-left corner of the screen as the origin, the X and Y coordinates are the upper-left corner of the popup screen. This option can only be configured when **Standard(Half-Width Character)**, **Standard(Hiragana)** or **Popup** is selected for **Type** and the **Adjust location automatically** check box is cleared. Specify the coordinates in 1 dot units.
X: 0 to (base screen horizontal size - 1)
Y: 0 to (base screen vertical size - 1)

■ Data Format

Specifies the digits to display.

- Input Digits: Specifies the number of digits that can be entered with the Character Input (1 to 127). For each character to enter, one digit for half-width characters and two digits for full-width characters is required.
- Display Digits: Specifies the number of digits that can be displayed in the Character Input display (1 to 100). Regardless of half-width or full-width, one digit is required per character.

■ Input Method

These options configure the destination for the character codes for the entered text.

Destination Device Address:

Specifies the destination word device for the character codes for the entered text.

Click to display the Tag Editor. For the device address configuration procedure, refer to Chapter 2 "5.1 Device Address Settings" on page 2-70.

Use Reference Device Address^{*1}:

Select this check box and specify a device address to change the destination word device by the value of this device address.

Click to display the Tag Editor. For the device address configuration procedure, refer to Chapter 2 "5.1 Device Address Settings" on page 2-70.

For details on indirect writing, refer to Chapter 2 "Indirect Read and Indirect Write Settings" on page 2-5.

*1 Advanced mode only

Write NULL (0x00) after the end of the string *1:

Select this check box to write NULL (0x00) to all device addresses from the end of the string to the address number specified by **Input Digits** if the length of the input string is less than **Input Digits**.

Example: If **Input Digits** is 10 and a string with a length of 5 was input

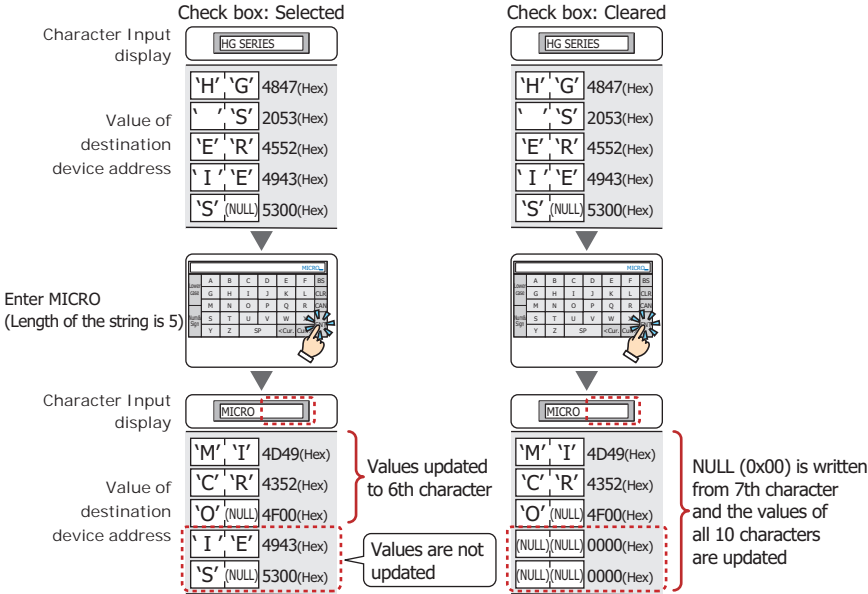

Example: If **Input Digits** is 10 and a string with a length of 6 was input

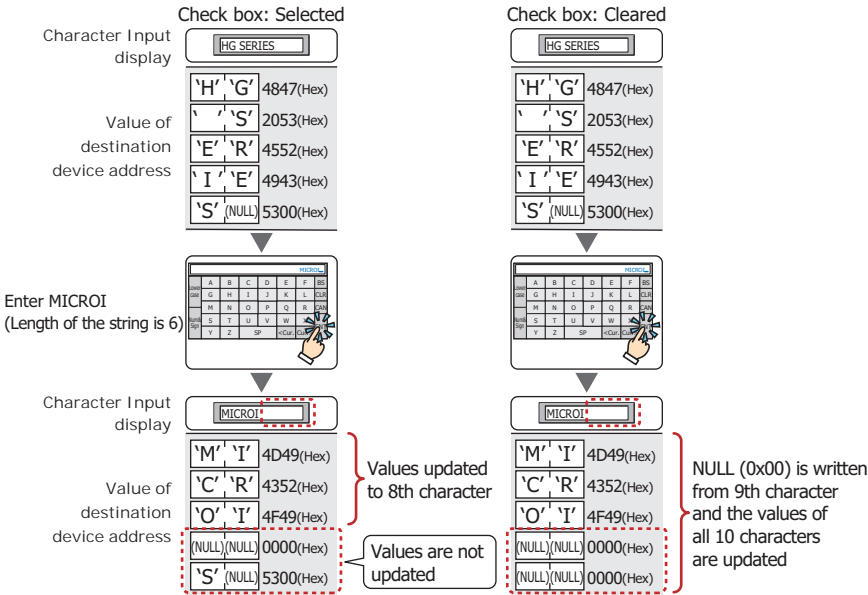

*1 Advanced mode only

■ **Always Entry Mode** *1

Select this check box to enter text by pressing the keypad and key buttons without touching the Character Input displayed on the screen.

This option can only be configured if **Current Screen** is selected for **Type**.

Example: When the **Always Entry mode** check box is selected

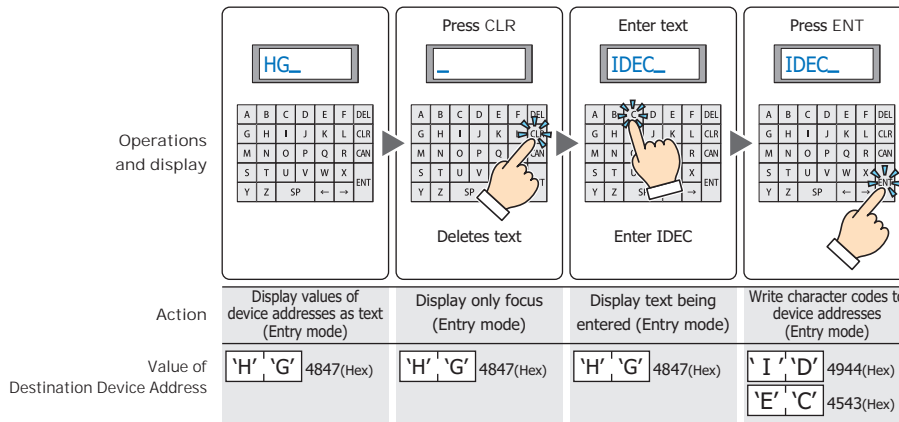

If you use a Numerical Input or a Character Input set to **Always Entry Mode**, other Numerical Input and Character Input configured on the same screen will not work.

Example: When the **Always Entry Mode** check box is cleared

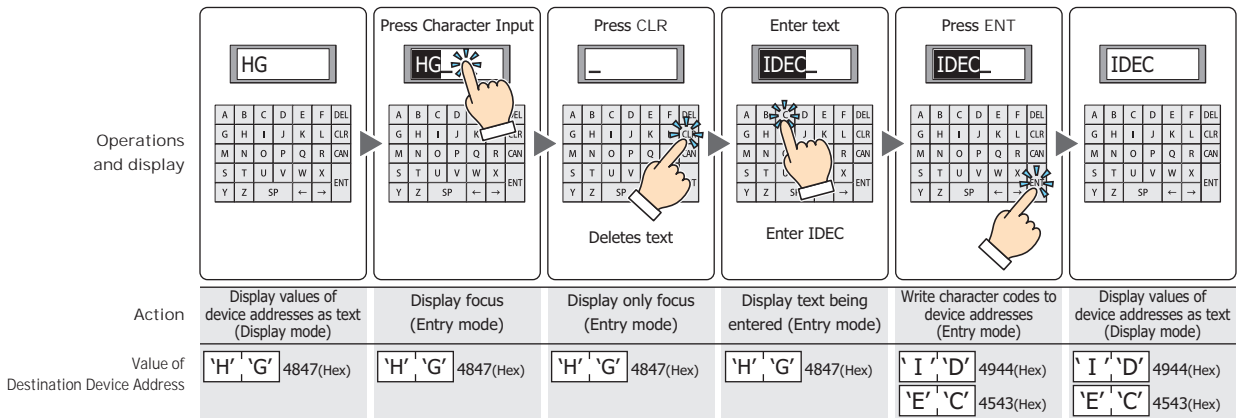

*1 Advanced mode only

■ **Focus is moved by ENT button*1**

When multiple Character Inputs are configured on the screen, select this check box to continue entering text on each of the Character Inputs.

Each time **ENT** is pressed, the focus moves between the Character Inputs according to **Focus Order**. On the **View** tab, in the **Screens** group, click **Focus Order**, and then click the Character Inputs in the order to move the focus.

Example: When Character Input A and B are configured and the **Focus is moved by ENT button** check box for Character Input A is selected and the **Focus is moved by ENT button** check box for Character Input B is cleared

Character Input A action	Display values of device addresses as text (Display mode)	Display focus (Entry mode)	Display text being entered (Entry mode)	Write character codes to device addresses (Entry mode)	Display values of device addresses as text (Display mode)	Display focus (Entry mode)	Display text being entered (Entry mode)	Write character codes to device addresses (Entry mode)	Display values of device addresses as text (Display mode)
Character Input B action	Display values of device addresses as text (Display mode)				Display focus (Entry mode)	Display text being entered (Entry mode)	Write character codes to device addresses (Entry mode)	Display values of device addresses as text (Display mode)	
Character Input A destination device address	'H','G' 4847(Hex)	'H','G' 4847(Hex)	'H','G' 4847(Hex)	'H','G' 4847(Hex) 'S' 2053(Hex) 'E','R' 4552(Hex) 'I','E' 4945(Hex) 'S' NULL 5300(Hex)	'H','G' 4847(Hex) 'S' 2053(Hex) 'E','R' 4552(Hex) 'I','E' 4945(Hex) 'S' NULL 5300(Hex)	'H','G' 4847(Hex)	'H','G' 4847(Hex)	'H','G' 4847(Hex) 'S' 2053(Hex) 'E','R' 4552(Hex) 'I','E' 4945(Hex) 'S' NULL 5300(Hex)	'H','G' 4847(Hex) 'S' 2053(Hex) 'E','R' 4552(Hex) 'I','E' 4945(Hex) 'S' NULL 5300(Hex)
Character Input B destination device address	'M','I' 4D49(Hex) 'C','R' 4352(Hex) 'O' NULL 4F00(Hex)	'M','I' 4D49(Hex) 'C','R' 4352(Hex) 'O' NULL 4F00(Hex)	'M','I' 4D49(Hex) 'C','R' 4352(Hex) 'O' NULL 4F00(Hex)	'M','I' 4D49(Hex) 'C','R' 4352(Hex) 'O' NULL 4F00(Hex)	'M','I' 4D49(Hex) 'C','R' 4352(Hex) 'O' NULL 4F00(Hex)	'M','I' 4D49(Hex)	'M','I' 4D49(Hex)	'M','I' 4D49(Hex) 'S','M' 534D(Hex) 'A','R' 4152(Hex) 'T' NULL 5400(Hex)	'M','I' 4D49(Hex) 'S','M' 534D(Hex) 'A','R' 4152(Hex) 'T' NULL 5400(Hex)

■ **Update the display by ENT button*1**

Select this check box to display the current text unchanged and update the display when text is entered and **ENT** is pressed.

When this check box is cleared, the display updates with each press of a character button to display the character being entered.

Action	Display values of device addresses as text (Display mode)	Display focus (Entry mode)	Display text being entered (Entry mode)	Write character codes to device addresses (Entry mode)	Display values of device addresses as text (Display mode)
Value of Destination Device Address	'H','G' 4847(Hex)	'H','G' 4847(Hex)	'H','G' 4847(Hex)	'H','G' 4847(Hex) 'S' 2053(Hex) 'E','R' 4552(Hex) 'I','E' 4943(Hex) 'S' NULL 5300(Hex)	'H','G' 4847(Hex) 'S' 2053(Hex) 'E','R' 4552(Hex) 'I','E' 4943(Hex) 'S' NULL 5300(Hex)
Character Input display	HG	HG	HG	HG SERIES	HG SERIES
Keypad display	Hide	HG	HG SERIES	HG SERIES	Hide

*1 Advanced mode only

● View Tab

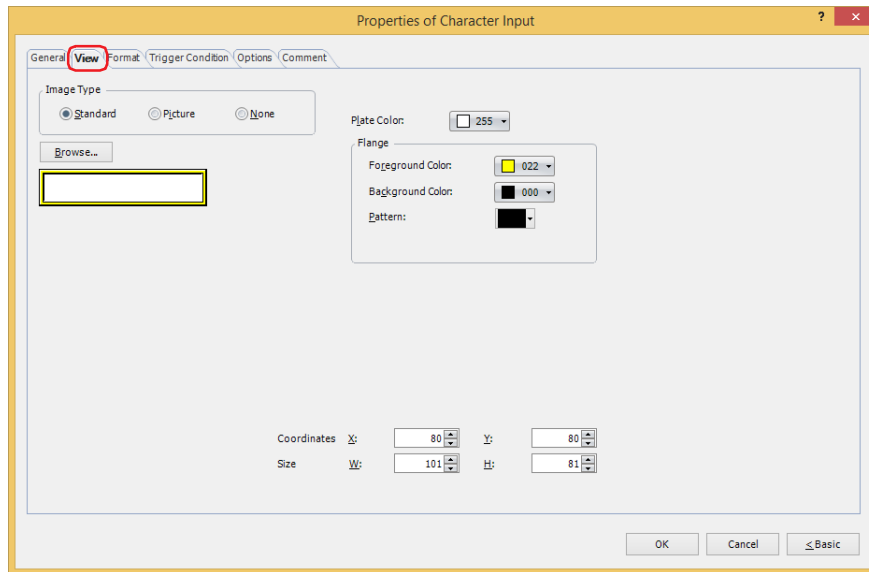

■ Image Type

Select the type of graphic to be used to represent the part.

Standard: Uses the default graphic for WindO/I-NV4.

Picture: Uses an image file saved using Picture Manager.

For details about image file restrictions, refer to Chapter 2 "1.4 Available Image Files" on page 2-20.

None: The plate and the flange of the part are not displayed. Only the text is displayed.

■ Browse

Select the type of graphic to be used to represent the part from the list of graphics. Click this button to display the View Browser or Picture Manager, depending on the setting for **Image Type**.

■ Plate Color

Selects the plate color of the standard graphic (color: 256 colors, monochrome: 16 shades).

Click **Color** to display the Color Palette. Select a color from the Color Palette.

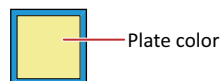

■ Flange

Foreground Color, Background Color: Selects the foreground and background colors of the flange of the standard graphic (color: 256 colors, monochrome: 16 shades).
Click **Color** to display the Color Palette. Select a color from the Color Palette.

Pattern: Selects a pattern for the flange of the standard graphic.
Click **Pattern** to display the Pattern Palette. Select a pattern from the Pattern Palette.

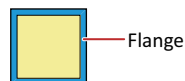

■ Coordinates

X, Y: Sets the display position of parts using coordinates.

The X and Y coordinates of parts is defined relative to an origin at the top-left corner of the screen.

X: 0 to (base screen horizontal size - 1)

Y: 0 to (base screen vertical size - 1)

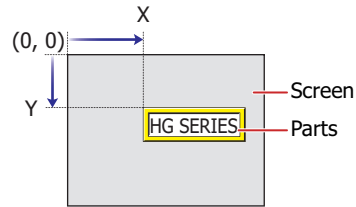

■ Size

W, H: Sets width and height to define the size of parts.

W: 20 to (base screen horizontal size)

H: 20 to (base screen vertical size)

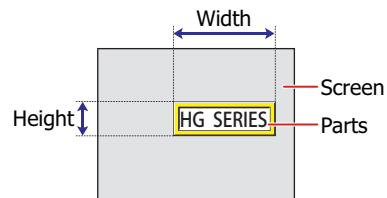

● Format Tab

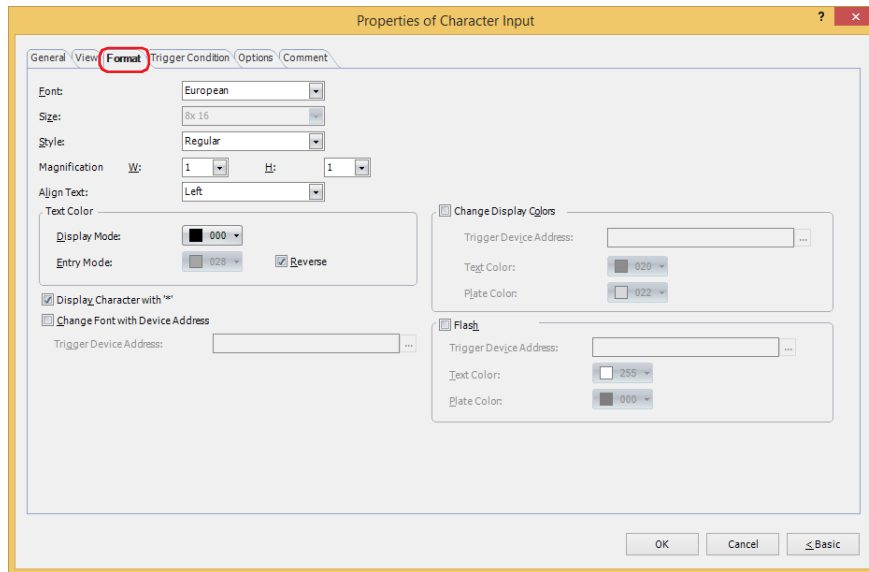

■ Font

Selects the font used for displaying text from the following.

Western, Japanese, Central European, Baltic, Cyrillic, Stroke^{*1}

The characters that can be displayed depend on the font. For details, refer to Chapter 2 "1.2 Available Text" on page 2-6.

■ Size

Specifies the text size to be displayed. The fonts and sizes that can be set vary based on the model.

Model	Font	Size
HG2J-7U	Western, Japanese, Central European, Baltic, Cyrillic	8 to 512
HG5G/4G/3G/2G-V, HG4G/3G, HG2G-5F/-5T, HG1G/1P	Japanese	8x16, 16x16
	Stroke	8 to 128

■ Style^{*1}

Selects **Regular** or **Bold** for text style.

Can only be set when **Western, Japanese, Central European, Baltic, Cyrillic** is selected for **Font**.

■ Magnification^{*1}

W, H: Selects text magnification (0.5, 1 to 8).

Can only be set when **Western, Japanese, Central European, Baltic, Cyrillic** is selected for **Font**.

■ Align Text

Selects the text alignment in the horizontal direction from the following.

Left, Center, Right

For details, refer to Appendix "5 Text Alignment" on page A-7.

■ Text Color

Selects the color of displayed text (color: 256 colors, monochrome: 16 shades).

Click **Color** to display the Color Palette. Select a color from the Color Palette.

This option can configure the text color in display mode and in entry mode. However, for **Entry Mode** text color can be set only when the **Reverse** check box is cleared.

■ Reverse

Select this check box to reverse the text color and plate color during display mode when in entry mode.

Can only be set when **Standard** is selected for **Image Type** under the **View** tab.

*1 HG5G/4G/3G/2G-V, HG4G/3G, HG2G-5F/-5T, HG1G/1P only

■ Display Character with "*" *2

Select this check box to display the entered characters as * (asterisks).

If this check box is selected, nothing is displayed until a value is entered from the key buttons or keypad when the Character Input is in entry mode. If **ENT** is pressed with nothing displayed, 0 is written to the destination device address.

■ Change Font with Device Address *2

Select this check box to change the font used to display the text with a value of device address.

The keypad (popup screen) can also be changed when **Standard(Half-Width Character)**, **Standard(Hiragana)** or **Popup** is selected for **Type** under **Keypad** on the **General** tab.

Trigger Device Address: Specifies the word device (2 words) to use as the condition to change the font.

Click  to display the Tag Editor. For the device address configuration procedure, refer to Chapter 2 "5.1 Device Address Settings" on page 2-70.

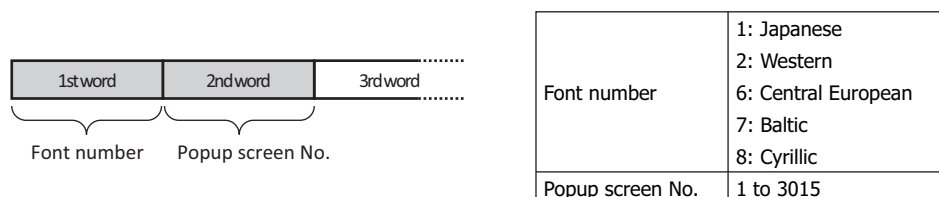

Example: With **Trigger Device Address** set to D100, to enter Central European text from popup screen 100 using a Character Input for entering European text from the standard keypad (popup screen 3003)
Write 6 to D100 and 100 to D101.

■ Change Display Colors *2

Select this check box to switch the text and plate colors.

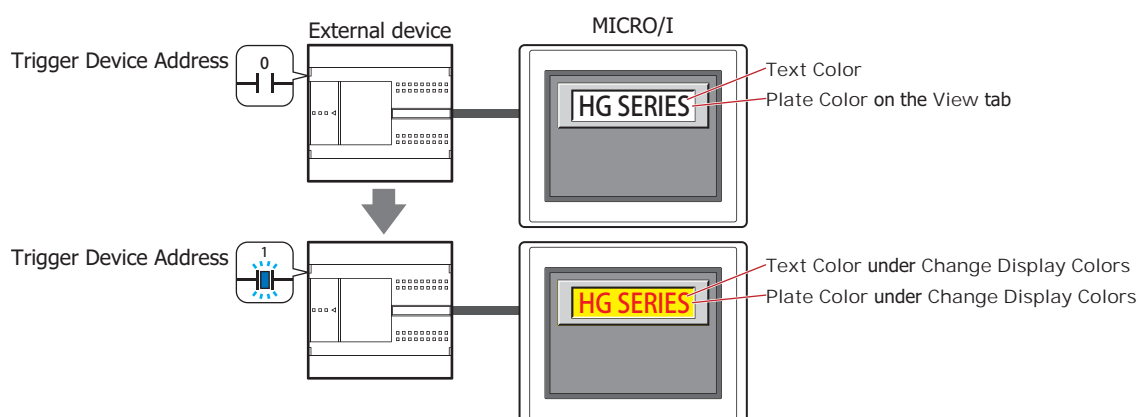

Trigger Device Address: Specifies the bit device or the bit number of the word device to use as the trigger to switch the text and plate colors.

Click  to display the Tag Editor. For the device address configuration procedure, refer to Chapter 2 "5.1 Device Address Settings" on page 2-70.

When the value of device address is 0, the color specified in **Text Color** or in **Plate Color** on the **View** tab will be displayed.

When the value of device address is 1, the color displayed and specified in **Text Color** or **Plate Color** under the **Change Display Colors**.

Text Color: Selects the color (color: 256 colors, monochrome: 16 shades) of the text when switching. Click this button to display the Color Palette. Select a color from the Color Palette.

Plate Color: Selects the plate color (color: 256 colors, monochrome: 16 shades) when switching. Click this button to display the Color Palette. Select a color from the Color Palette. This option can only be configured when **Standard** is selected for **Image Type** on the **View** tab.

*2 Advanced mode only

■ **Flash** *2

Select this check box to make the text and plate colors flash.

The flashing will occur as follows:

- The **Change Display Colors** check box is cleared, then the colors specified by **Text Color** and **Plate Color** on the **View** tab and the colors specified by **Text Color** and **Plate Color** under **Flash** are alternately displayed.

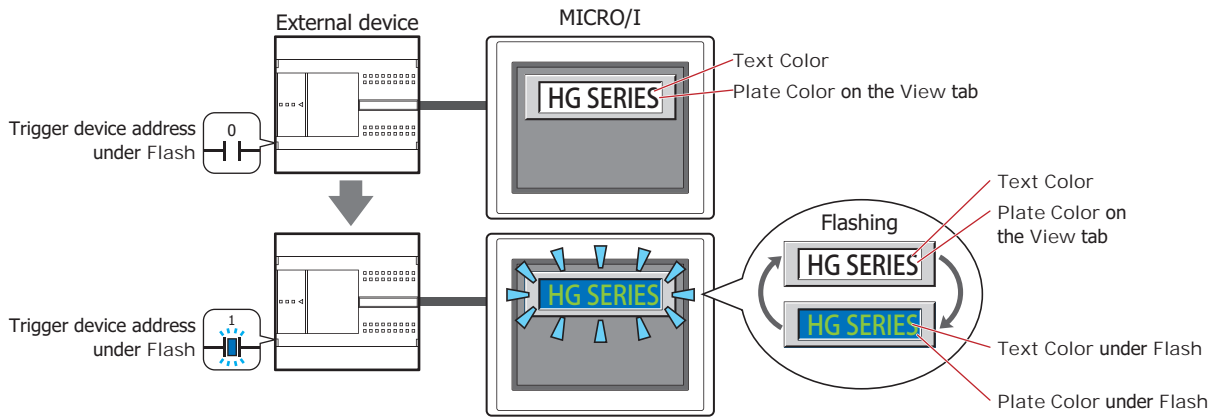

- The **Change Display Colors** check box is selected and the value of the trigger device address for **Change Display Colors** is 0, then the colors specified by **Text Color** and **Plate Color** on the **View** tab and the colors specified by **Text Color** and **Plate Color** under **Flash** are alternately displayed.

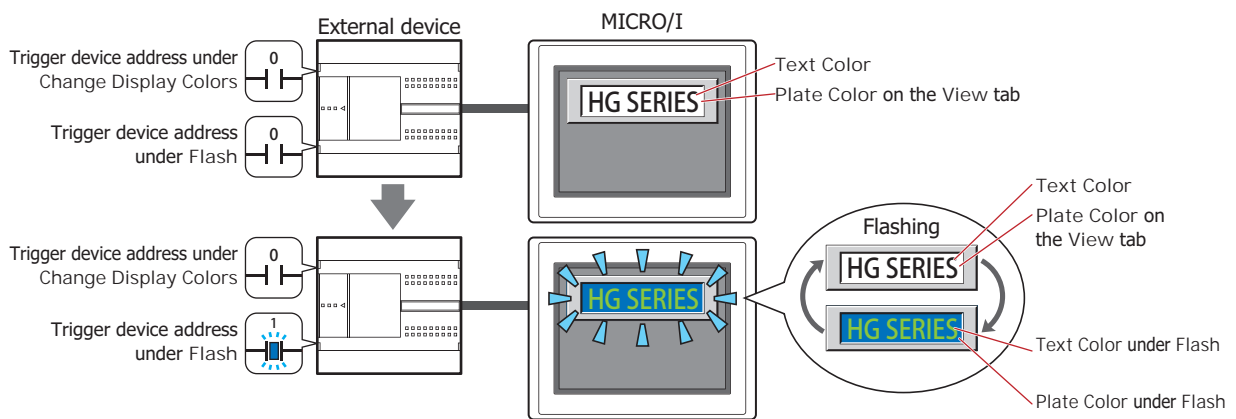

- The **Change Display Colors** check box is selected and the value of the trigger device for **Change Display Colors** is 1, then the colors specified by **Text Color** and **Plate Color** under **Change Display Colors** and the colors specified by **Text Color** and **Plate Color** under **Flash** are alternately displayed.

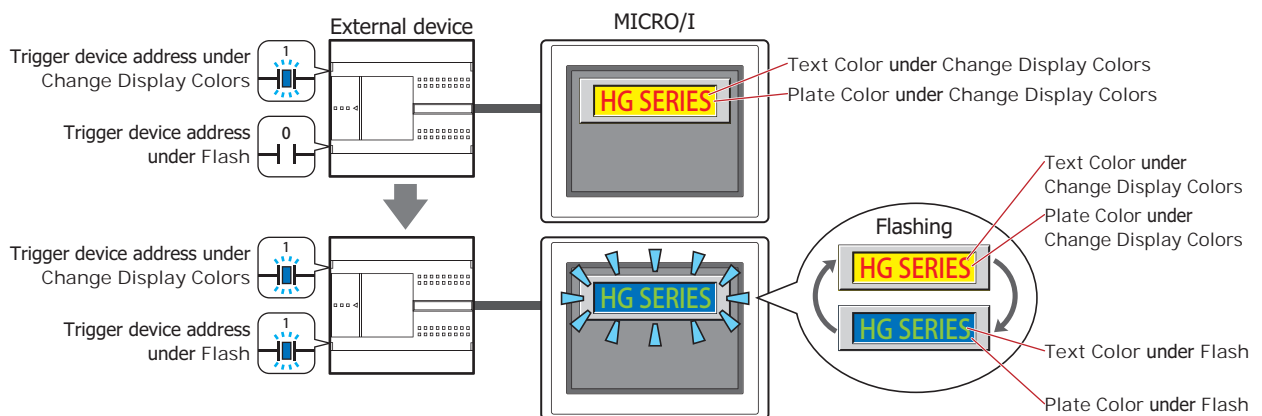

*2 Advanced mode only

- Trigger Device Address:** Specifies the bit device or the bit number of the word device that will be used to trigger flash.
- Click  to display the Tag Editor. For the device address configuration procedure, refer to Chapter 2 "5.1 Device Address Settings" on page 2-70.
- Flash intervals are set in the **Flashing Cycle** on the **System** tab in the **Project Settings** dialog box.
- Text Color:** Selects the color (color: 256 colors, monochrome: 16 shades) of text when flashing.
- Click this button to display the Color Palette. Select a color from the Color Palette.
- Plate Color:** Selects the plate color (color: 256 colors, monochrome: 16 shades) when flashing.
- Click this button to display the Color Palette. Select a color from the Color Palette.
- This option can only be configured when **Standard** is selected for **Image Type** on the **View** tab.

● **Trigger Condition Tab**

The **Trigger Condition** tab is displayed in Advanced mode.

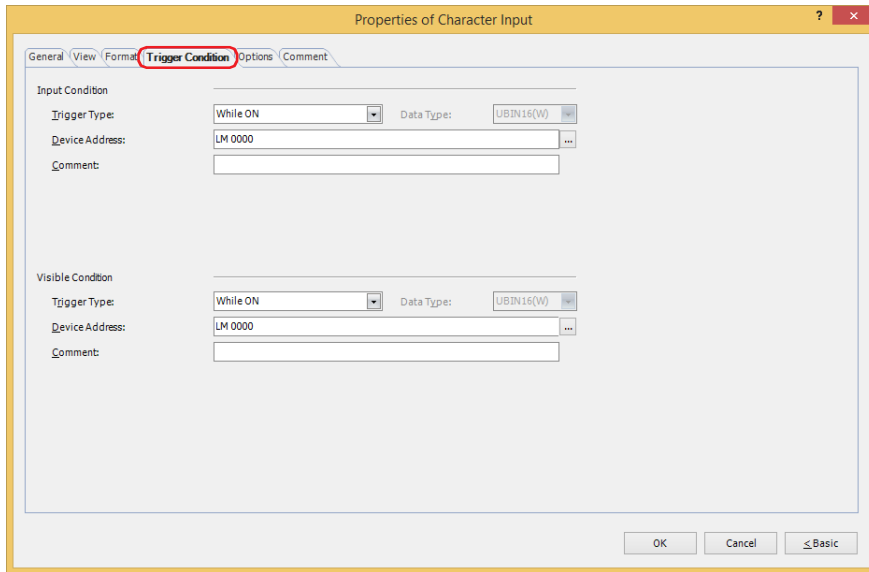

■ **Input Condition**

The Character Input is enabled and operational while the condition is satisfied. The Character Input is disabled and not operational while the condition is not satisfied.

Example: When **Trigger Type** is **While ON** and **Device Address** is **LM0**

While LM0 is 0, the condition is not satisfied and the Character Input is not operational.

While LM0 is 1, the condition is satisfied and the Character Input is operational.

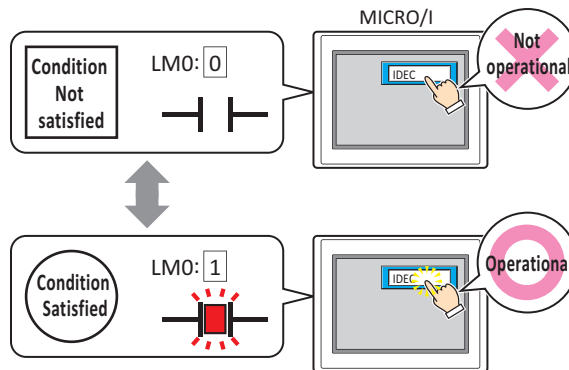

Trigger Type: Selects the condition to enable the Character Input from the following.

Always enable: The Character Input is always enabled.

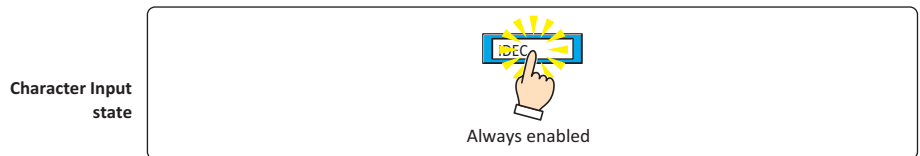

While ON: Enables the Character Input when the value of device address is 1.

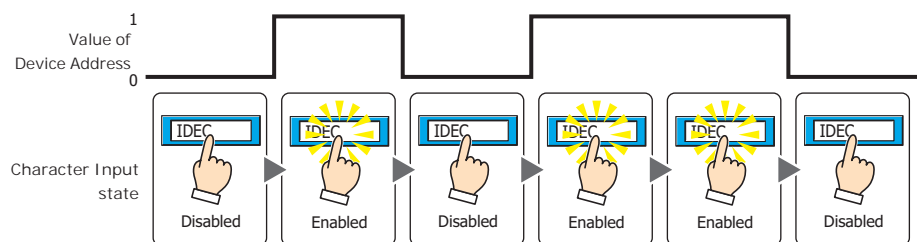

While OFF: Enables the Character Input when the value of device address is 0.

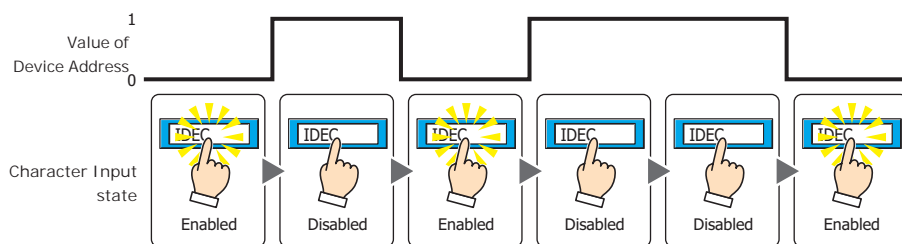

While satisfying the condition:

Enables the Character Input when the condition is satisfied.

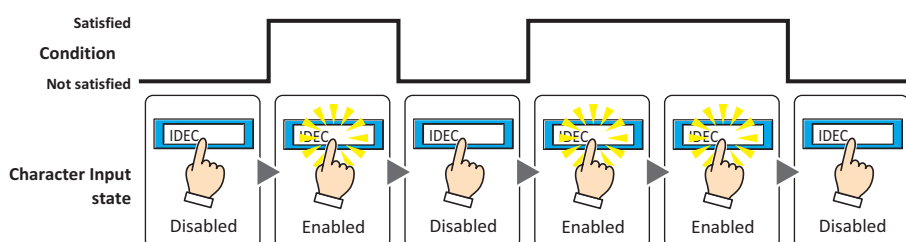

Data Type: Selects the type of data handled by the conditional expression for the input condition. This option can only be configured if **While satisfying the condition** is selected for **Trigger Type**. For details, refer to Chapter 2 "1.1 Available Data" on page 2-1.

Device Address: Specifies the bit device or the bit number of the word device to serve as the input condition. This option can only be configured when **While ON** or **While OFF** is selected for **Trigger Type**.

Click to display the Tag Editor. For the device address configuration procedure, refer to Chapter 2 "5.1 Device Address Settings" on page 2-70.

Condition: Specifies the conditional expression for the input condition. This option can only be configured when **While satisfying the condition** is selected for **Trigger Type**.

Click to display the **Trigger Condition Settings** dialog box. For the conditional expression configuration procedure, refer to Chapter 2 "5.2 Setting Conditional Expressions" on page 2-73.

Comment: Used for entering a comment for the input condition. The maximum number is 80 characters.

■ Visible Condition

The Character Input is displayed while the condition is satisfied. The Character Input is hidden while the condition is not satisfied.

Example: When **Trigger Type** is **While ON** and **Device Address** is **LM0**
 While LM0 is 0, the condition is not satisfied and the Character Input is hidden.
 While LM0 is 1, the condition is satisfied and the Character Input is displayed.

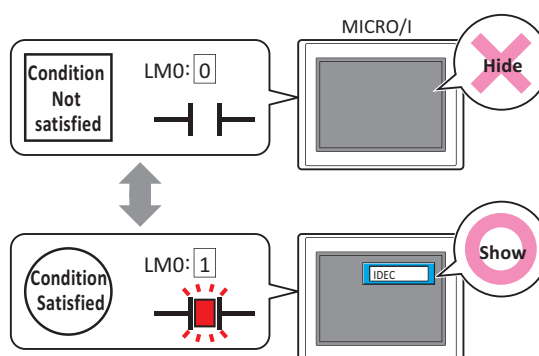

- If the Character Input is hidden while entering a value, the input is canceled. If a popup screen configured as the standard keypad or a keypad is displayed, these screens are closed.
- When multiple Character Inputs are arranged on the screen and the **Focus is moved by ENT button** check box is selected, entry mode is canceled if the Character Input is hidden while entering a value.

Trigger Type: Selects the condition to display the Character Input from the following.

Always visible: The Character Input is always displayed.

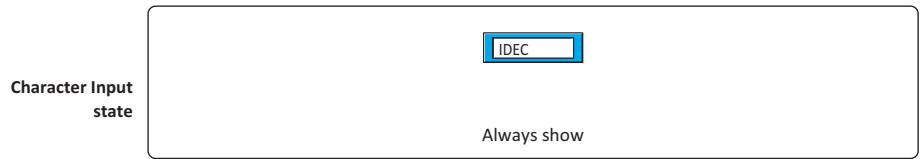

While ON: Displays the Character Input when the value of device address is 1.

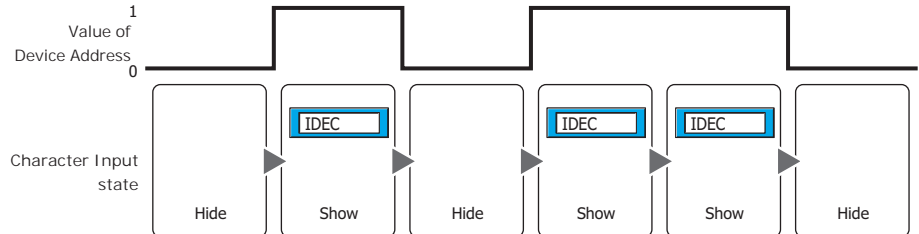

While OFF: Displays the Character Input when the value of device address is 0.

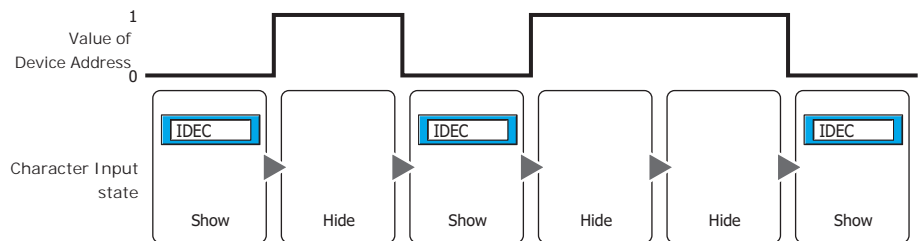

While satisfying the condition: Displays the Character Input when the condition is satisfied.

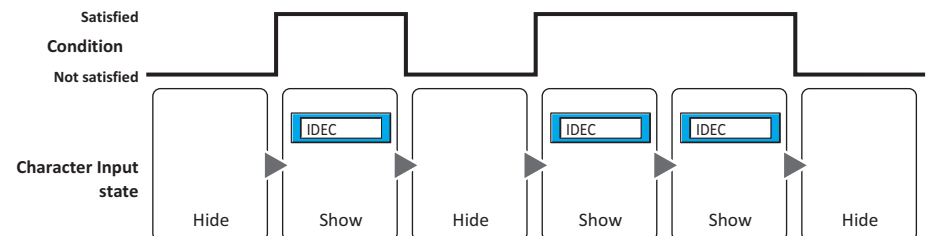

Data Type: Selects the type of data handled by the conditional expression for the visible condition.

This option can only be configured if **While satisfying the condition** is selected for **Trigger Type**. For details, refer to Chapter 2 "1.1 Available Data" on page 2-1.

Device Address: Specifies the bit device or the bit number of the word device to serve as the visible condition.

This option can only be configured when **While ON** or **While OFF** is selected for **Trigger Type**.

Click to display the Tag Editor. For the device address configuration procedure, refer to Chapter 2 "5.1 Device Address Settings" on page 2-70.

Condition: Specifies the conditional expression for the visible condition.

This option can only be configured when **While satisfying the condition** is selected for **Trigger Type**.

Click to display the **Trigger Condition Settings** dialog box. For the conditional expression configuration procedure, refer to Chapter 2 "5.2 Setting Conditional Expressions" on page 2-73.

Comment: Used for entering a comment for the visible condition. The maximum number is 80 characters.

● Options Tab

The **Options** tab is displayed in Advanced mode.

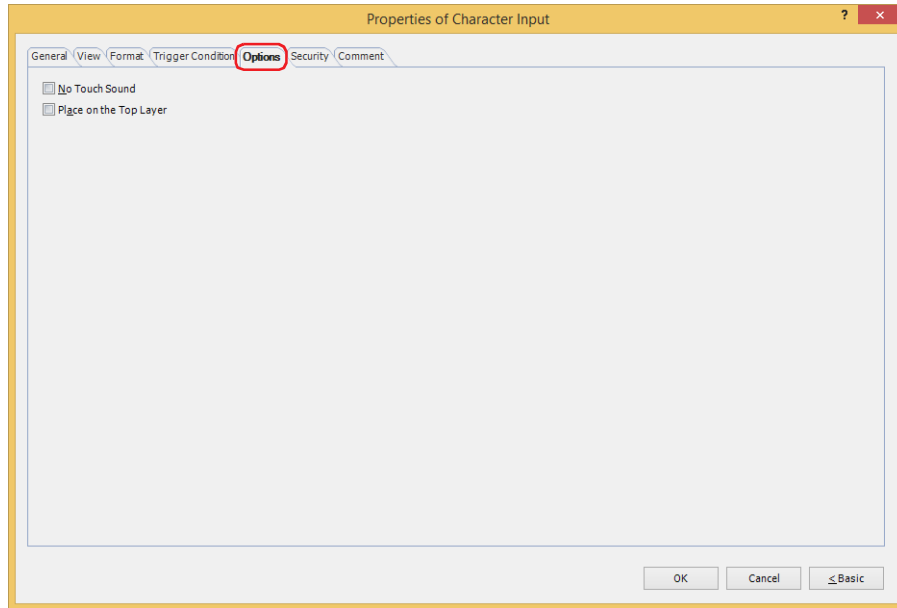

■ No Touch Sound

This function is to disable touch sounds only for specified parts when the MICRO/I makes touch sounds. Select this check box to display disable touch sounds for this part.



To enable touch sounds on the MICRO/I, select the **Enable Touch Sound** check box under the **System** tab of the **Project Settings** dialog box.

■ Place on the Top Layer

Select this check box to display the parts on the top layer. The parts will have precedence when other drawings and parts are overlapping with it. For details, refer to Chapter 6 “4 Drawings and Parts Overlapping” on page 6-5.

● Security Tab

This tab is used to restrict displaying and using the part by security groups.

This option can only be set when **Use Security functions** is selected. The **Use Security functions** check box is set on **General** tab in the **Security** dialog box.

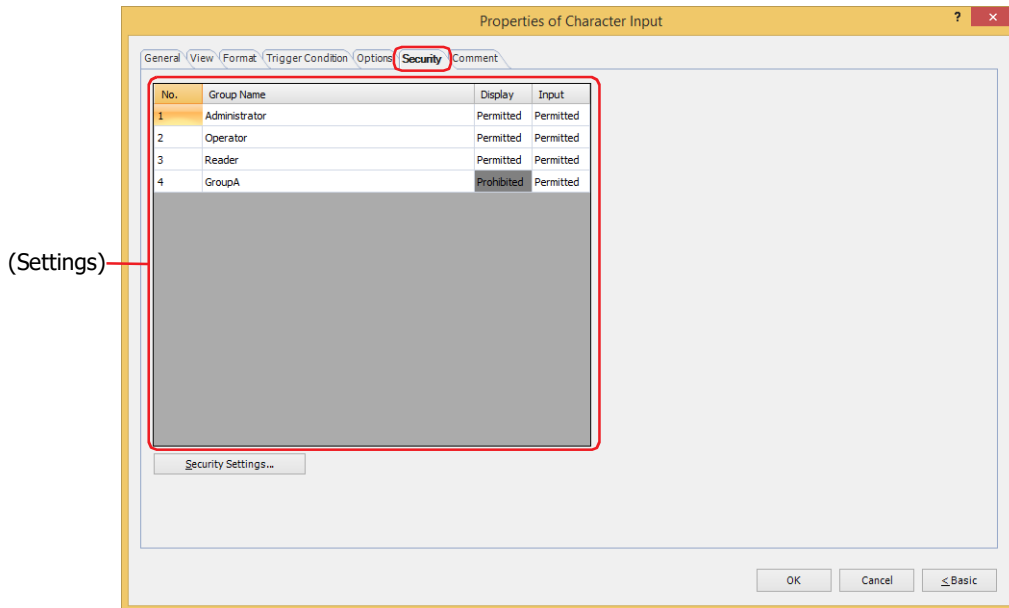

■ (Settings)

Displays the list of security groups used on the MICRO/I.

No.: Displays the security group numbers (1 to 15).

Group Name: Displays the name of the security group.

Display: Displays whether or not there is permission to display the part. Only **Permitted** security groups can display this part. If all security groups are set to **Permitted**, this part will be displayed even if no user account has been selected. Double clicking the cell switches between **Permitted** and **Prohibited**.

Input: Displays whether or not there is permission to use the part. Only **Permitted** security groups can use this part. If all security groups are set to **Permitted**, this part can be used even if no user account has been selected. Double clicking the cell switches between **Permitted** and **Prohibited**.



- You can also switch between **Permitted** and **Prohibited** by right-clicking on a **Display** or **Input** cell.
- Restricting the display and use of the part by switching between **Permitted** and **Prohibited** in **Display** and **Input** cells is similar to using the **Trigger Condition** tab.



■ Security Settings

The Security Settings dialog box is displayed. If you create a security group in the **Security Settings** dialog box, you can select that created group. For details, refer to Chapter 23 "2.2 Adding and Editing Security Groups" on page 23-19.



For details about security functions, refer to Chapter 23 "User Accounts and the Security Function" on page 23-1.

Example: If the user and security group for a part are set as follows:

User Name	 User1	 User2	 User3
Security Group	Reader	Operator	Administrator

Line Chart and Bar Chart

No.	Group Name	Display
1	Administrator	Permitted
2	Operator	Permitted
3	Reader	Prohibited

MICRO/I

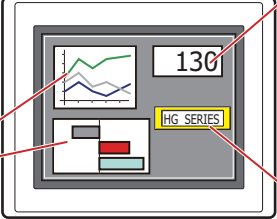

Numerical Display

No.	Group Name	Display
1	Administrator	Permitted
2	Operator	Permitted
3	Reader	Permitted

Character Input

No.	Group Name	Display	Input
1	Administrator	Permitted	Permitted
2	Operator	Permitted	Prohibited
3	Reader	Prohibited	Prohibited

For User1 in the **Reader** security group, the parts for which **Display** has been set to **Prohibited** for **Reader** will not be displayed.

If the password screen is opened and the user switches to User2 in the **Operator** security group, the parts for which **Display** has been set to **Permitted** for **Operator** will be displayed.

MICRO/I

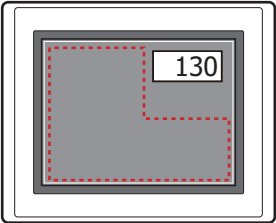

 For User1, parts for which Display has been set to Prohibited for Reader are not displayed

MICRO/I

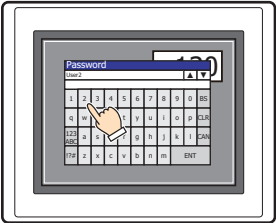

Open Password Screen, enter password, and switch to User2

MICRO/I

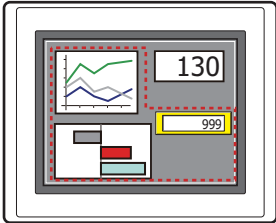



 For User2, parts for which Display has been set to Permitted for Operator are displayed

For User2 in **Operator**, **Display** has been set to **Permitted** for **Operator**, but **Input** is **Prohibited**, so the Character Input cannot be used.

If the password screen is opened and the user switches to User3 in the **Administrator** security group, the parts for which **Display** has been set to **Permitted** for **Administrator** will be displayed, and the parts for which **Input** has been set to **Permitted** for **Administrator** can be used.

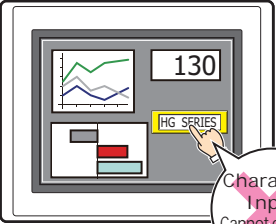
MICRO/I



 For User2, parts for which Display has been set to Permitted for Operator are displayed, but parts for which Input has been set to Prohibited cannot be used

MICRO/I

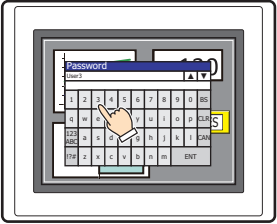

Open Password Screen, enter password, and switch to User3

MICRO/I

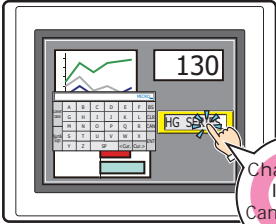

 For User3, parts for which Display has been set to Permitted for Administrator are displayed, and parts for which Input has been set to Permitted can be used

● Comment Tab

The **Comment** tab is used to specify the parts placed on the editing screen, and the popup text displayed when the mouse pointer is placed close to **No.**, **Name**, or **Type** in the object list.



When there are multiple parts of the same shape on the screen, this feature makes it possible to distinguish between the parts without displaying the Properties dialog box for each part, by just mousing over the part.

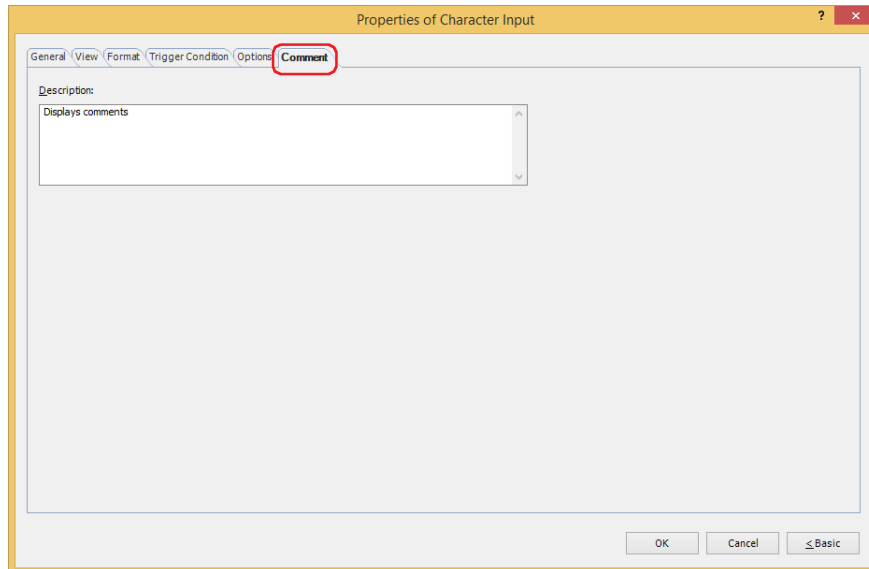

■ Description

Used for entering comments about parts. Maximum number is 80 characters.

Example: When mousing over the Character Input on the editing screen

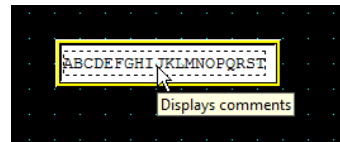

2.4 How to Enter Text

Use the keypad or key buttons to write character codes to device addresses with the Character Input. The input methods are as follows.

■ Pressing the Character Input and Entering Text from the Standard Keypad

Arrange a Character Input on the screen and in its properties dialog box, on the **General** tab, under **Keypad**, select **Standard** for **Type**.

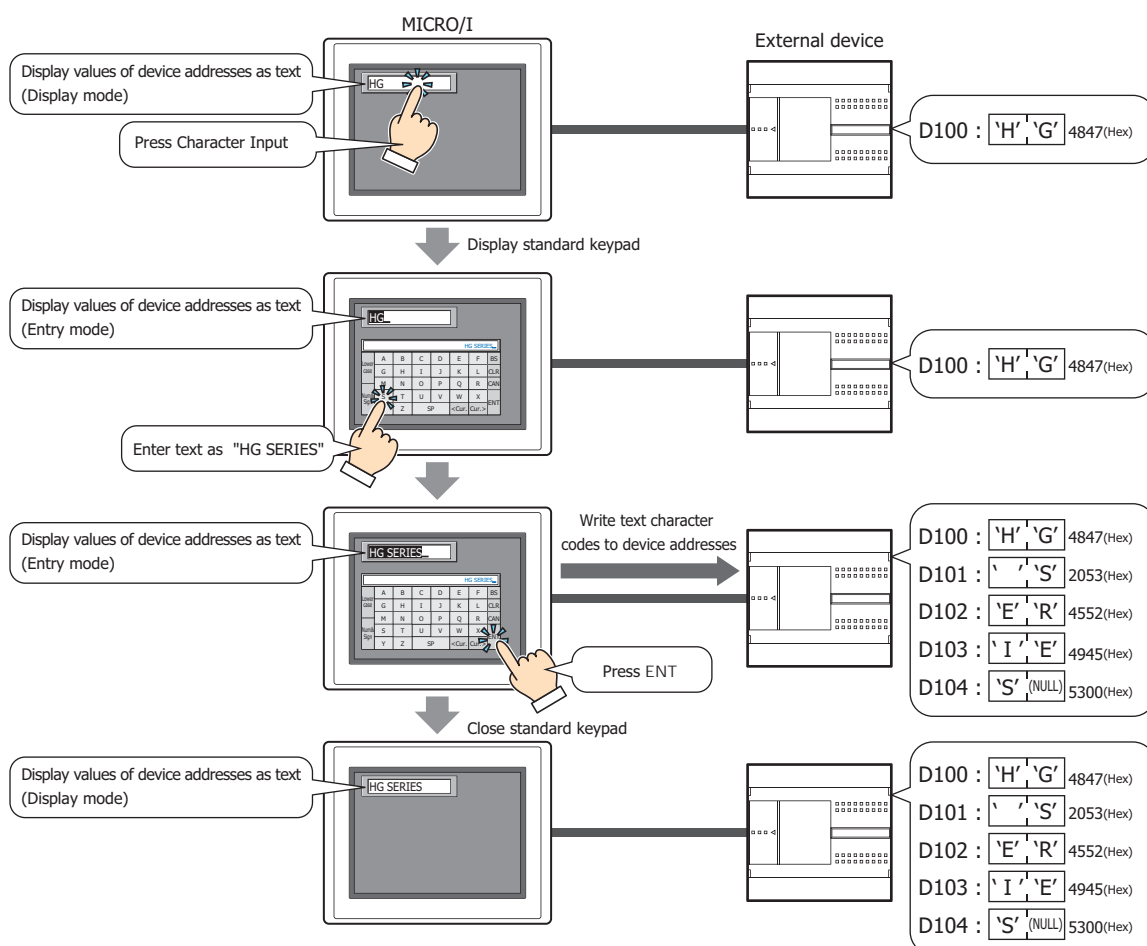

When the following operations are performed, entry mode is canceled and the current values of device addresses are displayed as character codes on the Character Input. To enter text, press the Character Input again to select it and set it to entry mode.

- **CAN** was pressed
- When the **Focus is moved by ENT button** check box on the **General** tab is cleared and **ENT** was pressed and a value was written to the device address

■ Without Pressing the Character Input, Directly Entering Text from a Keypad on the Same Screen

Arrange a Character Input and a keypad on the same screen. In the properties dialog box for the Character Input, on the **General** tab, under **Keypad**, select **Current Screen** for **Type** and select the **Always Entry Mode** check box.

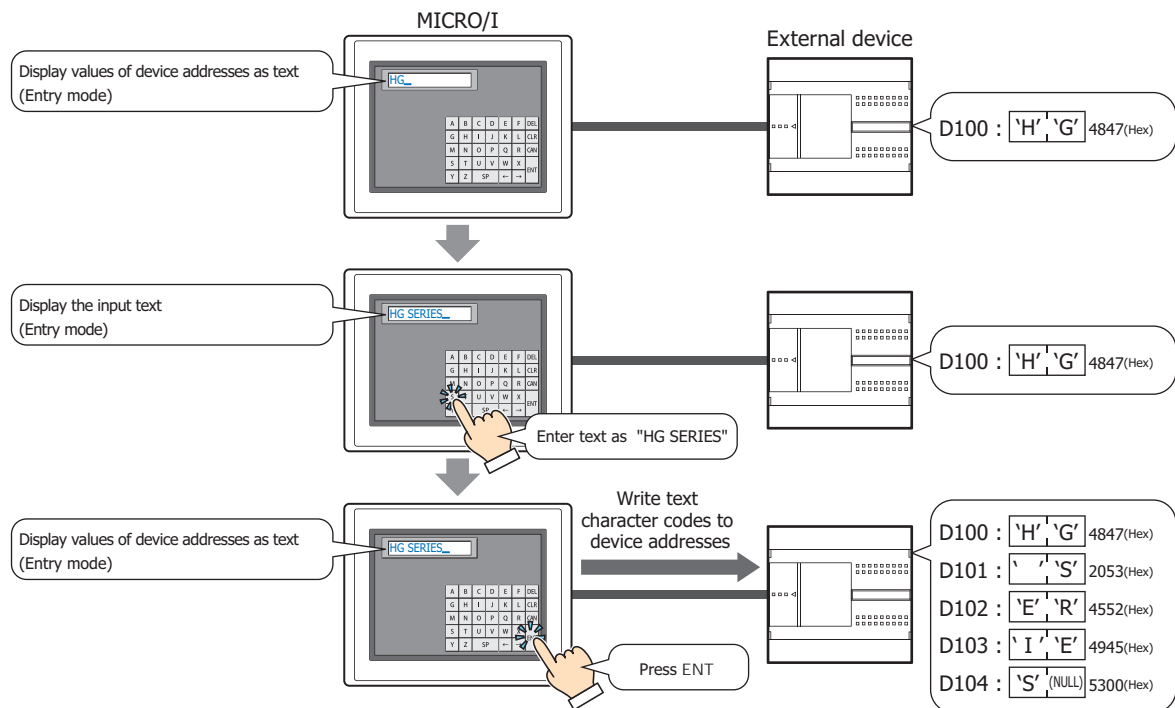

■ Changing the Language and Entering Text

Select the **Change Font with Device Address** check box on the **Format** tab in the properties dialog box.

It is convenient to use this setting together with the text group settings.

The font and popup screen with this setting will change simultaneously with the text group change and text can be entered with the same font as the text group.

Specify the same device address in the **Change Text Group by Device Address** on **Text Manager** as the **Trigger Device Address** for this setting.

2.5 Character Input Usage Examples

- Enter Kanji characters

HG2J-7U HG5G-V HG4G-V HG4G HG3G-V HG3G HG2G-V HG2G-5F HG2G-5T HG1G HG1P

Using the Standard Keypad Popup Screen (Screen number: 3008) for inputting Kanji characters, enter Kanji characters in the Character Input.

Configuration Procedure

- 1 On the **Home** tab, in the **Parts** group, click **Data Displays**, and then click **Character Input**.

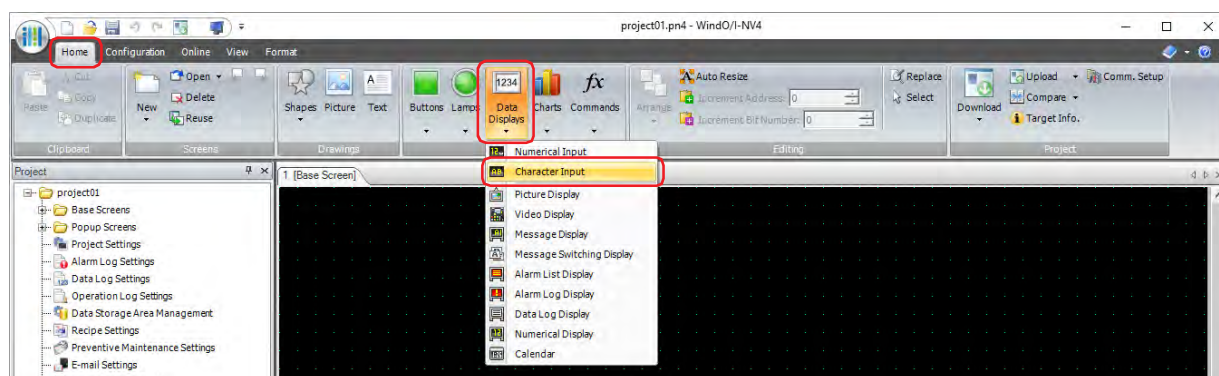

- 2 Click a point on the edit screen where you place the Character Input.
- 3 Double-click the placed Character Input and a Properties dialog box will be displayed.

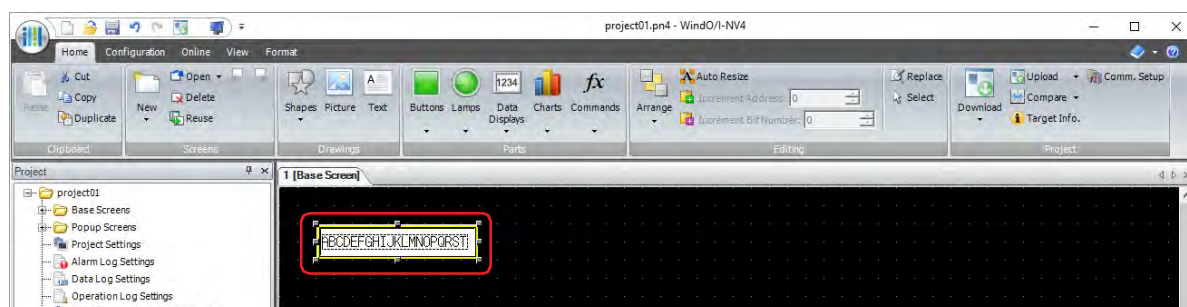

- 4 Select the **Standard(Hiragana)** as the **Type** on the **General** tab.

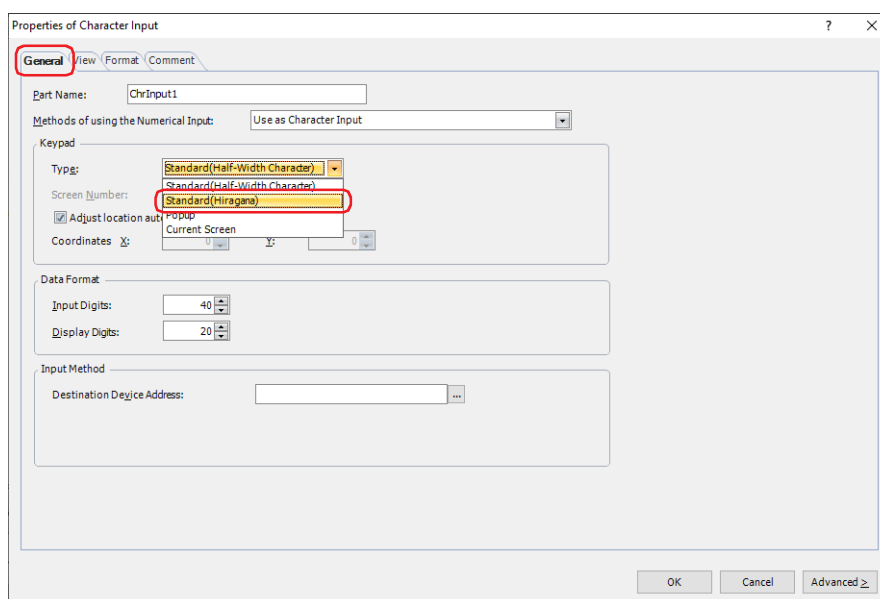

- 5 Click the **Format** tab, select the **Japanese** as the **Font**, and then select the **16x16** as the **Size**.

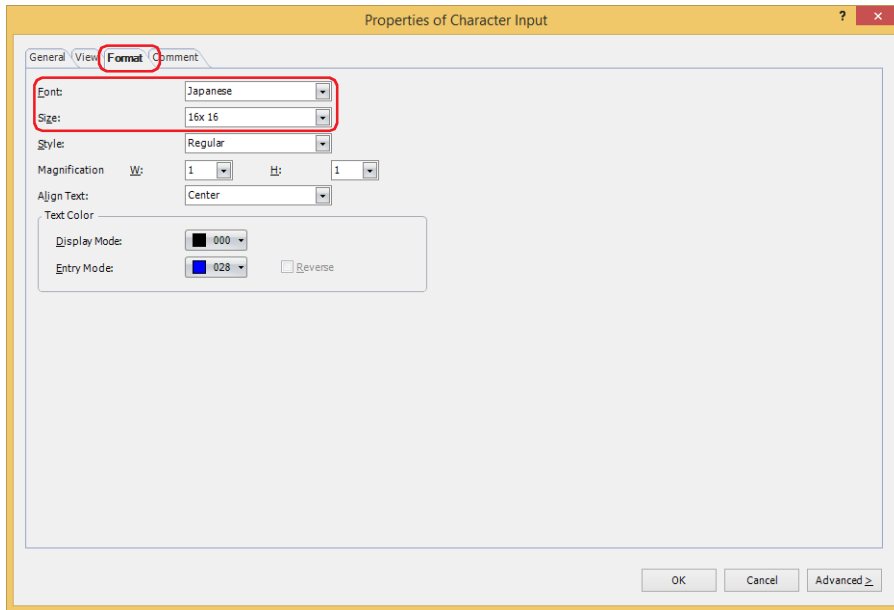

- 6 Click **OK**.

The Properties of **Character Input** dialog box closes.

- 7 On the **Configuration** tab, in the **System Setup** group, click **Project**.

The **Project Settings** dialog box is displayed.

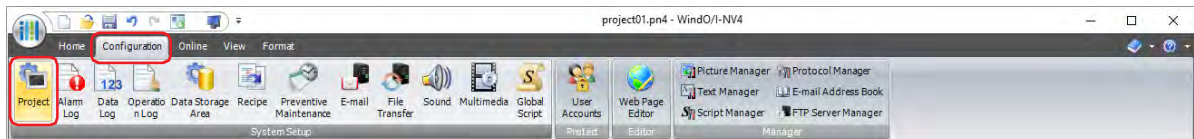

- 8 Click the **Font/Kanji Dictionary Data** tab, and then select the **Use Kanji dictionary data** check box.

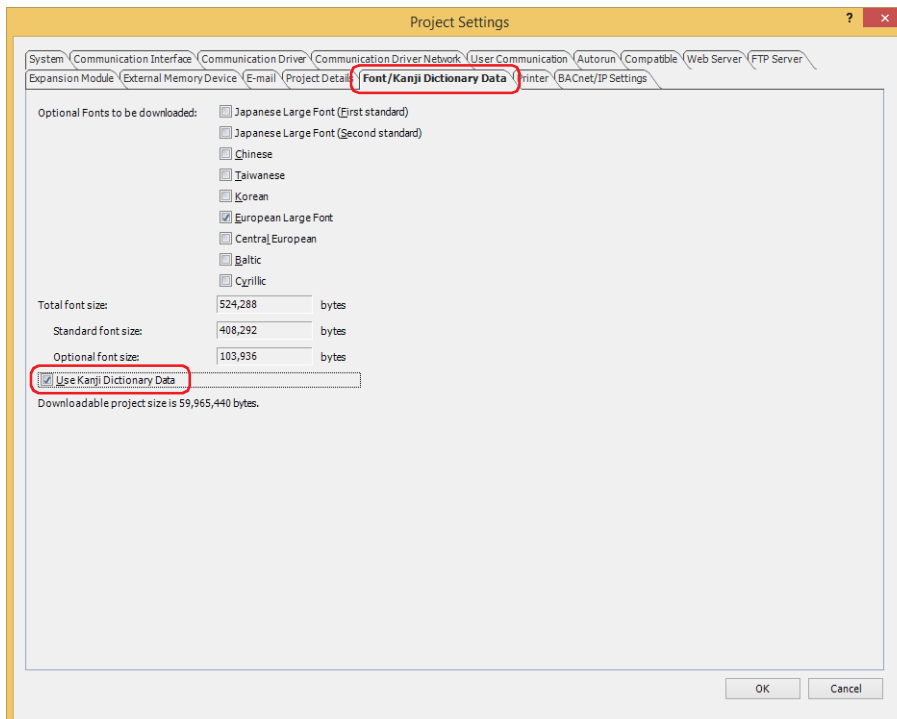

- 9 Click **OK**.

- 10 On the **Home** tab, in the **Project** group, click the **Download** icon.
The **Download** dialog box is displayed.

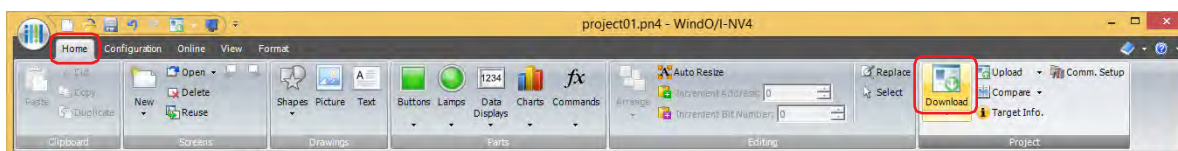

If the project data was changed, a confirmation message to save the project data is displayed.

Click **OK** to save the project data and display the Download dialog box.

Click **Cancel** to return to the editing screen without saving the project data.

- 11 Select the **Download Fonts and Kanji Dictionary Data** check box.

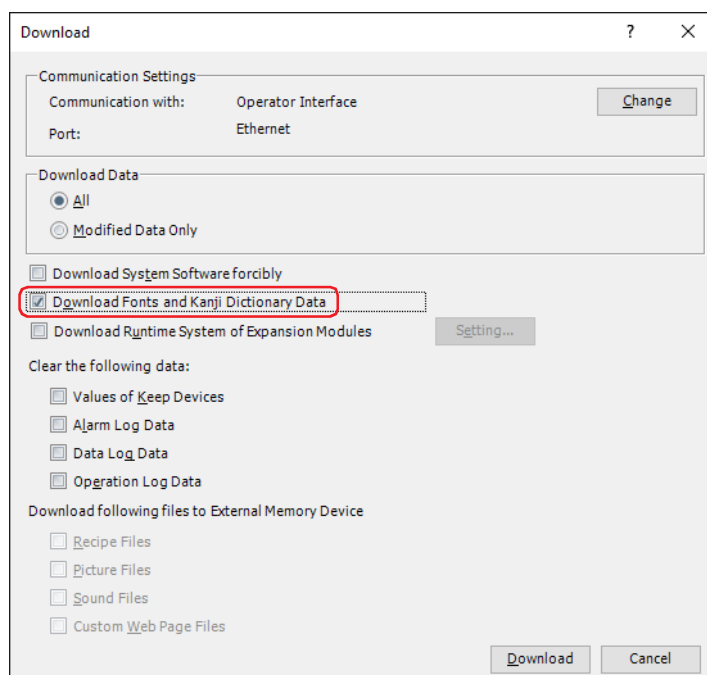

- 12 Verify **Communication Settings** and click **Download**.

Since the recipe files are downloaded to the external memory device inserted in the MICRO/I, use the same settings as when communicating with the MICRO/I.

To change **Communication Settings**, click **Change** to display the **Communication Settings** dialog box. **Change Communicate with, Port, and Baud Rate**. For details, refer to Chapter 24 "1 Communicating with the MICRO/I" on page 24-1.



If security is enabled in the MICRO/I project, the Password Screen is displayed. Select the user name and enter the password. For details, refer to Chapter 23 "User Accounts and the Security Function" on page 23-1.

- 13 On the confirmation message, click **Yes**.
The **Download Project** dialog box is displayed and the project files start downloading.
When finished downloading, an information message is displayed.
- 14 Click **OK** on the information message.
You are returned to the **Download** dialog box.
- 15 Click **Close** on the **Download** dialog box.

This concludes configuring the settings to enter Kanji characters to Character Input.

Operating Procedure

This section describes an example of entering the Kanji characters " 山田太郎 " to the Character Input.

- 1 Press the Character Input for entering the Kanji characters.

The popup screen for the standard keypad (screen number 3008) will be displayed.

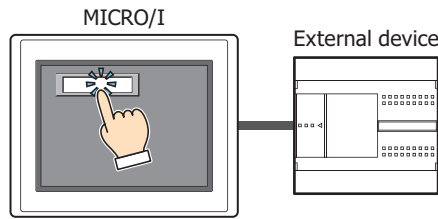

- 2 Press the **Kanji** to switch it to Kanji input mode.

[Cursor]										<Cur>	Cur>
あ	か	さ	た	な	は	ま	や	ら	わ	BS	
い	き	し	ち	に	ひ	み	ゆ	り	を	CLR	
う	く	す	つ	ぬ	ふ	む	よ	る	ん	CAN	
え	け	せ	て	ね	へ	め	、	れ		ENT	
お	こ	そ	と	の	ほ	も	。	ろ			
SP							—	↑			
Kanji	Alphabet	Num&Sign	Small ` °							↓	

A hand is pointing at the 'Kanji' button in the bottom row.

- 3 Enter the reading of Kanji with Hiragana.

The maximum number is 32 characters.

Example: Press " や ", " ま ", " た " and then "Small ` ° " when you enter " やまだ ".

やまだ										<Cur>	Cur>
あ	か	さ	た	な	は	ま	や	ら	わ	BS	
い	き	し	ち	に	ひ	み	ゆ	り	を	CLR	
う	く	す	つ	ぬ	ふ	む	よ	る	ん	CAN	
え	け	せ	て	ね	へ	め	、	れ		ENT	
お	こ	そ	と	の	ほ	も	。	ろ			
SP							—	↑			
Kanji	Alphabet	Num&Sign	Small ` °							↓	

Numbered hand icons indicate the sequence of inputs: 1 on 'や', 2 on 'ま', 3 on 'た', and 4 on the 'Small ` °' button.

4 Press **SP** to display conversion candidates.As necessary, press **SP**, **↑** or **↓** to change the conversion candidates.

やまだ										<Cur	Cur>
山田	た	な	は	ま	や	ら	わ	BS			
山だ	ち	に	ひ	み	ゆ	り	を	CLR			
やまだ	つ	ぬ	ふ	む	よ	る	ん	CAN			
ヤマダ											
ヤマだ											
え	け	せ	て	ね	へ	め	、	れ			
お	こ	そ	と	の	ほ	も	。	ろ			
SP										—	↑
Kanji	Alphabet	Num&Sign	Small ° °								↓

5 Press **ENT** to apply the entered characters.

山田										<Cur	Cur>
あ	か	さ	た	な	は	ま	や	ら	わ	BS	
い	き	し	ち	に	ひ	み	ゆ	り	を	CLR	
う	く	す	つ	ぬ	ふ	む	よ	る	ん	CAN	
え	け	せ	て	ね	へ	め	、	れ			
お	こ	そ	と	の	ほ	も	。	ろ			
SP										—	↑
Kanji	Alphabet	Num&Sign	Small ° °								↓



Characters exceeding the number of Input Digits or the number of Display Digits are deleted.

6 Repeat steps 2 through 5 to enter all the characters.

山田たろう										<Cur	Cur>
あ	太郎	な	は	ま	や	ら	わ	BS			
い	たろう	に	ひ	み	ゆ	り	を	CLR			
う	タロウ	ぬ	ふ	む	よ	る	ん	CAN			
え	け	せ	て	ね	へ	め	、	れ			
お	こ	そ	と	の	ほ	も	。	ろ			
SP										—	↑
Kanji	Alphabet	Num&Sign	Small ° °								↓

- 7 Press **ENT** to enter characters to the Character Input.

The Shift_JIS code of the entering characters are written to the device address.

山田太郎_										<Cur	Cur>
あ	か	さ	た	な	は	ま	や	ら	わ	BS	
い	き	し	ち	に	ひ	み	ゆ	り	を	CLR	
う	く	す	つ	ぬ	ふ	む	よ	る	ん	CAN	
え	け	せ	て	ね	へ	め	、	れ		ENT 	
お	こ	そ	と	の	ほ	も	。	ろ			
SP							—	↑			
Kanji	Alphabet	Num&Sign	Small ` °							↓	

This concludes entering Kanji characters to the Character Input.



On the simulator, you can not enter Kanji characters with the Character Input.

2.6 String Data Storage Method

The entered text is stored in the upper byte and lower byte according to the **Storage Method of String Data** setting. **Storage Method of String Data** is configured on the **System** tab in the **Project Settings** dialog box. For details, refer to Chapter 4 "3.1 System Tab" on page 4-25.

Example 1: When the destination device address is "LDR100" and the entered text is "ABCDE"

- When **from Upper byte** is selected for **Storage Method of String Data**

Device address	Stored value	
	Upper byte	Lower byte
LDR100	'A' = 41 (Hex)	'B' = 42 (Hex)
LDR101	'C' = 43 (Hex)	'D' = 44 (Hex)
LDR102	'E' = 45 (Hex)	0

NULL terminating character

- When **from Lower byte** is selected for **Storage Method of String Data**

Device address	Stored value	
	Upper byte	Lower byte
LDR100	'B' = 42 (Hex)	'A' = 41 (Hex)
LDR101	'D' = 44 (Hex)	'C' = 43 (Hex)
LDR102	0	'E' = 45 (Hex)

NULL terminating character

Example 2: When the destination device address is "LDR100" and the entered text is "完了"

- When **from Upper byte** is selected for **Storage Method of String Data**

Device address	Stored value	
	Upper byte	Lower byte
LDR100	8A (Hex)	AE (Hex)
LDR101	97 (Hex)	B9 (Hex)
LDR102	0	

NULL terminating character

‘完’
‘了’

- When **from Lower byte** is selected for **Storage Method of String Data**

Device address	Stored value	
	Upper byte	Lower byte
LDR100	AE (Hex)	8A (Hex)
LDR101	B9 (Hex)	97 (Hex)
LDR102		0

NULL terminating character

‘完’
‘了’



When handling strings, 0 is written to the device as the NULL terminating character and treated as the end of the string.

2.7 Advanced Usage

● Using the System Area

- When finished entering text by pressing **ENT**, 1 is written to the System Area 2 Character Input Setting Complete bit (address number+3, bit 5).
- When **CAN** is pressed, entry mode is canceled and 1 is written to the System Area 2 Character Input Setting Cancel bit (address number+3, bit 6). However, if the keypad is closed by pressing (close) on the popup screen's title bar or another Character Input is pressed and selected before finished entering the text by pressing **ENT**, entry mode is canceled and 1 is not written to the System Area 2 Character Input Setting Cancel bit (address number+3, bit 5).
- To clear the System Area 2 character input setting complete bit or the character input setting cancel bit, write 1 to System Area 1 Character Input Setting Clear bit (address number+1, bit 11). To automatically clear these bits when the Character Input keypad is pressed in entry mode, select the **Clear Keypad bit in System Area automatically** check box on the **System** tab in the **Project Settings** dialog box.

3 Picture Display

HG2J-7U HG5G-V HG4G-V HG4G HG3G-V HG3G HG2G-V HG2G-5F HG2G-5T HG1G HG1P

3.1 How the Picture Display is Used

The Picture Display displays pictures. It can change, move, or scale the displayed picture according to value of device address.

- Switch and display pictures by value of device address

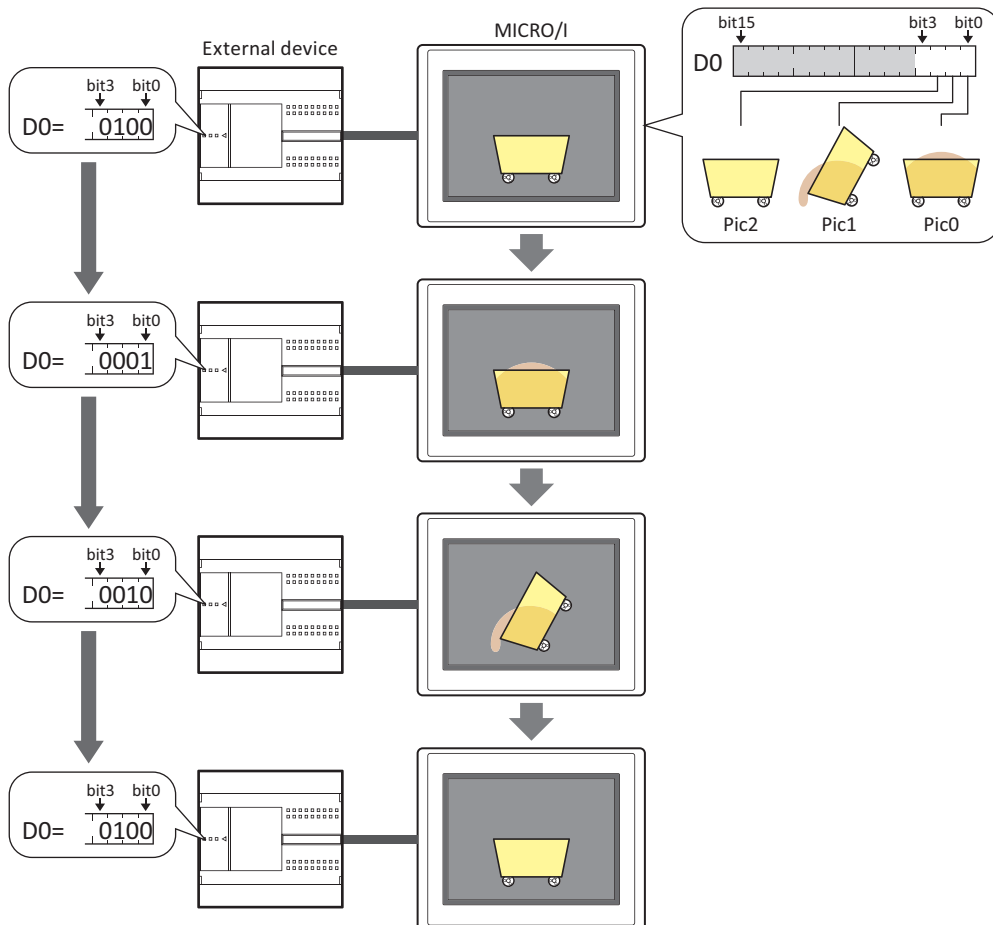

- Switch and display pictures at a regular interval

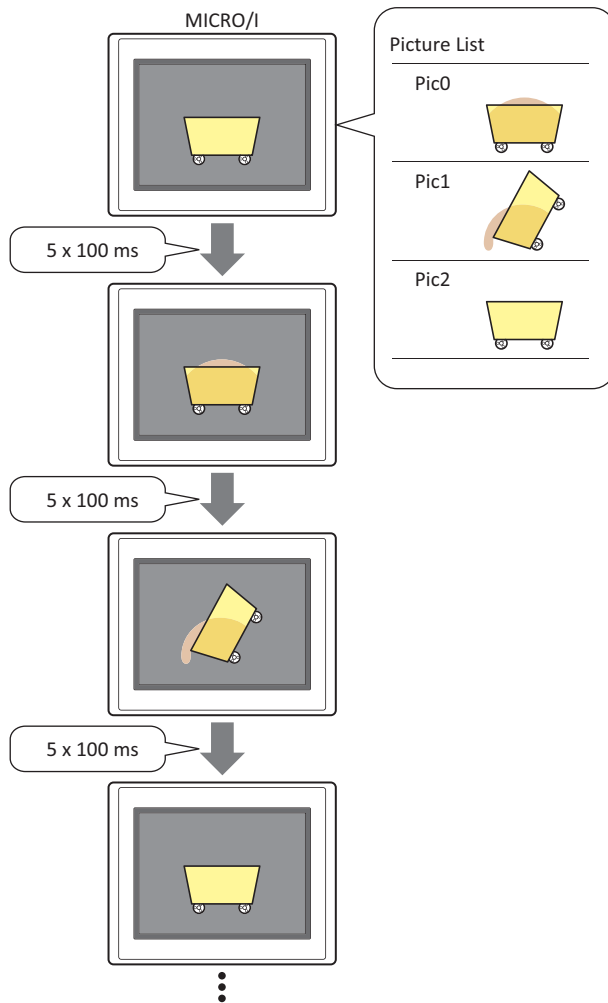

- Move the picture position by values of device addresses

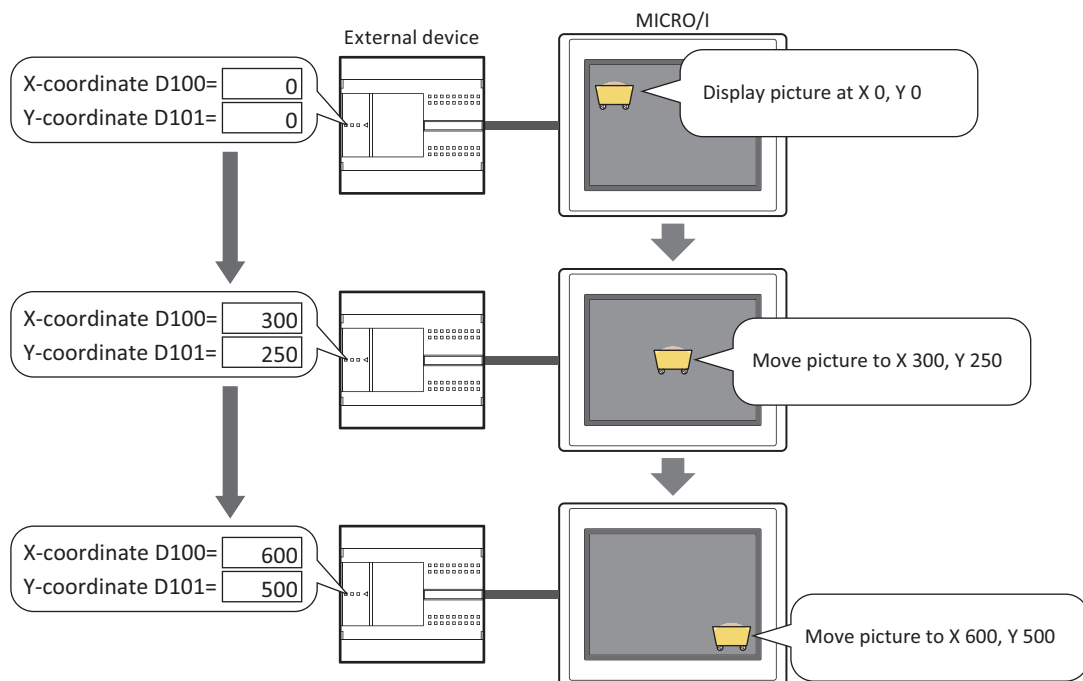

- Scale the size of the picture by values of device addresses and display it

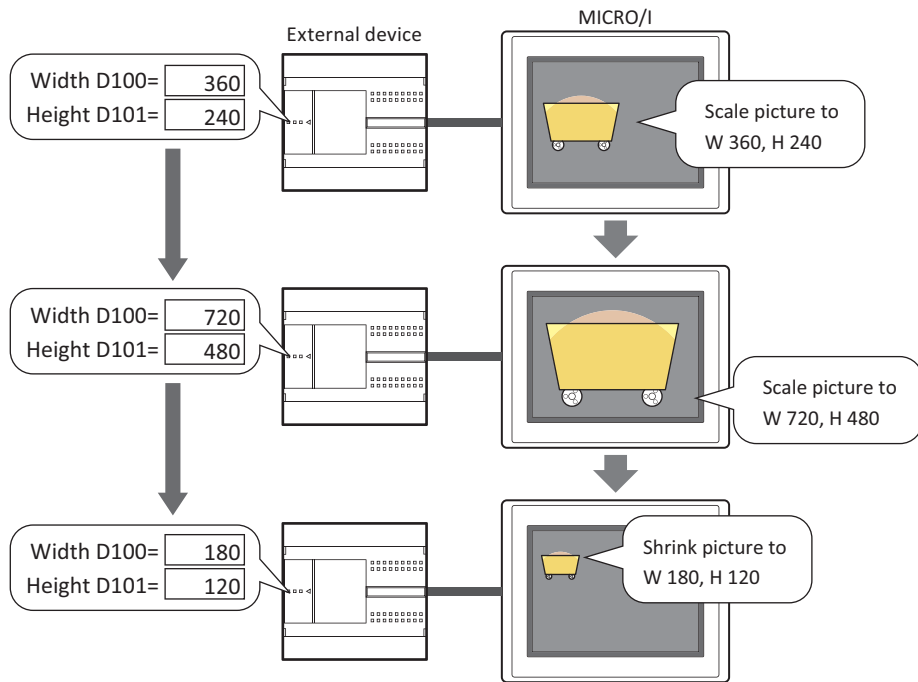

When the size of pictures to switch differs and the **Dynamic Size** check box is cleared, all the pictures are displayed with the same size as Pic0.

- Rotate the picture by values of device addresses and display it

This example shows a 0° start angle of rotation at the minimum value of 0 and a 90° end angle of rotation at the maximum value of 100.

The pivot point of rotation is the position at X Point 0 and Y Point 500 from the center of picture.

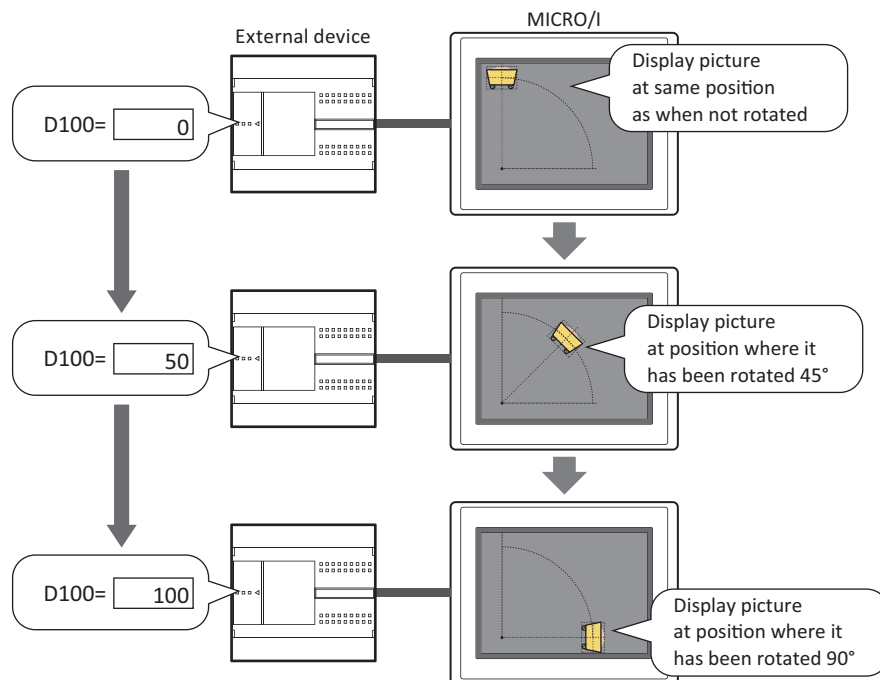

3.2 Picture Display Configuration Procedure

This section describes the configuration procedure for Picture Displays.

- 1 On the **Home** tab, in the **Parts** group, click **Data Displays**, and then click **Picture Display**.

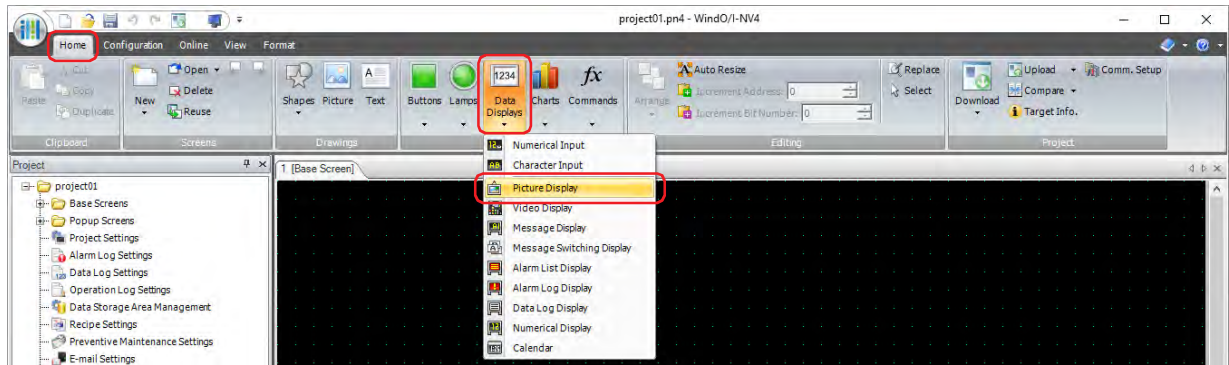

- 2 Click a point on the edit screen where you wish to place the Picture Display.
- 3 Double-click the placed Picture Display and a Properties dialog box will be displayed.
- 4 Change the settings on each tab as necessary.

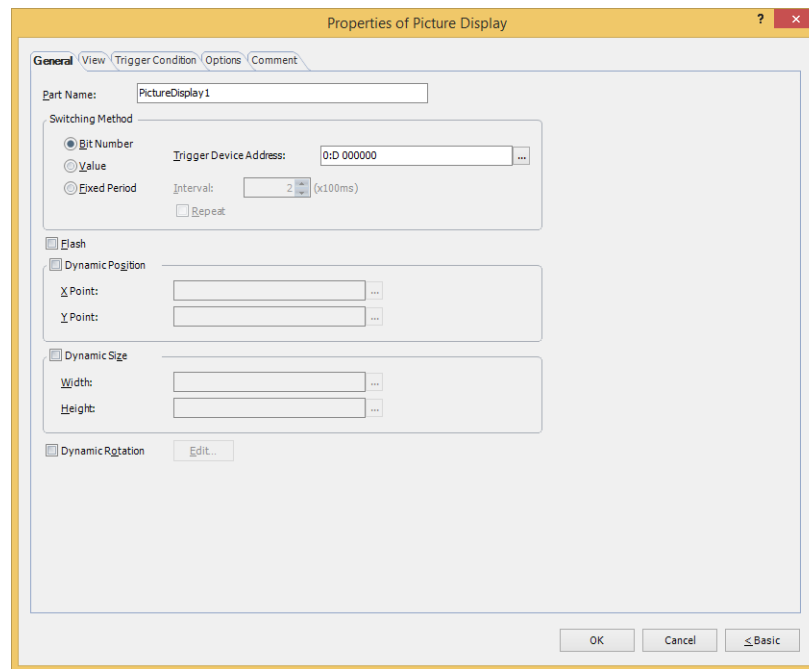

The **Trigger Condition** tab and **Options** tab only appear in **Advanced** mode.



You can set the default for the Picture Display on the **Default Preferences** tab of the **WindO/I-NV4 Options** dialog box. For details, refer to Chapter 2 "Default Preferences Tab" on page 2-63.

3.3 Properties of Picture Display Dialog Box

This section describes items and buttons on the properties dialog box.

● General Tab

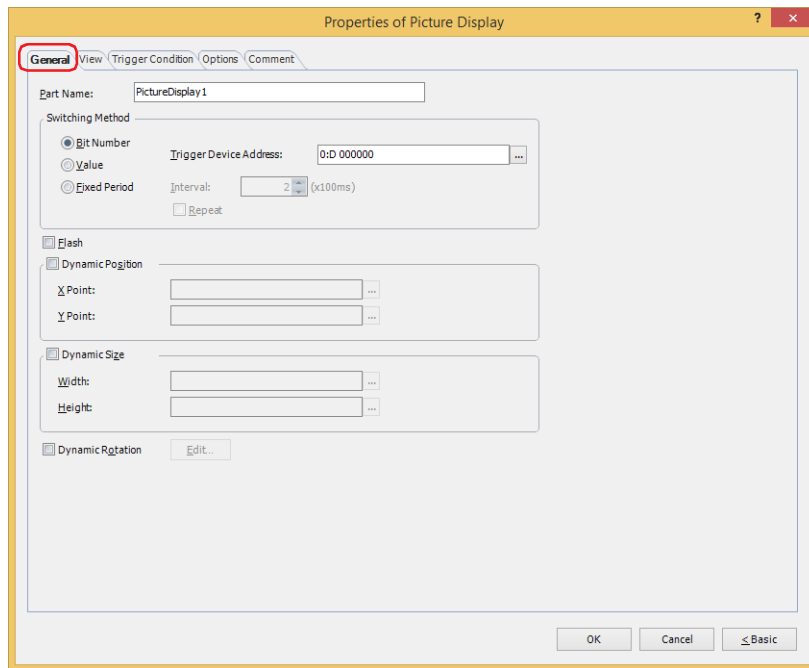

■ Part Name

Enter a name for the part. The maximum number is 20 characters.

■ Switching Method

Specifies the method for switching pictures to display from the following. Register pictures in **Picture List** on the **View** tab.

Bit Number:

Switches the picture to display according to the status of bits in a device address.

Example: When **Bit Number** is selected and the bits of trigger device address D0 are allocated to the following pictures.

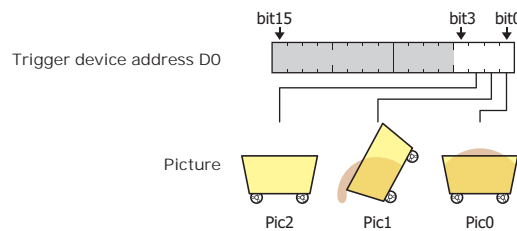

Switches the picture to display according to the status of the bits.

Trigger device address D0 bit state	0001	0010	0100	1000	1110	1100
Picture to display						
Action	Display picture for bit 0	Display picture for bit 1	Display picture for bit 2	No picture	Display picture for bit 1	Display picture for bit 2

If multiple bits are 1, display the picture for the lowest order bit.

If all bits in the device address are 0 or if a bit with no associated picture becomes 1, display nothing.

Value: Switches the picture to display according to the value of the device address.

Example: When **Value** is selected and the trigger device addresses D0 are allocated to the following pictures.

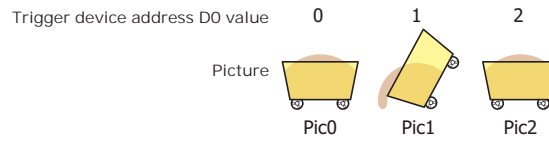

Switches the picture to display according to the value of the device address.

Trigger device address	0	1	2	3
D0 value				
Picture to display				
Action	Display picture for 0	Display picture for 1	Display picture for 2	No picture

If the value of device address has no picture associated with it, display nothing.

Trigger Device Address: Specifies the word device to use as the condition for switching pictures.

Click to display the Tag Editor. For the device address configuration procedure, refer to Chapter 2 "5.1 Device Address Settings" on page 2-70.

This option can only be configured when **Bit Number** or **Value** is selected.



When the size of pictures to switch differs and the **Dynamic Size** check box is cleared, all the pictures are displayed with the same size as Pic0.

Fixed Period: Switches the pictures to display at a regular interval in picture number order on the picture list.

Example: When **Fixed Period** is selected and the following pictures are allocated to the picture list.

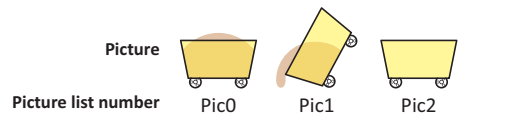

Switches the pictures to display at a regular interval in picture number order on the picture list.

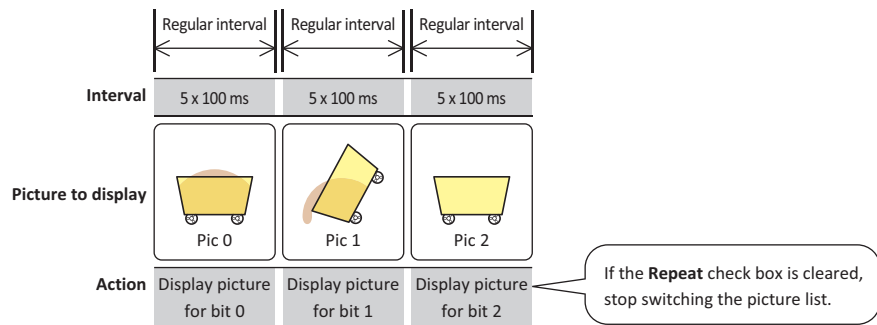

Interval: Specifies the interval to switch pictures as 2 to 600 (100 ms units). This option can only be configured when **Fixed Period** is selected.

Repeat: Select this check box to repeat displaying pictures from the start of the picture list when the picture at the end of the list is displayed. This option can only be configured when **Fixed Period** is selected.



When **Fixed Period** is selected, the picture may not be displayed when the interval is shorter than the scan time for the screen on the MICRO/I. The maximum value for the MICRO/I scan time can be checked by the value of HMI Special Data Register LSD4. Refer to Chapter 33 "HMI Special Data Register (LSD)" on page 33-8.

■ **Flash**

Select this check box to flash the displayed pictures. The picture is repeatedly shown and hidden.

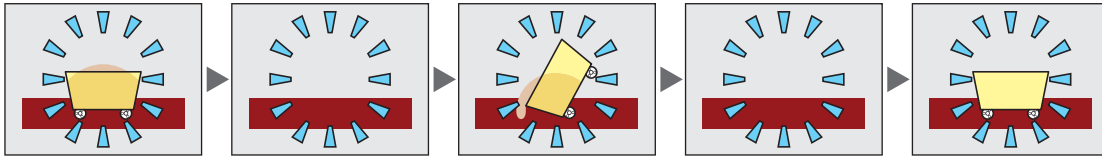

■ **Dynamic Position *1**

Select this check box to move and display the picture by specifying the coordinates of the picture as values of device addresses.

X Point: Specifies the word device that is the X-coordinate of the picture.

Click to display the Tag Editor. For the device address configuration procedure, refer to Chapter 2 "5.1 Device Address Settings" on page 2-70.

Y Point: Specifies the word device that is the Y-coordinate of the picture.

Click to display the Tag Editor. For the device address configuration procedure, refer to Chapter 2 "5.1 Device Address Settings" on page 2-70.

Example: When a device address for the X-coordinate is D100 and a device address for the Y-coordinate is D101
The picture is moved to the values of D100 and D101.

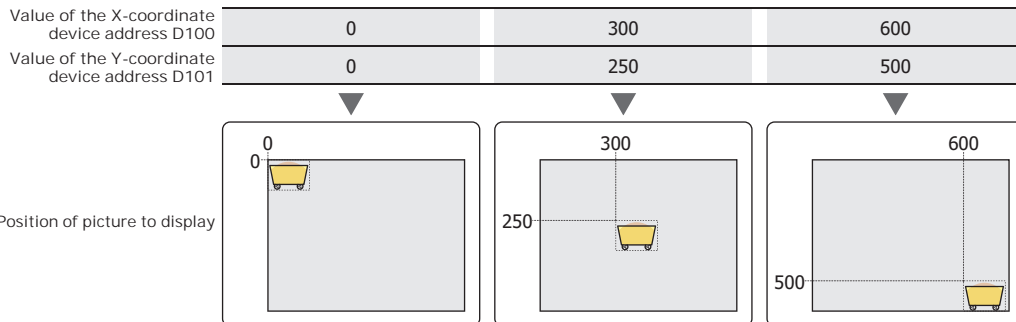

■ **Dynamic Size *1**

Select this check box to scale the picture by specifying the size of the picture as values of device addresses.

Width: Specifies the word device that is the width of the picture.

Click to display the Tag Editor. For the device address configuration procedure, refer to Chapter 2 "5.1 Device Address Settings" on page 2-70.

Height: Specifies the word device that is the height of the picture.

Click to display the Tag Editor. For the device address configuration procedure, refer to Chapter 2 "5.1 Device Address Settings" on page 2-70.

Example: When a device address for the width is D100 and a device address for the height is D101
The picture is displayed with its size scaled to the values of D100 and D101.

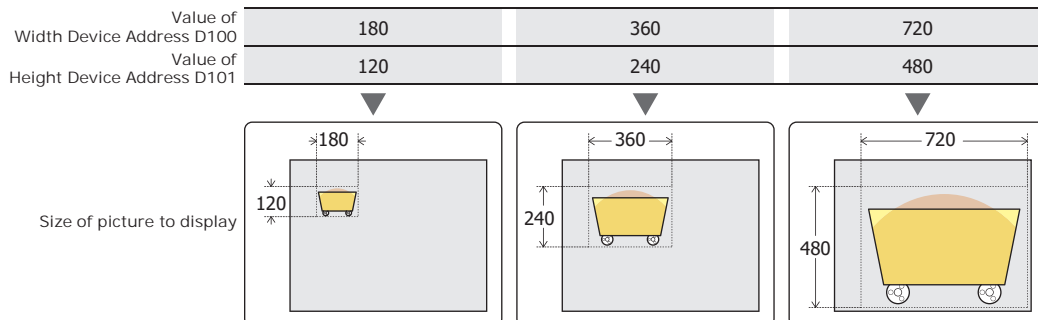

The top layer cannot be set when the **Dynamic Size** check box is selected.

*1 Advanced mode only

■ **Dynamic Rotation**

Select this check box to rotate and display a picture.

Edit: Configures details for rotating and displaying a picture.

Click this button to display the **Dynamic Rotation** dialog box. For details, refer to "Dynamic Rotation Dialog Box" on page 10-64.



Only the top layer is valid if the picture is NMF (NV Metafile).



When the size of pictures to switch differs and the **Dynamic Size** check box is cleared, all the pictures are displayed with the same size as Pic0.



When moving and scaling pictures, set the values of device addresses so the picture is not moved or scaled outside the screen's display area.

Dynamic Rotation Dialog Box

Configures details for rotating and displaying a picture.

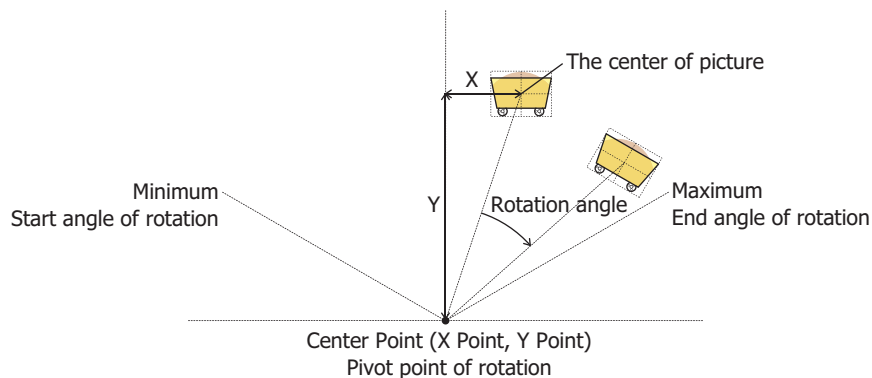

- **Source Device Address**

Specifies the word device to be read that holds the value of the rotation angle of the picture.

Click to display the Tag Editor. For the device address configuration procedure, refer to Chapter 2 "5.1 Device Address Settings" on page 2-70.

- **Data Type**

Selects the type of data that will be used to rotate the picture.

For details, refer to Chapter 2 "1.1 Available Data" on page 2-1.

- **Use Custom Settings**

Select this check box to configure the range of values to read from the Source Device Address, the range of the rotation angle, the coordinate point of the center point that will serve as the pivot point for rotation.

When this check box is cleared, rotate the picture with the minimum value is 0, the maximum value is a fixed value specified in the **Maximum** under the **Range of Value**, and the Range of Angle to rotate is 0 to 360 degrees.

■ Range of Value

Configures the range of values to read from the Source Device Address with a fixed value or a value of device address.

Converts the read value to the specified angle range, and then rotate the picture.

This option can only be configured when the **Use Custom Settings** check box is selected. When the **Use Custom Settings** check box is cleared, only the **Maximum** can be specified with a fixed value.

Value: Specifies the range of values to read from the Source Device Address as a constant.

Device Address: Specifies the range of values to read from the Source Device Address as a value of word device.

Specifies the range of values that corresponds to the range of angle.

Minimum, Maximum: Specifies the minimum and maximum values.

If **Value** is selected, the minimum and maximum values that can be specified will depend on the data type selected by **Data Type**. For details about data types, refer to Chapter 2 "1.1 Available Data" on page 2-1.

If **Device Address** is selected, specify the word device to be read. Click  to display the Tag Editor. For the device address configuration procedure, refer to Chapter 2 "5.1 Device Address Settings" on page 2-70.



When the Minimum is bigger than the Maximum, the picture is not rotated.

■ Range of Angle

Configures the range of the rotation angle with a fixed value or a value of device address. This option can only be configured when the **Use Custom Settings** check box is selected.

Value: Specifies the range of angle for rotation as a constant.

Device Address: Specifies the range of angle for rotation as a value of word device.

Specifies the range of angle for rotation.

Start, End: Specifies the start angle of rotation (-360° to 360°) and the end angle of rotation (-360° to 360°).

If **Value** is selected, the start and end angles that can be specified will depend on the data type selected by **Data Type**. For details about data types, refer to Chapter 2 "1.1 Available Data" on page 2-1.

If **Device Address** is selected, specify the word device to be read. Click  to display the Tag Editor. For the device address configuration procedure, refer to Chapter 2 "5.1 Device Address Settings" on page 2-70.



The direction of rotation is as follows.

Start angle < End angle: Clockwise

Start angle > End angle: Counterclockwise

■ **Center Point**

Configures the coordinate point of the center point that will serve as the pivot point for rotation with a fixed value or a value of device address. This option can only be configured when the **Use Custom Settings** check box is selected.

Value: Specifies the coordinate point of the center point that will serve as the pivot point for rotation as a constant.

Specify from Picture: Click this button to display the Specify from Picture dialog box. You can specify the coordinates of the center point using the preview that you actually rotate a picture. For details, refer to "Specify from Picture dialog box" on page 10-67. This option can only be configured when Value is selected.

Device Address: Specifies the coordinate point of the center point that will serve as the pivot point for rotation as a value of word device.

Specifies the coordinate point of the center point that will serve as the pivot point for rotation. The center point is relative coordinate point with the center of picture as the origin.

X, Y: Specifies the X Point (-32,768 to 32,767) and the Y Point (-32,768 to 32,767).
If **Value** is selected, the coordinate points that can be specified will depend on the data type selected by **Data Type**. For details about data types, refer to Chapter 2 "1.1 Available Data" on page 2-1.

If **Device Address** is selected, specify the word device to be read. Click to display the Tag Editor. For the device address configuration procedure, refer to Chapter 2 "5.1 Device Address Settings" on page 2-70.



- Coordinate points outside the screen's display area can also be specified as the pivot point of rotation.
- If the size of both the width and height of the pictures is odd, the center of picture is the origin.
If the width is even, the left side of the center of picture is the origin. If the height is even, the top side of the center of picture is the origin.

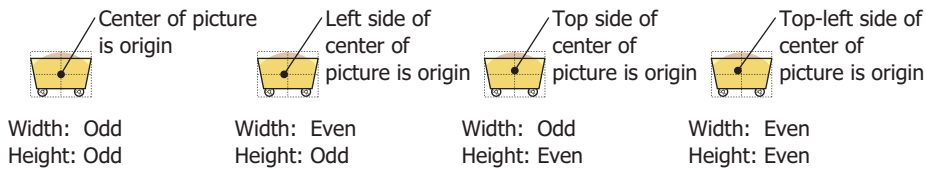

Example: When the source device address is D100, the minimum value is 0, the maximum value is 100, the start angle of rotation is 0°, the end angle of rotation is 90°, the X coordinate point of the center point is 0, and the Y coordinate point of the center point is 500

The picture will rotate according to the value of D100 as shown below.

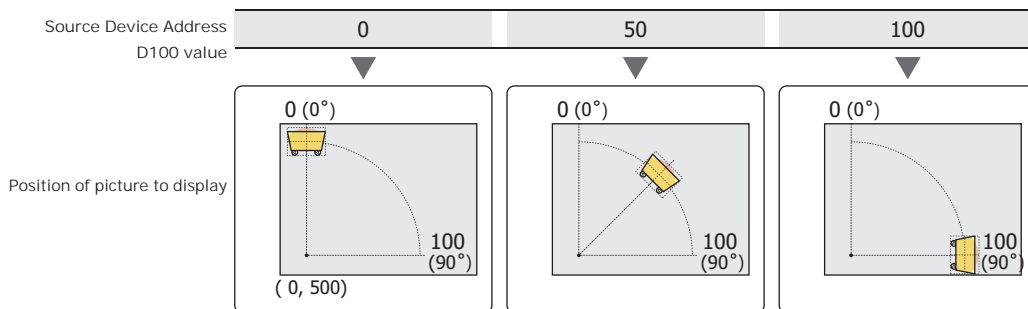

- When the picture is switched after being rotated, the picture after being switched will also be displayed with the same settings and in the same rotated state.
- When a picture is rotated and displayed on a popup screen, the portion of the picture that extends past the popup screen will not be displayed.
- If the drawing position of the picture changes due to changing the angle or pivot point, parts placed underneath the picture will be displayed partially missing on the base screen and popup screen. Parts on the top layer will be fully displayed.

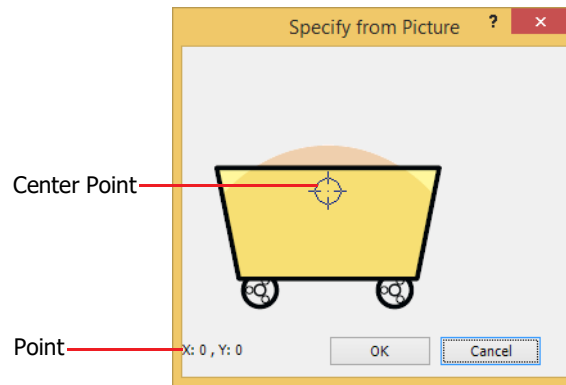
Specify from Picture dialog box

To specify the center point that will serve as the pivot point for rotation, perform one of the following operations. For the coordinates, the X-coordinate and Y-coordinate of the center point are displayed with the center of the picture as the origin.

- Double-click on the displayed picture.
- Select and drag the mark indicating the center point or move with the cursor key.

● View Tab

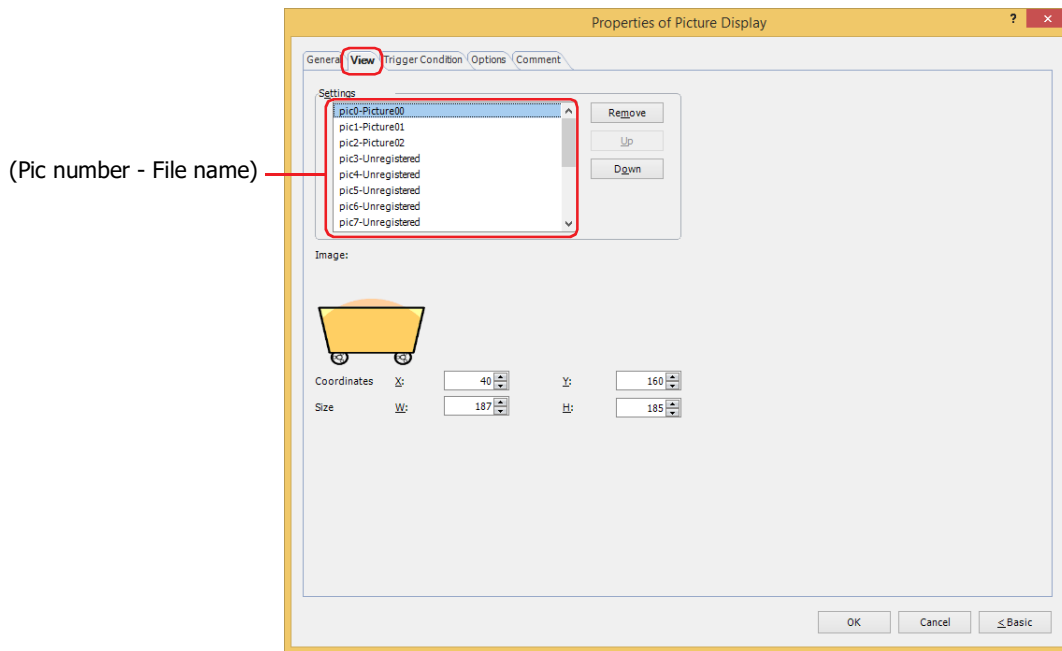

■ Settings

Registers the pictures to display on the Picture Display.

(Pic number - File name): Registers the pictures to display.

Double clicking the cell displays the Picture Manager where you can specify the picture. The picture number (Pic number) and the file name of the registered picture are displayed.

Remove: Deletes the registered picture from the list.

Up: Shifts the selected settings upward in the list.

Down: Shifts the selected settings downward in the list.

■ Image

Displays picture for the Pic number that has been selected in the Picture List.

■ Coordinates

X, Y: Sets the display position of parts using coordinates.

The X and Y coordinates of parts is defined relative to an origin at the top-left corner of the screen.

X: 0 to (base screen horizontal size - 1)

Y: 0 to (base screen vertical size - 1)

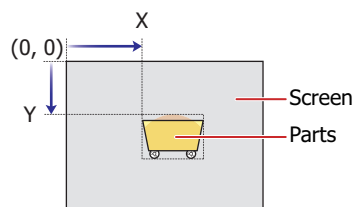

*1 Advanced mode only

■ Size

W, H: Sets width and height to define the size of parts.

W: 2 to (base screen horizontal size)

H: 2 to (base screen vertical size)

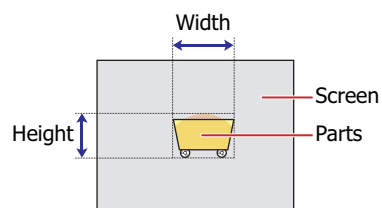

● **Trigger Condition Tab**

The **Trigger Condition** tab is displayed in Advanced mode.

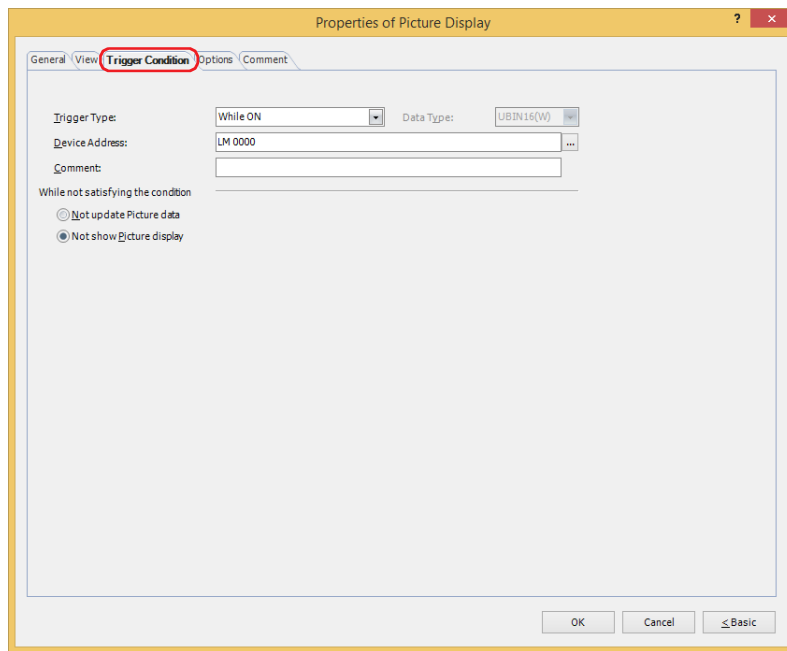

The Picture Display is enabled while the condition is satisfied, and it is disabled while the condition is not satisfied. Select the operation when the condition is not satisfied as **Not update Picture data** or **Not show Picture Display** under **While not satisfying the condition**.

Example: When **Trigger Type** is **While ON**, **Device Address** is **LM0**, and **While not satisfying the condition** is **Not show Picture Display**
 While LM0 is 0, the condition is not satisfied and the Picture Display does not display the picture.
 While LM0 is 1, the condition is satisfied and the Picture Display displays the picture.

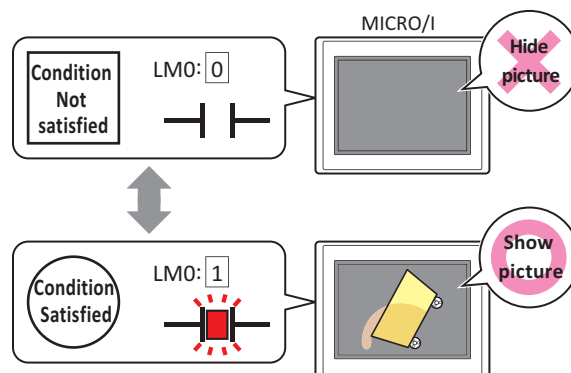

■ **Trigger Type**

Selects the condition to enable the Picture Display from the following.

Always visible: The Picture Display is always enabled.

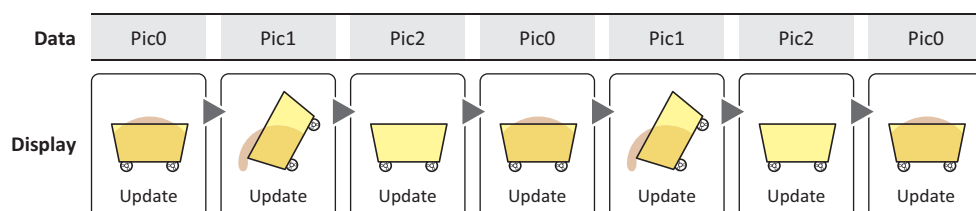

While ON: Enables the Picture Display when the value of device address is 1.

Example: When **While not satisfying the condition** is **Not update Picture data**

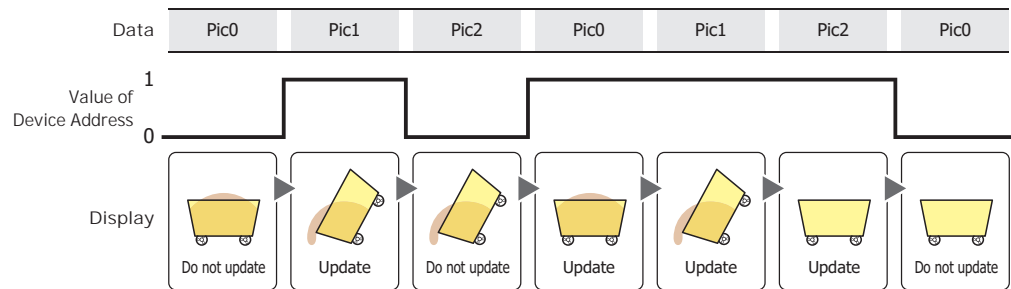

While OFF: Enables the Picture Display when the value of device address is 0.

Example: When **While not satisfying the condition** is **Not update Picture data**

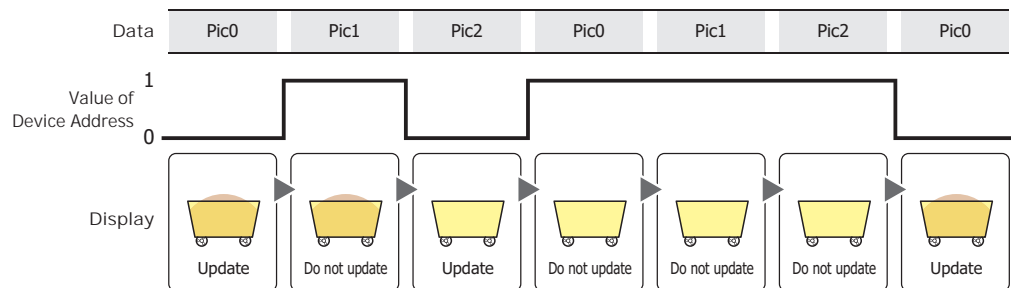

While satisfying the condition: Enables the Picture Display when the condition is satisfied.

Example: When **While not satisfying the condition** is **Not update Picture data**

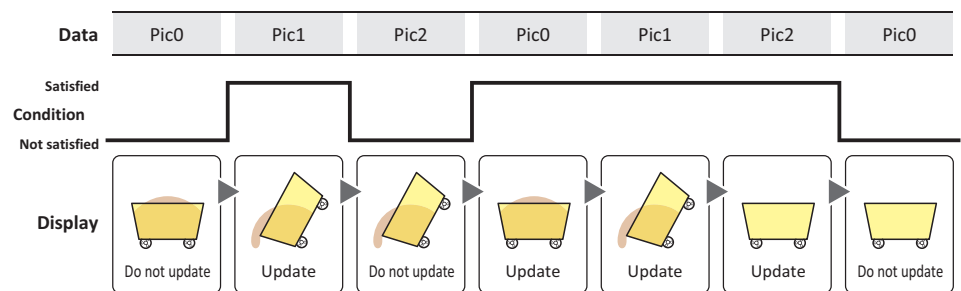

■ Data Type

Selects the data type to be handled by the condition formula.

Can only be set if **While satisfying the condition** is selected as **Trigger Type**.

For details, refer to Chapter 2 "1.1 Available Data" on page 2-1.

■ Device Address

Specifies the bit device or the bit number of the word device to serve as condition.

Can only be set if **While ON** or **While OFF** is selected as **Trigger Type**.

Click  to display the Tag Editor. For the device address configuration procedure, refer to Chapter 2 "5.1 Device Address Settings" on page 2-70.

■ Condition

Sets the condition formula.

Can only be set if **While satisfying the condition** is selected as **Trigger Type**.

Click  to display the **Trigger Condition Settings** dialog box. For the conditional expression configuration procedure, refer to Chapter 2 "5.2 Setting Conditional Expressions" on page 2-73.

■ Comment

Used for entering comments about trigger conditions. Maximum number is 80 characters.

■ While not satisfying the condition

Selects operation of parts when condition is not satisfied.

Not update Picture data: The last updated graphic is displayed. The graphic does not change.

Not show Picture Display: Graphic is not displayed.

● **Options Tab**

The **Options** tab is displayed in Advanced mode.

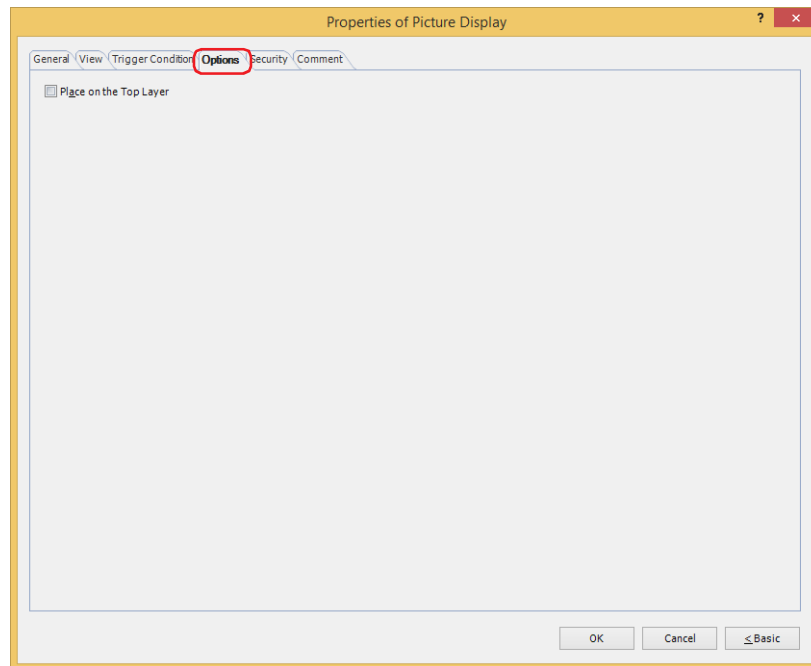

■ **Place on the Top Layer**

Select this check box to display the parts on the top layer. The parts will have precedence when other drawings and parts are overlapping with it. For details, refer to Chapter 6 "4 Drawings and Parts Overlapping" on page 6-5.

● Security Tab

This tab is used to restrict displaying and using the part by security groups.

This option can only be set when **Use Security functions** is selected. The **Use Security functions** check box is set on **General** tab in the **Security** dialog box.

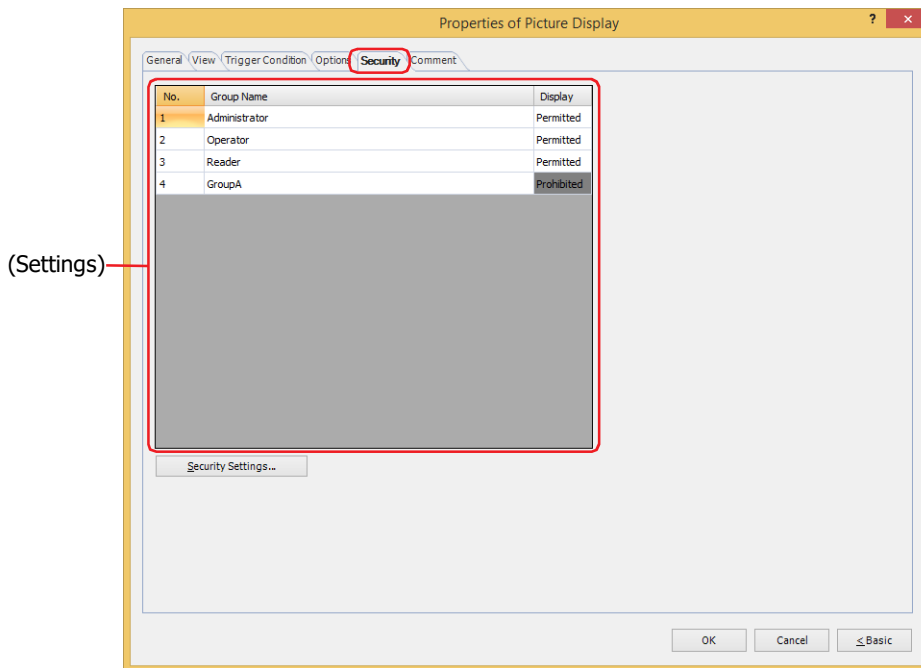

■ (Settings)

Displays the list of security groups used on the MICRO/I.

No.: Displays the security group numbers (1 to 15).

Group Name: Displays the name of the security group.

Display: Displays whether or not there is permission to display the part. Only **Permitted** security groups can display this part. If all security groups are set to **Permitted**, this part will be displayed even if no user account has been selected. Double clicking the cell switches between **Permitted** and **Prohibited**.



You can also switch between **Permitted** and **Prohibited** by right-clicking on a **Display** cell.



■ Security Settings

The Security Settings dialog box is displayed. If you create a security group in the **Security Settings** dialog box, you can select that created group. For details, refer to Chapter 23 "2.2 Adding and Editing Security Groups" on page 23-19.



For details about security functions, refer to Chapter 23 "User Accounts and the Security Function" on page 23-1.

Example: If the user and security group for a part are set as follows:

User Name	 User1	 User2
Security Group	Reader	Operator

Line Chart and Bar Chart

No.	Group Name	Display
1	Administrator	Permitted
2	Operator	Permitted
3	Reader	Prohibited

MICRO/I

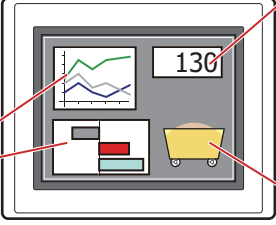

Numerical Display

No.	Group Name	Display
1	Administrator	Permitted
2	Operator	Permitted
3	Reader	Permitted

Picture Display

No.	Group Name	Display
1	Administrator	Permitted
2	Operator	Permitted
3	Reader	Prohibited

For User1 in the **Reader** security group, the parts for which **Display** has been set to **Prohibited** for **Reader** will not be displayed.

If the password screen is opened and the user switches to User2 in the **Operator** security group, the parts for which **Display** has been set to **Permitted** for **Operator** will be displayed.

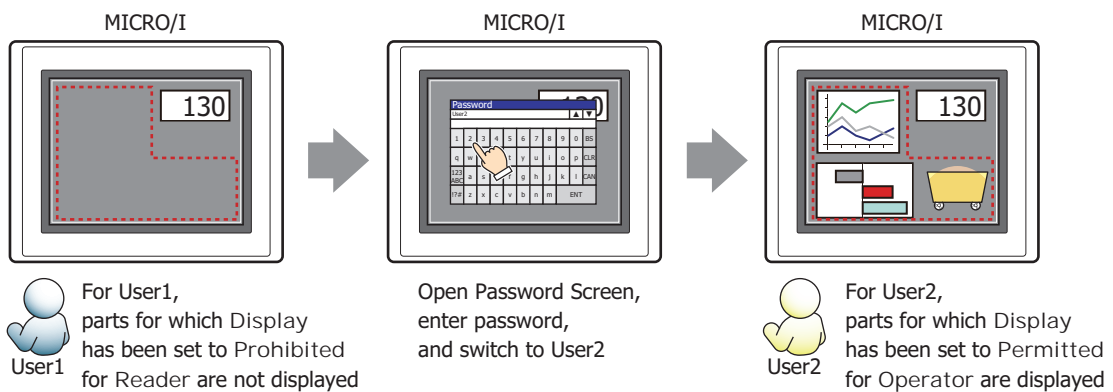

● Comment Tab

The **Comment** tab is used to specify the parts placed on the editing screen, and the popup text displayed when the mouse pointer is placed close to **No.**, **Name**, or **Type** in the object list.



When there are multiple parts of the same shape on the screen, this feature makes it possible to distinguish between the parts without displaying the Properties dialog box for each part, by just mousing over the part.

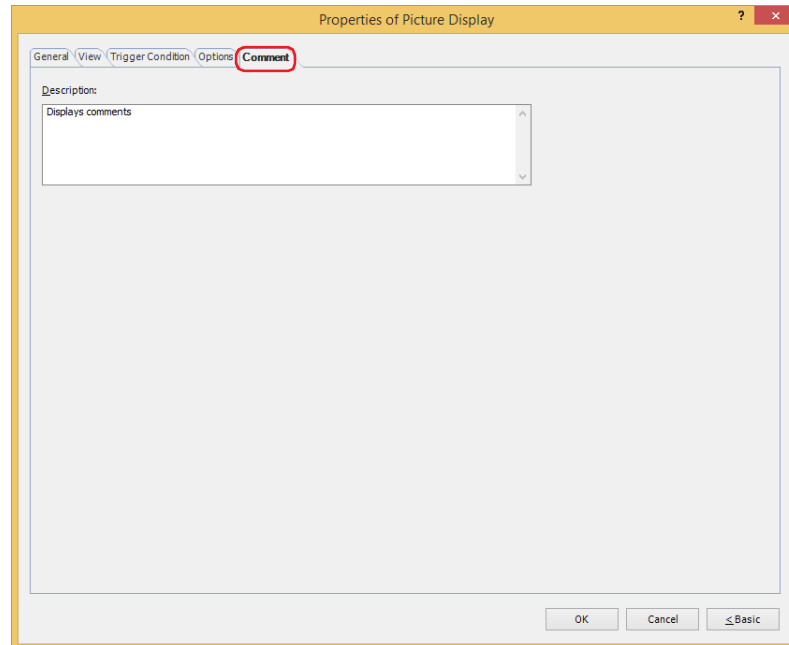

■ Description

Used for entering comments about parts. Maximum number is 80 characters.

Example: When mousing over the Picture Display on the editing screen

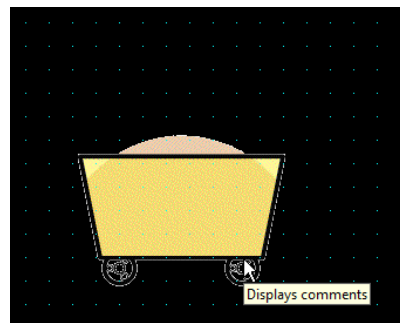

3.4 Picture Display Usage Examples

● Rotating and Displaying a Picture

This example shows rotating and displaying a picture by the values of device addresses.

- 1 On the **Home** tab, in the **Parts** group, click **Data Displays**, and then click **Picture Display**.

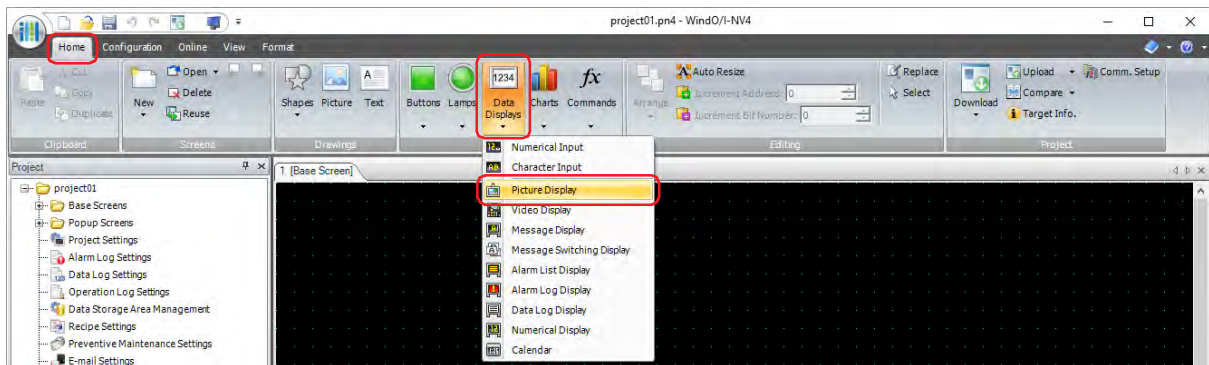

- 2 Click a point on the edit screen where you wish to place the Picture Display.
- 3 Double-click the placed Picture Display and a Properties dialog box will be displayed.

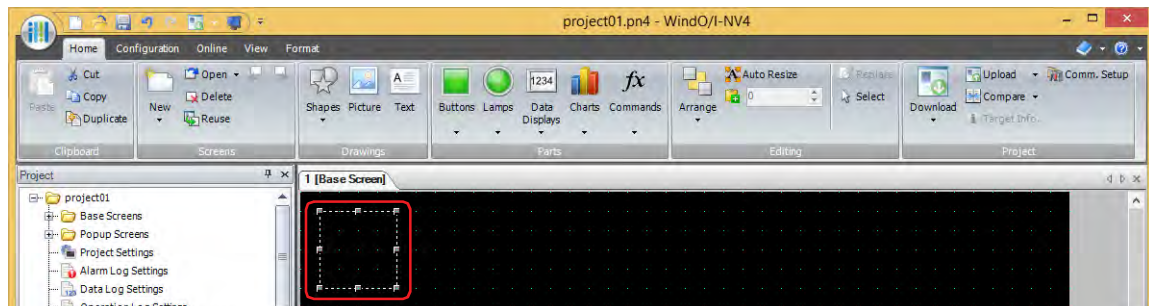

- 4 Click the **View** tab.

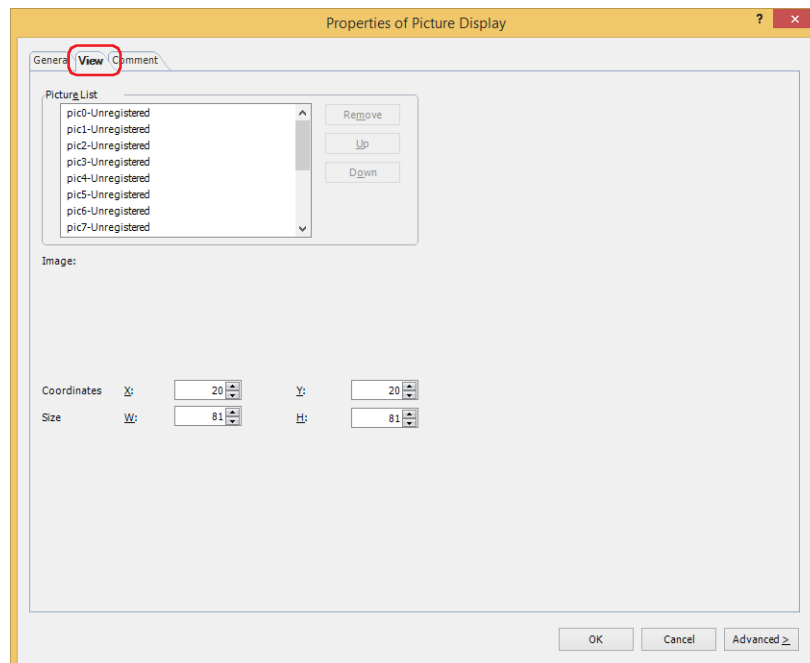

5 Registers the pictures to display on the Picture List.

Double click "pic0-Unregistered".

Picture Manager is displayed.

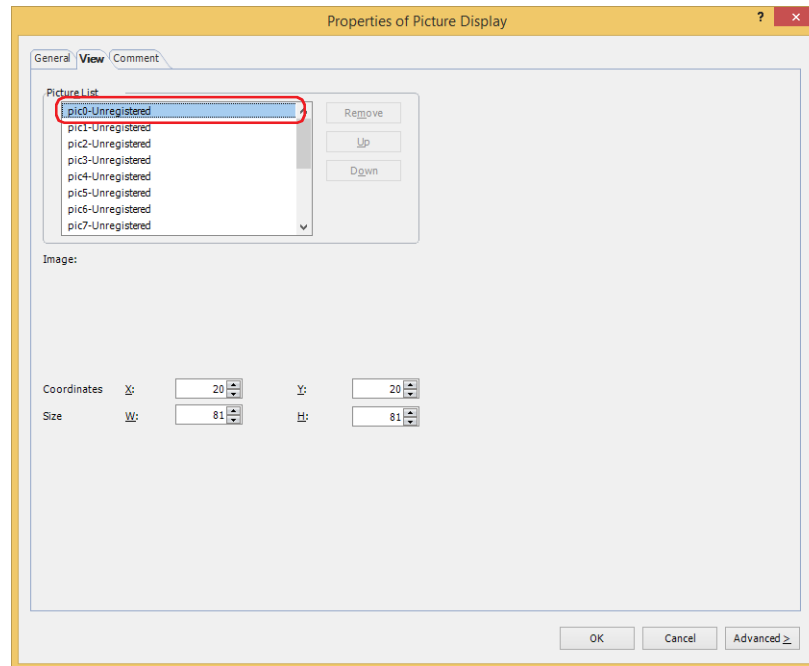

6 Click **Import**.

Open dialog box is displayed.

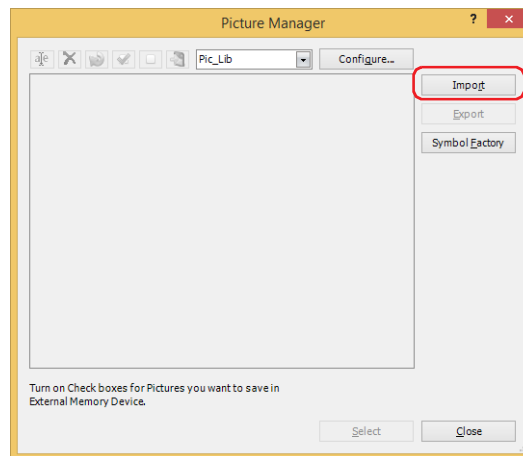

7 Specify the image file, and then click **Open**.

The picture is saved in Picture Manager.

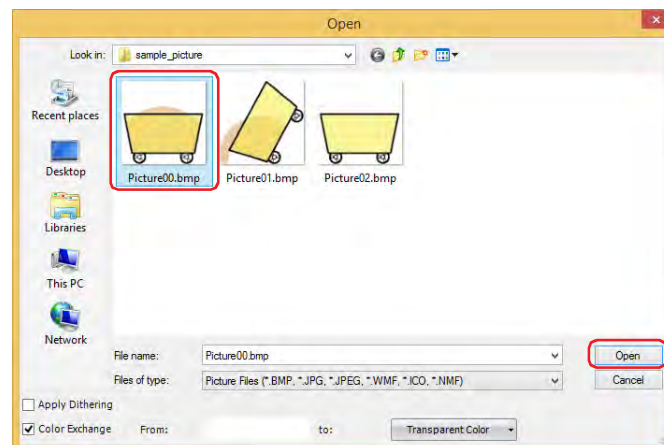

- Specify the image file, and then click **Select**.

The picture is saved in Settings.

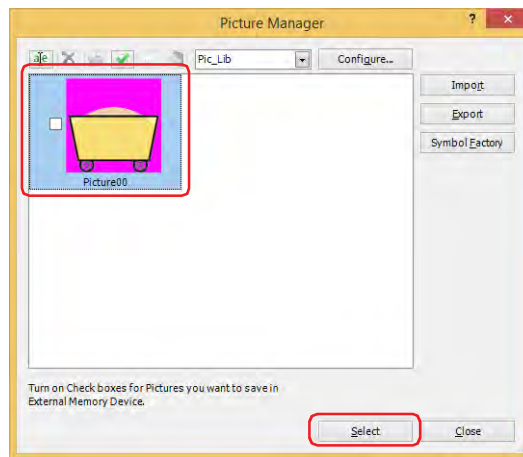

- Repeat steps 5 through 8 and register all pictures for switching.

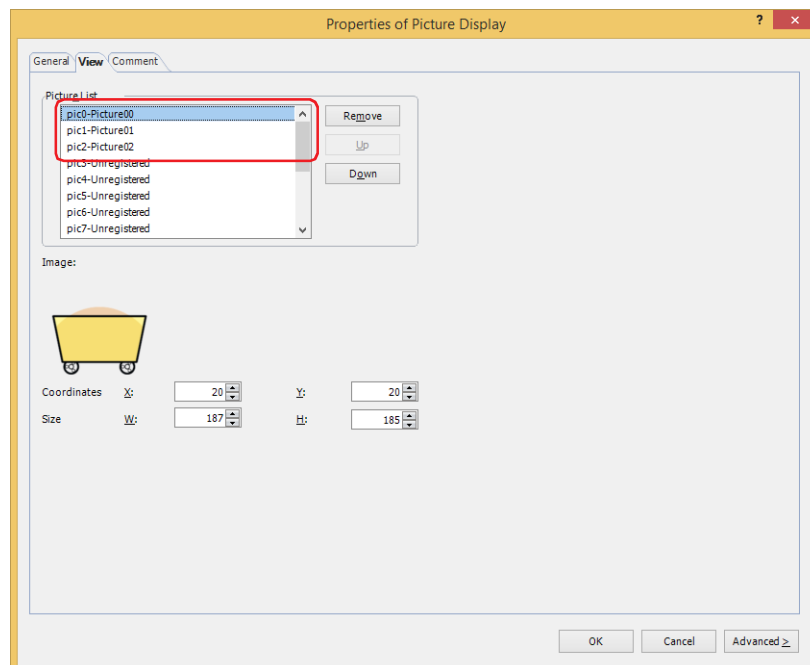

10 Click the **General** tab.

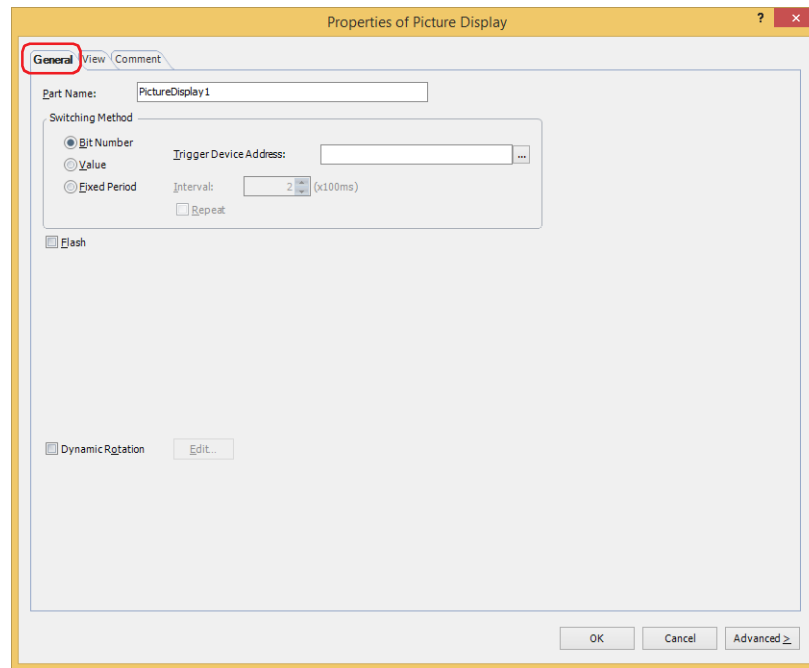

11 Select the **Dynamic Rotation** check box, and then click **Edit**.

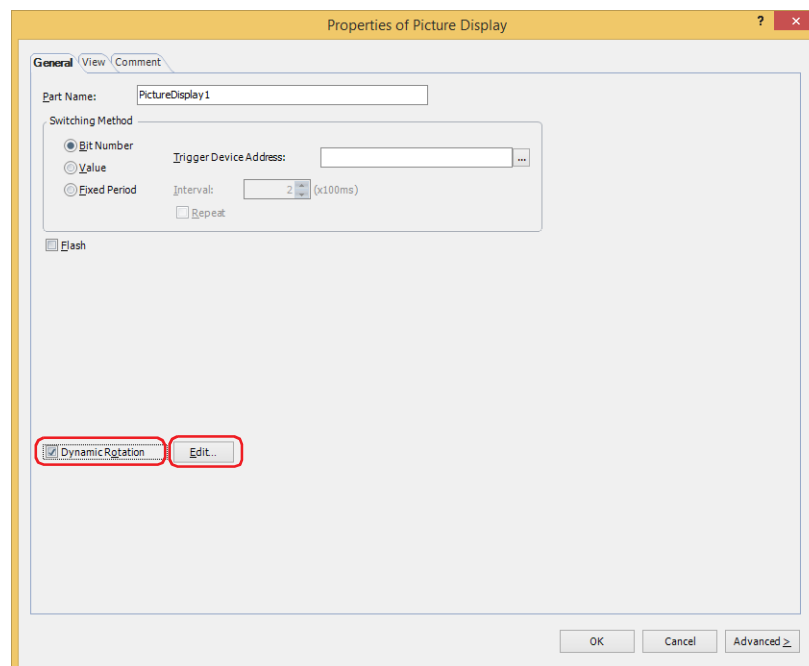

- 12 In **Source Device Address**, specify the word device to be read that holds the value to rotate and display the picture.

Click  to display the Tag Editor. For the device address configuration procedure, refer to Chapter 2 "5.1 Device Address Settings" on page 2-70.

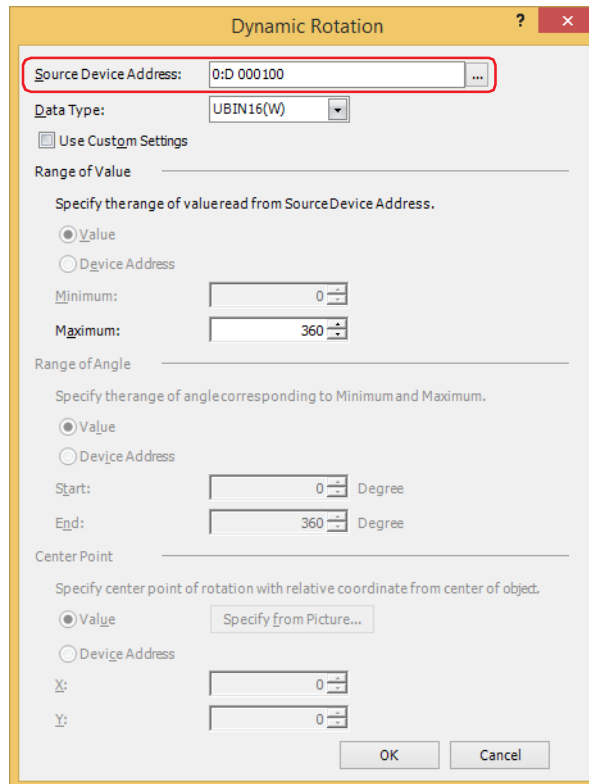

- 13 With **Data Type**, select the data type of the value.

Select the type of data that will be used to rotate and display the picture.

For details, refer to Chapter 2 "1.1 Available Data" on page 2-1.

- 14 Specify the maximum of the value to read from the Source Device Address in the **Maximum** under the **Range of Value**.

Rotate the picture with the minimum value is 0 and the Range of Angle to rotate is 0 to 360 degrees.

- 15 Click **OK**.

The Dynamic Rotation dialog box closes.

- 16 Change the settings on each tab as necessary and click the **OK** button.

The Properties of Picture Display dialog box closes.

This concludes configuring the settings to rotate and display the Picture Display.

4 Video Display

This function is only supported by models that are equipped with a video interface.

HG2J-7U HG5G-V HG4G-V HG4G HG3G-V HG3G HG2G-V HG2G-5F HG2G-5T HG1G HG1P

4.1 How the Video Display is Used

- Play movie files

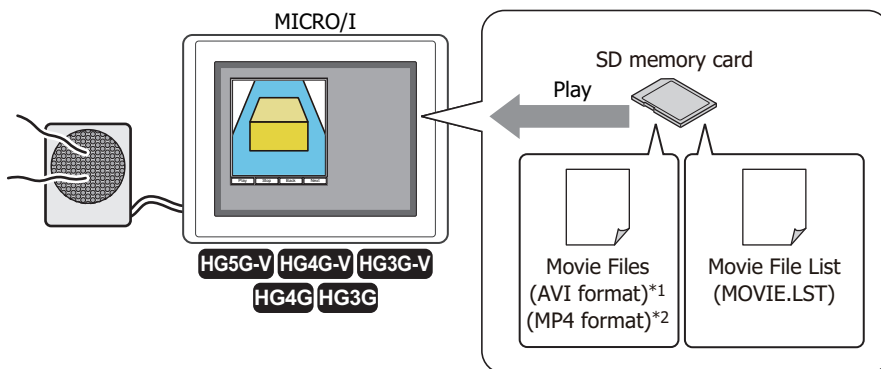

- Display video camera images on the MICRO/I and output microphone audio^{*3} from a connected speaker

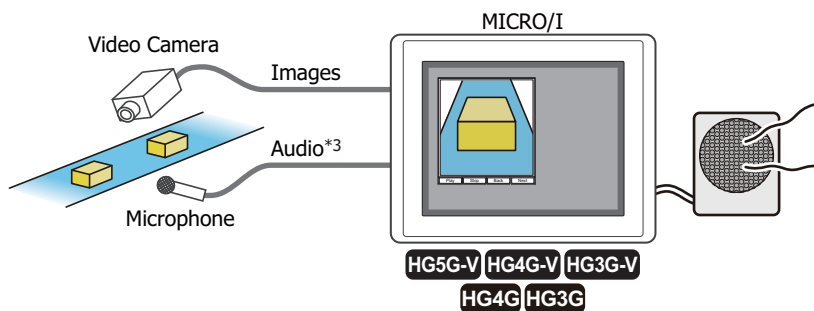

- Display images of two video cameras on the MICRO/I^{*1}

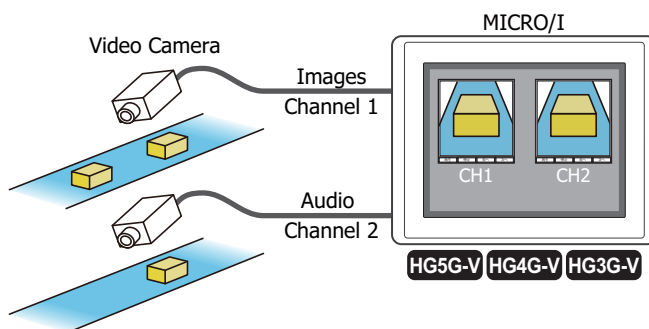

*1 HG5G/4G/3G-V only

*2 This is applicable for HG4G/3G with a video interface only.

*3 Recording sound function is for HG4G/3G only



- Using multiple Video Displays is as follows.

- HG5G/4G/3G-V

The maximum number of the Video Display that can be arranged on a single screen is two, you cannot arrange three or more Video Displays on a single screen including overlay.

Two Video Displays can display image from video input at the same time, but can not display movie file at the same time. However, even while playing a movie file on the Video Display, the video from the video input can be displayed on another Video Display.

- HG4G/3G

The maximum number of the Video Display that can be arranged on a single screen is 1. When two or more Video Displays are displayed on the screen including overlay, only the Video Display that was displayed first will operate.

Example: If the Popup Screen with a Video Display is opened from the Base Screen which also contains a Video Display, only the Video Display on the Base Screen will operate.

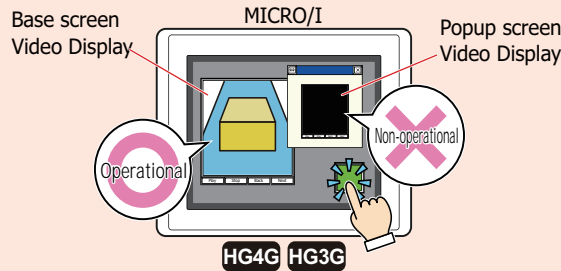

- If a portion of the Video Display is outside the display area of the screen, the Video Display will not display anything. If a Video Display on a popup screen is moved outside the display area of the screen, the movie playback and displayed video will stop.
- Depending on the size of the Video Display, the displayed image may be shrunk.
- When the frame size of the movie file to be played is less than or equal to half the size of the Video Display, the movie file cannot be played.
- Images from the video input will not be displayed when the size of Video Display is smaller than the following sizes:

Input Signal	HG5G/4G/3G-V	HG4G/3G
NTSC	368 x 240 dots	90 x 60 dots
PAL	368 x 288 dots	90 x 72 dots

- While data is being recorded after an event occurs with the event recording function, while data is being recorded with a Key Button, Multi-Button, or Multi-Command configured with the recording function, or while data is being saved to the external memory device, movie files cannot be played. While data is recording after an event occurs and while data is being saved to the external memory device, the value of HMI Special Data Register LSD155-0 changes to 1. For details, refer to Chapter 33 "HMI Special Data Register (LSD)" on page 33-8.



- Video Display can be operated using the Key Buttons, Multi-Buttons, and Multi-Commands.
- The Volume adjustment and mute are configured in the **Sound Settings** dialog box. For details, refer to Chapter 21 "Change Volume Level" on page 21-8 and Chapter 21 "Enable Mute" on page 21-8.

4.2 Video Display Configuration Procedure

This section describes the configuration procedure for the Video Display.

- 1 On the **Home** tab, in the **Parts** group, click **Data Displays**, and then click **Video Display**.

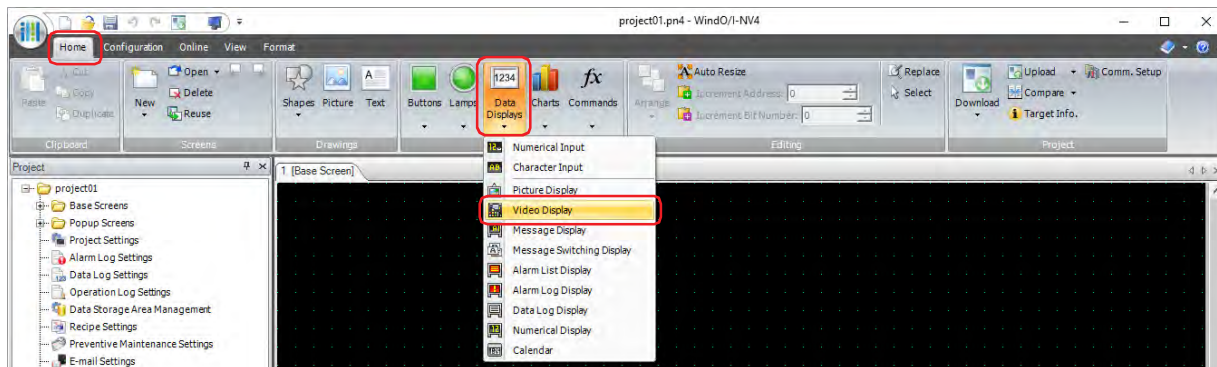

- 2 Click a point on the edit screen where you wish to place the Video Display.
- 3 Double-click the placed Video Display and a Properties dialog box will be displayed.
- 4 Change the settings on each tab as necessary.

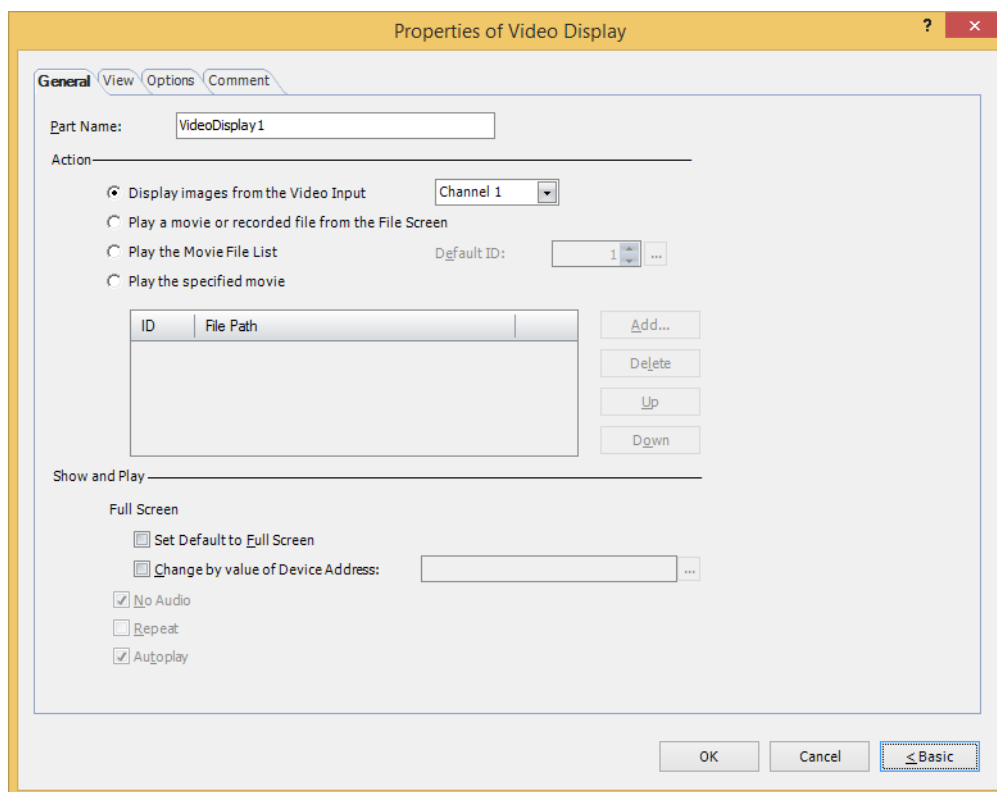

The **Options** tab only appears in Advanced Mode.



You can set the default for the Video Display on the **Default Preferences** tab of the **WindO/I-NV4 Options** dialog box. For details, refer to Chapter 2 "Default Preferences Tab" on page 2-63.

4.3 Properties of Video Display Dialog Box

This section describes items and buttons on the properties dialog box.

● General Tab

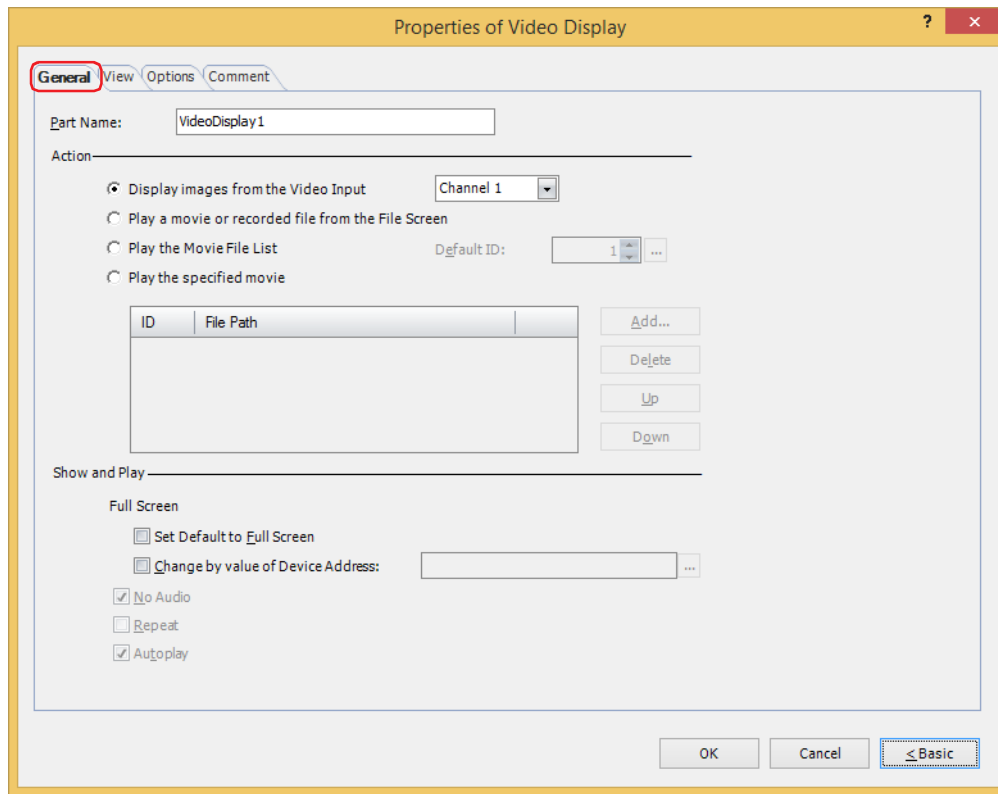

■ Part Name

Enter a name for the part. Maximum number is 20 characters.

■ Action

Select the content to execute on the Video Display from the following.

Display images from the Video Input: Displays images from the video interface and outputs sound^{*1} from the audio interface.
(Channel)^{*2}: Selects **Channel 1** or **Channel 2** to display one of the images from the video interface.

Play a movie or recorded file from the File Screen:

Selects and plays files using the File Screen. For details, refer to "4.4 File Screen" on page 10-92.

Play the Movie File List:

Plays movie files in order of ID number on the movie file list.

It is a list of movie files that have been registered in the Multimedia Function settings. You cannot change the order when you play files. For details, refer to Chapter 22 "Multimedia Function" on page 22-1.

Default ID: Pressing the play button specifies the ID number (1 to 64) of the movie file to be played.

Clicking  displays the **Multimedia Settings** dialog box. Select an ID number from the movie file list.

*1 Recording sound function is for HG4G/3G only

*2 HG5G/4G/3G-V only

Play the specified movie:	Plays movie files by the order of the ID number. Selects files to be played from the movie file list and then creates a list of files to be played. This can be set only when Play the specified movie is selected.
ID:	Displays the movie file list ID.
File Path:	Displays the file path of the movie file.
Add:	Adds a movie file (1 to 8) to the list. Clicking this button opens the movie file list. Specify files using the movie file list.
Delete:	Deletes files from the list. Select a file from the list and then click this button. Movie files deleted from the playlist will not be deleted from the movie file list.
Up:	Shifts a selected file upward on this list.
Down:	Shifts a selected file downward on this list.

■ Show and Play

Set Video Display's display setting and playback setting.

Full Screen: The entire screen of MICRO/I is used as the display area of images and movie files.

Set Default to Full Screen: Select the check box to start with a display or playback on full screen when the Video Display is displayed.

Change by the value of Device Address: Select the check box and specify the bit number of a bit device or word device if you want to switch between display in full screen or not using the value of a device address.
Full screen is displayed when the value of a device address is changed from 0 to 1. Full screen ends when the value is changed from 1 to 0.



Full screen can be ended with a Key Button (**Restore**). When the full screen ends with the Key Button, the value of a device address set by the **Change by the value of Device Address** check box remains 1.

No Audio: Select this to play movie files without sound.

Repeat: Select this to repeat playback of a movie file.

This can only be set when **Play a movie or recorded file from the File Screen, Play the Movie File List**, or **Play the specified movie** is selected in **Action**.

Autoplay: Select this to automatically play movies when a Video Display is shown on the screen. When **Display images from the Video Input** is selected for **Action**, movie files are always automatically played. However, while data is being recorded after an event occurs with the event recording function, while data is being recorded with a Key Button, Multi-Button, or Multi-Command configured with the recording function, or while data is being saved to the external memory device, movie files are not automatically played when the Video Display is shown on the screen.

● **View Tab**

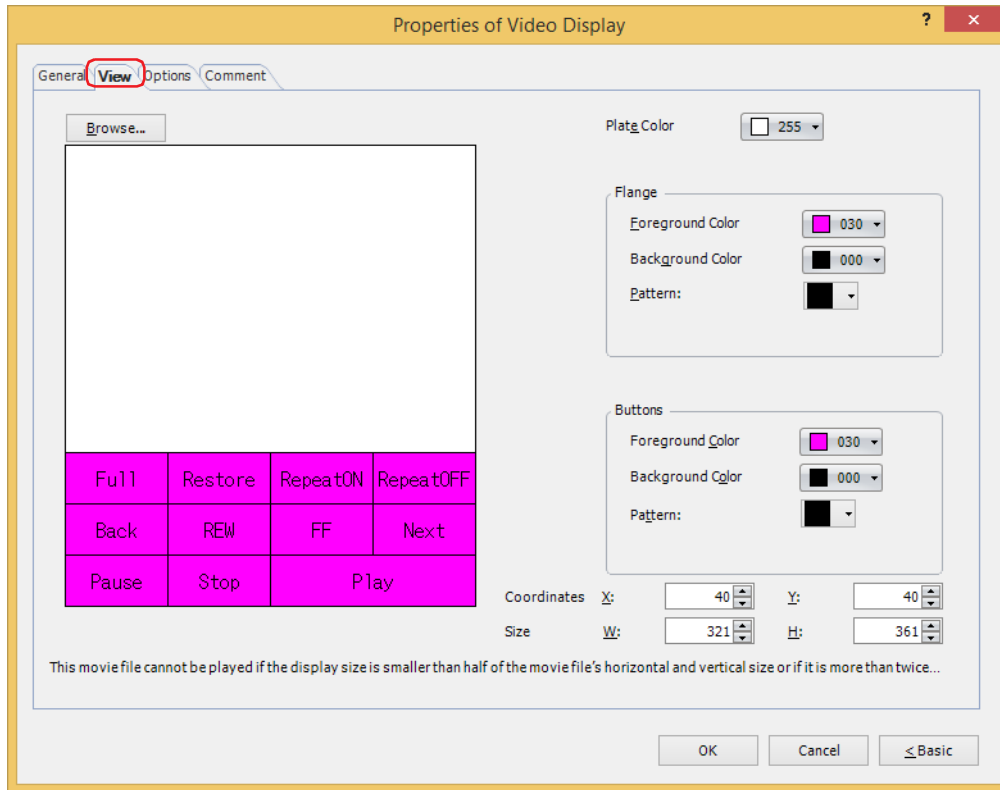

■ **Browse**

Select the type of graphic to be used to represent the part from the list of graphics. Click this button to display the View Browser.

■ **Plate Color**

Selects the plate (color: 256 colors, monochrome: 16 shades).

Click **Color** to display the Color Palette. Select a color from the Color Palette.

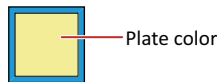

■ **Flange**

Foreground Color, Background Color: Selects the foreground and background colors of the flange (color: 256 colors, monochrome: 16 shades).

Click **Color** to display the Color Palette. Select a color from the Color Palette.

Pattern: Selects a pattern for the flange.

Click **Pattern** to display the Pattern Palette. Select a pattern from the Pattern Palette.

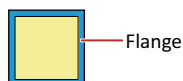

■ **Buttons**

Foreground Color, Background Color: Selects the foreground and background colors of the buttons (color: 256 colors, monochrome: 16 shades).
 Click **Color** to display the Color Palette. Select a color from the Color Palette.

Pattern: Selects a pattern or tonal gradation for the button.
 Click **Pattern** to display the Pattern Palette. Select a pattern or tonal gradation from the Pattern Palette.

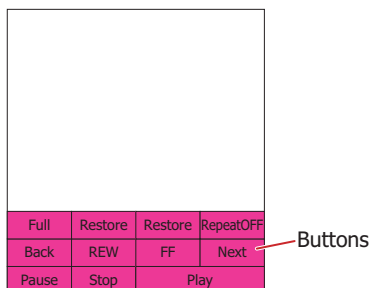

Can be set only when there are grouped Key Buttons.

■ **Coordinates**

X, Y: Sets the display position of parts using coordinates.
 The X and Y coordinates of parts is defined relative to an origin at the top-left corner of the screen.

X: 0 to (base screen horizontal size - 1)
 Y: 0 to (base screen vertical size - 1)

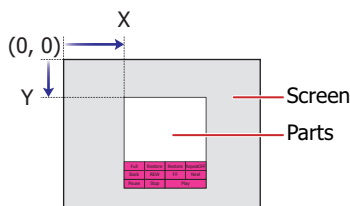

■ **Size**

W, H: Sets width and height to define the size of parts.

W: 20 to (base screen horizontal size)
 H: 20 to (base screen vertical size)

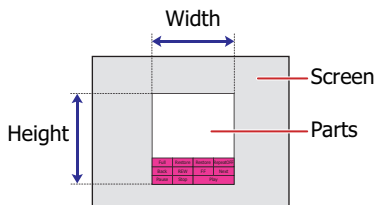

- **Options Tab**

The **Options** tab is displayed in Advanced mode.

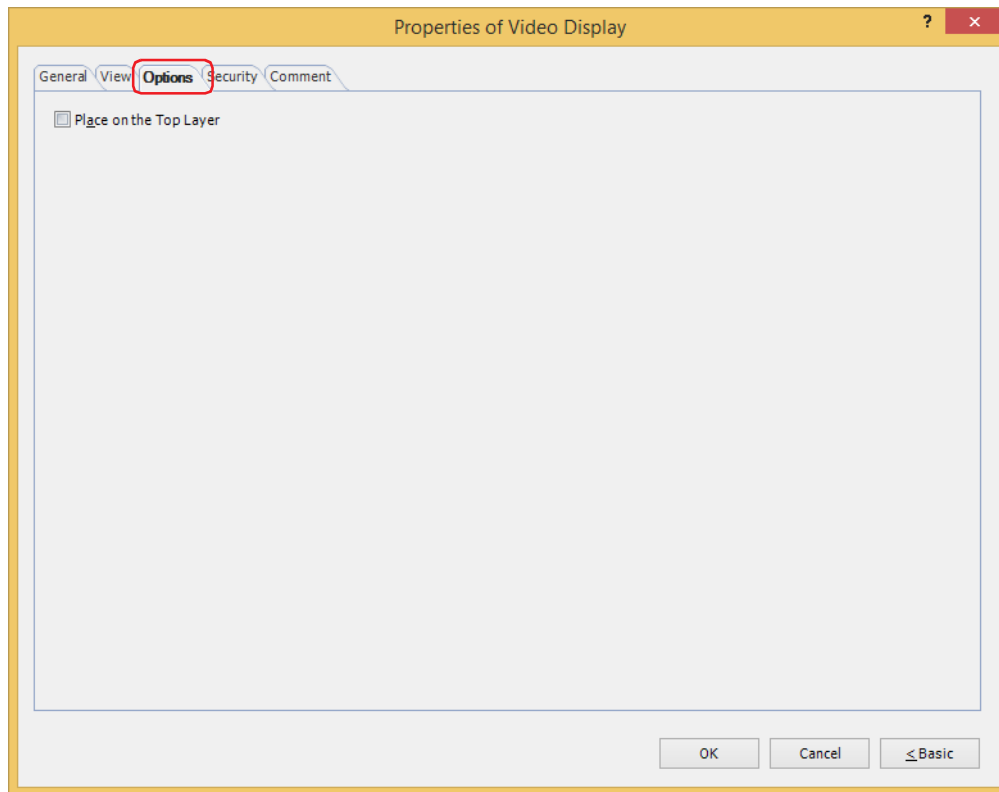

- **Place on the Top Layer**

Select this check box to display the parts on the top layer. The parts will have precedence when other drawings and parts are overlapping with it. For details, refer to Chapter 6 "4 Drawings and Parts Overlapping" on page 6-5.

● Security Tab

This tab is used to restrict displaying and using the part by security groups.

This option can only be set when **Use Security functions** is selected. The **Use Security functions** check box is set on **General** tab in the **Security** dialog box.

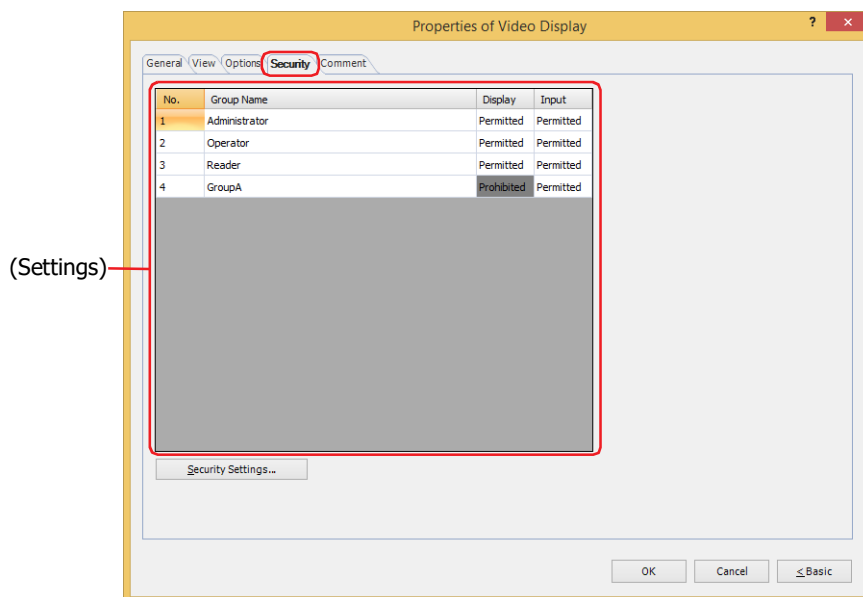

■ (Settings)

Displays the list of security groups used on the MICRO/I.

- No.:
- Displays the security group numbers (1 to 15).
- Group Name:
- Displays the name of the security group.
- Display:
- Displays whether or not there is permission to display the part. Only **Permitted** security groups can display this part. If all security groups are set to **Permitted**, this part will be displayed even if no user account has been selected. Double clicking the cell switches between **Permitted** and **Prohibited**.
- Input:
- Displays whether or not there is permission to use the part. Only **Permitted** security groups can use this part. If all security groups are set to **Permitted**, this part can be used even if no user account has been selected. Double clicking the cell switches between **Permitted** and **Prohibited**.



- You can also switch between **Permitted** and **Prohibited** by right-clicking on a **Display** or **Input** cell.
- Restricting the display and use of the part by switching between **Permitted** and **Prohibited** in **Display** and **Input** cells is similar to using the **Trigger Condition** tab.



■ Security Settings

The Security Settings dialog box is displayed. If you create a security group in the **Security Settings** dialog box, you can select that created group. For details, refer to Chapter 23 "2.2 Adding and Editing Security Groups" on page 23-19.



For details about security functions, refer to Chapter 23 "User Accounts and the Security Function" on page 23-1.

Example: If the user and security group for a part are set as follows:

User Name	 User1	 User2	 User3
Security Group	Reader	Operator	Administrator

Line Chart and Bar Chart

No.	Group Name	Display
1	Administrator	Permitted
2	Operator	Permitted
3	Reader	Prohibited

MICRO/I

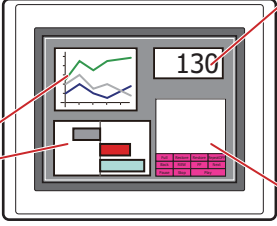

Numerical Display

No.	Group Name	Display
1	Administrator	Permitted
2	Operator	Permitted
3	Reader	Permitted

Video Display

No.	Group Name	Display	Input
1	Administrator	Permitted	Permitted
2	Operator	Permitted	Prohibited
3	Reader	Prohibited	Prohibited

For User1 in the **Reader** security group, the parts for which **Display** has been set to **Prohibited** for **Reader** will not be displayed.

If the password screen is opened and the user switches to User2 in the **Operator** security group, the parts for which **Display** has been set to **Permitted** for **Operator** will be displayed.

MICRO/I

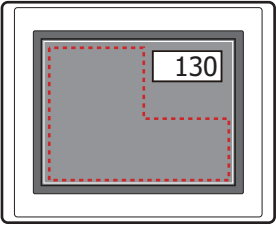

 For User1, parts for which Display has been set to Prohibited for Reader are not displayed

MICRO/I

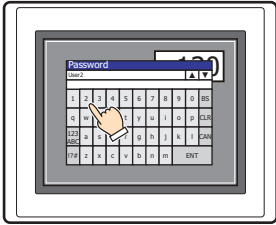

Open Password Screen, enter password, and switch to User2

MICRO/I

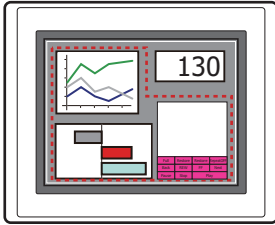



 For User2, parts for which Display has been set to Permitted for Operator are displayed

For User2 in **Operator**, **Display** has been set to **Permitted** for **Operator**, but **Input** is **Prohibited**, so the Video Display cannot be used.

If the password screen is opened and the user switches to User3 in the **Administrator** security group, the parts for which **Display** has been set to **Permitted** for **Administrator** will be displayed, and the parts for which **Input** has been set to **Permitted** for **Administrator** can be used.

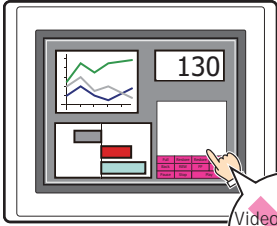
MICRO/I



 For User2, parts for which Display has been set to Permitted for Operator are displayed, but parts for which Input has been set to Prohibited cannot be used

MICRO/I

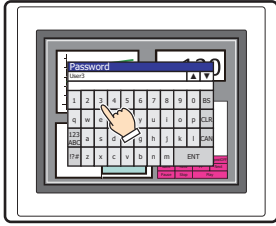

Open Password Screen, enter password, and switch to User3

MICRO/I

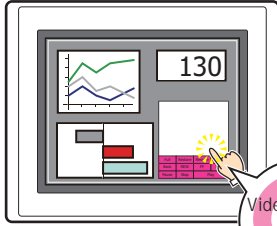

 For User3, parts for which Display has been set to Permitted for Administrator are displayed, and parts for which Input has been set to Permitted can be used

● Comment Tab

The **Comment** tab is used to specify the parts placed on the editing screen, and the popup text displayed when the mouse pointer is placed close to **No.**, **Name**, or **Type** in the object list.



When there are multiple parts of the same shape on the screen, this feature makes it possible to distinguish between the parts without displaying the Properties dialog box for each part, by just mousing over the part.

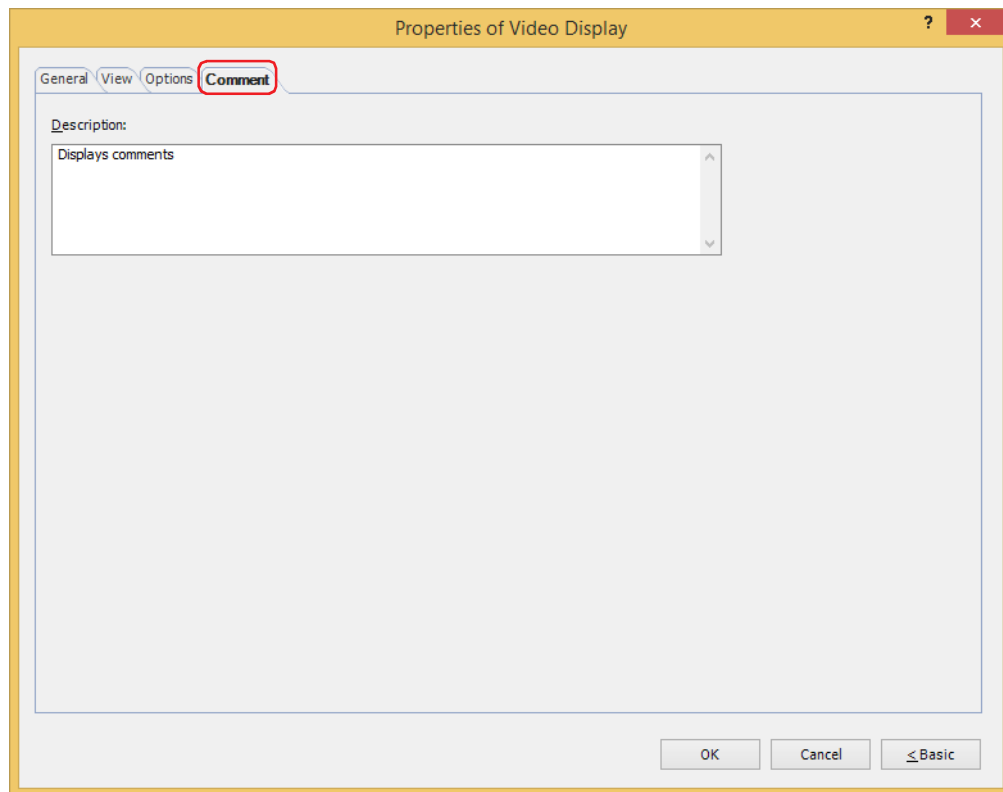

■ Description

Used for entering comments about parts. Maximum number is 80 characters.

Example: When mousing over the Video Display on the editing screen

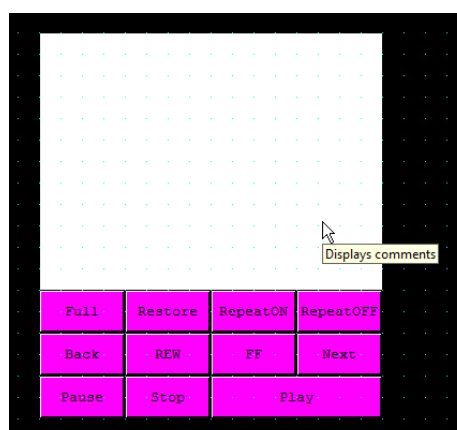

4.4 File Screen



With the File Screen, movie files can be selected from an SD memory card and then played on a Video Display.

When **Play a movie or recorded file from the File Screen** has been selected in **Action** for the Video Display, movie files can be selected with the File Screen and then played. **Action** is set in the **General** tab of the Video Display properties dialog box.

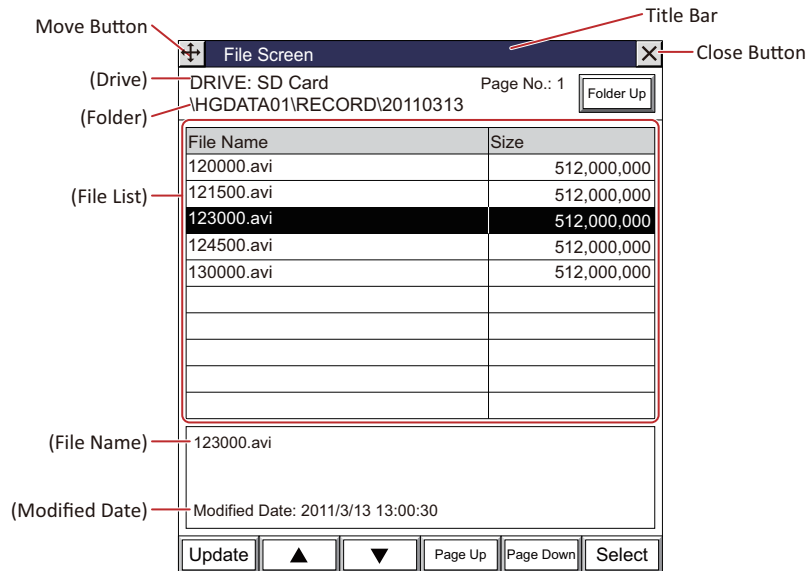
● File Screen Configuration



■ Title Bar

Displays the Title,  (Move) button, and  (Close) button.

 (Move) button: Moves the File Screen.

 (Close) button: Closes the File Screen.

■ (Drive)

Displays the selected drive. Displays as SD Card.

■ (Folder)

Displays the folder path of the currently selected folder.



- When the folder path exceeds 36 characters, up to 35 characters will be displayed.
- Once the File Screen is opened, the "RECORD" folder in the External Memory Device folder will be displayed. If the "RECORD" folder does not exist, the External Memory Device folder will be displayed.

■ Page No.

Displays the current page number.

■ Folder Up button

Moves to a folder that is 1 level higher in the hierarchy.

■ (File List)

File Name: Displays a list of the files and folders in the currently selected folder.

Size: For files, this displays the file size (bytes).
For folders, this is displayed as **Folder**.



File names should be alphanumeric characters only.



Movie files that meet the following specifications can be played with the MICRO/I:

HG5G/4G/3G-V: AVI file (.avi)

HG4G/3G: MP4 file (.mp4)

For details, refer to Chapter 2 "1.6 Available Movie Files" on page 2-37.

■ (File Name)

Displays the file name of the selected file. The maximum number for the file name is 120 characters.

■ (Modified Date)

Displays the updated date and time.

■ Update

Updates to the newest file list state.



Moves the focus up by one level.



Moves the focus down by one level.

■ Page Up

Moves up by one page.

■ Page Down

Moves down by one page.

■ Select

Selects the file or folder that is in focus.

If a folder has been selected, this will open the folder and display its contents.

● Select a Movie File

Display the File Screen on the Base Screen and select a movie file from a Memory Card.

- 1 Press the Goto Screen Button or Multi-Button that has been set to **Open File Screen** or execute the Goto Screen Command or Multi-Command.
The File Screen will be displayed.

- 2 Select the movie file to be played.

Example: When selecting the movie file "123000.avi" in the "20110313" folder of the "RECORD" folder located in the External Memory Device folder "HGDATA01":

1. Press ▼ to select "HGDATA01" and then press **Select**.
The contents of the "HGDATA01" folder will be displayed.

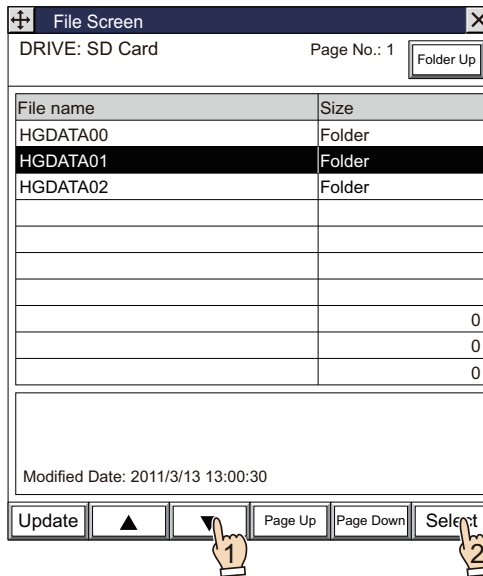

2. Press ▼ to select "RECORD" and then press **Select**.
The contents of the "RECORD" folder will be displayed.

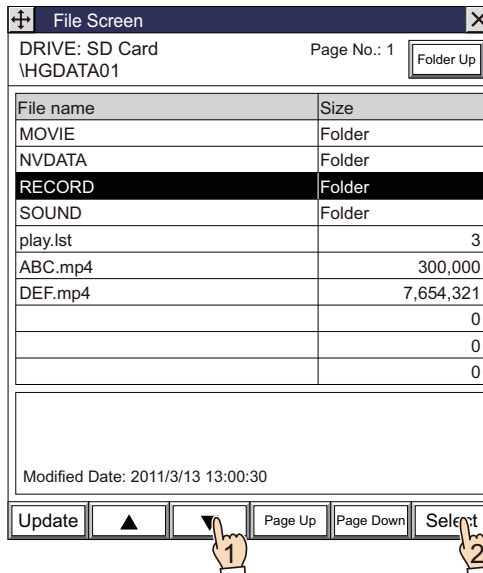

3. Press ▼ to select "20110313" and then press **Select**.
The contents of the "20110313" folder will be displayed.

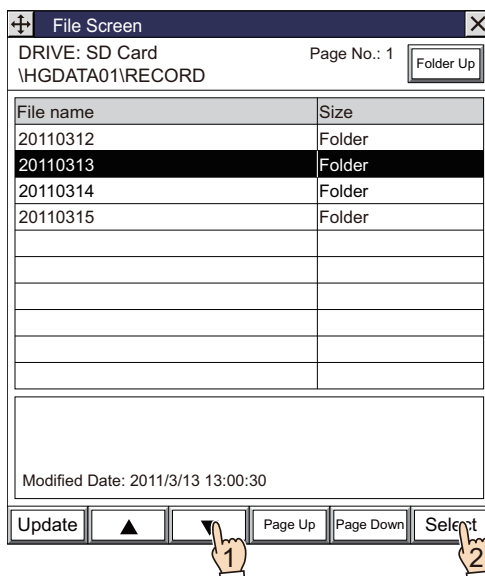

4. Press ▼ to select "123000.avi" and then press **Select**.
The movie file will be selected and the File Screen will close.
When you press a key button or a Multi-Button configured with the play key, or when you execute a Multi-Command, the movie file plays.

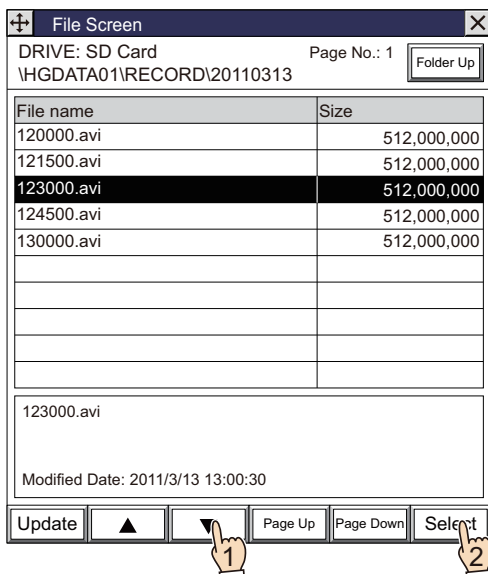

5 Message Display

HG2J-7U HG5G-V HG4G-V HG4G HG3G-V HG3G HG2G-V HG2G-5F HG2G-5T HG1G HG1P

5.1 How the Message Display is Used

The Message Display is used to constantly display messages registered in advance and to display text read from values of word devices as character codes.

The Message Display can perform the following functions.

- Display messages

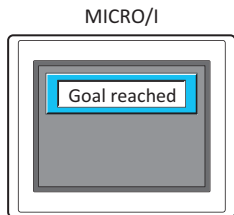

- Display text according to values of device addresses

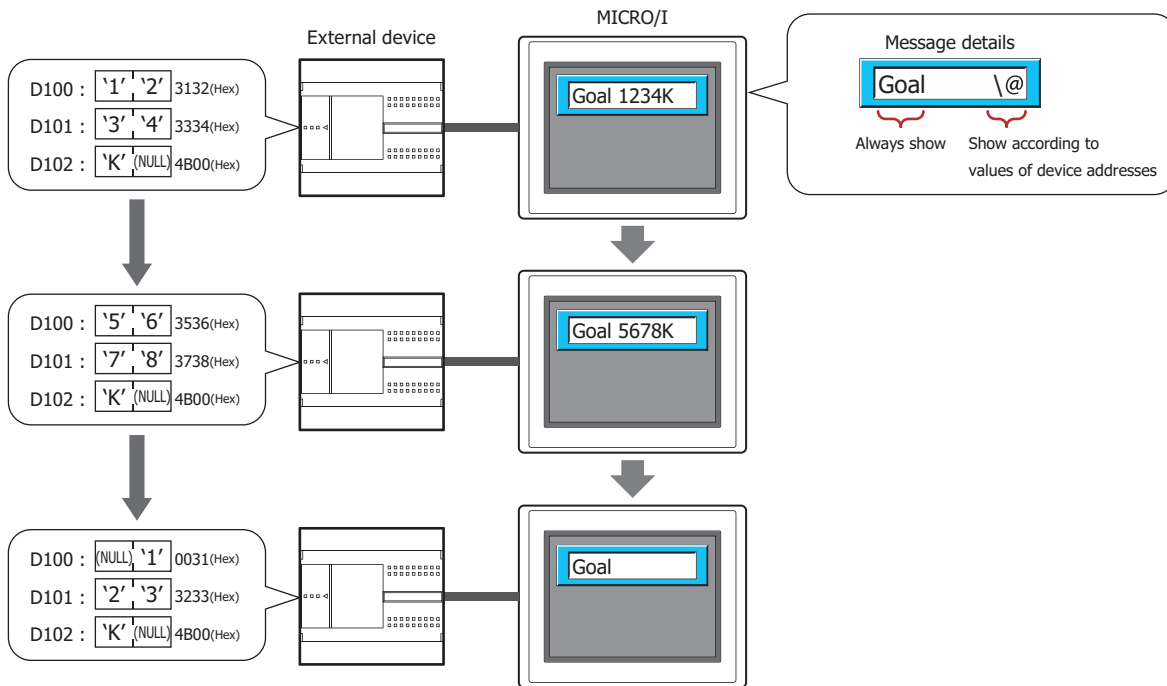

	D100	'1' '2' 3132(Hex)	'5' '6' 3536(Hex)	(NULL) '1' 0031(Hex)
Value of Source Device Address	D101	'3' '4' 3334(Hex)	'7' '8' 3738(Hex)	'2' '3' 3233(Hex)
	D102	'K' (NULL) 4B00(Hex)	'K' (NULL) 4B00(Hex)	'K' (NULL) 4B00(Hex)
Display		Goal 1234K	Goal 5678K	Goal
Action		Display always shown text and text shown according to values of device addresses	Display always shown text and text shown according to values of device addresses	Display only always shown text Do not show if upper byte of the source device address starting address number is 00 (NULL)

- Scroll messages

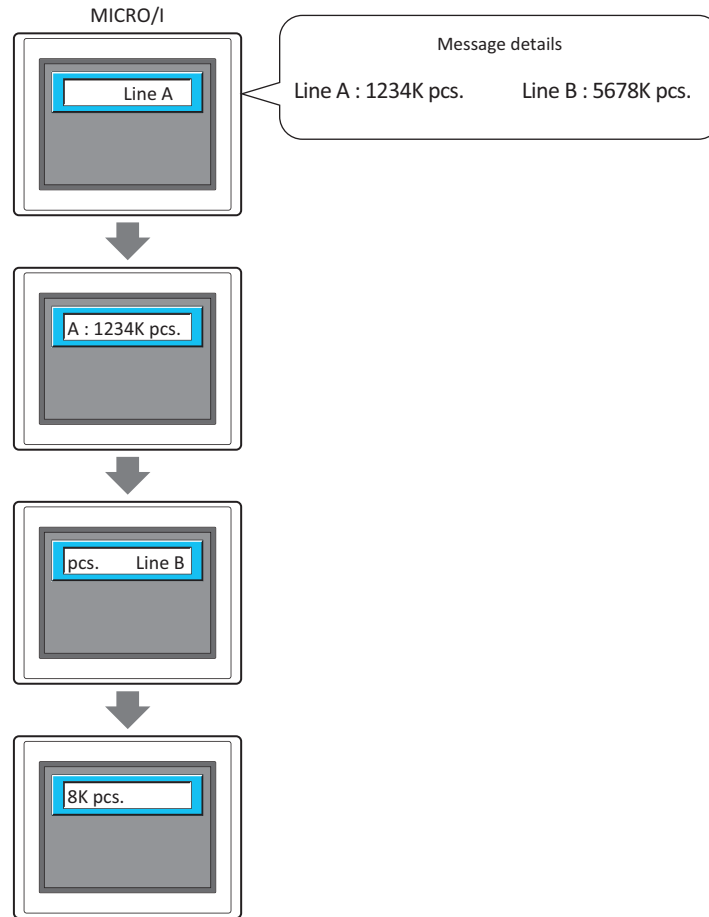

- Change the message and plate color according to a value of device address

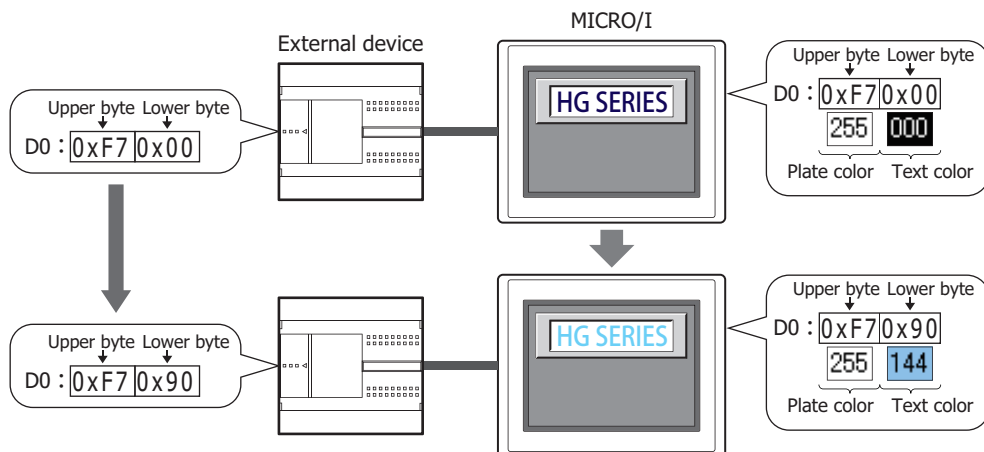

5.2 Message Display Configuration Procedure

This section describes the configuration procedure for Message Displays.

- 1 On the **Home** tab, in the **Parts** group, click **Data Displays**, and then click **Message Display**.

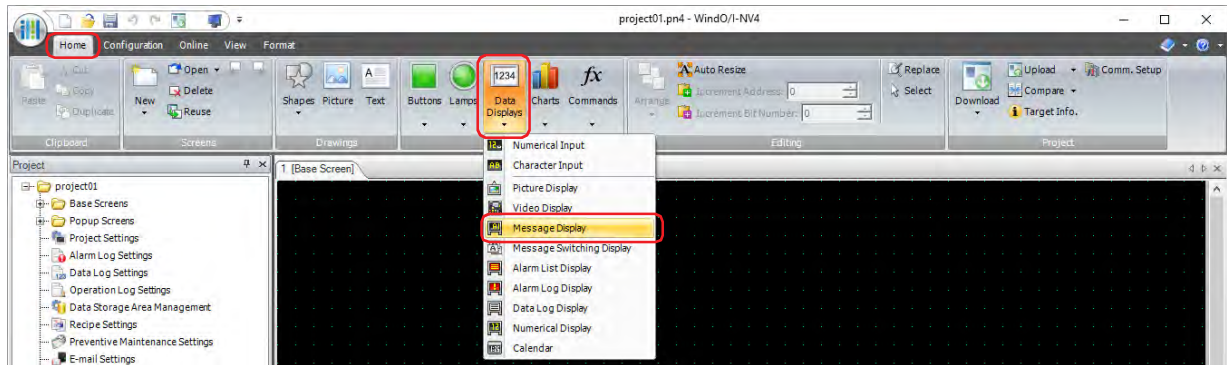

- 2 Click a point on the edit screen where you wish to place the Message Display.
- 3 Double-click the placed Message Display and a Properties dialog box will be displayed.
- 4 Change the settings on each tab as necessary.

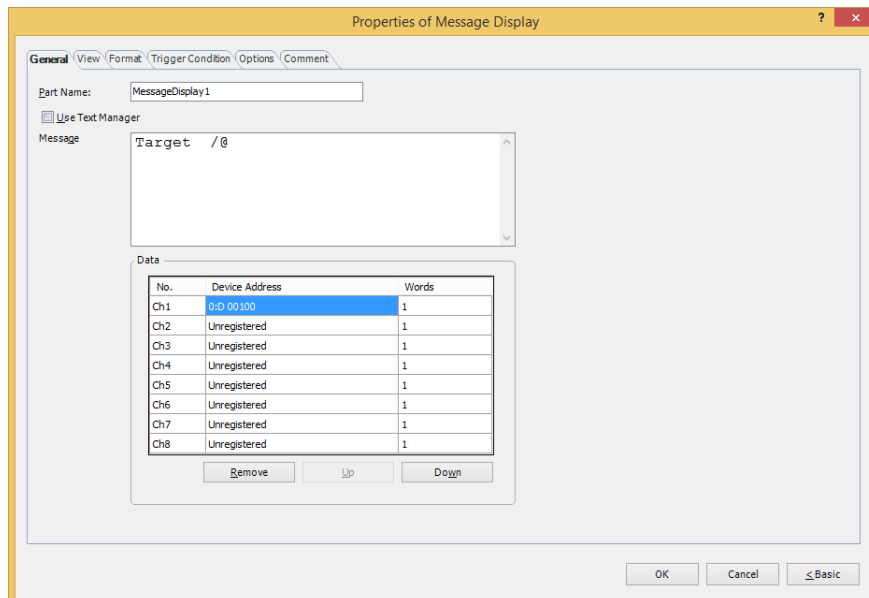

The **Trigger Condition** tab and **Options** tab only appear in Advanced mode.



You can set the default for the Message Display on the **Default Preferences** tab of the **WindO/I-NV4 Options** dialog box. For details, refer to Chapter 2 "Default Preferences Tab" on page 2-63.

5.3 Properties of Message Display Dialog Box

This section describes items and buttons on the properties dialog box.

● General Tab

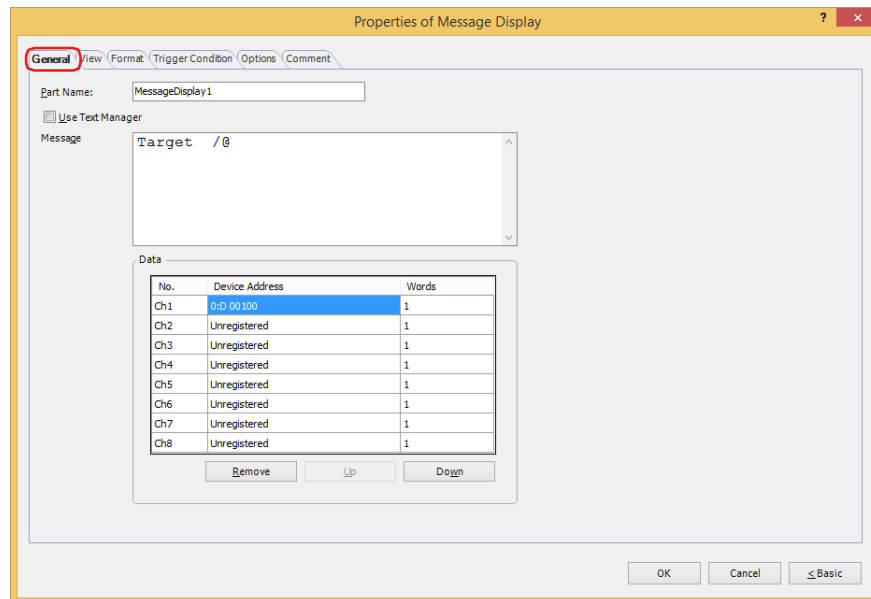

■ Part Name

Enter a name for the part. The maximum number is 20 characters.

■ Use Text Manager

Select this check box to use text registered in Text Manager.

■ Text ID

Specifies the Text Manager ID number (1 to 32000) when using text registered in Text Manager.

Click  to display Text Manager.

This option can only be configured when the **Use Text Manager** check box is selected.



To read values of word devices as character codes with text registered in Text Manager and display it as text, enter "\@" (1 to 8) in **Text** for the **Text ID** at the position to display the value of device address as text. The channels configured under **Data** are allocated in order from the first "\@". The text is displayed according to the values of device addresses in order from the first reference device address.

However, in the following situations "\@" is not handled as text to display according to values of device addresses and is displayed unchanged.

- When **Font** is **Windows** for **Text ID** configured in Text Manager
- When the number of "\@" configured in **Text** for **Text ID** is greater than the number of channels configured with device addresses
(Text for the character codes corresponding to the values of device addresses is only displayed for the number of channels in order from the beginning.)

■ Message

Enter the text to display. The maximum number is 610 characters. You can enter multi-line messages by inserting a newline. To configure text to display according to values of device addresses, enter "\@" (1 to 8) at the location to read the values of word devices as character codes and display them as text. The channels configured under **Data** are allocated in order from the first "\@". The text is displayed according to the values of device addresses in order from the first reference device address.

Example: The device configured in Ch1 is allocated to the first "\@". The device address configured in Ch2 is allocated to the second "\@".

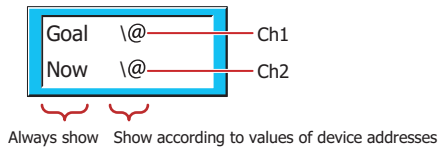

The characters that can be entered vary based on to the font selected for **Font** on the **Format** tab. For details, refer to Chapter 2 "1.2 Available Text" on page 2-6.

This option can only be configured if the **Use Text Manager** check box is cleared.



To display the backslash (\), enter a backslash (\) before the backslash (\).

Example:\\

■ Data

These options are used to register or edit the device addresses with values to read as character codes.

(Settings): Lists the settings for the text to display according to values of device addresses.

No.:	Shows the channel numbers (Ch1 to Ch8).
Device Address:	Specifies the word device that stores the values read as character codes. Double clicking the cell displays the Tag Editor. For the device address configuration procedure, refer to Chapter 2 "5.1 Device Address Settings" on page 2-70. Set the value of device address to the character codes for the language used. For details, refer to Chapter 2 "Character Code Table" on page 2-16.
Words:	Specifies the number of words for the length of the text to display (1 to 64). Double clicking the cell allows you to change the Words. Values of device addresses for the configured amount of words are read as character codes starting from the device address set by Device Address. 2 single-byte characters can be displayed by 1 word.

Remove: Deletes the registered settings from the list.

Up: Shifts the selected settings upward in the list.

Down: Shifts the selected settings downward in the list.



You can register the settings from arbitrary numbers, they are aligned filled from the beginning after clicking **OK** on the dialog box. Therefore, when the **Properties** dialog box is closed and reopened, the list is displayed filled from the beginning.

● View Tab

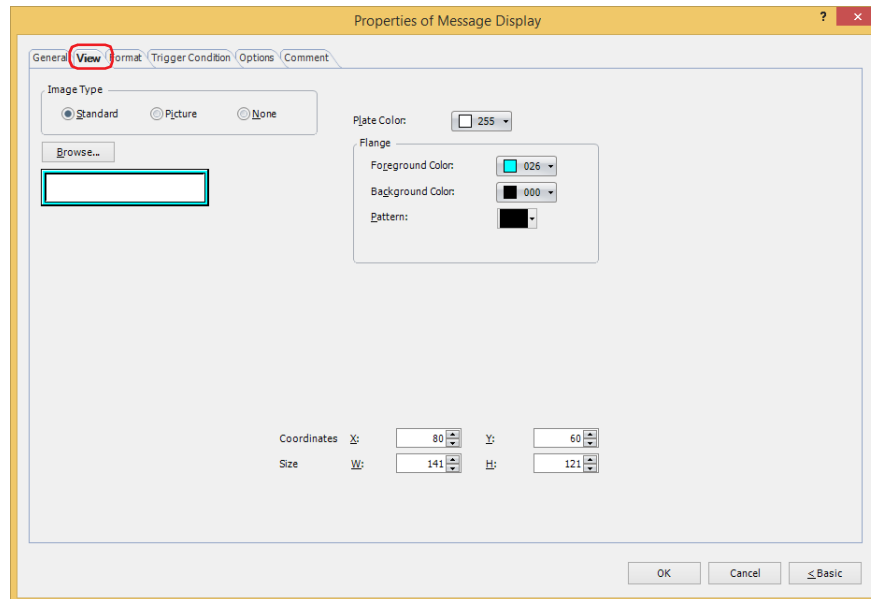

■ Image Type

Select the type of graphic to be used to represent the part.

Standard: Uses the default graphic for WindO/I-NV4.

Picture: Uses an image file saved using Picture Manager.

For details about image file restrictions, refer to Chapter 2 "1.4 Available Image Files" on page 2-20.

None: The plate and the flange of the part are not displayed. Only the text is displayed.

■ Browse

Select the type of graphic to be used to represent the part from the list of graphics. Click this button to display the View Browser or Picture Manager, depending on the setting for **Image Type**.

■ Plate Color

Selects the plate color of the standard graphic (color: 256 colors, monochrome: 16 shades).

Click **Color** to display the Color Palette. Select a color from the Color Palette.

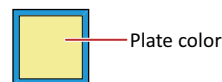

■ Flange

Foreground Color, Background Color: Selects the foreground and background colors of the flange of the standard graphic (color: 256 colors, monochrome: 16 shades).

Click **Color** to display the Color Palette. Select a color from the Color Palette.

Pattern:

Selects a pattern for the flange of the standard graphic.

Click **Pattern** to display the Pattern Palette. Select a pattern from the Pattern Palette.



■ Coordinates

X, Y: Sets the display position of parts using coordinates.

The X and Y coordinates of parts is defined relative to an origin at the top-left corner of the screen.

X: 0 to (base screen horizontal size - 1)

Y: 0 to (base screen vertical size - 1)

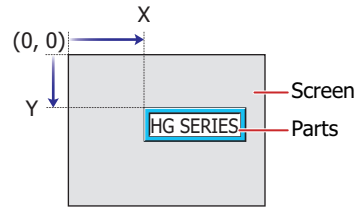

■ Size

W, H: Sets width and height to define the size of parts.

W: 5 to (base screen horizontal size)

H: 5 to (base screen vertical size)

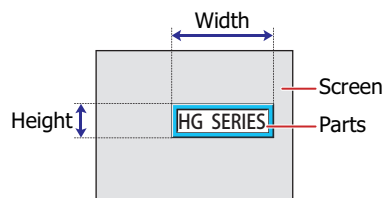

● Format Tab

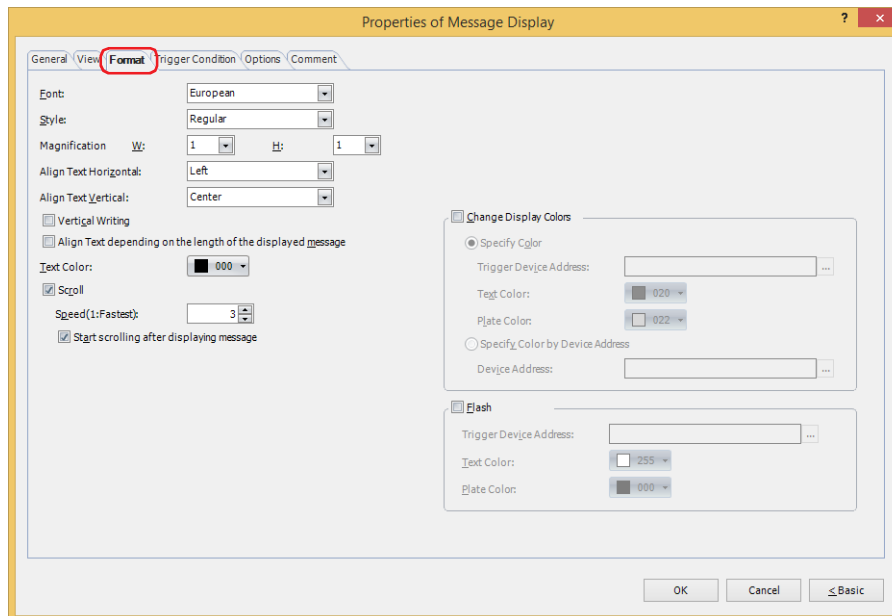

■ Font

Selects the font used for displaying text from the following.

Western, Japanese, Simplified Chinese, Traditional Chinese, Hangul, Central European, Baltic, Cyrillic, Stroke^{*1}

The characters that can be displayed depend on the font. For details, refer to Chapter 2 "1.2 Available Text" on page 2-6.

■ Size

Specifies the text size to be displayed. The fonts and sizes that can be set vary based on the model.

Model	Font	Size
HG2J-7U	Western, Japanese, Simplified Chinese, Traditional Chinese, Hangul, Central European, Baltic, Cyrillic	8 to 150
HG5G/4G/3G/2G-V, HG4G/3G, HG2G-5F/-5T, HG1G/1P	Stroke	8 to 128

■ Style^{*1}

Selects **Regular** or **Bold** for text style.

Can only be set when **Western, Japanese, Simplified Chinese, Traditional Chinese, Hangul, Central European, Baltic, Cyrillic** is selected for **Font**.

■ Magnification^{*1}

W, H: Selects text magnification (0.5, 1 to 8).

Can only be set when **Western, Japanese, Simplified Chinese, Traditional Chinese, Hangul, Central European, Baltic, Cyrillic** is selected for **Font**.

■ Align Text Horizontal

Selects the text alignment in the horizontal direction from the following.

Left, Center, Right, Center-Left, Left-Right

If **Top, Center** or **Bottom** is selected for **Align Text Vertical**, **Center** or **Right** can be set as this option.

If **Center-Top** is selected for **Align Text Vertical**, **Center-Left** or **Left-Right** can be set as this option.

For details, refer to Appendix "5 Text Alignment" on page A-7.

■ Align Text Vertical

Selects the text alignment in the vertical direction from the following.

Top, Center, Bottom, Center-Top

Set to **Center** when the **Vertical Writing** check box is selected.

For details, refer to Appendix "5 Text Alignment" on page A-7.

*1 HG5G/4G/3G/2G-V, HG4G/3G, HG2G-5F/-5T, HG1G/1P only

■ Vertical Writing

Select this check box when displaying text vertically.

Can only be set when **Font** is set to **Western, Japanese, Simplified Chinese, Traditional Chinese, Hangul, Central European, Baltic, Cyrillic**.



When the **Vertical Writing** check box is selected, take care about the following points. This is applicable for Windows supports East Asian characters.

- When there is a mixture of double-byte and single-byte characters, the half-width characters are left-aligned.

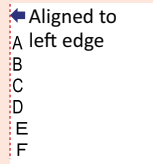

- Dashes are displayed horizontally. Symbols representing voiced and semi-voiced sounds of single-byte characters are shown as follows.

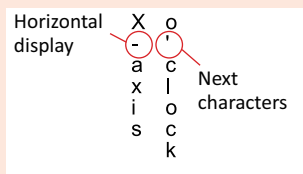

- When using text displayed according to values of device addresses, the characters are counted as single-byte characters and the display area for the characters is indicated by dotted lines. Therefore, when the text to display according to values of device addresses is double-byte characters, the display area actually required differs from the area indicated by the dotted lines.

Example: When 1 word of text to display according to values of device addresses is set to vertical writing, the vertical size of the dotted lines is displayed as 2 single-byte characters.

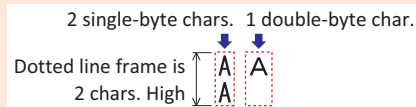

■ Align Text depending on the length of the displayed message *2

Select this check box to align text as standard to the number of characters that will be displayed.

This option is only displayed when the **Align the text area (Character Input/Message Display/Numerical Input/Numerical Display)** check box is selected in the **Project Settings** dialog box, on the **Compatible** tab.

When cleared, the maximum number of characters (set number of words) is always aligned as standard.

Example: When there are 2 characters of text to always display on the first line, 6 characters of text to always display on the second line and 6 characters of text (3 words) to display according to values of device addresses, **Align Text Horizontal** is set to **Center**, and the text to display according to values of device addresses is blank (when only 6 characters are always displayed on the second line)

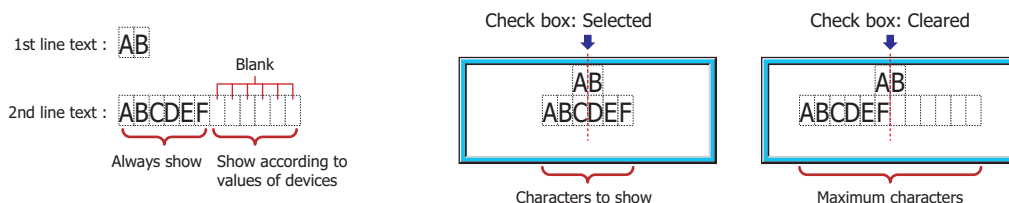

■ Text Color

Selects the color of displayed text (color: 256 colors, monochrome: 16 shades).

Click **Color** to display the Color Palette. Select a color from the Color Palette.

*2 Advanced mode only

■ Scroll*2

Select this check box to enable scrolling display displaying of messages.

This option can only be configured when the **Flash** check box is cleared and **Standard** is selected for **Image Type** on the **View** tab.

Speed (1: Fastest):

Sets the scrolling speed (1 to 10). 1 is fastest, 10 is slowest.

Start scrolling after displaying message: Select this check box to start scrolling after a message is displayed for 2 seconds.

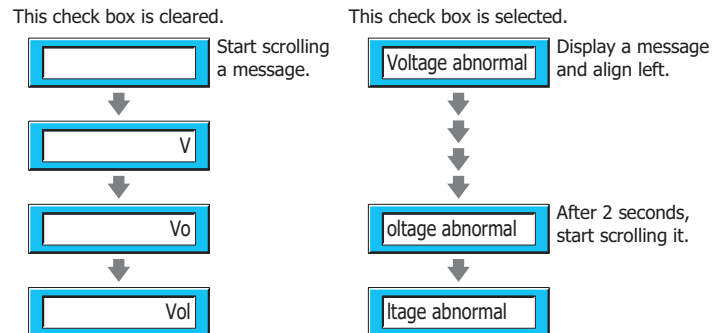

- When the **Scroll** check box is selected, the number of parts that can be arranged on a single screen decreases. If the MICRO/I displays an error message, clear the **Scroll** check box, or reduce the number of parts on the screen.
- When the scan time for the screen becomes longer, and when the part that has its **Scroll** check box selected is placed on the top layer, the scrolling speed may become slow.



When the **Scroll** check box is selected operation is follows.

- Messages that include CRs are displayed without the CRs.
- Messages scroll in the direction in which the text is drawn.
- When the text displayed according to values of device addresses, the text color, or the displayed text changes, the message is scrolled top the beginning.

*2 Advanced mode only

■ Change Display Colors*2

To switch the text and plate colors, select this check box and select the method to the display colors from the following.

Specify Color: Switches the text and plate to the specified colors.

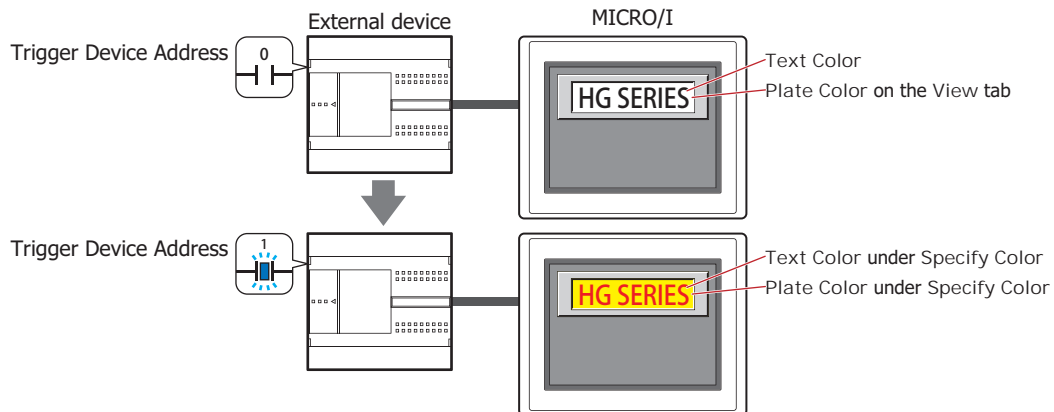

Trigger Device Address: Specifies the bit device or the bit number of the word device to use as the trigger to switch the text and plate colors.

Click to display the Tag Editor. For the device address configuration procedure, refer to Chapter 2 "5.1 Device Address Settings" on page 2-70.

When the value of device address is 0, the color specified in **Text Color** or in **Plate Color** on the **View** tab will be displayed.

When the value of device address is 1, the color displayed and specified in **Text Color** or **Plate Color** under the **Specify Color**.

Text Color: Selects the color (color: 256 colors, monochrome: 16 shades) of the text when switching. Click this button to display the Color Palette. Select a color from the Color Palette.

Plate Color: Selects the plate color (color: 256 colors, monochrome: 16 shades) when switching. Click this button to display the Color Palette. Select a color from the Color Palette. This option can only be configured when **Standard** is selected for **Image Type** on the **View** tab.

*2 Advanced mode only

Specify Color by Device Address:

Specifies the text and plate colors by the value of the device address.

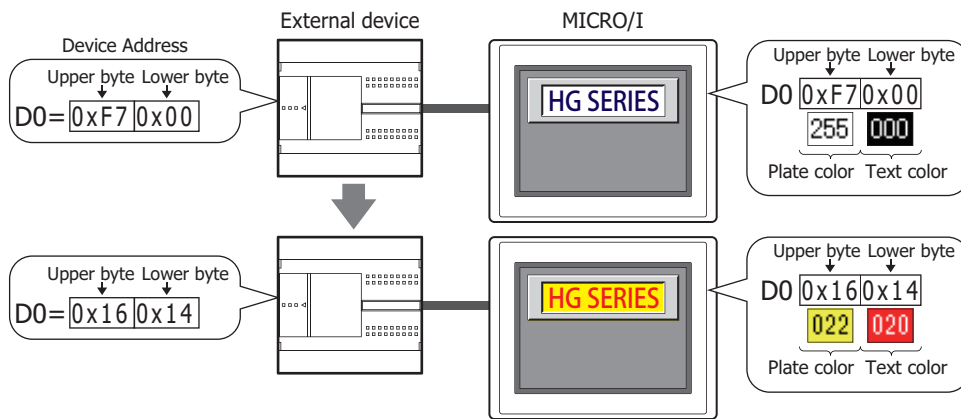

Device Address:

Specify the word device that stores the color data for the text or plate.

Click to display the Tag Editor. For the device address configuration procedure, refer to Chapter 2 "5.1 Device Address Settings" on page 2-70. This uses address number+1 to specify the text and plate colors when the **Flash** check box has been selected.

Color data assignments that are stored to device addresses are given below.

Device Address	bit 15	Upper byte	bit 8	bit 7	Lower byte	bit 0
	Plate color			Text color		
Device Address+1	Plate color when flashing			Text color when flashing		

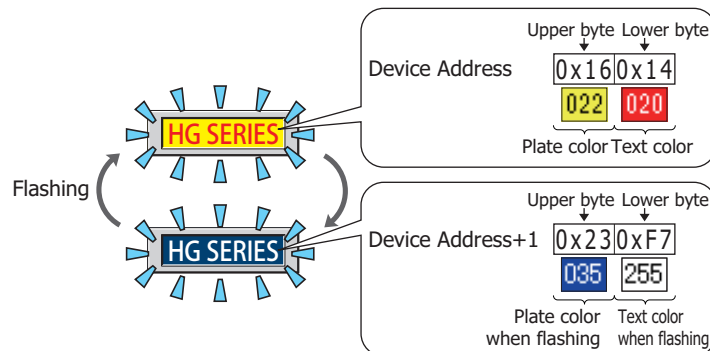

For color data, refer to Appendix "1 Color Number" on page A-1.

■ **Flash** *1

Select this check box to make the text and plate colors flash.

The flashing will occur as follows:

- The **Change Display Colors** check box is cleared, then the colors specified by **Text Color** and **Plate Color** on the **View** tab and the colors specified by **Text Color** and **Plate Color** under **Flash** are alternately displayed.

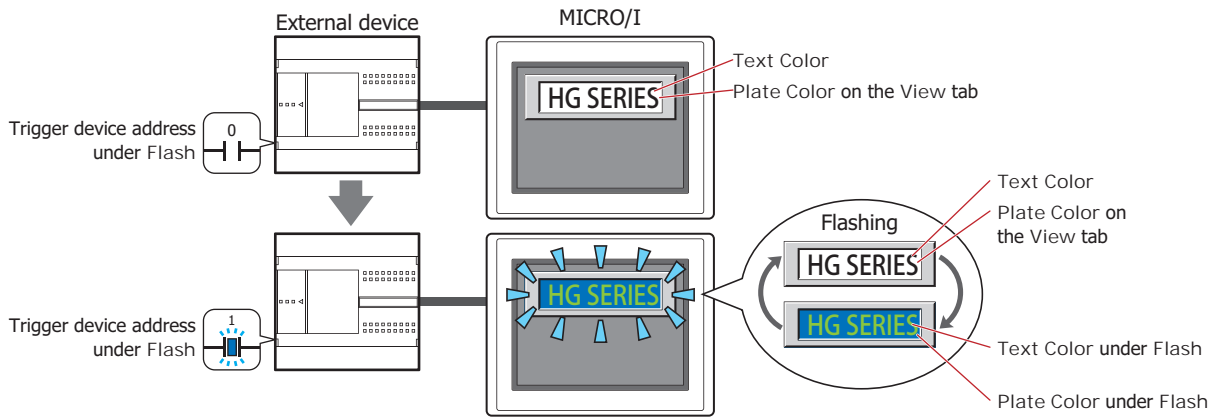

- The **Change Display Colors** check box is selected, **Specify Color** is selected and the value of the trigger device address for **Specify Color** is 0, then the colors specified by **Text Color** and **Plate Color** on the **View** tab and the colors specified by **Text Color** and **Plate Color** under **Flash** are alternately displayed.

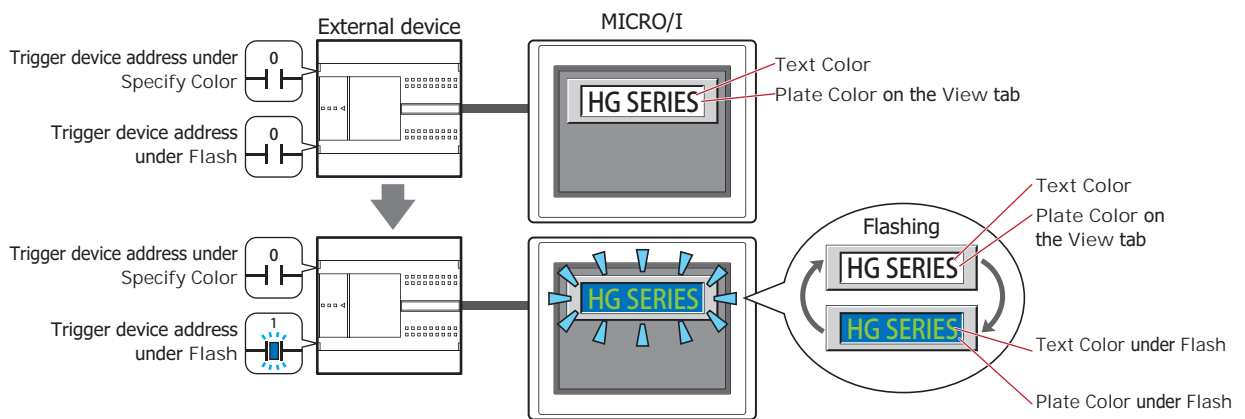

- The **Change Display Colors** check box is selected, **Specify Color** is selected and the value of the trigger device address for **Specify Color** is 1, then the colors specified by **Text Color** and **Plate Color** under **Specify Color** and the colors specified by **Text Color** and **Plate Color** under **Flash** are alternately displayed.

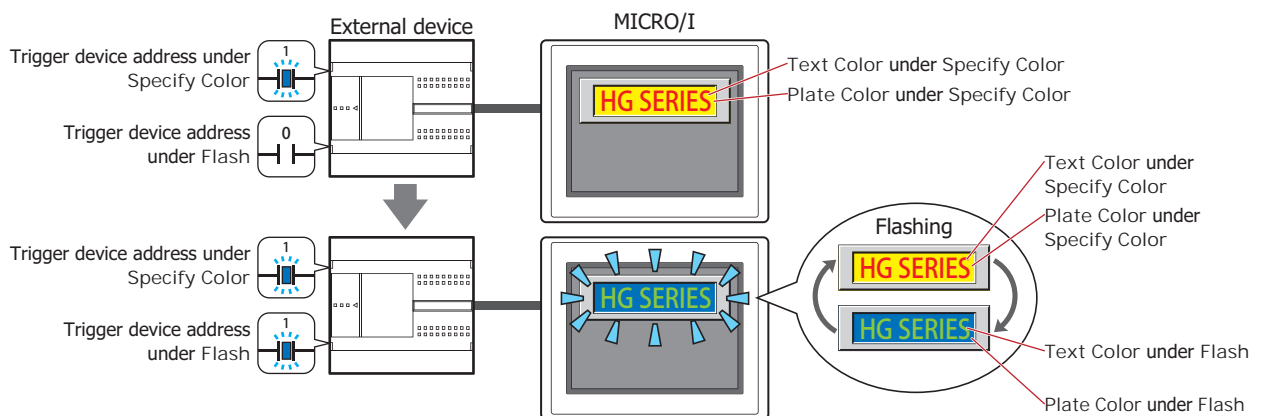

*2 Advanced mode only

- The **Change Display Colors** check box is selected, **Specify Color by Device Address** is selected, then the colors that correspond to the values stored in the device addresses for **Specify Color by Device Address** and this device address number+1 are alternately displayed.

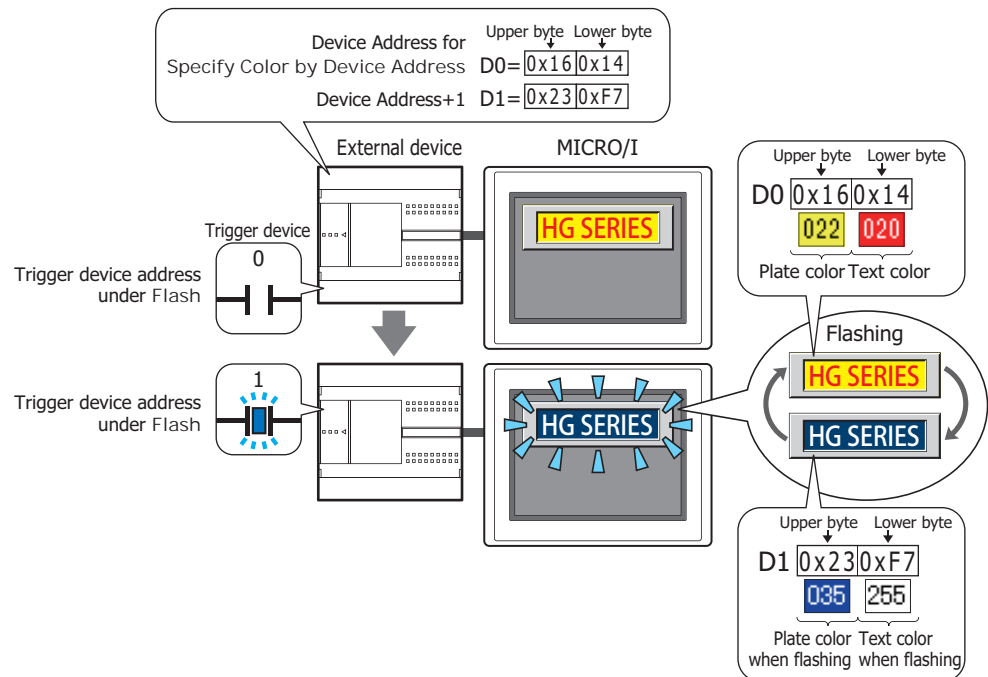

Trigger Device Address: Specifies the bit device or the bit number of the word device that will be used to trigger flash.

Click to display the Tag Editor. For the device address configuration procedure, refer to Chapter 2 "5.1 Device Address Settings" on page 2-70.

Flash intervals are set in the **Flashing Cycle** on the **System** tab in the **Project Settings** dialog box.

Text Color: Selects the color (color: 256 colors, monochrome: 16 shades) of text when flashing.

Click this button to display the Color Palette. Select a color from the Color Palette.

This option can only be configured when the **Change Display Colors** check box is cleared or selected and **Specify Color** is selected.

Plate Color: Selects the plate color (color: 256 colors, monochrome: 16 shades) when flashing.

Click this button to display the Color Palette. Select a color from the Color Palette.

This option can only be configured when the **Change Display Colors** check box is cleared, or the check box and **Specify Color** are selected, and **Standard** is selected for **Image Type** on the **View** tab.

● **Trigger Condition Tab**

The **Trigger Condition** tab is displayed in Advanced mode.

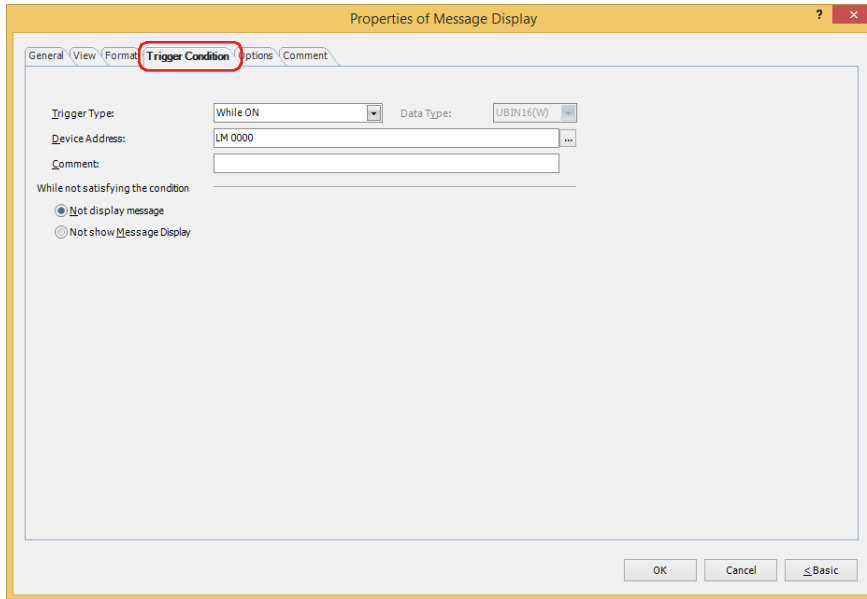

The Message Display is enabled while the condition is satisfied, and it is disabled while the condition is not satisfied. Select the operation when disabled as **Not display message** or **Not show Message Display** under **While not satisfying the condition**.

Example: When **Trigger Type** is **While ON**, **Device Address** is **LM0**, and **While not satisfying the condition** is **Not display message**.

While LM0 is 0, the condition is not satisfied and the Message Display does not display the message.
 While LM0 is 1, the condition is satisfied and the Message Display displays the message.

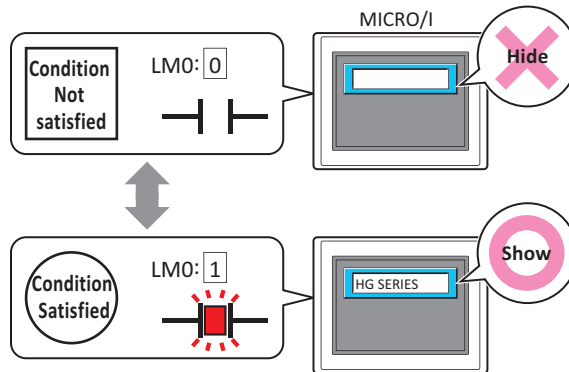

■ **Trigger Type**

Selects the condition to enable the Message Display from the following.

Always visible: The Message Display is always enabled.

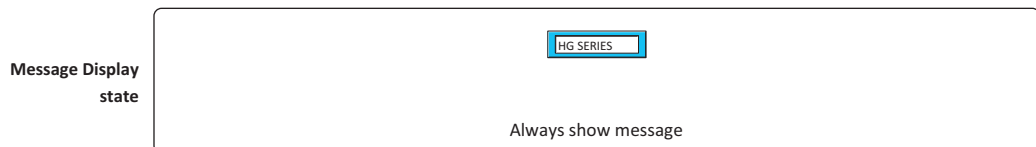

While ON: Enables the Message Display when the value of device address is 1.
 Example: When **While not satisfying the condition** is **Not display message**.

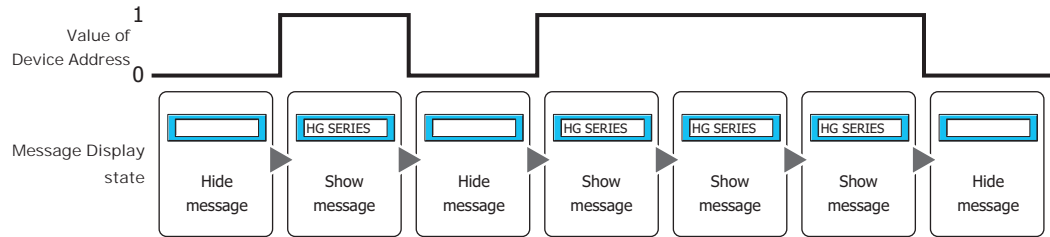

While OFF: Enables the Message Display when the value of device address is 0.
 Example: When **While not satisfying the condition** is **Not display message**.

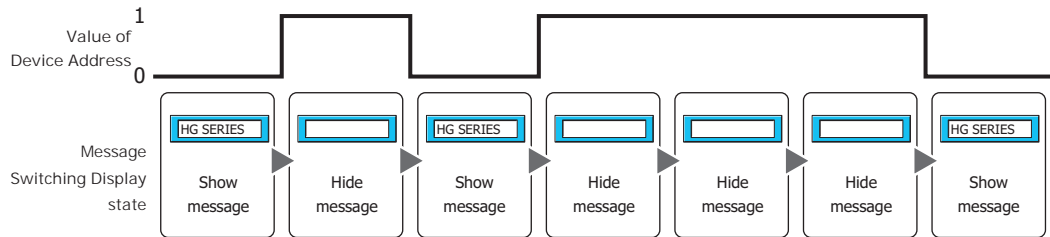

While satisfying the condition: Enables the Message Display when the condition is satisfied.
 Example: When **While not satisfying the condition** is **Not display message**.

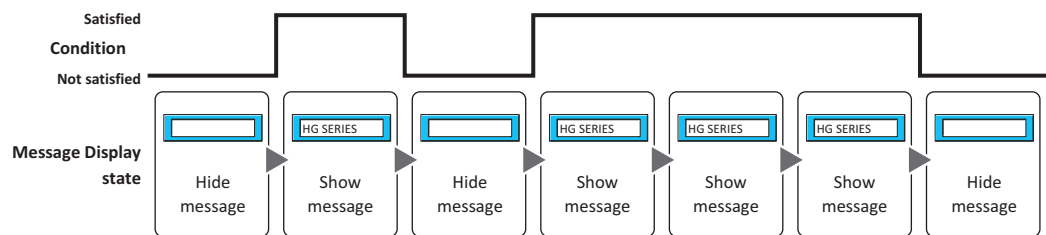

■ Data Type

Selects the data type to be handled by the condition formula.
 Can only be set if **While satisfying the condition** is selected as **Trigger Type**.
 For details, refer to Chapter 2 "1.1 Available Data" on page 2-1.

■ Device Address

Specifies the bit device or the bit number of the word device to serve as condition.
 Can only be set if **While ON** or **While OFF** is selected as **Trigger Type**.

Click to display the Tag Editor. For the device address configuration procedure, refer to Chapter 2 "5.1 Device Address Settings" on page 2-70.

■ Condition

Sets the condition formula.
 Can only be set if **While satisfying the condition** is selected as **Trigger Type**.

Click to display the **Trigger Condition Settings** dialog box. For the conditional expression configuration procedure, refer to Chapter 2 "5.2 Setting Conditional Expressions" on page 2-73.

■ Comment

Used for entering comments about trigger conditions. Maximum number is 80 characters.

■ While not satisfying the condition

Selects the operation of the part when the condition is not satisfied.

Not display message: The plate and flange are displayed, but the message is not displayed.

Not show Message Display: Hides the Message Display.

● Options Tab

The **Options** tab is displayed in Advanced mode.

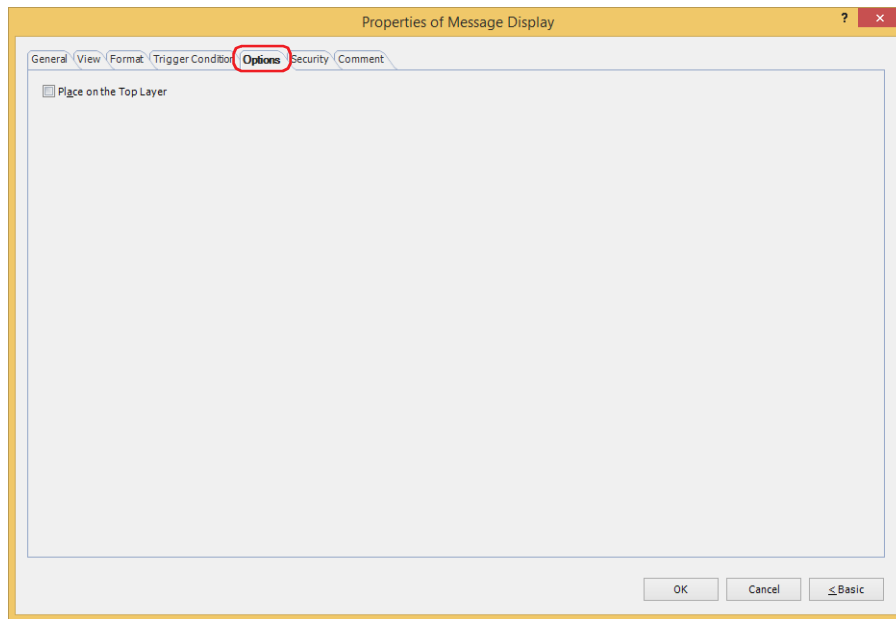

■ Place on the Top Layer

Select this check box to display the parts on the top layer. The parts will have precedence when other drawings and parts are overlapping with it. For details, refer to Chapter 6 "4 Drawings and Parts Overlapping" on page 6-5.

● Security Tab

This tab is used to restrict displaying and using the part by security groups.

This option can only be set when **Use Security functions** is selected. The **Use Security functions** check box is set on **General** tab in the **Security** dialog box.

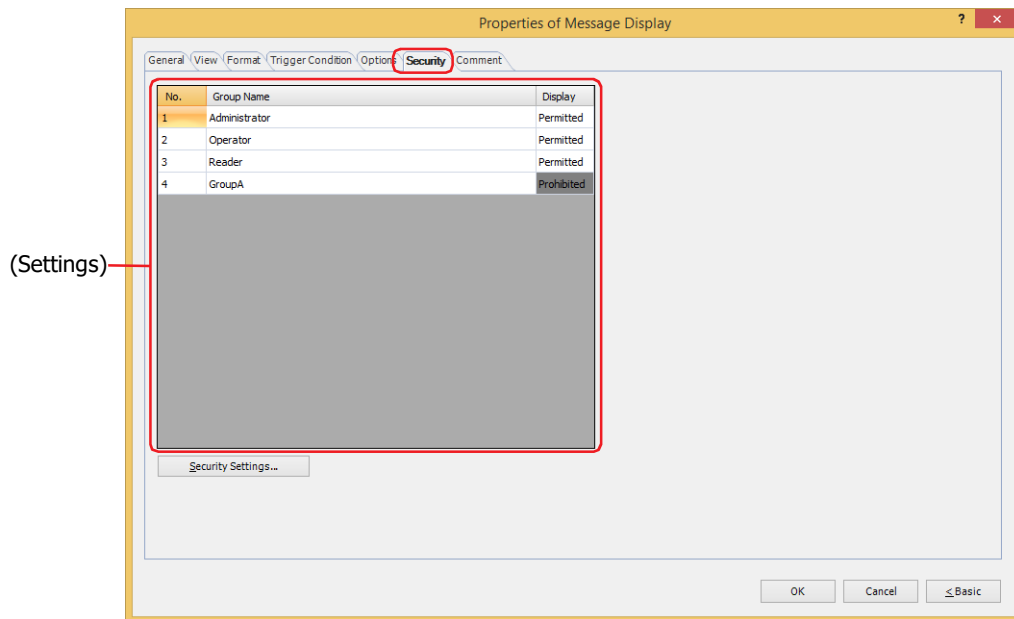

■ (Settings)

Displays the list of security groups used on the MICRO/I.

No.:	Displays the security group numbers (1 to 15).
Group Name:	Displays the name of the security group.
Display:	Displays whether or not there is permission to display the part. Only Permitted security groups can display this part. If all security groups are set to Permitted , this part will be displayed even if no user account has been selected. Double clicking the cell switches between Permitted and Prohibited .



You can also switch between **Permitted** and **Prohibited** by right-clicking on a **Display** cell.



■ Security Settings

The Security Settings dialog box is displayed. If you create a security group in the **Security Settings** dialog box, you can select that created group. For details, refer to Chapter 23 “2.2 Adding and Editing Security Groups” on page 23-19.



For details about security functions, refer to Chapter 23 “User Accounts and the Security Function” on page 23-1.

Example: If the user and security group for a part are set as follows:

User Name	 User1	 User2
Security Group	Reader	Operator

Line Chart and Bar Chart

No.	Group Name	Display
1	Administrator	Permitted
2	Operator	Permitted
3	Reader	Prohibited

MICRO/I

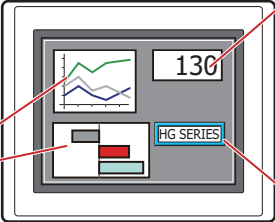

Numerical Display

No.	Group Name	Display
1	Administrator	Permitted
2	Operator	Permitted
3	Reader	Permitted

Message Display

No.	Group Name	Display
1	Administrator	Permitted
2	Operator	Permitted
3	Reader	Prohibited

For User1 in the **Reader** security group, the parts for which **Display** has been set to **Prohibited** for **Reader** will not be displayed.

If the password screen is opened and the user switches to User2 in the **Operator** security group, the parts for which **Display** has been set to **Permitted** for **Operator** will be displayed.

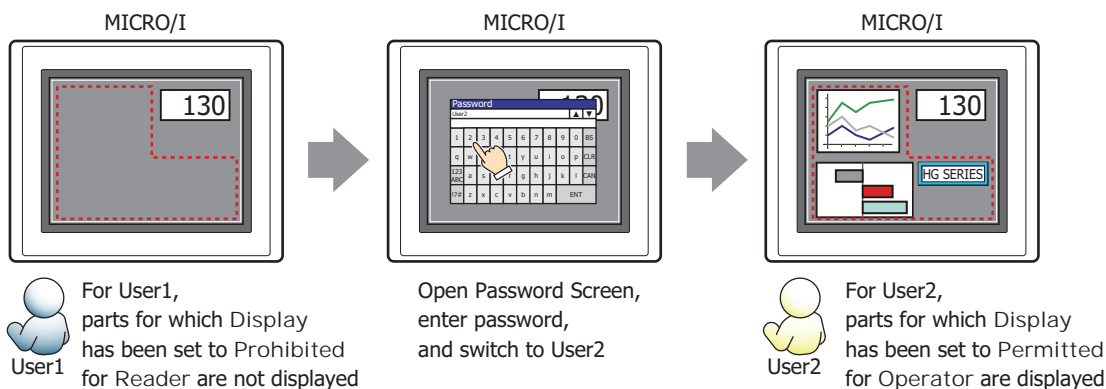

● Comment Tab

The **Comment** tab is used to specify the parts placed on the editing screen, and the popup text displayed when the mouse pointer is placed close to **No.**, **Name**, or **Type** in the object list.



When there are multiple parts of the same shape on the screen, this feature makes it possible to distinguish between the parts without displaying the Properties dialog box for each part, by just mousing over the part.

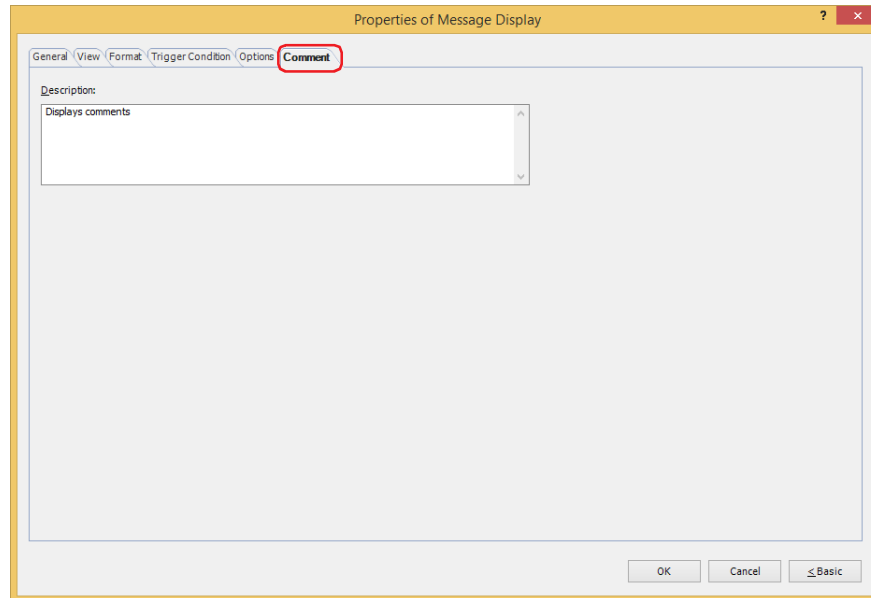

■ Description

Used for entering comments about parts. Maximum number is 80 characters.

Example: When mousing over the Message Display on the editing screen

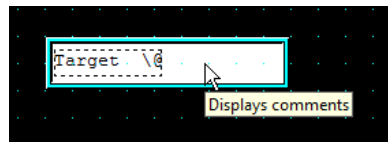

5.4 String Data Storage Method

The values of device addresses read as character codes are stored in the upper byte and lower byte of words according to the **Storage Method of String Data** setting. **Storage Method of String Data** is configured on the **System** tab in the **Project Settings** dialog box.

For details, refer to Chapter 4 "3.1 System Tab" on page 4-25.

Example: When reference device address D100 = 3132 (Hex), D101 = 3334 (Hex), D102 = 3500 (Hex)

- When **from Upper byte** is selected for **Storage Method of String Data**

Device address	Stored value		Displayed string
	Upper byte	Lower byte	
D100	31 (Hex)	32 (Hex)	12
D101	33 (Hex)	34 (Hex)	34
D102	35 (Hex)	0	5

NULL terminating character

- When **from Lower byte** is selected for **Storage Method of String Data**

Device address	Stored value		Displayed string
	Upper byte	Lower byte	
D100	32 (Hex)	31 (Hex)	21
D101	34 (Hex)	33 (Hex)	43
D102	0	35 (Hex)	

NULL terminating character

When handling values of device addresses as character codes, 0 is handled as the NULL terminating character to end the string. Therefore, when the upper byte is 0, nothing is displayed.



- When handling values of device addresses as character codes, 0 is handled as the NULL terminating character to end the string. Therefore, when the upper byte is 0, nothing is displayed.
- To display only a single character, set the lower byte to 0.

Example: To display a single-byte 7

3700(Hex)

6 Message Switching Display

HG2J-7U HG5G-V HG4G-V HG4G HG3G-V HG3G HG2G-V HG2G-5F HG2G-5T HG1G HG1P

6.1 How the Message Switching Display is Used

The Message Switching Display is used to switch the displayed message according to the value of a word device.

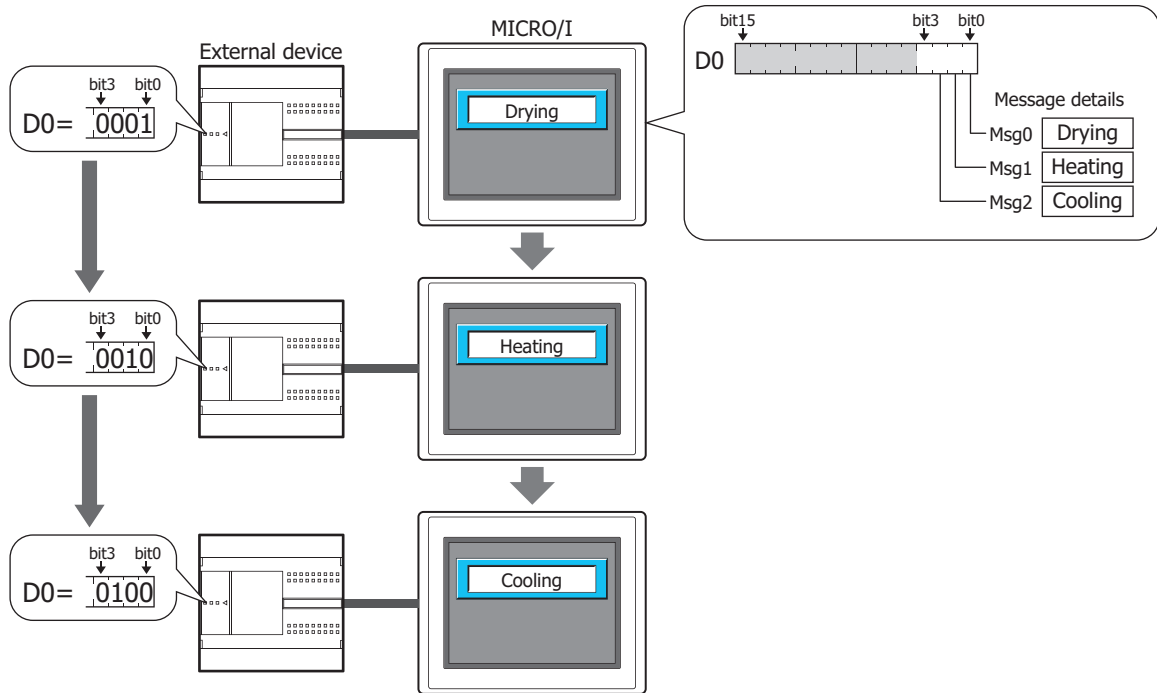

6.2 Message Switching Display Configuration Procedure

This section describes the configuration procedure for Message Switching Displays.

- 1 On the **Home** tab, in the **Parts** group, click **Data Displays**, and then click **Message Switching Display**.

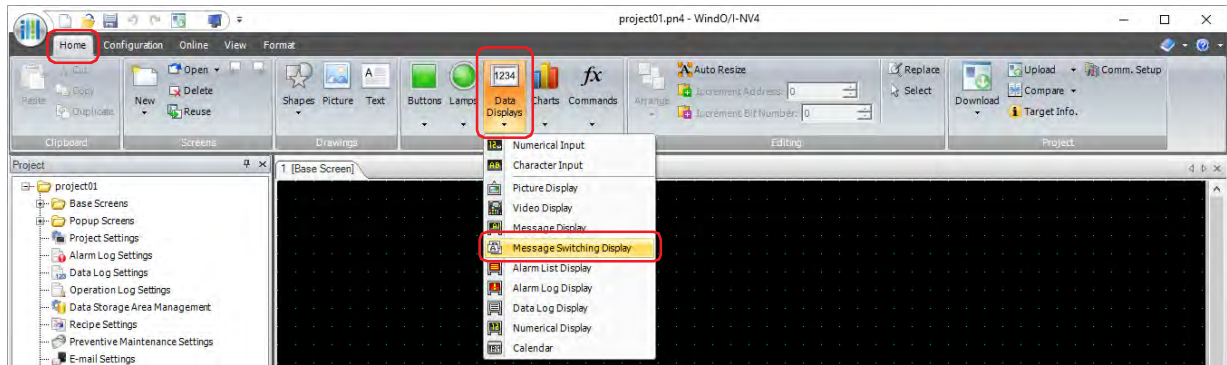

- 2 Click a point on the edit screen where you wish to place the Message Switching Display.
- 3 Double-click the placed Message Switching Display and a Properties dialog box will be displayed.
- 4 Change the settings on each tab as necessary.

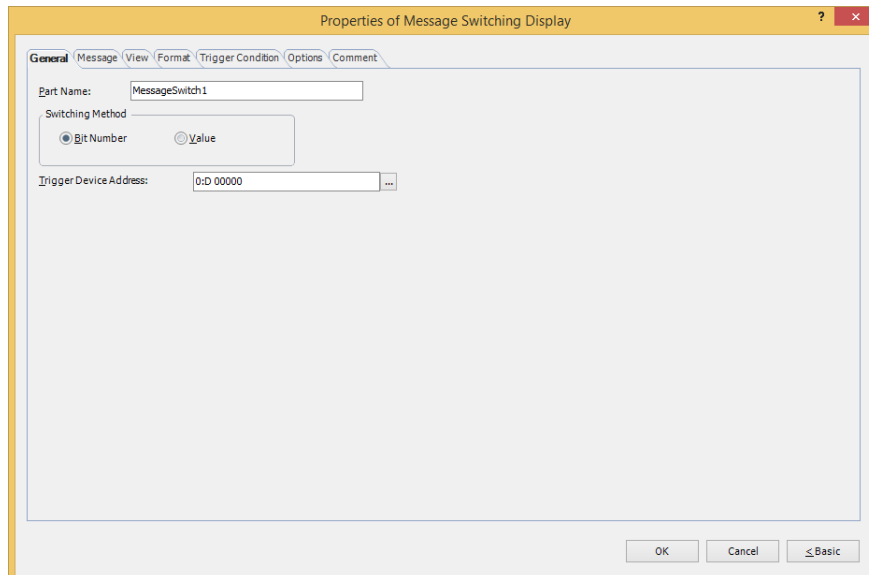

The **Trigger Condition** tab and **Options** tab only appear in Advanced mode.



You can set the default for the Message Switching Display on the **Default Preferences** tab of the **WindO/I-NV4 Options** dialog box. For details, refer to Chapter 2 "Default Preferences Tab" on page 2-63.

6.3 Properties of Message Switching Display Dialog Box

This section describes items and buttons on the properties dialog box.

● General Tab

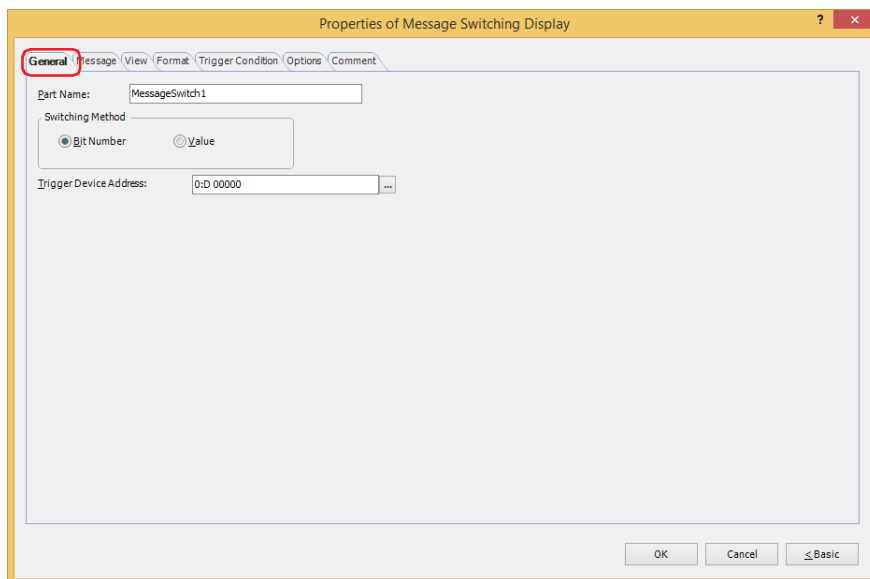

■ Part Name

Enter a name for the part. The maximum number is 20 characters.

■ Switching Method

Selects the method for switching message to display from the following. Messages are registered in **Settings** on the **Message** tab.

Bit Number: Switches the message to display according to the status of bits in a device address.

Example: When **Bit Number** is selected and the bits of trigger device address D0 are allocated to the following messages.

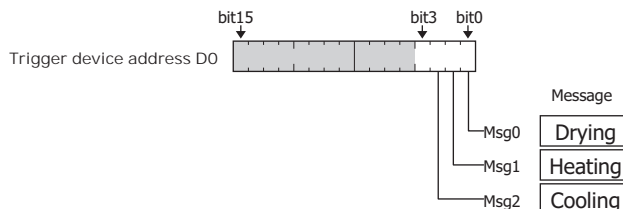

Switches the message to display according to the status of the bits.

Bit state of Trigger Device Address D0	0001	0010	0100	1000	1110
Message to display	Drying (Msg0)	Heating (Msg1)	Cooling (Msg2)	No message	Heating (Msg1)
Action	Display Msg0	Display Msg1	Display Msg2	No message	Display Msg1

If multiple bits are 1, display the message for the lowest order bit.

If all bits in the device address are 0 or if a bit with no associated message becomes 1, display nothing.

Value: Switches the message to display according to the value of a device address.
Example: When **Value** is selected and the trigger device addresses D0 are allocated to the following messages.

Message details

Value of Trigger Device Address D0	0 : Msg0	Drying
	1 : Msg1	Heating
	2 : Msg2	Cooling

Switches the message to display according to the value of the device address.

Value of Trigger Device Address D0	0	1	2	3
Message to display	Drying Msg0	Heating Msg1	Cooling Msg2	
Action	Display Msg0	Display Msg1	Display Msg2	No message

If the value of device address has no message associated with it, display nothing.

■ **Trigger Device Address**

Specifies the word device to use as the condition for switching messages.

Click to display the Tag Editor. For the device address configuration procedure, refer to Chapter 2 "5.1 Device Address Settings" on page 2-70.

● Message Tab

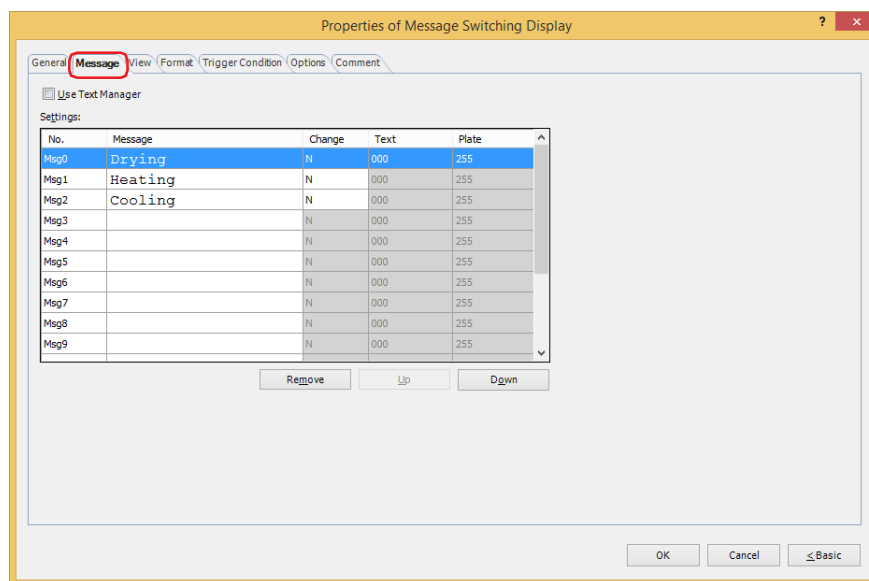

■ Use Text Manager

Select this check box to use text registered in Text Manager.

■ Settings

Edits the message settings.

No.: Shows the message number (Msg number).

The number of messages that can be registered varies based on **Switching Method** on the **General** tab.

Bit Number: Msg0 to Msg15

Value: Msg0 to Msg999

Message: Enter the text to display.

Double clicking the cell allows to edit the Message. The maximum number is 3750 characters. You can enter multi-line messages by inserting a newline.

The characters that can be entered vary based on the font selected for **Font** on the **Format** tab. For details, refer to Chapter 2 "1.2 Available Text" on page 2-6.

This option can only be configured if the **Use Text Manager** check box is cleared.



- To display the backslash (\), enter a backslash (\) before the backslash (\).
- A line feed is added with pressing and holding ALT and ENTER keys.

Change: Selects whether or not to configure **Text** and **Plate** per Msg number. For **N**, the colors are configured by **Text Color** on the **Format** tab and **Plate Color** on the **View** tab. Double clicking the cell toggles between **Y** as Yes and **N** as No.

Text: Selects the text color for the messages when configuring the text color per Msg number (color: 256 colors, monochrome: 16 shades).

Double clicking the cell displays the Color Palette where you can change the Text Color.

Plate: Selects the plate color for the messages when configuring the plate color per Msg number (color: 256 colors, monochrome: 16 shades).

Double clicking the cell displays the Color Palette where you can change the Plate Color.

- **Remove**

Deletes the registered settings from the list.

- **Up**

Shifts the selected settings upward in the list.

- **Down**

Shifts the selected settings downward in the list.

● View Tab

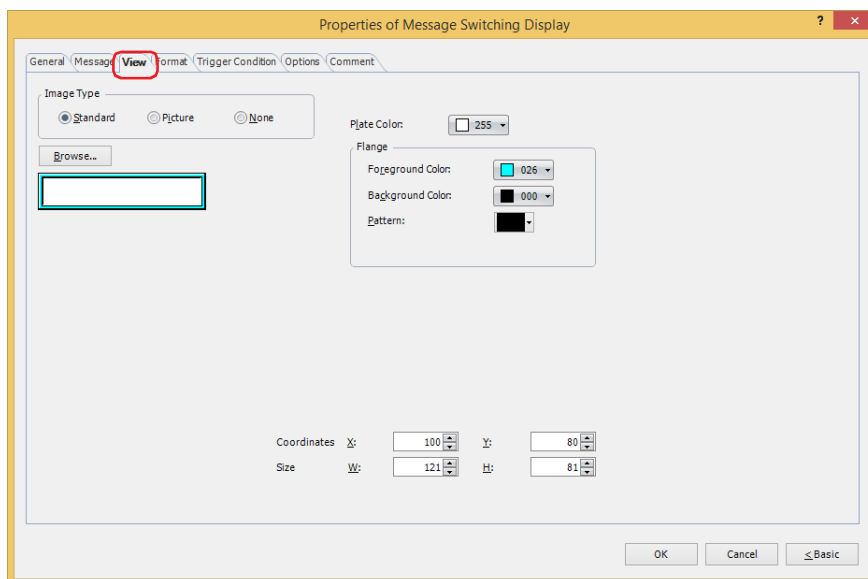

■ Image Type

Select the type of graphic to be used to represent the part.

Standard: Uses the default graphic for WindO/I-NV4.

Picture: Uses an image file saved using Picture Manager.

For details about image file restrictions, refer to Chapter 2 "1.4 Available Image Files" on page 2-20.

None: The plate and the flange of the part are not displayed. Only the text is displayed.

■ Browse

Select the type of graphic to be used to represent the part from the list of graphics. Click this button to display the View Browser or Picture Manager, depending on the setting for **Image Type**.

■ Plate Color

Selects the plate color of the standard graphic (color: 256 colors, monochrome: 16 shades).

Click **Color** to display the Color Palette. Select a color from the Color Palette.

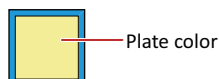

■ Flange

Foreground Color, Background Color: Selects the foreground and background colors of the flange of the standard graphic (color: 256 colors, monochrome: 16 shades).

Click **Color** to display the Color Palette. Select a color from the Color Palette.

Pattern:

Selects a pattern for the flange of the standard graphic.

Click **Pattern** to display the Pattern Palette. Select a pattern from the Pattern Palette.



■ Coordinates

X, Y: Sets the display position of parts using coordinates.

The X and Y coordinates of parts is defined relative to an origin at the top-left corner of the screen.

X: 0 to (base screen horizontal size - 1)

Y: 0 to (base screen vertical size - 1)

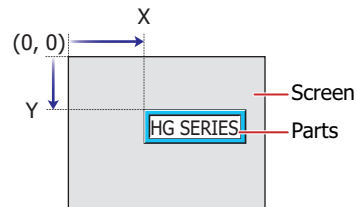

■ Size

W, H: Sets width and height to define the size of parts.

W: 5 to (base screen horizontal size)

H: 5 to (base screen vertical size)

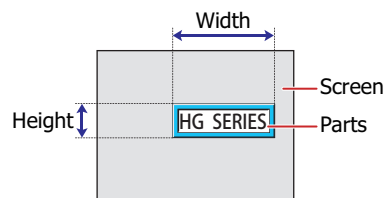

● Format Tab

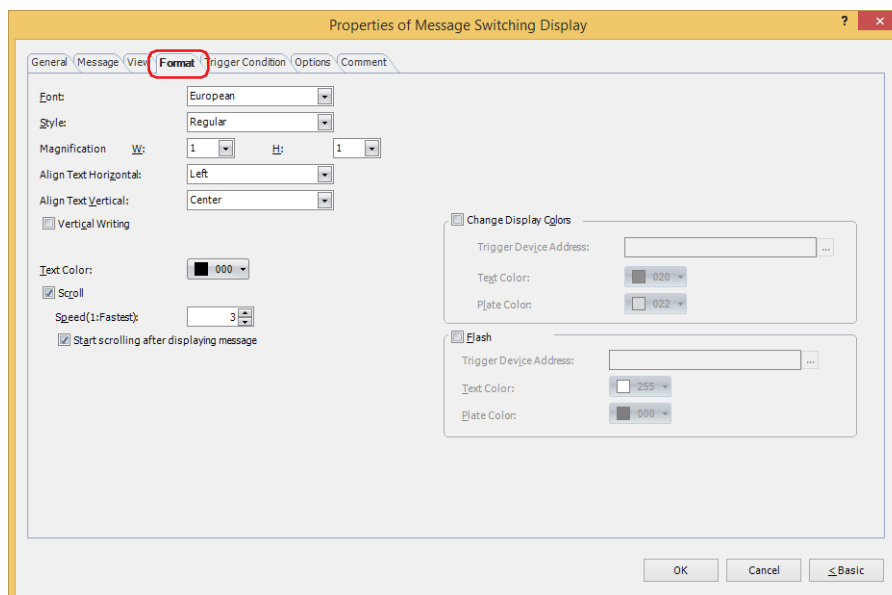

■ Font

Selects the font used for displaying text from the following.

Western, Japanese, Simplified Chinese, Traditional Chinese, Hangul, Central European, Baltic, Cyrillic, Stroke^{*1}

The characters that can be displayed depend on the font. For details, refer to Chapter 2 “1.2 Available Text” on page 2-6.

■ Size

Specifies the text size to be displayed. The fonts and sizes that can be set vary based on the model.

Model	Font	Size
HG2J-7U	Western, Japanese, Simplified Chinese, Traditional Chinese, Hangul, Central European, Baltic, Cyrillic	8 to 150
HG5G/4G/3G/2G-V, HG4G/3G, HG2G-5F/-5T, HG1G/1P	Stroke	8 to 128

■ Style^{*1}

Selects **Regular** or **Bold** for text style.

Can only be set when **Western, Japanese, Simplified Chinese, Traditional Chinese, Hangul, Central European, Baltic, Cyrillic** is selected for **Font**.

■ Magnification^{*1}

W, H: Selects text magnification (0.5, 1 to 8).

Can only be set when **Western, Japanese, Simplified Chinese, Traditional Chinese, Hangul, Central European, Baltic, Cyrillic** is selected for **Font**.

■ Align Text Horizontal

Selects the text alignment in the horizontal direction from the following.

Left, Center, Right, Center-Left, Left-Right

If **Top, Center** or **Bottom** is selected for **Align Text Vertical**, **Center** or **Right** can be set as this option.

If **Center-Top** is selected for **Align Text Vertical**, **Center-Left** or **Left-Right** can be set as this option.

For details, refer to Appendix “5 Text Alignment” on page A-7.

■ Align Text Vertical

Selects the text alignment in the vertical direction from the following.

Top, Center, Bottom, Center-Top

Set to **Center** when the **Vertical Writing** check box is selected.

For details, refer to Appendix “5 Text Alignment” on page A-7.

*1 HG5G/4G/3G/2G-V, HG4G/3G, HG2G-5F/-5T, HG1G/1P only

Vertical Writing

Select this check box when displaying text vertically.

Can only be set when **Font** is set to **Western, Japanese, Simplified Chinese, Traditional Chinese, Hangul, Central European, Baltic, Cyrillic**.



When the **Vertical Writing** check box is selected, take care about the following points. This is applicable for Windows supports East Asian characters.

- When there is a mixture of double-byte and single-byte characters, the half-width characters are left-aligned.

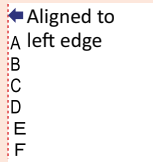

- Dashes are displayed horizontally. Symbols representing voiced and semi-voiced sounds of single-byte characters are shown as follows.

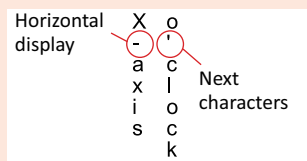

Text Color

Selects the color of displayed text (color: 256 colors, monochrome: 16 shades).

Click **Color** to display the Color Palette. Select a color from the Color Palette.

Scroll*2

Select this check box to enable scrolling display displaying of messages.

This option can only be configured when **Standard** is selected for **Image Type** on the **View** tab and the **Flash** check box is cleared.

Speed (1: Fastest):

Sets the scrolling speed (1 to 10). 1 is fastest, 10 is slowest.

Start scrolling after displaying message: Select this check box to start scrolling after a message is displayed for 2 seconds.

This check box is cleared.

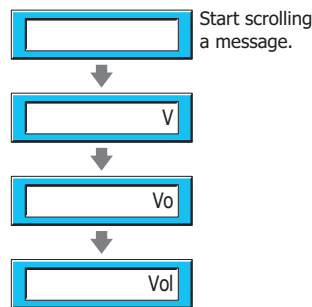

This check box is selected.

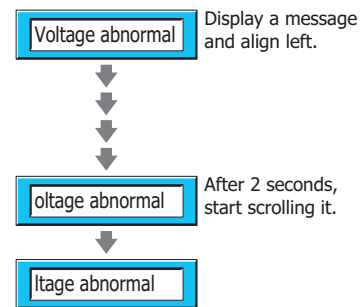

- When the **Scroll** check box is selected, the number of parts that can be arranged on a single screen decreases. If the MICRO/I displays an error message, clear the **Scroll** check box, or reduce the number of parts on the screen.
- When the scan time for the screen becomes longer, and when the part that has its **Scroll** check box selected is placed on the top layer, the scrolling speed may become slow.



When the **Scroll** check box is selected operation is follows.

- Messages that include CRs are displayed without the CRs.
- Messages scroll in the direction in which the text is drawn.
- When the message is switched, the message is scrolled from the beginning.

*2 Advanced mode only

■ Change Display Colors*2

Select this check box to switch the text and plate colors.

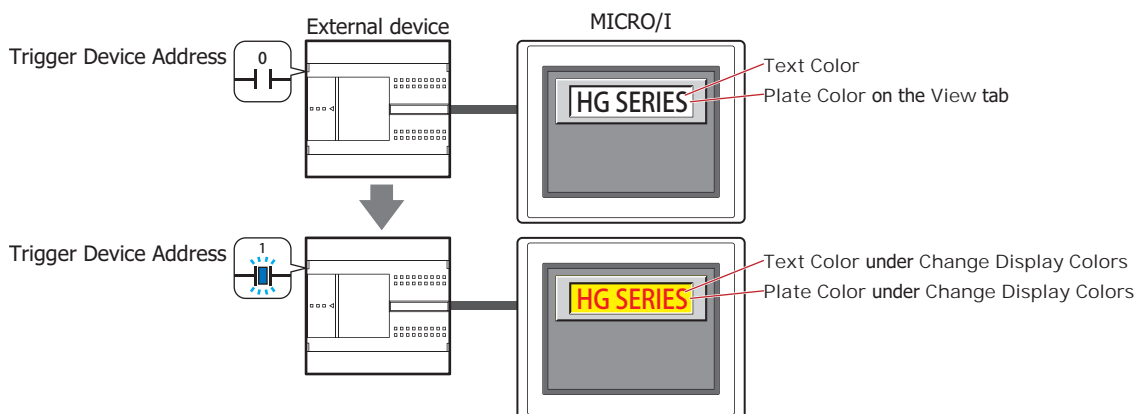

Trigger Device Address: Specifies the bit device or the bit number of the word device to use as the trigger to switch the text and plate colors.

Click  to display the Tag Editor. For the device address configuration procedure, refer to Chapter 2 "5.1 Device Address Settings" on page 2-70.

When the value of device address is 0, the color specified in **Text Color** or in **Plate Color** on the **View** tab will be displayed.

When the value of device address is 1, the color displayed and specified in **Text Color** or **Plate Color** under the **Change Display Colors**.

Text Color: Selects the color (color: 256 colors, monochrome: 16 shades) of the text when switching. Click this button to display the Color Palette. Select a color from the Color Palette.

Plate Color: Selects the plate color (color: 256 colors, monochrome: 16 shades) when switching. Click this button to display the Color Palette. Select a color from the Color Palette. This option can only be configured when **Standard** is selected for **Image Type** on the **View** tab.

*2 Advanced mode only

■ **Flash** *2

Select this check box to make the text and plate colors flash.

The flashing will occur as follows:

- The **Change Display Colors** check box is cleared, then the colors specified by **Text Color** and **Plate Color** on the **View** tab and the colors specified by **Text Color** and **Plate Color** under **Flash** are alternately displayed.

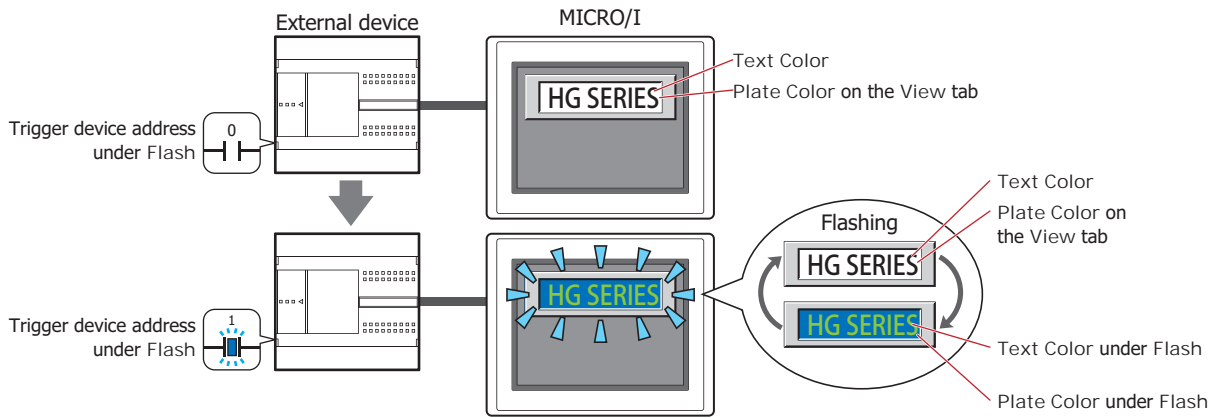

- The **Change Display Colors** check box is selected and the value of the trigger device address for **Change Display Colors** is 0, then the colors specified by **Text Color** and **Plate Color** on the **View** tab and the colors specified by **Text Color** and **Plate Color** under **Flash** are alternately displayed.

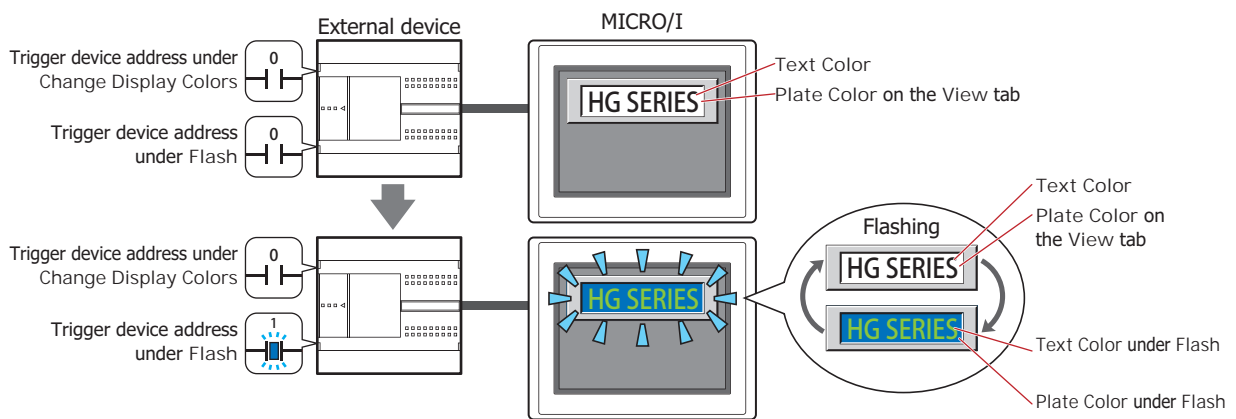

- The **Change Display Colors** check box is selected and the value of the trigger device address for **Change Display Colors** is 1, then the colors specified by **Text Color** and **Plate Color** under **Change Display Colors** and the colors specified by **Text Color** and **Plate Color** under **Flash** are alternately displayed.

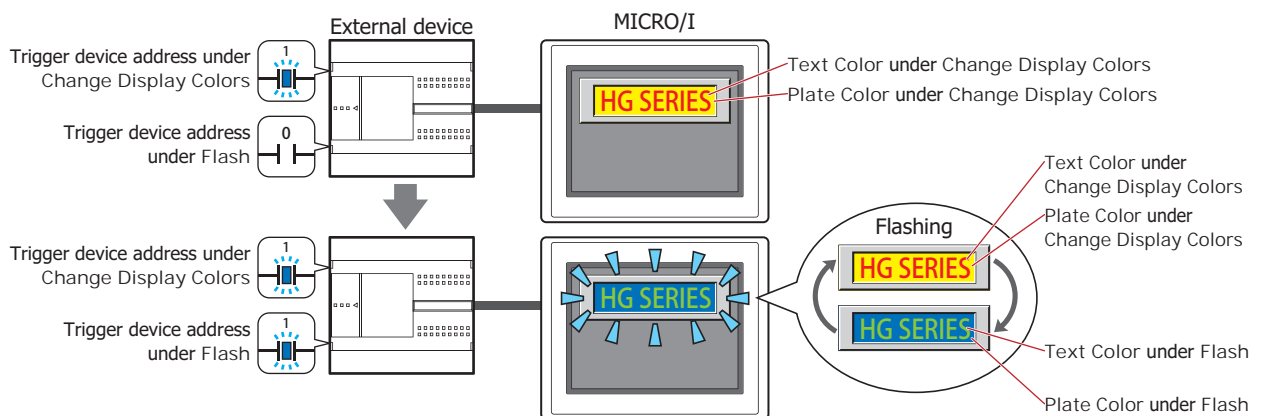

*2 Advanced mode only

- Trigger Device Address:** Specifies the bit device or the bit number of the word device that will be used to trigger flash.
Click  to display the Tag Editor. For the device address configuration procedure, refer to Chapter 2 "5.1 Device Address Settings" on page 2-70.
Flash intervals are set in the **Flashing Cycle** on the **System** tab in the **Project Settings** dialog box.
- Text Color:** Selects the color (color: 256 colors, monochrome: 16 shades) of text when flashing.
Click this button to display the Color Palette. Select a color from the Color Palette.
- Plate Color:** Selects the plate color (color: 256 colors, monochrome: 16 shades) when flashing.
Click this button to display the Color Palette. Select a color from the Color Palette.
This option can only be configured when **Standard** is selected for **Image Type** on the **View** tab.

● Trigger Condition Tab

The **Trigger Condition** tab is displayed in Advanced mode.

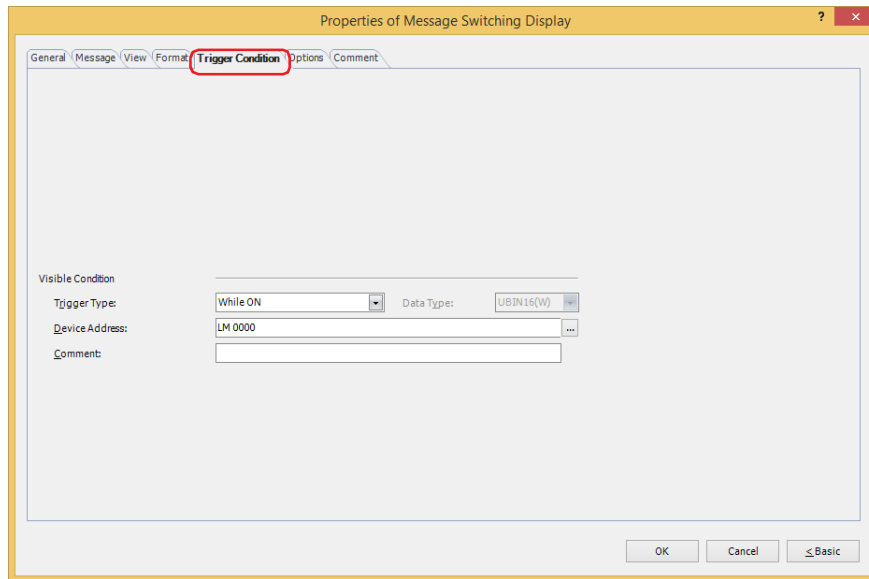

■ Visible Condition

The Message Switching Display is displayed while the condition is satisfied. The Message Switching Display is hidden while the condition is not satisfied.

Example: When **Trigger Type** is **While ON** and **Device Address** is **LM0**

While LM0 is 0, the condition is not satisfied and the Message Switching Display is hidden.

While LM0 is 1, the condition is satisfied and the Message Switching Display is displayed.

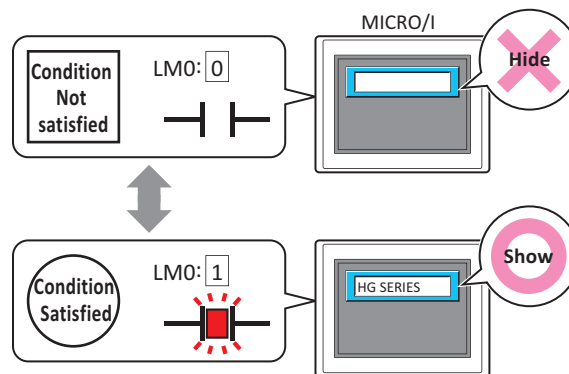

Trigger Type: Selects the condition to display the Message Switching Display from the following.

Always visible: The Message Switching Display is always displayed.



While ON: Displays the Message Switching Display when the value of device address is 1.

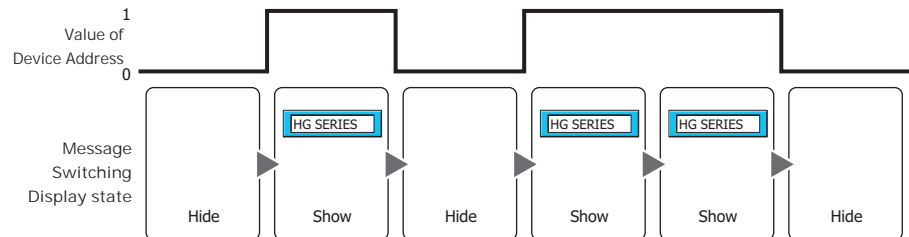

While OFF: Displays the Message Switching Display when the value of device address is 0.

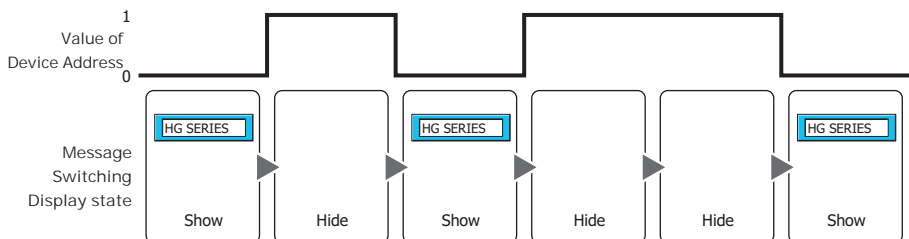

While satisfying the condition:

Displays the Message Switching Display when the condition is satisfied.

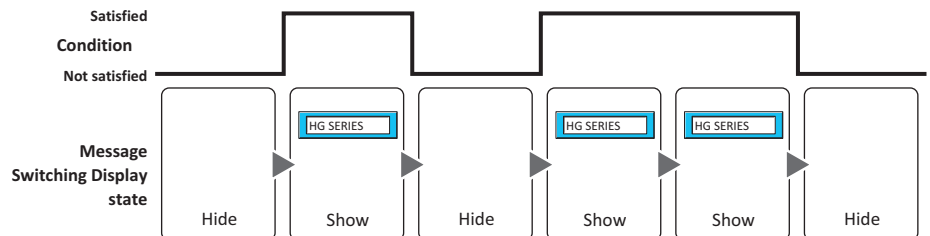

Data Type: Selects the type of data handled by the conditional expression for the visible condition.

This option can only be configured if **While satisfying the condition** is selected for **Trigger Type**. For details, refer to Chapter 2 "1.1 Available Data" on page 2-1.

Device Address: Specifies the bit device or the bit number of the word device to serve as the visible condition.

This option can only be configured when **While ON** or **While OFF** is selected for **Trigger Type**.

Click to display the Tag Editor. For the device address configuration procedure, refer to Chapter 2 "5.1 Device Address Settings" on page 2-70.

Condition: Specifies the conditional expression for the visible condition.

This option can only be configured when **While satisfying the condition** is selected for **Trigger Type**.

Click to display the **Trigger Condition Settings** dialog box. For the conditional expression configuration procedure, refer to Chapter 2 "5.2 Setting Conditional Expressions" on page 2-73.

Comment: Used for entering a comment for the visible condition. The maximum number is 80 characters.

● **Options Tab**

The **Options** tab is displayed in Advanced mode.

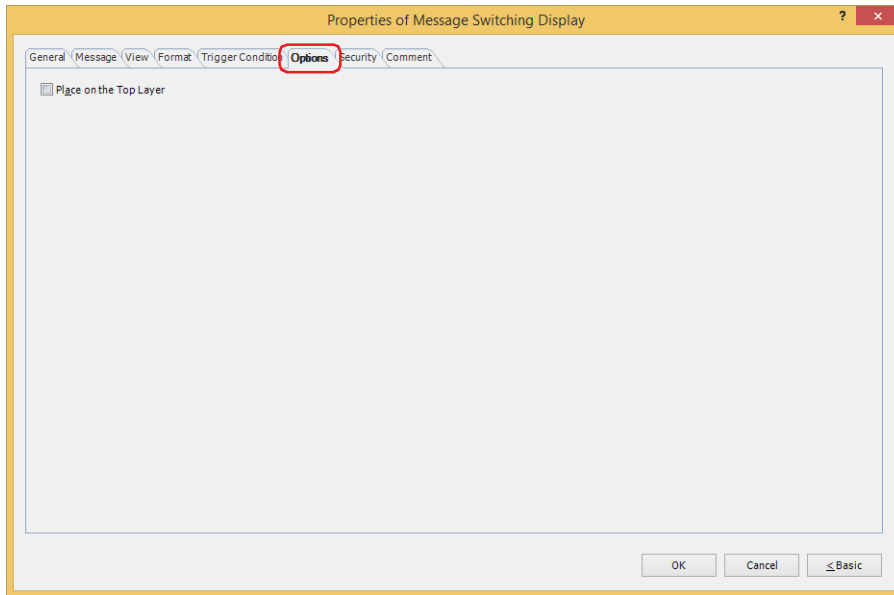

■ **Place on the Top Layer**

Select this check box to display the parts on the top layer. The parts will have precedence when other drawings and parts are overlapping with it. For details, refer to Chapter 6 "4 Drawings and Parts Overlapping" on page 6-5.

● Security Tab

This tab is used to restrict displaying and using the part by security groups.

This option can only be set when **Use Security functions** is selected. The **Use Security functions** check box is set on **General** tab in the **Security** dialog box.

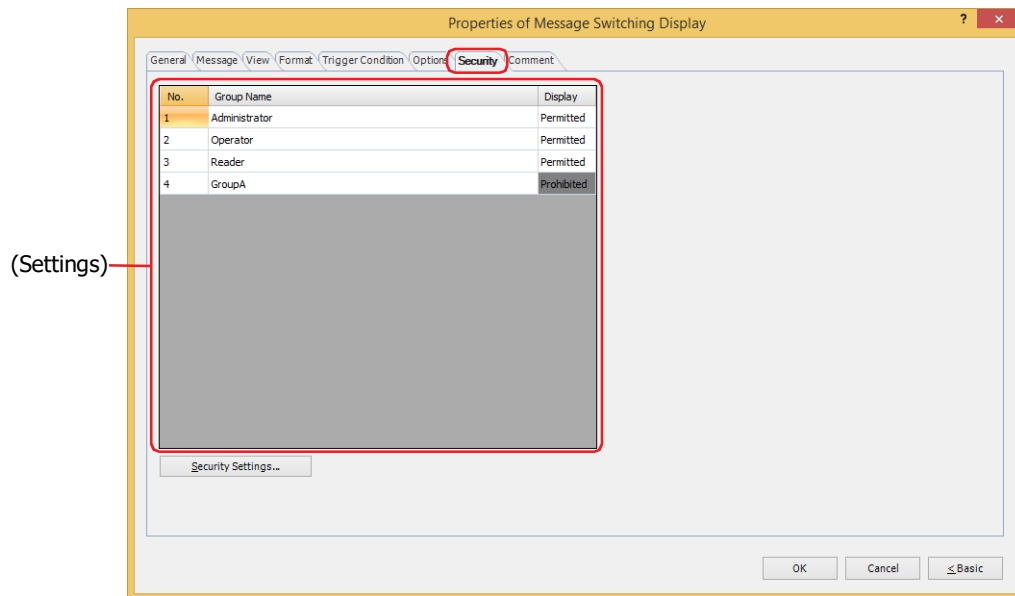

■ (Settings)

Displays the list of security groups used on the MICRO/I.

No.: Displays the security group numbers (1 to 15).

Group Name: Displays the name of the security group.

Display: Displays whether or not there is permission to display the part. Only **Permitted** security groups can display this part. If all security groups are set to **Permitted**, this part will be displayed even if no user account has been selected. Double clicking the cell switches between **Permitted** and **Prohibited**.



You can also switch between **Permitted** and **Prohibited** by right-clicking on a **Display** cell.



■ Security Settings

The Security Settings dialog box is displayed. If you create a security group in the **Security Settings** dialog box, you can select that created group. For details, refer to Chapter 23 "2.2 Adding and Editing Security Groups" on page 23-19.



For details about security functions, refer to Chapter 23 "User Accounts and the Security Function" on page 23-1.

Example: If the user and security group for a part are set as follows:

User Name	 User1	 User2
Security Group	Reader	Operator

Line Chart and Bar Chart

No.	Group Name	Display
1	Administrator	Permitted
2	Operator	Permitted
3	Reader	Prohibited

MICRO/I

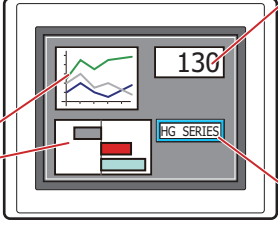

Numerical Display

No.	Group Name	Display
1	Administrator	Permitted
2	Operator	Permitted
3	Reader	Permitted

Message Switching Display

No.	Group Name	Display
1	Administrator	Permitted
2	Operator	Permitted
3	Reader	Prohibited

For User1 in the **Reader** security group, the parts for which **Display** has been set to **Prohibited** for **Reader** will not be displayed.

If the password screen is opened and the user switches to User2 in the **Operator** security group, the parts for which **Display** has been set to **Permitted** for **Operator** will be displayed.

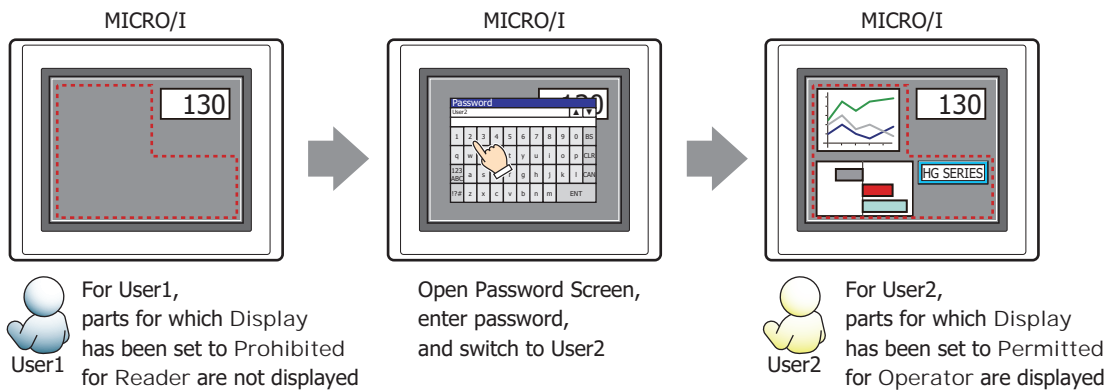

● Comment Tab

The **Comment** tab is used to specify the parts placed on the editing screen, and the popup text displayed when the mouse pointer is placed close to **No.**, **Name**, or **Type** in the object list.



When there are multiple parts of the same shape on the screen, this feature makes it possible to distinguish between the parts without displaying the Properties dialog box for each part, by just mousing over the part.

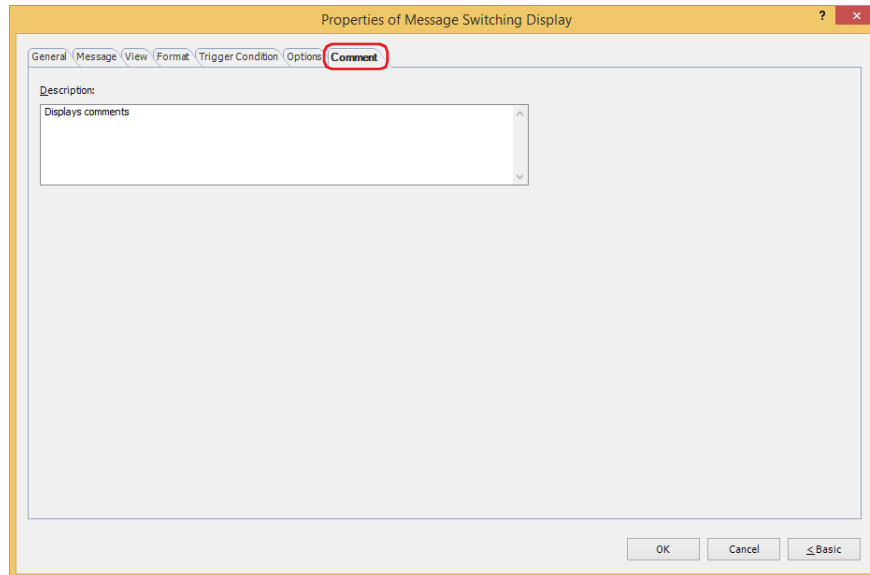

■ Description

Used for entering comments about parts. Maximum number is 80 characters.

Example: When mousing over the Message Switching Display on the editing screen

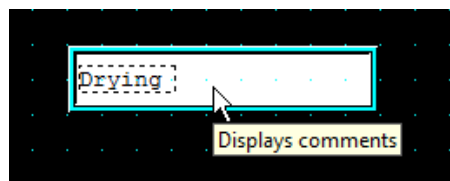

7 Alarm List Display

HG2J-7U HG5G-V HG4G-V HG4G HG3G-V HG3G HG2G-V HG2G-5F HG2G-5T HG1G HG1P

7.1 How the Alarm List Display is Used

The Alarm List Display works with the Alarm Log function to display messages for active alarms and to display multiple messages according to values of device addresses in a list.

- List currently active alarms out of the alarms configured in the Alarm Log settings

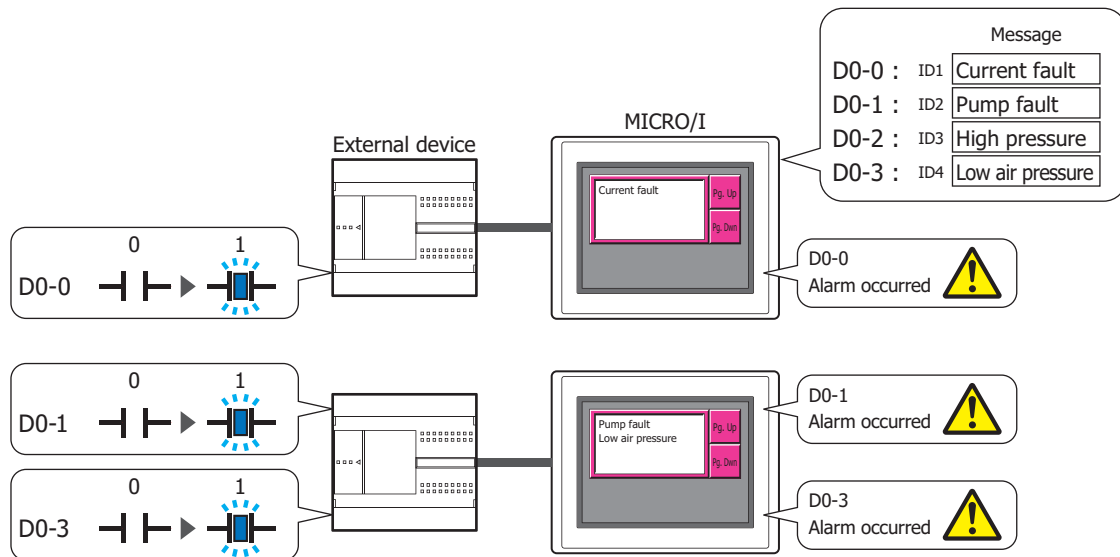

- Display multiple messages according to values of device addresses

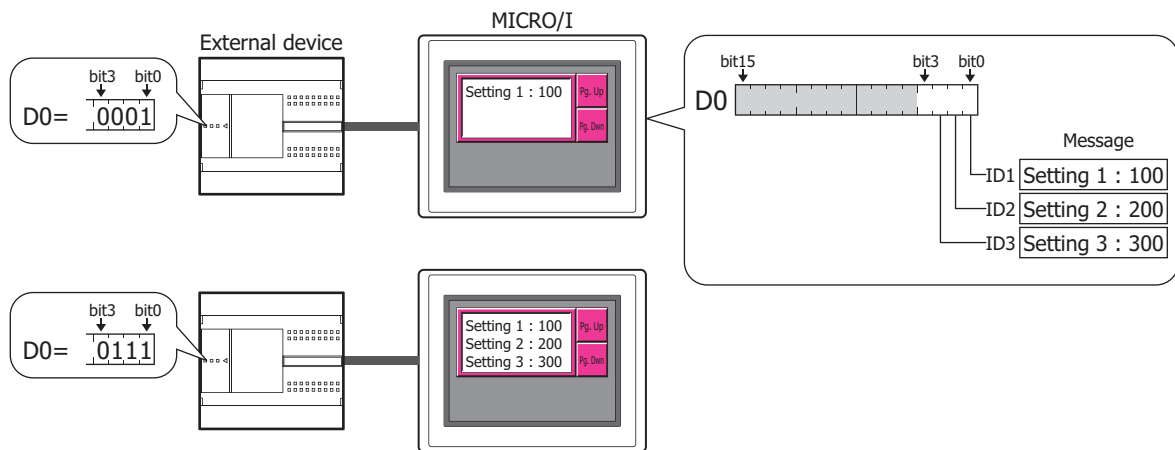

- Only one Alarm List Display or Alarm Log Display can be configured on a single screen.
- When the active alarm is displayed on the Alarm List Display, the message disappears from the list when the alarm is recovered from regardless of the **Lock/Unlock** setting. To display the alarm message until it can be checked, use the Alarm Log Display. **Lock/Unlock** is configured on the **Channel** tab in the **Alarm Log Settings** dialog box.



- For the key buttons used with the Alarm List Display, refer to Chapter 8 "Alarm List Display" on page 8-97.
- The number of the message (channel when using the Alarm function) that has focus on the Alarm List Display is stored in HMI Special Data Register LSD50.
- The information about where on the list the message that has focus is displayed, out of all the messages displayed on the Alarm List Display, is stored in HMI Special Data Register LSD56.

7.2 Alarm List Display Configuration Procedure

This section describes the configuration procedure for Alarm List Displays.

- 1 On the **Home** tab, in the **Parts** group, click **Data Displays**, and then click **Alarm List Display**.

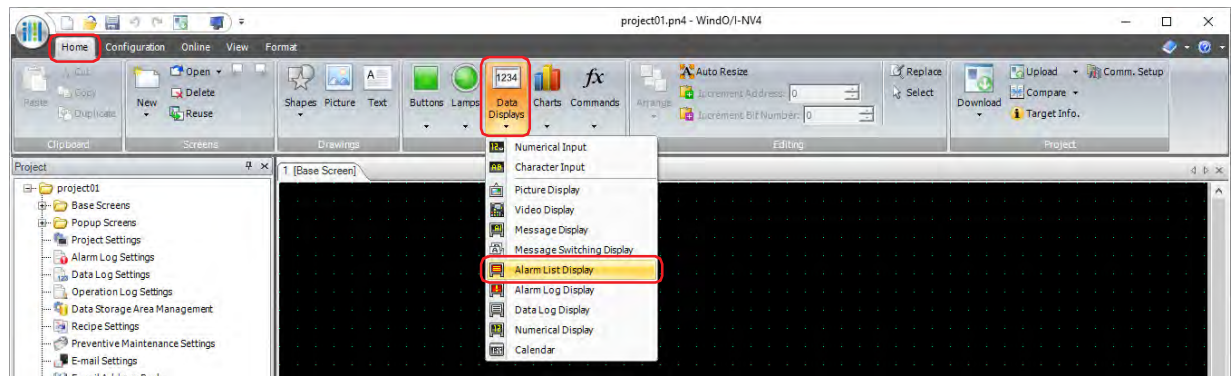

- 2 Click a point on the edit screen where you wish to place the Alarm List Display.
- 3 Double-click the placed Alarm List Display and a Properties dialog box will be displayed.
- 4 Change the settings on each tab as necessary.

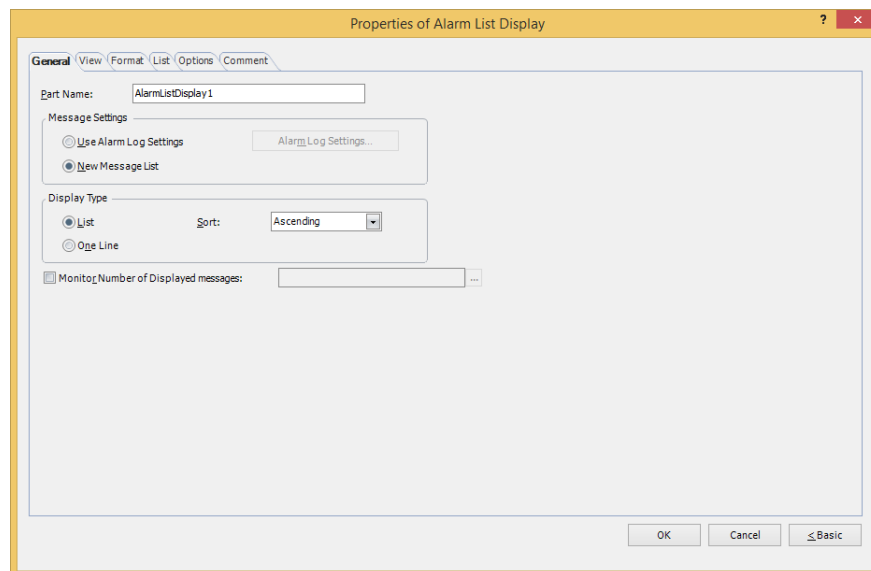

The **Options** tab only appears in Advanced mode.



You can set the default for the Alarm List Display on the **Default Preferences** tab of the **WindO/I-NV4 Options** dialog box. For details, refer to Chapter 2 "Default Preferences Tab" on page 2-63.

7.3 Properties of Alarm List Display Dialog Box

This section describes items and buttons on the properties dialog box.

● General Tab

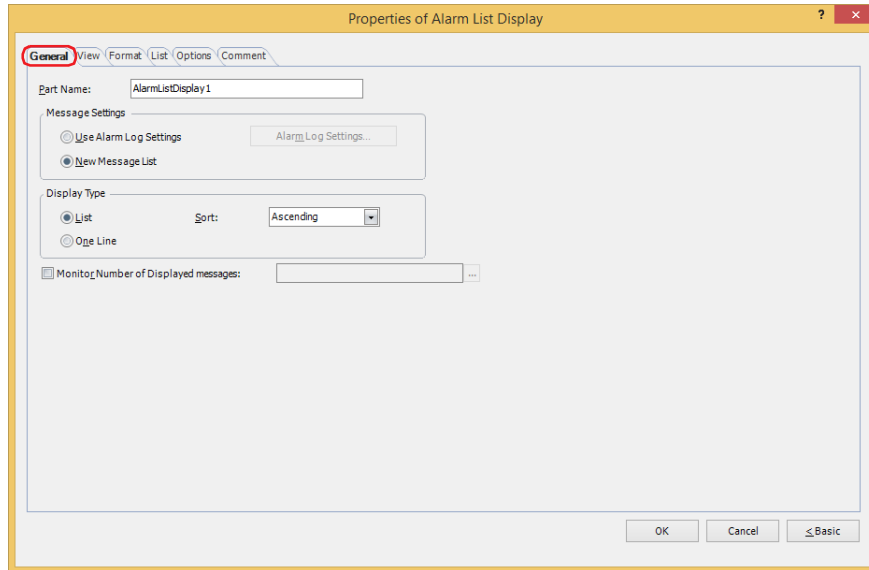

■ Part Name

Enter a name for the part. The maximum number is 20 characters.

■ Message Settings

Selects the method for switching message to display.

Use Alarm Log Settings: Displays messages for the active alarms. The alarms are configured by the Alarm Log settings.

Alarm Log Settings: Displays the **Alarm Log Settings** dialog box.

New Message List: Displays the messages registered in Text Manager according to the state of bits in the trigger device address configured on the **List** tab.

Example: When **Use Alarm Log Settings** is selected, the source device address (device address to monitor) configured by the Alarm Log function is D0, and the following messages are allocated to the channels

Source device address	Message
D0-0 : ID1	Current fault
D0-1 : ID2	Pump fault
D0-2 : ID3	High pressure
D0-3 : ID4	Low air pressure

The active alarm messages are displayed.

Bit state of Source device address	D0-0	D0-1	D0-2	D0-3	Message to display	Action
D0-0	1	0	1	1	0	Display ID1
D0-1	0	1	0	1	0	Display ID2, ID3
D0-2	0	1	1	1	0	Display ID1, ID3, ID4
D0-3	0	0	1	1	0	Display ID1, ID2, ID3, ID4
						No message

If all bits in the device address are 0 or if a bit with no associated message becomes 1, display nothing.

Example: When **New Message List** is selected and the bits of trigger device address D0 are allocated to the following messages.

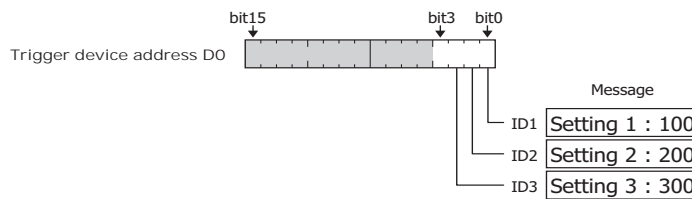

The messages are displayed according to the state of the bits.

Bit state of Trigger device address D0	0001	0110	0101	0111	0000
Message to display	Setting 1 : 100 Pg. Up Pg. Dwn	Setting 2 : 200 Setting 3 : 300 Pg. Up Pg. Dwn	Setting 1 : 100 Setting 3 : 300 Pg. Up Pg. Dwn	Setting 1 : 100 Setting 2 : 200 Setting 3 : 300 Pg. Up Pg. Dwn	
Action	Display ID1	Display ID2, ID3	Display ID1, ID3	Display ID1, ID2, ID3	No message

If all bits in the device address are 0 or if a bit with no associated message becomes 1, display nothing.

■ Display Type

Selects whether or not to simultaneously display multiple messages.

List: Simultaneously displays multiple messages.

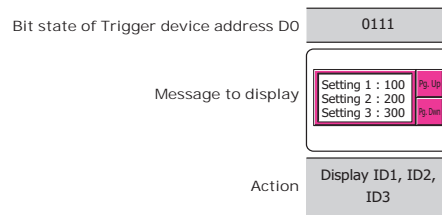

Sort: Selects the display order when displaying multiple messages.

Old and **New** can only be configured when the **Use Alarm Log Settings** check box is selected.

Ascending: Sort from the smallest block number to the largest block number, and then from the smallest channel number or message number to the largest number.

Descending: Sort from the smallest block number to the largest block number, and then from the largest channel number or message number to the smallest number.

Old: Sorts the list in order from oldest to newest.

New: Sorts the list in order from newest to oldest.

One Line: Displays only a single message.
When multiple bits are 1, the message for the lowest order bit is displayed.

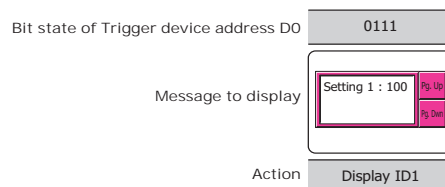

■ Monitor Number of Displayed messages

Select this check box to count the number of displayed messages.

This option can only be configured when the **New Message List** check box is selected.

(Destination Device Address): Specifies the word device to write the number of displayed messages to.

Click to display the Tag Editor. For the device address configuration procedure, refer to Chapter 2 "5.1 Device Address Settings" on page 2-70.

● List Tab

The **List** tab is only displayed when **New Message List** is selected for **Message Settings** on the **General** tab.

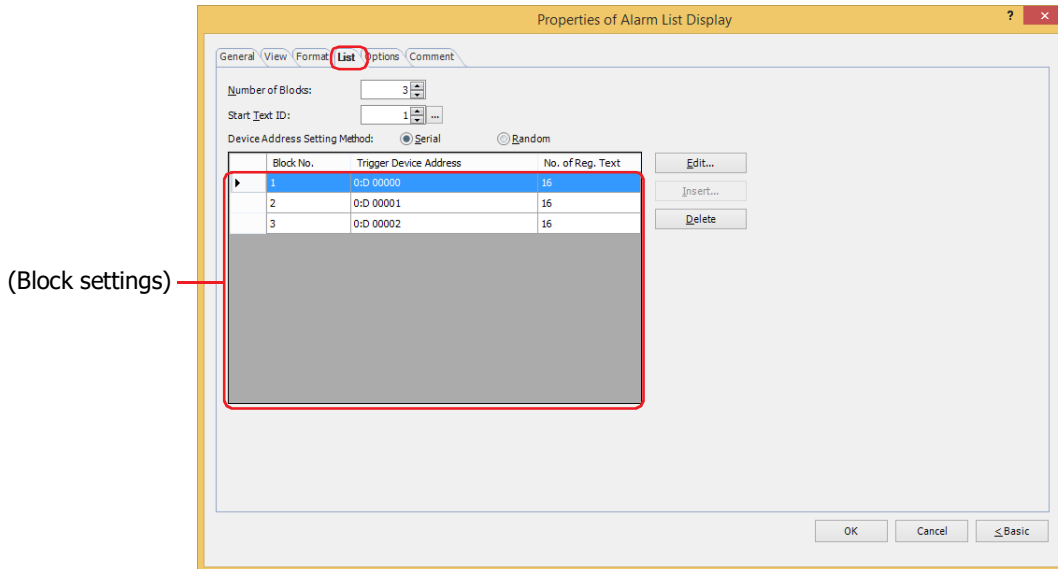

■ Number of Blocks

Configures the device addresses that trigger messages to display and message switching as blocks (1 to 64).



1 block is composed of 16 channels. 1 device address bit can be monitored for each channel. The maximum number of device address bits that can be monitored is 16 for each block.

■ Start Text ID

Specifies the Text Manager ID number (1 to 32000) of the message to display. The text ID numbers are sequentially configured for all channels from the first block starting with the ID number configured here. Click to display Text Manager.

■ Device Address Setting Method

Selects the trigger device address setting method.

Serial: The trigger device addresses after the block number selected in the block settings are configured with sequential addresses.

Random: Configures trigger device addresses for each block number.

■ (Block settings)

Registers and edits the messages to display for each block channel.

Block No.: Shows the block numbers in the amount specified by **Number of Blocks**. Double clicking the cell displays the **Individual Settings** dialog box. For details, refer to "Individual Settings Dialog Box" on page 10-141.

Trigger Device Address: Shows the word device to use as the condition to display messages. Double clicking the cell displays the Tag Editor. For the device address configuration procedure, refer to Chapter 2 "5.1 Device Address Settings" on page 2-70. When **Serial** is selected for **Device Address Setting Method**, the trigger device addresses for block numbers after the selected block number are automatically configured with the configured trigger device address as the starting address.

No. of Reg. Text: Shows the number of messages registered to the block. Double clicking the cell displays the **Individual Settings** dialog box. For details, refer to "Individual Settings Dialog Box" on page 10-141.

Edit: Changes the block settings in list. Select a block number in the list and click this button to display the **Individual Settings** dialog box. For details, refer to "Individual Settings Dialog Box" on page 10-141.

- Insert:** Inserts the block settings in the position selected on the list.
Select the block number at the position to insert the settings in the list and click this button to display the **Individual Settings** dialog box. For details, refer to "Individual Settings Dialog Box" on page 10-141.
The settings at the insertion point shift down one line. Settings cannot be inserted if all block numbers are configured.
- Delete:** Deletes the registered settings from the list.
Select a block number on the list and click this button to delete the selected settings from the list.

Individual Settings Dialog Box

The **Individual Settings** dialog box is used to configure the conditions to display the messages.

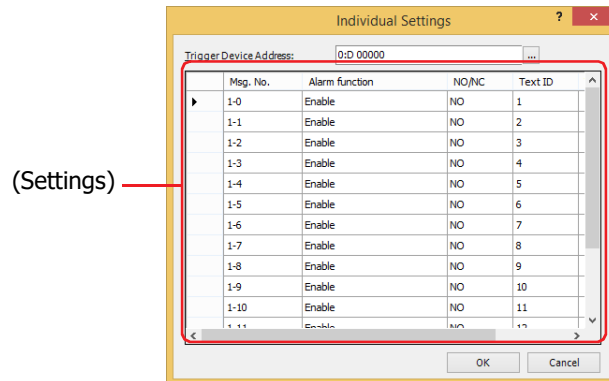

■ Trigger Device Address

Specifies the word device to use as the condition to display messages. The word device bits correspond to the message numbers.

Example: When the number of blocks is 1 and D0 is specified as the trigger device address

The device address of the number(Block Number - Message Number) 1-0 is D0-0, the device address of the number 1-1 is D0-1, ... the device address of the number 1-15 is D0-15.

Number(Block Number - Message Number)	Device Address
1-0	D0-0
1-1	D0-1
1-2	D0-2
⋮	⋮
1-14	D0-14
1-15	D0-15

Block 1
16 channels

Click to display the Tag Editor. For the device address configuration procedure, refer to Chapter 2 "5.1 Device Address Settings" on page 2-70.

When **Serial** is selected for **Device Address Setting Method** on the **List** tab, the trigger device addresses for block numbers after the block number being registered or edited are automatically changed with the configured trigger device address as the starting address.

■ (Settings)

- Msg. No.:** Displayed as (Block No.)-(Message No.).
- Alarm function:** Selects whether or not to use the alarm function. Double clicking the cell switches between **Enable** and **Disable**.
Enable: Monitors the state of the device address bit configured for the channel and displays the message.
Disable: The device address bit is not monitored and the message is not displayed.
- NO/NC:** Selects the alarm detection condition. Double clicking the cell switches between **NO** and **NC**.
NO: Displays the message when the monitored bit changes from 0 to 1.
NC: Displays the message when the monitored bit changes from 1 to 0.
- Text ID:** Shows the Text Manager ID number (1 to 32000) to use for the message.
The text ID is sequentially configured starting with the text ID configured by **Start Text ID** on the **List** tab.
- Text:** Shows the text for the specified text ID.
Only shows the first line of text when the text registered to the text ID has multiple lines.

● **View Tab**

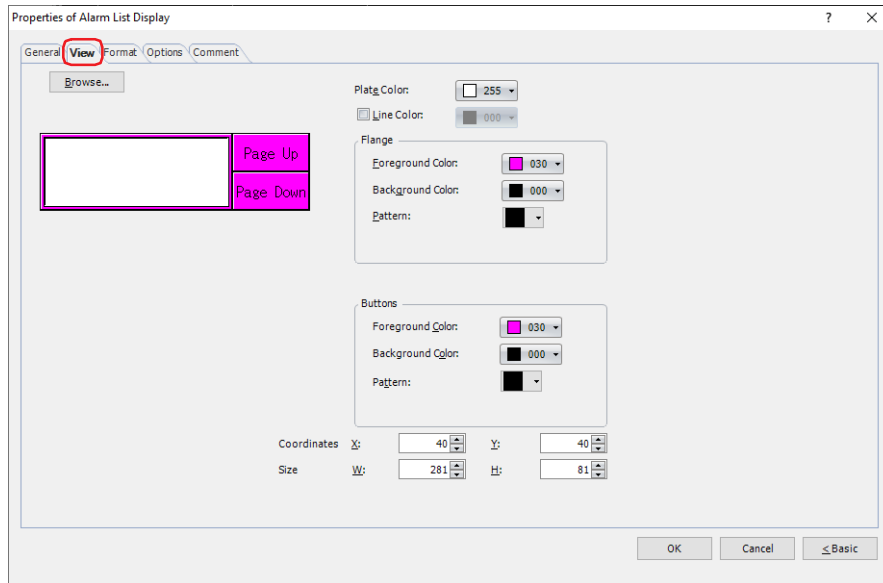

■ **Browse**

Select the type of graphic to be used to represent the part from the list of graphics. Click this button to display the View Browser.

■ **Plate Color**

Selects the plate (color: 256 colors, monochrome: 16 shades).

Click **Color** to display the Color Palette. Select a color from the Color Palette.

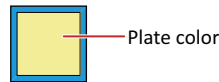

■ **Line Color**

When lines are displayed, select this check box and select line color (color: 256 colors, monochrome: 16 shades).

Click **Color** to display the Color Palette. Select a color from the Color Palette.



■ **Flange**

Foreground Color, Background Color: Selects the foreground and background colors of the flange (color: 256 colors, monochrome: 16 shades).

Click **Color** to display the Color Palette. Select a color from the Color Palette.

Pattern:

Selects a pattern for the flange.

Click **Pattern** to display the Pattern Palette. Select a pattern from the Pattern Palette.

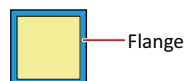

■ Buttons

Foreground Color, Background Color: Selects the foreground and background colors of the buttons (color: 256 colors, monochrome: 16 shades).

Click **Color** to display the Color Palette. Select a color from the Color Palette.

Pattern:

Selects a pattern or tonal gradation for the button.

Click **Pattern** to display the Pattern Palette. Select a pattern or tonal gradation from the Pattern Palette.



Can be set only when there are grouped Key Buttons.

■ Coordinates

X, Y: Sets the display position of parts using coordinates.

The X and Y coordinates of parts is defined relative to an origin at the top-left corner of the screen.

X: 0 to (base screen horizontal size - 1)

Y: 0 to (base screen vertical size - 1)

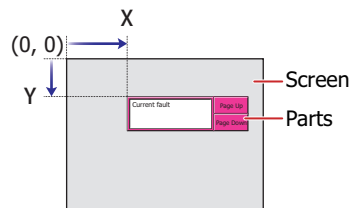

■ Size

W, H: Sets width and height to define the size of parts.

W: 20 to (base screen horizontal size)

H: 20 to (base screen vertical size)

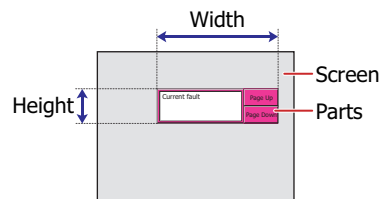

● Format Tab

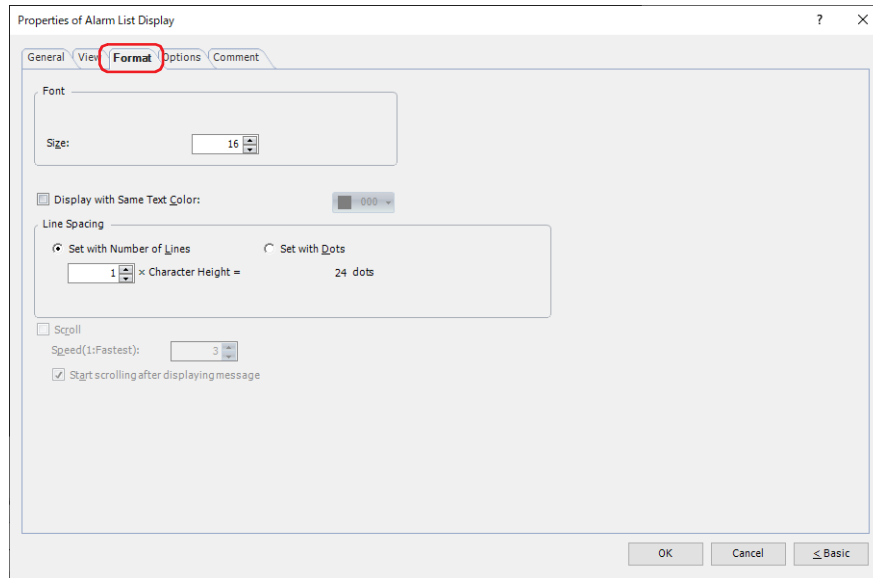

■ Font

Configures the format of the messages to display.

Style*¹: Selects **Regular** or **Bold** for text style.

Size*²: Specifies the character size (8 to 150).

Magnification*¹: W, H: Selects text magnification (0.5, 1 to 8).

■ Display with Same Text Color*³

To set the text color for all messages to the same color, select this check box and select the text color to display (color: 256 colors, monochrome: 16 shades).

Click this button to display the Color Palette. Select a color from the Color Palette.

When this check box is cleared, the color for messages is the text color configured in Text Manager.

*1 HG5G/4G/3G/2G-V, HG4G/3G, HG2G-5F/-5T, HG1G/1P only

*2 HG2J-7U only

*3 Advanced mode only

■ Line Spacing*3

Selects the specification method for line spacing in the list and configures the line spacing.

Set with Number of Lines:

Specifies the number of lines for the message to display for one alarm line.

Enter the number of lines. The range that can be specified varies based on the vertical size of the base screen and the character height. When you enter the number of lines, the line spacing is automatically calculated according to the display area.

Number of lines X Character height = Line spacing (dots)

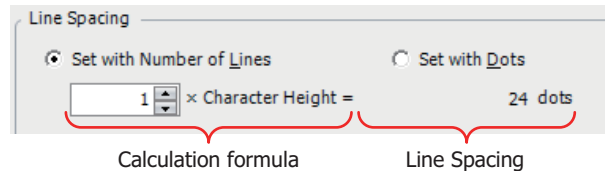

The character height setting varies based on the model.

HG2J-7U: **Size**

Size is 16.

Number of Lines	Character height	Line Spacing	
<input type="text" value="1"/>	<input type="text" value="24"/>	= 24 dots	↓ Current fault ↑ Pump fault
			When the message is 2 lines, 2nd line is not shown.
Number of Lines	Character height	Line Spacing	
<input type="text" value="2"/>	<input type="text" value="24"/>	= 48 dots	↓ Current fault has occurred ↑ Pump fault has occurred
Number of Lines	Character height	Line Spacing	
<input type="text" value="3"/>	<input type="text" value="24"/>	= 72 dots	↓ Current fault has occurred ↑ Pump fault has occurred

HG5G/4G/3G/2G-V, HG4G/3G, HG2G-5F/-5T, HG1G/1P: **Magnification H x 16**

Number of Lines	Magnification H	Line Spacing	
<input type="text" value="1"/>	<input type="text" value="1"/>	= 16 dots	↓ Current fault ↑ Pump fault
			When the message is 2 lines, 2nd line is not shown.
Number of Lines	Magnification H	Line Spacing	
<input type="text" value="2"/>	<input type="text" value="1"/>	= 32 dots	↓ Current fault has occurred ↑ Pump fault has occurred
Number of Lines	Magnification H	Line Spacing	
<input type="text" value="3"/>	<input type="text" value="1"/>	= 48 dots	↓ Current fault has occurred ↑ Pump fault has occurred
Number of Lines	Magnification H	Line Spacing	
<input type="text" value="3"/>	<input type="text" value="2"/>	= 96 dots	↑ Current fault has occurred ↓ Pump fault has occurred



Since the alarm line spacing is adjusted with the number of lines for the message fixed, this option is convenient to use when displaying multi-line messages.

*3 Advanced mode only

Set with Dots: Specifies the line spacing for the message to display for one alarm line in dots.

Enter the height (8 to (base screen vertical size -3)). The range that can be specified varies based on the vertical size of the base screen and the character height.

The character height setting varies based on the model.

HG2J-7U: **Size** is 16.

To display a one-line message, $1 \times 24 = 24$ dots, a line spacing of 24 dots or higher is required.

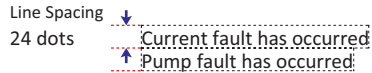

To display a two-line message, $2 \times 24 = 48$ dots, a height of 48 dots or higher is required.

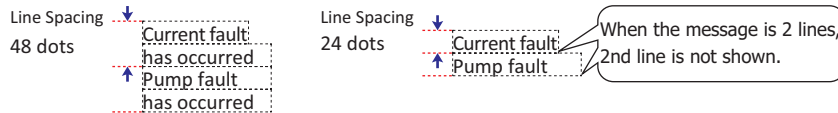

HG5G/4G/3G/2G-V, HG4G/3G, HG2G-5F/-5T, HG1G/1P: **Magnification H** is 1.

To display a one-line message, $1 \times 16 \times 1 = 16$ dots, a line spacing of 16 dots or higher is required.

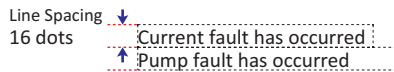

To display a two-line message, $1 \times 16 \times 2 = 32$ dots, a line spacing of 32 dots or higher is required.

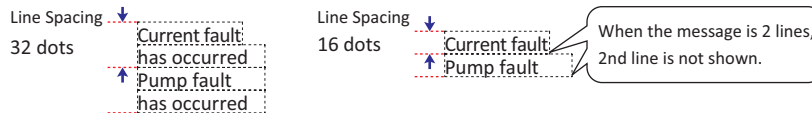

HG5G/4G/3G/2G-V, HG4G/3G, HG2G-5F/-5T, HG1G/1P: **Magnification H** is 2.

To display a one-line message, $2 \times 16 \times 1 = 32$ dots, a line spacing of 32 dots or higher is required.



To display a two-line message, $2 \times 16 \times 2 = 64$ dots, a line spacing of 64 dots or higher is required.

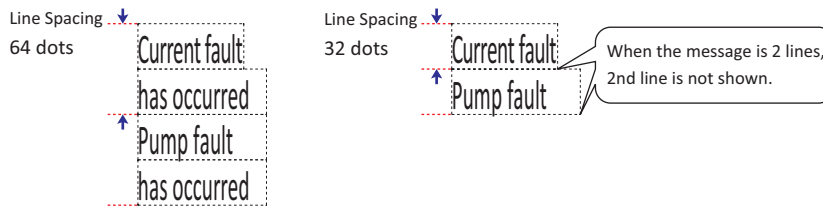

■ Scroll*3

Select this check box to enable scrolling display displaying of messages.

Can only be set when **One Line** is selected for **Display Type** under the **General** tab.

For Alarm List Display, this can only be set if **One Line** is selected for **Display Type** under the **General** tab.

Speed (1: Fastest):

Sets the scrolling speed (1 to 10). 1 is fastest, 10 is slowest.

Start scrolling after displaying message:

Select this check box to start scrolling after a message is displayed for 2 seconds.

This check box is cleared.

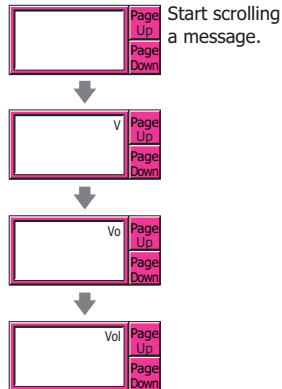

This check box is selected.

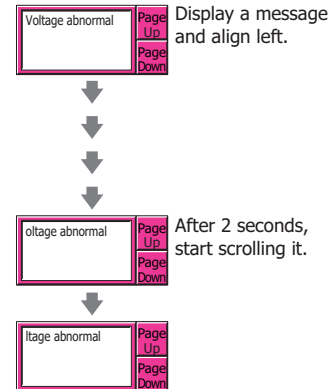

- When the **Scroll** check box is selected, the number of parts that can be arranged on a single screen decreases. If the MICRO/I displays an error message, clear the **Scroll** check box, or reduce the number of parts on the screen.
- When the scan time for the screen becomes longer, and when the part that has its **Scroll** check box selected is placed on the top layer, the scrolling speed may become slow.



When the **Scroll** check box is selected operation is follows.

- Messages that include CRs are displayed without the CRs.
- Messages scroll in the direction in which the text is drawn.
- When the text displayed according to values of device addresses, the text color, the displayed text, or the alarm state changes, the message is scrolled from the beginning.

*3 Advanced mode only

● Options Tab

The **Options** tab is displayed in Advanced mode.

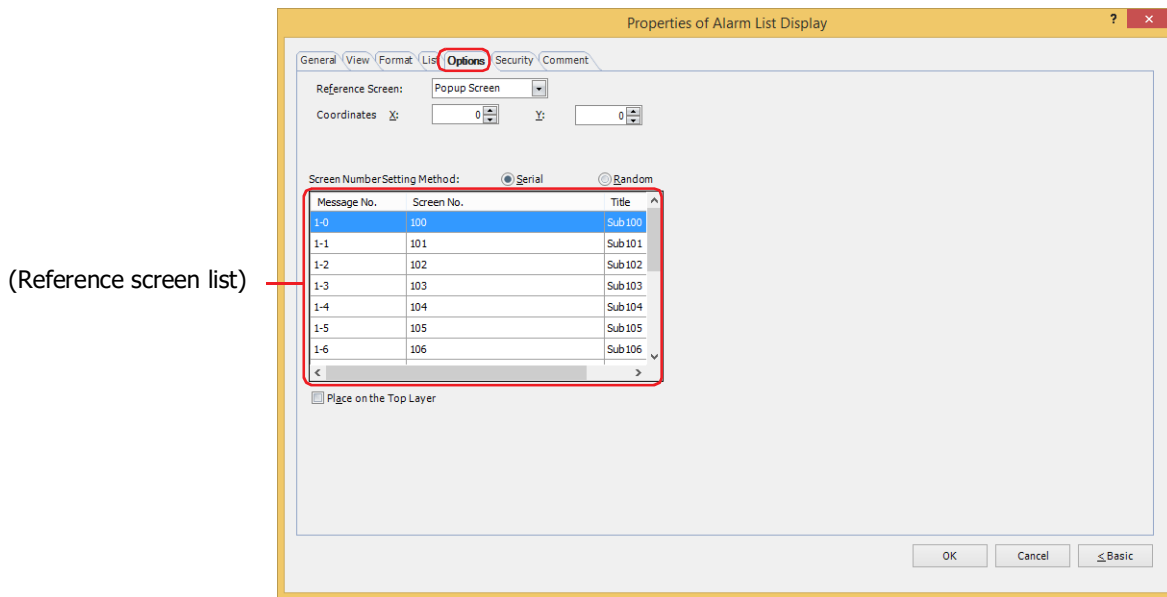

■ Reference Screen

The **Options** tab is used to configure the reference screen. The reference screen is a base screen or popup screen associated with each individual message. The reference screen is displayed when the key button **Ref.** is pressed.

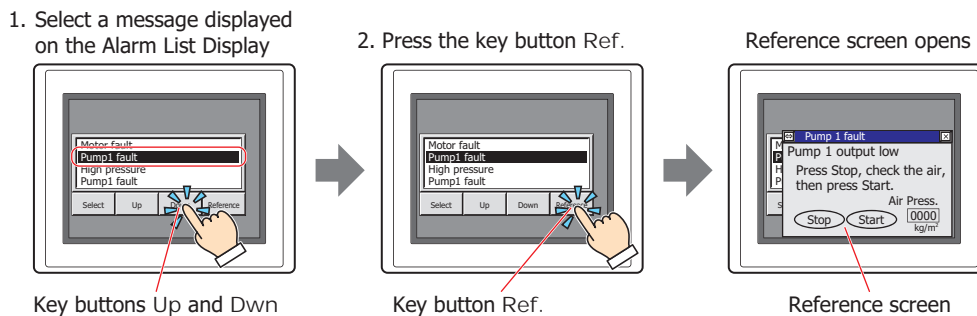

When displaying a reference screen, select either **Base Screen** or **Popup Screen** as the reference screen type. When not displaying a reference, select **Not Use**.

This can only be set when **New Message List** has been selected in **Message Settings** on the **General** tab. When **Use Alarm Log Settings** has been selected, the screen type will become the one selected in **Reference Screen** on the **Channel** tab in the **Alarm Log Settings** dialog box.

■ Coordinates

X, Y: Specifies the coordinates to display the reference screen.

With the upper-left corner of the screen as the origin, the X and Y coordinates are the upper-left corner of the reference screen.

This option can only be configured when **Base Screen** or **Popup Screen** is selected for **Reference Screen**.

Specify the coordinates in 1 dot units.

X: 0 to (base screen horizontal size - 1)

Y: 0 to (base screen vertical size - 1)

■ Screen Number Setting Method

Selects the setting method for the screen numbers on the reference screen list.

Serial: Continuously and automatically specifies screen numbers (1 to 3000) that are at or below the selected message number.

Example 1: When screen number "100" has been entered for message number 1-0.

Message No.	Screen No.
1-0	
1-1	
1-2	
1-3	
1-4	
1-5	
1-6	



Message No.	Screen No.
1-0	100
1-1	101
1-2	102
1-3	103
1-4	104
1-5	105
1-6	106

Screen numbers "100", "101", "102"....are automatically specified in order from message number 1-0.

Example 2: When screen number "200" has been entered for message number 1-5.

Message No.	Screen No.
1-0	100
1-1	101
1-2	102
1-3	103
1-4	104
1-5	105
1-6	106



Message No.	Screen No.
1-0	100
1-1	101
1-2	102
1-3	103
1-4	104
1-5	200
1-6	201

Message numbers 1-0 to 1-4 are left unchanged and screen numbers "200", "201", "202"....are automatically specified in order from message number 1-5.

Random: Specifies a reference screen number (1 to 3000) for each message number.

■ (Reference Screen List)

Displays a list reference screen numbers and screen titles that have been set to messages.

Message No.: Displays the message number.

Screen No.: Displays the reference screen number.

Double clicking the cell allows you to change the screen number (1 to 3000).



When there is not screen for the specified screen number a message confirming the creation of a new screen will appear.

If **Yes** is clicked, a screen will be created but if **No** is clicked, you will be returned to the **Options** screen without creating a screen.

Title: Displays the title of a reference screen.

Double clicking the cell allows you to edit the title. The maximum number is 40 characters.

■ Place on the Top Layer

Select this check box to display the parts on the top layer. The parts will have precedence when other drawings and parts are overlapping with it. For details, refer to Chapter 6 "4 Drawings and Parts Overlapping" on page 6-5.

● Security Tab

This tab is used to restrict displaying and using the part by security groups.

This option can only be set when **Use Security functions** is selected. The **Use Security functions** check box is set on **General** tab in the **Security** dialog box.

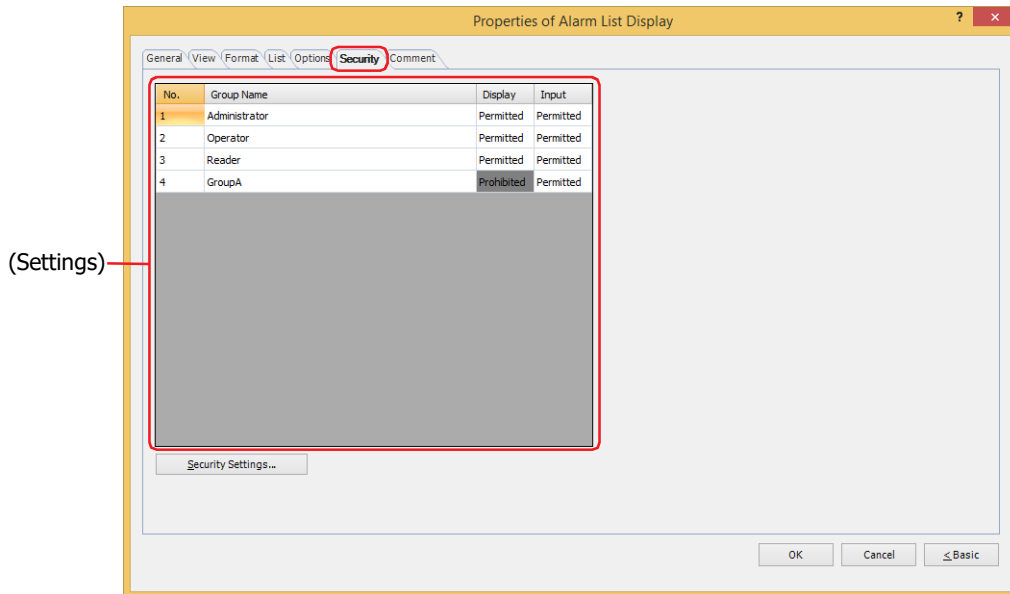

■ (Settings)

Displays the list of security groups used on the MICRO/I.

No.: Displays the security group numbers (1 to 15).

Group Name: Displays the name of the security group.

Display: Displays whether or not there is permission to display the part. Only **Permitted** security groups can display this part. If all security groups are set to **Permitted**, this part will be displayed even if no user account has been selected. Double clicking the cell switches between **Permitted** and **Prohibited**.

Input: Displays whether or not there is permission to use the part. Only **Permitted** security groups can use this part. If all security groups are set to **Permitted**, this part can be used even if no user account has been selected. Double clicking the cell switches between **Permitted** and **Prohibited**.



- You can also switch between **Permitted** and **Prohibited** by right-clicking on a **Display** or **Input** cell.
- Restricting the display and use of the part by switching between **Permitted** and **Prohibited** in **Display** and **Input** cells is similar to using the **Trigger Condition** tab.



■ Security Settings

The Security Settings dialog box is displayed. If you create a security group in the **Security Settings** dialog box, you can select that created group. For details, refer to Chapter 23 "2.2 Adding and Editing Security Groups" on page 23-19.



For details about security functions, refer to Chapter 23 "User Accounts and the Security Function" on page 23-1.

Example: If the user and security group for a part are set as follows:

User Name	 User1	 User2	 User3
Security Group	Reader	Operator	Administrator

MICRO/I

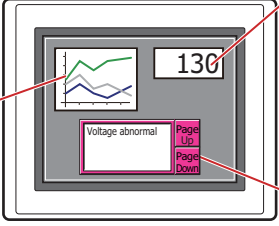

Line Chart

No.	Group Name	Display
1	Administrator	Permitted
2	Operator	Permitted
3	Reader	Prohibited

Numerical Display

No.	Group Name	Display
1	Administrator	Permitted
2	Operator	Permitted
3	Reader	Permitted

Alarm List Display

No.	Group Name	Display	Input
1	Administrator	Permitted	Permitted
2	Operator	Permitted	Prohibited
3	Reader	Prohibited	Prohibited

For User1 in the **Reader** security group, the parts for which **Display** has been set to **Prohibited** for **Reader** will not be displayed.

If the password screen is opened and the user switches to User2 in the **Operator** security group, the parts for which **Display** has been set to **Permitted** for **Operator** will be displayed.

MICRO/I

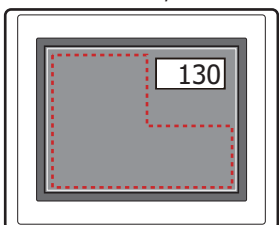

For User1, parts for which Display has been set to Prohibited for Reader are not displayed

MICRO/I

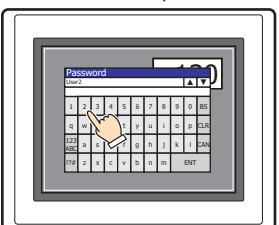

Open Password Screen, enter password, and switch to User2

MICRO/I

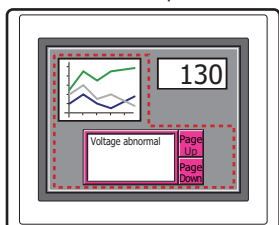

For User2, parts for which Display has been set to Permitted for Operator are displayed

For User2 in **Operator**, **Display** has been set to **Permitted** for **Operator**, but **Input** is **Prohibited**, so the Alarm List Display cannot be used.

If the password screen is opened and the user switches to User3 in the **Administrator** security group, the parts for which **Display** has been set to **Permitted** for **Administrator** will be displayed, and the parts for which **Input** has been set to **Permitted** for **Administrator** can be used.

MICRO/I

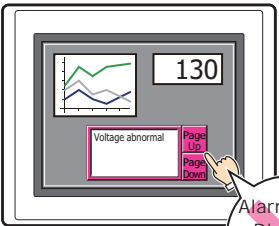

For User2, parts for which Display has been set to Permitted for Operator are displayed, but parts for which Input has been set to Prohibited cannot be used

MICRO/I

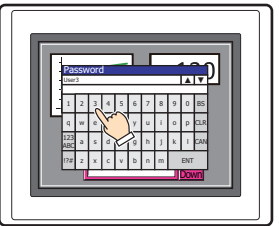

Open Password Screen, enter password, and switch to User3

MICRO/I

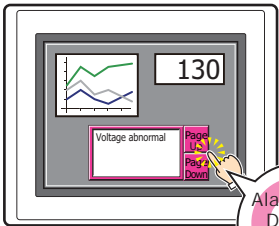

For User3, parts for which Display has been set to Permitted for Administrator are displayed, and parts for which Input has been set to Permitted can be used

● Comment Tab

The **Comment** tab is used to specify the parts placed on the editing screen, and the popup text displayed when the mouse pointer is placed close to **No.**, **Name**, or **Type** in the object list.



When there are multiple parts of the same shape on the screen, this feature makes it possible to distinguish between the parts without displaying the Properties dialog box for each part, by just mousing over the part.

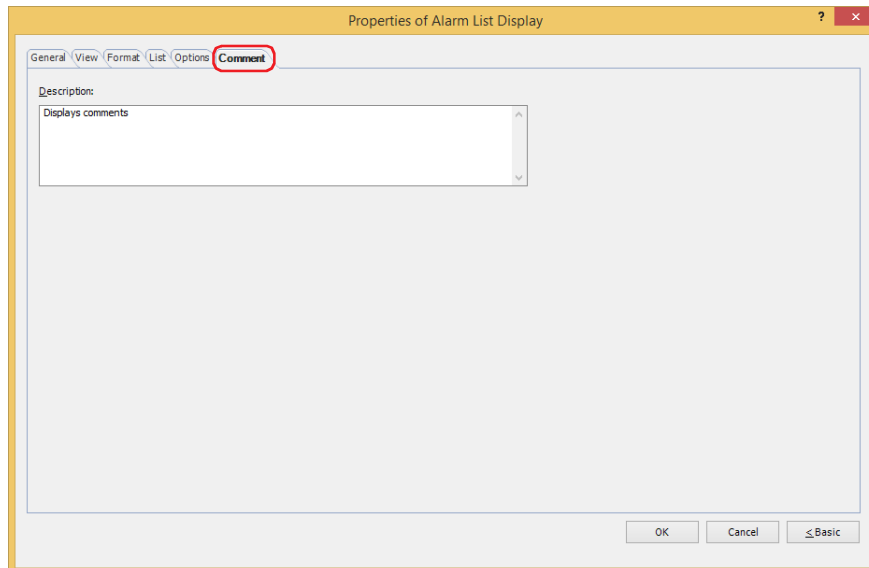

■ Description

Used for entering comments about parts. Maximum number is 80 characters.

Example: When mousing over the Alarm List Display on the editing screen

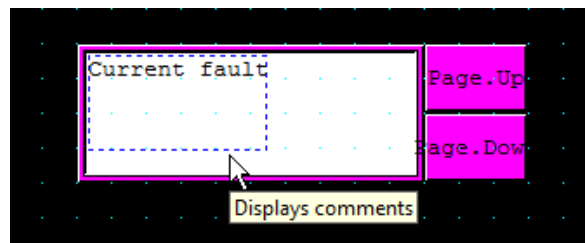

8 Alarm Log Display

HG2J-7U HG5G-V HG4G-V HG4G HG3G-V HG3G HG2G-V HG2G-5F HG2G-5T HG1G HG1P

8.1 How the Alarm Log Display is Used

The Alarm Log Display displays Alarm Log data saved in the data storage area.

- List the message, the occurrence time, recovery time, and confirmation time for the alarms that have occurred

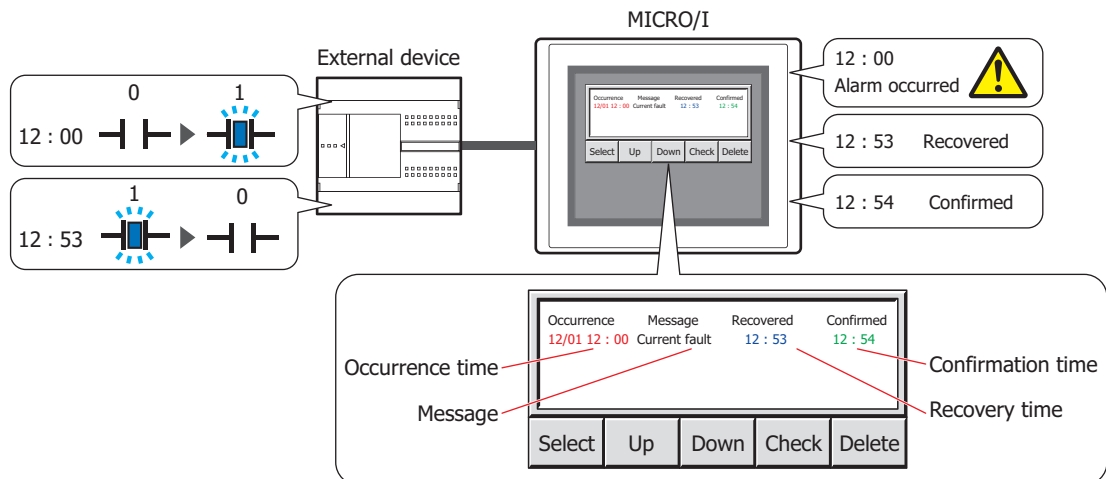

- Display the reference screen for alarms that have occurred

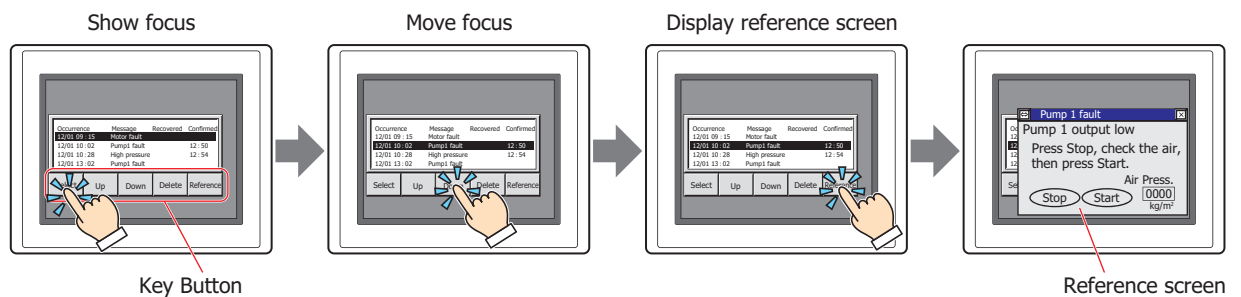

Only one Alarm List Display or Alarm Log Display can be displayed in a screen.



- For the key buttons used with the Alarm Log Display, refer to Chapter 8 "Alarm Log Display" on page 8-97.
- When the **Operate the Alarm on List directly** check box on the **General** tab in the Properties of Alarm Log Display dialog box is selected, a displayed alarm can be given focus by pressing it on the list.
- The number of lines from the start line to the selected line of the message displayed on the Alarm Log Display is stored in HMI Special Data Register LSD56.

8.2 Alarm Log Display Configuration Procedure

This section describes the configuration procedure for Alarm Log Displays.

- 1 On the **Home** tab, in the **Parts** group, click **Data Displays**, and then click **Alarm Log Display**.

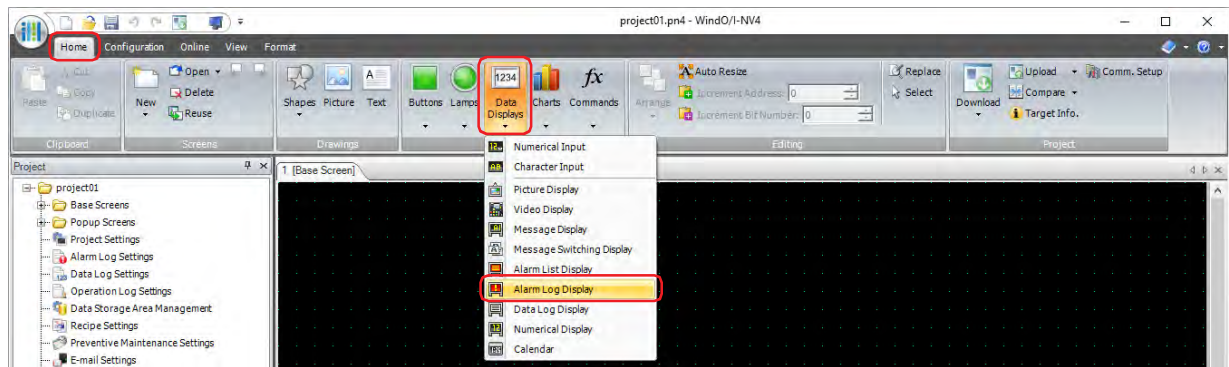

- 2 Click a point on the edit screen where you wish to place the Alarm Log Display.
- 3 Double-click the placed Alarm Log Display and a Properties dialog box will be displayed.
- 4 Change the settings on each tab as necessary.

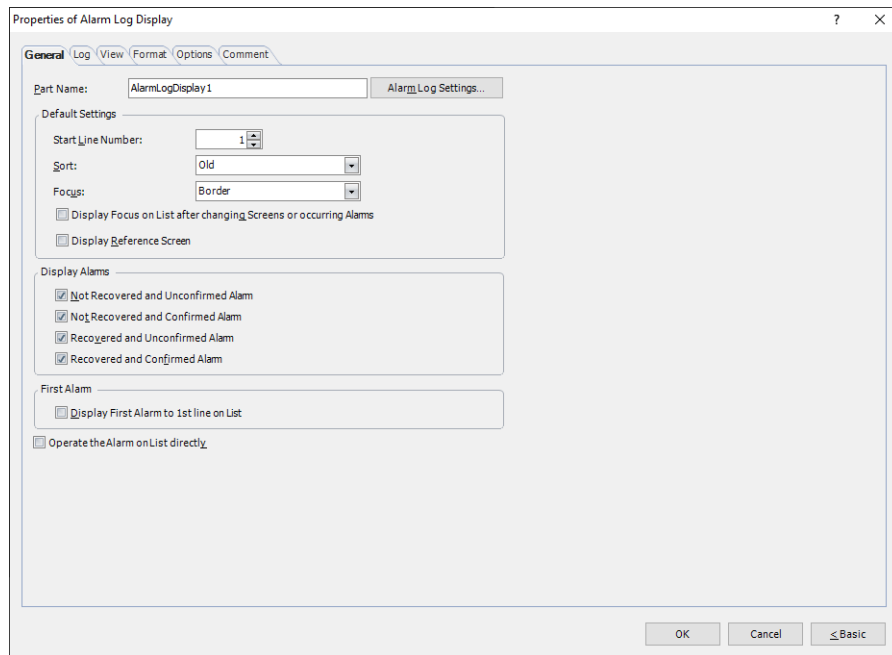

The **Options** tab only appears in Advanced mode.



You can set the default for the Alarm Log Display on the **Default Preferences** tab of the **WindO/I-NV4 Options** dialog box. For details, refer to Chapter 2 "Default Preferences Tab" on page 2-63.

8.3 Properties of Alarm Log Display Dialog Box

This section describes items and buttons on the properties dialog box.

● General Tab

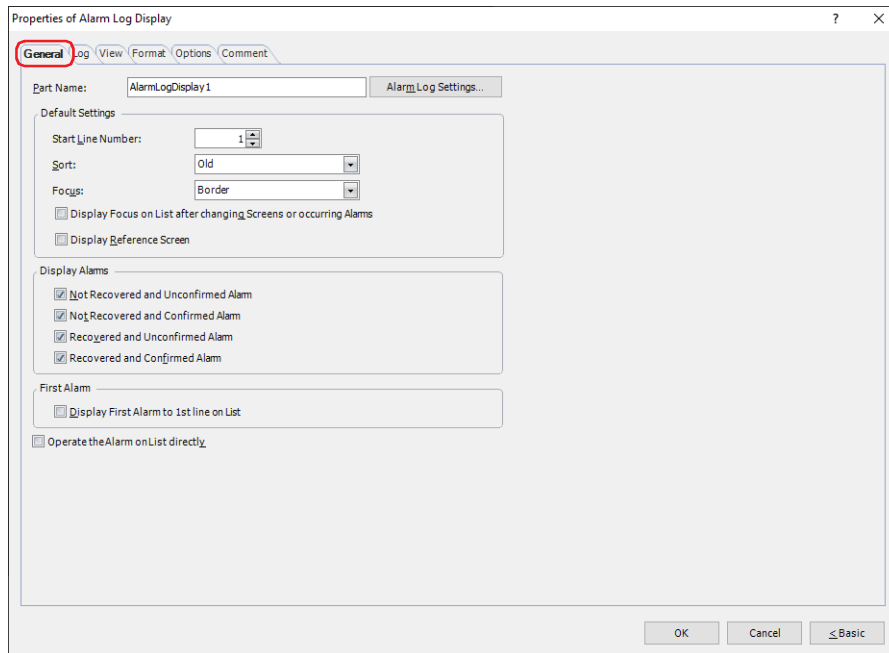

■ Part Name

Enter a name for the part. The maximum number is 20 characters.

■ Alarm Log Settings

Displays the **Alarm Log Settings** dialog box.

■ Default Settings

These options configure the default settings when the Alarm Log Display is displayed.

Start Line Number: Specifies what number alarm to display when multiple alarms have occurred.

The range that can be specified varies based on the model type.

HG2J-7U, HG2G-5T, HG1G/1P: 1 to 5520

HG5G/4G/3G/2G-V, HG4G/3G, HG2G-5F: 1 to 11660

Sort: Selects the display order for alarms that have occurred from the following.

Old, New, New & Level

Focus: Selects a style of the focus from the following.

Reverse Performs the negative/positive conversion to the entire row that has the focus.

Occurrence	Message	Recovered	Confirmed
12/01 12 : 00	Current fault		
12/01 12 : 00	Current fault	12 : 50	
12/01 12 : 00	Current fault		12 : 54

➔

Occurrence	Message	Recovered	Confirmed
12/01 12 : 00	Current fault		
12/01 12 : 00	Current fault	12 : 50	
12/01 12 : 00	Current fault		12 : 54

Border Displays a frame (performs the negative/positive conversion to the inside 2 dots only) on the row with focus.

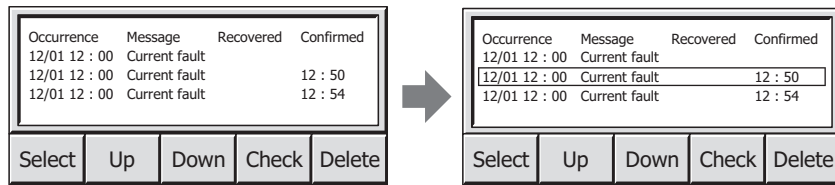

With negative/positive conversion, the color data (RGB value) is inverted and displayed.

Example: When the white color data 0xFFFFFF is inverted, it becomes 0x000000 and is displayed in black. For details on the color data, refer to Appendix "Windows RGB Value Correspondence Table" on page A-2.

Example: Inverts **Text Color** and **Background Color** when a color is set to **Background Color**.
 When the Background Color is Blue(0x0000FF) and the Text Color is Red(0xFF0000), inverts the Background Color to Yellow(0xFFFF00) and the Text Color to Cyan(0x00FFFF).

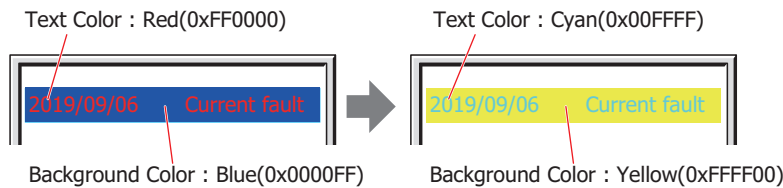

When **Background Color** is **None**, **Text Color** and **Plate Color** is inverted.

Display Focus on List after changing Screens or occurring Alarms*1:

Select this check box to automatically display the focus at the first item in the list after switching screens and when an alarm occurs.

Display Reference Screen*1:

Select this check box to automatically display the reference screen for the alarm that has focus by the following events.

- The focus is displayed
- The focus moves
- A new alarm occurs

■ **Displaying Alarms*1**

Select these check boxes for alarms to display on the Alarm Log Display.

- Not Recovered and Unconfirmed Alarm: Displays active alarms that have not been recovered and confirmed.
- Not Recovered and Confirmed Alarm: Displays alarms that have not been recovered but the key button **CHECK** has been pressed.
- Recovered and Unconfirmed Alarm: Displays alarms that have been recovered but the key button **CHECK** has not been pressed.
- Recovered and Confirmed Alarm: Displays alarms that have been recovered and the key button **CHECK** has been pressed.

■ **First Alarm*1**

An alarm that occurs in a state where no alarms have occurred is called the first alarm. Select the check boxes for the operations to execute when the first alarm occurs.

Display First Alarm to 1st line on List: Always displays the first alarm on the first line of the list.

■ **Operate the Alarm on List directly*1**

Select this check box to display the focus by pressing an alarm displayed on the list.

When an alarm is pressed with no focus displayed, the focus is displayed on that alarm.

When an alarm is pressed that does not have focus when the focus is displayed, the focus is moved to that alarm. The focus is no longer displayed when an alarm with focus is pressed.

*1 Advanced mode only

● Log Tab

(Show items detailed settings)

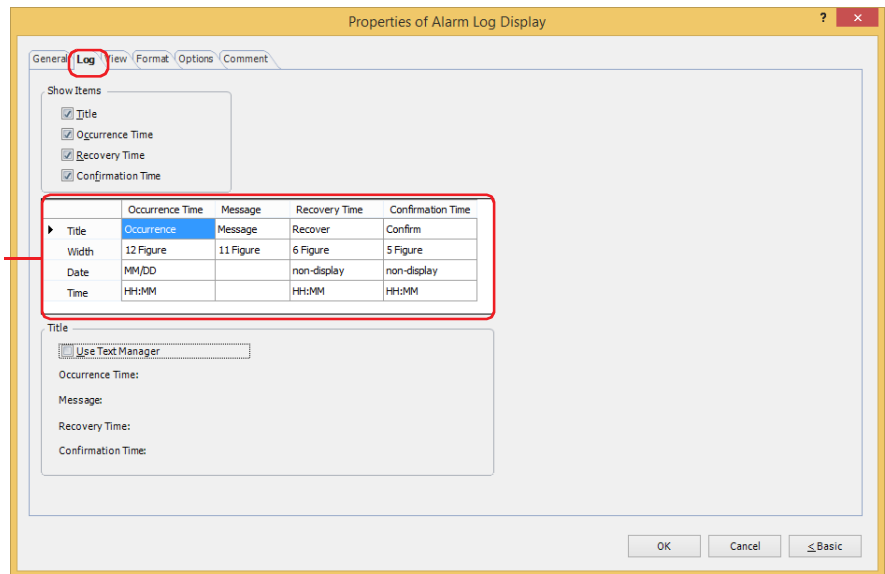

■ Show Items

Select these check boxes for the items to display on the Alarm Log Display.

- Title: Shows the titles on the first line of the list.
- Occurrence Time: Shows the time the alarm occurred.
- Recovery Time: Shows the time the alarm was recovered from.
- Confirmation Time: Shows the time the alarm was confirmed by pressing the key button **CHECK**.

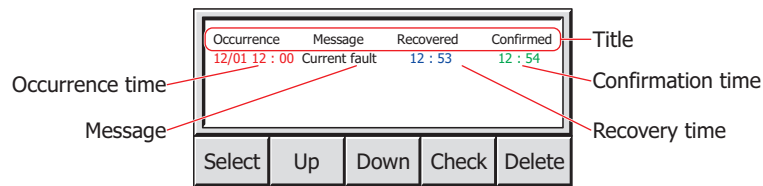

You can drag and drop the sub headings to change the order of items to be displayed on the Alarm Log Display. This function is not applied to the order of the Alarm Log output data by batch or real time output function.

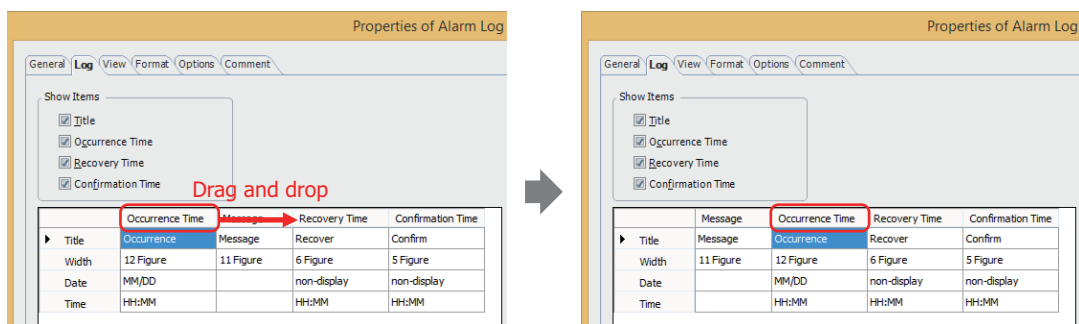

■ (Show items detailed settings)

Each of the show items selected by the check boxes under **Show Items** can be configured in detail here.

- Title:** Double click the cell, and then enter the titles for the items to display. The maximum number is 100 characters.
- Width:** Specifies the number of characters to display (0 to 40). 1 is the width of a single-byte character, 2 is the width of a double-byte character.
- Date:** Selects the display type of the date from the following.
YY/MM/DD, MM/DD/YY, DD/MM/YY, MM/DD, DD/MM, non-display
- Time:** Selects the display type of the time from the following.
HH:MM, HH:MM:SS, non-display



- If the characters displayed in the title contain a newline, the text after the newline will not be displayed. However, if using a Windows font for the selected text ID, the text after the newline will still be displayed.
- If the title contains a language not supported as standard by the computer operating system, the characters may be garbled when displaying the **(Show items detailed settings)**. However, the downloaded data is correctly displayed.



- If you change the display format for **Date** or **Time**, the number for **Width** is automatically adjusted.
- The text color for **Message** changes according to the alarm state. The text color for **Message** is configured by **Occurred Color**, **Recovered Color**, and **Confirmed Color** on the **Format** tab.

■ Title

Select this check box to use text registered in Text Manager for **Title** in the **(Show items detailed settings)**. The **Text ID** message configured for **Occurrence Time**, **Message**, **Recovery Time**, and **Confirmation Time** is displayed in **(Show Items detailed settings)**.

- Text ID:** Specifies the Text Manager ID number (1 to 32000) when using text registered in Text Manager. Click to display Text Manager. This option can only be configured when the **Use Text Manager** check box is selected.

● View Tab

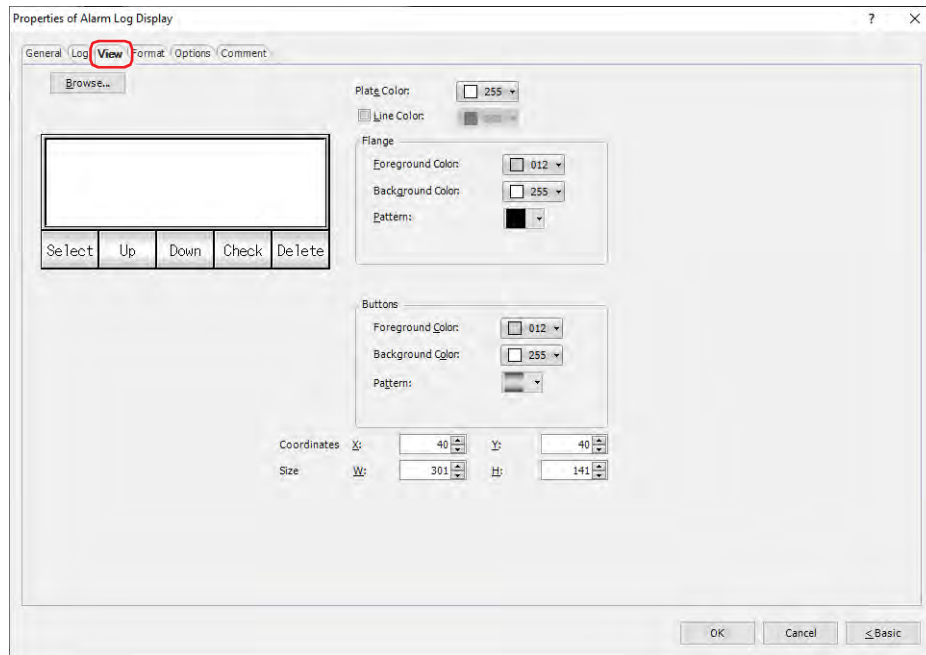

■ Browse

Select the type of graphic to be used to represent the part from the list of graphics. Click this button to display the View Browser.

■ Plate Color

Selects the plate (color: 256 colors, monochrome: 16 shades).

Click **Color** to display the Color Palette. Select a color from the Color Palette.

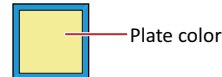

■ Line Color

When lines are displayed, select this check box and select line color (color: 256 colors, monochrome: 16 shades).

Click **Color** to display the Color Palette. Select a color from the Color Palette.

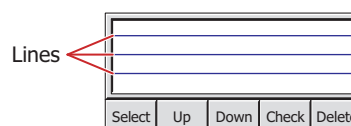

■ Flange

Foreground Color, Background Color:

Selects the foreground and background colors of the flange (color: 256 colors, monochrome: 16 shades).

Click **Color** to display the Color Palette. Select a color from the Color Palette.

Pattern:

Selects a pattern for the flange.

Click **Pattern** to display the Pattern Palette. Select a pattern from the Pattern Palette.

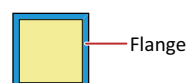

■ **Buttons**

Foreground Color, Background Color: Selects the foreground and background colors of the buttons (color: 256 colors, monochrome: 16 shades).

Click **Color** to display the Color Palette. Select a color from the Color Palette.

Pattern:

Selects a pattern or tonal gradation for the button.

Click **Pattern** to display the Pattern Palette. Select a pattern or tonal gradation from the Pattern Palette.

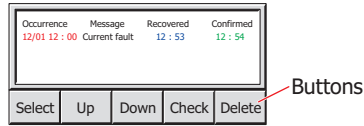

Can be set only when there are grouped Key Buttons.

■ **Coordinates**

X, Y: Sets the display position of parts using coordinates.

The X and Y coordinates of parts is defined relative to an origin at the top-left corner of the screen.

X: 0 to (base screen horizontal size - 1)

Y: 0 to (base screen vertical size - 1)

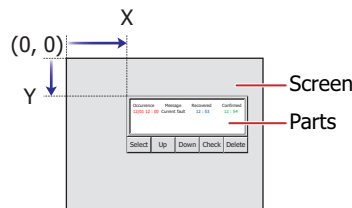

■ **Size**

W, H: Sets width and height to define the size of parts.

W: 20 to (base screen horizontal size)

H: 20 to (base screen vertical size)

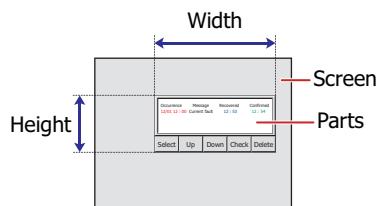

● Format Tab

(Color setting list
by level and status)

Level	Show	Occurred			Recovered			Confirmed		
		Text Color	Background Color	Flash	Text Color	Background Color	Flash	Text Color	Background Color	Flash
1	<input checked="" type="checkbox"/>	000	255	No	000	255	No	000	255	No
2	<input checked="" type="checkbox"/>	000	255	No	000	255	No	000	255	No
3	<input checked="" type="checkbox"/>	000	255	No	000	255	No	000	255	No
4	<input checked="" type="checkbox"/>	000	255	No	000	255	No	000	255	No
5	<input checked="" type="checkbox"/>	000	255	No	000	255	No	000	255	No
6	<input checked="" type="checkbox"/>	000	144	No	000	144	No	000	144	No
7	<input checked="" type="checkbox"/>	000	219	No	000	219	No	000	219	No
8	<input checked="" type="checkbox"/>	000	231	No	000	231	No	000	231	No

■ Title Font

Select the font that will be used for the title from the following options.

Western, Japanese, Simplified Chinese, Traditional Chinese, Hangul, Central European, Baltic, Cyrillic

The characters that can be displayed depend on the font. For details, refer to Chapter 2 "1.2 Available Text" on page 2-6.

■ Style*¹

Selects **Regular** or **Bold** for text style.

■ Size*²

Specifies the character size (8 to 512).

■ Magnification*¹

W, H: Selects text magnification (0.5, 1 to 8).

■ Title Color

Select the color (color: 256 colors, monochrome: 16 shades) of the text for titles.

Click this button to display the Color Palette. Select a color from the Color Palette.

*1 HG5G/4G/3G/2G-V, HG4G/3G, HG2G-5F/-5T, HG1G/1P only

*2 HG2J-7U only

■ (Color setting list by level and status)

Configures the text color, the background color and whether or not to flash according to the alarm level and status.

Level:	Displays the level of alarms.
Show:	Select the check boxes for the Level displayed on the Alarm Log Display.
Occurred, Recovered, Confirmed:	Edit the settings for text color, background color, and flashing according to the status of alarm occurrence, recovery, and confirmation.
Text Color:	Selects the text color of alarms (color: 256 colors, monochrome: 16 shades). Click Color to display the Color Palette. Select a color from the Color Palette.
Background Color:	Selects the background color of alarms (color: 256 colors, monochrome: 16 shades). Click Color to display the Color Palette. Select a color from the Color Palette.
Flash:	Selects whether or not to flash alarms. Double clicking the cell toggles between Y as Yes and N as No. Flash intervals are set in the Flashing Cycle on the System tab in the Project Settings dialog box.



When the Key Button CHECK is pressed before recovering a triggered alarm, the alarm display will change from the Occurred Color to the Confirmed Color. After this, the alarm that has changed to the Confirmed Color will remain in that color and will not change to the Recovered Color even when recovered.

■ Edit

Changes the settings for the selected level.

Select the line and click this button to display the Edit dialog box.

For details, refer to "Edit Dialog Box" on page 10-165.

■ Change Display Colors of First Alarm

Select this check box to change the color of the First Alarm.

Text Color:	Selects the text color of First Alarm (color: 256 colors, monochrome: 16 shades). Click Color to display the Color Palette. Select a color from the Color Palette.
Background Color:	Selects the background color of First Alarm (color: 256 colors, monochrome: 16 shades). Click Color to display the Color Palette. Select a color from the Color Palette.
Flash:	Selects whether or not to flash First Alarm. Double clicking the cell toggles between Y as Yes and N as No. Flash intervals are set in the Flashing Cycle on the System tab in the Project Settings dialog box.

■ **Line Spacing**^{*3}

Selects the specification method for line spacing in the list and configures the line spacing.

Set with Number of Lines:

Specifies the number of lines for the message to display for one alarm line.

Enter the number of lines. The range that can be specified varies based on the vertical size of the base screen and the character height. When you enter the number of lines, the line spacing is automatically calculated according to the display area.

Number of lines X Character height = Line spacing (dots)

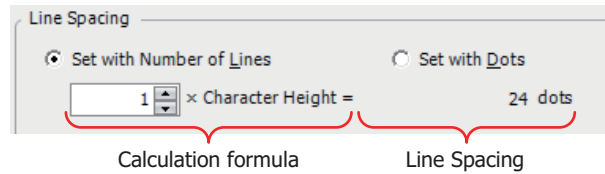

The character height setting varies based on the model.

HG2J-7U: **Size**

Size is 16.

Number of Lines	Character height	Line Spacing	
1	24	= 24 dots	<div style="border: 1px solid black; padding: 2px;"> Current fault Pump fault </div>
			When the message is 2 lines, 2nd line is not shown.
Number of Lines	Character height	Line Spacing	
2	24	= 48 dots	<div style="border: 1px dashed black; padding: 2px;"> Current fault has occurred Pump fault has occurred </div>
Number of Lines	Character height	Line Spacing	
3	24	= 72 dots	<div style="border: 1px dashed black; padding: 2px;"> Current fault has occurred Pump fault has occurred </div>

HG5G/4G/3G/2G-V, HG4G/3G, HG2G-5F/-5T, HG1G/1P: **Magnification H x 16**

Number of Lines	Magnification H	Line Spacing	
1	1	= 16 dots	<div style="border: 1px solid black; padding: 2px;"> Current fault Pump fault </div>
			When the message is 2 lines, 2nd line is not shown.
Number of Lines	Magnification H	Line Spacing	
2	1	= 32 dots	<div style="border: 1px dashed black; padding: 2px;"> Current fault has occurred Pump fault has occurred </div>
Number of Lines	Magnification H	Line Spacing	
3	1	= 48 dots	<div style="border: 1px dashed black; padding: 2px;"> Current fault has occurred Pump fault has occurred </div>

Number of Lines	Magnification H	Line Spacing
3	2	= 96 dots

Current fault
 has occurred

Pump fault
 has occurred



Since the alarm line spacing is adjusted with the number of lines for the message fixed, this option is convenient to use when displaying multi-line messages.

*3 Advanced mode only

Set with Dots: Specifies the line spacing for the message to display for one alarm line in dots.

Enter the height (8 to (base screen vertical size -3)). The range that can be specified varies based on the vertical size of the base screen and the character height.

The character height setting varies based on the model.

HG2J-7U: **Size** is 16.

To display a one-line message, $1 \times 24 = 24$ dots, a line spacing of 24 dots or higher is required.

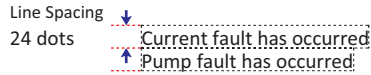

To display a two-line message, $2 \times 24 = 48$ dots, a line spacing of 48 dots or higher is required.

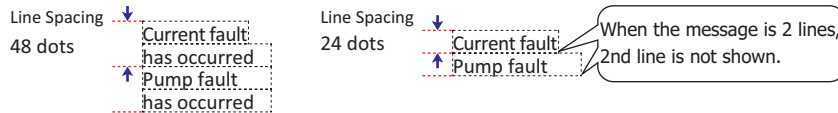

HG5G/4G/3G/2G-V, HG4G/3G, HG2G-5F/-5T, HG1G/1P: **Magnification H** is 1.

To display a one-line message, $1 \times 16 \times 1 = 16$ dots, a line spacing of 16 dots or higher is required.

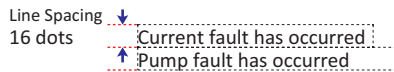

To display a two-line message, $1 \times 16 \times 2 = 32$ dots, a line spacing of 32 dots or higher is required.

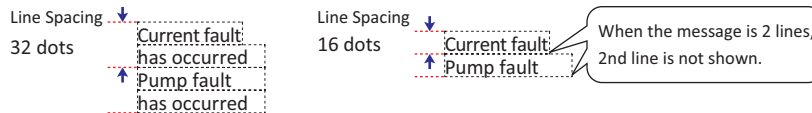

HG5G/4G/3G/2G-V, HG4G/3G, HG2G-5F/-5T, HG1G/1P: **Magnification H** is 2.

To display a one-line message, $2 \times 16 \times 1 = 32$ dots, a line spacing of 32 dots or higher is required.



To display a two-line message, $2 \times 16 \times 2 = 64$ dots, a line spacing of 64 dots or higher is required.

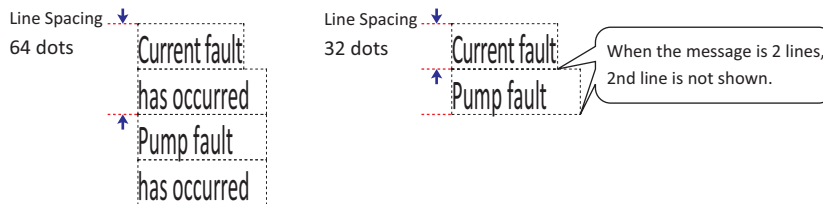

Since only one line of the title is displayed, the title line spacing = 1 (number of lines) x the character height regardless of the **Line Spacing** setting.

Example: When **Size***2 is 24, the title line spacing = $1 \times 24 = 24$ dots
 When **Magnification H***1 is 2, the title line spacing = $1 \times 2 \times 16 = 32$ dots

*1 HG5G/4G/3G/2G-V, HG4G/3G, HG2G-5F/-5T, HG1G/1P only
 *2 HG2J-7U only

Edit Dialog Box

Edit the settings for text color, background color, and flashing according to the status of alarm occurrence, recovery, and confirmation of the selected level.

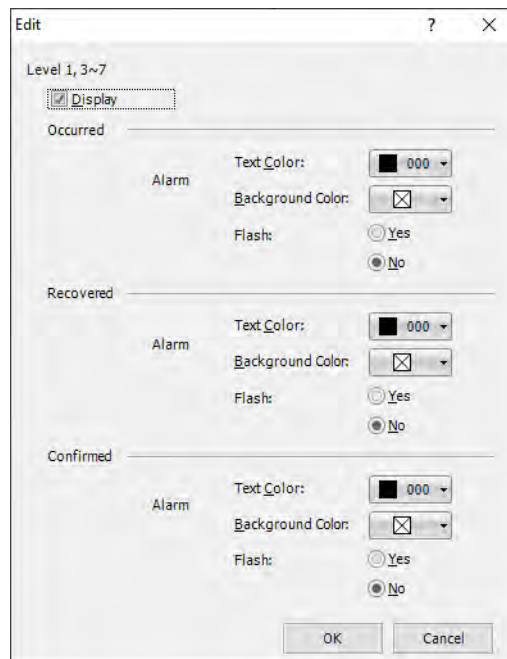

- **Level**

Displays the selected level in the **(Color setting list by level and status)** on the **Format** tab.

- **Display**

Select this check box to display the alarm at the level displayed in the **Level** on the Alarm Log Display.

- **Occurred, Recovered, Confirmed**

Edit the settings for text color, background color, and flashing according to the status of alarm occurrence, recovery, and confirmation.

Text Color: Selects the text color of alarms (color: 256 colors, monochrome: 16 shades).

Click Color to display the Color Palette. Select a color from the Color Palette.

Background Color: Selects the Background color of alarms (color: 256 colors, monochrome: 16 shades).

Click Color to display the Color Palette. Select a color from the Color Palette.

Flash: Selects whether or not to flash alarms.

Flash intervals are set in the **Flashing Cycle** on the **System** tab in the Project Settings dialog box.

● Options Tab

The **Options** tab is displayed in Advanced mode.

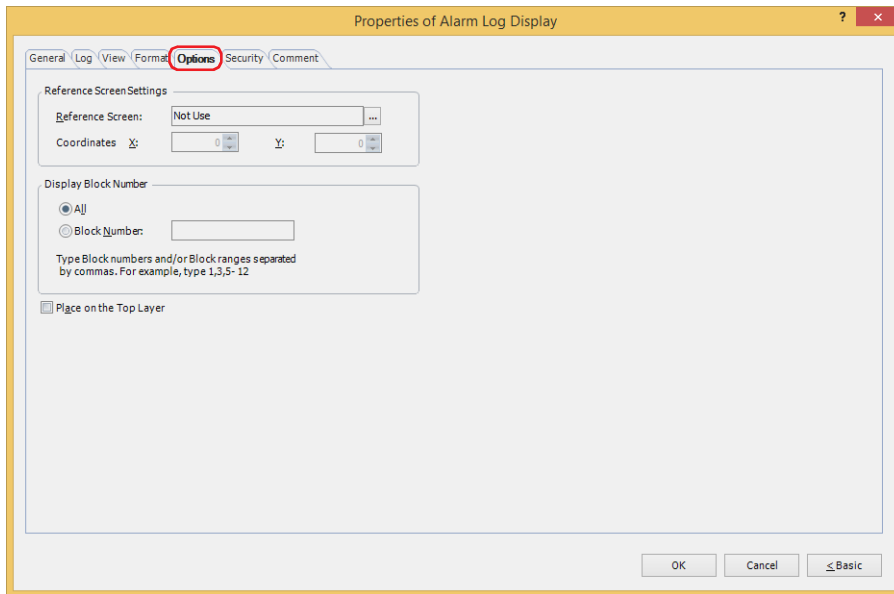

■ Reference Screen Settings

The **Options** tab is used to configure the reference screen. The reference screen is a base screen or popup screen associated with each individual message. The reference screen is displayed when the key button **Ref.** is pressed.

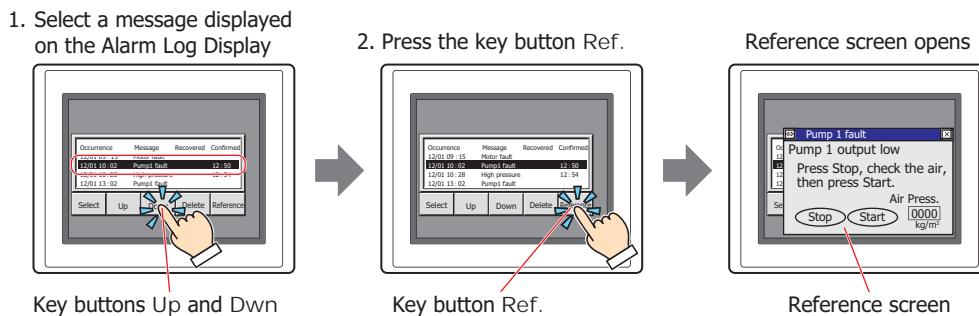

Reference Screen: Displays the type of screen selected in **Reference Screen** on the **Channel** tab in the **Alarm Log Settings** dialog box.

Click **...** to display the **Alarm Log Settings** dialog box.

When displaying a reference screen, select either **Base Screen** or **Popup Screen** as the reference screen type.

When not displaying a reference, select **Not Use**.

Coordinates X, Y: Specifies the coordinates to display the reference screen.

With the upper-left corner of the screen as the origin, the X and Y coordinates are the upper-left corner of the reference screen.

This option can only be configured when **Base Screen** or **Popup Screen** is selected for **Reference Screen**.

Specify the coordinates in 1 dot units.

X: 0 to (base screen horizontal size - 1)

Y: 0 to (base screen vertical size - 1)



If you overlap the reference screen key button and the move focus key buttons, the reference screen can be switched and checked while moving the focus.

■ Display Block Number

Specifies the range of block numbers that will display the collected alarm log data.

All: Displays the data for all blocks.

Block Number: Displays only the data for the specified blocks in the Alarm Log Display. Alarms in unspecified blocks are not displayed, even if active.

Individual block numbers can be specified by separating the numbers with ",", continuous regions can be specified with "-".

Example: When the number of blocks is 6, enter the following.

To specify blocks 1 to 3: 1-3

To specify blocks 1, 3, 6: 1, 3, 6

To specify blocks 1, 4 to 6: 1, 4-6

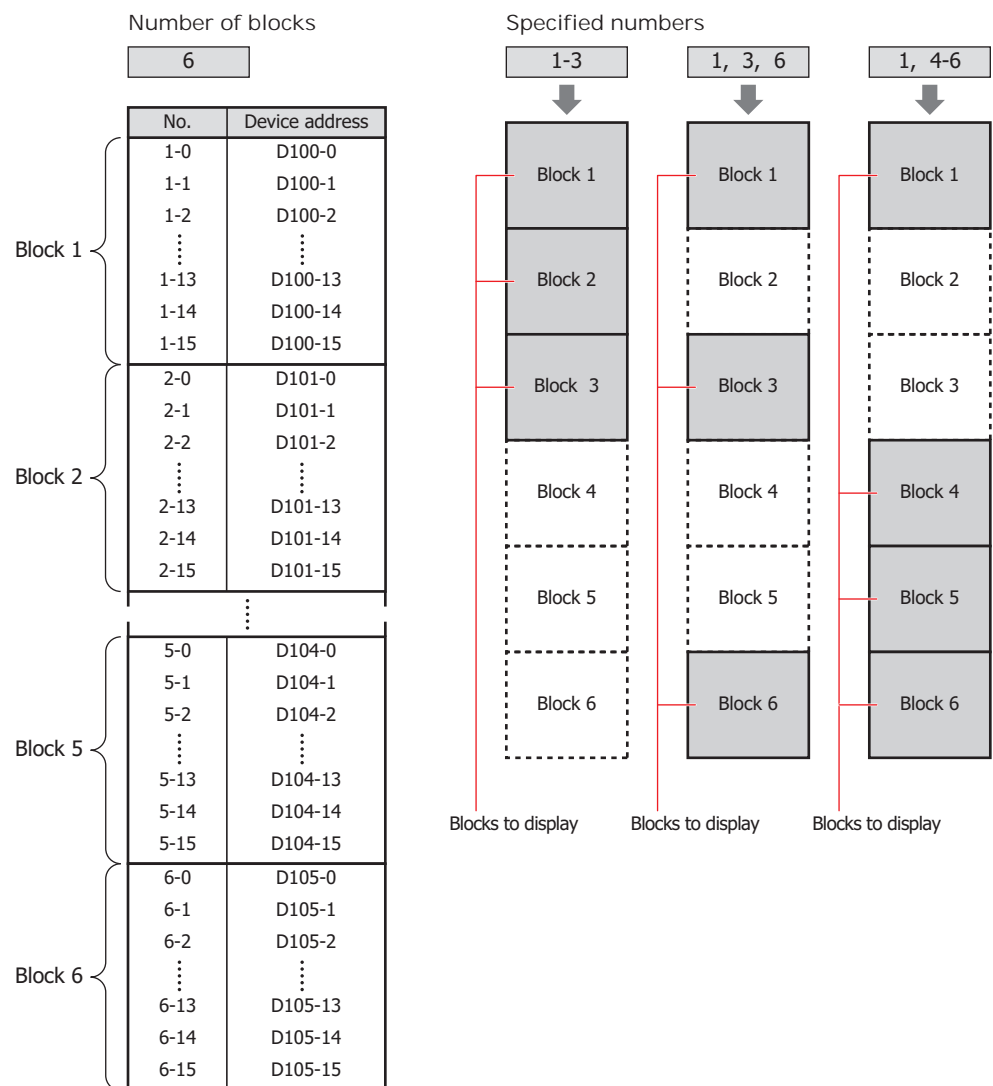

- To display the alarms set in blocks 65 to 128 of the Alarm Log settings, select **All** under **Display Block Number**. If **Block Number** is selected, only blocks 1 to 64 can be specified.
- For the number of blocks, refer to Chapter 13 "Number of Blocks" on page 13-16.

■ Place on the Top Layer

Select this check box to display the parts on the top layer. The parts will have precedence when other drawings and parts are overlapping with it. For details, refer to Chapter 6 "4 Drawings and Parts Overlapping" on page 6-5.

● Security Tab

This tab is used to restrict displaying and using the part by security groups.

This option can only be set when **Use Security functions** is selected. The **Use Security functions** check box is set on **General** tab in the **Security** dialog box.

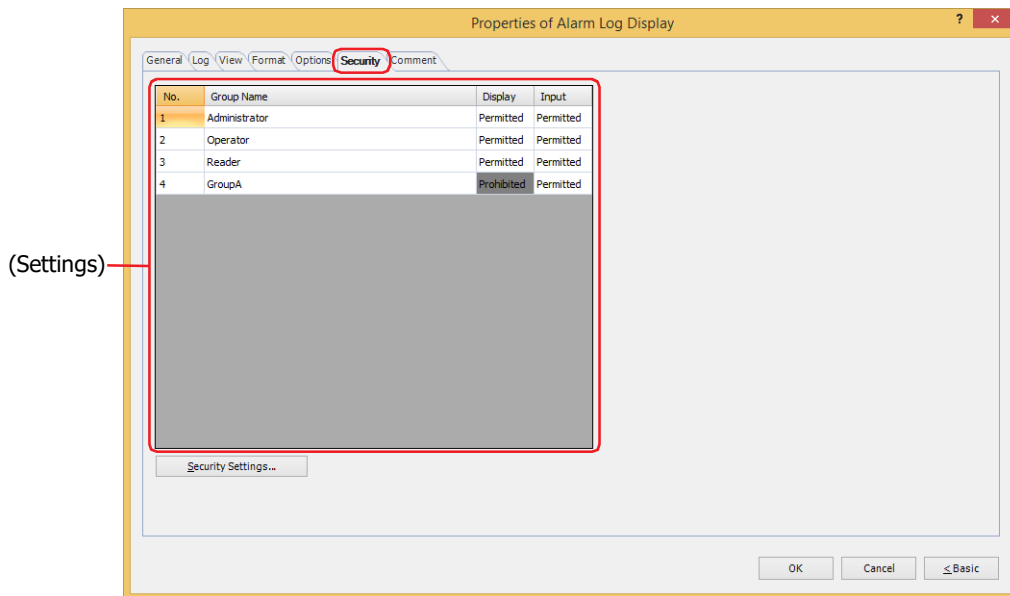

■ (Settings)

Displays the list of security groups used on the MICRO/I.

No.: Displays the security group numbers (1 to 15).

Group Name: Displays the name of the security group.

Display: Displays whether or not there is permission to display the part. Only **Permitted** security groups can display this part. If all security groups are set to **Permitted**, this part will be displayed even if no user account has been selected. Double clicking the cell switches between **Permitted** and **Prohibited**.

Input: Displays whether or not there is permission to use the part. Only **Permitted** security groups can use this part. If all security groups are set to **Permitted**, this part can be used even if no user account has been selected. Double clicking the cell switches between **Permitted** and **Prohibited**.



- You can also switch between **Permitted** and **Prohibited** by right-clicking on a **Display** or **Input** cell.
- Restricting the display and use of the part by switching between **Permitted** and **Prohibited** in **Display** and **Input** cells is similar to using the **Trigger Condition** tab.



■ Security Settings

The Security Settings dialog box is displayed. If you create a security group in the **Security Settings** dialog box, you can select that created group. For details, refer to Chapter 23 "2.2 Adding and Editing Security Groups" on page 23-19.



For details about security functions, refer to Chapter 23 "User Accounts and the Security Function" on page 23-1.

Example: If the user and security group for a part are set as follows:

User Name	 User1	 User2	 User3
Security Group	Reader	Operator	Administrator

MICRO/I

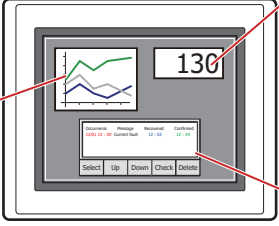

Numerical Display

No.	Group Name	Display
1	Administrator	Permitted
2	Operator	Permitted
3	Reader	Permitted

Line Chart

No.	Group Name	Display
1	Administrator	Permitted
2	Operator	Permitted
3	Reader	Prohibited

Alarm Log Display

No.	Group Name	Display	Input
1	Administrator	Permitted	Permitted
2	Operator	Permitted	Prohibited
3	Reader	Prohibited	Prohibited

For User1 in the **Reader** security group, the parts for which **Display** has been set to **Prohibited** for **Reader** will not be displayed.

If the password screen is opened and the user switches to User2 in the **Operator** security group, the parts for which **Display** has been set to **Permitted** for **Operator** will be displayed.

MICRO/I

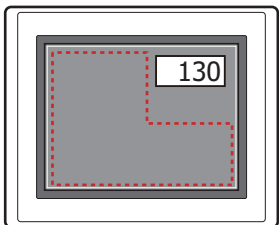

For User1, parts for which Display has been set to Prohibited for Reader are not displayed

MICRO/I

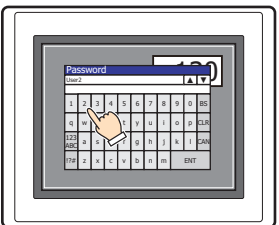

Open Password Screen, enter password, and switch to User2

MICRO/I

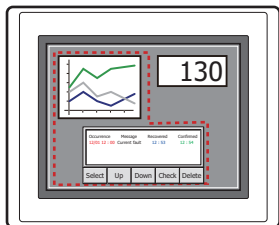

For User2, parts for which Display has been set to Permitted for Operator are displayed

For User2 in **Operator**, **Display** has been set to **Permitted** for **Operator**, but **Input** is **Prohibited**, so the Alarm Log Display cannot be used.

If the password screen is opened and the user switches to User3 in the **Administrator** security group, the parts for which **Display** has been set to **Permitted** for **Administrator** will be displayed, and the parts for which **Input** has been set to **Permitted** for **Administrator** can be used.

MICRO/I

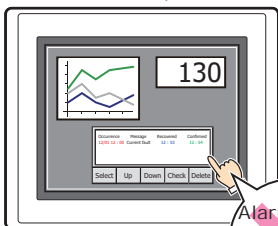

For User2, parts for which Display has been set to Permitted for Operator are displayed, but parts for which Input has been set to Prohibited cannot be used

MICRO/I

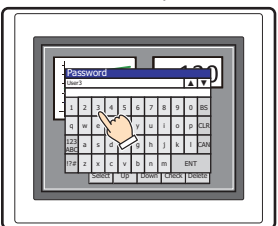

Open Password Screen, enter password, and switch to User3

MICRO/I

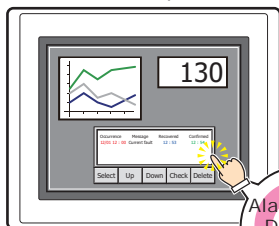

For User3, parts for which Display has been set to Permitted for Administrator are displayed, and parts for which Input has been set to Permitted can be used

● Comment Tab

The **Comment** tab is used to specify the parts placed on the editing screen, and the popup text displayed when the mouse pointer is placed close to **No.**, **Name**, or **Type** in the object list.



When there are multiple parts of the same shape on the screen, this feature makes it possible to distinguish between the parts without displaying the Properties dialog box for each part, by just mousing over the part.

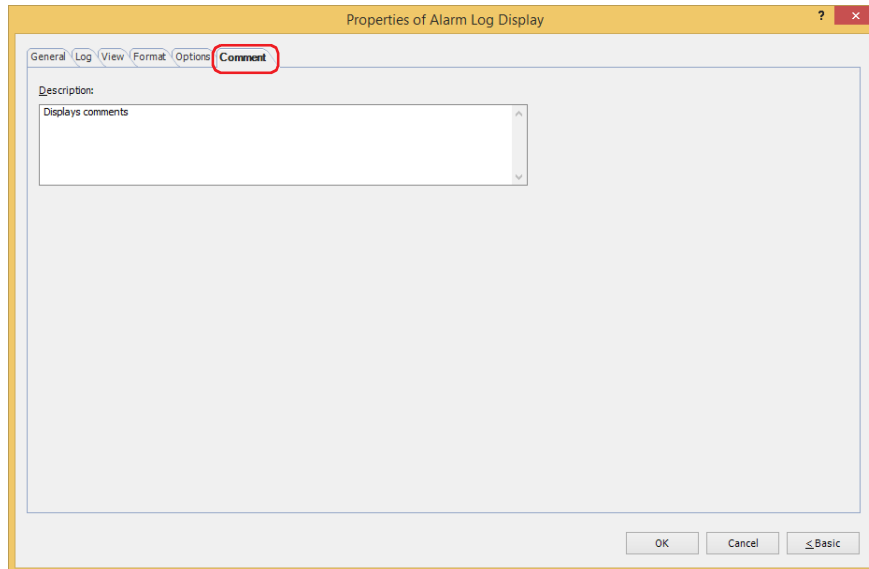

■ Description

Used for entering comments about parts. Maximum number is 80 characters.

Example: When mousing over the Alarm Log Display on the editing screen

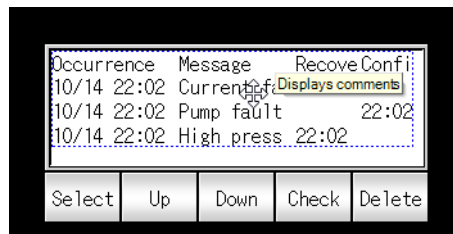

9 Data Log Display

HG2J-7U HG5G-V HG4G-V HG4G HG3G-V HG3G HG2G-V HG2G-5F HG2G-5T HG1G HG1P

9.1 How the Data Log Display is Used

Displays the list of the Data Log data saved in the data storage area and the external memory device.

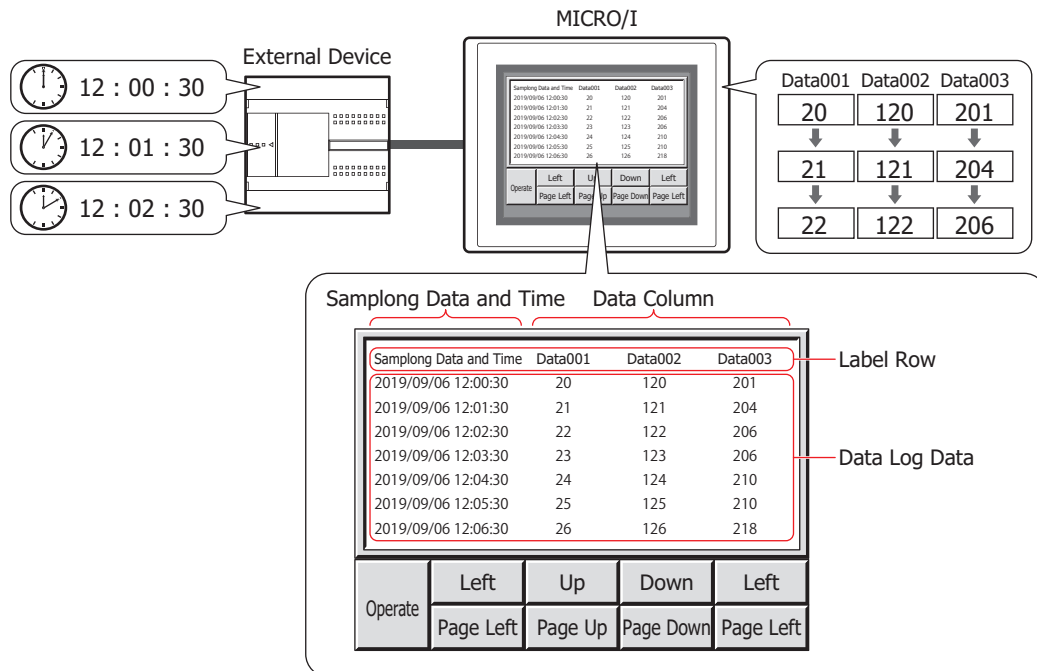

- Only one Data Log Display can be displayed per screen.
- One channel data is displayed per Data Log Display. You cannot switch channels and display other channel data.



For the Key Buttons used with the Data Log Display, refer to Chapter 8 "Data Log Display" on page 8-98.

9.2 Data Log Display Configuration Procedure

This section describes the configuration procedure for Data Log Displays.

- 1 On the **Home** tab, in the **Parts** group, click **Data Displays**, and then click **Data Log Display**.

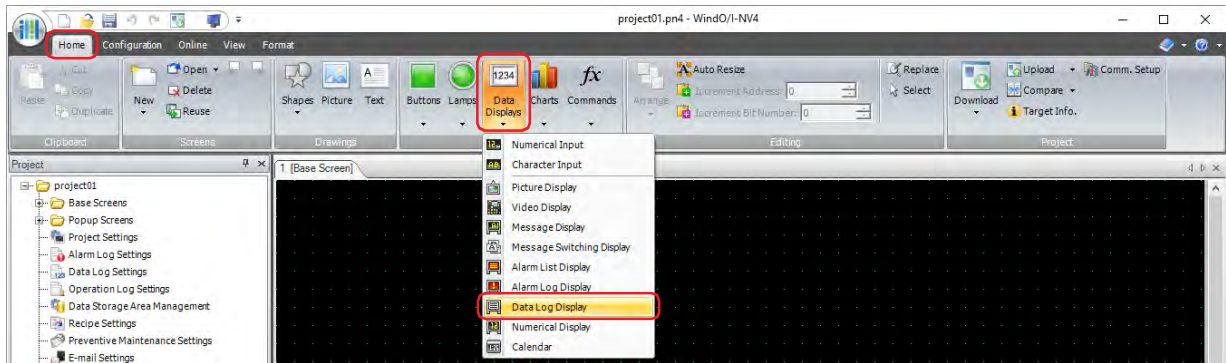

- 2 Click a point on the edit screen where you wish to place the Data Log Display.
- 3 Double-click the placed Data Log Display and a Properties dialog box will be displayed.
- 4 Change the settings on each tab as necessary.

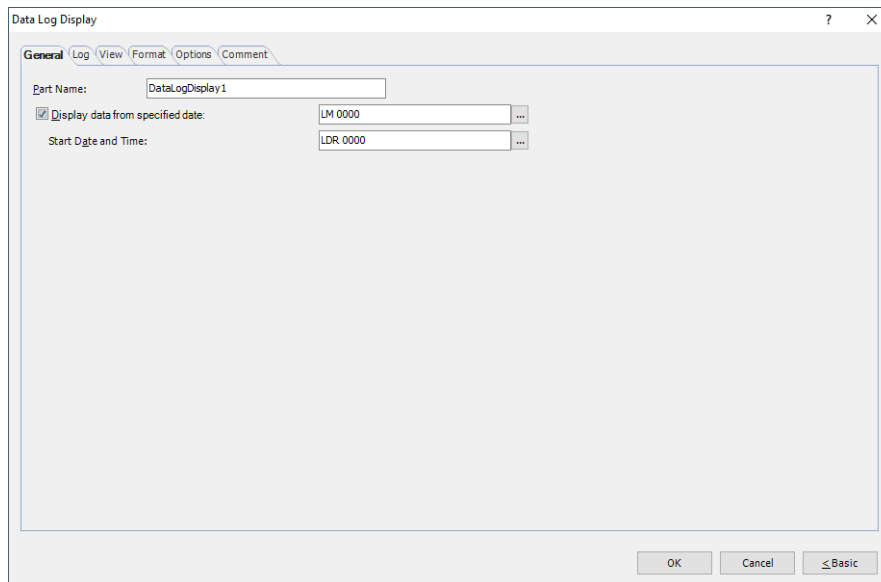

The **Options** tab only appears in Advanced mode.



You can set the default for the Data Log Display on the **Default Preferences** tab of the **WindO/I-NV4 Options** dialog box. For details, refer to Chapter 2 "Default Preferences Tab" on page 2-63.

9.3 Properties of Data Log Display Dialog Box

This section describes items and buttons on the properties dialog box.

● General Tab

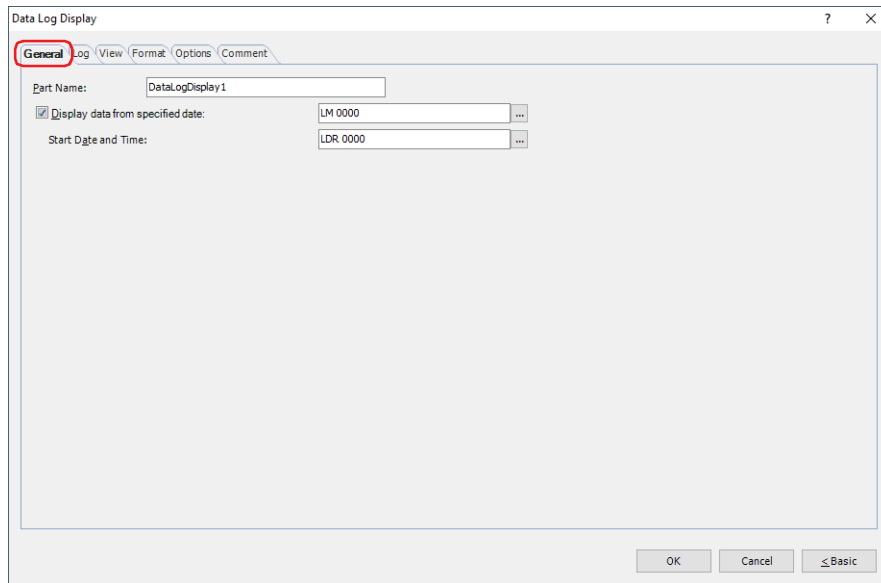

■ Part Name

Enter a name for the part. The maximum number is 20 characters.

■ Display data from specified date

When stopping updating the display, to display the data from the Start

Date, select this check box and specify the bit device or the bit number of the word device to control the display.

Click to display the Tag Editor. For the device address configuration procedure, refer to Chapter 2 "5.1 Device Address Settings" on page 2-70.

Displays from the data of Start Date when the value of device address changes from 0 to 1.

Start Date and Time: Specifies the Start Date for the display data as the values of word devices.

Click to display the Tag Editor. For the device address configuration procedure, refer to Chapter 2 "5.1 Device Address Settings" on page 2-70.

For address number assignment, refer to Chapter 11 "Specifying Date and Time with Values of device addresses" on page 11-33.

This option can only be configured when **Display data from specified date** check box is selected.

● Log Tab

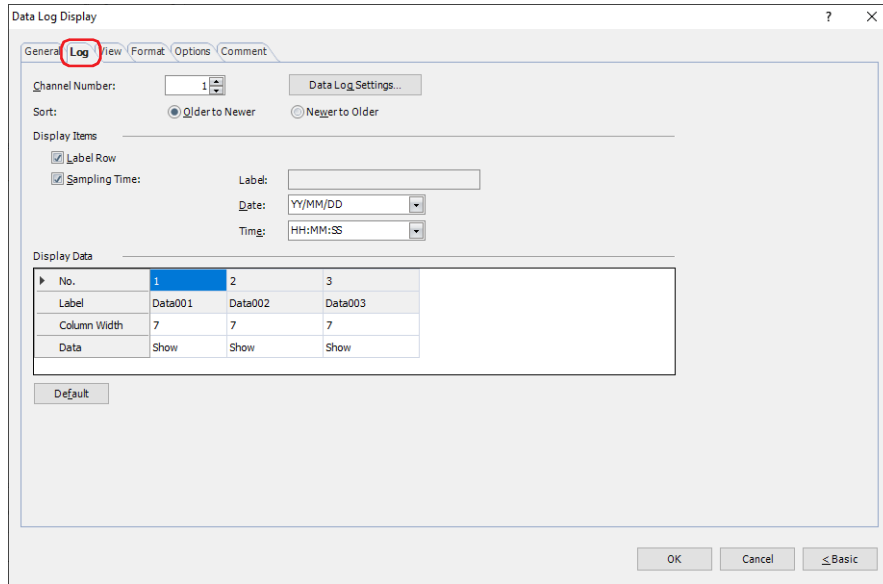

■ Channel No.

Specifies the channel number (1 to 20) of the Data Log data to be displayed.

Data Log Settings: Displays the Data Log Settings dialog box, and you can configure the channel while checking the displayed data.

■ Sort

Selects the display order for the Data Log data as **Old** or **New**.

■ Show Items

Select these check boxes for the items to display on the Data Log Display.

Label Row: Shows the label row.

Sampling Time: Shows the sampling time column.

Label: Displays the label for the sampling time configured as the **Output Items** in the Individual Settings dialog box of the Data Log Settings.

Date: Selects the display type of the sampling date from the following.
YY/MM/DD, MM/DD/YY, DD/MM/YY, MM/DD, DD/MM, non-display

Time: Selects the display type of the sampling time from the following.
HH:MM, HH:MM:SS, non-display

Sampling Data and Time Column		Data Column		
Sampling Data and Time	Data001	Data002	Data003	
2019/09/06 12:00:30	20	120	201	Label Row
2019/09/06 12:01:30	21	121	204	Data Log Data
2019/09/06 12:02:30	22	122	206	
2019/09/06 12:03:30	23	123	206	
2019/09/06 12:04:30	24	124	210	
2019/09/06 12:05:30	25	125	210	
2019/09/06 12:06:30	26	126	218	
Operate	Left	Up	Down	
	Page Left	Page Up	Page Down	Page Left

■ Display Data

Specifies data to display on the Data Log Display.

- No.: Displays the data number of the Data Log. The data number cannot be edited.
- Label: Displays the **Label** under the **Output Data** in the Individual Settings dialog box of the Data Log Settings. The label cannot be edited.
- Column Width: Configures the column width (1 to 40) of the data columns.
- Data: Selects whether or not to display data of the data number on the Data Log Display. Double clicking the cell switches between **Show** and **Hide**. All data of the number switched to **Hide** cannot be displayed.

■ Default

Returns the configured column width to their default values.

● **View Tab**

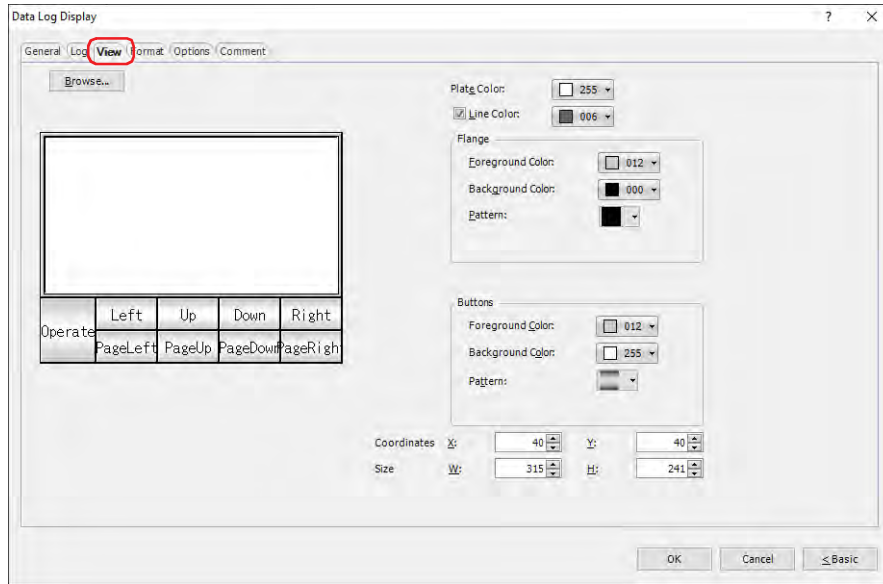

■ **Browse**

Select the type of graphic to be used to represent the part from the list of graphics. Click this button to display the View Browser.

■ **Plate Color**

Selects the plate (color: 256 colors, monochrome: 16 shades).
Click **Color** to display the Color Palette. Select a color from the Color Palette.

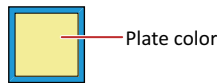

■ **Line Color**

When lines are displayed, select this check box and select line color (color: 256 colors, monochrome: 16 shades).
Click **Color** to display the Color Palette. Select a color from the Color Palette.

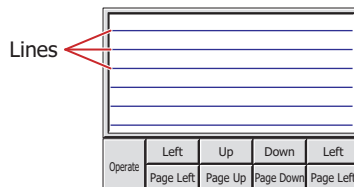

■ **Flange**

Foreground Color, Background Color:

Selects the foreground and background colors of the flange (color: 256 colors, monochrome: 16 shades).

Click **Color** to display the Color Palette. Select a color from the Color Palette.

Pattern:

Selects a pattern for the flange.

Click **Pattern** to display the Pattern Palette. Select a pattern from the Pattern Palette.

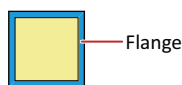

■ **Buttons**

Foreground Color, Background Color: Selects the foreground and background colors of the buttons (color: 256 colors, monochrome: 16 shades).

Click **Color** to display the Color Palette. Select a color from the Color Palette.

Pattern: Selects a pattern or tonal gradation for the button.

Click **Pattern** to display the Pattern Palette. Select a pattern or tonal gradation from the Pattern Palette.

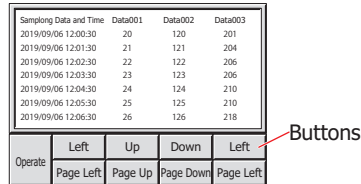

Can be set only when there are grouped Key Buttons.

■ **Coordinates**

X, Y: Sets the display position of parts using coordinates.

The X and Y coordinates of parts is defined relative to an origin at the top-left corner of the screen.

X: 0 to (base screen horizontal size - 1)

Y: 0 to (base screen vertical size - 1)



■ **Size**

W, H: Sets width and height to define the size of parts.

W: 20 to (base screen horizontal size)

H: 20 to (base screen vertical size)

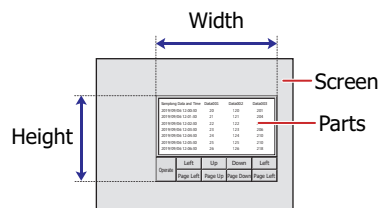

● Format Tab

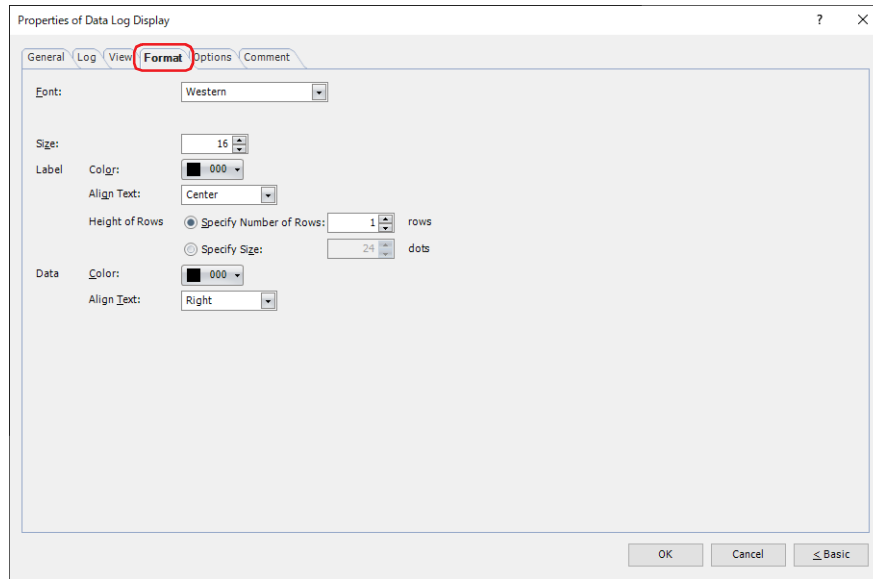

■ Font

Select the font to use for displaying the label row and the Data Log data from the following items:

Western, Japanese, Simplified Chinese, Traditional Chinese, Hangul, Central European, Baltic, Cyrillic

The characters that can be displayed depend on the font. For details, refer to Chapter 2 "1.2 Available Text" on page 2-6.

■ Style*1

Selects **Regular** or **Bold** for text style.

■ Size*2

Specifies the character size (8 to 512).

■ Magnification*1

W, H: Selects text magnification (0.5, 1 to 8).

*1 HG5G/4G/3G/2G-V, HG4G/3G, HG2G-5F/-5T, HG1G/1P only

*2 HG2J-7U only

Label

Configures the details of the label row.

Color: Selects the color for the displayed text (color: 256 colors, monochrome: 16 shades).
Click Color to display the Color Palette. Select a color from the Color Palette.

Align Text: Selects text alignment in the horizontal direction.

Left, Center, Right

For details, refer to Appendix "5 Text Alignment" on page A-7.

Height of Rows: Selects the specification method for height of the label row and configures the height of row.

Specify Number of Rows:

Specifies the number of rows. The range that can be specified varies based on the vertical size of the base screen and the character height. When you enter the number of lines, the height of rows is automatically calculated according to the display area.

$$\text{Number of lines} \times \text{Character height} = \text{Height of rows (dots)}$$

The character height setting varies based on the model.

HG2J-7U: **Size**

Size is 16.

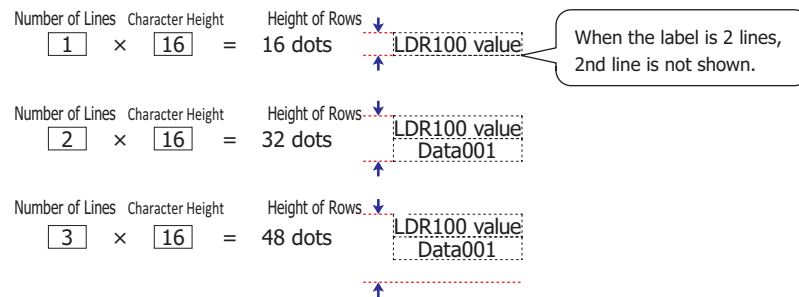

HG5G/4G/3G/2G-V, HG4G/3G, HG2G-5F/-5T, HG1G/1P: **Magnification H x 16**

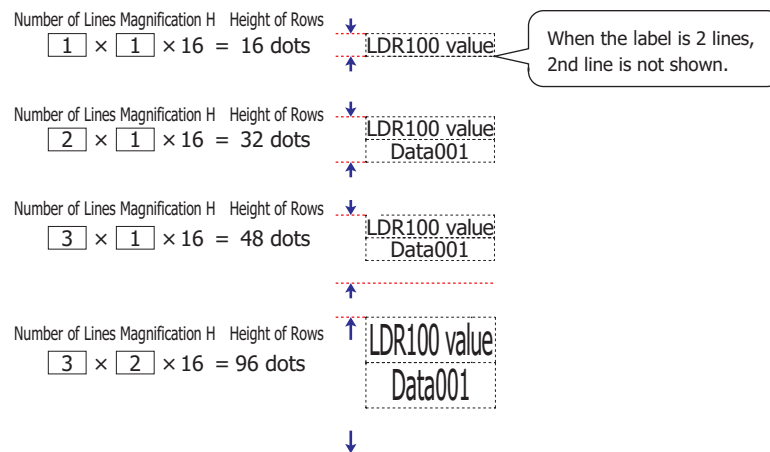

Since the height of row is adjusted with the fixed number of the label rows, this option is convenient to use when displaying multi-line labels.

Specify Size:

Specifies the height of rows in dots.

Enter the height (8 to (base screen vertical size -3)). The range that can be specified varies based on the vertical size of the base screen and the character height.

The character height setting varies based on the model.

HG2J-7U: **Size** is 16.

To display a one-line message, 1 x 24 = 24 dots, a height of rows of 24 dots or higher is required.

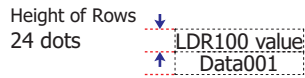

To display a two-line message, 2 x 24 = 48 dots, a height of rows of 48 dots or higher is required.

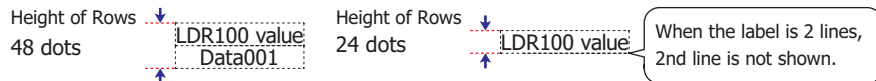

HG5G/4G/3G/2G-V, HG4G/3G, HG2G-5F/-5T, HG1G/1P: **Magnification H** is 1.

To display a one-line message, 1 x 16 = 16 dots, a height of rows of 16 dots or higher is required.

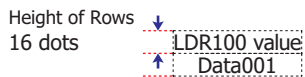

To display a two-line message, 2 x 16 = 32 dots, a height of rows of 32 dots or higher is required.

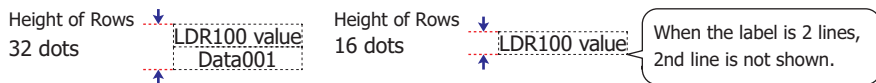

HG5G/4G/3G/2G-V, HG4G/3G, HG2G-5F/-5T, HG1G/1P: **Magnification H** is 2.

To display a one-line message, 1 x 32 = 32 dots, a height of rows of 32 dots or higher is required.

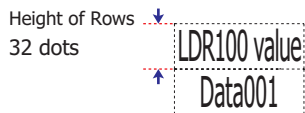

To display a two-line message, 2 x 32 = 64 dots, a height of rows of 64 dots or higher is required.

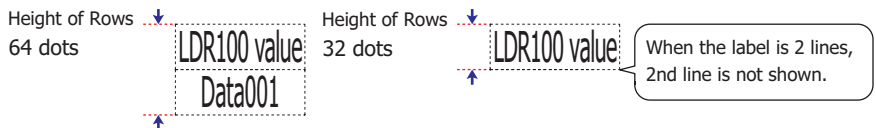

■ **Data**

Configures the details of the Data Log data.

Color: Selects the color for the displayed text (color: 256 colors, monochrome: 16 shades). Click Color to display the Color Palette. Select a color from the Color Palette.

Align Text: Selects text alignment in the horizontal direction.

Left, Center, Right

For details, refer to Appendix "5 Text Alignment" on page A-7.

● Options Tab

The **Options** tab is displayed in Advanced mode.

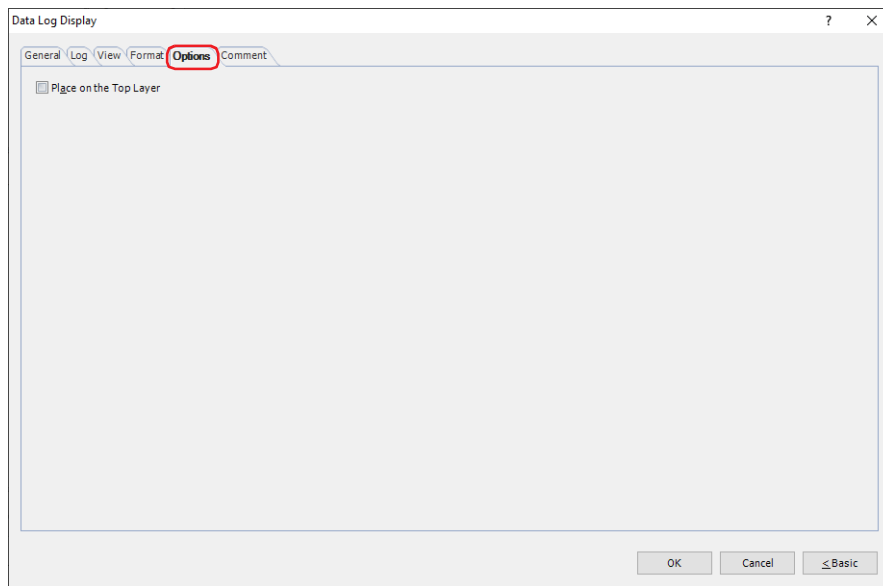

■ Place on the Top Layer

Select this check box to display the parts on the top layer. The parts will have precedence when other drawings and parts are overlapping with it. For details, refer to Chapter 6 "4 Drawings and Parts Overlapping" on page 6-5.

● Security Tab

This tab is used to restrict displaying and using the part by security groups.

This option can only be set when **Use Security functions** is selected. The **Use Security functions** check box is set on **General** tab in the **Security** dialog box.

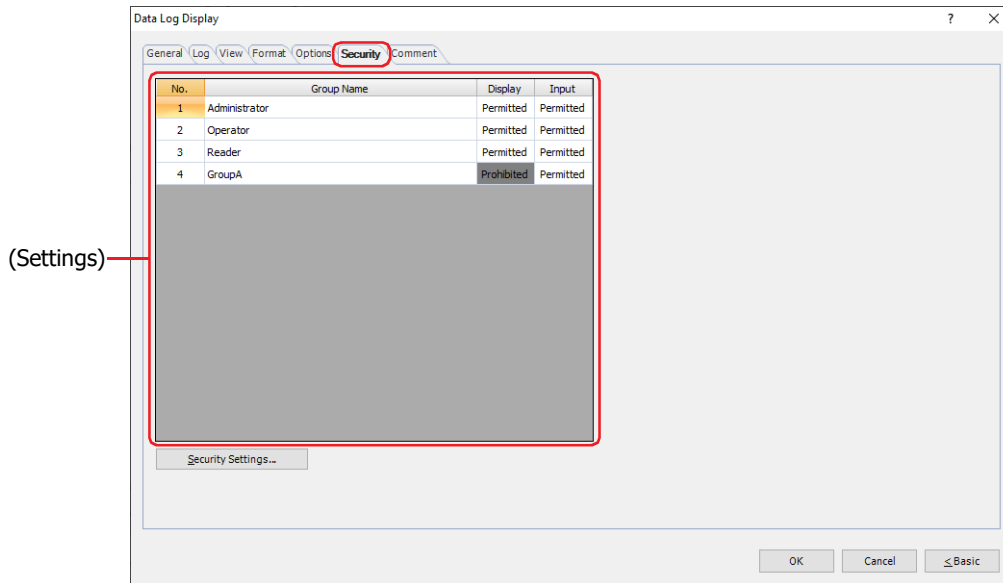

■ (Settings)

Displays the list of security groups used on the MICRO/I.

No.: Displays the security group numbers (1 to 15).

Group Name: Displays the name of the security group.

Display: Displays whether or not there is permission to display the part. Only **Permitted** security groups can display this part. If all security groups are set to **Permitted**, this part will be displayed even if no user account has been selected. Double clicking the cell switches between **Permitted** and **Prohibited**.

Input: Displays whether or not there is permission to use the part. Only **Permitted** security groups can use this part. If all security groups are set to **Permitted**, this part can be used even if no user account has been selected. Double clicking the cell switches between **Permitted** and **Prohibited**.



- You can also switch between **Permitted** and **Prohibited** by right-clicking on a **Display** or **Input** cell.
- Restricting the display and use of the part by switching between **Permitted** and **Prohibited** in **Display** and **Input** cells is similar to using the **Trigger Condition** tab.



■ Security Settings

The Security Settings dialog box is displayed. If you create a security group in the **Security Settings** dialog box, you can select that created group. For details, refer to Chapter 23 "2.2 Adding and Editing Security Groups" on page 23-19.



For details about security functions, refer to Chapter 23 "User Accounts and the Security Function" on page 23-1.

Example: If the user and security group for a part are set as follows:

User Name	 User1	 User2	 User3
Security Group	Reader	Operator	Administrator

MICRO/I

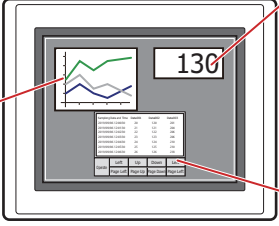

Numerical Display

No.	Group Name	Display
1	Administrator	Permitted
2	Operator	Permitted
3	Reader	Permitted

Line Chart

No.	Group Name	Display
1	Administrator	Permitted
2	Operator	Permitted
3	Reader	Prohibited

Data Log Display

No.	Group Name	Display	Input
1	Administrator	Permitted	Permitted
2	Operator	Permitted	Prohibited
3	Reader	Prohibited	Prohibited

For User1 in the **Reader** security group, the parts for which **Display** has been set to **Prohibited** for **Reader** will not be displayed.

If the password screen is opened and the user switches to User2 in the **Operator** security group, the parts for which **Display** has been set to **Permitted** for **Operator** will be displayed.

MICRO/I

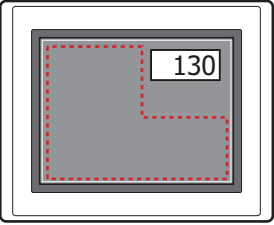

For User1, parts for which Display has been set to Prohibited for Reader are not displayed

MICRO/I



Open Password Screen, enter password, and switch to User2

MICRO/I

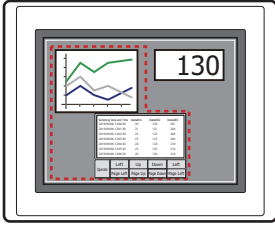

For User2, parts for which Display has been set to Permitted for Operator are displayed

For User2 in **Operator**, **Display** has been set to **Permitted** for **Operator**, but **Input** is **Prohibited**, so the Data Log Display cannot be used.

If the password screen is opened and the user switches to User3 in the **Administrator** security group, the parts for which **Display** has been set to **Permitted** for **Administrator** will be displayed, and the parts for which **Input** has been set to **Permitted** for **Administrator** can be used.

MICRO/I

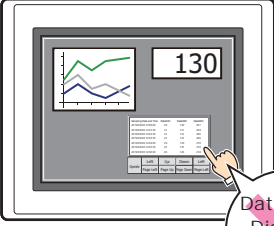

For User2, parts for which Display has been set to Permitted for Operator are displayed, but parts for which Input has been set to Prohibited cannot be used

MICRO/I



Open Password Screen, enter password, and switch to User3

MICRO/I

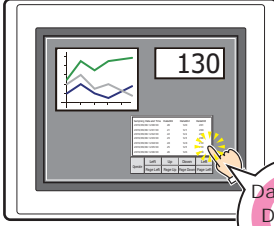

For User3, parts for which Display has been set to Permitted for Administrator are displayed, and parts for which Input has been set to Permitted can be used

● **Comment Tab**

The **Comment** tab is used to specify the parts placed on the editing screen, and the popup text displayed when the mouse pointer is placed close to **No.**, **Name**, or **Type** in the object list.



When there are multiple parts of the same shape on the screen, this features makes it possible to distinguish between the parts without displaying the Properties dialog box for each part, by just mousing over the part.

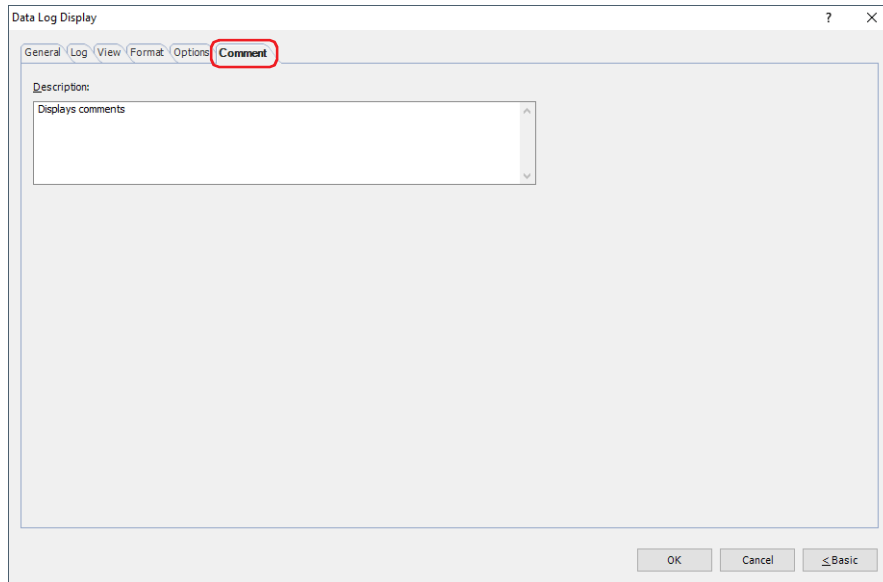

■ **Description**

Used for entering comments about parts. Maximum number is 80 characters.
 Example: When mousing over the Data Log Display on the editing screen

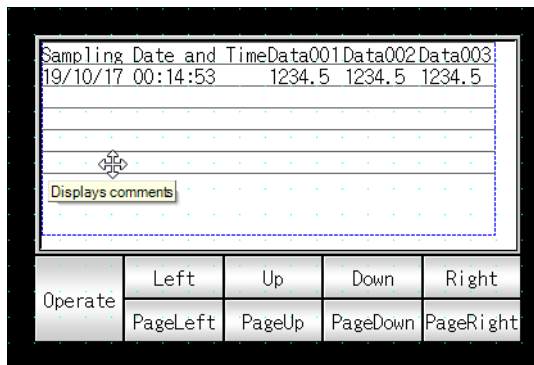

10 Numerical Display

HG2J-7U HG5G-V HG4G-V HG4G HG3G-V HG3G HG2G-V HG2G-5F HG2G-5T HG1G HG1P

10.1 How the Numerical Display is Used

The Numerical Display is used to display the value of a word device in the specified format.

- Display the current value of a device address

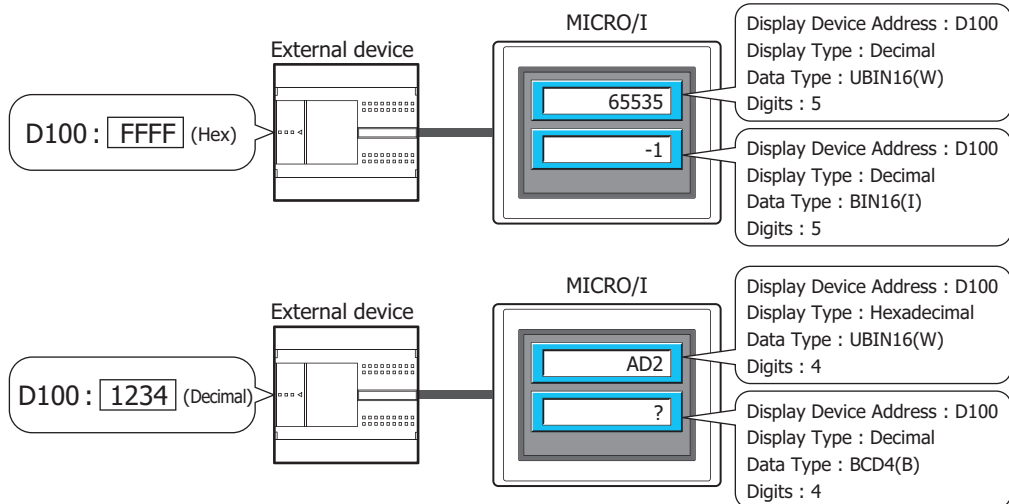

- Display the decimal point

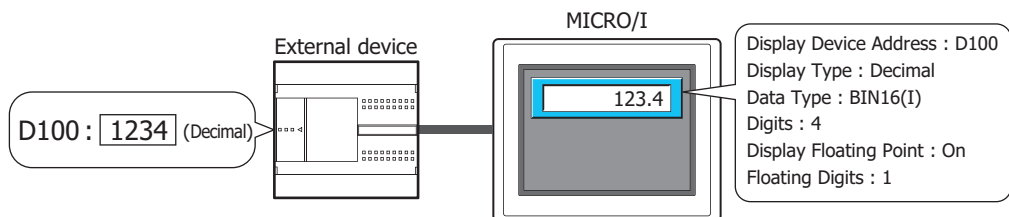

- Display the unit

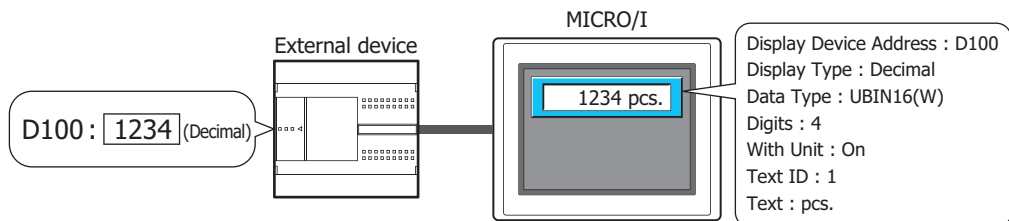

- Flash a value that exceeds the minimum or the maximum

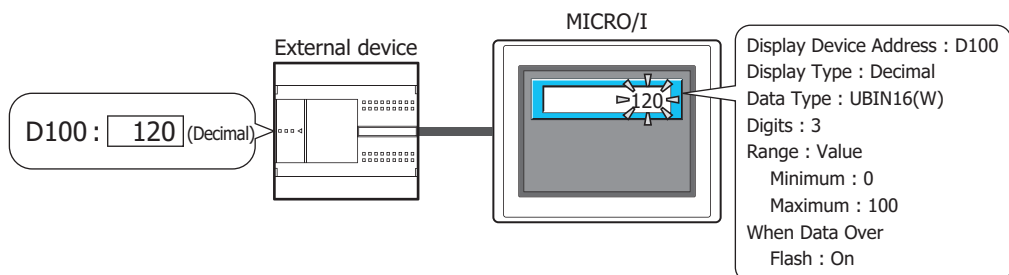

10.2 Numerical Display Configuration Procedure

This section describes the configuration procedure for Numerical Displays.

- 1 On the **Home** tab, in the **Parts** group, click **Data Displays**, and then click **Numerical Display**.

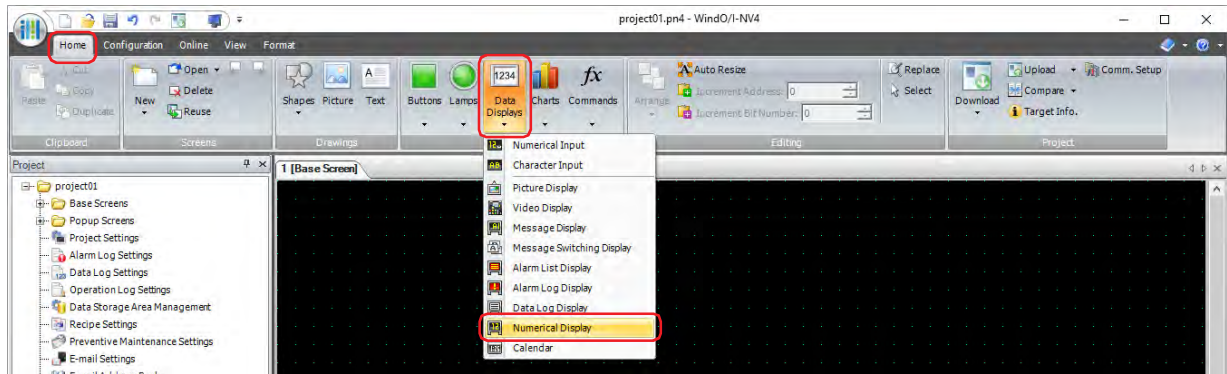

- 2 Click a point on the edit screen where you wish to place the Numerical Display.
- 3 Double-click the placed Numerical Display and a Properties dialog box will be displayed.
- 4 Change the settings on each tab as necessary.

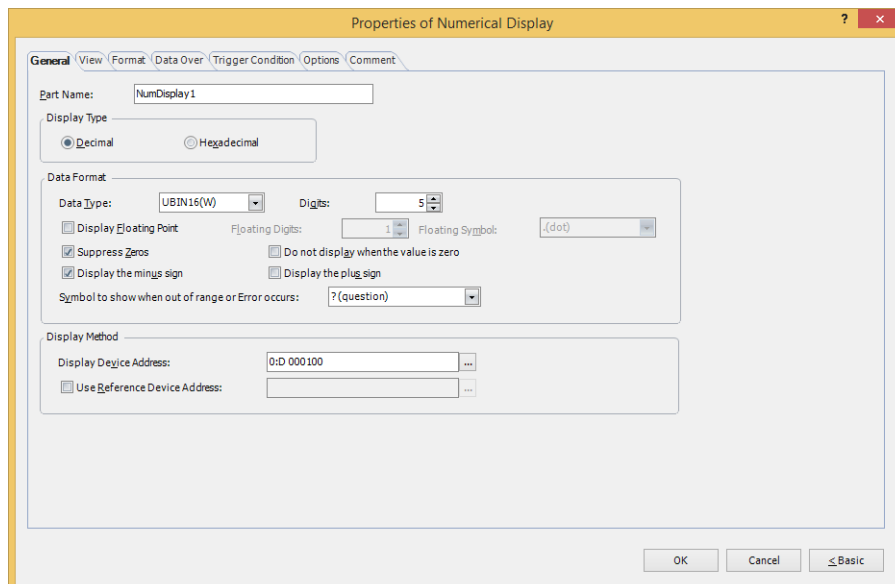

The **Data Over** tab, **Trigger Condition** tab and **Options** tab only appear in Advanced mode.



You can set the default for the Numerical Display on the **Default Preferences** tab of the **WindO/I-NV4 Options** dialog box. For details, refer to Chapter 2 "Default Preferences Tab" on page 2-63.

10.3 Properties of Numerical Display Dialog Box

This section describes items and buttons on the properties dialog box.

● General Tab

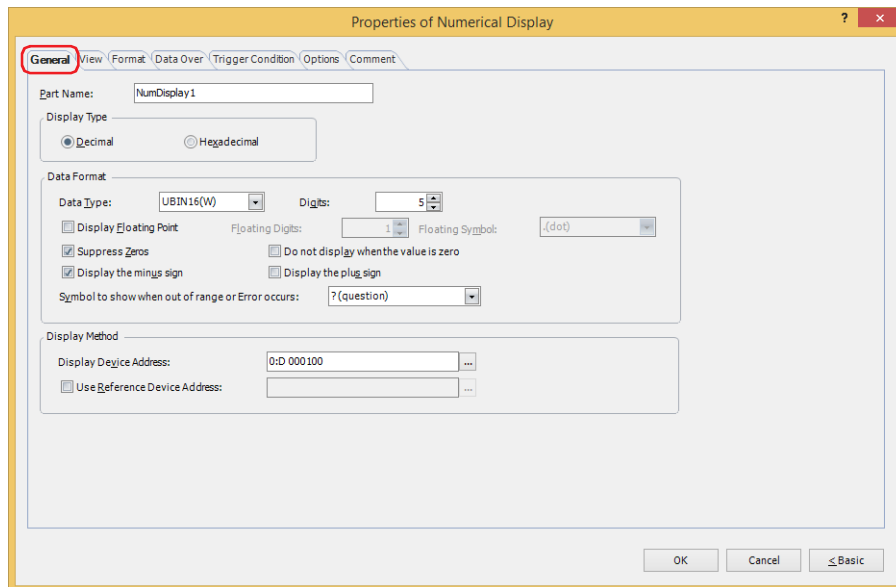

■ Part Name

Enter a name for the part. The maximum number is 20 characters.

■ Display Type

Selects the display type for the value as **Decimal** or **Hexadecimal**.

■ Data Format

Data Type: Selects the type of data for the value.

For details, refer to Chapter 2 “1.1 Available Data” on page 2-1.

Digits:

Specifies the digits to display. The range of digits that can be set varies based on the display type and data type. The digits that can be set are as follows.

Display Type	Data Type	Digits
Decimal display	UBIN16(W), BIN16(I)	1 to 5
	UBIN32(D), BIN32(L)	1 to 10
	BCD4(B)	1 to 4
	BCD8(EB)	1 to 8
	Float32(F)	1 to 10
Hexadecimal display	UBIN16(W)	1 to 4
	UBIN32(D)	1 to 8

Display Floating Point: Select this check box to display the decimal point.



When the **Display Floating Point** check box is selected and **UBIN16(W)**, **BIN16(I)**, **UBIN32(D)**, **BIN32(L)**, **BCD4(B)**, or **BCD8(EB)** is selected for **Data Type**, the source device is an integer, but the value is displayed with the decimal point added at the configured floating digits.

However, if **Float32(F)** is selected for **Data Type**, the source data is a decimal value.

Floating Digits: Specifies the number of digits for the fractional part of the decimal value out of the number of digits specified by **Digits**.
 This option can only be configured when the **Display Floating Point** check box is selected. The range of digits that can be set for the fractional part varies based on the display type and data type. The range of digits that can be set for the fractional part is as follows.

Display Type	Data Type	Floating Digits
Decimal display	UBIN16(W), BIN16(I)	1 to Digits
	UBIN32(D), BIN32(L)	1 to Digits
	BCD4(B)	1 to Digits
	BCD8(EB)	1 to Digits
	Float32(F)	1 to Digits or 8
Hexadecimal display	UBIN16(W)	--
	UBIN32(D)	--

Floating Symbol*1: Selects the decimal point symbol from the following.
.(dot), :(colon), ;(semicolon), ,(comma), /(slash)
 This option can only be configured when the **Display Floating Point** check box is selected.

Example: When **Digits** is 4 and **Floating Digits** is 2
 When **Floating Symbol** is **.(dot)** 12.34
 When **Floating Symbol** is **/(slash)** 12/34

Suppress Zeros: Select this check box to hide "0" for the upper digits of the integer part.

Example: **Suppress Zeros** selected: 1234
Suppress Zeros cleared: 00001234

Do not display when the value is zero: Select this check box to show a blank display if the value is "0".



- If the value is zero and it is not displayed, the unit set on the **Format** tab is also not displayed.
- Even if the **Do not display when the value is zero** check box is selected, "0" is displayed when the value is not 0.

Display the minus sign: Select this check box to display the - (negative) sign when displaying negative values. This option can only be configured when **Decimal** is selected for **Display Type**.

Display the plus sign: Select this check box to display the + (positive) sign when displaying positive values. This option can only be configured when **Decimal** is selected for **Display Type**.

Symbol to show when out of range or Error occurs:

Selects the following symbols to be displayed when a value exceeding the **Data Type** in the **General** tab is entered, or an error occurs.
 "? (question mark)", " (space)", "# (pound)", "% (percent)", "\$ (dollar)", "- (minus)", "@ (at sign)", "\" (backslash)", "*" (asterisk)", "! (exclamation mark)", "+" (plus)"



In the following cases, it is handled as an error and the symbol selected in **Symbol to show when out of range or Error occurs** is displayed.

- If the **Data Type** is **BCD4(B)**, **BCD8(EB)**, or **Float32(F)** and the value entered in device address doesn't comply with the data type.
- If a value divided by zero operation was executed with **Display with Arithmetic Operation** on the **Options** tab.

*1 Advanced mode only

■ Display Method

Specifies the source of the value to display.

Display Device Address: Specifies the word device that stores the value to display.

Click to display the Tag Editor. For the device address configuration procedure, refer to Chapter 2 "5.1 Device Address Settings" on page 2-70.

Use Reference Device Address*¹: Select this check box and specify a device address to change the source device address by the value of this device address.

Click to display the Tag Editor. For the device address configuration procedure, refer to Chapter 2 "5.1 Device Address Settings" on page 2-70.

For details on indirect reading, refer to Chapter 2 "Indirect Read and Indirect Write Settings" on page 2-5.

*1 Advanced mode only

● View Tab

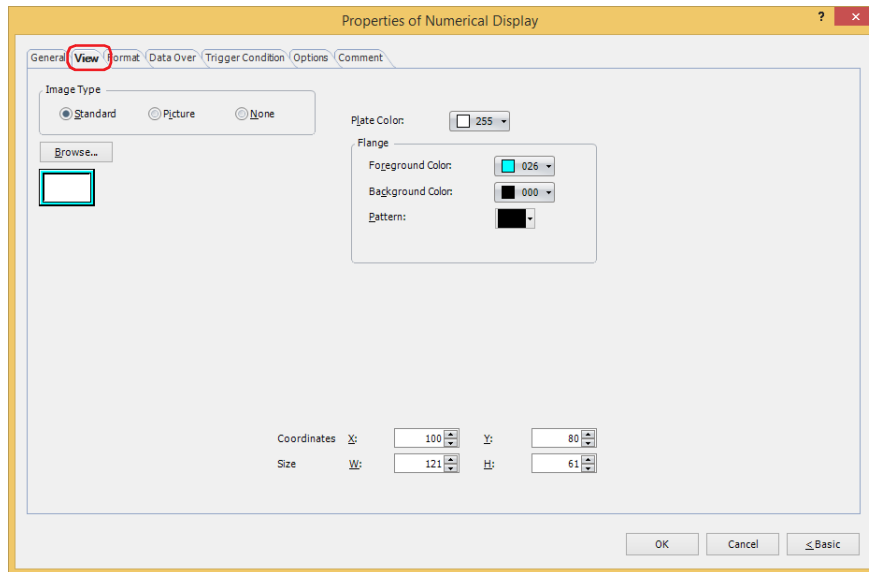

■ Image Type

Select the type of graphic to be used to represent the part.

Standard: Uses the default graphic for WindO/I-NV4.

Picture: Uses an image file saved using Picture Manager.

For details about image file restrictions, refer to Chapter 2 "1.4 Available Image Files" on page 2-20.

None: The plate and the flange of the part are not displayed. Only the text is displayed.

■ Browse

Select the type of graphic to be used to represent the part from the list of graphics. Click this button to display the View Browser or Picture Manager, depending on the setting for **Image Type**.

■ Plate Color

Selects the plate color of the standard graphic (color: 256 colors, monochrome: 16 shades).

Click **Color** to display the Color Palette. Select a color from the Color Palette.

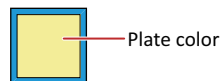

■ Flange

Foreground Color, Background Color:

Selects the foreground and background colors of the flange of the standard graphic (color: 256 colors, monochrome: 16 shades).

Click **Color** to display the Color Palette. Select a color from the Color Palette.

Pattern: Selects a pattern for the flange of the standard graphic.

Click **Pattern** to display the Pattern Palette. Select a pattern from the Pattern Palette.

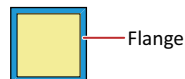

■ Coordinates

- X, Y: Sets the display position of parts using coordinates.
 The X and Y coordinates of parts is defined relative to an origin at the top-left corner of the screen.
- X: 0 to (base screen horizontal size - 1)
- Y: 0 to (base screen vertical size - 1)

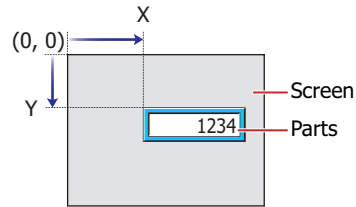

■ Size

- W, H: Sets width and height to define the size of parts.
- W: 5 to (base screen horizontal size)
- H: 5 to (base screen vertical size)

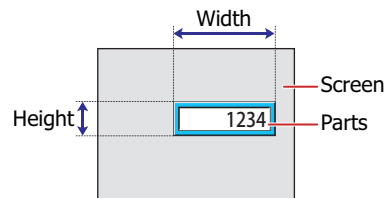

● Format Tab

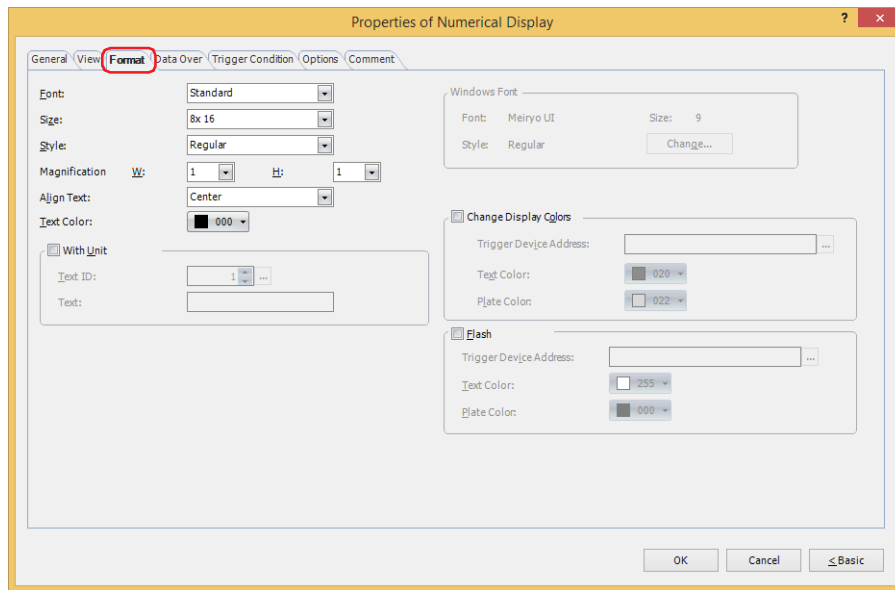

■ Font

Selects the font used for displaying text from the following.

Western^{*1}, Standard^{*2}, Stroke^{*2}, 7-Segment, Windows

The characters that can be displayed depend on the font. For details, refer to Chapter 2 "1.2 Available Text" on page 2-6.

■ Size

Specifies the text size to be displayed. The fonts and sizes that can be set vary based on the model.

Model	Font	Size
HG2J-7U	Western, 7-Segment	8 to 512
HG5G/4G/3G/2G-V, HG4G/3G, HG2G-5F/-5T, HG1G/1P	Standard	8x16, 16x16
	Stroke, 7-Segment	8 to 128

■ Style^{*2}

Selects **Regular** or **Bold** for text style.

Can only be set when **Standard** is selected for **Font**.

■ Magnification^{*2}

W, H: Selects text magnification (0.5, 1 to 8).

Can only be set when **Standard** is selected for **Font**.

■ Align Text

Selects the text alignment in the horizontal direction from the following.

Left, Center, Right

For details, refer to Appendix "5 Text Alignment" on page A-7.

■ Text Color

Selects the color of displayed text (color: 256 colors, monochrome: 16 shades).

Click **Color** to display the Color Palette. Select a color from the Color Palette.

*1 HG2J-7U only

*2 HG5G/4G/3G/2G-V, HG4G/3G, HG2G-5F/-5T, HG1G/1P only

■ With Unit*3

Select this check box to display units or other characters at the end of a number. Displayed characters must be registered in Text Manager. The displayed text color will be as set for **Text Color** under the **Format** tab.

Text ID: Specifies the Text Manager ID No. (1 to 32000).

Click  to display Text Manager.

Text: Displays the characters of the specified Text ID.



- The maximum number that can be displayed with this function is 4 characters. The fifth and subsequent characters of a character string are not displayed. However, if using a Windows font for the selected text ID, the fifth and subsequent characters of a character string will still be displayed.
- If a carriage return (CR) is included the characters after the CR are not displayed.

■ Windows Font

Configures the font to use as the Windows Font.

Select **Windows** for **Font** to display the current settings. To change the settings, click **Change** to display the **Font** dialog box. For details, refer to Chapter 2 "Windows Font" on page 2-13.

■ Change Display Colors

Select this check box to switch the text and plate colors.

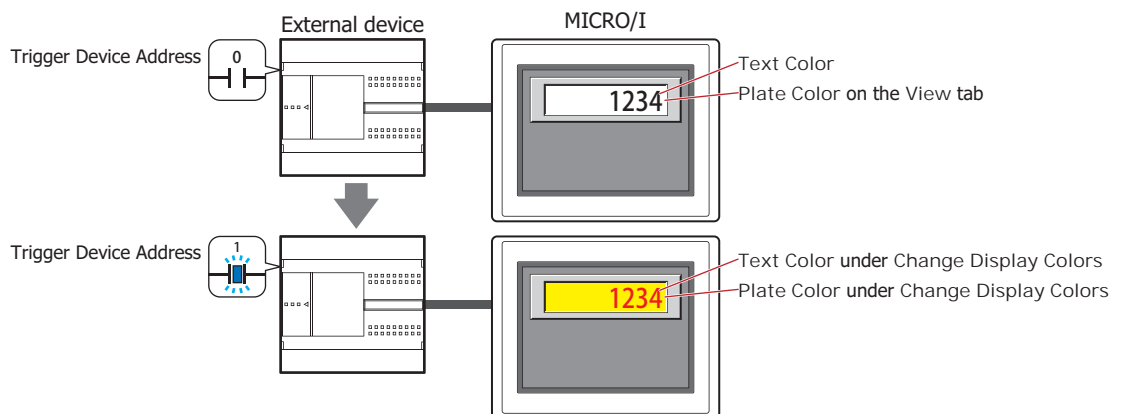

Trigger Device Address: Specifies the bit device or the bit number of the word device to use as the trigger to switch the text and plate colors.

Click  to display the Tag Editor. For the device address configuration procedure, refer to Chapter 2 "5.1 Device Address Settings" on page 2-70.

When the value of device address is 0, the color specified in **Text Color** or in **Plate Color** on the **View** tab will be displayed.

When the value of device address is 1, the color displayed and specified in **Text Color** or **Plate Color** under the **Change Display Colors**.

Text Color: Selects the color (color: 256 colors, monochrome: 16 shades) of the text when switching. Click this button to display the Color Palette. Select a color from the Color Palette.

Plate Color: Selects the plate color (color: 256 colors, monochrome: 16 shades) when switching. Click this button to display the Color Palette. Select a color from the Color Palette. This option can only be configured when **Standard** is selected for **Image Type** on the **View** tab.

*3 Advanced mode only

■ **Flash** *3

Select this check box to make the text and plate colors flash.

The flashing will occur as follows:

- The **Change Display Colors** check box is cleared, then the colors specified by **Text Color** and **Plate Color** on the **View** tab and the colors specified by **Text Color** and **Plate Color** under **Flash** are alternately displayed.

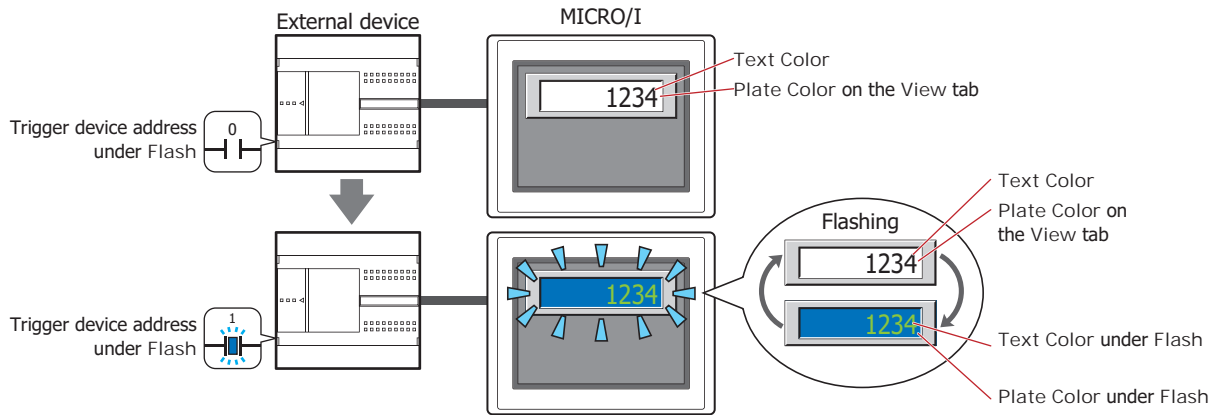

- The **Change Display Colors** check box is selected and the value of the trigger device address for **Change Display Colors** is 0, then the colors specified by **Text Color** and **Plate Color** on the **View** tab and the colors specified by **Text Color** and **Plate Color** under **Flash** are alternately displayed.

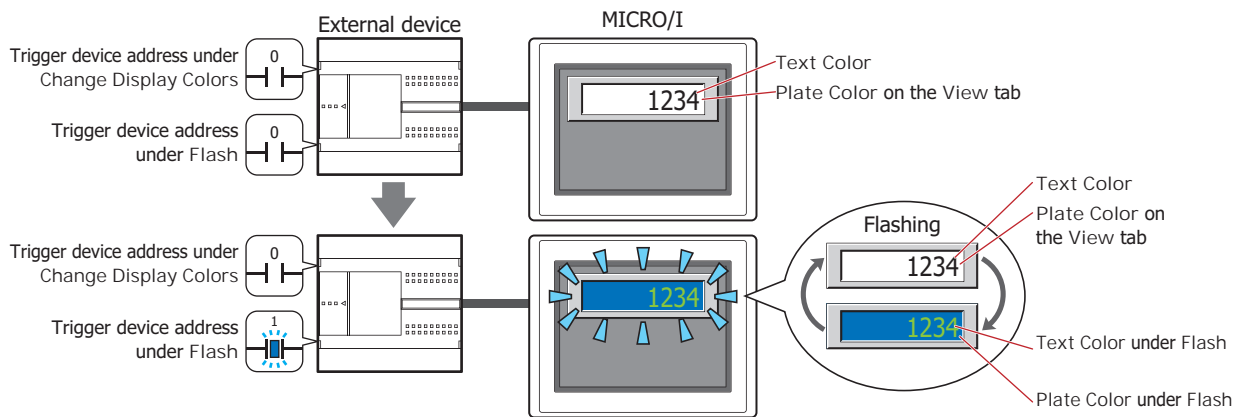

- The **Change Display Colors** check box is selected and the value of the trigger device address for **Change Display Colors** is 1, then the colors specified by **Text Color** and **Plate Color** under **Change Display Colors** and the colors specified by **Text Color** and **Plate Color** under **Flash** are alternately displayed.

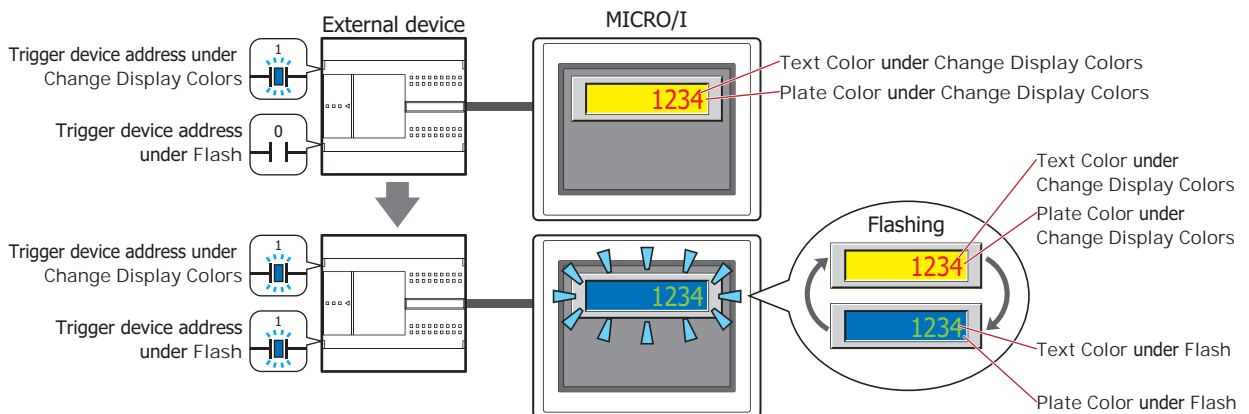

*3 Advanced mode only

- Trigger Device Address:** Specifies the bit device or the bit number of the word device that will be used to trigger flash.
Click  to display the Tag Editor. For the device address configuration procedure, refer to Chapter 2 "5.1 Device Address Settings" on page 2-70.
Flash intervals are set in the **Flashing Cycle** on the **System** tab in the **Project Settings** dialog box.
- Text Color:** Selects the color (color: 256 colors, monochrome: 16 shades) of text when flashing.
Click this button to display the Color Palette. Select a color from the Color Palette.
- Plate Color:** Selects the plate color (color: 256 colors, monochrome: 16 shades) when flashing.
Click this button to display the Color Palette. Select a color from the Color Palette.
This option can only be configured when **Standard** is selected for **Image Type** on the **View** tab.



If the **Flash** check box is selected and the **Flash** check box under **When Data Over** on the **Data Over** tab is also selected, the Data Over display is blinking will be given precedence when both conditions are satisfied.

● Data Over Tab

The **Data Over** tab is displayed in Advanced mode.

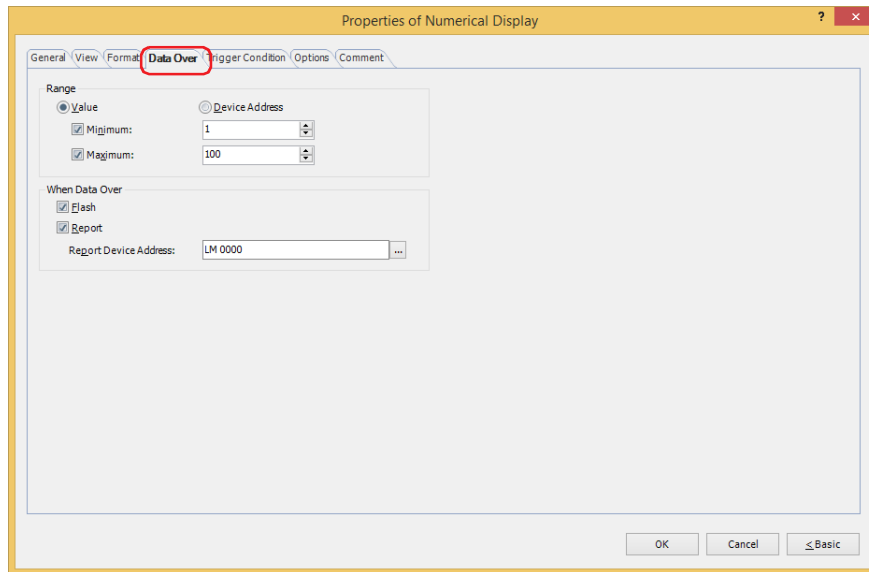

■ Range

Select data type.

Value: Specifies the minimum and/or the maximum as a constant.

Device Address: Specifies the minimum and/or the maximum as a value of word device.

Specifies the allowable range of values to display.

Minimum, Maximum: Select these check boxes to specify the minimum and/or maximum.

The minimum and maximum that can be specified when **Value** is selected vary based on the data type selected with **Data Format** on the **General** tab. For details on data types, refer to Chapter 2 "1.1 Available Data" on page 2-1.

When **Device Address** is selected, these options specify the source word devices.

Click  to display the Tag Editor. For the device address configuration procedure, refer to Chapter 2 "5.1 Device Address Settings" on page 2-70.



- Select **UBIN16(W)**, **BIN16(I)**, **UBIN32(D)**, **BIN32(L)**, **BCD4(B)**, or **BCD8(EB)** for **Data Type** under the **General** tab, and to display a fractional number specify the values of **Minimum** and **Maximum** as an integer.
Example: To set a value of "1.25" for the upper limit, enter "125".
- If the value of the device address to display exceeds the data range that can be processed for the data type selected under **Data Format** on the **General** tab, the symbol selected under **Symbol to show when out of range or Error occurs** on the **General** tab is displayed.

■ When Data Over

These options configure the operation of the part when the allowable range is exceeded.

These options can only be configured when the **Minimum** or **Maximum** check boxes are selected under **Range**.

Flash: Select this check box to make the value flash when the displayed data exceeds the allowable range.

Report: Select this check box to write 1 in the Report Device Address when the displayed data exceeds the allowable range.

Report Device Address: Specifies the Report Device Address.

Click  to display the Tag Editor. For the device address configuration procedure, refer to Chapter 2 "5.1 Device Address Settings" on page 2-70.

Example: If the value of word device of the reading source is "120," which is higher than the upper limit of "100," or "-10," which is below the lower limit of "0," a value of 1 will be written to LM0 and the displayed numerical value will flash.

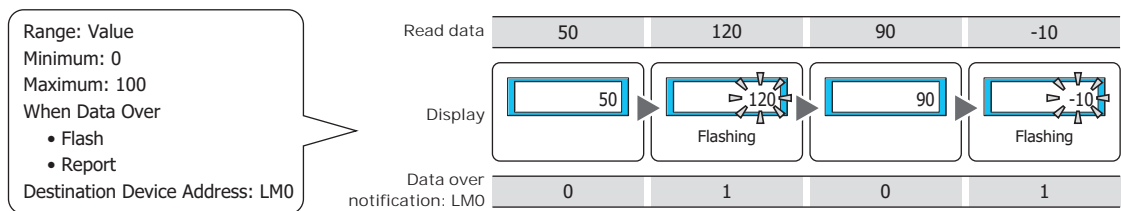

● **Trigger Condition Tab**

The **Trigger Condition** tab is displayed in Advanced mode.

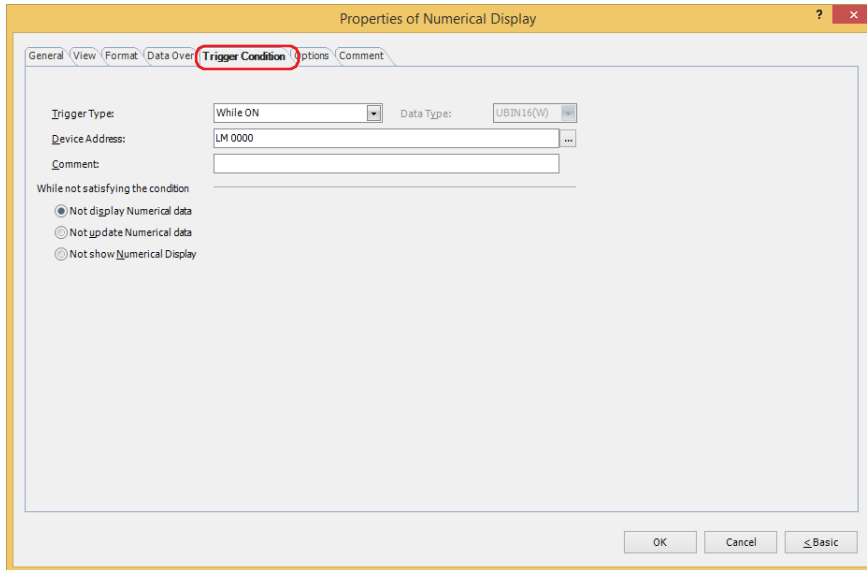

The Numerical Display is enabled while the condition is satisfied, and it is disabled while the condition is not satisfied. Select the operation when the condition is not satisfied as **Not display Numerical data**, **Not update Numerical data**, or **Not show Numerical Display** under **While not satisfying the condition**.

Example: When **Trigger Type** is **While ON**, **Device Address** is **LM0**, and **While not satisfying the condition** is **Not display Numerical data**

While LM0 is 0, the condition is not satisfied and the Numerical Display does not display the number.
 While LM0 is 1, the condition is satisfied and the Numerical Display displays the number.

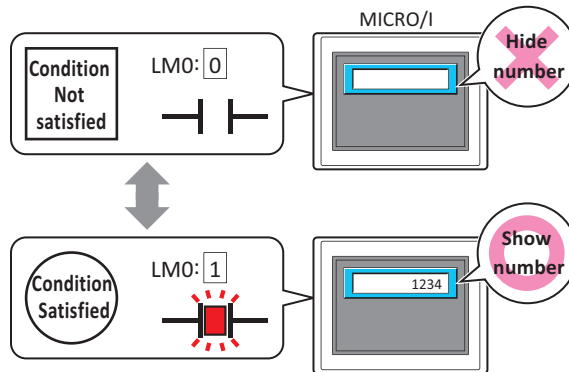

Data over does not operate for hidden Numerical Displays. Data over is reported if the minimum or maximum is exceeded when the Numerical Display changes from hidden to displayed.

■ **Trigger Type**

Selects the condition to enable the Numerical Display from the following.

Always visible: The Numerical Display is always enabled.

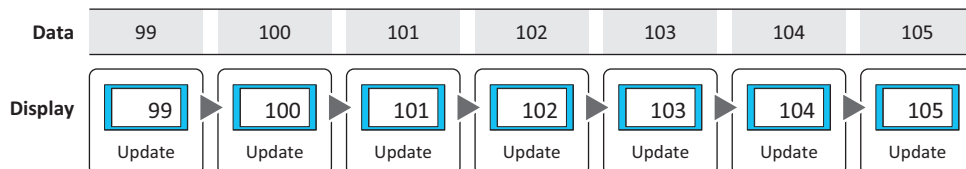

While ON: Enables the Numerical Display when the value of device address is 1.

Example: When **While not satisfying the condition** is **Not update Numerical data**

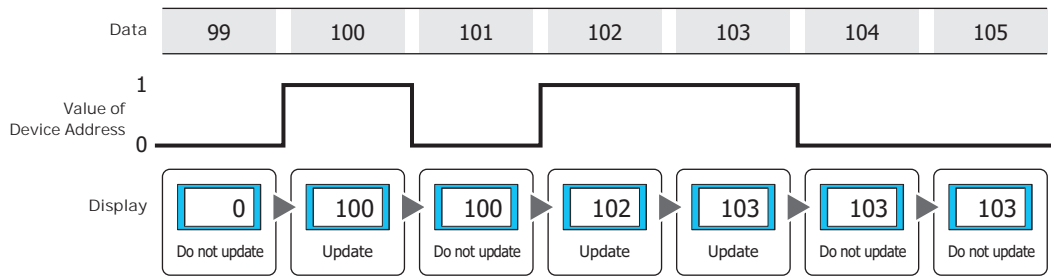

While OFF: Enables the Numerical Display when the value of device address is 0.

Example: When **While not satisfying the condition** is **Not update Numerical data**

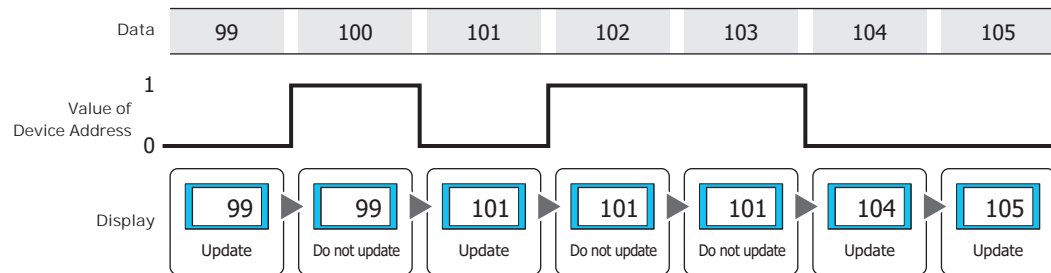

While satisfying the condition: Enables the Numerical Display when the condition is satisfied.

Example: When **While not satisfying the condition** is **Not update Numerical data**

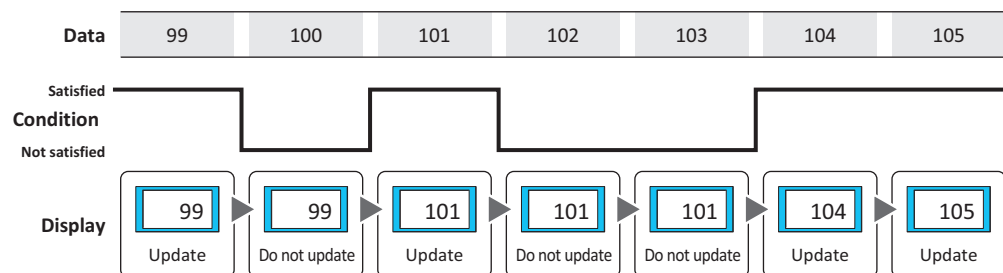

■ Data Type

Selects the data type to be handled by the condition formula.

Can only be set if **While satisfying the condition** is selected as **Trigger Type**.

For details, refer to Chapter 2 "1.1 Available Data" on page 2-1.

■ Device Address

Specifies the bit device or the bit number of the word device to serve as condition.

Can only be set if **While ON** or **While OFF** is selected as **Trigger Type**.

Click to display the Tag Editor. For the device address configuration procedure, refer to Chapter 2 "5.1 Device Address Settings" on page 2-70.

■ Condition

Sets the condition formula.

Can only be set if **While satisfying the condition** is selected as **Trigger Type**.

Click to display the **Trigger Condition Settings** dialog box. For the conditional expression configuration procedure, refer to Chapter 2 "5.2 Setting Conditional Expressions" on page 2-73.

■ Comment

Used for entering comments about trigger conditions. Maximum number is 80 characters.

■ While not satisfying the condition

Selects the operation of the Numerical Display when the condition is not satisfied.

Not display Numerical data: The plate and flange are displayed, but number is not displayed.

Not update Numerical data: The last updated number is displayed. The number does not change.

Not show Numerical Display: Hides the Numerical Display.

● Options Tab

The **Options** tab is displayed in Advanced mode.

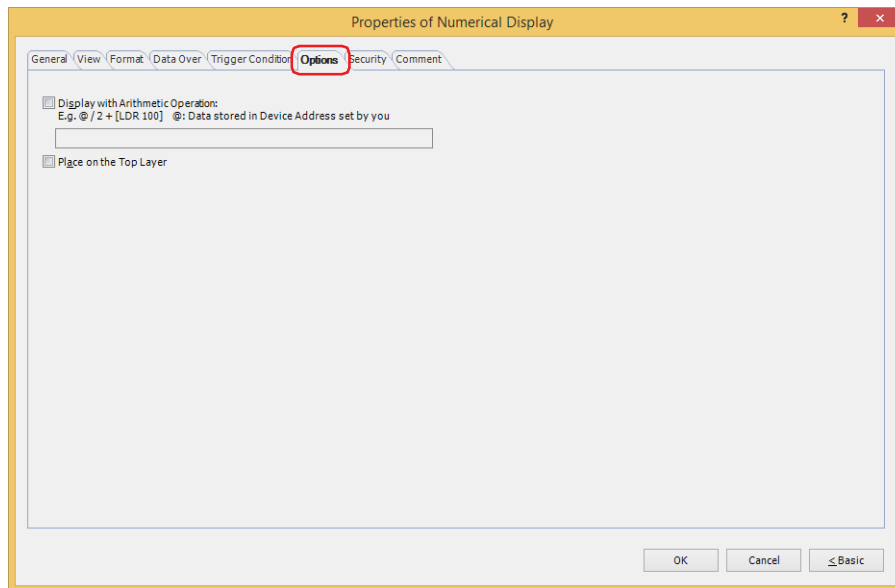

■ Display with Arithmetic Operation

To apply arithmetic operations to values of device addresses and writing the results, select this check box and input the arithmetic formula.

Example: To multiply the value of device address when displayed by 60

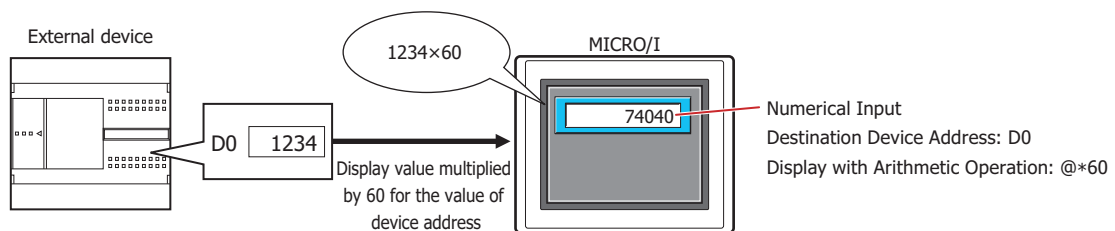

Arithmetic Formulas

Arithmetic formulas can be specified by freely combining multiple kinds of data and operators in the following format.

Data Operator Data

to

Data Operator Data Operator Data Operator Data Operator Data Operator Data ... (up to 120 characters)

- There is no limit on the number of data items or number of operators. However, the maximum number is 120 characters.
- Round brackets can be used.

Data

Item	Description
@	The device address on which the arithmetic operation is performed is specified in the arithmetic formula. Only one device address can be set for an arithmetic operation. The device address is as specified for Display Device Address under the General tab.
Value	Sets the constant values for the arithmetic formula. The values that can be set depend on the data type selected using Data Format under the General tab. For details, refer to Chapter 2 "1.1 Available Data" on page 2-1.
Device Address	Specifies the bit device or the word device for the arithmetic formula. Always enter the device address enclosed in square brackets, "[" and "] ".

Operators

Specify the type of arithmetic operation to be performed on the data. The operator priority is the same as for scripts. For details, refer to Chapter 20 "6.5 About the Priority of the Operator" on page 20-62.

Item	Description		
Arithmetic operators	Sets the arithmetic operators.		
	+	Addition	Adds <input type="text" value="a"/> and <input type="text" value="b"/> .
	-	Subtraction	Subtracts <input type="text" value="b"/> from <input type="text" value="a"/> .
	*	Multiplication	Multiplies <input type="text" value="a"/> and <input type="text" value="b"/> .
	/	Division	Divides <input type="text" value="a"/> by <input type="text" value="b"/> .
	%	Modulo	Calculates remainder after dividing <input type="text" value="a"/> by <input type="text" value="b"/> .
Bit operator	Sets the bit operator.		
	&	Logical AND	Calculates the logical product (AND) of each bit of <input type="text" value="a"/> and <input type="text" value="b"/> .
		Logical OR	Calculates the logical sum (OR) of each bit of <input type="text" value="a"/> and <input type="text" value="b"/> .
	^	Logical XOR (exclusive OR)	Calculates the exclusive logical sum (XOR) of each bit of <input type="text" value="a"/> and <input type="text" value="b"/> .
	<<	Left shift	Shifts each bit of <input type="text" value="a"/> to left by <input type="text" value="b"/> bit(s).
	>>	Right shift	Shifts each bit of <input type="text" value="a"/> to right by <input type="text" value="b"/> bit(s).

Examples of Arithmetic Formula Input

Input Examples	Description
@ + 1	To perform the arithmetic operation and input the result, add 1 to the value entered using the Keypad and write the result to the device address.
	To perform the arithmetic operation and display the result, add 1 to the value of device address and display the result.
[LDR 0] + @ + 100	To perform the arithmetic operation and input the result, add the value of LDR0 to the value entered using the Keypad and add 100, and write the result to the device address.
	To perform the arithmetic operation and display the result, add the value of LDR0 to the value of device address and add 100, then display the result.
@ & 3	To perform the arithmetic operation and input the result, write the logical product of the value entered using the Keypad and 3 to the device address.
	To perform the arithmetic operation and display the result, add 3 to the value of device address and display the result.

■ Place on the Top Layer

Select this check box to display the parts on the top layer. The parts will have precedence when other drawings and parts are overlapping with it. For details, refer to Chapter 6 "4 Drawings and Parts Overlapping" on page 6-5.

● Security Tab

This tab is used to restrict displaying and using the part by security groups.

This option can only be set when **Use Security functions** is selected. The **Use Security functions** check box is set on **General** tab in the **Security** dialog box.

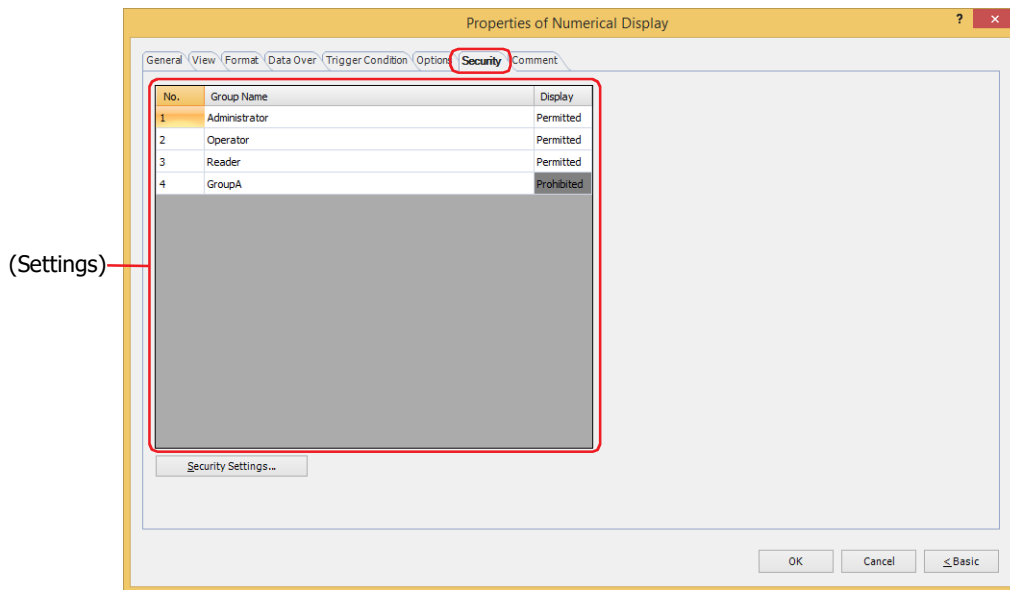

■ (Settings)

Displays the list of security groups used on the MICRO/I.

No.: Displays the security group numbers (1 to 15).

Group Name: Displays the name of the security group.

Display: Displays whether or not there is permission to display the part. Only **Permitted** security groups can display this part. If all security groups are set to **Permitted**, this part will be displayed even if no user account has been selected. Double clicking the cell switches between **Permitted** and **Prohibited**.



You can also switch between **Permitted** and **Prohibited** by right-clicking on a **Display** cell.



■ Security Settings

The Security Settings dialog box is displayed. If you create a security group in the **Security Settings** dialog box, you can select that created group. For details, refer to Chapter 23 "2.2 Adding and Editing Security Groups" on page 23-19.



For details about security functions, refer to Chapter 23 "User Accounts and the Security Function" on page 23-1.

Example: If the user and security group for a part are set as follows:

User Name	 User1	 User2
Security Group	Reader	Operator

Line Chart and Bar Chart

No.	Group Name	Display
1	Administrator	Permitted
2	Operator	Permitted
3	Reader	Prohibited

MICRO/I

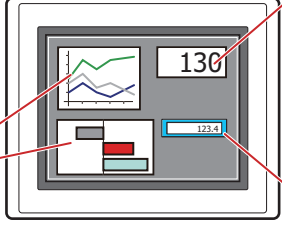

Numerical Display

No.	Group Name	Display
1	Administrator	Permitted
2	Operator	Permitted
3	Reader	Permitted

For User1 in the **Reader** security group, the parts for which **Display** has been set to **Prohibited** for **Reader** will not be displayed.

If the password screen is opened and the user switches to User2 in the **Operator** security group, the parts for which **Display** has been set to **Permitted** for **Operator** will be displayed.

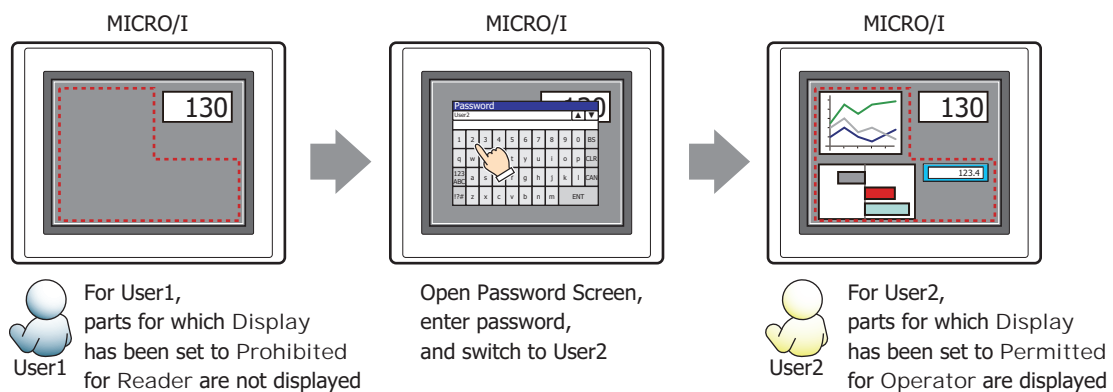

● Comment Tab

The **Comment** tab is used to specify the parts placed on the editing screen, and the popup text displayed when the mouse pointer is placed close to **No.**, **Name**, or **Type** in the object list.



When there are multiple parts of the same shape on the screen, this feature makes it possible to distinguish between the parts without displaying the Properties dialog box for each part, by just mousing over the part.

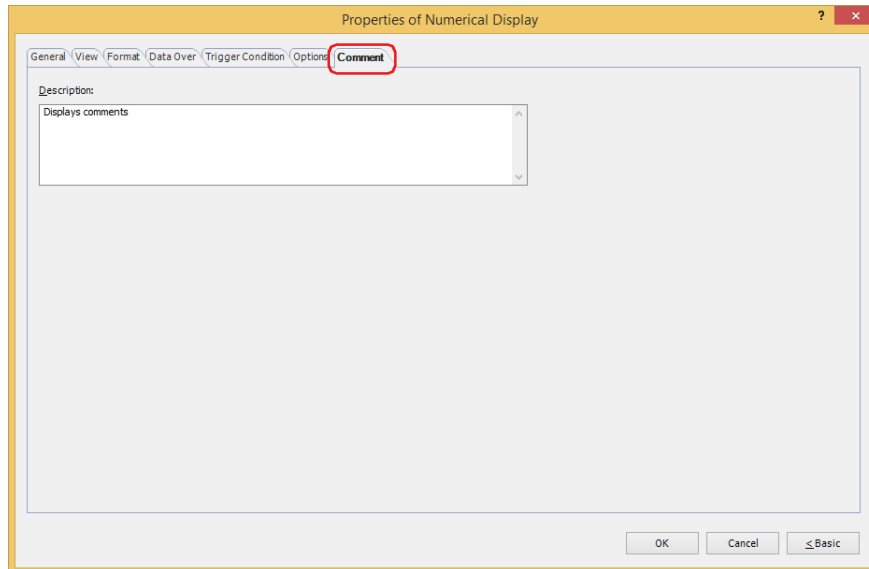

■ Description

Used for entering comments about parts. Maximum number is 80 characters.

Example: When mousing over the Numerical Display on the editing screen

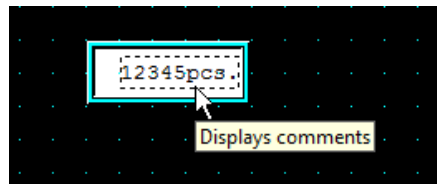

11 Calendar

HG2J-7U HG5G-V HG4G-V HG4G HG3G-V HG3G HG2G-V HG2G-5F HG2G-5T HG1G HG1P

11.1 How the Calendar is Used

The Calendar can be used to display the date and time using the MICRO/I's clock data.

- Display the date and time

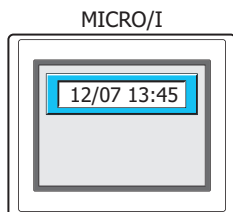

- Write 0 or 1 to a device address at the configured times

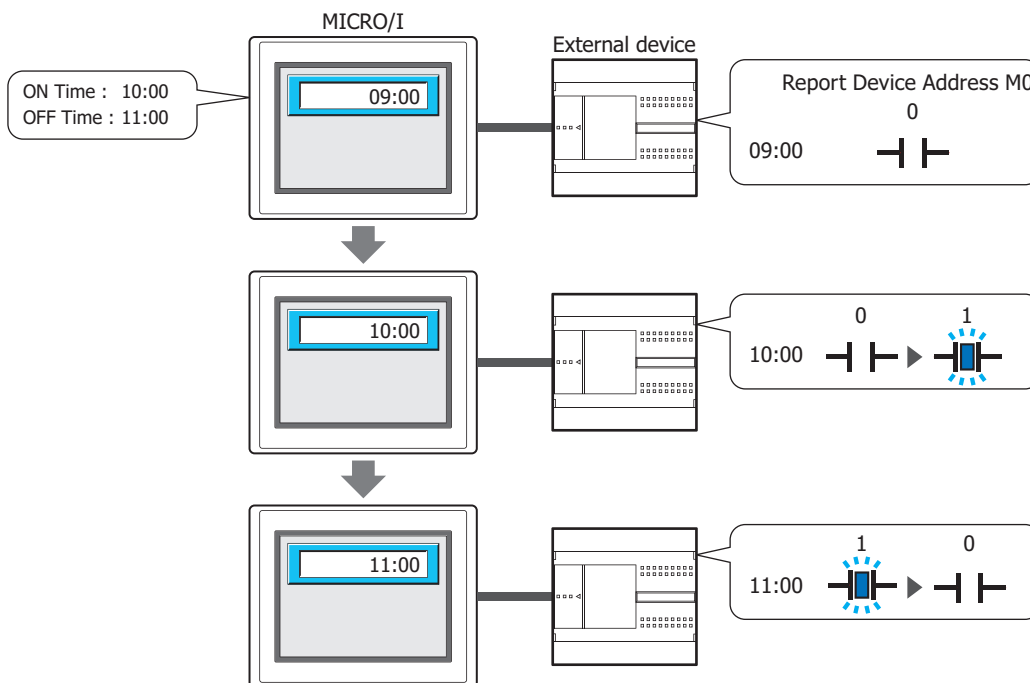

	ON Time			OFF Time	
Time	09:00	09:30	10:00	10:30	11:00
Action			Write		Write
Report Device Address M0 value	0	0	1	1	0



When **Alarm** is selected for **Calendar Type**, you can use just the alarm function without displaying the clock on the screen.

11.2 Calendar Configuration Procedure

This section describes the configuration procedure for Calendars.

- 1 On the **Home** tab, in the **Parts** group, click **Data Displays**, and then click **Calendar**.

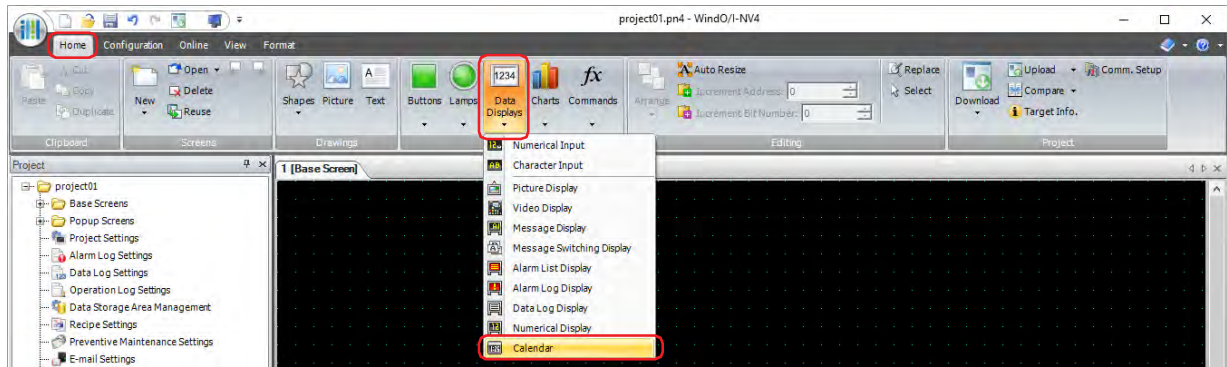

- 2 Click a point on the edit screen where you wish to place the Calendar.
- 3 Double-click the placed Calendar and a Properties dialog box will be displayed.
- 4 Change the settings on each tab as necessary.

 A screenshot of the 'Properties of Calendar' dialog box. The dialog has several tabs: General, Alarm, View, Format, Trigger Condition, Options, and Comment. The 'General' tab is selected. The 'Part Name' is 'Calendar 1'. The 'Calendar Type' is 'Clock'. There is a checkbox for 'Use Value of Device Address (UNIX Time)'. The 'Clock Type' is 'Date & Day of the Week & Time' with an example '2020/10/9 Fri. 15:00'. The 'Time Settings' section includes 'Display Format' (hh:mm), 'Separator' (hh: mm ss), 'AM Symbol' (AM), and 'PM Symbol' (PM). The 'Date Settings' section includes 'Display Format' (yyyy/MM/dd), 'Separator' (yyyy / MM / dd), 'Type' (01, 02, ..., 12), and a grid for month settings (January to December). The 'Day of the Week Settings' section includes 'Type' (Sun., Mon., ..., Sat.) and a grid for day settings (Sunday to Saturday). At the bottom are 'OK', 'Cancel', and '< Basic' buttons.

The **Trigger Condition** tab and **Options** tab only appear in Advanced mode.



You can set the default for the Calendar on the **Default Preferences** tab of the **WindO/I-NV4 Options** dialog box. For details, refer to Chapter 2 "Default Preferences Tab" on page 2-63.

11.3 Properties of Calendar Dialog Box

This section describes items and buttons on the properties dialog box.

● General Tab

■ Part Name

Enter a name for the part. The maximum number is 20 characters.

■ Calendar Type

Selects the type of Calendar from the following.

Clock: Displays the date and time.

Alarm: Notifies by writing 1 (ON Time) or 0 (OFF Time) to a device address at the configured times without displaying the date and time.

Clock & Alarm: Displays the date and time, and notifies by writing 1 (ON Time) or 0 (OFF Time) to a device address at the configured times.

Elapsed Time: Display the values of device addresses as elapsed seconds.

■ Use Value of Device Address (UNIX Time):

To consider a value of device address as UNIX time^{*1} and display it converted to date and time data, select this check box and specify the source data to display. It handles as a value whose data type is UBIN32(D). This option can only be configured when **Clock** is selected for **Calendar Type**.

Click to display the Tag Editor. For the device address configuration procedure, refer to Chapter 2 "5.1 Device Address Settings" on page 2-70.

■ Use Value of Device Address:

Specifies the source of elapsed time data to display. It handles as a value whose data type is UBIN32(D). This option can only be configured when **Elapsed Time** is selected for **Calendar Type**.

Click to display the Tag Editor. For the device address configuration procedure, refer to Chapter 2 "5.1 Device Address Settings" on page 2-70.

*1 The number of seconds elapsed since 0:00:00 on January 1, 1970 in UTC (Coordinated Universal Time). A leap second and a time zone is not considered.

■ Clock Type:

Configures the display items on Calendar. This option can only be configured when **Clock**, **Clock & Alarm** or **Elapsed Time** is selected for **Calendar Type**.

An example of the selected **Clock Type** is displayed on the right.

When **Clock** or **Clock & Alarm** is selected for **Calendar Type**, select the content to be displayed on Calendar from the following.

Date & Day of the Week & Time, **Date & Day of the Week**, **Date & Time**, **Date**, **Time & Date & Day of the Week**, **Time & Date**, **Time & Day of the Week**, **Time**, **Day of the Week & Time**, **Day of the Week**

When **Elapsed Time** is selected for **Calendar Type**, **Time** is configured.

■ Time Settings

Configures the content to be displayed as time. These options can only be configured when **Clock**, **Clock & Alarm** or **Elapsed Time** is selected for **Calendar Type**.

Display Format: Configures the time display format.

When **Clock** or **Clock & Alarm** is selected for **Calendar Type**, selects the time display format from the following:

hh:mm, **hh:mm tt**, **tt hh:mm**, **hh:mm:ss**, **hh:mm:ss tt**, **tt hh:mm:ss**

(h: hour, m: minute, s: second t: A.M. or P.M.)

When **Elapsed Time** is selected for **Calendar Type**, selects the time display format from the following:

dd:hh:mm:ss, **h:mm:ss**, **hh:mm:ss**, **hhh:mm:ss**, **hhhh:mm:ss**, **dd:hh:mm**, **h:mm**, **hh:mm**, **hhh:mm**, **hhhh:mm** (d: day, h: hour, m: minute, s: second)

Separator: Configures the symbol that separates the hour, minute, and second data. The maximum number is 10 characters.

When **Font** on **View** tab is **7-segment**, 0 to 9 (number), (space), *(asterisk), +(plus), -(hyphen), .(Period), /(slash) and :(colon) can be used.

AM Symbol: Configures the symbol to indicate the morning. The maximum number is 10 characters. This option can only be configured when an item that includes t is selected for **Display Format**.

When **Font** on **View** tab is **7-segment**, 0 to 9 (number), (space), *(asterisk), +(plus), -(hyphen), .(Period), /(slash) and :(colon) can be used.

PM Symbol: Configures the symbol to indicate the afternoon. The maximum number is 10 characters. This option can only be configured when an item that includes t is selected for **Display Format**.

When **Font** on **View** tab is **7-segment**, 0 to 9 (number), (space), *(asterisk), +(plus), -(hyphen), .(Period), /(slash) and :(colon) can be used.

■ Date Settings

Configures the content to be displayed as a date. These options can only be configured when **Clock** or **Clock & Alarm** is selected for **Calendar Type** and **Date & Day of the Week & Time**, **Date & Day of the Week**, **Date & Time**, **Date**, **Time & Date & Day of the Week** or **Time & Date** is selected for **Clock Type**.

Display Format: Select the date display format from the following:

yyyy/MM/dd, **MM/dd/yyyy**, **dd/MM/yyyy**, **yy/MM/dd**, **MM/dd/yy**, **dd/MM/yy**, **MM/dd**, **dd/MM** (y: year, M: month, d: day)

Separator: Configures the symbol that separates the year, month, and day data. The maximum number is 10 characters.

When **Font** on **View** tab is **7-segment**, 0 to 9 (number), (space), *(asterisk), +(plus), -(hyphen), .(Period), /(slash) and :(colon) can be used.

Type: Selects the string to indicate month from the following:

01, **02**, ..., **12**, **Jan.**, **Feb.**, ..., **Dec.**, **January**, **February**, ..., **December**, **Customize**

When **Customize** is selected, configures the string to indicate month. The maximum number is 10 characters.

■ Day of the Week Settings

Configures the content to be displayed as the day of the week. These options can only be configured when **Clock** or **Clock & Alarm** is selected for **Calendar Type** and **Date & Day of the Week & Time**, **Date & Day of the Week**, **Time & Date & Day of the Week**, **Time & Day of the Week**, **Day of the Week & Time** or **Day of the Week** is selected for **Clock Type**.

Type: Selects the string to indicate the day of the week from the following:

(日), (月), ..., (土), Sun., Mon., ..., Sat., Sunday, Monday, ..., Saturday,
星期日, 星期一, ..., 星期六, **Customize**

When **Customize** is selected, configures the string to indicate the day of the week. The maximum number is 10 characters.

● Alarm Tab

These options can only be configured when **Alarm** or **Clock & Alarm** is selected for **Calendar Type** on the **General** tab.

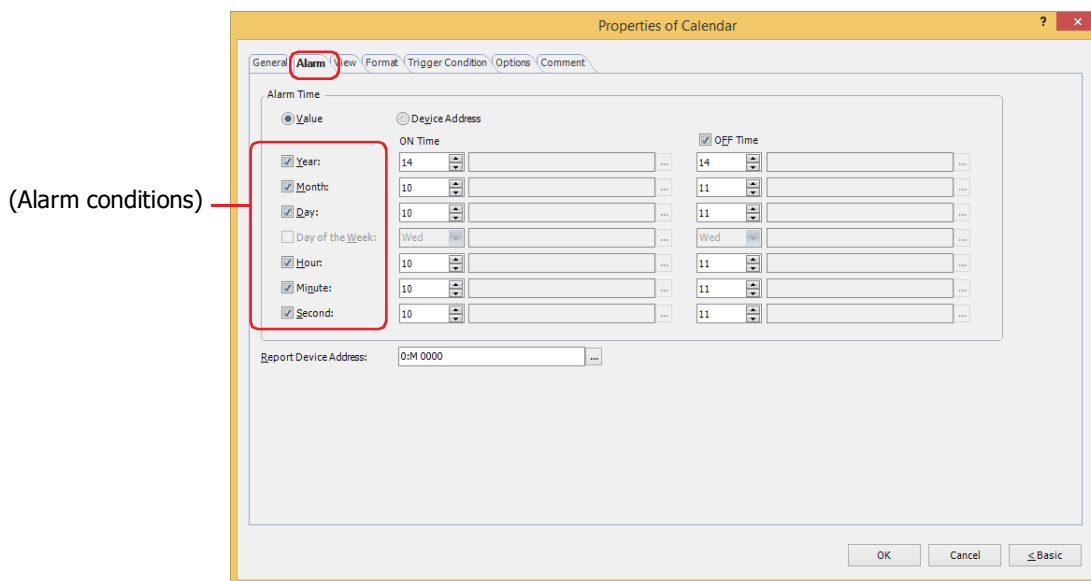

■ Alarm Time

Selects the type of data for the alarm time.

Value: Specifies the alarm time as values and the day of the week.

Year: Enter the year (0 to 99).

Month: Enter the month (1 to 12).

Day: Enter the day (1 to 31).

Day of the Week: Select the day of the week.

Hour: Enter the hour (0 to 23).

Minute: Enter the minute (0 to 59).

Second: Enter the second (0 to 59).

Device Address: Configures the alarm time as values of word devices. It handles as a value whose data type is BCD4(B). Configures the year, month, day, hour, minute, and second values in the same range as **Value**. Specifies the day of the week with the following values. 0: Sunday, 1: Monday, 2: Tuesday, 3: Wednesday, 4: Thursday, 5: Friday, 6: Saturday. Click to display the Tag Editor. For the device address configuration procedure, refer to Chapter 2 "5.1 Device Address Settings" on page 2-70.



If the data of the alarm time is invalid, 1 is written to System Area 2 Processing error bit (address number+2, bit 5), and an error message is displayed. For details, refer to Chapter 4 "Processing error" on page 4-32 and Chapter 36 "Processing error" on page 36-3.

An error occurs in the following states:

- **Year, Month, Day, Hour, Minute** or **Second** are set to values outside the range of **Value**.
- A value outside the range of BCD4(B) is entered.

■ **(Alarm conditions)**

Select the check boxes for the conditions to use as the alarm time.

The **Day of the Week** check box can only be configured when the **Year** check box is cleared.

■ **ON Time**

Configures the time to write 1 to the Report Device Address according to the type of data.



- After 1 is written to the Report Device Address with **ON Time**, that value is retained.

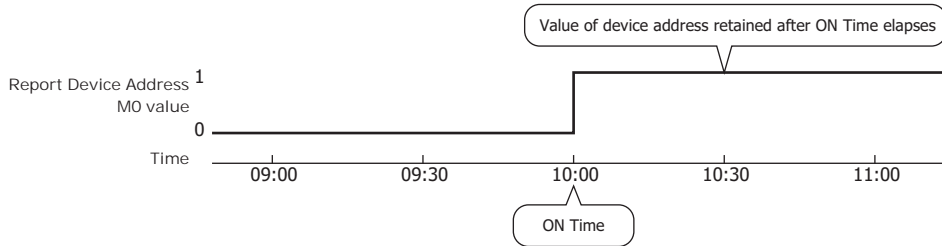

- After a screen configured with the Calendar is displayed, if the time is in between **ON Time** and **OFF Time**, 1 is written to the Report Device Address.

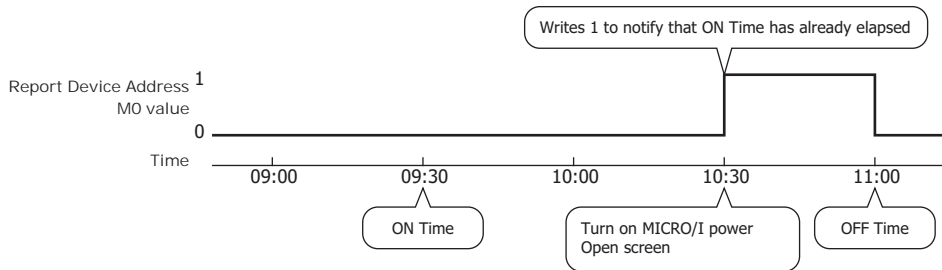

■ **OFF Time**

Select this check box to configure the time to write 0 to the Report Device Address.

The time is configured according to the type of data.



- The value of Report Device Address is retained even when the current time exceeds **OFF Time**.

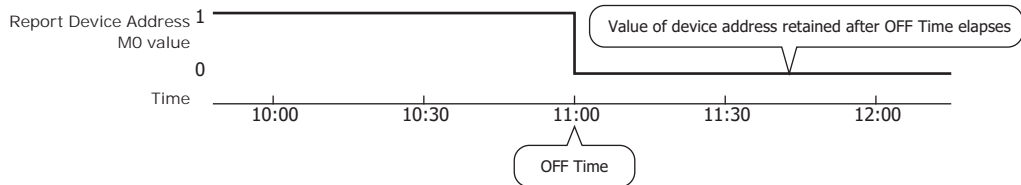

- After a screen configured with the Calendar is displayed, if the time exceeds **OFF Time**, 0 is written to the Report Device Address.

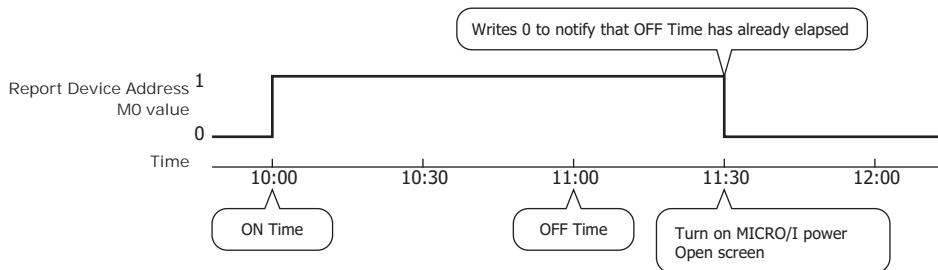

■ **Report Device Address**

Specifies the bit device to write the value to at **ON Time** and **OFF Time**.

Click to display the Tag Editor. For the device address configuration procedure, refer to Chapter 2 "5.1 Device Address Settings" on page 2-70.

● **View Tab**

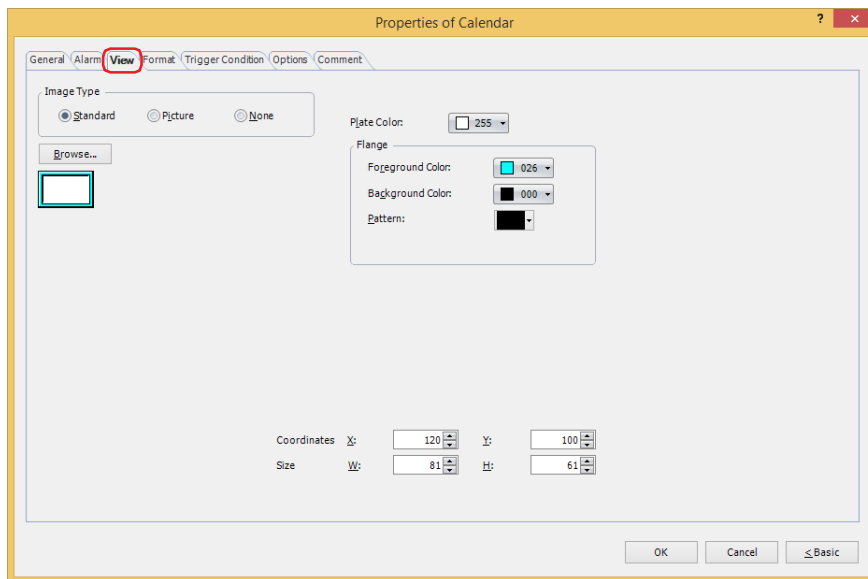

■ **Image Type**

Select the type of graphic to be used to represent the part.

Standard: Uses the default graphic for WindO/I-NV4.

Picture: Uses an image file saved using Picture Manager.

For details about image file restrictions, refer to Chapter 2 "1.4 Available Image Files" on page 2-20.

None: The plate and the flange of the part are not displayed. Only the text is displayed.

■ **Browse**

Select the type of graphic to be used to represent the part from the list of graphics. Click this button to display the View Browser or Picture Manager, depending on the setting for **Image Type**.

■ **Plate Color**

Selects the plate color of the standard graphic (color: 256 colors, monochrome: 16 shades).

Click **Color** to display the Color Palette. Select a color from the Color Palette.

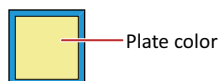

■ **Flange**

Foreground Color, Background Color:

Selects the foreground and background colors of the flange of the standard graphic (color: 256 colors, monochrome: 16 shades).

Click **Color** to display the Color Palette. Select a color from the Color Palette.

Pattern: Selects a pattern for the flange of the standard graphic.

Click **Pattern** to display the Pattern Palette. Select a pattern from the Pattern Palette.

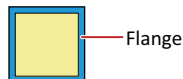

■ Coordinates

- X, Y: Sets the display position of parts using coordinates.
The X and Y coordinates of parts is defined relative to an origin at the top-left corner of the screen.
- X: 0 to (base screen horizontal size - 1)
- Y: 0 to (base screen vertical size - 1)

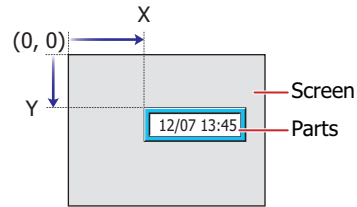

■ Size

- W, H: Sets width and height to define the size of parts.
- W: 5 to (base screen horizontal size)
- H: 5 to (base screen vertical size)

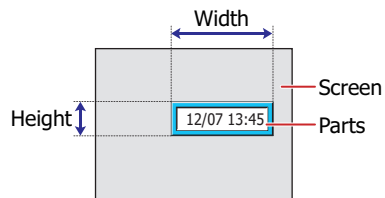

● **Format Tab**

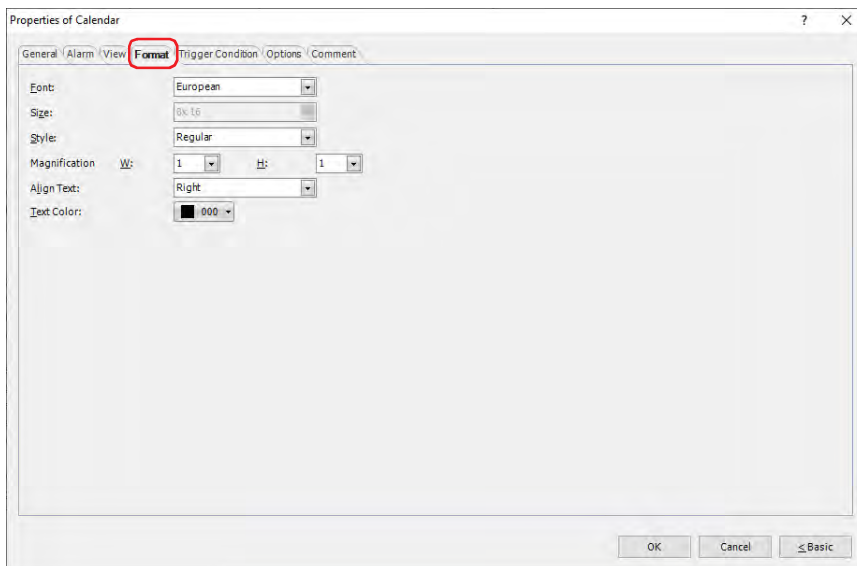

■ **Font**

Selects the font used for displaying text from the following.

Western, Japanese, Simplified Chinese, Traditional Chinese, Hangul, Central European, Baltic, Cyrillic, Stroke*1, 7-Segment

7-Segment can only be configured when **Date & Time, Date, Time & Date** or **Time** is selected for **Clock Type** on the **General** tab. The characters that can be displayed depend on the font. For details, refer to Chapter 2 "1.2 Available Text" on page 2-6.

■ **Size**

Specifies the text size to be displayed. The fonts and sizes that can be set vary based on the model.

Model	Font	Size
HG2J-7U	Western, Japanese, Simplified Chinese, Traditional Chinese, Hangul, Central European, Baltic, Cyrillic, 7-Segment	8 to 512
HG5G/4G/3G/2G-V, HG4G/3G, HG2G-5F/-5T, HG1G/1P	Japanese, Simplified Chinese, Traditional Chinese, Hangul	8x16, 16x16
	Stroke, 7-Segment	8 to 128



When **Japanese, Simplified Chinese, Traditional Chinese, Hangul** is selected for **Font**, regardless of the **Size** setting, the single-byte characters in the following text boxes are displayed with 8x16 and the double-byte characters are displayed with 16x16.

- **Time Settings: Separator, AM Symbol, PM Symbol**
- **Date Settings: Separator, Type**
- **Day of the Week Settings: Type**

■ **Style*1**

Selects **Regular** or **Bold** for text style.

Can only be set when **Western, Japanese, Simplified Chinese, Traditional Chinese, Hangul, Central European, Baltic, Cyrillic** is selected for **Font**.

■ **Magnification*1**

W, H: Selects text magnification (0.5, 1 to 8).

Can only be set when **Western, Japanese, Simplified Chinese, Traditional Chinese, Hangul, Central European, Baltic, Cyrillic** is selected for **Font**.

*1 HG5G/4G/3G/2G-V, HG4G/3G, HG2G-5F/-5T, HG1G/1P only

- **Align Text**

Selects the text alignment in the horizontal direction from the following.

- **Left, Center, Right**

For details, refer to Appendix "5 Text Alignment" on page A-7.

- **Text Color**

Selects the color of displayed text (color: 256 colors, monochrome: 16 shades).

Click **Color** to display the Color Palette. Select a color from the Color Palette.

● **Trigger Condition Tab**

The **Trigger Condition** tab is displayed in Advanced mode.

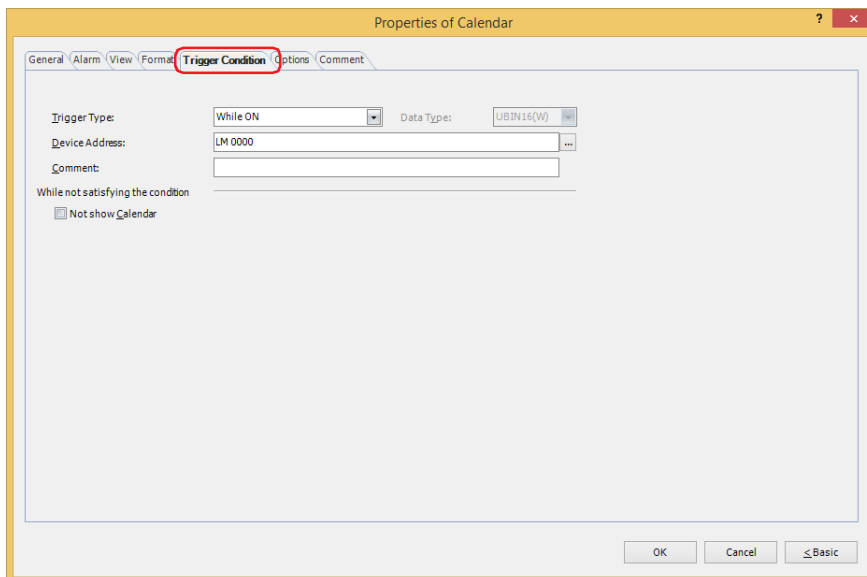

The Calendar is enabled while the condition is satisfied, and it is disabled while the condition is not satisfied. When disabled, the plate and flange are displayed, but the time is not displayed. However, if the **Not show Calendar** check box under **While not satisfying the condition** is selected, the plate and flange are also hidden and the part image is not displayed.

Example: When **Trigger Type** is **While ON**, **Device Address** is **LM0**, and the **Not show Calendar** check box under **While not satisfying the condition** is cleared
 While LM0 is 0, the condition is not satisfied and the Calendar does not display the time.
 While LM0 is 1, the condition is satisfied and the Calendar displays the time.

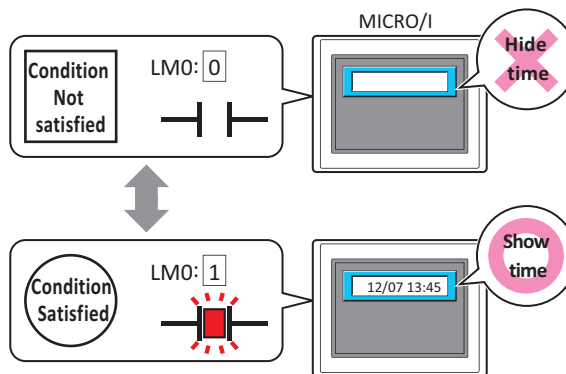

■ **Trigger Type**

Selects the condition to enable the Calendar from the following.

Always visible: The Calendar is always enabled.

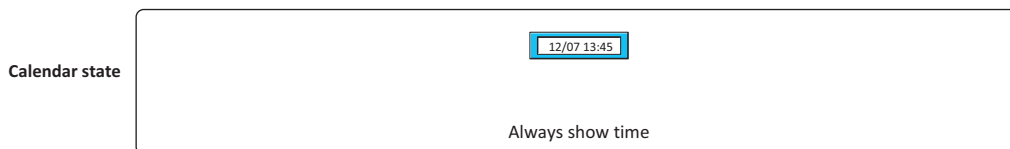

While ON: Enables the Calendar when the value of device address is 1.
 Example: When the **Not show Calendar** check box is cleared under **While not satisfying the condition**

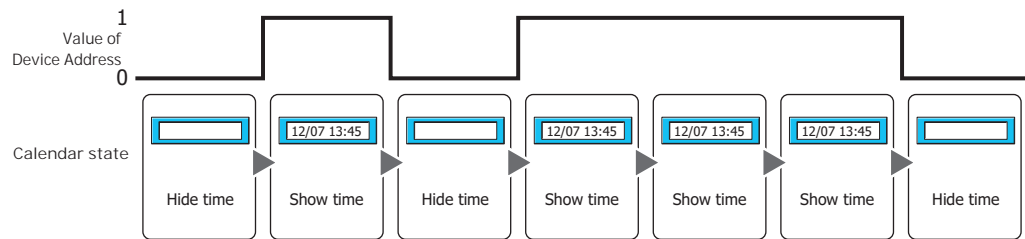

While OFF: Enables the Calendar when the value of device address is 0.
 Example: When the **Not show Calendar** check box is cleared under **While not satisfying the condition**

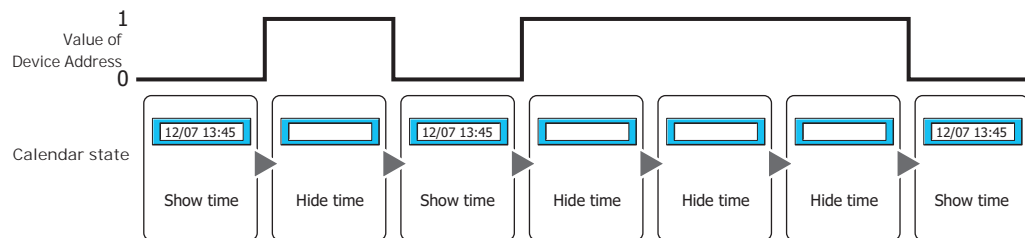

While satisfying the condition:

Enables the Calendar when the condition is satisfied.
 Example: When the **Not show Calendar** check box is cleared under **While not satisfying the condition**

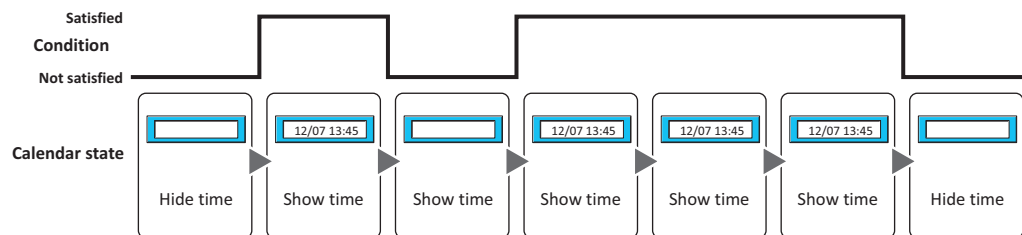

■ Data Type

Selects the data type to be handled by the condition formula.
 Can only be set if **While satisfying the condition** is selected as **Trigger Type**.
 For details, refer to Chapter 2 "1.1 Available Data" on page 2-1.

■ Device Address

Specifies the bit device or the bit number of the word device to serve as condition.
 Can only be set if **While ON** or **While OFF** is selected as **Trigger Type**.

Click to display the Tag Editor. For the device address configuration procedure, refer to Chapter 2 "5.1 Device Address Settings" on page 2-70.

■ Condition

Sets the condition formula.
 Can only be set if **While satisfying the condition** is selected as **Trigger Type**.

Click to display the **Trigger Condition Settings** dialog box. For the conditional expression configuration procedure, refer to Chapter 2 "5.2 Setting Conditional Expressions" on page 2-73.

■ Comment

Used for entering comments about trigger conditions. Maximum number is 80 characters.

■ Not show Calendar

When this check box is cleared, the part image is not displayed when the condition is not satisfied.

● Options Tab

The **Options** tab is displayed in Advanced mode.

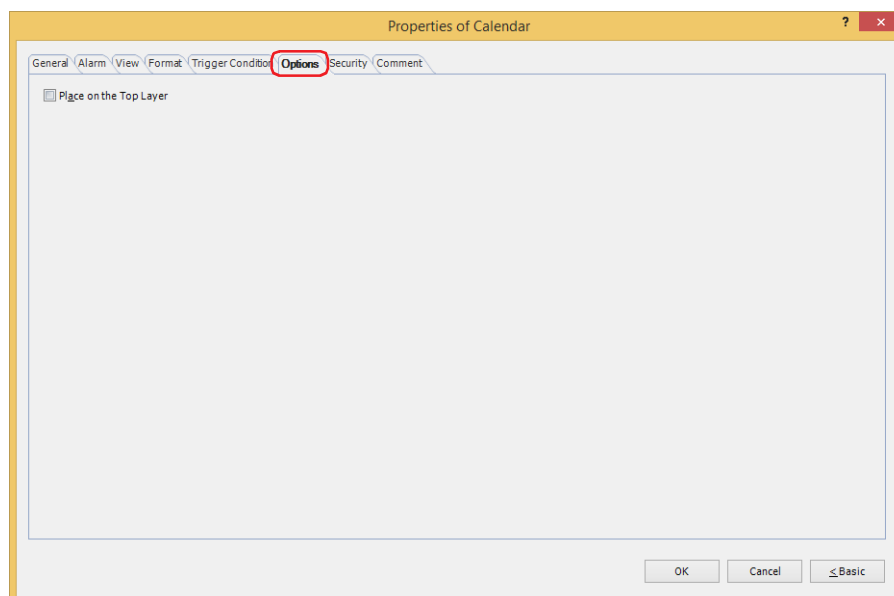

■ Place on the Top Layer

Select this check box to place the parts on the top layer. When drawings and parts overlap, those place on the top layer are displayed in preference. For details, refer to Chapter 6 "4 Drawings and Parts Overlapping" on page 6-5.

● Security Tab

This tab is used to restrict displaying and using the part by security groups.

This option can only be set when **Use Security functions** is selected. The **Use Security functions** check box is set on **General** tab in the **Security** dialog box.

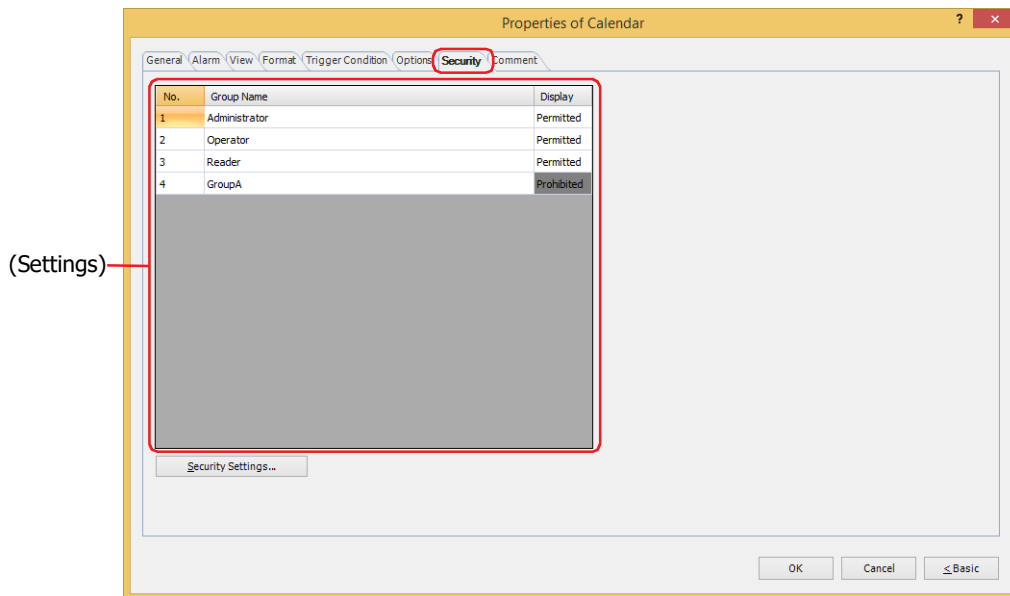

■ (Settings)

Displays the list of security groups used on the MICRO/I.

No.: Displays the security group numbers (1 to 15).

Group Name: Displays the name of the security group.

Display: Displays whether or not there is permission to display the part. Only **Permitted** security groups can display this part. If all security groups are set to **Permitted**, this part will be displayed even if no user account has been selected. Double clicking the cell switches between **Permitted** and **Prohibited**.



You can also switch between **Permitted** and **Prohibited** by right-clicking on a **Display** cell.



■ Security Settings

The Security Settings dialog box is displayed. If you create a security group in the **Security Settings** dialog box, you can select that created group. For details, refer to Chapter 23 "2.2 Adding and Editing Security Groups" on page 23-19.



For details about security functions, refer to Chapter 23 "User Accounts and the Security Function" on page 23-1.

Example: If the user and security group for a part are set as follows:

User Name	 User1	 User2
Security Group	Reader	Operator

Line Chart and Bar Chart

No.	Group Name	Display
1	Administrator	Permitted
2	Operator	Permitted
3	Reader	Prohibited

MICRO/I

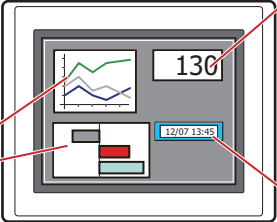

Numerical Display

No.	Group Name	Display
1	Administrator	Permitted
2	Operator	Permitted
3	Reader	Permitted

Calendar

No.	Group Name	Display
1	Administrator	Permitted
2	Operator	Permitted
3	Reader	Prohibited

For User1 in the **Reader** security group, the parts for which **Display** has been set to **Prohibited** for **Reader** will not be displayed.

If the password screen is opened and the user switches to User2 in the **Operator** security group, the parts for which **Display** has been set to **Permitted** for **Operator** will be displayed.

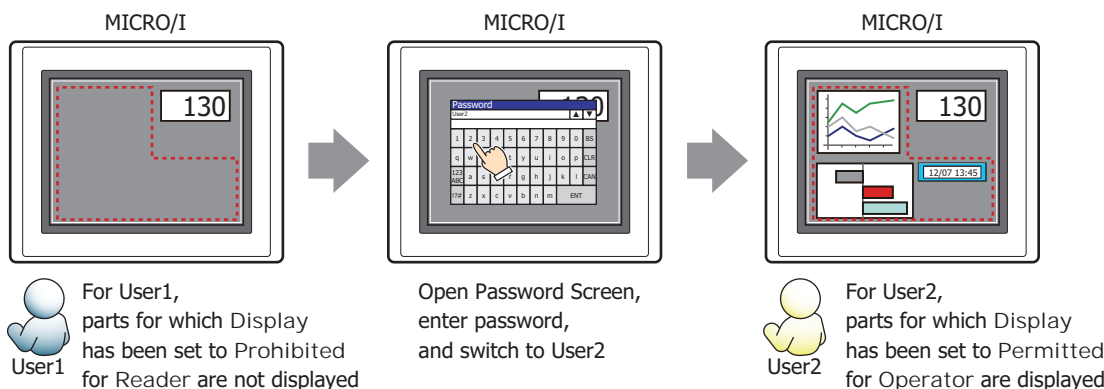

● Comment Tab

The **Comment** tab is used to specify the parts placed on the editing screen, and the popup text displayed when the mouse pointer is placed close to **No.**, **Name**, or **Type** in the object list.



When there are multiple parts of the same shape on the screen, this feature makes it possible to distinguish between the parts without displaying the Properties dialog box for each part, by just mousing over the part.

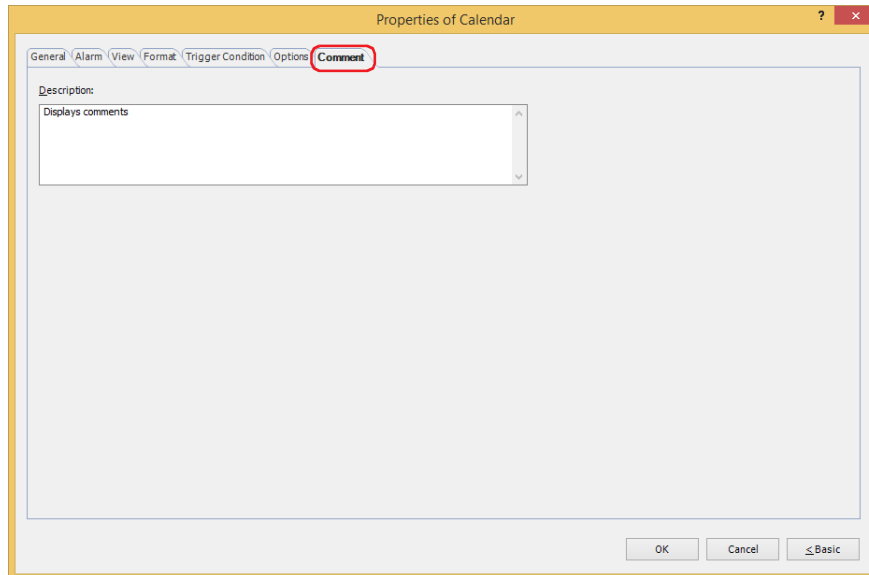

■ Description

Used for entering comments about parts. Maximum number is 80 characters.

Example: When mousing over the Calendar on the editing screen

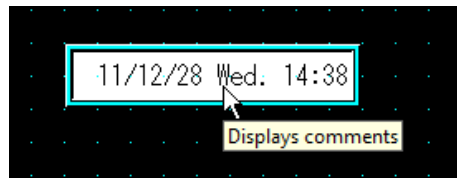

Chapter 11 Charts

This chapter describes how to configure charts and meters and their operation on the MICRO/I.

1 Bar Chart

HG2J-7U HG5G-V HG4G-V HG4G HG3G-V HG3G HG2G-V HG2G-5F HG2G-5T HG1G HG1P

1.1 How the Bar Chart is Used

Bar charts and peak charts can be used to display word device values.

- Display word device values in a bar chart

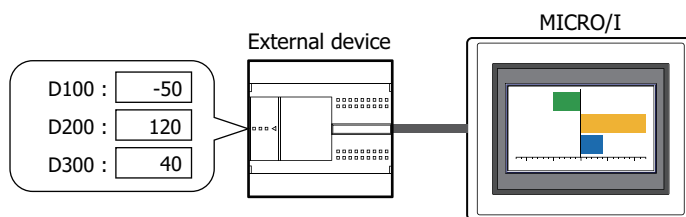

- Display word device values in a peak chart

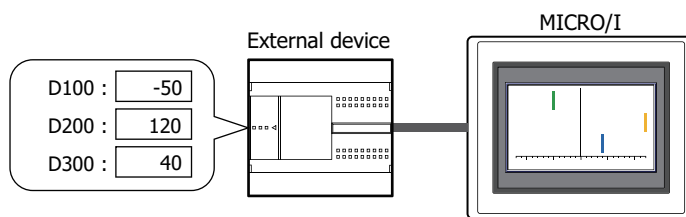

- Make the chart flash when the displayed data exceeds the maximum or minimum

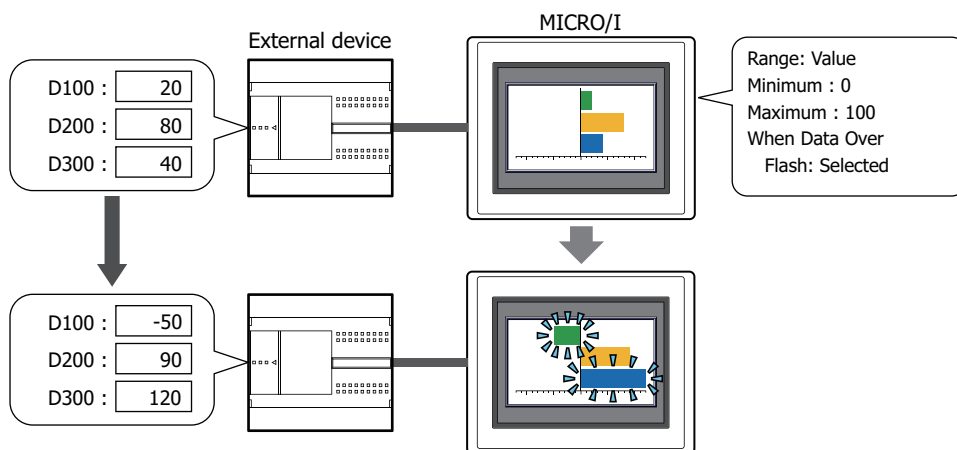

1.2 Bar Chart Configuration Procedure

This section describes the configuration procedure for bar charts.

- 1 On the **Home** tab, in the **Parts** group, click **Charts**, and then click **Bar Chart**.

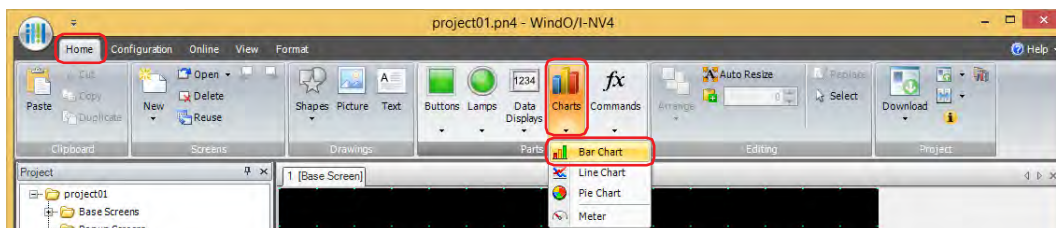

- 2 Click a point on the edit screen where you wish to place the Bar Chart.
- 3 Double-click the placed Bar Chart and a Properties dialog box will be displayed.
- 4 Change the settings on each tab as necessary.

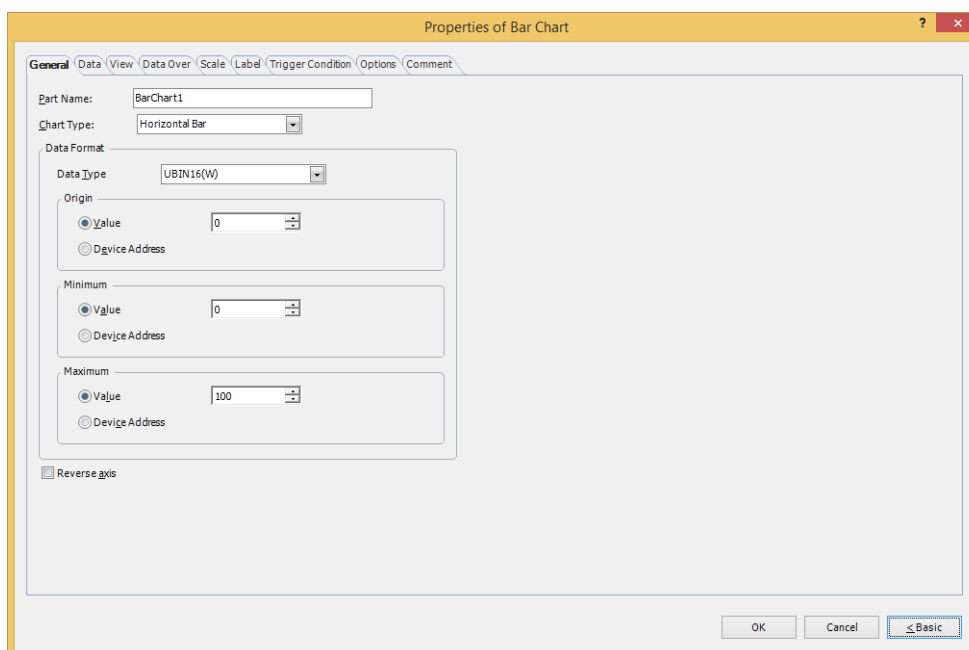

The **Data Over** tab, **Scale** tab, **Label** tab, **Trigger Condition** tab and **Options** tab only appear in Advanced mode.



You can set the default for the Bar Chart on the **Default Preferences** tab of the **WindO/I-NV4 Options** dialog box. For details, refer to Chapter 2 "Default Preferences Tab" on page 2-63.

1.3 Properties of Bar Chart Dialog Box

This section describes items and buttons in the Properties dialog box.

● **General Tab**

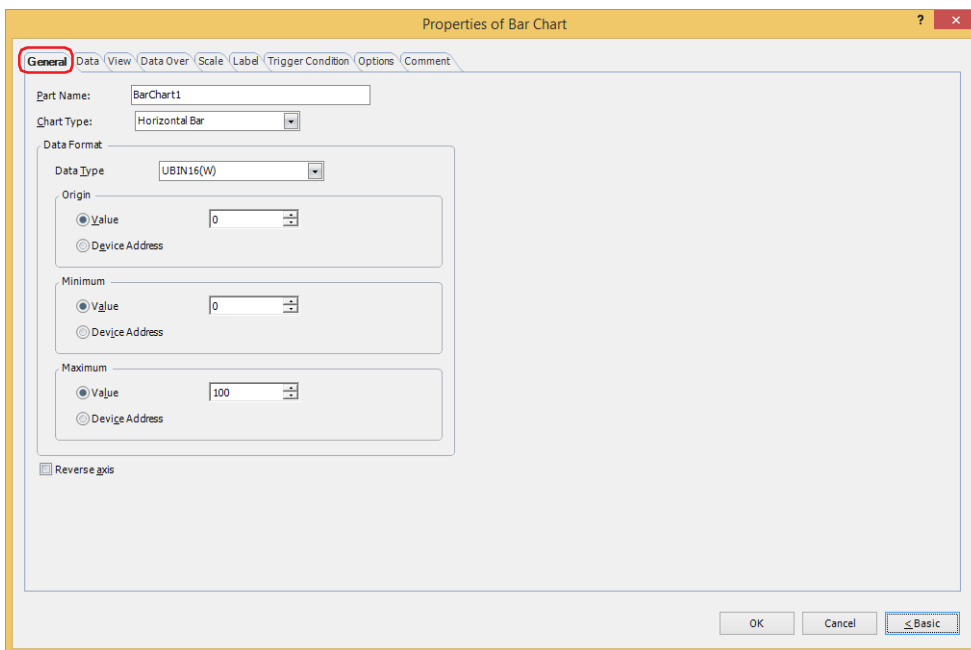

■ **Part Name**

Enter a name for the part. The maximum number is 20 characters.

■ **Chart Type**

Selects the type of chart from the following items.

Horizontal Bar, Vertical Bar, Horizontal Peak, Vertical Peak

Peak charts only display the tip of the bar chart.

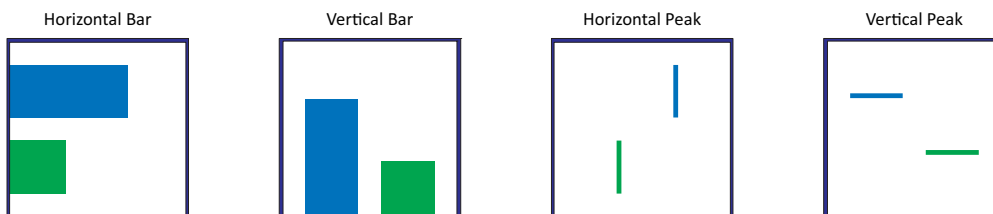

■ **Data Format**

Data Type: Selects the data type handled by the chart from the following.
UBIN16(W), BIN16(I), UBIN32(D), BIN32(L), BCD4(B), BCD8(EB), Float32(F)
 For details, refer to Chapter 2 "1.1 Available Data" on page 2-1.

Origin, Minimum, Maximum: Specifies the origin, minimum, and maximum for the chart.
 (Data Type)^{*1}: Selects the data type to use for the **Origin, Minimum, and Maximum.**

Value: Uses a constant value.

Device Address: Uses a value of device address.

The origin, minimum, and maximum that can be specified during Basic mode and when **Value** is selected vary based on the data type. For details, refer to Chapter 2 "1.1 Available Data" on page 2-1.

When **Device Address** is selected, these options specify the source word devices.

Click  to display the Tag Editor. For the device address configuration procedure, refer to Chapter 2 "5.1 Device Address Settings" on page 2-70.



If the data displayed in the chart is invalid, 1 is written to System Area 2 Processing error bit (address number+2, bit 5), and an error message is displayed. For details, refer to Chapter 4 "Processing error" on page 4-32 and Chapter 36 "Processing error" on page 36-3.

An error occurs in the following states:

- The setting of **Origin, Minimum, or Maximum** are invalid, or the **Minimum** and **Maximum** are the same values.
- **Data Type** is **BCD4(B), BCD8(EB), or Float32(F)** and the value cannot be expressed with the data type selected for the read data

The chart cannot be displayed when an error has occurred.



Even if the value of device address is changed while the trigger condition is not satisfied, the minimum and maximum are not updated.

■ **Reverse axis**

Select this check box to flip the axis of the graph.

Horizontal chart (**Horizontal Bar, Horizontal Peak**):

Check box: Cleared

Check box: Selected

Direction of graph: From left to right

Direction of graph: From right to left

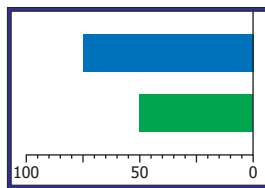
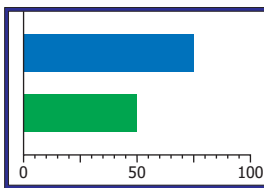

Vertical chart (**Vertical Bar, Vertical Peak**):

Check box: Cleared

Check box: Selected

Direction of graph: From bottom to top

Direction of graph: From top to bottom

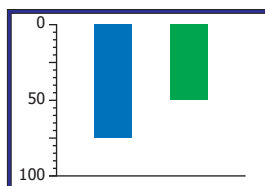
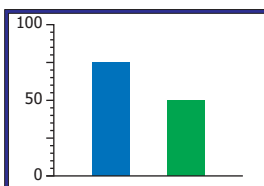

*1 Advanced mode only

● Data Tab

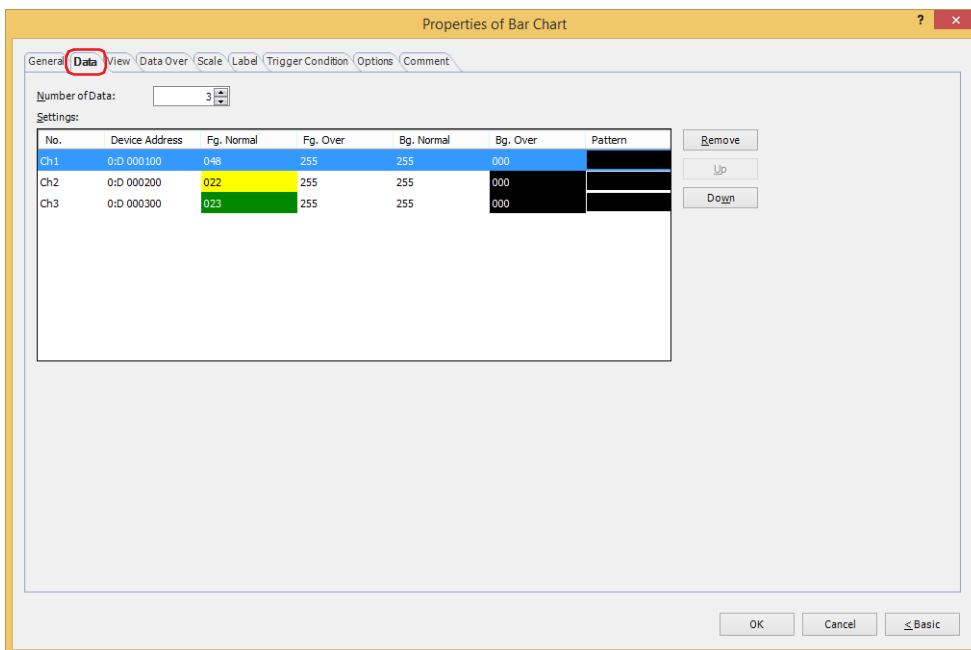

■ Number of Data

Specifies the number of data to be displayed in the chart(1 to 10).

■ Settings

Lists the chart settings. The list shows the numbers, source device addresses, and colors for the chart.

No.: Shows the numbers for the chart (Ch1 to Ch10).
 For **Horizontal Bar** and **Horizontal Peak**, the numbers are listed in order from top. For **Vertical Bar** and **Vertical Peak**, the numbers are listed in order from the left.

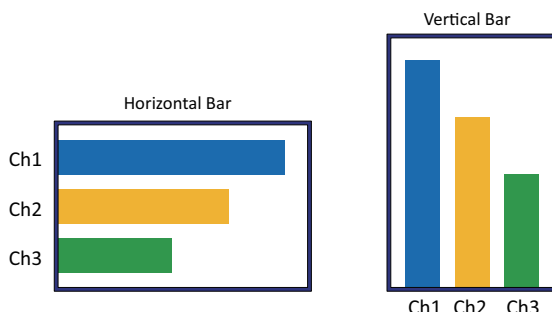

- Device Address: Specifies the source word device for the data to display in the chart.
 Double clicking the cell displays the Tag Editor where you can edit the device address. For the device address configuration procedure, refer to Chapter 2 "5.1 Device Address Settings" on page 2-70
- Fg. Normal: Selects the foreground color of the chart when normal. (color: 256 colors, monochrome: 16 shades)
 Double clicking the cell displays the Color Palette where you can change the foreground color of the chart when normal.
- Fg. Over*1: Selects the foreground color of the chart when data over. (color: 256 colors, monochrome: 16 shades)
 Double clicking the cell displays the Color Palette where you can change the foreground color of the chart when data over.

*1 Advanced mode only

- Bg. Normal:** Selects the background color of the chart when normal. (color: 256 colors, monochrome: 16 shades)
Double clicking the cell displays the Color Palette where you can change the background color of the chart when normal.
- Bg. Over^{*1}:** Selects the background color of the chart when data over. (color: 256 colors, monochrome: 16 shades)
Double clicking the cell displays the Color Palette where you can change the background color of the chart when data over.
- Pattern:** Selects the chart pattern or tonal gradation.
Double clicking the cell displays the Pattern Palette where you can change the chart pattern or tonal gradation.

■ **Remove**

Deletes the registered settings from the list.

■ **Up**

Shifts the selected settings upward in the list.

■ **Down**

Shifts the selected settings downward in the list.

*1 Advanced mode only

● **View Tab**

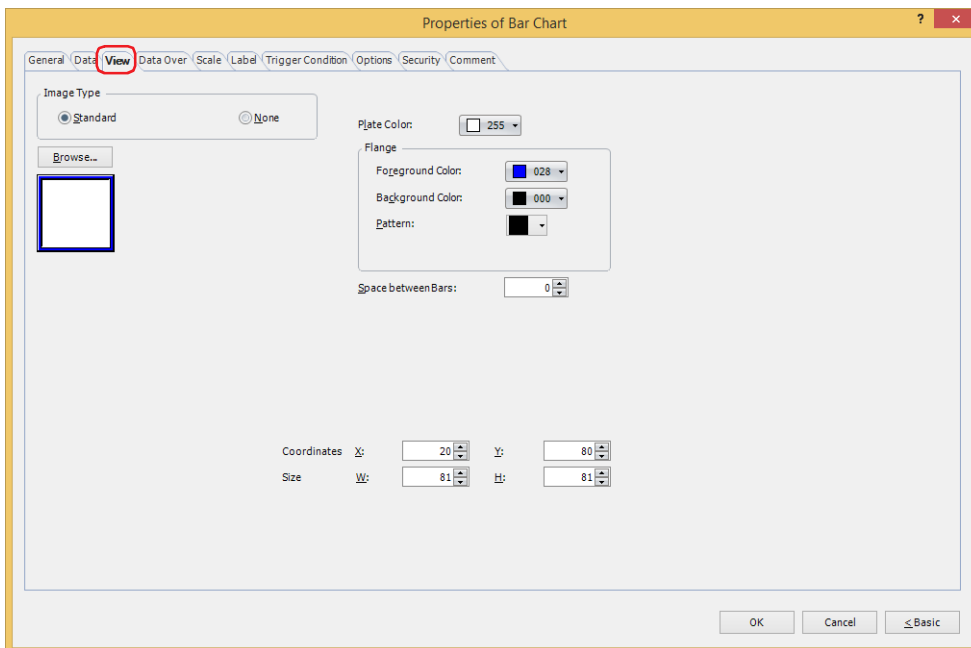

■ **Image Type**

Select the type of graphic to be used to represent the part.

Standard: Uses the default graphic for WindO/I-NV4.

None: The plate and the flange of the part are not displayed.

■ **Browse**

Select the type of graphic to be used to represent the part from the list of graphics. Click this button to display the View Browser.

■ **Plate Color**

Selects the plate color of the standard graphic (color: 256 colors, monochrome: 16 shades).

Click **Color** to display the Color Palette. Select a color from the Color Palette.

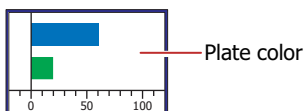

■ **Flange**

Foreground Color, Background Color: Selects the foreground and background colors of the flange of the standard graphic (color: 256 colors, monochrome: 16 shades).

Click **Color** to display the Color Palette. Select a color from the Color Palette.

Pattern:

Selects a pattern for the flange of the standard graphic.

Click **Pattern** to display the Pattern Palette. Select a pattern from the Pattern Palette.

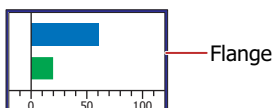

■ **Space between Bars** *1

Specifies the spacing for the bar chart (0 to 100 dots).

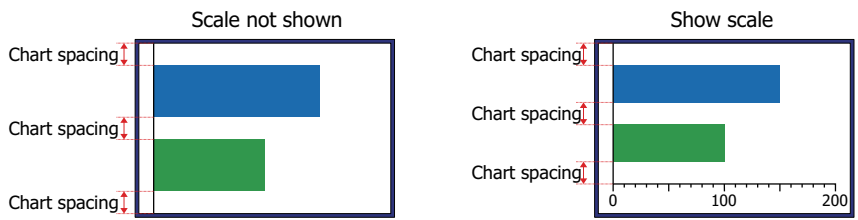

Example: If **Space between Bars** is 10

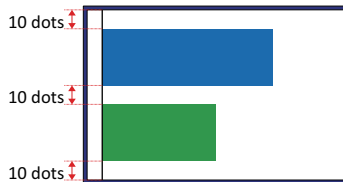

If **Space between Bars** is 0



■ **Coordinates**

X, Y: Sets the display position of parts using coordinates.

The X and Y coordinates of parts are defined relative to an origin at the top-left corner of the screen.

X: 0 to (base screen horizontal size - 1)

Y: 0 to (base screen vertical size - 1)

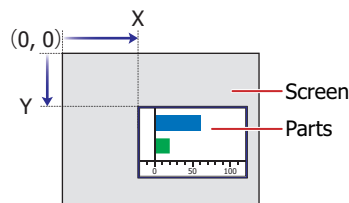

■ **Size**

W, H: Sets width and height to define the size of parts.

W: 5 to (base screen horizontal size)

H: 5 to (base screen vertical size)

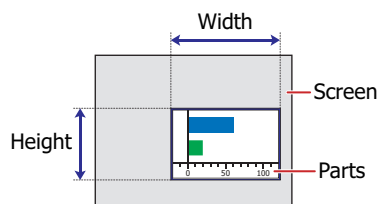

*1 Advanced mode only

● Data Over Tab

The **Data Over** tab is displayed in Advanced mode.

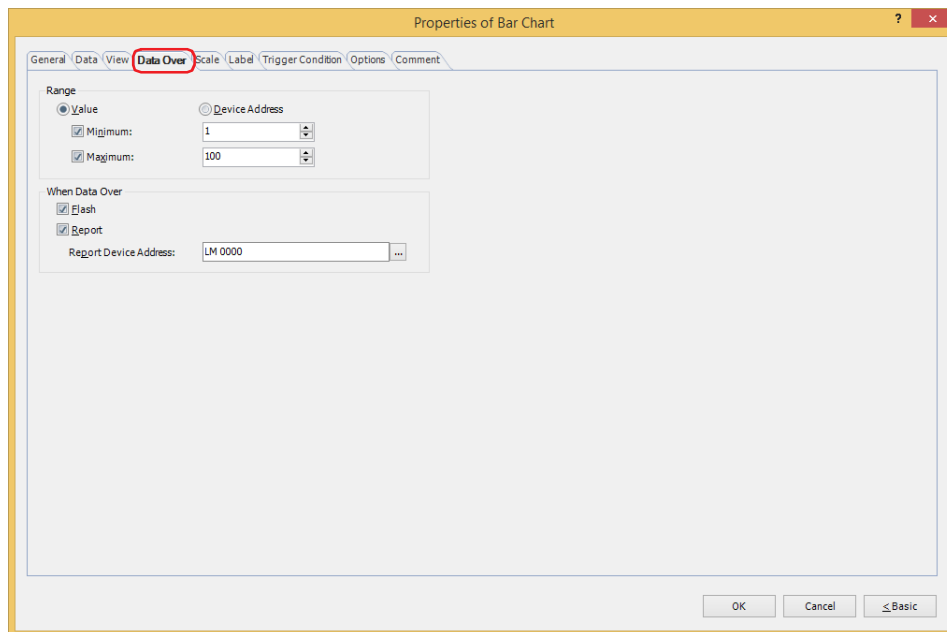

■ Range

Select data type.

Value: Specifies the minimum and/or the maximum as a constant.

Device Address: Specifies the minimum and/or the maximum as a word device value.

Specifies the allowable range of values to display.

Minimum, Maximum: Select these check boxes to specify the minimum and/or maximum.

The minimum and maximum that can be specified when **Value** is selected vary based on the data type selected with **Data Format** on the **General** tab. For details on data types, refer to Chapter 2 "1.1 Available Data" on page 2-1.

When **Device Address** is selected, these options specify the source word devices.

Click to display the Tag Editor. For the device address configuration procedure, refer to Chapter 2 "5.1 Device Address Settings" on page 2-70.

■ **When Data Over**

These options configure the operation of the part when the allowable range is exceeded.

These options can only be configured when the **Minimum** or **Maximum** check boxes are selected under **Range**.

Flash: Select this check box to make the chart flash when the displayed data exceeds the allowable range.

Report: Select this check box to write 1 in the Report Device Address when the displayed data exceeds the allowable range.

Report Device Address: Specifies the Report Device Address.

Click  to display the Tag Editor. For the device address configuration procedure, refer to Chapter 2 "5.1 Device Address Settings" on page 2-70.

Example: If the word device value of the reading source is "110" which is higher than the upper limit of "100", or "-10" which is below the lower limit of "0", a value of 1 will be written to LM0 and the displayed bar will flash.

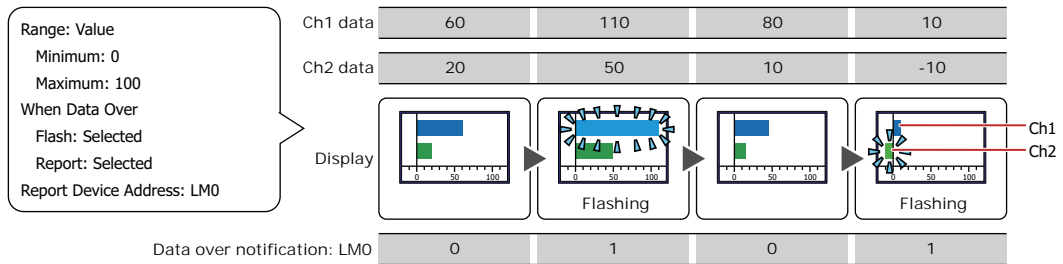

● **Scale Tab**

The **Scale** tab is displayed in Advanced mode.

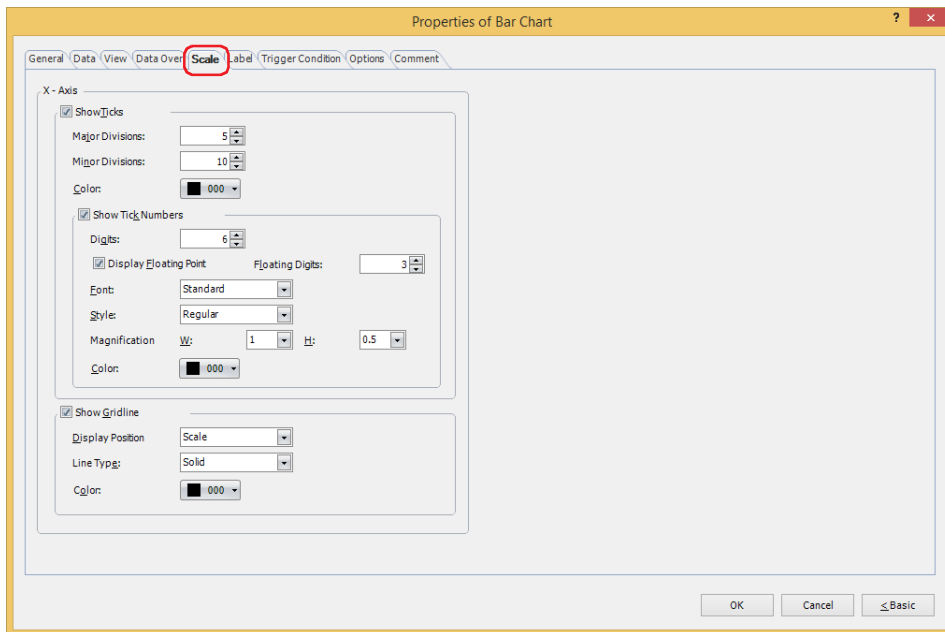

The options on the **Scale** tab vary based on the type selected with **Chart Type** on the **General** tab.

Horizontal Bar, Horizontal Peak: X-Axis

Vertical Bar, Vertical Peak: Y-Axis

■ **Show Ticks**

Select this check box to display a scale on a chart.

Major Divisions: Enter the number of major scale divisions (1 to 20).

Minor Divisions: Enter the number of minor scale divisions (1 to 20).

Color: Selects the color of scales (color: 256 colors, monochrome: 16 shades). Click **Color** to display the Color Palette. Select a color from the Color Palette.

Show Tick Numbers: Select this check box to display numbers along the scale.

Digits: Sets the number of digits to be displayed (1 to 10). Can only be set when **Float32(F)** is selected for **Data Type** under the **General** tab.

Display Floating Point: Select this check box to display a floating point along the scale. Can only be set when **Float32(F)** is selected for **Data Type** under the **General** tab.

Floating Digits: Sets the number of digits for the fractional parts of numbers (1 to 8) from the number of digits specified for **Digits**. Can only be set when the **Display Floating Point** check box is selected.

Font: Selects the font used for displayed text from the following. **Western *1, Standard *2, Stroke *2, 7-Segment**

The characters that can be displayed depend on the font. For details, refer to Chapter 2 "1.2 Available Text" on page 2-6.

Style *2: Selects **Regular** or **Bold** for the character style to be displayed. Can only be set when **Standard** is selected for **Font**.

Size: Specifies the text size to be displayed. The fonts and sizes that can be set vary based on the model.

Model	Font	Size
HG2J-7U	Western, 7-Segment	8 to 512
HG5G/4G/3G/2G-V, HG4G/3G, HG2G-5F/-5T, HG1G/1P	Stroke, 7-Segment	8 to 128

*1 HG2J-7U only

*2 HG5G/4G/3G/2G-V, HG4G/3G, HG2G-5F/-5T, HG1G/1P only

Magnification*2: W, H: Selects magnification (0.5, 1 to 8) for the displayed text. Can only be set when **Standard** is selected for **Font**.

Color: Selects the color of displayed text (color: 256 colors, monochrome: 16 shades). Click **Color** to display the Color Palette. Select a color from the Color Palette.

 If the area for displaying the scale is small, the scale will not be displayed properly.

Show Gridline

Select this check box to display grid lines on the chart. Grid lines are displayed above the chart. Can only be set when the **Show Ticks** check box is selected.

Display Position: Select from **Scale** and **Data Over** to specify the grid line display position.

Scale: Grid lines are displayed according to the number of major scale divisions.

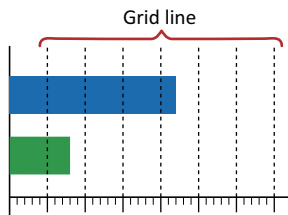

Data Over: Grid lines are displayed at the positions of values specified for **Maximum** and **Minimum** under the **Data Over** tab.

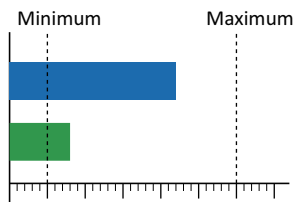

Line Type: Selects the type of grid lines from the following.

Solid, Dot, Dash, Long Dash, Long Dash Dot, Long Dash Dot Dot

Color: Specifies grid line color (color: 256 colors, monochrome: 16 shades). Click **Color** to display the Color Palette. Select a color from the Color Palette.

*2 HG5G/4G/3G/2G-V, HG4G/3G, HG2G-5F/-5T, HG1G/1P only

● Label Tab

The **Label** tab is only displayed in Advanced mode.

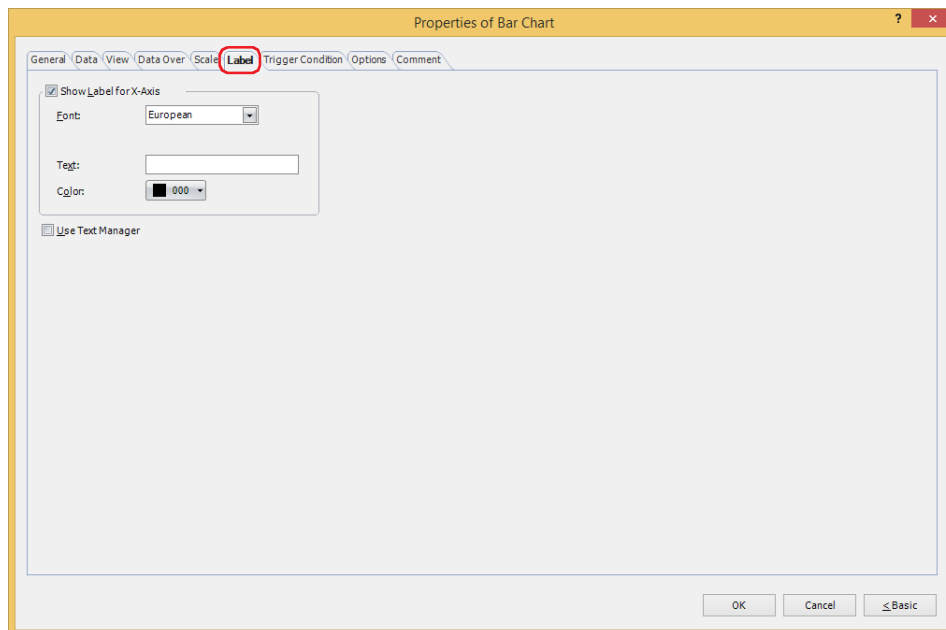

■ Show Label for X-Axis, Show Label for Y-Axis

Select this check box to display a label on X-axis and Y-axis scales.

The options on the **Label** tab vary based on the type selected with **Chart Type** on the **General** tab.

Horizontal Bar, Horizontal Peak: Show Label for X-Axis

Vertical Bar, Vertical Peak: Show Label for Y-Axis

- Font:** Selects the font for text used in labels from the following.
Western, Japanese, Simplified Chinese, Traditional Chinese, Hangul, Central European, Baltic, Cyrillic
 Can only be set when the **Use Text Manager** check box is cleared.
 The characters that can be displayed depend on the font. For details, refer to Chapter 2 "1.2 Available Text" on page 2-6.
- Text ID:** Specifies the Text Manager ID No. (1 to 32000) when text registered in the Text Manager are used for labels.
 Click  to display Text Manager.
 Can only be set when the **Use Text Manager** check box is selected.
- Text:** Inputs characters to be displayed for labels. Maximum number is 40 characters.
 The characters that can be entered depend on the font selected using **Font**. For details, refer to Chapter 2 "1.2 Available Text" on page 2-6.
 Can only be input when the **Use Text Manager** check box is cleared.
- Color:** Selects the color of the text used for labels (color: 256 colors, monochrome: 16 shades).
 Click **Color** to open the Color Palette. Select a color from the Color Palette.



If the area for displaying the label is too small, the label will not be displayed properly.

■ Use Text Manager

Select this check box if using the text registered in Text Manager for labels. Can only be set when the **Show Label for X-Axis** or **Show Label for Y-Axis** check box is selected.



If a carriage return (CR) is included, the characters after the CR are not displayed. However, if Windows Font is set for the specified Text ID, all the characters are displayed.

● **Trigger Condition Tab**

The **Trigger Condition** tab is displayed in Advanced mode.

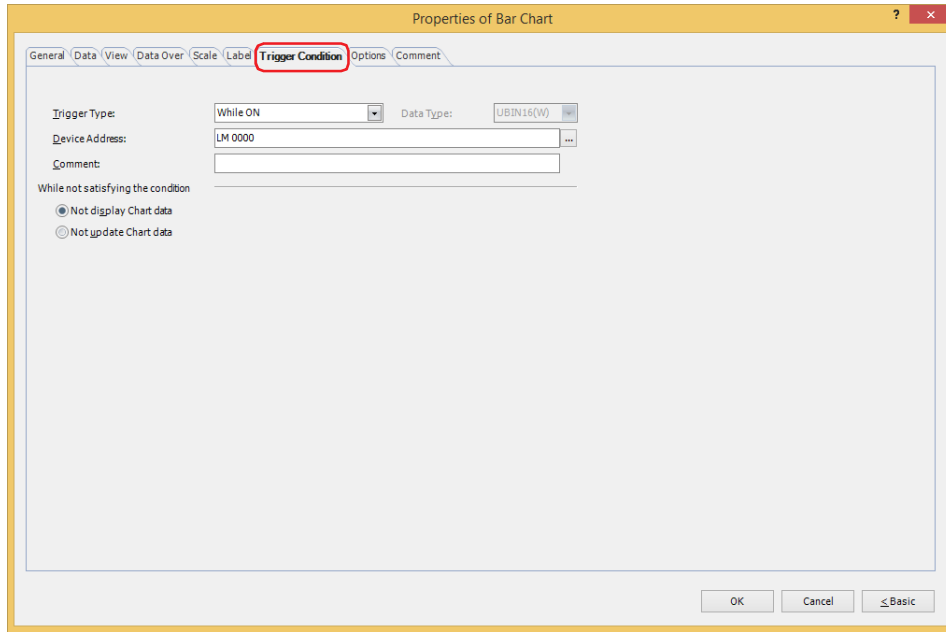

The bar chart is enabled while the condition is satisfied, and it is disabled while the condition is not satisfied. Select the operation when the condition is not satisfied as **Not display Chart data** or **Not update Chart data** under **While not satisfying the condition**.

Example: When **Trigger Type** is **While ON**, **Device Address** is **LM0**, and **While not satisfying the condition** is **Not display Chart data**

While LM0 is 0, the condition is not satisfied and the bar chart is not displayed.

While LM0 is 1, the condition is satisfied and the bar chart is displayed.

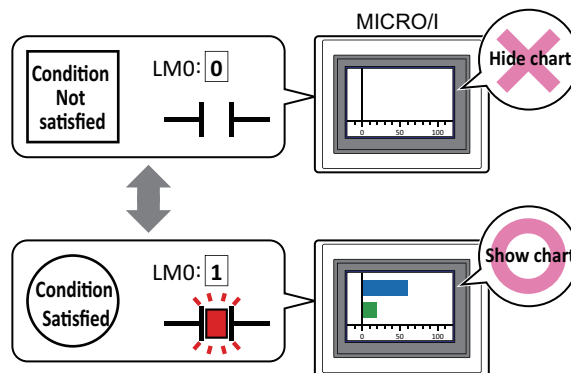

Data over does not operate for hidden bar charts. Data over is reported if the minimum or maximum is exceeded when the bar chart changes from hidden to displayed.

■ **Trigger Type**

Selects the condition to enable the bar chart from the following.

Always visible: The bar chart is always enabled.

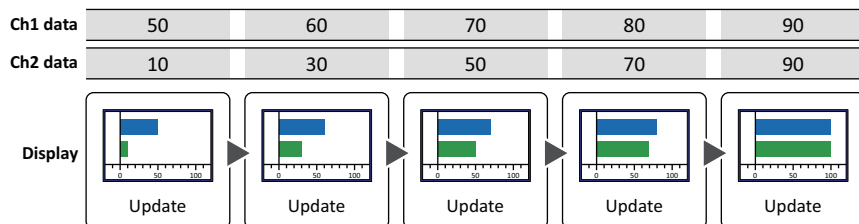

While ON:

Enables the bar chart when the value of device address is 1.

Example: When **While not satisfying the condition** is **Not update Chart data**

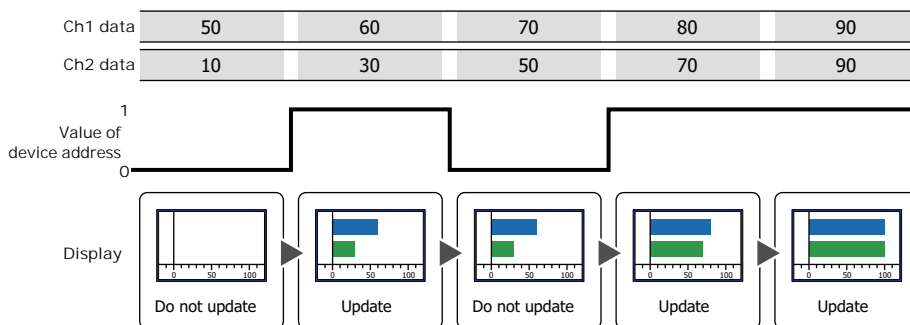

While OFF:

Enables the bar chart when the value of device address is 0.

Example: When **While not satisfying the condition** is **Not update Chart data**

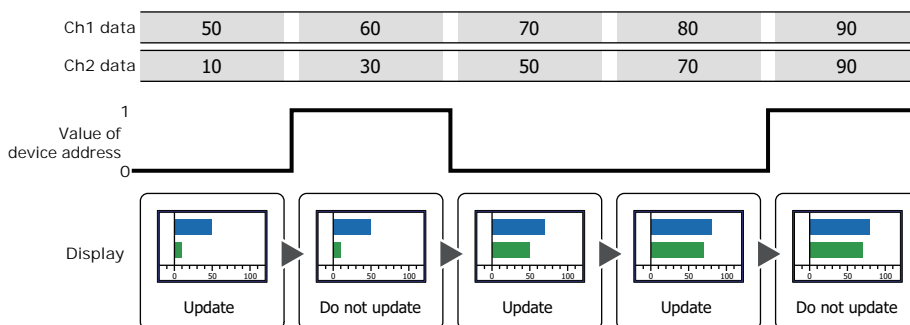

While satisfying the condition: Enables the bar chart when the condition is satisfied.

Example: When **While not satisfying the condition** is **Not update Chart data**

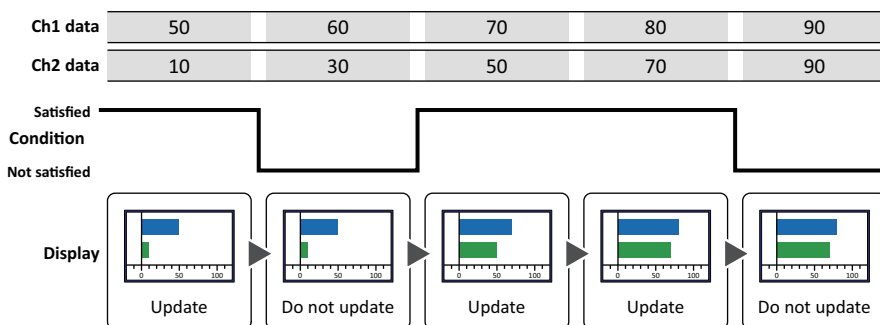

■ **Data Type**

Selects the data type to be handled by the condition formula.

Can only be set if **While satisfying the condition** is selected as **Trigger Type**.

For details, refer to Chapter 2 "1.1 Available Data" on page 2-1.

■ **Device Address**

Specifies the bit device or the bit number of the word device to serve as condition.

Can only be set if **While ON** or **While OFF** is selected as **Trigger Type**.

Click to display the Tag Editor. For the device address configuration procedure, refer to Chapter 2 "5.1 Device Address Settings" on page 2-70.

■ **Condition**

Sets the condition formula.

Can only be set if **While satisfying the condition** is selected as **Trigger Type**.

Click to display the **Trigger Condition Settings** dialog box. For the conditional expression configuration procedure, refer to Chapter 2 "5.2 Setting Conditional Expressions" on page 2-73.

- **Comment**

Used for entering comments about trigger conditions. Maximum number is 80 characters.

- **While not satisfying the condition**

Selects operation of the Bar Chart when condition is not satisfied.

Not display Chart data: The plate and flange are displayed, but Bar Chart is not displayed.

Not update Chart data: The last updated Bar Chart is displayed. The Bar Chart does not change.

● Options Tab

The **Options** tab is displayed in Advanced mode.

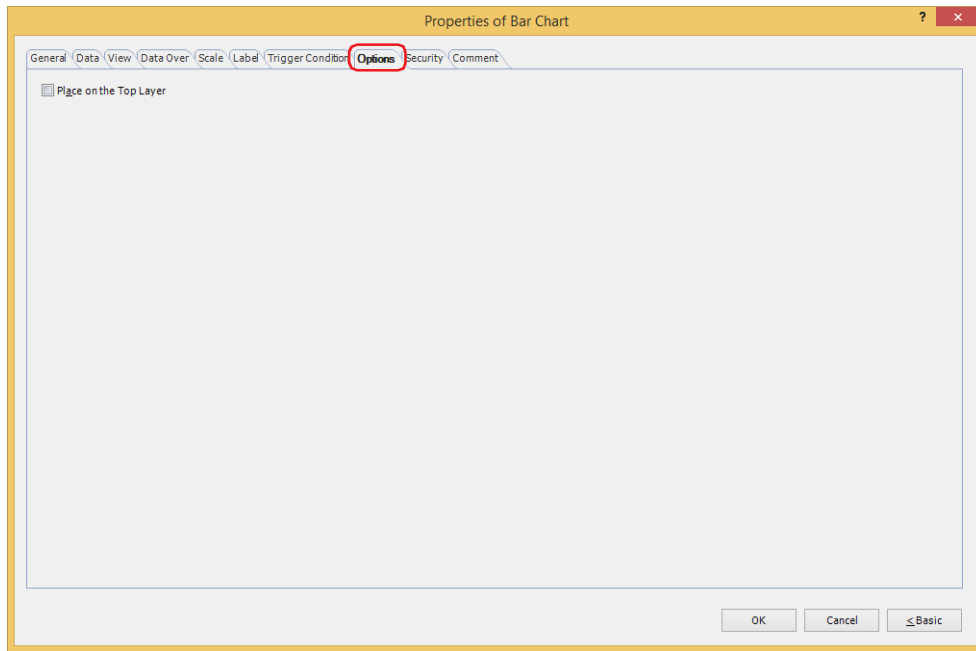

■ Place on the Top Layer

Select this check box to display the parts on the top layer. The parts will have precedence when other drawings and parts are overlapping with it. For details, refer to Chapter 6 "4 Drawings and Parts Overlapping" on page 6-5.

● Security Tab

This tab is used to restrict displaying and using the part by security groups.

This option can only be set when **Use Security functions** is selected. The **Use Security functions** check box is set on **General** tab in the **Security** dialog box.

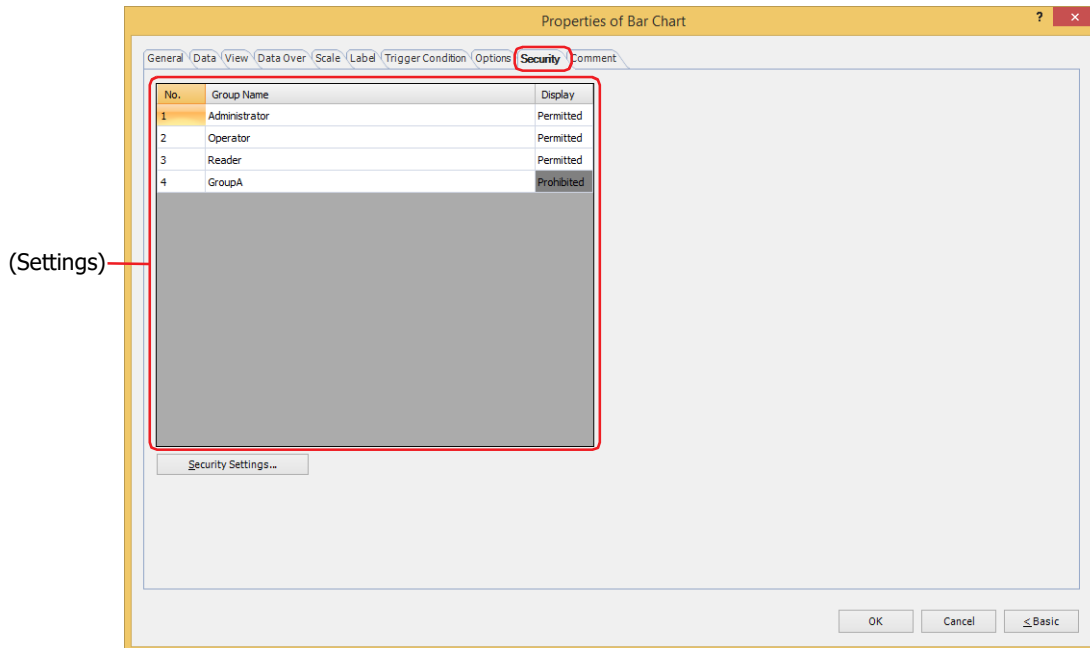

■ (Settings)

Displays the list of security groups used on the MICRO/I.

No.: Displays the security group numbers (1 to 15).

Group Name: Displays the name of the security group.

Display: Displays whether or not there is permission to display the part. Only **Permitted** security groups can display this part. If all security groups are set to **Permitted**, this part will be displayed even if no user account has been selected. Double clicking the cell switches between **Permitted** and **Prohibited**.



You can also switch between **Permitted** and **Prohibited** by right-clicking on a **Display** cell.



■ Security Settings

The Security Settings dialog box is displayed. If you create a security group in the **Security Settings** dialog box, you can select that created group. For details, refer to Chapter 23 "2.2 Adding and Editing Security Groups" on page 23-19.



For details about security functions, refer to Chapter 23 "User Accounts and the Security Function" on page 23-1.

Example: If the user and security group for a part are set as follows:

User Name	 User1	 User2
Security Group	Reader	Operator

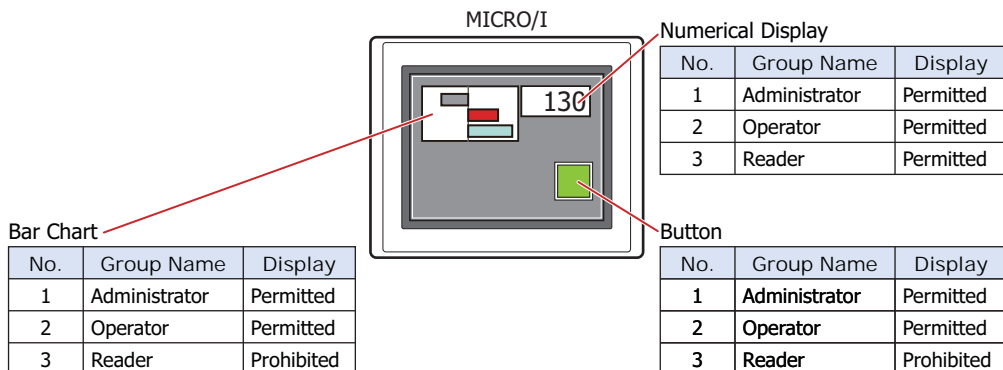

For User1 in the **Reader** security group, the parts for which **Display** has been set to **Prohibited** for **Reader** will not be displayed.

If the password screen is opened and the user switches to User2 in the **Operator** security group, the parts for which **Display** has been set to **Permitted** for **Operator** will be displayed.

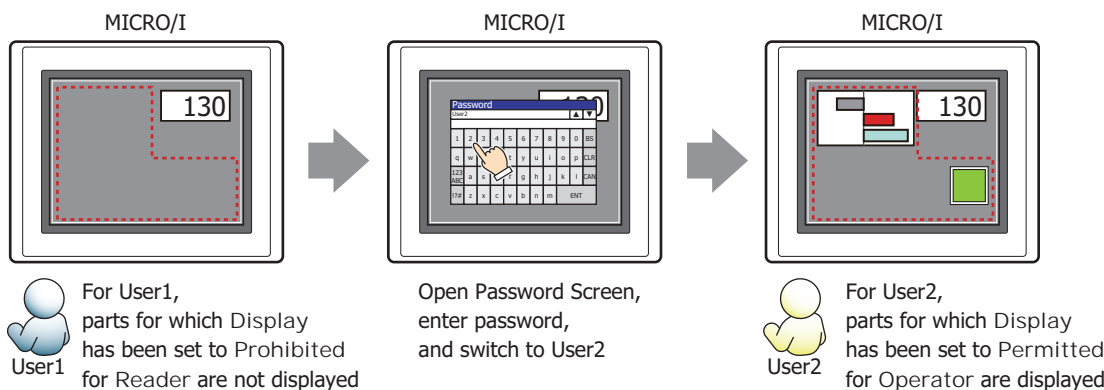

● Comment Tab

The **Comment** tab is used to specify the parts placed on the editing screen, and the popup text displayed when the mouse pointer is placed close to **No.**, **Name**, or **Type** in the object list.



When there are multiple parts of the same shape on the screen, this feature makes it possible to distinguish between the parts without displaying the Properties dialog box for each part, by just mousing over the part.

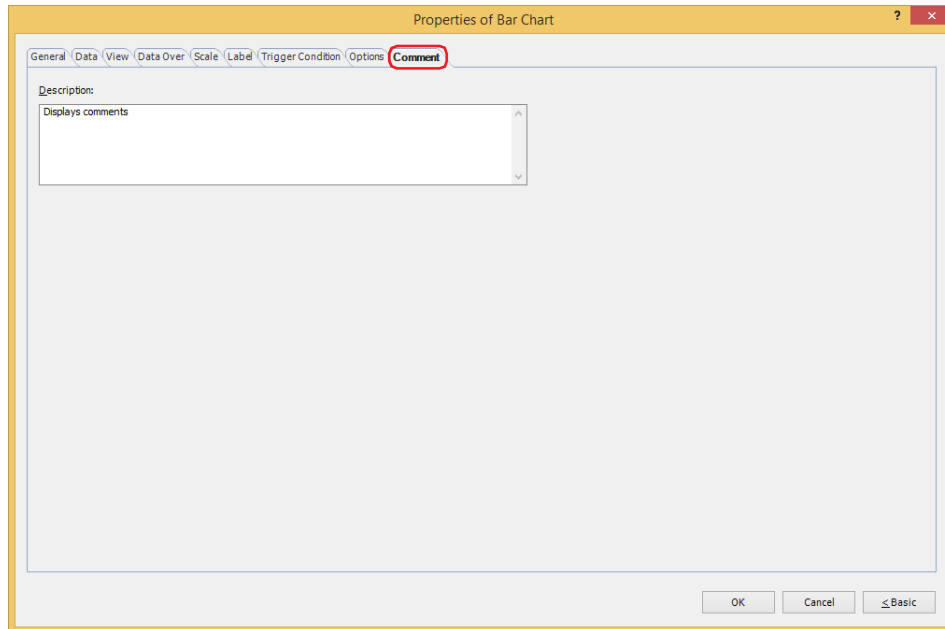

■ Description

Used for entering comments about parts. Maximum number is 80 characters.

Example: When mousing over the bar chart on the editing screen

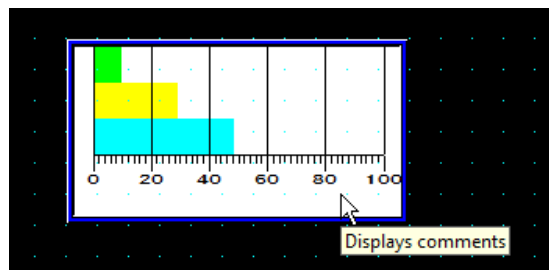

2 Line Chart

HG2J-7U HG5G-V HG4G-V HG4G HG3G-V HG3G HG2G-V HG2G-5F HG2G-5T HG1G HG1P

2.1 How the Line Chart is Used

The line chart can be used to display values of device addresses sampled with the Data Log function and the values of multiple word devices.

- Display the values of device addresses sampled with the Data Log function in a trend chart

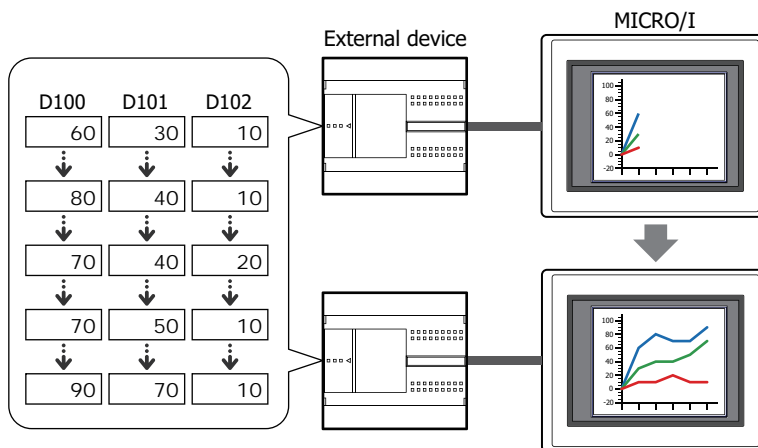

- There are two types of trend charts, a normal trend chart and a pen recorder trend chart.
- If the Data Log data displayed in the chart is deleted, the chart display is erased.

- Display the values of multiple, continuous device addresses in a single line chart

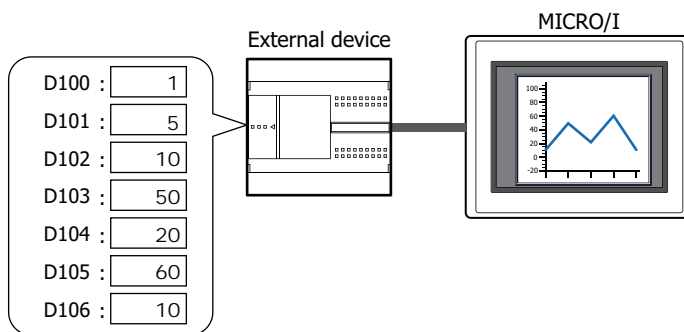

- Display the cursor and the date and time at the cursor

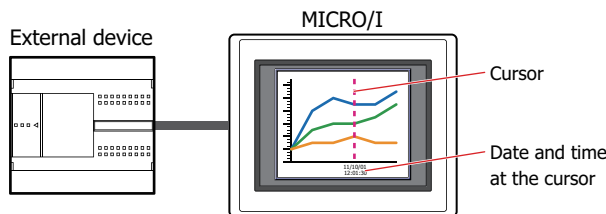

2.2 Line Chart Configuration Procedure

This section describes the configuration procedure for Line Charts.

- 1 On the **Home** tab, in the **Parts** group, click **Charts**, and then click **Line Chart**.

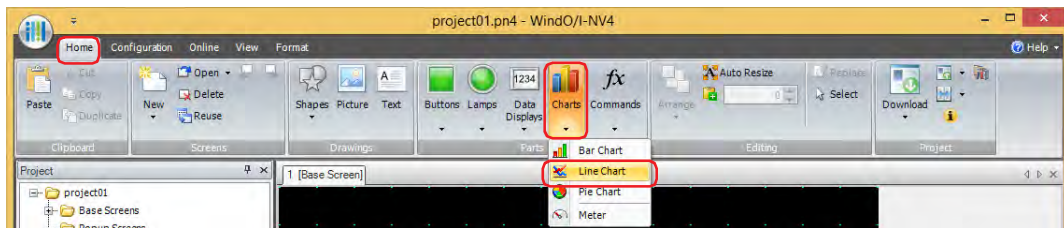

- 2 Click a point on the edit screen where you wish to place the Line Chart.
- 3 Double-click the placed Line Chart and a Properties dialog box will be displayed.
- 4 Change the settings on each tab as necessary.

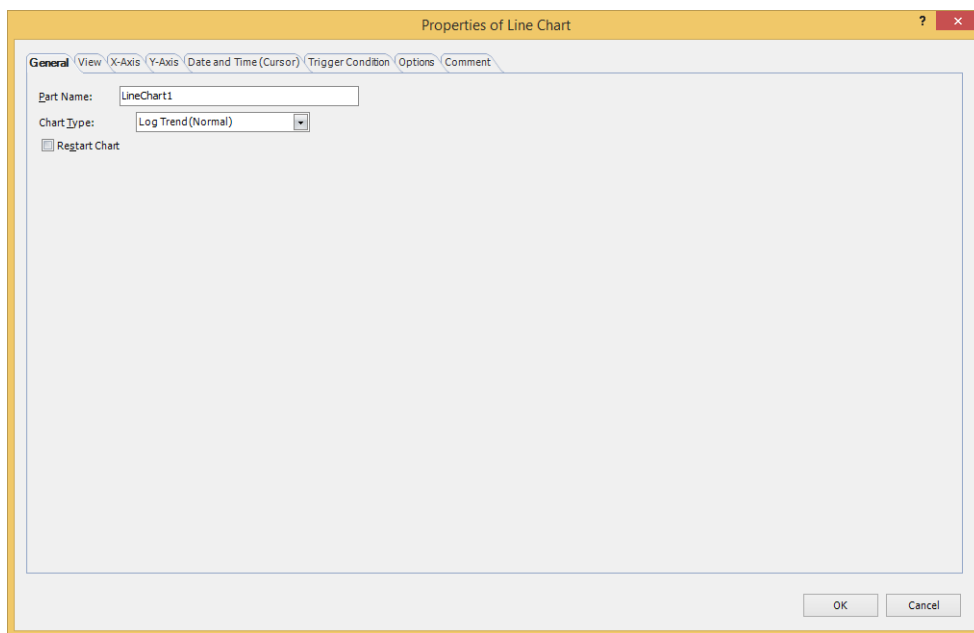

You can set the default for the Line Chart on the **Default Preferences** tab of the **WindO/I-NV4 Options** dialog box. For details, refer to Chapter 2 "Default Preferences Tab" on page 2-63.

2.3 Properties of Line Chart Dialog Box

This section describes items and buttons in the Properties dialog box.

● General Tab

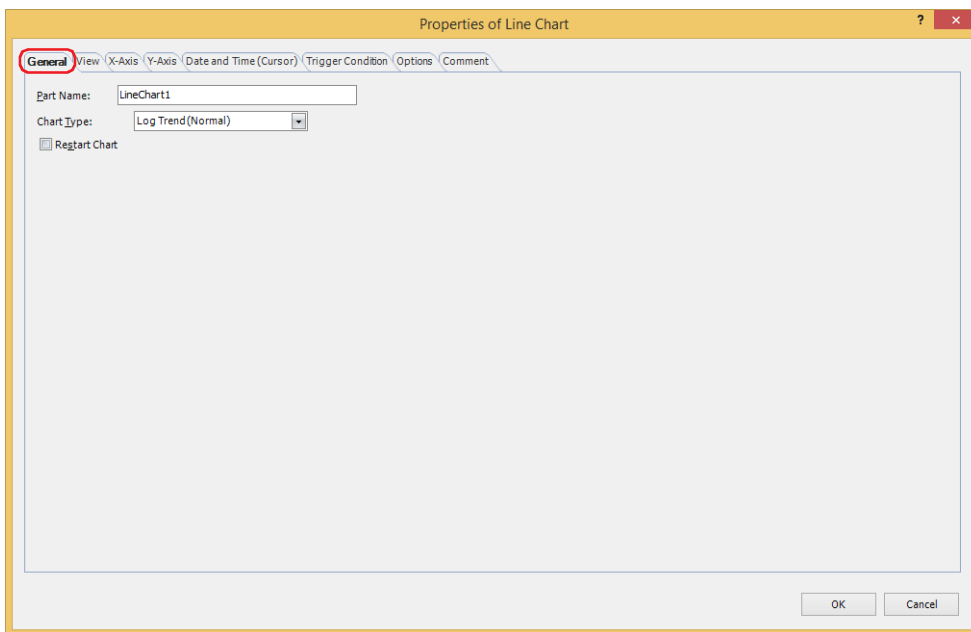

■ Part Name

Enter a name for the part. The maximum number is 20 characters.

■ Chart Type

Selects the type of chart from the following.

Log Trend (Normal):

Shows values of device addresses sampled with the Data Log function in a trend chart. The displayed chart is updated each time the latest data is sampled and the latest data is charted from the left edge. If the sampled data exceeds the number of display points, the entire chart is shifted to the left by the configured scroll size and the display is updated.

Example: **Display Points** on the **X-Axis** tab is 5 and **Number of automatic scrolls when updating display** is 1:

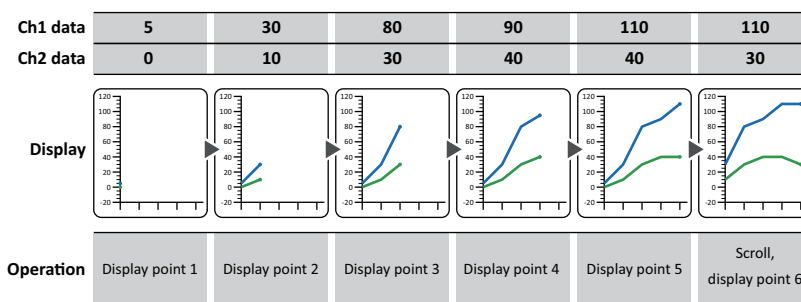

Log Trend (Pen Recorder): Shows values of device addresses sampled with the Data Log function in a trend chart. The displayed chart is updated each time the latest data is sampled and the latest data is always displayed at the right edge. The entire chart shifts to the left point by point and the display is updated.

Example: **Display Points** on the **X-Axis** tab is 5:

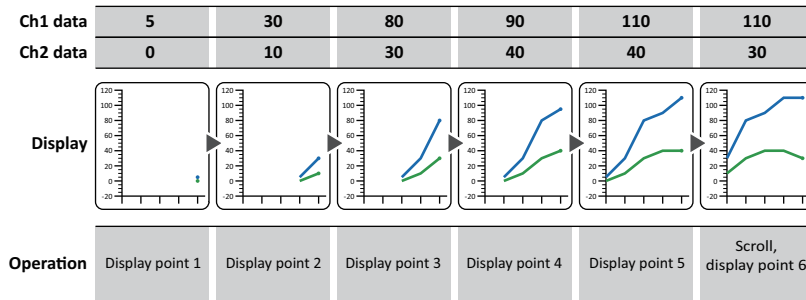

To display multiple items of data, set the sampling conditions and data size for the data to display to the same settings. The data cannot be displayed if its sampling conditions or data size is different.



The chart can display a maximum of 20 lines.

Device Address Display: Display the values of multiple, continuous device addresses as a single line chart. Updating and erasing the display is controlled by the lower 2 bits of the start address number value (control status). The value of the starting address number is automatically changes to 0 after updating and clearing the display. The number of values of device addresses to display is specified by the value of start address number + 1. The values of device addresses from start address number + 2 are displayed on the chart. The data size of the start address number and the start address number + 1 is 16 bits, and that of the start address number + 2 and later varies based on the data type selected with **Data Format** on the **Y-Axis** tab. For details on data types, refer to Chapter 2 "1.1 Available Data" on page 2-1.

Example: **Data Type** under **Data Format** on the **Y-Axis** tab is "UBIN32(D)" and **Reference Device Address** under **Data** is D100.

The display updates when the value of D100 changes from 0 to 1. The display is erased when the value changes to 2. The display is first erased and then updated when the value changes to 3. The value of D100 is automatically changes to 0 after updating and clearing the display.

(Start address number) D100-0 value Update	0→1	0	0→1	0→1	0→1
D100-1 value Erase	0	0→1	0	0	0→1
(Start address number + 1) D101 value Number of device addresses to display values	5	5	3	5	5
(Start address number + 2) D102 value The first plotted point	10	10	70	10	20
(Start address number + 4) D103 value The second plotted point	50	50	100	50	80
(Start address number + 6) D104 value The third plotted point	20	20	90	20	30
(Start address number + 8) D105 value The fourth plotted point	60	60	110	60	90
(Start address number + 10) D106 value The fifth plotted point	10	10	80	10	20

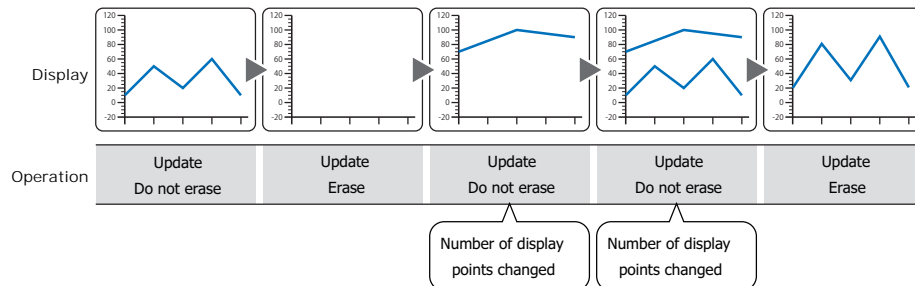

If there are many items of data to display, it may take some time to update the display.

■ **Restart Chart**

Select this check box to display the chart from the beginning when switching screens.

This option can only be configured when **Log Trend (Normal)** or **Log Trend (Pen Recorder)** is selected for **Chart Type**.

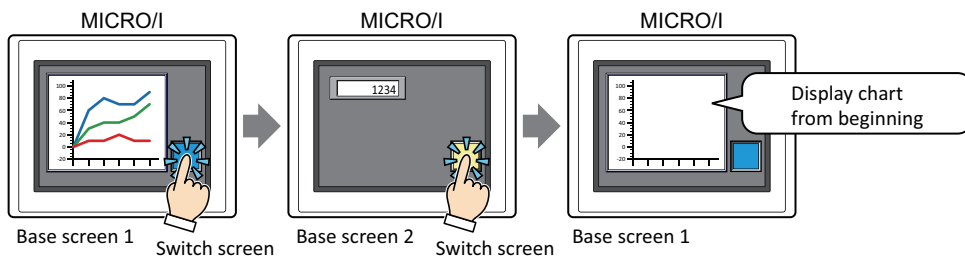

● View Tab

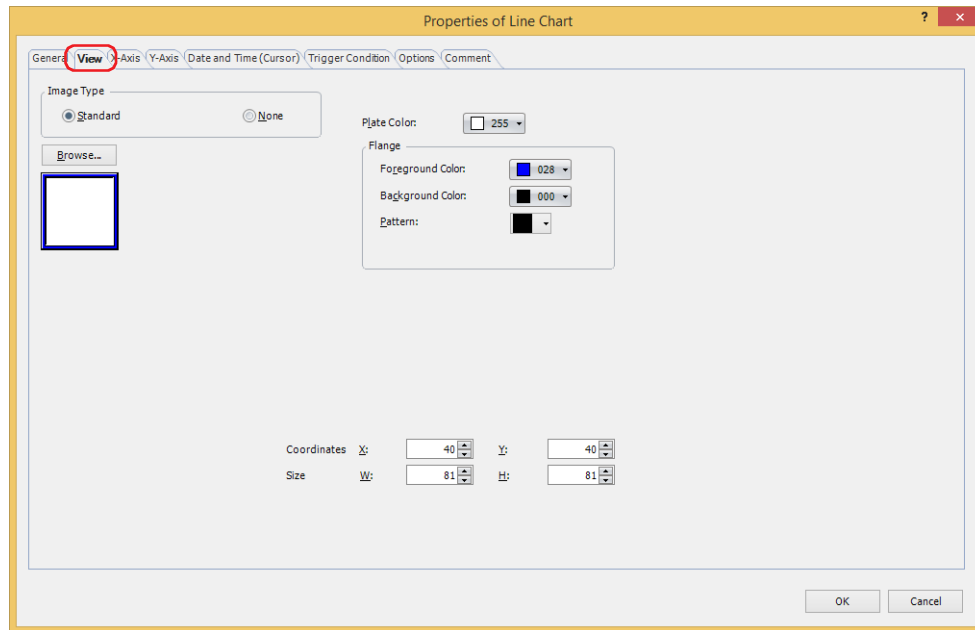

■ Image Type

Select the type of graphic to be used to represent the part.

Standard: Uses the default graphic for WindO/I-NV4.

None: The plate and the flange of the part are not displayed.

■ Browse

Select the type of graphic to be used to represent the part from the list of graphics. Click this button to display the View Browser.

■ Plate Color

Selects the plate color of the standard graphic (color: 256 colors, monochrome: 16 shades).

Click **Color** to display the Color Palette. Select a color from the Color Palette.

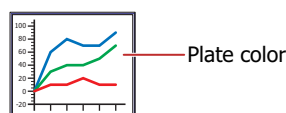

■ Flange

Foreground Color, Background Color: Selects the foreground and background colors of the flange of the standard graphic (color: 256 colors, monochrome: 16 shades).

Click **Color** to display the Color Palette. Select a color from the Color Palette.

Pattern:

Selects a pattern for the flange of the standard graphic.

Click **Pattern** to display the Pattern Palette. Select a pattern from the Pattern Palette.

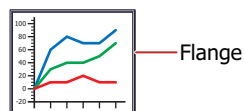

■ Coordinates

X, Y: Sets the display position of parts using coordinates.

The X and Y coordinates of parts are defined relative to an origin at the top-left corner of the screen.

X: 0 to (base screen horizontal size - 1)

Y: 0 to (base screen vertical size - 1)

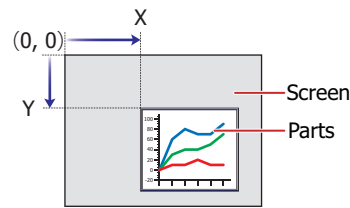

■ Size

W, H: Sets width and height to define the size of parts.

W: 5 to (base screen horizontal size)

H: 5 to (base screen vertical size)

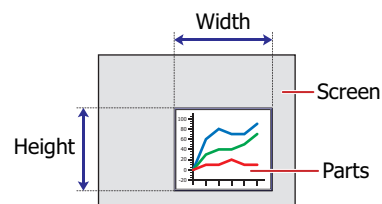

● X-Axis Tab

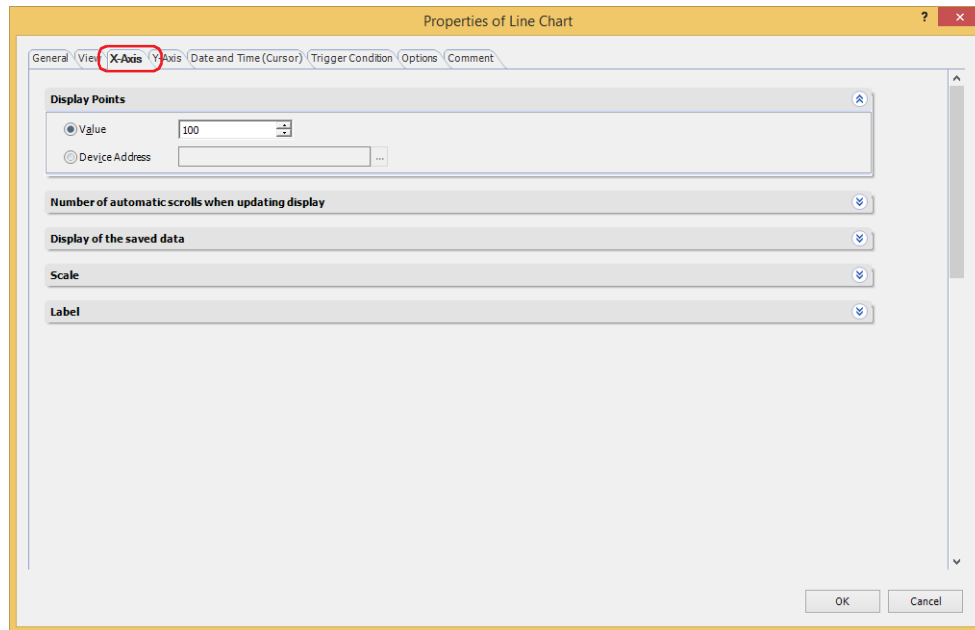

■ Display Points

Specifies the maximum number of points of data to display on the chart (2 to 65535).

This option can only be configured when **Log Trend (Normal)** or **Log Trend (Pen Recorder)** is selected for **Chart Type**.

(Data Type): Selects the data type to use with the display points.

Value: Uses a constant value.

Device Address: Uses a value of device address.

(Display points): Specifies the maximum number of points (2 to 65535) for the data to be displayed on the chart. The handled data type is UBIN16(W) only.

When **Device Address** is selected for (Data Type), the display points can be specified in the word device.

Click  to display the Tag Editor. For the device address configuration procedure, refer to Chapter 2 "5.1 Device Address Settings" on page 2-70.



- The maximum number of data that can be displayed is the number of dots on the X-axis of the graph (the horizontal size of the area displaying the graph). When setting the value exceeding the number of dots on the X-axis as the Display Points, thinned out data is displayed.

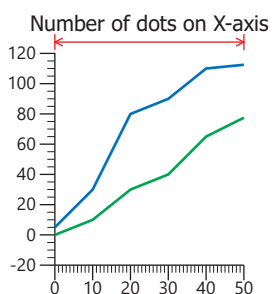

- If the value of the device address is smaller than 2 (minimum value), then the number of data points to display remains at 2.
- When the value of device address changes, the chart display is updated. At this time, chart data not saved to the data storage area is not displayed.
- Even if the value of device address is changed while the trigger condition is not satisfied, the chart display is not updated.

■ Number of automatic scrolls when updating display

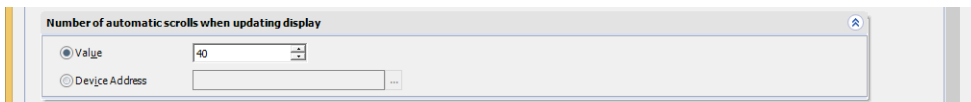

Specifies the number of points of data to scroll when updating the chart display (1 to Screen size (Horizontal)). This option can only be configured when **Log Trend (Normal)** is selected for **Chart Type**.

(Data Type): Selects the data type to use with the scroll size.

Value: Uses a constant value.

Device Address: Uses a value of device address.

(Scroll size): Specifies the number of points of data to scroll (1 to Screen size (Horizontal)). The handled data type is UBIN16(W) only.

When **Device Address** is selected for (Data Type), the scroll size can be specified in the word device.

Click  to display the Tag Editor. For the device address

configuration procedure, refer to Chapter 2 "5.1 Device Address Settings" on page 2-70.



- If the value of the device address is smaller than 1 (minimum value), then the Number of automatic scrolls remains at 1. If the value is larger than **Display Points**, then **Scroll Size** is the value of **Display Points**.
- When the value of **Display Points** is larger than the number of dots on the X-axis (the horizontal size of the area displaying the graph), scroll the chart by the number of dots specified in **Number of automatic scrolls when updating display**.

Example: When **Display Points** is 5 and **Scroll Size** is 3

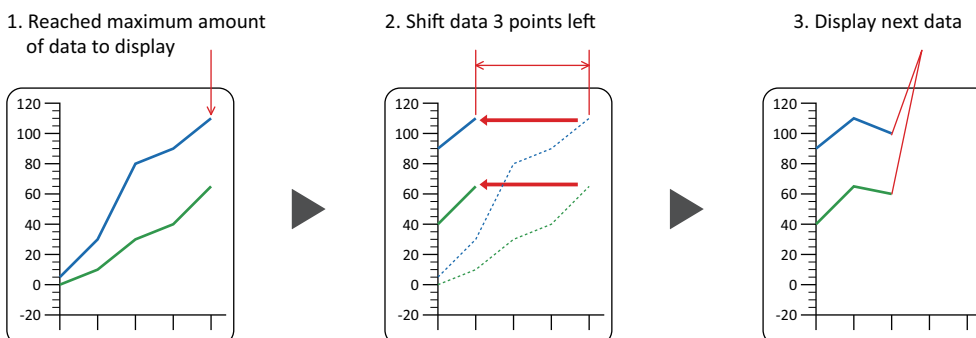

■ Display of the saved data

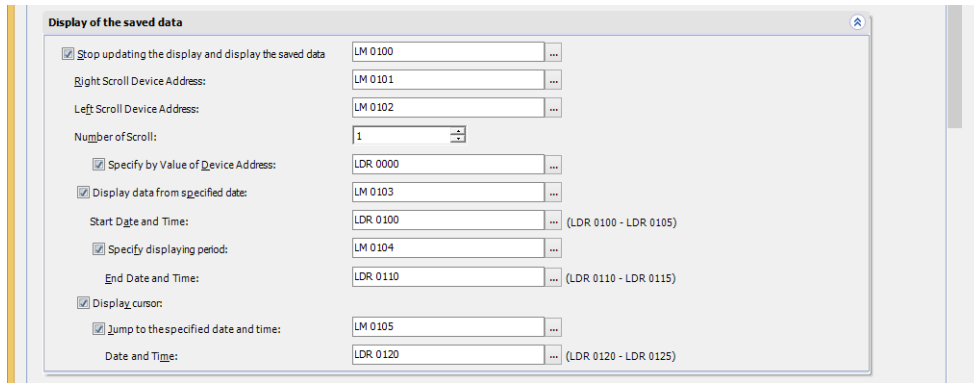

This option can only be configured when **Log Trend (Normal)** or **Log Trend (Pen Recorder)** is selected from **Chart Type** on the **General** tab.

Stop updating the display and display the saved data:

To scroll the chart to display past data and to display the cursor, the chart display updating must be stopped. To control updating the display, select this check box and specify the bit device or the bit number of the word device to control the display.

Click **...** to display the Tag Editor. For the device address configuration procedure, refer to Chapter 2 "5.1 Device Address Settings" on page 2-70.

Display updating stops when the value of device address changes from 0 to 1. Display updating restarts when the value of device address changes from 1 to 0.



When displaying a line graph using a file (.BIN) saved in external memory, the data on a channel that does not have a BIN file will not be displayed. For details about the BIN file, refer to Chapter 14 "Save Data Log Data and Display in Line Chart or Data Log Display" on page 14-23.

Right Scroll Device Address, Left Scroll Device Address:

The chart can be scrolled to the right or to the left when display updating is stopped. This option specifies the bit device or the bit number of the word device to scroll the chart left or right.

Click **...** to display the Tag Editor. For the device address configuration procedure, refer to Chapter 2 "5.1 Device Address Settings" on page 2-70.

The chart scrolls right or left one point of data each time the value of device address changes from 0 to 1.

These options can only be configured when the **Stop updating the display and display the saved data** check box is selected.

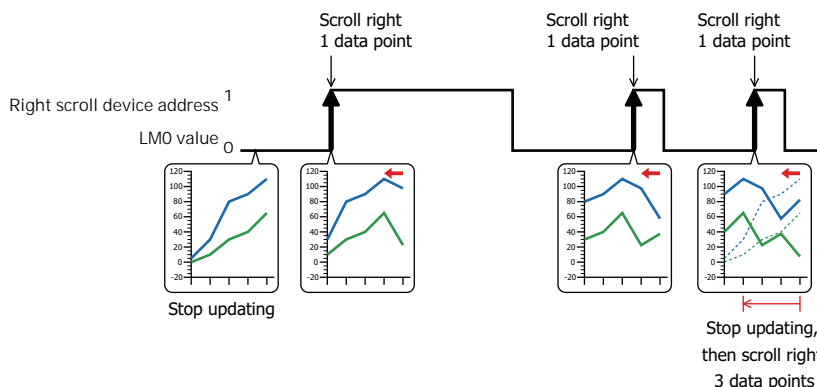

When the value of **Display Points** is larger than the number of dots on the X-axis (the horizontal size of the area displaying the graph), scroll the chart by the number of dots specified in **Number of Scroll**.

Number of Scroll:

Specifies the number of points of data to scroll the chart left or right (1 to the Screen size (Horizontal)) when stopping the chart display.

This option can only be configured when the **Stop updating the display and display the saved data** check box is selected.

Specify by Device Address: Select this check box and specify a source word device to specify the Number of Scroll using the value of the specified device address.

Click to display the Tag Editor. For the device address configuration procedure, refer to Chapter 2 "5.1 Device Address Settings" on page 2-70.

When MICRO/I starts operation, it copies the value of **Number of Scroll** as the initial value to the device address.

Display data from specified date: When stopping the chart display, to display the chart with the specified **Start Date** as the left end, select this check box and specify the bit device or the bit number of the word device to control the display.

Click to display the Tag Editor. For the device address configuration procedure, refer to Chapter 2 "5.1 Device Address Settings" on page 2-70.

Displays the chart for **Display Points** with **Start Date** as the left end when the value of device address changes from 0 to 1.

Start Date and Time:

Specifies the Start Date as the values of word devices for the data to display in the chart. It handles as a value whose data type is BCD4(B).

Click to display the Tag Editor. For the device address configuration procedure, refer to Chapter 2 "5.1 Device Address Settings" on page 2-70.

For address number assignment, refer to "Specifying Date and Time with Values of device addresses" on page 11-33.

This option can only be configured when **Display data from specified date** check box is selected.

Specify displaying period: To specify the range of data displayed on the chart, select this check box and specify the bit device or the bit number of the word device to control the display.

Click to display the Tag Editor. For the device address configuration procedure, refer to Chapter 2 "5.1 Device Address Settings" on page 2-70.

Displays the chart from **Start Date** as the left end to **End Date** when the value of device address changes from 0 to 1.

This option can only be configured when **Display data from specified date** check box is selected.

End Date and Time:

Specifies the End Date as the values of word devices for the data to display in the chart. It handles as a value whose data type is BCD4(B).

Click to display the Tag Editor. For the device address configuration procedure, refer to Chapter 2 "5.1 Device Address Settings" on page 2-70.

For address number assignment, refer to "Specifying Date and Time with Values of device addresses" on page 11-33.



- The maximum number of data that can be displayed is the number of dots on the X-axis of the graph (the horizontal size of the area displaying the graph). When the number of data from **Start Date** to **End Date** exceeds the number of dots on the X-axis, thinned out data is displayed.

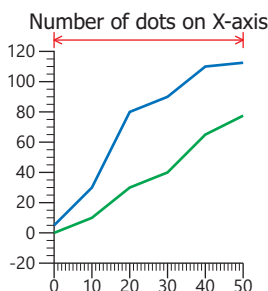

- If **Start Date** and **End Date** are the same or **End Date** is earlier than **Start Date**, the chart display will not be updated.

Display cursor:

Select this check box and specify the bit device or the bit number of the word device to display the cursor.

Click  to display the Tag Editor. For the device address configuration procedure, refer to Chapter 2 "5.1 Device Address Settings" on page 2-70.

Displays the cursor when the value of device address changes from 0 to 1.

The functions related to the cursor, such as cursor style and display position control, can be set on the **Date and Time (Cursor)** tab.

This option can only be configured when the **Stop updating the display and display the saved data** check box is selected.

Jump to the specified date and time:

To display the data of the specified date and time at the center of the chart, specify the bit device or the bit number of the word device to control the display.

Click  to display the Tag Editor. For the device address configuration procedure, refer to Chapter 2 "5.1 Device Address Settings" on page 2-70.

Display the chart with the data of the specified date and time as the center when the value of device address changes from 0 to 1.

Date and Time:

Specify the date and time of the data to display the center of the chart. It handles as a value whose data type is BCD4(B).

Click  to display the Tag Editor. For the device address configuration procedure, refer to Chapter 2 "5.1 Device Address Settings" on page 2-70.

For address number assignment, refer to "Specifying Date and Time with Values of device addresses" on page 11-33.



- Even if you move the data displayed on the graph by using **Jump to the specified date and time**, the cursor does not move.
- If there is not enough data to center the data for the specified date and time, the oldest or latest data is displayed.
- When the specified date and time is older than the oldest data, the oldest data is displayed on the left side of the chart.
- When the specified date and time is newer than the newest data, the newest data is displayed on the right side of the chart.
- In the following situations, the cursor does not move to the specified date and time even if the value of device address configured in **Jump to the specified date and time** becomes 1,
 - Trigger Condition is not satisfied.
 - The specified date and time are invalid.

Specifying Date and Time with Values of device addresses

Using this option requires the sequential address number of 6 words starting from the specified device address. The data is handled as BCD4(B) values in the order of year, month, day, hour, minute, and second.

Example: **Top Device Address** is LDR100, and the date and time is October 1 2018 12:01:30.

	Read source	Date and time data	
(the address number of Top Device Address)	LDR 100	2018	(Year)
+1	LDR 101	10	(Month)
+2	LDR 102	1	(Day)
+3	LDR 103	12	(Hour)
+4	LDR 104	1	(Minute)
+5	LDR 105	30	(Second)

■ **Scale**

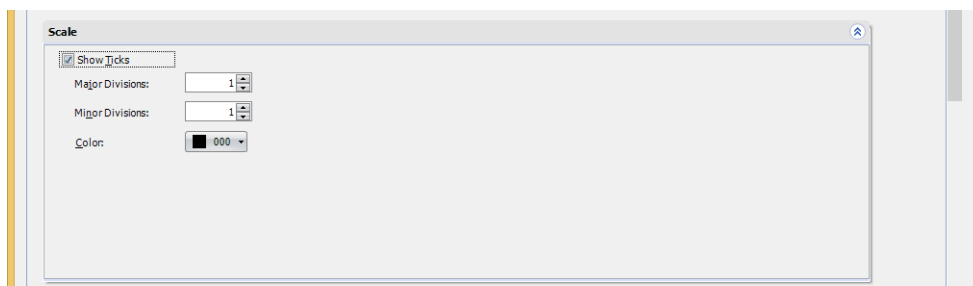

- Show Ticks: Select this check box to display a scale on a X-axis.
- Major Divisions: Enter the number of major scale divisions (1 to 20).
- Minor Divisions: Enter the number of minor scale divisions (1 to 20).
- Color: Selects the color of scales (color: 256 colors, monochrome: 16 shades). Click **Color** to display the Color Palette. Select a color from the Color Palette.

 If the area for displaying the scale is small, the scale will not be displayed properly.

■ Label

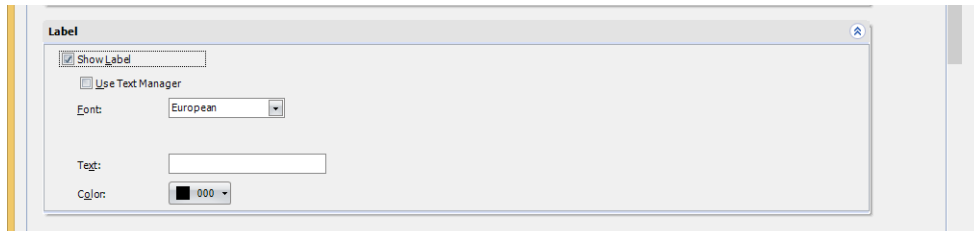

Show Label: Select this check box to display a label on X-axis scales.

Use Text Manager: Select this check box if using the text registered in Text Manager for labels. Can only be set when the **Show Label** check box is selected.



If a carriage return (CR) is included in the character displayed on the label, the characters after the CR are not displayed. However, if Windows Font is set for the specified Text ID, all the characters are displayed.

- Font:** Selects the font for text used in labels from the following.
Western, Japanese, Simplified Chinese, Traditional Chinese, Hangul, Central European, Baltic, Cyrillic
 Can only be set when the **Use Text Manager** check box is cleared.
 The characters that can be displayed depend on the font. For details, refer to Chapter 2 "1.2 Available Text" on page 2-6.
- Text ID:** Specifies the Text Manager ID No. (1 to 32000) when text registered in the Text Manager are used for labels.
 Click  to display Text Manager.
 Can only be set when the **Use Text Manager** check box is selected.
- Text:** Inputs characters to be displayed for labels. Maximum number is 40 characters.
 The characters that can be entered depend on the font selected using **Font**. For details, refer to Chapter 2 "1.2 Available Text" on page 2-6.
- Color:** Can only be input when the **Use Text Manager** check box is cleared.
 Selects the color of the text used for labels (color: 256 colors, monochrome: 16 shades).
 Click **Color** to open the Color Palette. Select a color from the Color Palette.



If the area for displaying the label is too small, the label will not be displayed properly.

● **Y-Axis Tab**

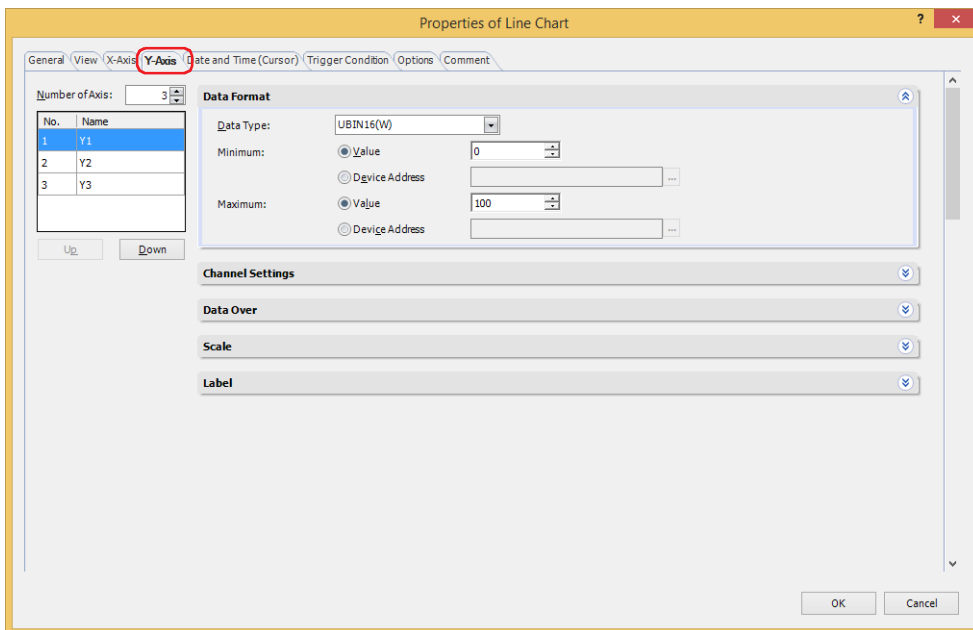

■ **Number of Axes**

Specifies the number of Y-axis (1 to 4*1).

Example: Display sample when **Number of Axes** is configured to 4

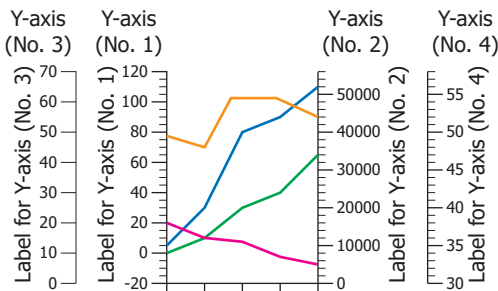

■ **(Y-Axis)**

The number of Y-axis specified by **Number of Axes** is displayed. Configures the graph displayed on the selected Y-axis with **Data Format**, **Channel Settings***2, **Data***3, **Data Over**, **Scale**, **Label**.

- No.: Displays the number of Y-axis (1 to 4*1).
- Name: Enter the name of Y-axis. The maximum number is 40 characters.
- Up: Shifts the selected Y-axis upward in the list.
- Down: Shifts the selected Y-axis downward in the list.

*1 When **Chart Type** is configured to **Device Address Display** on the **General** tab, 1 is configured.
 *2 This option can only be configured when **Log Trend (Normal)** or **Log Trend (Pen Recorder)** is selected from **Chart Type** on the **General** tab.
 *3 This option can only be configured when **Device Address Display** is selected from **Chart Type** on the **General** tab.

■ Data Format

Data Type: Selects the data type handled by the chart from the following.
UBIN16(W), BIN16(I), UBIN32(D), BIN32(L), BCD4(B), BCD8(EB), Float32(F)
 For details, refer to Chapter 2 "1.1 Available Data" on page 2-1.

Minimum, Maximum: Specifies the minimum and maximum for the chart.

(Data Type): Selects the data type to use for the minimum and the maximum.

Value: Uses a constant value.

Device Address: Uses a value of device address.

The minimum and maximum vary based on the selected data type. For details, refer to Chapter 2 "1.1 Available Data" on page 2-1.

When **Device Address** is selected for (Data Type), the minimum and maximum can be specified in the word device.

Click  to display the Tag Editor. For the device address configuration procedure, refer to Chapter 2 "5.1 Device Address Settings" on page 2-70.



If the data displayed in the chart is invalid, 1 is written to System Area 2 Processing error bit (address number+2, bit 5), and an error message is displayed. If **Chart Type** is **Device Address Display**, a processing error occurs when the chart is initially displayed, when the display is updated, and when it is erased. For details, refer to Chapter 4 "Processing error" on page 4-32 and Chapter 36 "Processing error" on page 36-3.

An error occurs in the following states:

- The setting of **Origin**, **Minimum**, or **Maximum** are invalid, or the **Minimum** and **Maximum** are the same values.
- **Data Type** is **BCD4(B)**, **BCD8(EB)**, or **Float32(F)** and the value cannot be expressed with the data type selected for the read data

The chart cannot be displayed when an error has occurred.



- If the **Chart Type** is selected as **Log Trend (Normal)** or **Log Trend (Pen Recorder)**, the chart display is updated when a value of device address is changed. At this time, chart data not saved to the data storage area is not displayed.
- If the **Chart Type** is selected as **Device Address Display**, the minimum and maximum are updated when the display is updated or erased.
- Even if the value of device address is changed while the trigger condition is not satisfied, the minimum and maximum are not updated.

■ Channel Settings*2

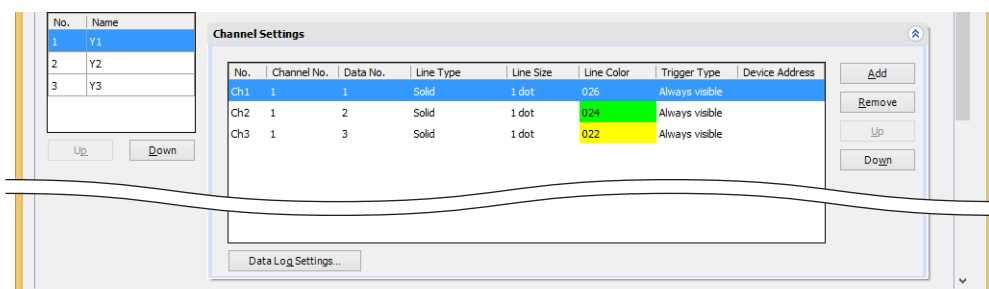

No.: Shows the numbers for the chart (Ch1 to Ch20).

Channel No.: Specifies the Data Log channel number to display on the chart (1 to 20).

Double clicking the cell allows you to edit the channel number.



If the Condition of Writing to Data Storage Area or the amount of log data saved in the data storage area is different from other channels, the chart cannot be displayed. Use the channel data which have the same settings of other channels.

*2 This option can only be configured when **Log Trend (Normal)** or **Log Trend (Pen Recorder)** is selected from **Chart Type** on the **General** tab.

- Data No.: Out of the data contained in the selected Data Log channel number, specifies the data number to display on the chart (1 to 128).
Double clicking the cell allows you to edit the data number.
- Line Type: Selects the type of line from the following.
Solid, Dot, Dash, Long Dash, Long Dash Dot, Long Dash Dot Dot
Double clicking the cell allows you to change the chart line type.
- Line Size: Selects the line size from the following.
1 dot, 2 dots, 3 dots, 5 dots
Double clicking the cell allows you to change the chart line size.
- Line Color: Selects the line color for the chart (color: 256 colors, monochrome: 16 shades).
Double clicking the cell displays the Color Palette where you can change the chart line color.



You can register the settings from arbitrary numbers, they are aligned filled from the beginning after clicking **OK** on the dialog box. Therefore, when the **Properties** dialog box is closed and reopened, the list is displayed filled from the beginning.

Trigger Type: Always visible: Always display the graph.

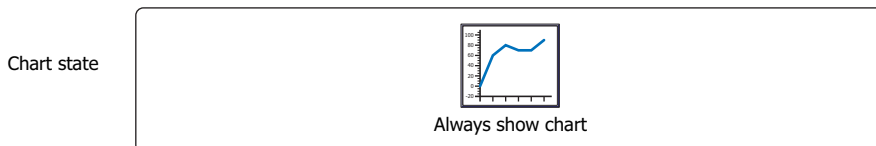

While ON: The graph is displayed when the value of device address is 1.

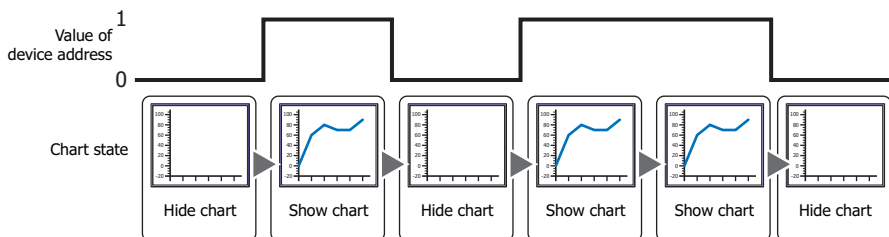

- Device Address: Specifies the bit device or the bit number of the word device to serve as condition.
Can only be set if **While ON** or **While OFF** is selected as **Trigger Type**.
Click to display the Tag Editor. For the device address configuration procedure, refer to Chapter 2 "5.1 Device Address Settings" on page 2-70.
- Add: Adds a channel to the list. Up to 20 channels total for all Y-axis.
- Up: Shifts the selected settings upward in the list.
- Down: Shifts the selected settings downward in the list.
- Remove: Deletes the selected contents from the list.
- Data Log Settings: Displays the **Data Log Settings** dialog box where you can configure the channel while checking the data to display.

■ Data*3

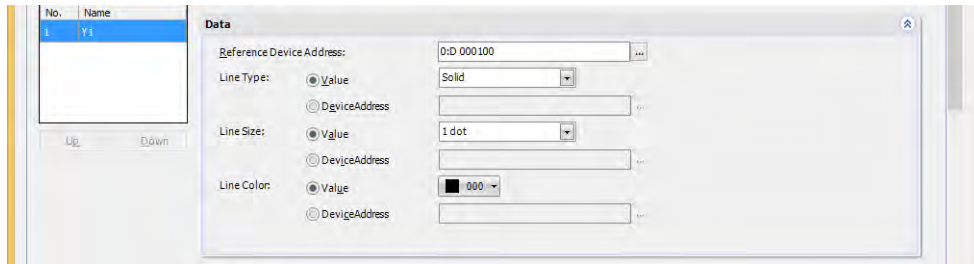

Reference Device Address:

Specifies the start address number of the data to display on the chart.

Click to display the Tag Editor. For the device address configuration procedure, refer to Chapter 2 "5.1 Device Address Settings" on page 2-70.

The data size for the device addresses is 16 bits.

Updating and erasing the display is controlled by the lower 2 bits of the start address number value (control status).

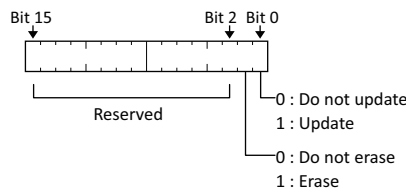

The number of values of device addresses to display is specified by the value of start address number + 1. The values of device addresses from start address number + 2 are displayed on the chart.

Example: If **Reference Device Address** is set to D100, continuous device addresses are used starting from D100. The used device addresses are as follows.

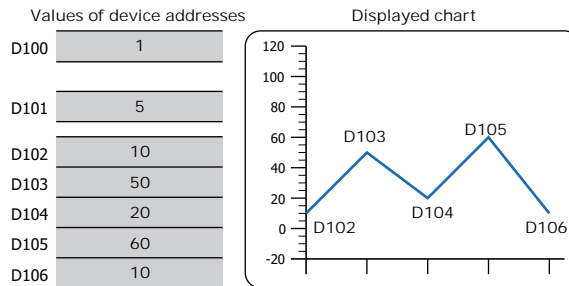
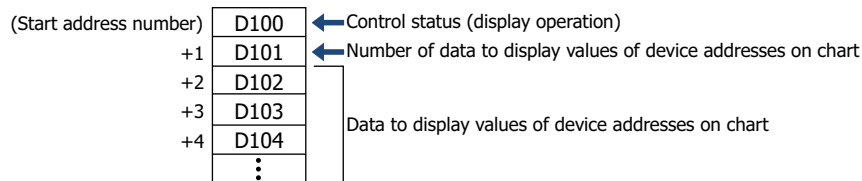

Line Type: Specifies the type of line. You can also specify it using the value of device address.

Value: Selects the type of line from the following.
Solid, Dot, Dash, Long Dash, Long Dash Dot, Long Dash Dot Dot

Device Address: Specifies the line type using the value of device address.

Click to display the Tag Editor. For the device address configuration procedure, refer to Chapter 2 "5.1 Device Address Settings" on page 2-70.

Line type is as follows:

Preset Value	1	2	3	4	5	6
Line Type	Solid	Dot	Dash	Long Dash	Long Dash Dot	Long Dash Dot Dot

The line will be displayed with **Solid** when the value of device address is not 1 to 6 or when the line width is not 1 (1 dot).

*3 This option can only be configured when **Device Address Display** is selected from **Chart Type** on the **General** tab.

Line Size: Specifies the line size. You can also specify it using the value of device address.

Value: Selects the line size from the following.

1 dot, 2 dots, 3 dots, 5 dots

Device Address: Specifies the line size using the value of device address.

Click to display the Tag Editor. For the device address configuration procedure, refer to Chapter 2 "5.1 Device Address Settings" on page 2-70.

Line width is as follows:

Preset Value	1	2	3	5
Line Width	1 dot	2 dots	3 dots	5 dots

The line will be displayed with **1 dot** when the value of device address is not 1 to 3 or 5.

Line Type: Specifies the color of line. You can also specify it using the value of device address.

Value: Selects the line color for the chart (color: 256 colors, monochrome: 16 shades).

Click this button to display the Color Palette. Select a color from the Color Palette.

Device Address: Specifies the line color using the value of device address.

Click to display the Tag Editor. For the device address configuration procedure, refer to Chapter 2 "5.1 Device Address Settings" on page 2-70.

Line color is specified by the color data. When the value of device address is other than the color number, the graph is displayed in 255 (white).

For color data, refer to Appendix "Color Data Correspondence Table" on page A-1.

■ Data Over

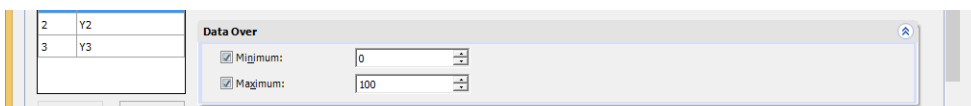

Specifies the allowable range of values to display.

Minimum, Maximum: Select these check boxes to specify the minimum and/or maximum.

The minimum and maximum that can be specified differ according to the data type selected with **Data Format**. For details on data types, refer to Chapter 2 "1.1 Available Data" on page 2-1.



When grid lines are displayed for the minimum and maximum, select the **Show Gridline** check box on the **Scale** and then select **Data Over**.

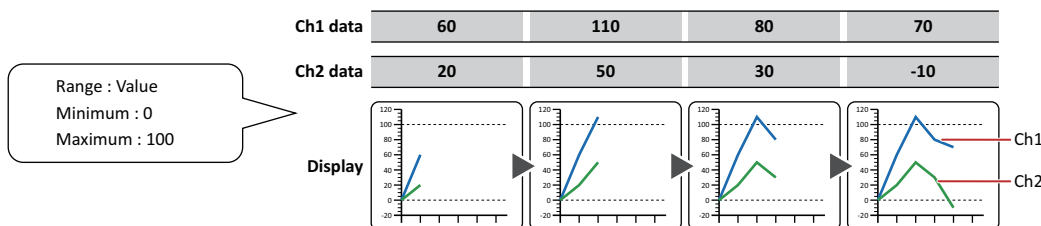

■ Scale Tab

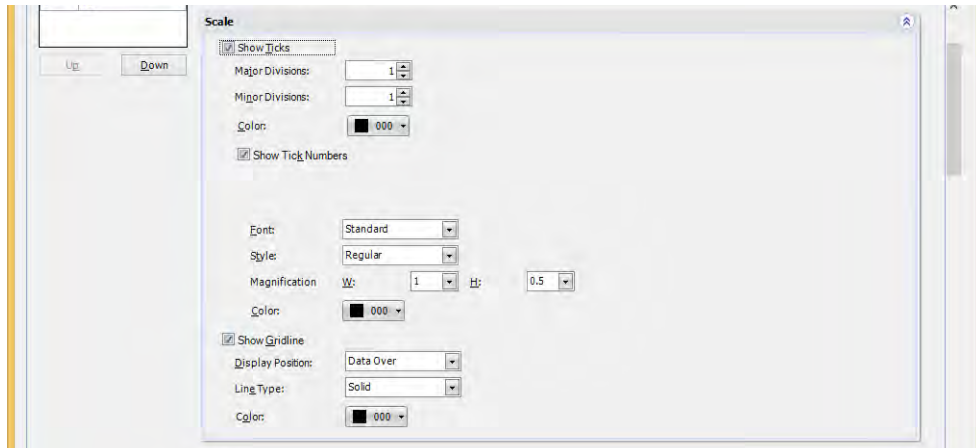

Show Ticks: Select this check box to display a scale on a chart.

Major Divisions: Enter the number of major scale divisions (1 to 20).

Minor Divisions: Enter the number of minor scale divisions (1 to 20).

Color: Selects the color of scales (color: 256 colors, monochrome: 16 shades). Click **Color** to display the Color Palette. Select a color from the Color Palette.

Show Tick Numbers: Select this check box to display numbers along the scale. Can only be set for **Y-Axis**.

Digits: Sets the number of digits to be displayed (1 to 10). Can only be set when **Float32(F)** is selected for **Data Type** under the **General** tab.

Display Floating Point: Select this check box to display a floating point along the scale. Can only be set when **Float32(F)** is selected for **Data Type** under the **General** tab.

Floating Digits: Sets the number of digits for the fractional parts of numbers (1 to 8) from the number of digits specified for **Digits**. Can only be set when the **Display Floating Point** check box is selected.

Font: Selects the font used for displayed text from the following. **Western *1, Standard *2, Stroke *2, 7-Segment**
The characters that can be displayed depend on the font. For details, refer to Chapter 2 "1.2 Available Text" on page 2-6.

Style*2: Selects **Regular** or **Bold** for the character style to be displayed. Can only be set when **Standard** is selected for **Font**.

Size: Specifies the text size to be displayed. The fonts and sizes that can be set vary based on the model.

Model	Font	Size
HG2J-7U	Western, 7-Segment	8 to 512
HG5G/4G/3G/2G-V, HG4G/3G, HG2G-5F/-5T, HG1G/1P	Stroke, 7-Segment	8 to 128

Magnification*2: W, H: Selects magnification (0.5, 1 to 4, 8) for the displayed text. Can only be set when **Standard** is selected for **Font**.

Color: Selects the color of displayed text (color: 256 colors, monochrome: 16 shades). Click **Color** to display the Color Palette. Select a color from the Color Palette.

 If the area for displaying the scale is small, the scale will not be displayed properly.

*1 HG2J-7U only

*2 HG5G/4G/3G/2G-V, HG4G/3G, HG2G-5F/-5T, HG1G/1P only

Show Gridline: Select this check box to display grid lines on the chart. The grid lines are displayed on the chart. Can only be set when the **Show Ticks** check box is selected.

Display Position: Select from **Scale** and **Data Over** to specify the grid line display position.

Scale: Grid lines are displayed according to the number of major scale divisions.

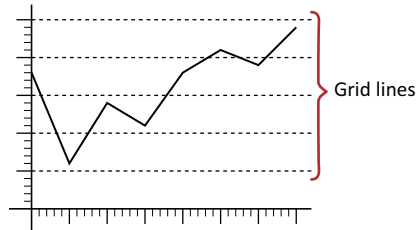

Data Over: Grid lines are displayed at the positions of values specified for **Maximum** and **Minimum** under the **Data Over** tab.

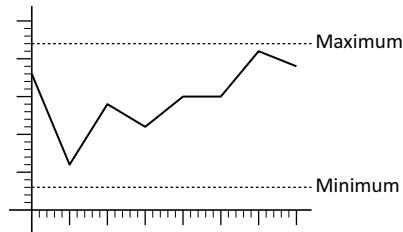

Line Type: Selects the type of grid lines from the following.

Solid, Dot, Dash, Long Dash, Long Dash Dot, Long Dash Dot Dot

Color: Specifies grid line color (color: 256 colors, monochrome: 16 shades).

Click **Color** to display the Color Palette. Select a color from the Color Palette.

■ Label Tab

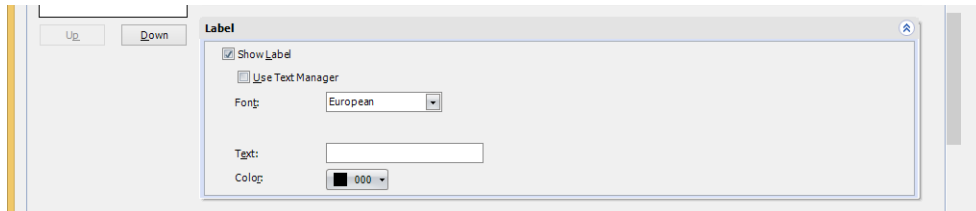

Show Label: Select this check box to display a label on Y-axis scales.

Use Text Manager: Select this check box if using the text registered in Text Manager for labels. Can only be set when the **Show Label** check box is selected.



If a carriage return (CR) is included in the character displayed on the label, the characters after the CR are not displayed. However, if Windows Font is set for the specified Text ID, all the characters are displayed.

- Font:** Selects the font for text used in labels from the following.
Western, Japanese, Simplified Chinese, Traditional Chinese, Hangul, Central European, Baltic, Cyrillic
 Can only be set when the **Use Text Manager** check box is cleared.
 The characters that can be displayed depend on the font. For details, refer to Chapter 2 "1.2 Available Text" on page 2-6.
- Text ID:** Specifies the Text Manager ID No. (1 to 32000) when text registered in the Text Manager are used for labels.
 Click  to display Text Manager.
 Can only be set when the **Use Text Manager** check box is selected.
- Text:** Inputs characters to be displayed for labels. Maximum number is 40 characters.
 The characters that can be entered depend on the font selected using **Font**. For details, refer to Chapter 2 "1.2 Available Text" on page 2-6.
 Can only be input when the **Use Text Manager** check box is cleared.
- Color:** Selects the color of the text used for labels (color: 256 colors, monochrome: 16 shades).
 Click **Color** to open the Color Palette. Select a color from the Color Palette.



If the area for displaying the label is too small, the label will not be displayed properly.

● Date and Time (Cursor) Tab

The **Date and Time (Cursor)** tab is displayed only when **Log Trend (Normal)** or **Log Trend (Pen Recorder)** is selected as **Chart Type** on the **General** tab and the **Display cursor** check box on the **X-Axis** tab is selected.

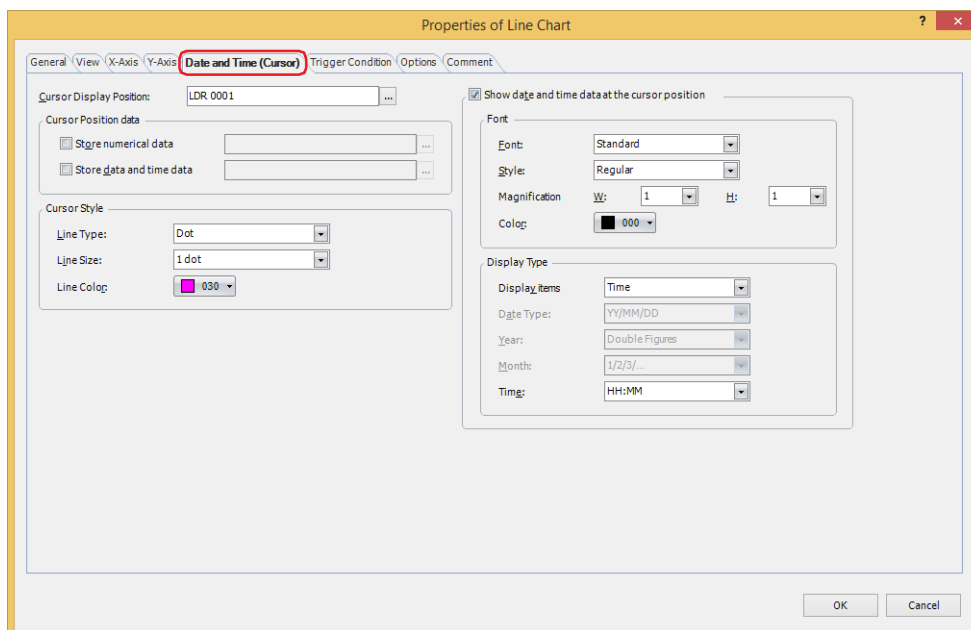

■ Cursor Display Position

This value of device address is the cursor's display position. The cursor is displayed at the position counted from the left side of the chart.

This option specifies the word device that is the cursor's display position.

Click to display the Tag Editor. For the device address configuration procedure, refer to Chapter 2 "5.1 Device Address Settings" on page 2-70.

If the value of the device address configured by **Cursor Display Position** is outside the range of points configured by **Display Points** on **X-Axis** tab, the cursor is displayed at the minimum or the maximum value of the display points.

Example: When **Display Points** is 50 and the value of the device address configured by **Cursor Display Position** is 100, the cursor is displayed at the 50 (maximum) position.

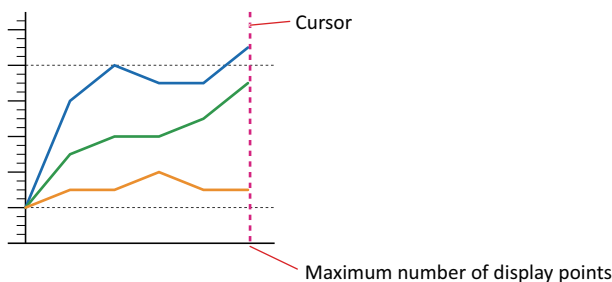

■ Cursor Position data

Store numerical data: To store the numerical data at the position indicated by the cursor in internal devices, select this check box and specify the destination word device.

Click  to display the Tag Editor. For the device address configuration procedure, refer to Chapter 2 "5.1 Device Address Settings" on page 2-70.

The data is stored in continuous device addresses starting from the specified device address in order from Ch1 in the amount of charts displayed. The number of used device addresses varies based on the data size. If there is no data at the cursor position, 0 is stored in the device address.

Example: Specifies LDR10 in **Store numeric data**.

Ch1 to Ch3 (Data Type: UBIN16(W)) on the Y-axis (No. 1)

Ch1 and Ch2 (Data Type: UBIN32(D)) on the Y-axis (No. 2)

Destination Device Addresses	Data Type	Destination Data
LDR10	UBIN16(W)	Ch1 numerical data of Y-axis (No.1)
LDR11	UBIN16(W)	Ch2 numerical data of Y-axis (No.1)
LDR12	UBIN16(W)	Ch3 numerical data of Y-axis (No.1)
LDR13	UBIN32(D)	Ch1 numerical data of Y-axis (No.2)
LDR14		
LDR15	UBIN32(D)	Ch2 numerical data of Y-axis (No.2)
LDR16		

Store date and time data: To store the date and time data at the position indicated by the cursor in internal devices, select this check box and specify the destination word device.

Click  to display the Tag Editor. For the device address configuration procedure, refer to Chapter 2 "5.1 Device Address Settings" on page 2-70.

Stores the value of data type BCD4(B) in the order of year, month, day, hour, minute, and second in consecutive address numbers starting with the specified device address. If there is no data at the cursor position, 0 is stored in the device address.

Destination Device Addresses	Data Type	Destination Data
Address Number+0	BCD4(B)	"Year" of the date and time data
Address Number+1	BCD4(B)	"Month" of the date and time data
Address Number+2	BCD4(B)	"Day" of the date and time data
Address Number+3	BCD4(B)	"Hour" of the date and time data
Address Number+4	BCD4(B)	"Minute" of the date and time data
Address Number+5	BCD4(B)	"Second" of the date and time data

Example: When storing the date and time data for October 1, 2011 12:01:30

Destination Device Addresses	Destination Data
LDR50	2021
LDR51	10
LDR52	1
LDR53	12
LDR54	1
LDR55	30

■ Cursor Style

Line Type: Selects the cursor line type from the following.

Solid, Dot, Dash, Long Dash, Long Dash Dot, Long Dash Dot Dot

Line Size: Selects the cursor line size from the following.

1 dot, 2 dots, 3 dots, 5 dots

Line Color: Selects the line color for the cursor (color: 256 colors, monochrome: 16 shades).

Click this button to display the Color Palette. Select a color from the Color Palette.

■ Show date and time data at the cursor position

To show the date and time data at the position indicated by the cursor, select this check box and specify the font and display type.

Font: Configures the format to display the date and time data.

Font: Selects the font for displayed characters from the following.

Western*1, Standard*2, Stroke*2, 7-Segment

The characters that can be displayed depend on the font. For details, refer to Chapter 2 "1.2 Available Text" on page 2-6.

Style*2: Selects the character style as **Regular** or **Bold**.

This option can only be configured when **Standard** is selected for **Font**.

Size: Specifies the text size to be displayed. The fonts and sizes that can be set vary based on the model.

Model	Font	Size
HG2J-7U	Western, 7-Segment	8 to 512
HG5G/4G/3G/2G-V, HG4G/3G, HG2G-5F/-5T, HG1G/1P	Stroke, 7-Segment	8 to 128

Magnification*2: W, H: Selects the zoom factor for characters (0.5, 1 to 4, 8).

This option can only be configured when **Standard** is selected for **Font**.

Color: Selects the text color (color: 256 colors, monochrome: 16 shades).

Click this button to display the Color Palette. Select a color from the Color Palette.

*1 HG2J-7U only

*2 HG5G/4G/3G/2G-V, HG4G/3G, HG2G-5F/-5T, HG1G/1P only

Display Type: Configures the display type for the date and time data.

Display items: Selects the items to display for the date and time data from the following.
Time, Date, Date & Time
 If **Date & Time** is selected, the date is displayed centered on the first line and the time is displayed centered on the second line.

Date Type: Selects the display type of the date from the following.
YY/MM/DD, MM/DD/YY, DD/MM/YY, MM/DD, DD/MM
 This option can only be configured when **Date** or **Date & Time** is selected for **Display items**.

Year: Selects the display type for the year as **Double Figures** or **Four Figures**.
 This option can only be configured when **Date** or **Date & Time** is selected for **Display items**.

Month: Selects the display type for the month as **1/2/3/...** or **Jan/Feb/Mar/....**
 This option can only be configured when **Date** or **Date & Time** is selected for **Display items**.

Time: Selects the display type for the time from the following.
HH:MM, HH:MM:SS, MM:SS
 HH: hours, MM: minutes, SS: seconds

Example: When **Display items** is configured as **Date & Time**, **Date Type** is **YY/MM/DD**, **Month** is **1/2/3/...**, **Year** is **Double Figures**, **Time** is **HH:MM:SS**

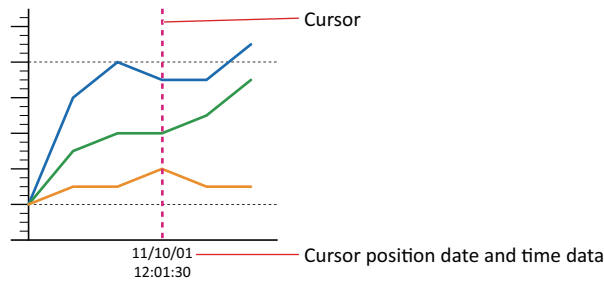

If there is no data at the cursor position, the date and time is displayed as "**".

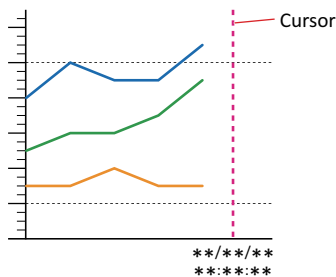

● Trigger Condition Tab

The **Trigger Condition** tab is displayed in Advanced mode.

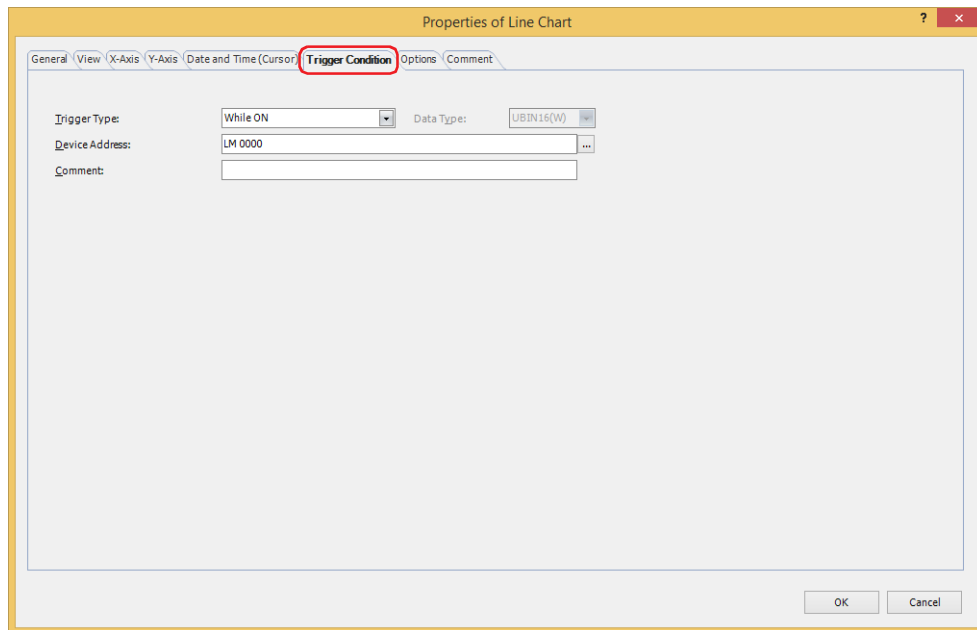

The line chart is enabled while the condition is satisfied, and it is disabled while the condition is not satisfied. When disabled, the plate and flange are displayed, but the chart is not displayed.

Example: When **Trigger Type** is **While ON** and **Device Address** is **LM0**

While LM0 is 0, the condition is not satisfied and the line chart is not displayed.

While LM0 is 1, the condition is satisfied and the line chart is displayed.

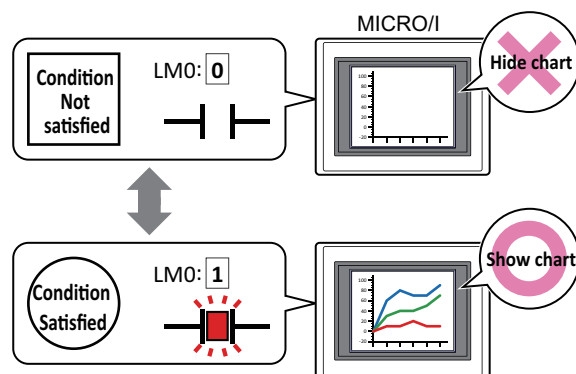

■ Trigger Type

Selects the condition to enable the line chart from the following.

Always visible: The line chart is always enabled.

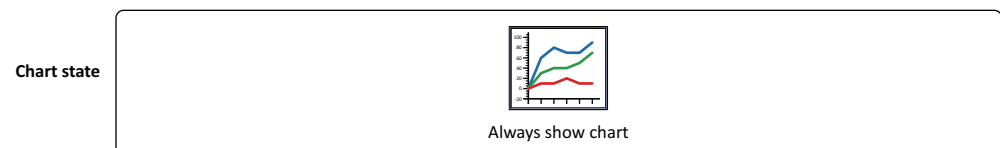

While ON: Enables the line chart when the value of device address is 1.

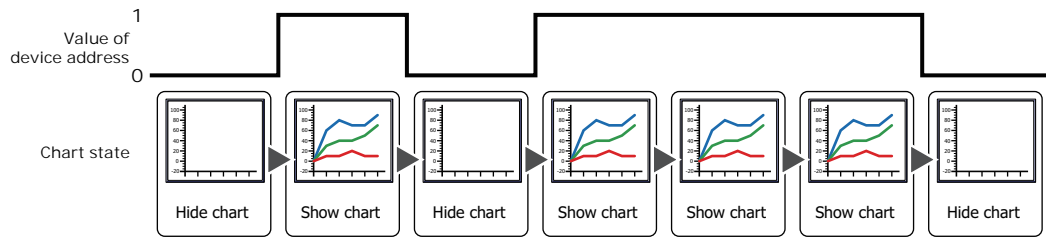

While OFF: Enables the line chart when the value of device address is 0.

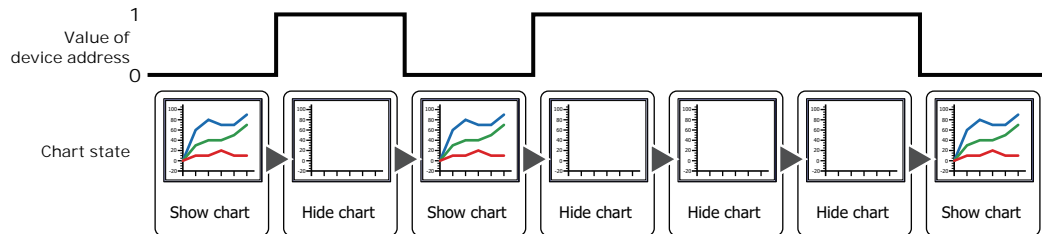

While satisfying the condition:

Enables the line chart when the condition is satisfied.

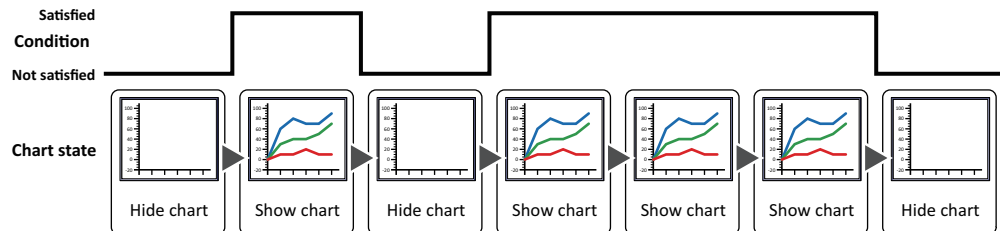

■ Data Type

Selects the data type to be handled by the condition formula.

Can only be set if **While satisfying the condition** is selected as **Trigger Type**.

For details, refer to Chapter 2 "1.1 Available Data" on page 2-1.

■ Device Address

Specifies the bit device or the bit number of the word device to serve as condition.

Can only be set if **While ON** or **While OFF** is selected as **Trigger Type**.

Click to display the Tag Editor. For the device address configuration procedure, refer to Chapter 2 "5.1 Device Address Settings" on page 2-70.

■ Condition

Sets the condition formula.

Can only be set if **While satisfying the condition** is selected as **Trigger Type**.

Click to display the **Trigger Condition Settings** dialog box. For the conditional expression configuration procedure, refer to Chapter 2 "5.2 Setting Conditional Expressions" on page 2-73.

■ Comment

Used for entering comments about trigger conditions. Maximum number is 80 characters.

● Options Tab

The **Options** tab is displayed in Advanced mode.

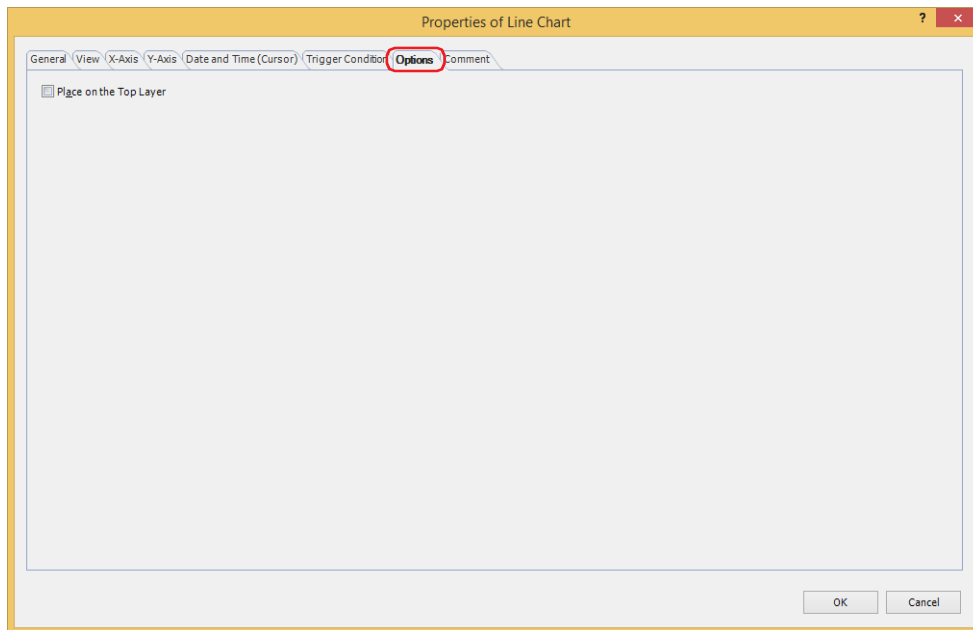

■ Place on the Top Layer

Select this check box to display the parts on the top layer. The parts will have precedence when other drawings and parts are overlapping with it. For details, refer to Chapter 6 "4 Drawings and Parts Overlapping" on page 6-5.

● Security Tab

This tab is used to restrict displaying and using the part by security groups.

This option can only be set when **Use Security functions** is selected. The **Use Security functions** check box is set on **General** tab in the **Security** dialog box.

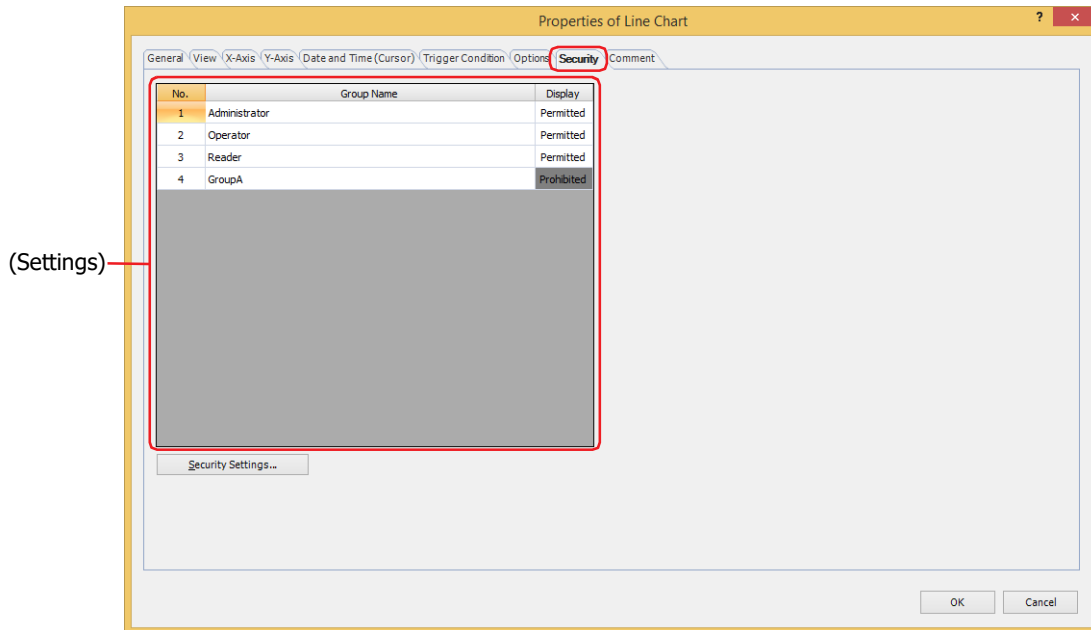

■ (Settings)

Displays the list of security groups used on the MICRO/I.

No.: Displays the security group numbers (1 to 15).

Group Name: Displays the name of the security group.

Display: Displays whether or not there is permission to display the part. Only **Permitted** security groups can display this part. If all security groups are set to **Permitted**, this part will be displayed even if no user account has been selected. Double clicking the cell switches between **Permitted** and **Prohibited**.



You can also switch between **Permitted** and **Prohibited** by right-clicking on a **Display** cell.



■ Security Settings

The Security Settings dialog box is displayed. If you create a security group in the **Security Settings** dialog box, you can select that created group. For details, refer to Chapter 23 "2.2 Adding and Editing Security Groups" on page 23-19.



For details about security functions, refer to Chapter 23 "User Accounts and the Security Function" on page 23-1.

Example: If the user and security group for a part are set as follows:

User Name	 User1	 User2
Security Group	Reader	Operator

Line Chart

No.	Group Name	Display
1	Administrator	Permitted
2	Operator	Permitted
3	Reader	Prohibited

MICRO/I

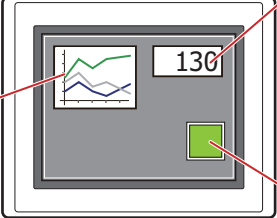

Numerical Display

No.	Group Name	Display
1	Administrator	Permitted
2	Operator	Permitted
3	Reader	Permitted

Button

No.	Group Name	Display
1	Administrator	Permitted
2	Operator	Permitted
3	Reader	Prohibited

For User1 in the **Reader** security group, the parts for which **Display** has been set to **Prohibited** for **Reader** will not be displayed.

If the password screen is opened and the user switches to User2 in the **Operator** security group, the parts for which **Display** has been set to **Permitted** for **Operator** will be displayed.

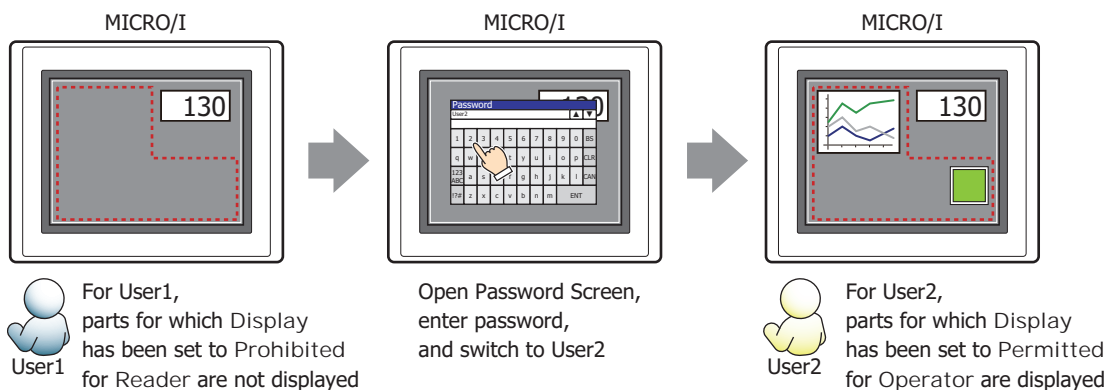

● Comment Tab

The **Comment** tab is used to specify the parts placed on the editing screen, and the popup text displayed when the mouse pointer is placed close to **No.**, **Name**, or **Type** in the object list.



When there are multiple parts of the same shape on the screen, this feature makes it possible to distinguish between the parts without displaying the Properties dialog box for each part, by just mousing over the part.

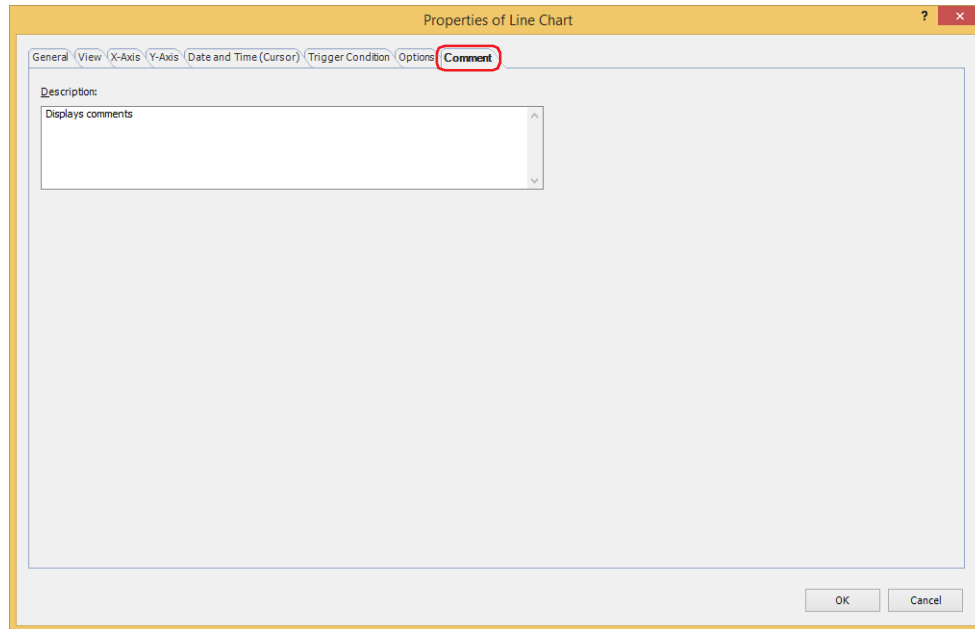

■ Description

Used for entering comments about parts. Maximum number is 80 characters.

Example: When mousing over the line chart on the editing screen

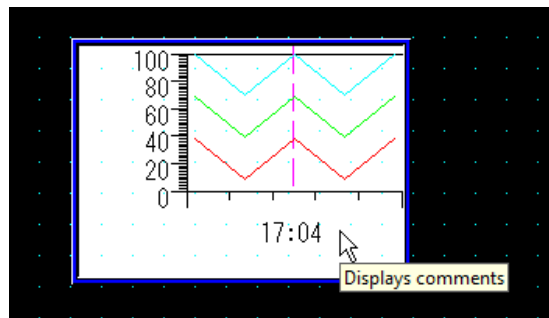

3 Pie Chart

HG2J-7U HG5G-V HG4G-V HG4G HG3G-V HG3G HG2G-V HG2G-5F HG2G-5T HG1G HG1P

3.1 How the Pie Chart is Used

The stacked bar chart and pie chart are used to show the proportion of individual data to the sum of the data. They can be used to check the relative change in multiple values of device addresses in real-time.

- Display the proportion of the sum of multiple values of device addresses in a stacked bar chart or a pie chart

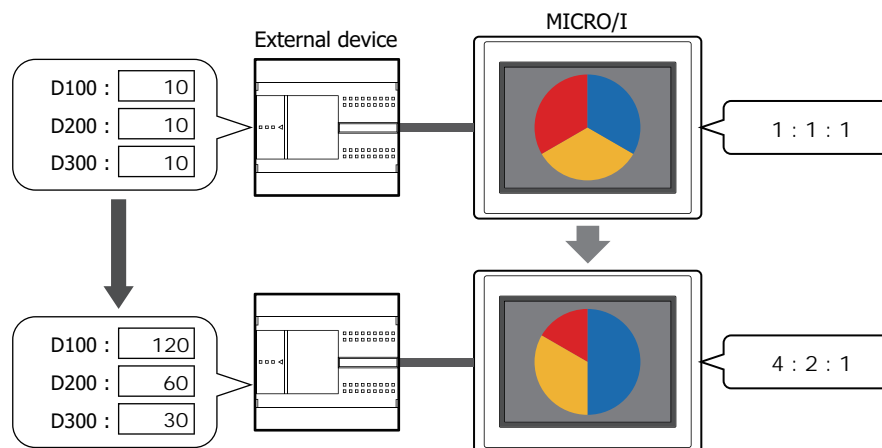

If the source data is all 0, the chart shows the same proportion for all the data.

3.2 Pie Chart Configuration Procedure

This section describes the configuration procedure for pie charts.

- 1 On the **Home** tab, in the **Parts** group, click **Charts**, and then click **Pie Chart**.

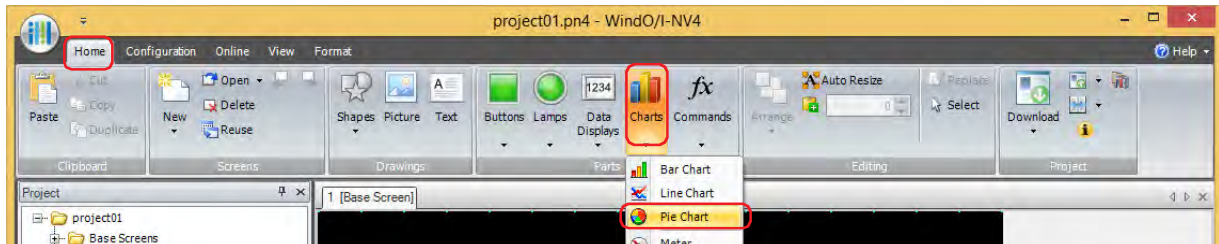

- 2 Click a point on the edit screen where you wish to place the Pie Chart.
- 3 Double-click the placed Pie Chart and a Properties dialog box will be displayed.
- 4 Change the settings on each tab as necessary.

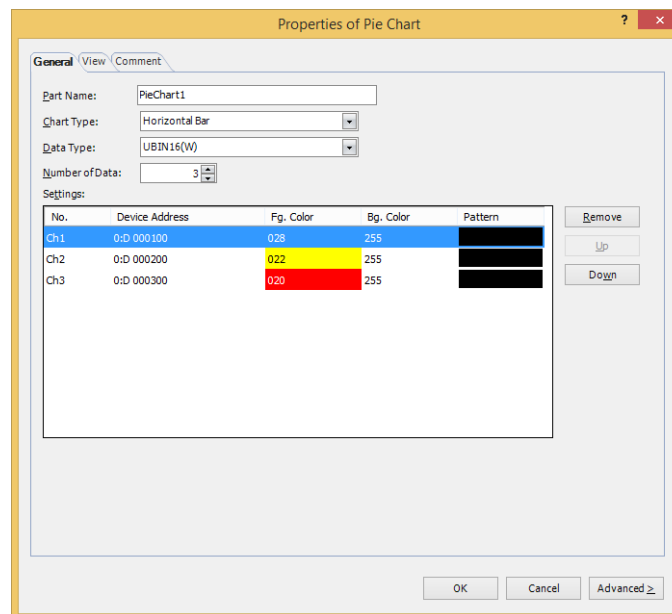

The **Options** tab only appears in Advanced mode.



You can set the default for the Pie Chart on the **Default Preferences** tab of the **WindO/I-NV4 Options** dialog box. For details, refer to Chapter 2 "Default Preferences Tab" on page 2-63.

3.3 Properties of Pie Chart Dialog Box

This section describes items and buttons in the Properties dialog box.

● **General Tab**

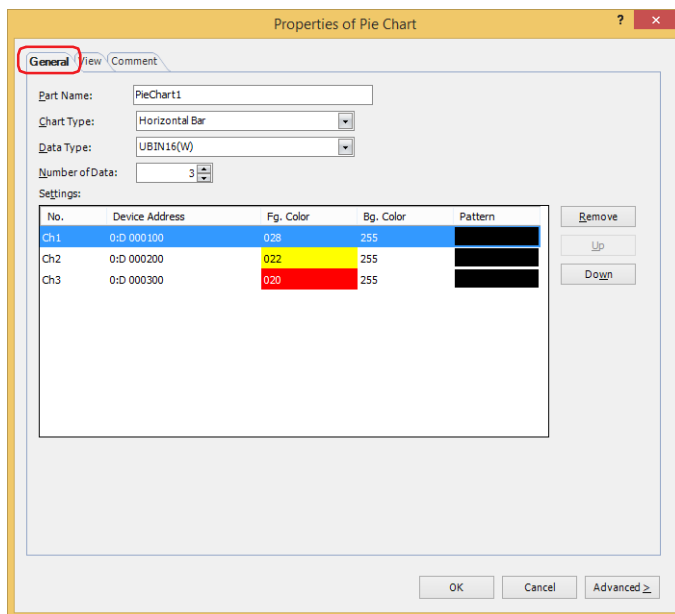

■ **Part Name**

Enter a name for the part. The maximum number is 20 characters.

■ **Chart Type**

Select the type of chart from the following items.

Horizontal Bar: Shows the proportion of the sum of the data as a horizontal stacked bar chart.

Example: When displaying the values for three device addresses

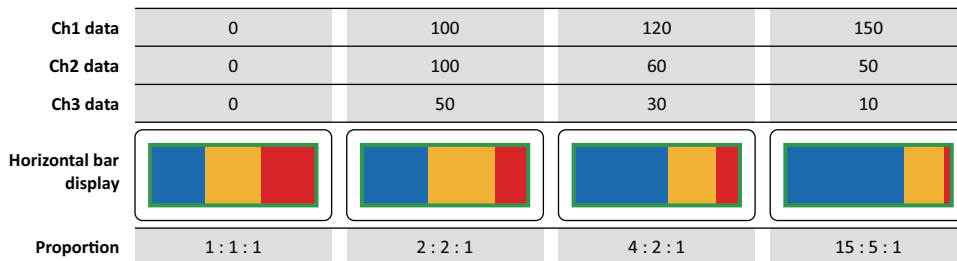

Vertical Bar: Shows the proportion of the sum of the data as a vertical stacked bar chart.

Example: When displaying the values for three device addresses

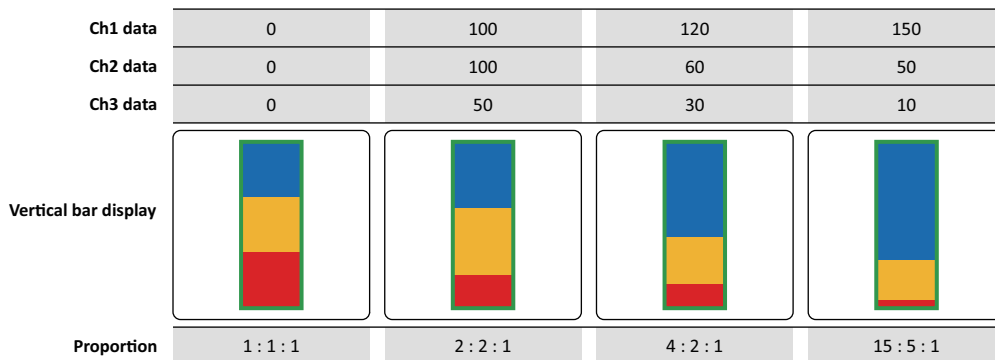

Pie: Shows the proportion of the sum of the data as a pie chart.
 Example: When displaying the values for three device addresses

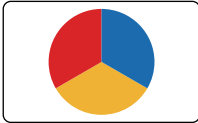
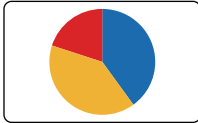
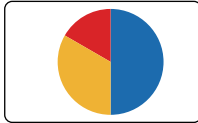
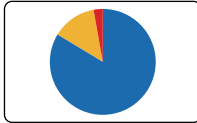
Ch1 data	0	100	120	300
Ch2 data	0	100	60	50
Ch3 data	0	50	30	10
Pie chart display				
Proportion	1 : 1 : 1	2 : 2 : 1	4 : 2 : 1	30 : 5 : 1

Data Type

Selects the data type handled by the chart from the following.

UBIN16(W), UBIN32(D), BCD4(B), BCD8(EB), Float32(F)

For details, refer to Chapter 2 "1.1 Available Data" on page 2-1.



When the **BCD4(B), BCD8(EB), or Float32(F)** is selected as **Data Type** and the value cannot be expressed with the data type selected for the data that was read, 1 is written to System Area 2 Processing Error bit (address number+2, bit 5), and an error message is displayed. For details, refer to Chapter 4 "Processing error" on page 4-32 and Chapter 36 "Processing error" on page 36-3.

Number of Data

Specifies the number of items of data to chart (1 to 10).

Settings

Lists the chart settings. The list shows the numbers, source device addresses, and colors for the chart.

No.: Shows the numbers for the chart (Ch1 to Ch10).

For **Horizontal Bar**, the numbers are listed in order from the left. For **Vertical Bar**, the numbers are listed in order from the top.

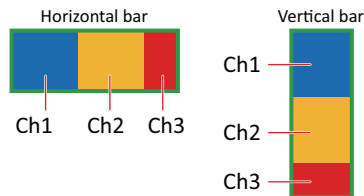

For **Pie**, the numbers are listed clockwise.

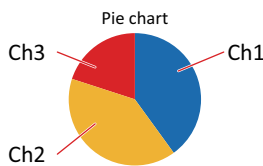

Device Address: Specifies the source word device for the data to display in the chart.

Double clicking the cell displays the Tag Editor where you can edit the device address. For the device address configuration procedure, refer to Chapter 2 "5.1 Device Address Settings" on page 2-70.

Fg. Color: Selects the foreground color of the chart. (color: 256 colors, monochrome: 16 shades)
 Double clicking the cell displays the Color Palette where you can change the foreground color of the chart.

Bg. Color: Selects the background color of the chart. (color: 256 colors, monochrome: 16 shades)
 Double clicking the cell displays the Color Palette where you can change the background color of the chart.

Pattern: Selects the chart pattern.
 Double clicking the cell displays the Pattern Palette where you can change the chart pattern.

- **Remove**
Deletes the registered settings from the list.
- **Up**
Shifts the selected settings upward in the list.
- **Down**
Shifts the selected settings downward in the list.

● **View Tab**

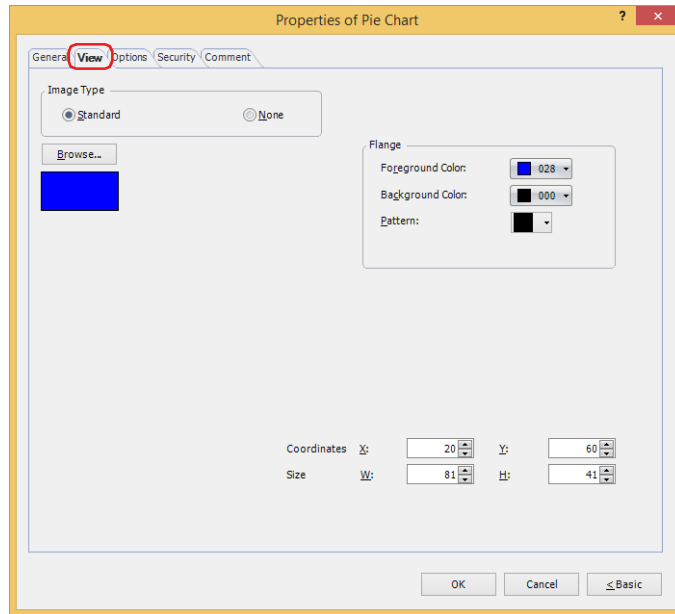

■ **Image Type**

Select the type of graphic to be used to represent the part.

Standard: Uses the default graphic for WindO/I-NV4.

None: The plate and the flange of the part are not displayed.

■ **Browse**

Select the type of graphic to be used to represent the part from the list of graphics. Click this button to display the View Browser.

■ **Flange**

Foreground Color, Background Color: Selects the foreground and background colors of the flange of the standard graphic (color: 256 colors, monochrome: 16 shades).

Click **Color** to display the Color Palette. Select a color from the Color Palette.

Pattern: Selects a pattern for the flange of the standard graphic.

Click **Pattern** to display the Pattern Palette. Select a pattern from the Pattern Palette.



■ **Coordinates**

X, Y: Sets the display position of parts using coordinates.

The X and Y coordinates of parts are defined relative to an origin at the top-left corner of the screen.

X: 0 to (base screen horizontal size - 1)

Y: 0 to (base screen vertical size - 1)

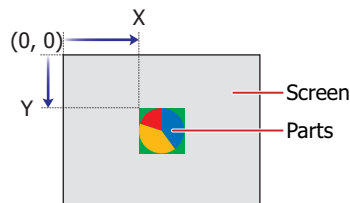

■ Size

W, H: Sets width and height to define the size of parts.

W: 5 to (base screen horizontal size)

H: 5 to (base screen vertical size)

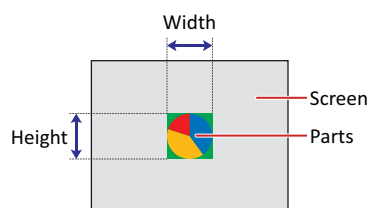

● Options Tab

The **Options** tab is displayed in Advanced mode.

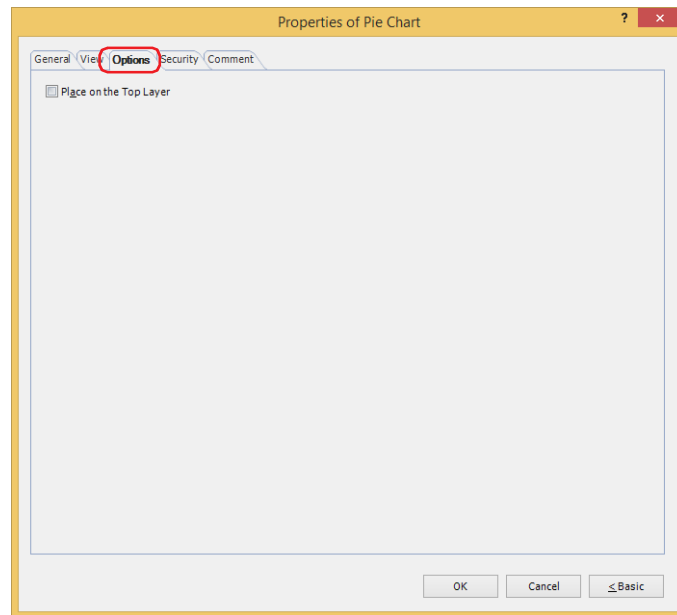

■ Place on the Top Layer

Select this check box to display the parts on the top layer. The parts will have precedence when other drawings and parts are overlapping with it. For details, refer to Chapter 6 "4 Drawings and Parts Overlapping" on page 6-5.

● Security Tab

This tab is used to restrict displaying and using the part by security groups.

This option can only be set when **Use Security functions** is selected. The **Use Security functions** check box is set on **General** tab in the **Security** dialog box.

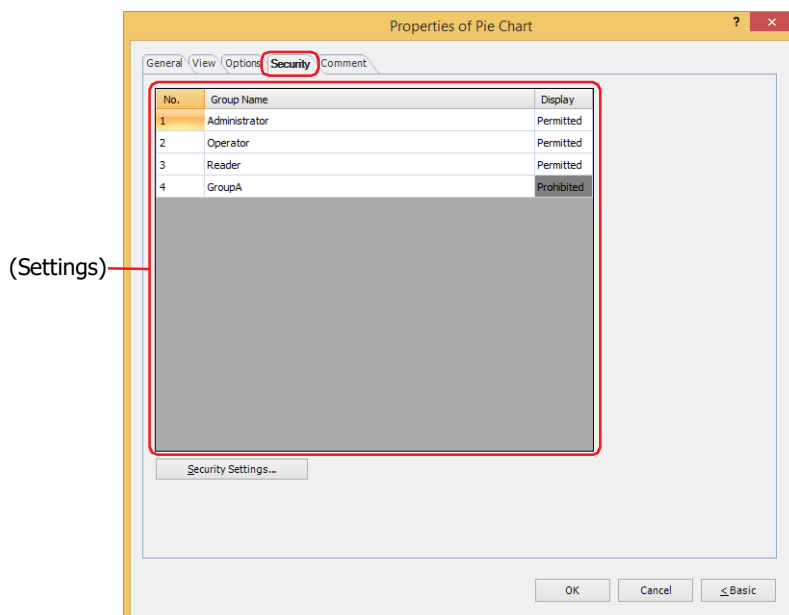

■ (Settings)

Displays the list of security groups used on the MICRO/I.

No.:	Displays the security group numbers (1 to 15).
Group Name:	Displays the name of the security group.
Display:	Displays whether or not there is permission to display the part. Only Permitted security groups can display this part. If all security groups are set to Permitted , this part will be displayed even if no user account has been selected. Double clicking the cell switches between Permitted and Prohibited .



You can also switch between **Permitted** and **Prohibited** by right-clicking on a **Display** cell.



■ Security Settings

The Security Settings dialog box is displayed. If you create a security group in the **Security Settings** dialog box, you can select that created group. For details, refer to Chapter 23 "2.2 Adding and Editing Security Groups" on page 23-19.



For details about security functions, refer to Chapter 23 "User Accounts and the Security Function" on page 23-1.

Example: If the user and security group for a part are set as follows:

User Name	 User1	 User2
Security Group	Reader	Operator

Line Chart and Bar Chart

No.	Group Name	Display
1	Administrator	Permitted
2	Operator	Permitted
3	Reader	Prohibited

MICRO/I

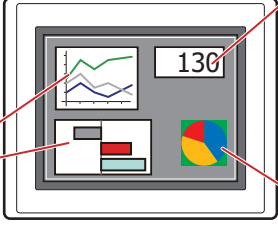

Numerical Display

No.	Group Name	Display
1	Administrator	Permitted
2	Operator	Permitted
3	Reader	Permitted

Pie Chart

No.	Group Name	Display
1	Administrator	Permitted
2	Operator	Permitted
3	Reader	Prohibited

For User1 in the **Reader** security group, the parts for which **Display** has been set to **Prohibited** for **Reader** will not be displayed.

If the password screen is opened and the user switches to User2 in the **Operator** security group, the parts for which **Display** has been set to **Permitted** for **Operator** will be displayed.

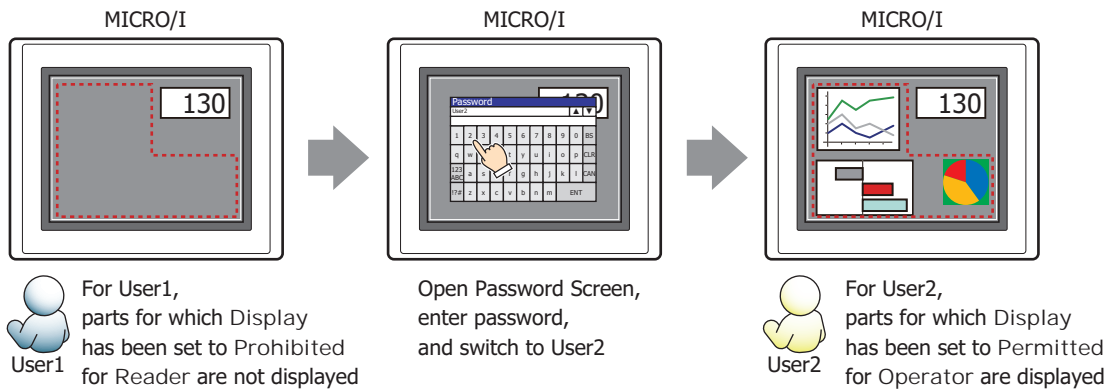

● Comment Tab

The **Comment** tab is used to specify the parts placed on the editing screen, and the popup text displayed when the mouse pointer is placed close to **No.**, **Name**, or **Type** in the object list.



When there are multiple parts of the same shape on the screen, this features makes it possible to distinguish between the parts without displaying the Properties dialog box for each part, by just mousing over the part.

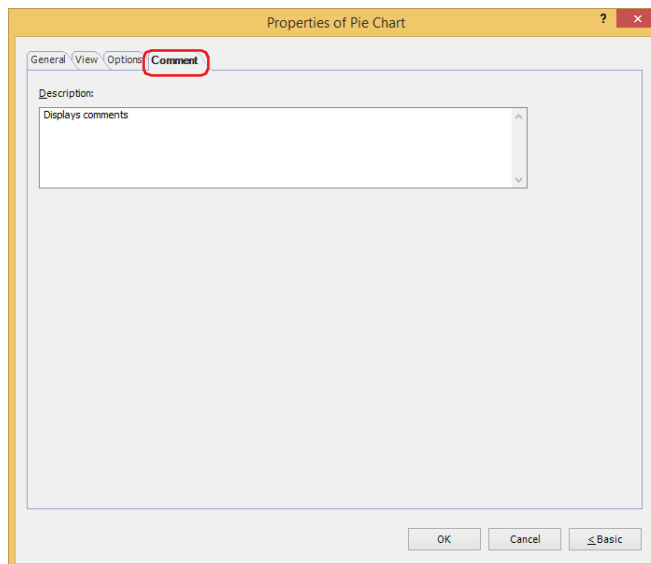

■ Description

Used for entering comments about parts. Maximum number is 80 characters.

Example: When mousing over the pie chart on the editing screen

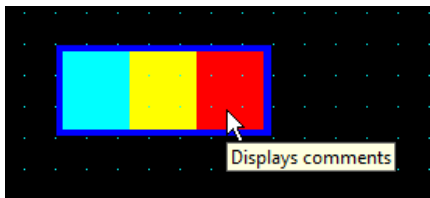

4 Meter

HG2J-7U HG5G-V HG4G-V HG4G HG3G-V HG3G HG2G-V HG2G-5F HG2G-5T HG1G HG1P

4.1 How the Meter is Used

The meter displays the value of a word device as the movement of a needle.

- Display the value of a word device in a meter

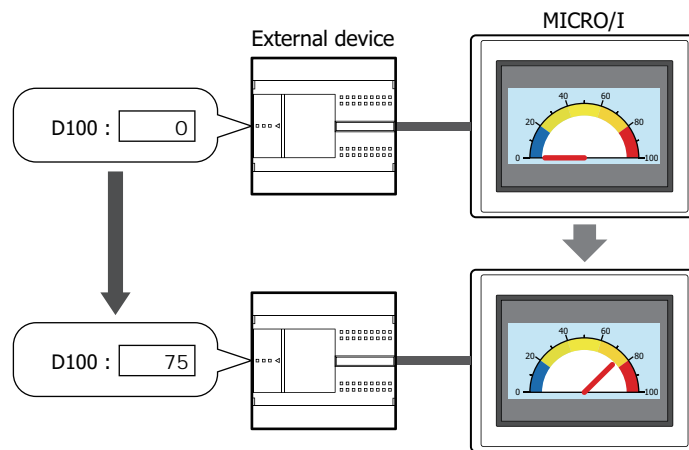

4.2 Meter Configuration Procedure

This section describes the configuration procedure for meters.

- 1 On the **Home** tab, in the **Parts** group, click **Charts**, and then click **Meter**.

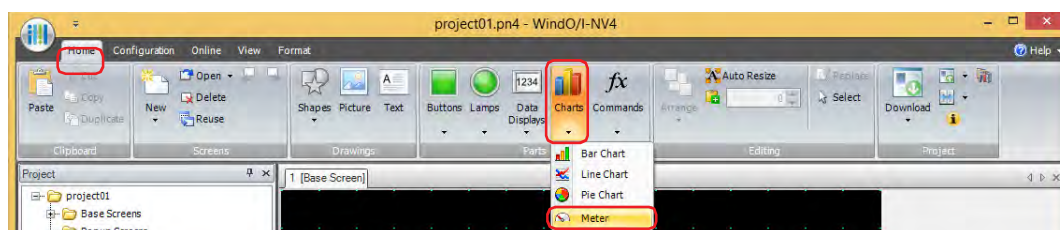

- 2 Click a point on the edit screen where you wish to place the Meter.
- 3 Double-click the placed Meter and a Properties dialog box will be displayed.
- 4 Change the settings on each tab as necessary.

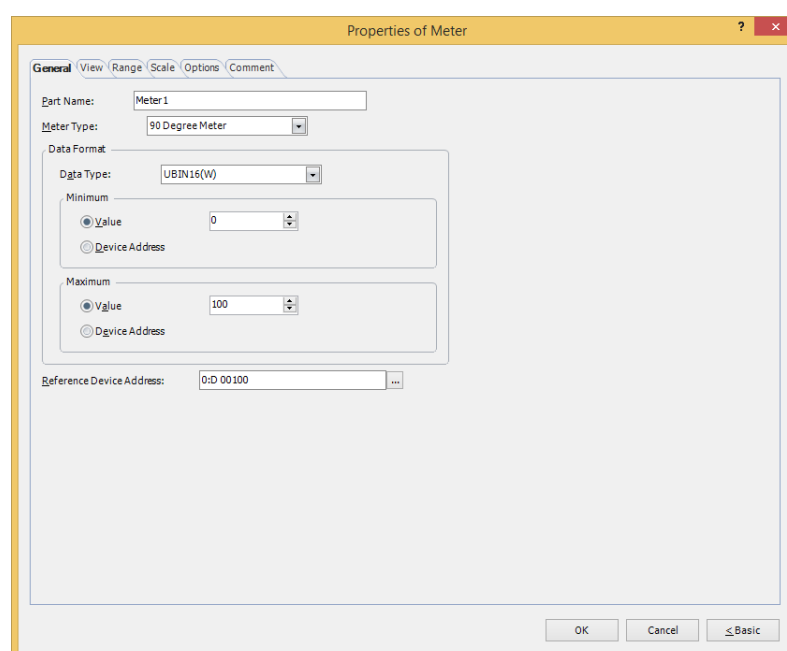

The **Range** tab, **Scale** tab and **Options** tab only appear in Advanced mode.



You can set the default for the Meter on the **Default Preferences** tab of the **WindO/I-NV4 Options** dialog box. For details, refer to Chapter 2 "Default Preferences Tab" on page 2-63.

4.3 Properties of Meter Dialog Box

This section describes items and buttons in the Properties dialog box.

● General Tab

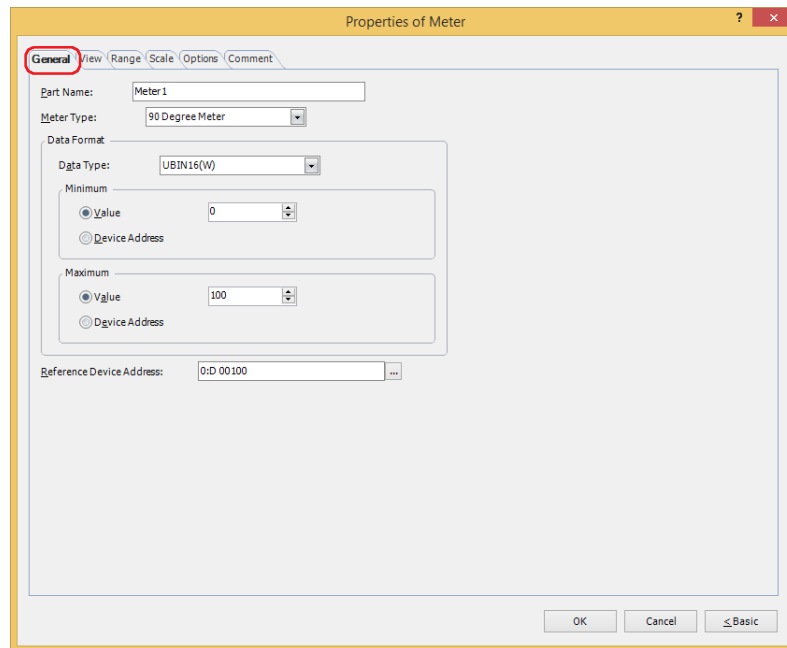

■ Part Name

Enter a name for the part. The maximum number is 20 characters.

■ Meter Type

Select the type of meter from the following items.

90 Degree Meter, 180 Degree Meter, 270 Degree Meter

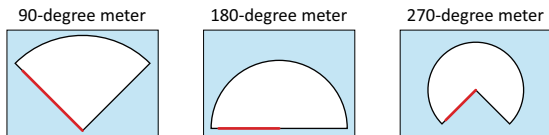

Example: **180 Degree Meter**

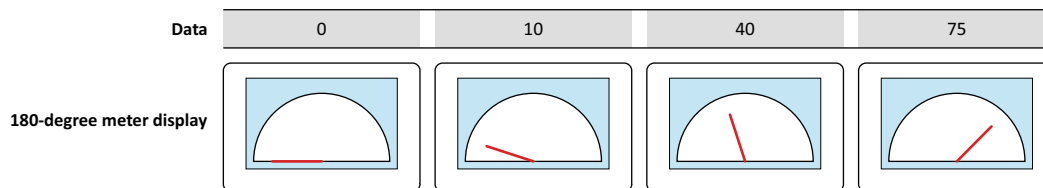

■ Data Format

Data Type: Selects the data type handled by the meter from the following.
UBIN16(W), BIN16(I), UBIN32(D), BIN32(L), BCD4(B), BCD8(EB), Float32(F)
 For details, refer to Chapter 2 "1.1 Available Data" on page 2-1.

Minimum, Maximum: Specifies the minimum and maximum for the data.

(Data Type): Selects the data type to use for the minimum and the maximum.

Value: Uses a constant value.

Device Address: Uses a value of device address.

The minimum and maximum vary based on the selected data type. For details, refer to Chapter 2 "1.1 Available Data" on page 2-1.

The needle does not move past the left edge when the data value is the minimum or lower.

The needle stops at the right edge when the data value is the maximum or higher.

When **Device Address** is selected for (Data Type), the minimum and maximum can be specified in the word device.

Click to display the Tag Editor. For the device address configuration procedure, refer to Chapter 2 "5.1 Device Address Settings" on page 2-70.



If the data displayed in the meter is invalid, 1 is written to System Area 2 Processing error bit (address number+2, bit 5), and an error message is displayed. For details, refer to Chapter 4 "Processing error" on page 4-32 and Chapter 36 "Processing error" on page 36-3.

An error occurs in the following states:

- The setting of **Minimum, Maximum**, or ranges are invalid, or the **Minimum** and **Maximum** are the same values.
- **Data Type** is **BCD4(B), BCD8(EB)**, or **Float32(F)** and the value cannot be expressed with the data type selected for the read data

If an error occurs, only the flange is initially displayed. Then once the meter is displayed, it doesn't show an update.

■ Reference Device Address

Specifies the source word device for the data to display in the meter.

Click to display the Tag Editor. For the device address configuration procedure, refer to Chapter 2 "5.1 Device Address Settings" on page 2-70.

● View Tab

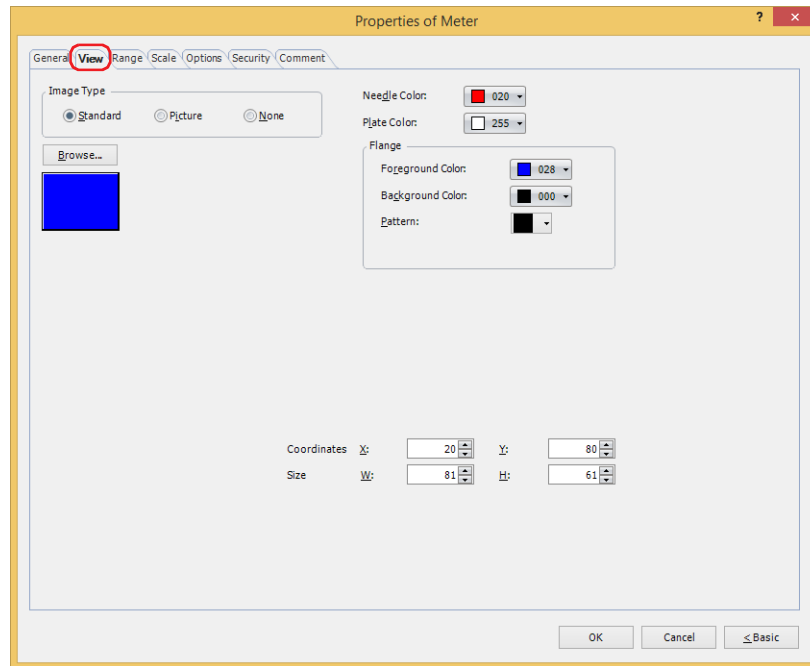

■ Image Type

Select the type of graphic to be used to represent the part.

Standard: Uses the default graphic for WindO/I-NV4.

Picture: Uses an image file saved using Picture Manager.

For details about image file restrictions, refer to Chapter 2 "1.4 Available Image Files" on page 2-20.

None: The plate and the flange of the part are not displayed.

■ Browse

Select the type of graphic to be used to represent the part from the list of graphics. Click this button to display the View Browser or Picture Manager, depending on the setting for **Image Type**.

■ Needle Color

Selects the needle color of the Meter (color: 256 colors, monochrome: 16 shades).

Click **Color** to display the Color Palette. Select a color from the Color Palette.



■ Plate Color

Selects the plate color of the standard graphic (color: 256 colors, monochrome: 16 shades).

Click **Color** to display the Color Palette. Select a color from the Color Palette.



■ Flange

Foreground Color, Background Color: Selects the foreground and background colors of the flange of the standard graphic (color: 256 colors, monochrome: 16 shades).

Click **Color** to display the Color Palette. Select a color from the Color Palette.

Pattern: Selects a pattern for the flange of the standard graphic.

Click **Pattern** to display the Pattern Palette. Select a pattern from the Pattern Palette.



■ Coordinates

X, Y: Sets the display position of parts using coordinates.

The X and Y coordinates of parts are defined relative to an origin at the top-left corner of the screen.

X: 0 to (base screen horizontal size - 1)

Y: 0 to (base screen vertical size - 1)

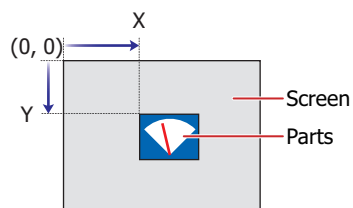

■ Size

W, H: Sets width and height to define the size of parts.

W: 5 to (base screen horizontal size)

H: 5 to (base screen vertical size)

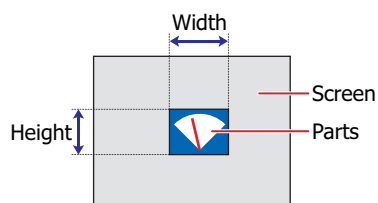

● Range Tab

The **Range** tab is only displayed in Advanced mode.

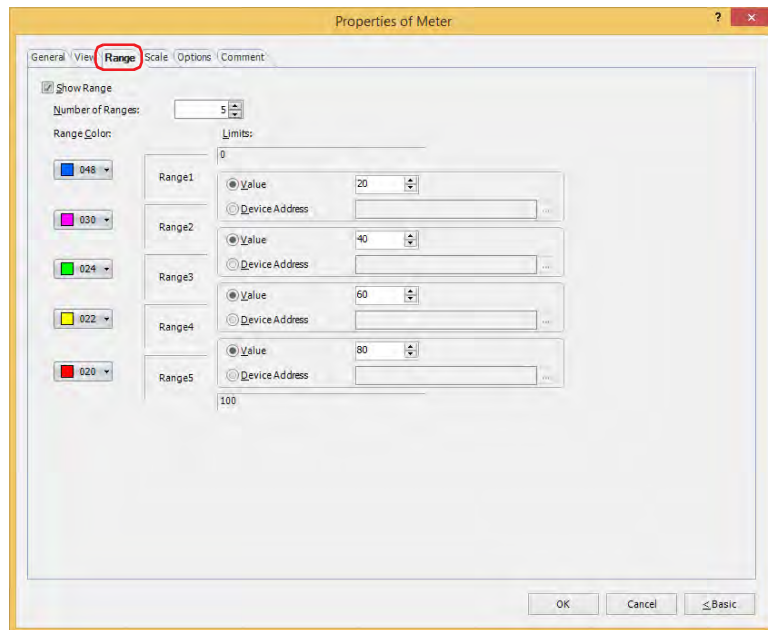

■ Show Range

Select this check box to show ranges on the meter and configure the number of ranges, range colors, and limits. Ranges can only be configured when **Standard** or **None** is selected under **Image Type** on the **View** tab.

Number of Ranges: Specifies the number of ranges (1 to 5).

Range Color: Selects the range color (color: 256 colors, monochrome: 16 shades). Click this button to display the Color Palette. Select a color from the Color Palette.

Limits: Specifies the limit for the range.

(Data Type): Selects the data type to use for the limit.

Value: Uses a constant value.

Device Address: Uses a value of device address.

The limit varies based on the data type selected with **Data Format** on the **General** tab. For details, refer to Chapter 2 "1.1 Available Data" on page 2-1.

When **Device Address** is selected for (Data Type), the minimum and maximum can be specified in the word device.

Click **...** to display the Tag Editor. For the device address configuration procedure, refer to Chapter 2 "5.1 Device Address Settings" on page 2-70.



If the data displayed in the meter is invalid, 1 is written to System Area 2 Processing error bit (address number+2, bit 5), and an error message is displayed. For details, refer to Chapter 4 "Processing error" on page 4-32 and Chapter 36 "Processing error" on page 36-3.

An error occurs in the following states:

- The setting of **Minimum**, **Maximum**, or ranges are invalid, or the **Minimum** and **Maximum** are the same values.
- **Data Type** is **BCD4(B)**, **BCD8(EB)**, or **Float32(F)** and the value cannot be expressed with the data type selected for the read data

If an error occurs, only the flange is initially displayed. Then once the meter is displayed, it doesn't show an update.

Example: 180-degree meter, data minimum is 0, maximum is 100, the number of ranges is set to 5

The limit between range 1 and 2: 20

The limit between range 2 and 3: 40

The limit between range 3 and 4: 60

The limit between range 4 and 5: 80

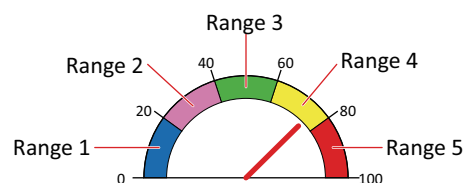

● Scale Tab

The **Scale** tab is displayed in Advanced mode.

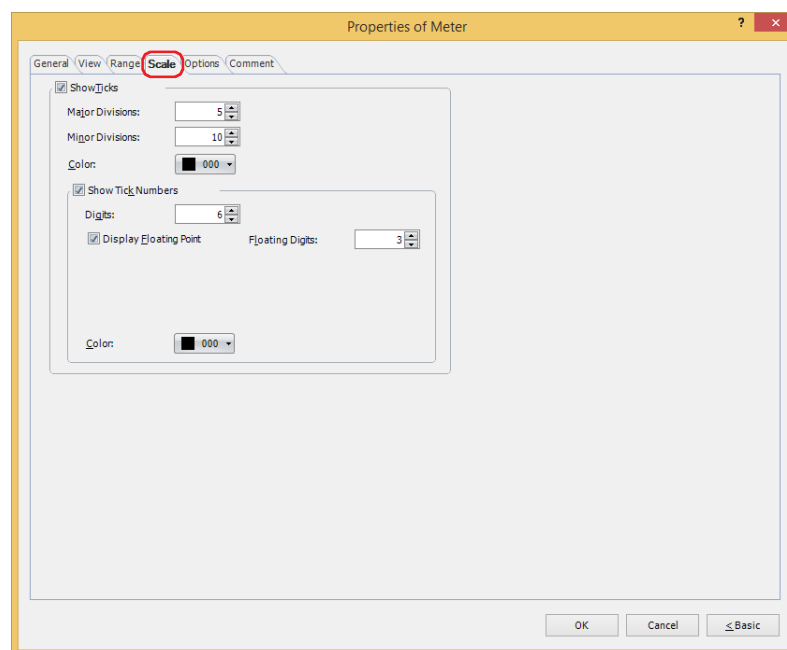

■ Show Ticks

Select this check box to display a scale on a or meter.

Scales can only be configured when **Standard** or **None** is selected under **Image Type** on the **View** tab.

Major Divisions: Enter the number of major scale divisions (1 to 20).

Minor Divisions: Enter the number of minor scale divisions (1 to 20).

Color: Selects the color of scales (color: 256 colors, monochrome: 16 shades). Click **Color** to display the Color Palette. Select a color from the Color Palette.

Show Tick Numbers: Select this check box to display numbers along the scale.

Digits: Sets the number of digits to be displayed (1 to 10). Can only be set when **Float32(F)** is selected for **Data Type** under the **General** tab.

Display Floating Point: Select this check box to display a floating point along the scale. Can only be set when **Float32(F)** is selected for **Data Type** under the **General** tab.

Floating Digits: Sets the number of digits for the fractional parts of numbers (1 to 8) from the number of digits specified for **Digits**. Can only be set when the **Display Floating Point** check box is selected.

Color: Selects the color of displayed text (color: 256 colors, monochrome: 16 shades). Click **Color** to display the Color Palette. Select a color from the Color Palette.



- If the area for displaying the scale is small, the scale will not be displayed properly.
- When the standard graphic **F0001**, **F0101**, or **F0201 (no flange)** are selected, the scale cannot be configured.

● Options Tab

The **Options** tab is displayed in Advanced mode.

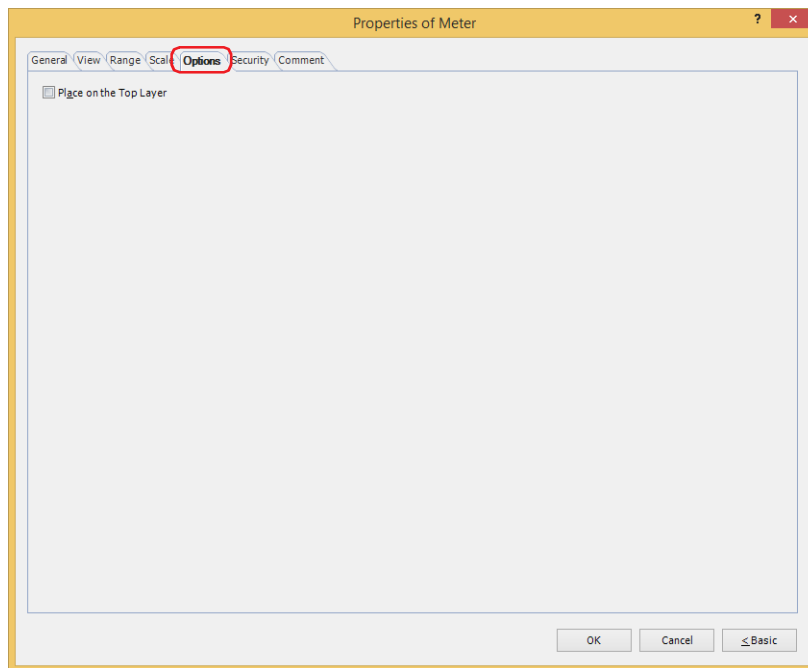

■ Place on the Top Layer

Select this check box to display the parts on the top layer. The parts will have precedence when other drawings and parts are overlapping with it. For details, refer to Chapter 6 "4 Drawings and Parts Overlapping" on page 6-5.

● Security Tab

This tab is used to restrict displaying and using the part by security groups.

This option can only be set when **Use Security functions** is selected. The **Use Security functions** check box is set on **General** tab in the **Security** dialog box.

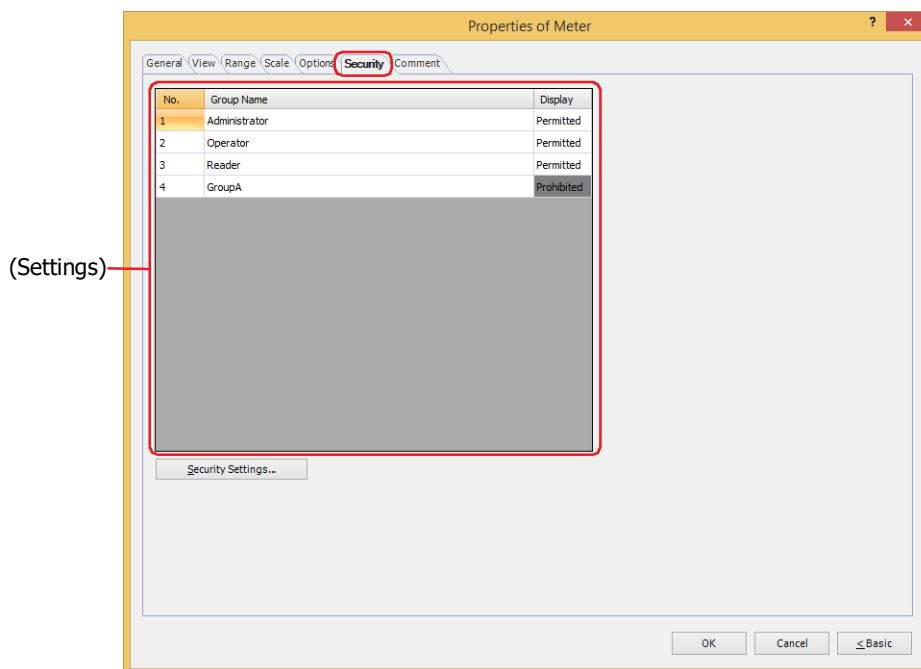

■ (Settings)

Displays the list of security groups used on the MICRO/I.

No.: Displays the security group numbers (1 to 15).

Group Name: Displays the name of the security group.

Display: Displays whether or not there is permission to display the part. Only **Permitted** security groups can display this part. If all security groups are set to **Permitted**, this part will be displayed even if no user account has been selected. Double clicking the cell switches between **Permitted** and **Prohibited**.



You can also switch between **Permitted** and **Prohibited** by right-clicking on a **Display** cell.



■ Security Settings

The Security Settings dialog box is displayed. If you create a security group in the **Security Settings** dialog box, you can select that created group. For details, refer to Chapter 23 "2.2 Adding and Editing Security Groups" on page 23-19.



For details about security functions, refer to Chapter 23 "User Accounts and the Security Function" on page 23-1.

Example: If the user and security group for a part are set as follows:

User Name	 User1	 User2
Security Group	Reader	Operator

Line Chart and Bar Chart

No.	Group Name	Display
1	Administrator	Permitted
2	Operator	Permitted
3	Reader	Prohibited

MICRO/I

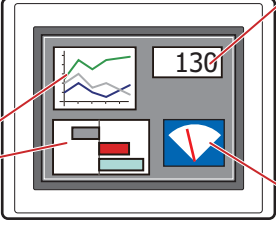

Numerical Display

No.	Group Name	Display
1	Administrator	Permitted
2	Operator	Permitted
3	Reader	Permitted

Meter

No.	Group Name	Display
1	Administrator	Permitted
2	Operator	Permitted
3	Reader	Prohibited

For User1 in the **Reader** security group, the parts for which **Display** has been set to **Prohibited** for **Reader** will not be displayed.

If the password screen is opened and the user switches to User2 in the **Operator** security group, the parts for which **Display** has been set to **Permitted** for **Operator** will be displayed.

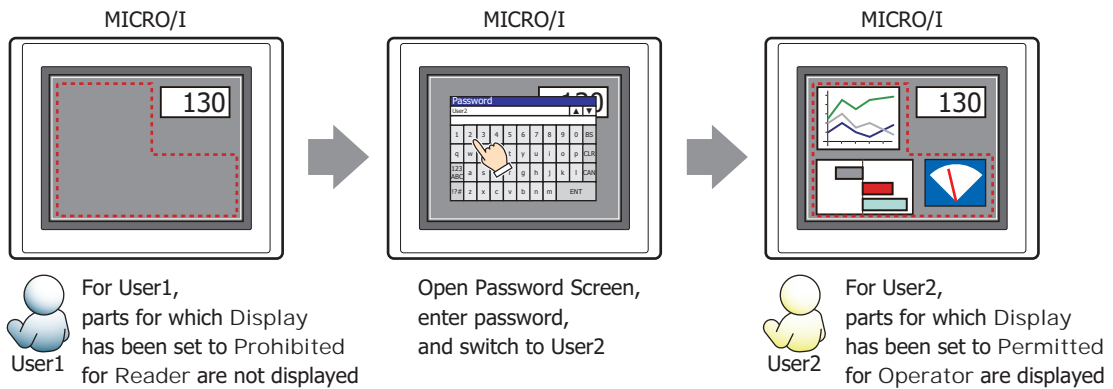

● Comment Tab

The **Comment** tab is used to specify the parts placed on the editing screen, and the popup text displayed when the mouse pointer is placed close to **No.**, **Name**, or **Type** in the object list.



When there are multiple parts of the same shape on the screen, this features makes it possible to distinguish between the parts without displaying the Properties dialog box for each part, by just mousing over the part.

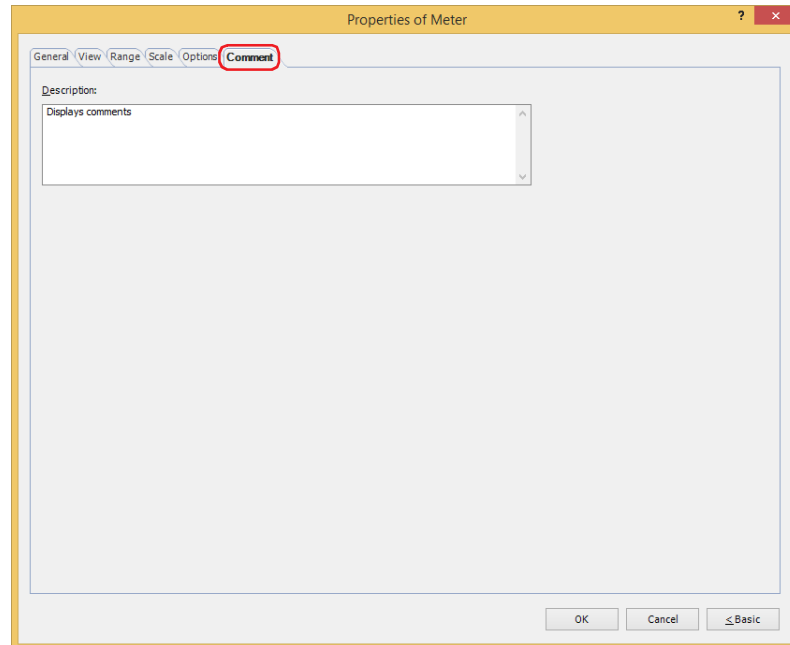

■ Description

Used for entering comments about parts. Maximum number is 80 characters.

Example: When mousing over the meter on the editing screen

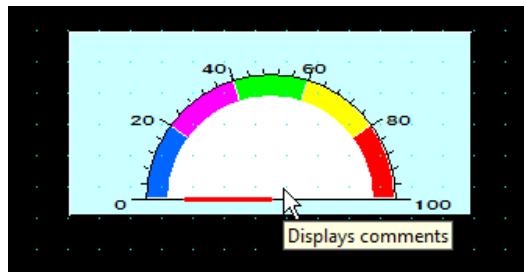

Chapter 12 Commands

This chapter describes how to setup commands and their operation on the MICRO/I.

1 Bit Write Command

HG2J-7U HG5G-V HG4G-V HG4G HG3G-V HG3G HG2G-V HG2G-5F HG2G-5T HG1G HG1P

1.1 How the Bit Write Command is Used

Writes a 0 or 1 to a bit device.

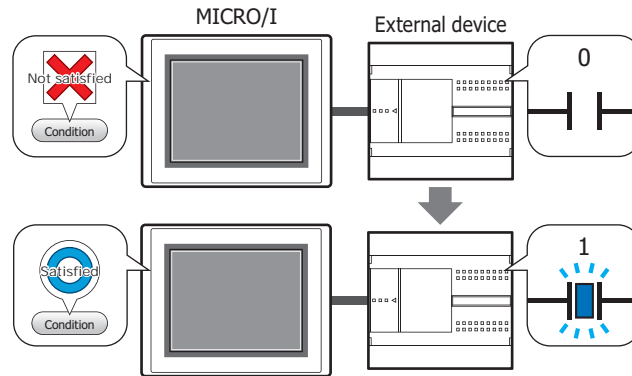

■ Set

Writes a 1 to the specified bit device when the trigger condition is satisfied.

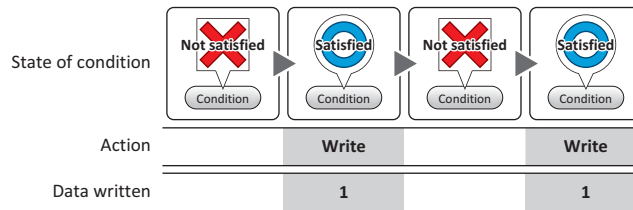

■ Reset

Writes a 0 to the specified bit device when the trigger condition is satisfied.

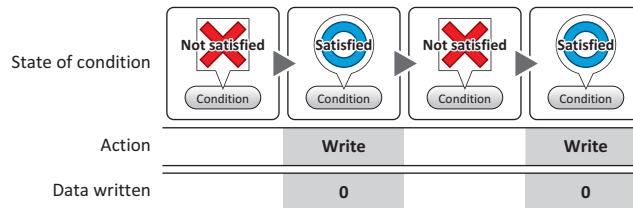

■ Momentary

Writes a 1 to the specified bit device when the trigger condition is satisfied.

When the trigger condition is no longer satisfied, a 0 is written to the specified bit device.

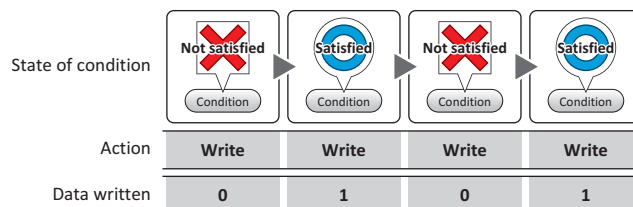

■ **Toggle**

Toggles the value of the specified bit device when the trigger condition is satisfied.

If the value of the bit device is 0 it changes to 1, and vice versa.

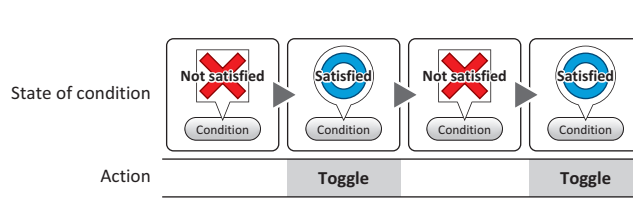

■ **Move**

This function writes the value in the source bit device to the value in the destination bit device when the trigger condition is satisfied.

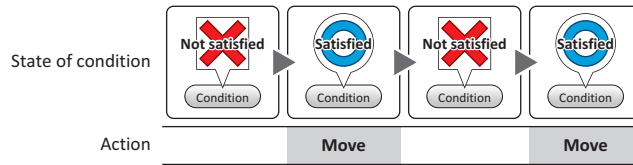

1.2 Bit Write Command Configuration Procedure

This section describes the configuration procedure for the Bit Write Command.

- 1 On the **Home** tab, in the **Parts** group, click **Commands**, and then click **Bit Write Command**.

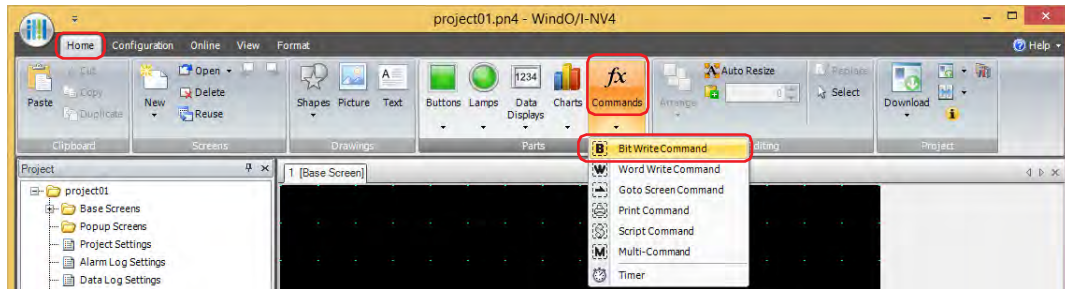

- 2 Click a point on the edit screen where you wish to place the Bit Write Command.
- 3 Double-click the placed Bit Write Command and a Properties dialog box will be displayed.
- 4 Change the settings on each tab as necessary.

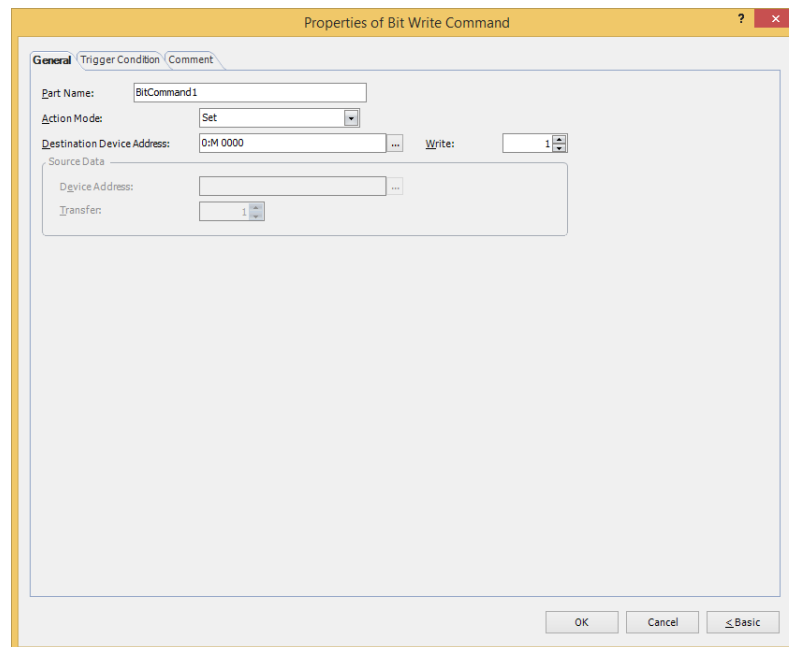

1.3 Properties of Bit Write Command Dialog Box

This section describes items and buttons in the Properties dialog box.

● General Tab

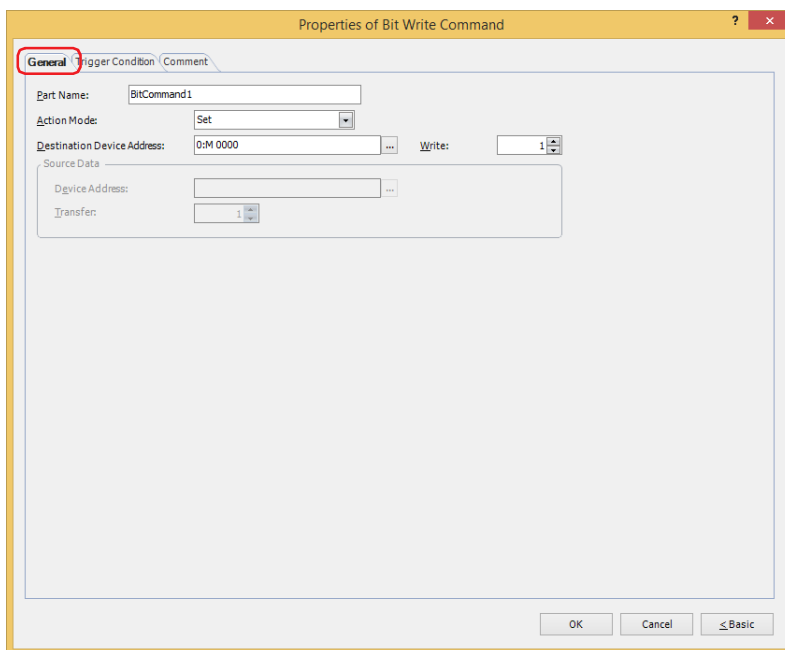

■ Part Name

Enter a name for the part. The maximum number is 20 characters.

■ Action Mode

Select the action to perform when the trigger condition is satisfied from the following:

Set: Writes a 1 to the specified bit device when the trigger condition is satisfied.

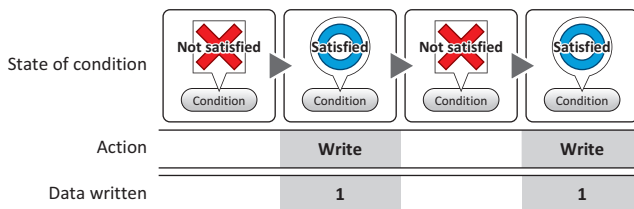

Reset: Writes a 0 to the specified bit device when the trigger condition is satisfied.

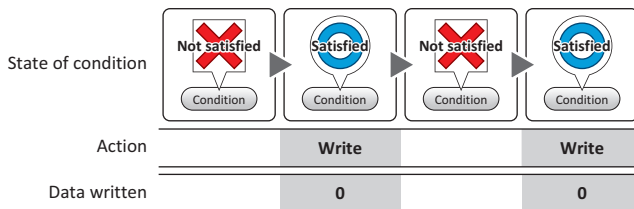

Momentary: Writes a 1 to the specified bit device when the trigger condition is satisfied. When the trigger condition is no longer satisfied, a 0 is written to the specified bit device.

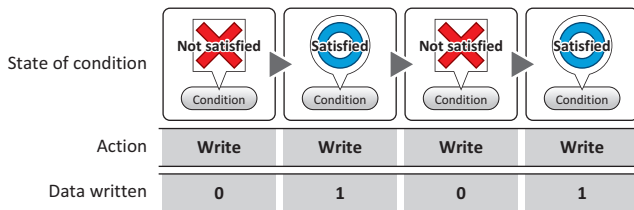

Toggle: Toggles the value of the specified bit device when the trigger condition is satisfied. If the value of the bit device is 0 it changes to 1, and vice versa.

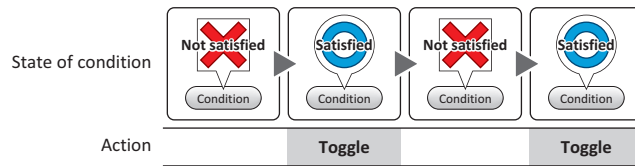

Move: This function writes the value in the source bit device to the value in the destination bit device when the trigger condition is satisfied.

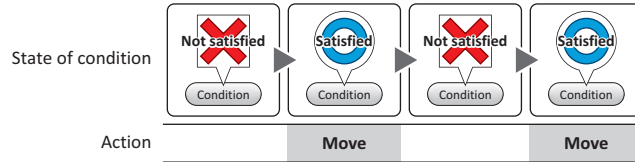

■ **Destination Device Address**

Specify the destination bit device.

Click to display the Tag Editor. For the device address configuration procedure, refer to Chapter 2 “5.1 Device Address Settings” on page 2-70.

■ **Write*1**

Specify the number of bit devices (1 to 64) at the destination.

This setting is enabled only if **Action Mode** is set to **Set** or **Reset**.

Example: This fills a contiguous block of bit devices with the same value.

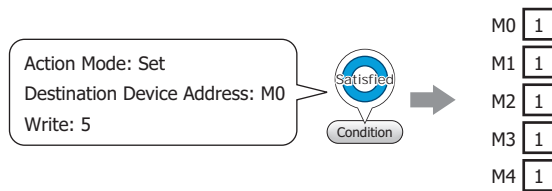

If the bit number in a word device is specified, the same value is written to same bit of contiguous word devices.

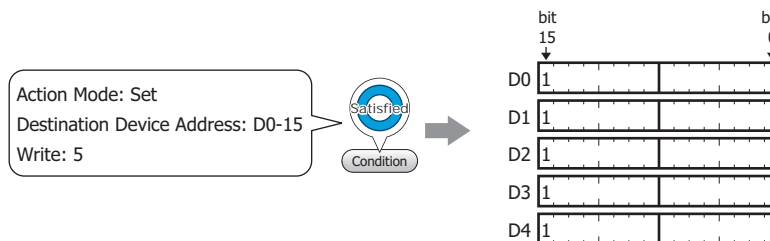

■ **Source Data**

Specifies the device address where the data to be written is stored.

This setting is enabled only if **Action Mode** is set to **Move**.

Device Address: Specify the source bit device.

Click to display the Tag Editor. For the device address configuration procedure, refer to Chapter 2 “5.1 Device Address Settings” on page 2-70.

Transfer: Specify the number of bit devices (1 to 64) to move.

Example: This button writes the values in a contiguous block of bit devices to a contiguous block of device addresses at the destination.

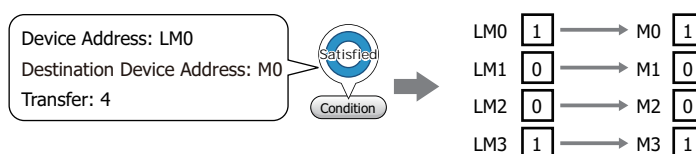

*1 Advanced mode only

● **Trigger Condition Tab**

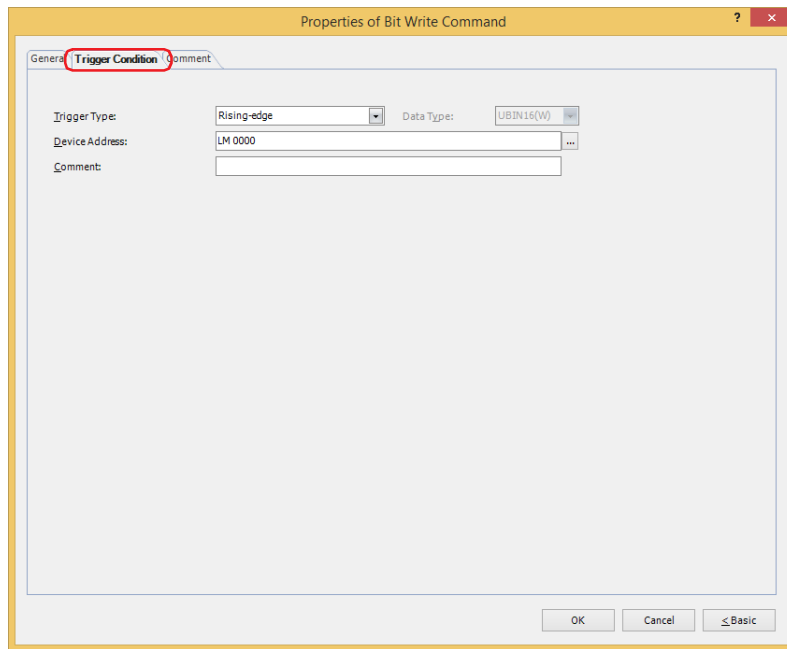

When the condition has been or is satisfied, the command is executed; when not satisfied, the command is not executed.

Example: When **Trigger Type** is **Rising-edge** and **Device Address** is **LM0**
 The command is executed when LM0 changes from 0 to 1.

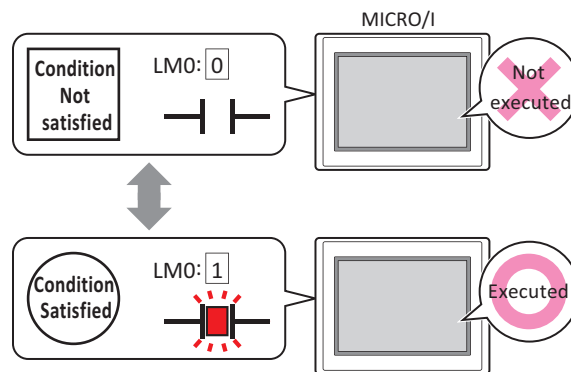

■ **Trigger Type**

Selects the condition to execute the command from the following.

Rising-edge:

Command is executed when a value of device address changes from 0 to 1.

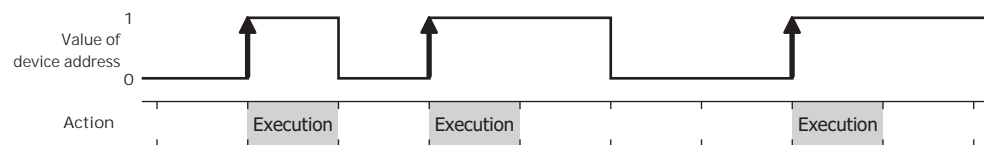

Falling-edge:

Command is executed when a value of device address changes from 1 to 0.

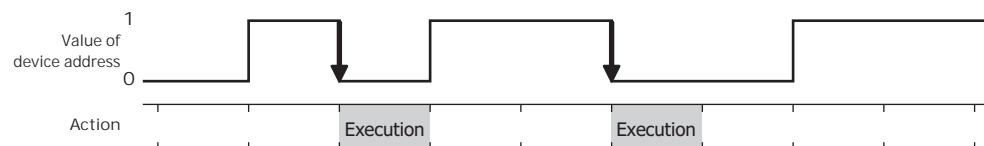

Satisfy the condition: Command is executed when condition changes from not satisfied to satisfied.

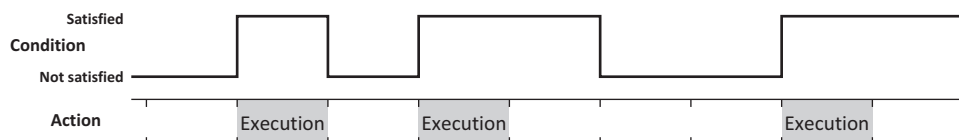

While satisfying the condition:

The command continues being executed while the condition is satisfied.

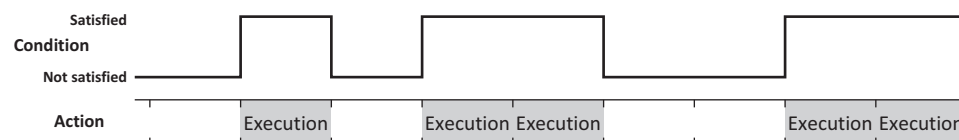

■ Data Type

Selects the data type to be handled by the condition formula.

Can only be set if **Satisfy the condition** or **While satisfying the condition** is selected as **Trigger Type**.

For details, refer to Chapter 2 "1.1 Available Data" on page 2-1.

■ Device Address

Specifies the bit device or the bit number of the word device to serve as condition.

Can only be set if **Rising-edge** or **Falling-edge** is selected as **Trigger Type**.

Click to display the Tag Editor. For the device address configuration procedure, refer to Chapter 2 "5.1 Device Address Settings" on page 2-70.

■ Condition

Specifies the conditional expression.

This option can only be configured when **Satisfy the condition** or **While satisfying the condition** is selected for **Trigger Type**.

Click to display the **Trigger Condition Settings** dialog box. For the conditional expression configuration procedure, refer to Chapter 2 "5.2 Setting Conditional Expressions" on page 2-73.

■ Comment

Used for entering comments about trigger conditions. The maximum number is 80 characters.

● **Comment** Tab

The **Comment** tab is used to specify the parts placed on the editing screen, and the popup text displayed when the mouse pointer is placed close to **No.**, **Name**, or **Type** in the object list.



When there are multiple parts of the same shape on the screen, this features makes it possible to distinguish between the parts without displaying the Properties dialog box for each part, by just mousing over the part.

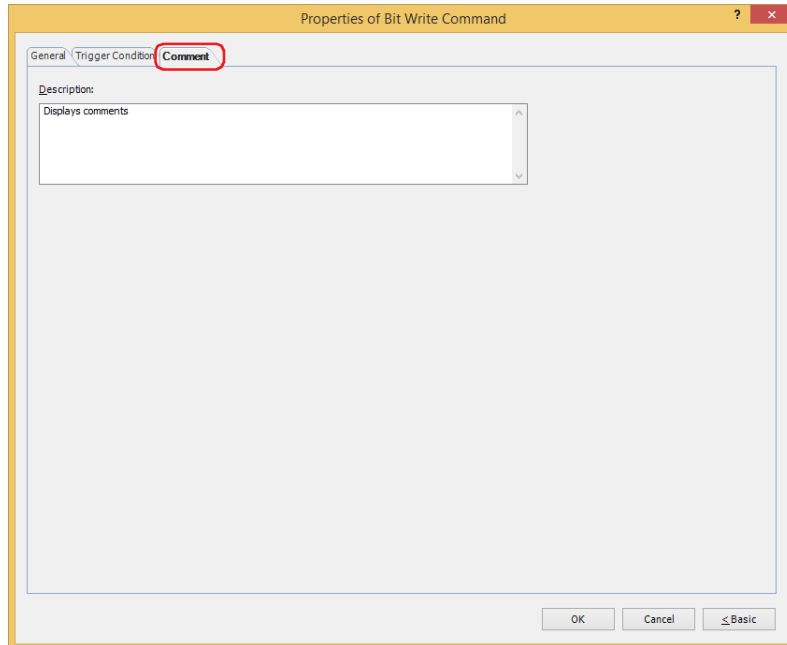

■ **Description**

Used for entering comments about parts. The maximum number is 80 characters.

Example: When mousing over the Bit Write Command on the editing screen

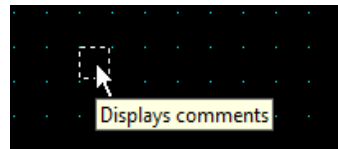

2 Word Write Command

HG2J-7U HG5G-V HG4G-V HG4G HG3G-V HG3G HG2G-V HG2G-5F HG2G-5T HG1G HG1P

2.1 How the Word Write Command is Used

Writes a value to a word device. Can be used to indirectly specify the destination address number or to perform operations on the written value.

- Writes a fixed value to a word device when the trigger condition is satisfied.

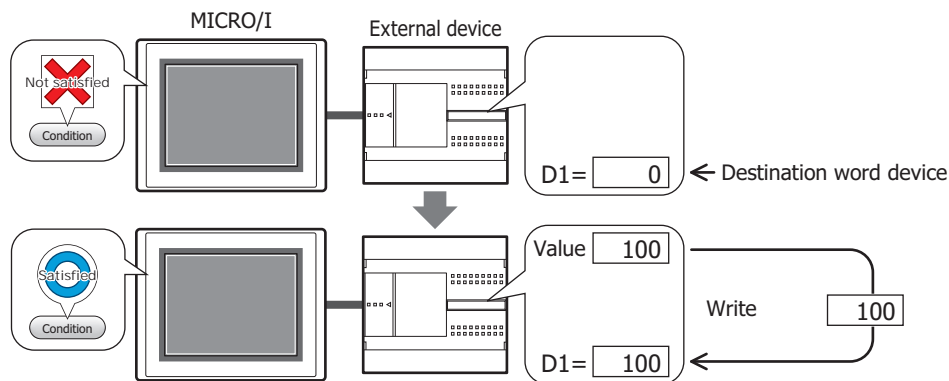

- Writes the value of device address to a word device when the trigger condition is satisfied.

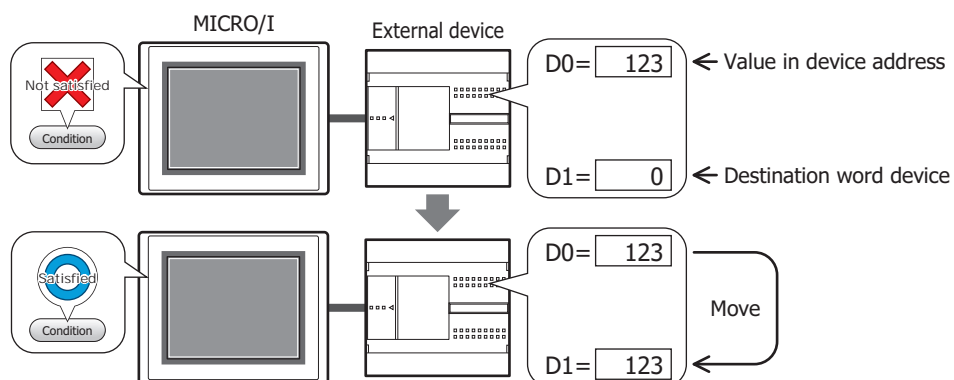

- Performs arithmetic on the value to write before writing it to a word device when the trigger condition is satisfied.

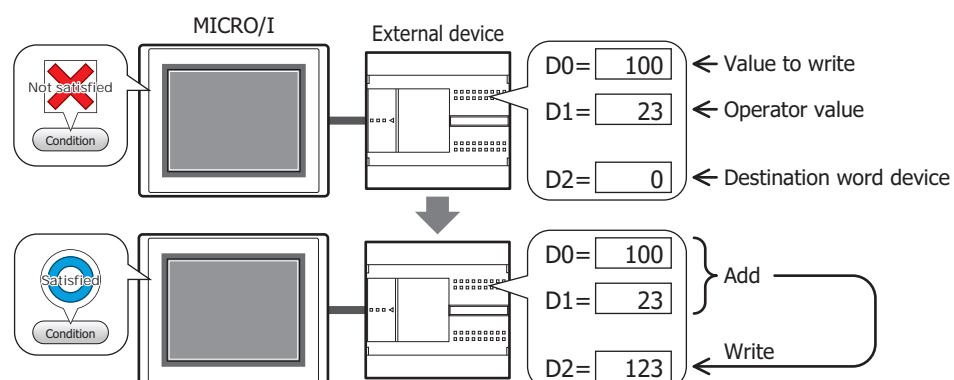

■ **Set**

Writes a fixed value to a word device when the trigger condition is satisfied.

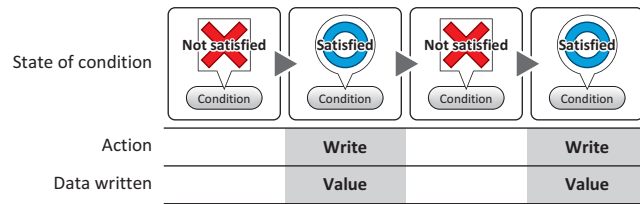

■ **Move**

Writes the value of source device address to the destination word device when the trigger condition is satisfied.

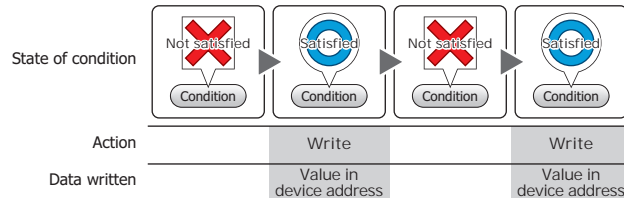

■ **Momentary**

Writes a fixed value of ON Data to a word device when the trigger condition is satisfied.
Writes a fixed value of OFF Data to a word device when the trigger condition is no longer satisfied.

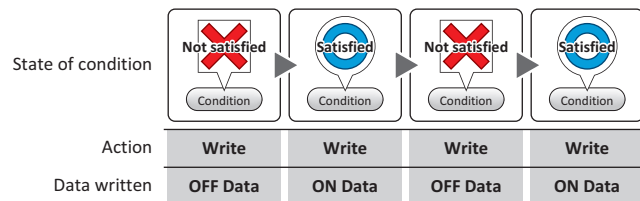

■ **Add, Sub, Multi, Div, Mod, OR, AND, XOR**

Performs arithmetic on the value of source device address and a fixed value, or a value of device address and writes the result to a word device when the trigger condition is satisfied.

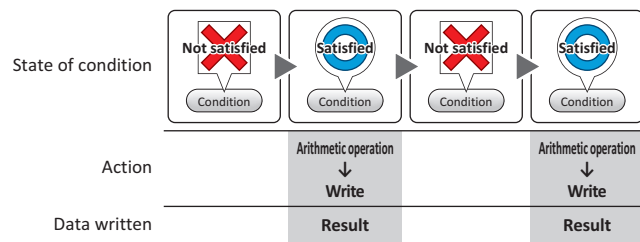

Example: Add (Addition)

When the trigger condition is satisfied, the value in the **Source 1** is added to the value in **Source 2** and the result is written to the word device.

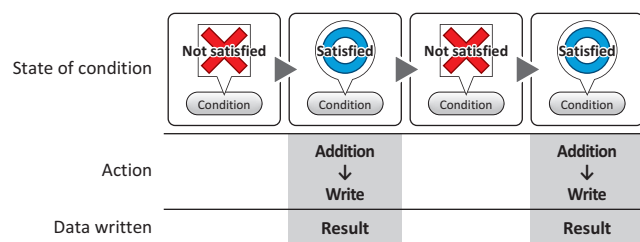

2.2 Word Write Command Configuration Procedure

This section describes the configuration procedure for the Word Write Command.

- 1 On the **Home** tab, in the **Parts** group, click **Commands**, and then click **Word Write Command**.

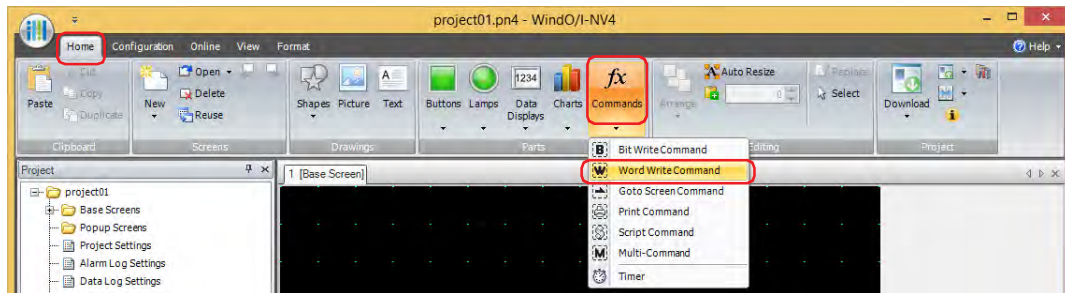

- 2 Click a point on the edit screen where you wish to place the Word Write Command.
- 3 Double-click the placed Word Write Command and a Properties dialog box will be displayed.
- 4 Change the settings on each tab as necessary.

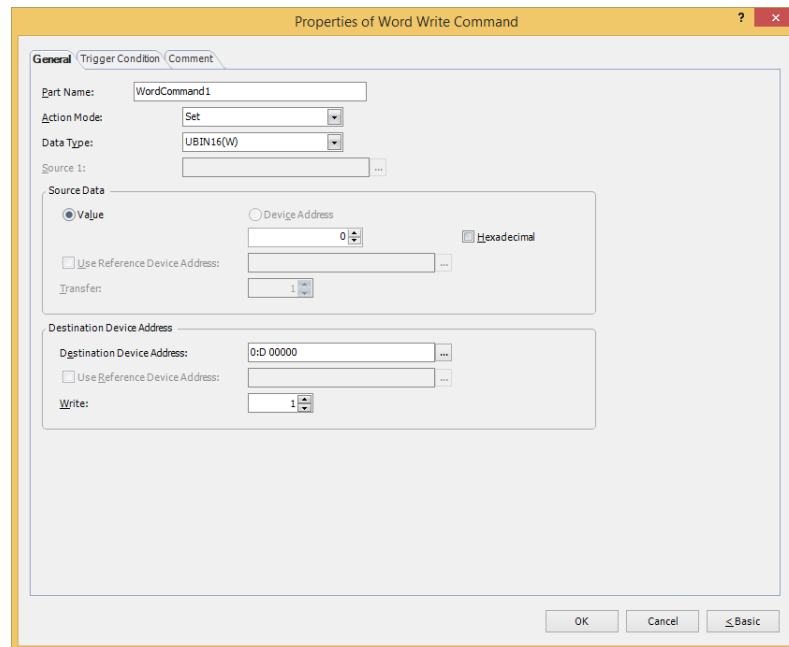

2.3 Properties of Word Write Command Dialog Box

This section describes items and buttons in the Properties dialog box.

● General Tab

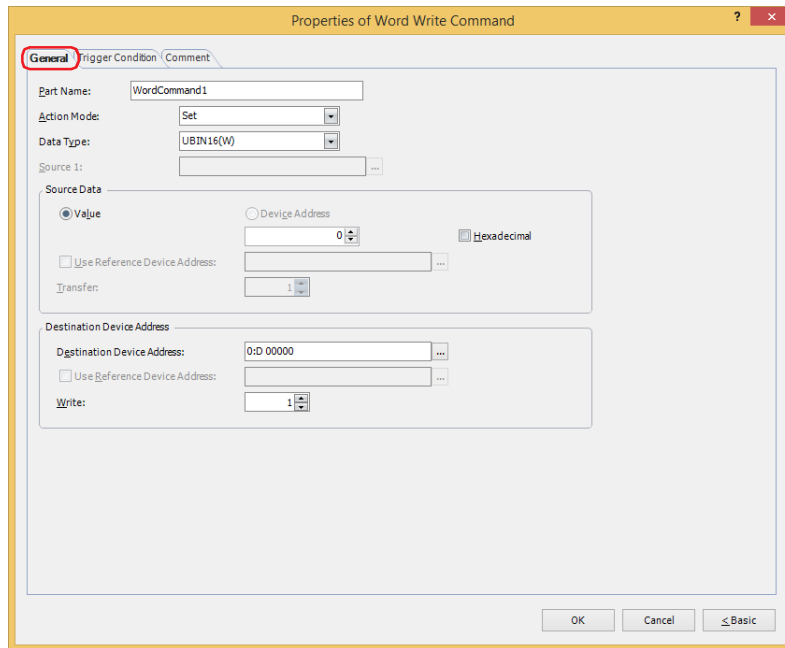

■ Part Name

Enter a name for the part. The maximum number is 20 characters.

■ Action Mode

Select the action to perform when the trigger condition is satisfied from the following:

Set: Writes a fixed value to the specified word device when the trigger condition is satisfied.

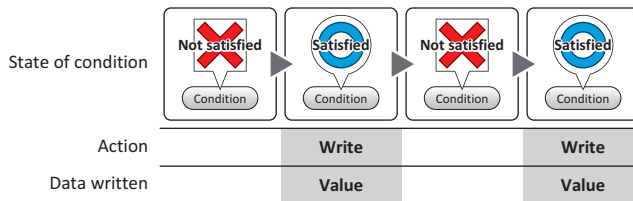

Move: Writes the value in the source device address to the destination word device when the trigger condition is satisfied.

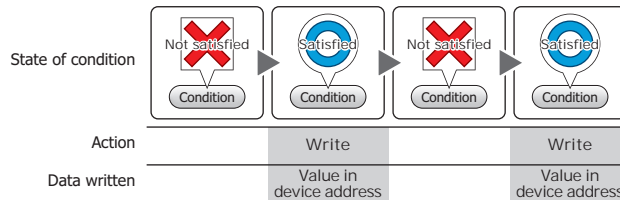

Momentary: Writes the fixed ON Data value to the specified word device when the trigger condition is satisfied. Writes the fixed OFF Data value to the specified word device when the trigger condition is no longer satisfied.

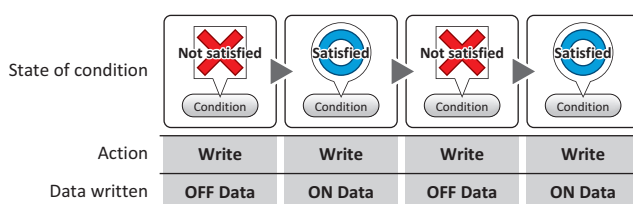

Add, Sub, Multi, Div, Mod, OR, AND, XOR:

Performs arithmetic on the value in a reference device address and a fixed value, or the value at a device address and writes the result to a word device when the trigger condition is satisfied.

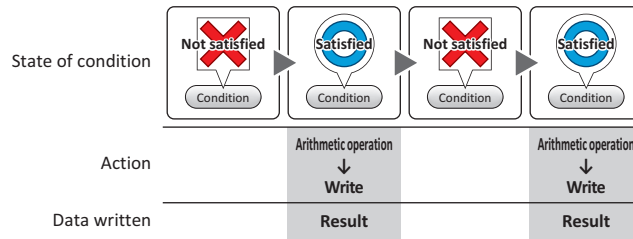

Example: Add (Addition)

When the trigger condition is satisfied, the value in the **Source 1** is added to the value in **Source 2** and the result is written to the word device.

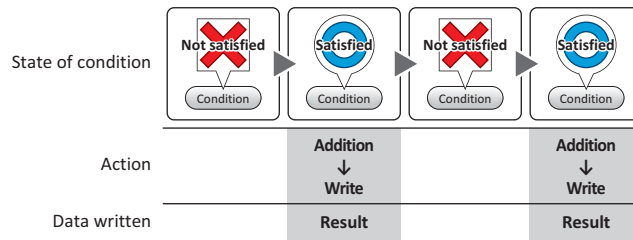

■ Data Type

Select the data type handled by the operation selected for **Action Mode**.

For details, refer to Chapter 2 "1.1 Available Data" on page 2-1.

UBIN16(W) and **UBIN32(D)** can only be set if **Action Mode** is set to **OR, AND, or XOR**.



UBIN16(W) and **UBIN32(D)** can only be set if **Action Mode** is set to **Move**. Because the number of device addresses to transfer is specified in Advanced mode, you do not need to set Data Type.



If **BCD4(B)**, **BCD8(EB)**, or **Float32(F)** is selected and the arithmetic data contains a value inexpressible in BCD, a 1 is written to System Area 2 Processing error bit (address number+2, bit 5) and an error message is displayed. For details, refer to Chapter 4 "Processing error" on page 4-32 and Chapter 36 "Processing error" on page 36-3.

■ Source 1

Specify the source word device.

Click to display the Tag Editor. For the device address configuration procedure, refer to Chapter 2 "5.1 Device Address Settings" on page 2-70.

This setting is enabled only if **Action Mode** is set to **Add, Sub, Multi, Div, Mod, OR, AND, or XOR**.

■ Source Data

Select the data handled by the operation selected for **Action Mode**.

Value: Use a constant value.

Only a **Value** can be handled if **Action Mode** is set to **Set** or **Momentary**.

If **Action Mode** is set to **Momentary**, the value in the **ON Data** is written when the trigger condition is satisfied, and the value in the **OFF Data** when the trigger condition is no longer satisfied.

Hexadecimal: Select this check box to enter the **ON Data** and **OFF Data** values as a hexadecimal.

Device Address: Use a value of device address.
Specify the device address.

Click to display the Tag Editor. For the device address configuration procedure, refer to Chapter 2 "5.1 Device Address Settings" on page 2-70.

Use Reference Device Address^{*1}: Select this check box and specify a device address to change the source word device according to the value of the specified device address.
This setting is enabled only if **Action Mode** is set to **Move**.
For details, refer to Chapter 2 "Indirect Read and Indirect Write Settings" on page 2-5.

Transfer^{*1}:

Specify the number of word devices (1 to 64) to transfer.
This setting is enabled only if **Action Mode** is set to **Move**.

Example: If **Transfer** is set to **2** and **Write** is set to **3**, the same data in 2 continuous word device addresses will be written to the destination device address 3 times.

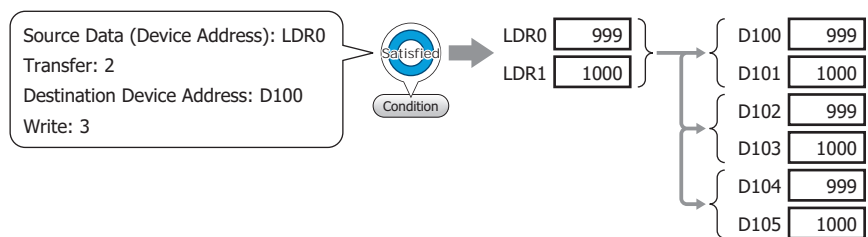

■ Destination Device Address

Destination Device Address: Specify the destination word device.

Click to display the Tag Editor. For the device address configuration procedure, refer to Chapter 2 "5.1 Device Address Settings" on page 2-70.

Use Reference Device Address^{*1}: Select this check box and specify a device address to change the destination word device according to the value of the specified device address.
This setting is enabled only if **Action Mode** is set to **Move**.
For details, refer to Chapter 2 "Indirect Read and Indirect Write Settings" on page 2-5.

Write^{*1}:

Specify the number of word devices (1 to 64) at the destination.
For **Move**, specify how many times to write.

This setting is enabled only if **Action Mode** is set to **Set**, **Move**, or **Momentary**.
Example: If **Data Type** is set to **UBIN16(W)** and **Write** is set to 5, the same data will be written to 5 continuous word addresses.

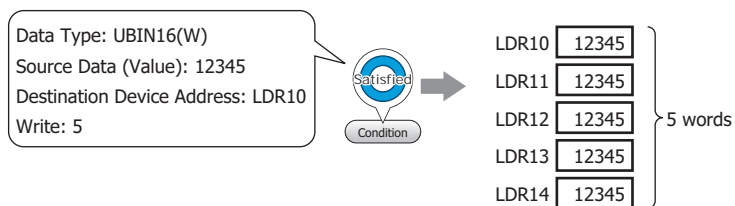

If **Data Type** is set to **UBIN32(D)** and **Write** is set to 5, the same data will be written to a total of 10 word addresses (2 words 5 times).

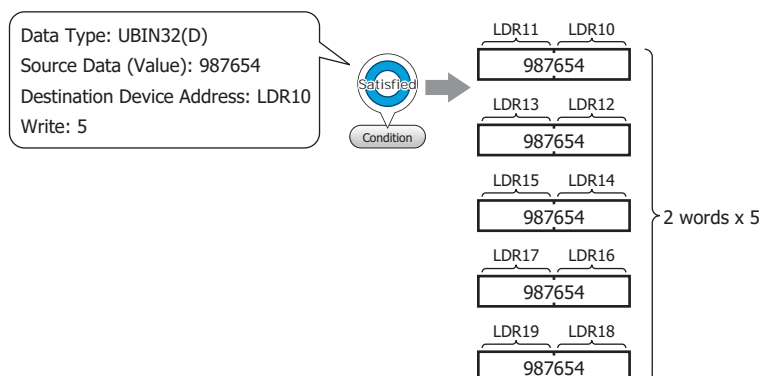

*1 Advanced mode only

● Trigger Condition Tab

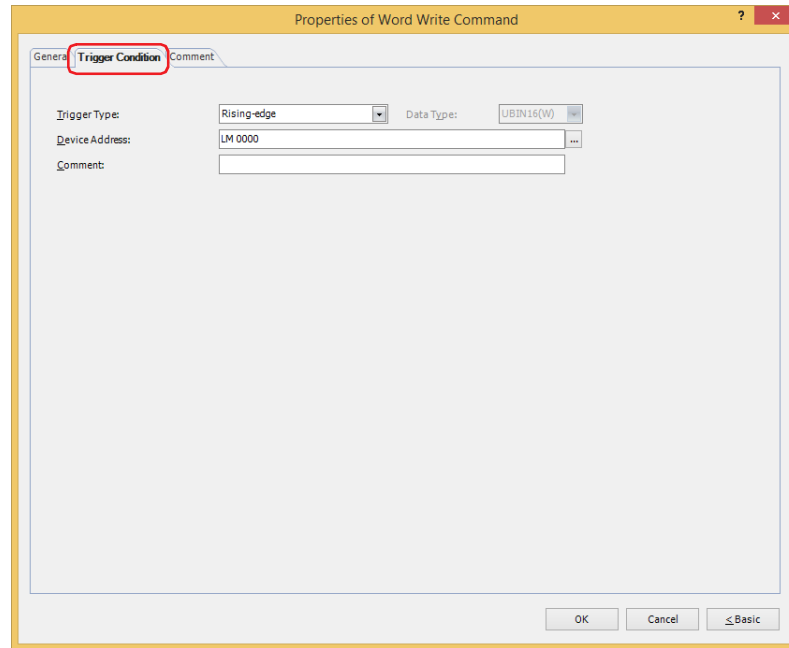

When the condition has been or is satisfied, the command is executed; when not satisfied, the command is not executed.

Example: When **Trigger Type** is **Rising-edge** and **Device Address** is **LM0**
The command is executed when LM0 changes from 0 to 1.

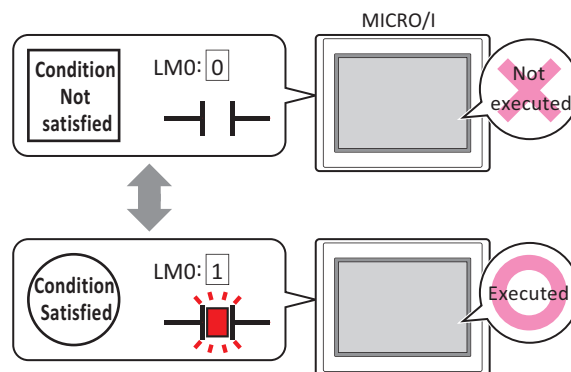

■ Trigger Type

Selects the condition to execute the command from the following.

Rising-edge:

Command is executed when a value of device address changes from 0 to 1.

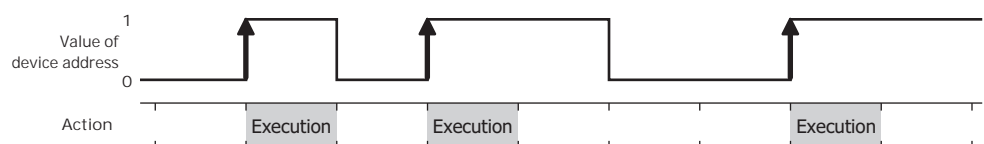

Falling-edge:

Command is executed when a value of device address changes from 1 to 0.

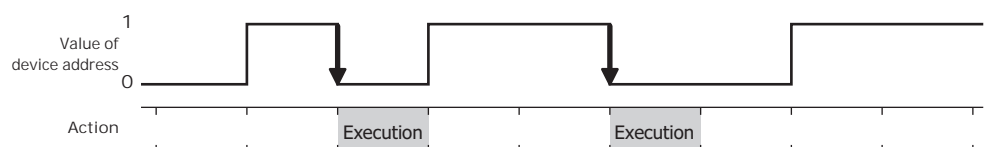

Satisfy the condition: Command is executed when condition changes from not satisfied to satisfied.

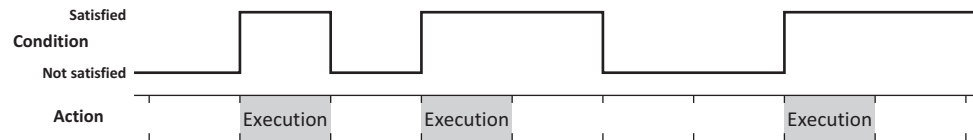

While satisfying the condition:

The command continues being executed while the condition is satisfied.

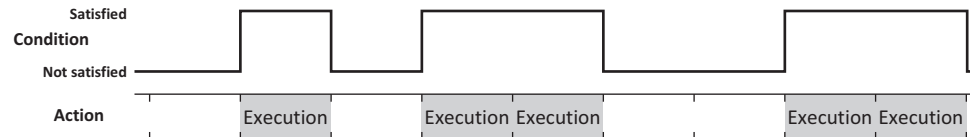

■ Data Type

Selects the data type to be handled by the condition formula.

Can only be set if **Satisfy the condition** or **While satisfying the condition** is selected as **Trigger Type**.

For details, refer to Chapter 2 "1.1 Available Data" on page 2-1.

■ Device Address

Specifies the bit device or the bit number of the word device to serve as condition.

Can only be set if **Rising-edge** or **Falling-edge** is selected as **Trigger Type**.

Click to display the Tag Editor. For the device address configuration procedure, refer to Chapter 2 "5.1 Device Address Settings" on page 2-70.

■ Condition

Specifies the conditional expression.

This option can only be configured when **Satisfy the condition** or **While satisfying the condition** is selected for **Trigger Type**.

Click to display the **Trigger Condition Settings** dialog box. For the conditional expression configuration procedure, refer to Chapter 2 "5.2 Setting Conditional Expressions" on page 2-73.

■ Comment

Used for entering comments about trigger conditions. The maximum number is 80 characters.

● Comment Tab

The **Comment** tab is used to specify the parts placed on the editing screen, and the popup text displayed when the mouse pointer is placed close to **No.**, **Name**, or **Type** in the object list.



When there are multiple parts of the same shape on the screen, this feature makes it possible to distinguish between the parts without displaying the Properties dialog box for each part, by just mousing over the part.

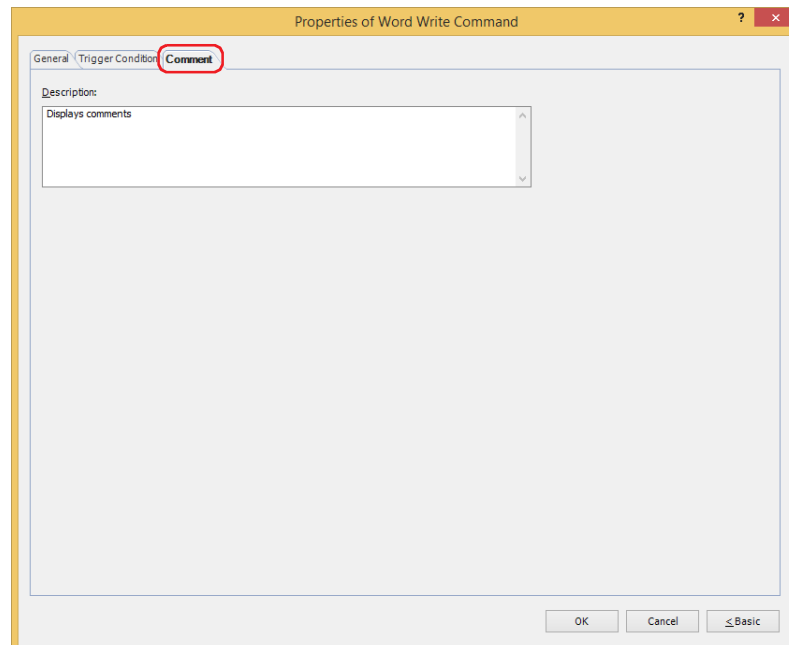

■ Description

Used for entering comments about parts. The maximum number is 80 characters.

Example: When mousing over the Word Write Command on the editing screen



3 Goto Screen Command

HG2J-7U HG5G-V HG4G-V HG4G HG3G-V HG3G HG2G-V HG2G-5F HG2G-5T HG1G HG1P

3.1 How the Goto Screen Command is Used

Switches to another screen or displays a window.

- Switches between Base Screens when the trigger condition is satisfied.

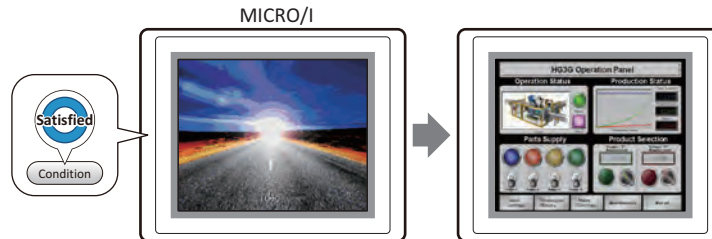

- Opens and closes other windows (such as the Popup Screen, Device Monitor, Password Screen, Adjust Brightness Screen, File Screen, and Open User Account Setting Screen) when the trigger condition is satisfied.

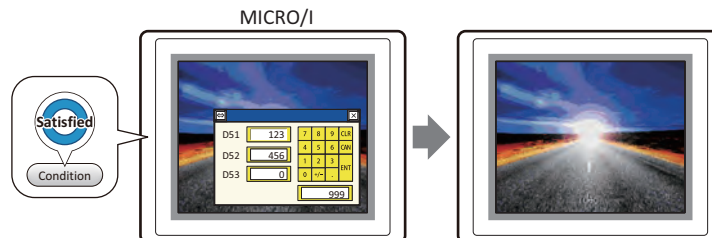
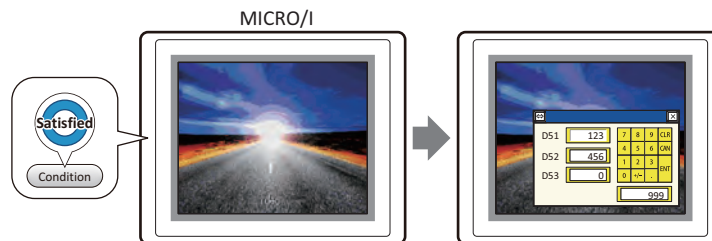

- Switches to the System Mode when the trigger condition is satisfied.

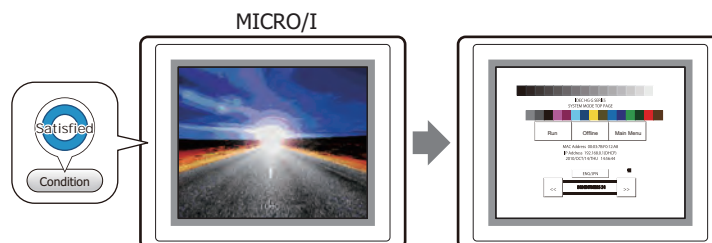

- Resets the current screen when the trigger condition is satisfied.

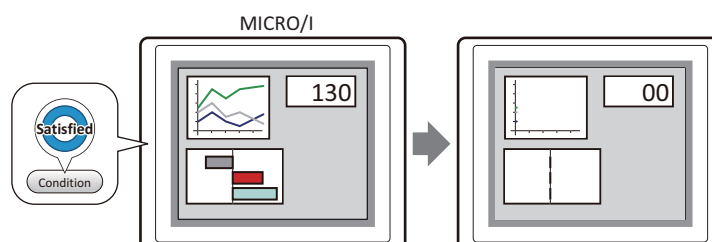

3.2 Goto Screen Command Configuration Procedure

This section describes the configuration procedure for the Goto Screen Command.

- 1 On the **Home** tab, in the **Parts** group, click **Commands**, and then click **Goto Screen Command**.

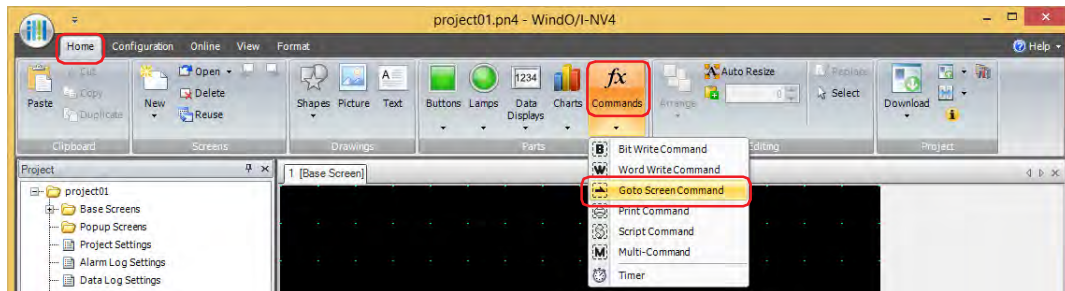

- 2 Click a point on the edit screen where you wish to place the Goto Screen Command.
- 3 Double-click the placed Goto Screen Command and a Properties dialog box will be displayed.
- 4 Change the settings on each tab as necessary.

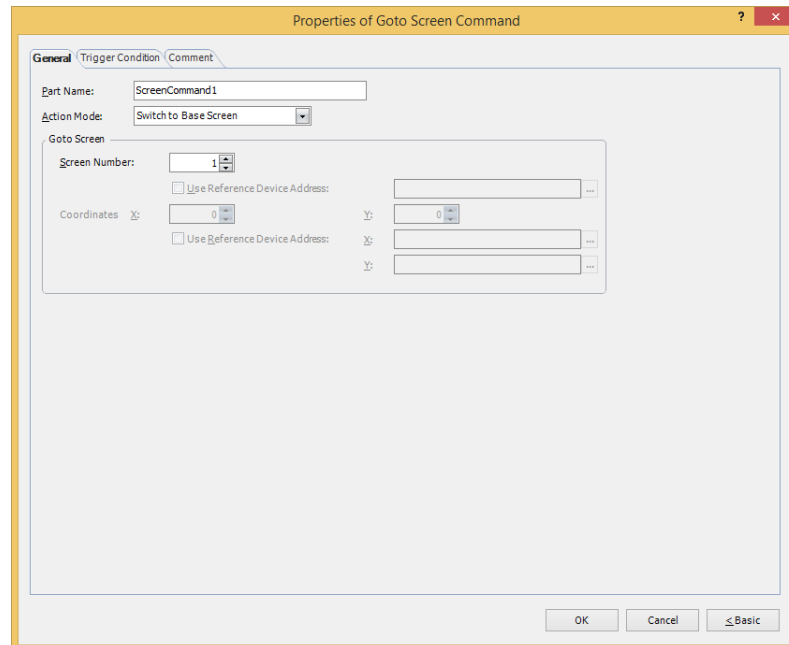

3.3 Properties of Goto Screen Command Dialog Box

This section describes items and buttons in the Properties dialog box.

● General Tab

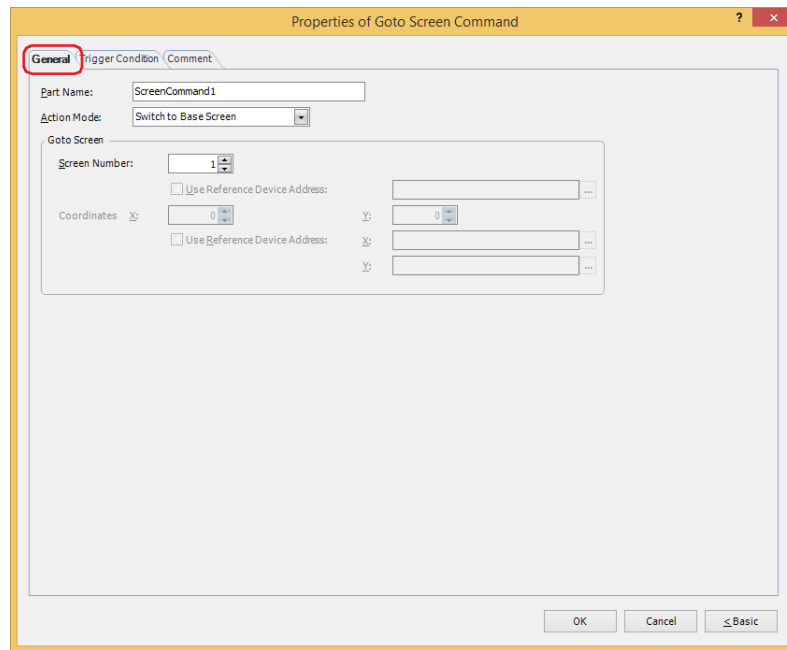

■ Part Name

Enter a name for the part. The maximum number is 20 characters.

■ Action Mode

Select the action to perform when the trigger condition is met from the following:

- | | |
|---------------------------------|--|
| Back to previous Screen: | Switches to the previous screen. Returns to up to 16 earlier screens. |
| Switch to Base Screen: | Switches between Base Screen. For details, refer to Chapter 5 "3 Base Screen" on page 5-14. |
| Open Popup Screen: | Opens a Popup Screen. For details, refer to Chapter 5 "4 Popup Screen" on page 5-20. |
| Close Popup Screen: | Closes a Popup Screen. For details, refer to Chapter 5 "4 Popup Screen" on page 5-20. |
| Open Device Monitor Screen: | Opens the Device Monitor Screen. For details, refer to Chapter 25 "2.2 Device Monitor" on page 25-21. |
| Close Device Monitor Screen: | Closes the Device Monitor Screen. For details, refer to Chapter 25 "2.2 Device Monitor" on page 25-21. |
| Open Password Screen: | Opens the Password Screen. For details, refer to Chapter 23 "4.1 Entering the Password on the MICRO/I" on page 23-47. |
| Close Password Screen: | Closes the Password Screen. For details, refer to Chapter 23 "4.1 Entering the Password on the MICRO/I" on page 23-47. |
| Open Adjust Brightness Screen: | Opens the Adjust Brightness Screen. For details, refer to Chapter 34 "1.3 Adjusting Screen Brightness" on page 34-2. |
| Close Adjust Brightness Screen: | Closes the Adjust Brightness Screen. For details, refer to Chapter 34 "1.3 Adjusting Screen Brightness" on page 34-2. |

Open File Screen for movie files ^{*1} :	Opens the File Screen. For details, refer to Chapter 10 "4.4 File Screen" on page 10-92.
Close File Screen for movie files ^{*1} :	Closes the File Screen. For details, refer to Chapter 10 "4.4 File Screen" on page 10-92.
Switch to System Mode:	Switches to the Top Page in the System Mode. For details, refer to Chapter 34 "2 System Mode Overview" on page 34-3.
Reset current screen:	Resets the current Base Screen. When the current screen is reset, the displayed Popup Screen is closed and the following internal devices restart as if the Base Screen is switched. <ul style="list-style-type: none"> • HMI Temporary Relay LBM0 to 127 • HMI Special Internal Relay LSM1, 2, 3, 11 • HMI Temporary Register LBR0 to 127
Open User Account Setting Screen:	Opens the User Account Setting Screen. For details, refer to Chapter 23 "5 Editing User Accounts on the MICRO/I" on page 23-50. When User Account Setting Screen is selected, the Configure Processing Area of User Account Setting Screen dialog box will be displayed. For details, refer to Chapter 8 "Configure Processing Area of User Account Setting Screen Dialog Box" on page 8-44. Specify the word device to use as the processing area of the User Account Setting Screen and click OK . When you return to the properties dialog box, Edit will be displayed. Edit: Click this button to display the Configure Processing Area of User Account Setting Screen dialog box.

■ Goto Screen

Screen Number:	If Action Mode is set to Switch to Base Screen , specify the Base Screen number to switch to (from 1 to 3000). If Action Mode is set to Open Popup Screen or Close Popup Screen , specify the number of the Popup Screen to open or close (from 1 to 3015). This setting is enabled only if Action Mode is set to Switch to Base Screen, Open Popup Screen, or Close Popup Screen .
Use Reference Device Address ^{*2} :	Select this check box and specify a device address to specify the screen number using the value of the specified device address. Click <input type="text" value="..."/> to display the Tag Editor. For the device address configuration procedure, refer to Chapter 2 "5.1 Device Address Settings" on page 2-70. This setting is enabled only if Action Mode is set to Open Popup Screen or Close Popup Screen .
Coordinates X, Y:	Specify the coordinates on the Base Screen for displaying a window. X and Y specify the upper left corner of the window using the upper left corner of the screen as the origin. This setting is enabled only if Action Mode is set to Open Popup Screen, Open Device Monitor Screen, Open Password Screen, Open Adjust Brightness Screen, or Open File Screen for Movie Files ^{*1} . Use Reference Device Address ^{*2} : Select this check box and specify a device address to specify the coordinates using the value of the specified device address. Click <input type="text" value="..."/> to display the Tag Editor. For the device address configuration procedure, refer to Chapter 2 "5.1 Device Address Settings" on page 2-70. This setting is enabled only if Action Mode is set to Open Popup Screen .

*1 This is applicable for models with a video interface only.

*2 Advanced mode only

● **Trigger Condition Tab**

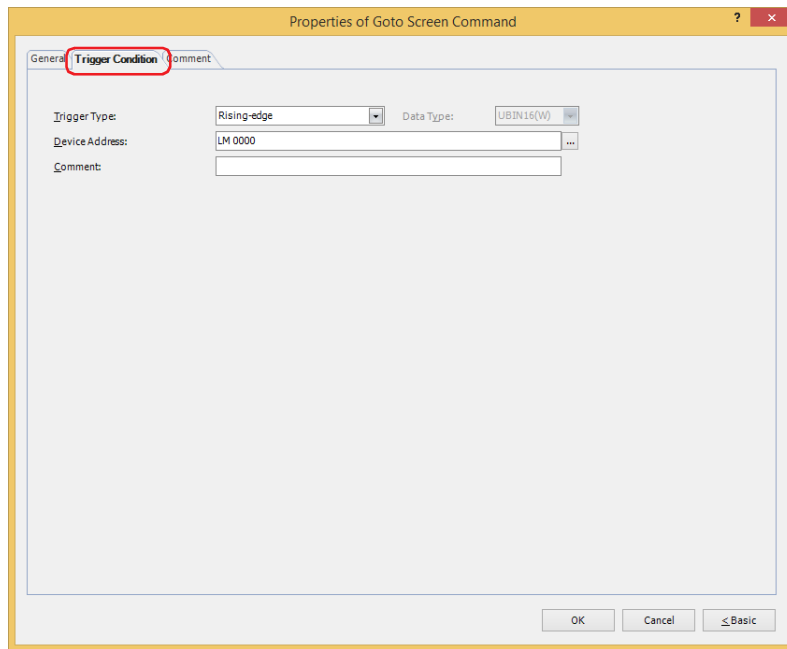

When the condition has been or is satisfied, the command is executed; when not satisfied, the command is not executed.

Example: When **Trigger Type** is **Rising-edge** and **Device Address** is **LM0**
The command is executed when LM0 changes from 0 to 1.

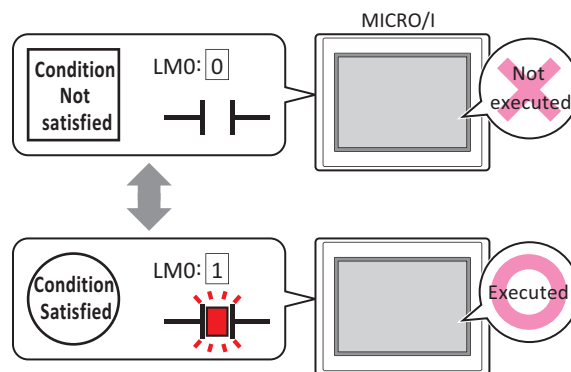

■ **Trigger Type**

Selects the condition to execute the command from the following.

Rising-edge:

Command is executed when a value of device address changes from 0 to 1.

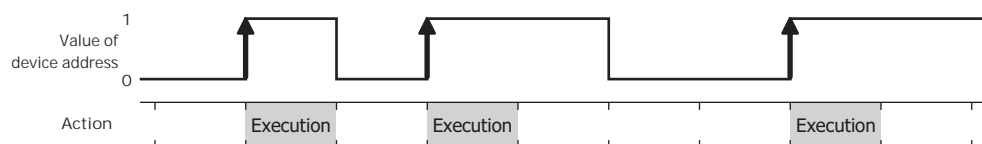

Falling-edge:

Command is executed when a value of device address changes from 1 to 0.

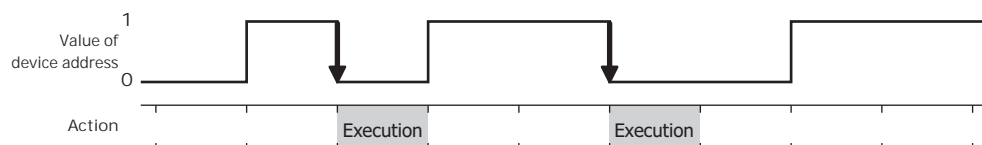

Satisfy the condition: Command is executed when condition changes from not satisfied to satisfied.

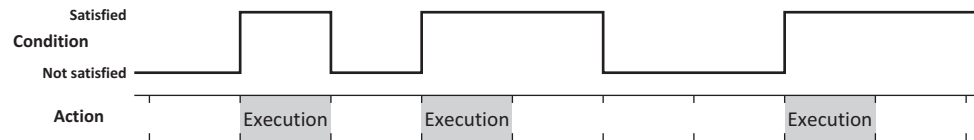

While satisfying the condition:

The command continues being executed while the condition is satisfied.

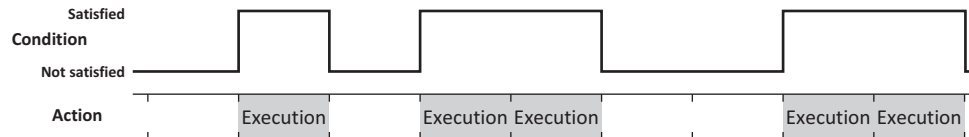

■ Data Type

Selects the data type to be handled by the condition formula.

Can only be set if **Satisfy the condition** or **While satisfying the condition** is selected as **Trigger Type**.

For details, refer to Chapter 2 "1.1 Available Data" on page 2-1.

■ Device Address

Specifies the bit device or the bit number of the word device to serve as condition.

Can only be set if **Rising-edge** or **Falling-edge** is selected as **Trigger Type**.

Click to display the Tag Editor. For the device address configuration procedure, refer to Chapter 2 "5.1 Device Address Settings" on page 2-70.

■ Condition

Specifies the conditional expression.

This option can only be configured when **Satisfy the condition** or **While satisfying the condition** is selected for **Trigger Type**.

Click to display the **Trigger Condition Settings** dialog box. For the conditional expression configuration procedure, refer to Chapter 2 "5.2 Setting Conditional Expressions" on page 2-73.

■ Comment

Used for entering comments about trigger conditions. The maximum number is 80 characters.

● Comment Tab

The **Comment** tab is used to specify the parts placed on the editing screen, and the popup text displayed when the mouse pointer is placed close to **No.**, **Name**, or **Type** in the object list.



When there are multiple parts of the same shape on the screen, this feature makes it possible to distinguish between the parts without displaying the Properties dialog box for each part, by just mousing over the part.

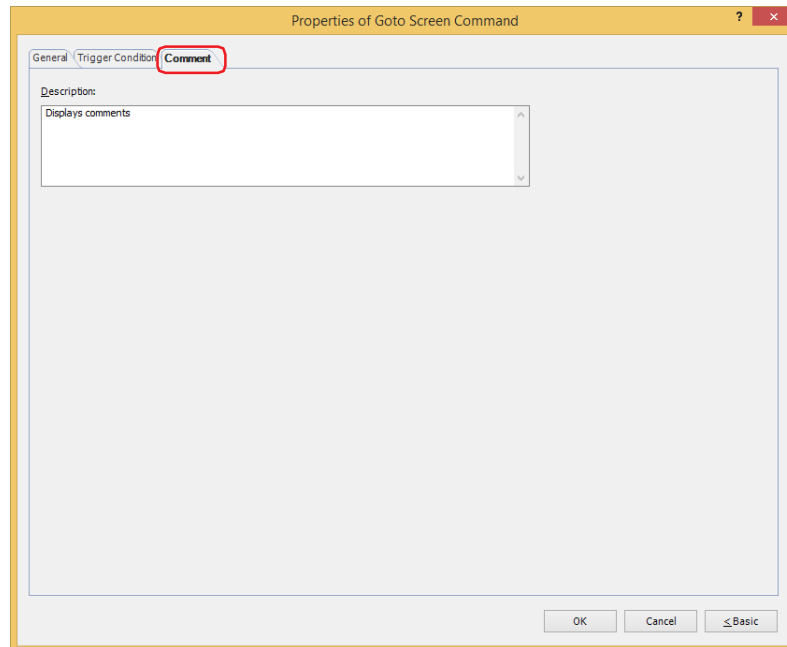

■ Description

Used for entering comments about parts. The maximum number is 80 characters.

Example: When mousing over the Goto Screen Command on the editing screen



4 Print Command

HG2J-7U HG5G-V HG4G-V HG4G HG3G-V HG3G HG2G-V HG2G-5F HG2G-5T HG1G HG1P

4.1 How the Print Command is Used

Outputs a screenshot to a printer*¹ or an external memory device*².

- Outputs a screenshot of the current screen to the printer*¹ when the trigger condition is satisfied.

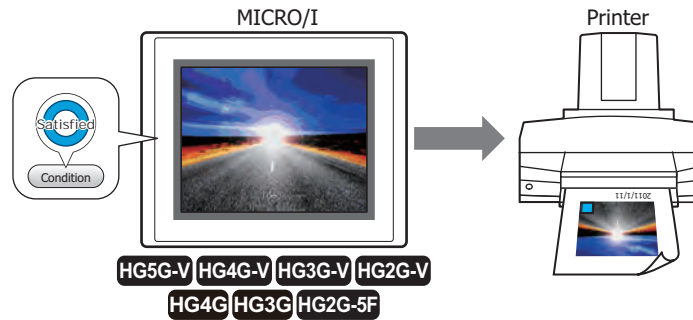

Refer to Chapter 32 "1.2 Connecting a Printer to MICRO/I" on page 32-1 for compatible printers and instructions on how to connect one to the MICRO/I.

- Outputs a screenshot of the current screen to the external memory device*² when the trigger condition is satisfied.

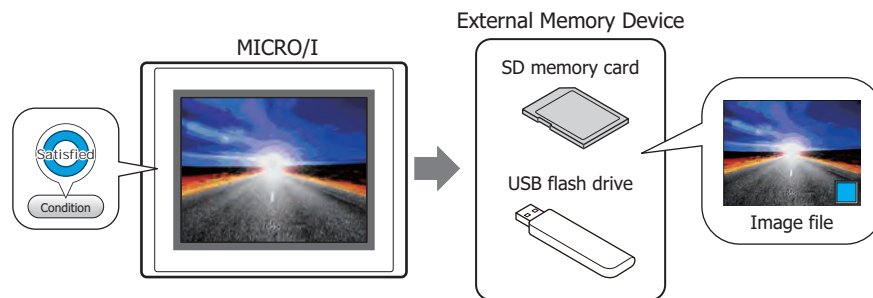

*1 HG5G/4G/3G/2G-V, HG4G/3G, HG2G-5F only

*2 USB flash drive inserted in USB1 for HG2J-7U, SD memory card for HG5G/4G/3G/2G-V, HG4G/3G and HG2G-5F, USB flash drive for HG2G-5T and HG1G/1P

4.2 Print Command Configuration Procedure

This section describes the configuration procedure for the Print Command.

- 1 On the **Home** tab, in the **Parts** group, click **Commands**, and then click **Print Command**.

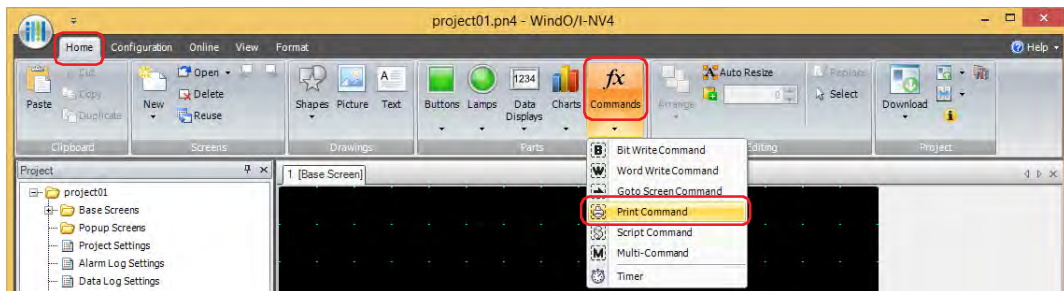

- 2 Click a point on the edit screen where you wish to place the Print Command.
- 3 Double-click the placed Print Command and a Properties dialog box will be displayed.
- 4 Change the settings on each tab as necessary.

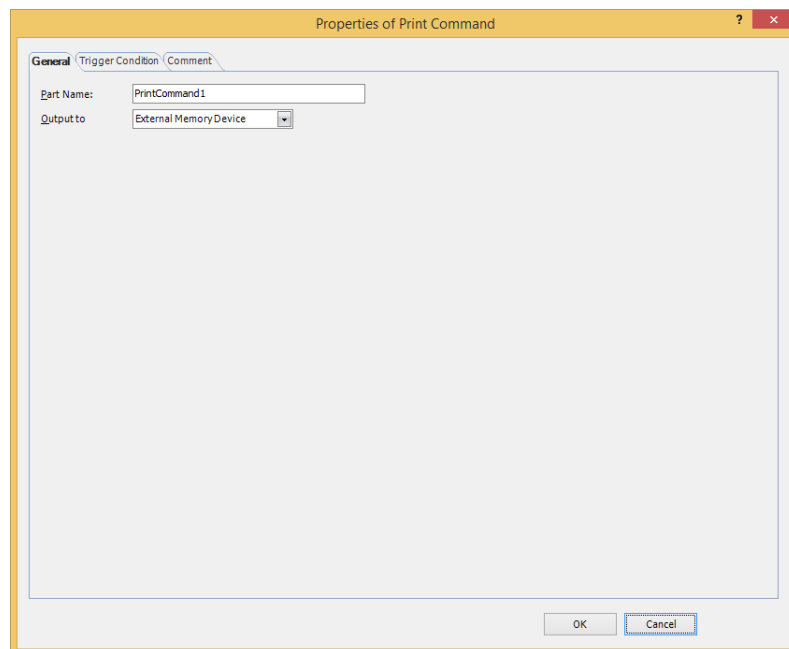

4.3 Properties of Print Command Dialog Box

This section describes items and buttons in the Properties dialog box.

● General Tab

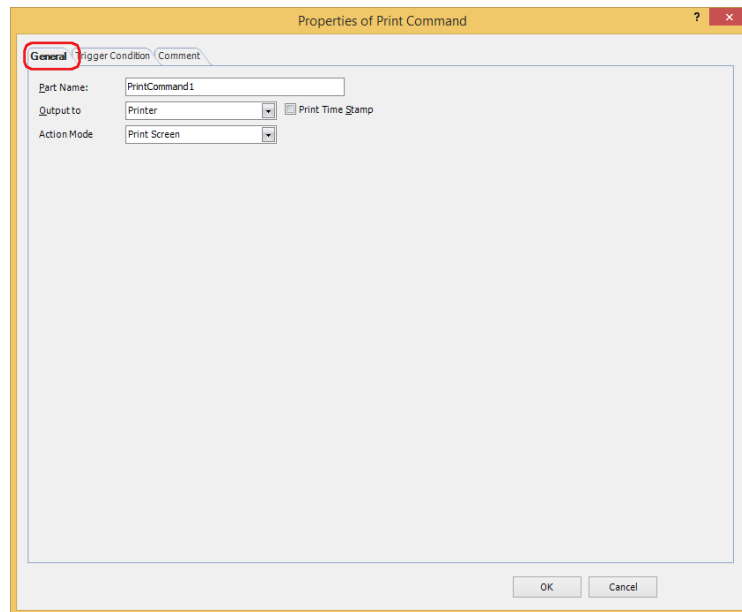

■ Part Name

Enter a name for the part. The maximum number is 20 characters.

■ Output to

Select where to direct the screenshot to.

Printer^{*1}:

Outputs the screenshot to the printer connected to the MICRO/I.

Print Time Stamp: Adds the date and time of printing to the screenshot before sending it to the printer.

The date and time format depends on the language selected in **Language**. **Language** is available on the **Project Details** tab of the **Project Settings** dialog box.

The display formats are shown below:

- Japanese: YYYY/MM/DD hh:mm
- English: MM/DD/YYYY hh:mm

YYYY: year, MM: month, DD: day, hh: hour, mm: minute

External Memory Device^{*2}: Outputs the screenshot as a file to the external memory device inserted in the MICRO/I. Files are output as follows:

File format	File name	File size
JPEG	CAP***.JPG (***: date and time when file was output) Example: A file created at 18:50:25 on June 30, 2011 will be named "CAP110630_185025.JPG".	Depends on image being displayed.



- For details about printers, refer to Chapter 32 "Printer" on page 32-1.
- For details about external memory devices, refer to Chapter 31 "External Memory Devices" on page 31-1.

■ Action Mode

Select the action to perform when the trigger condition is satisfied from the following. This option is displayed only when **Printer** is selected in **Output to**.

Print Screen: Outputs a screenshot of the current screen to the printer or the external memory device.

Cancel Printing^{*1}: Cancels printout to the printer.

*1 HG5G/4G/3G/2G-V, HG4G/3G, HG2G-5F only

*2 USB flash drive inserted in USB1 for HG2J-7U, SD memory card for HG5G/4G/3G/2G-V, HG4G/3G and HG2G-5F, USB flash drive for HG2G-5T and HG1G/1P



- These operations cannot be performed simultaneously.
 - Outputting to the external memory device using the Print Command
 - Outputting to the printer using the Print Command^{*1}
 - Printing alarm logs
- While the screenshot is being output to the external memory device, the Print Button or Print Command cannot output to one. Also, during these situations, the value of HMI Special Relay LSM24 or LSM25 changes to 1. For details, refer to Chapter 33 "HMI Special Relay (LSM)" on page 33-2.
- It may take some time to output screenshots when copying files using the USB Autorun function or a Key Button.
- MICRO/I cannot stop printing in the middle of a page, even when the print job is canceled. Print jobs after the current print job are canceled after the current page finishes printing.



The maximum number of screenshots that can be captured (1 to 999) can be set in HMI Special Data Register LSD65. (Default: 99)



The methods to erase screenshot files saved on the external memory device are as follows.

- To erase files during operation using parts, on the **External Memory Device** tab on the **Project Settings** dialog box, select the **Remove Files** check box and the **All Screenshot data** check box, and then configure the trigger device address. Assign that trigger device address to a part.
- To erase files with WindO/I-NV4, click **Clear** on the **Online** tab, and then click **Stored Data in External Memory Device** to open the **Clear Data** dialog box. Select the **Screenshot Data** check box and click **OK**.
- To erase files on the HG5G/4G/3G/2G-V, HG4G/3G and the HG2G-5F, go to the System Mode - File Manager. In the File Manager, select the files to be deleted by pressing **DEL**.

*1 HG5G/4G/3G/2G-V, HG4G/3G, HG2G-5F only

● Trigger Condition Tab

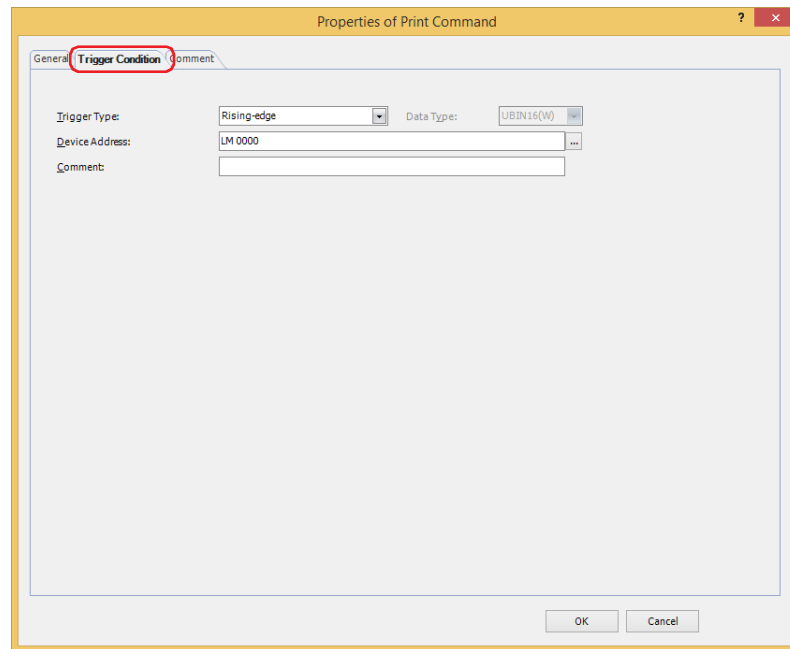

When the condition has been or is satisfied, the command is executed; when not satisfied, the command is not executed.

Example: When **Trigger Type** is **Rising-edge** and **Device Address** is **LM0**
The command is executed when LM0 changes from 0 to 1.

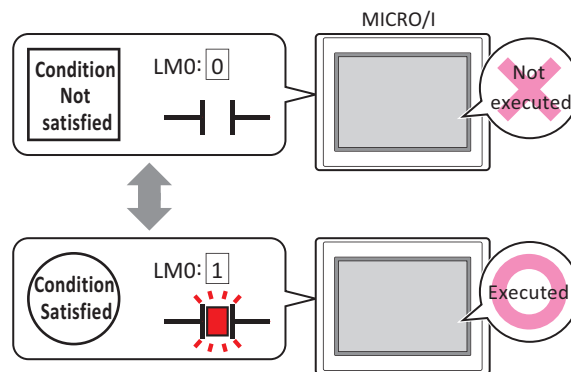

■ Trigger Type

Selects the condition to execute the command from the following.

Rising-edge:

Command is executed when a value of device address changes from 0 to 1.

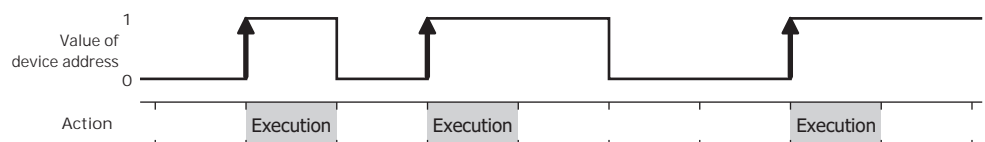

Falling-edge:

Command is executed when a value of device address changes from 1 to 0.

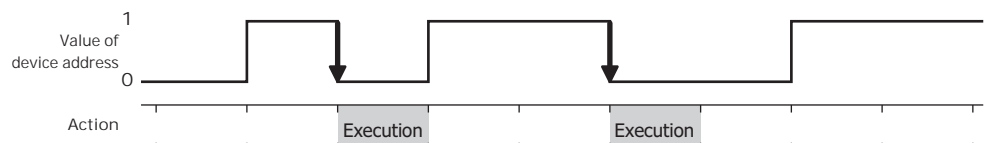

Satisfy the condition: Command is executed when condition changes from not satisfied to satisfied.

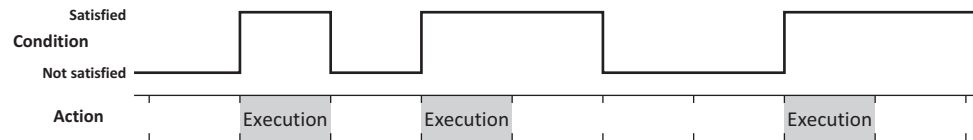

While satisfying the condition:

The command continues being executed while the condition is satisfied.

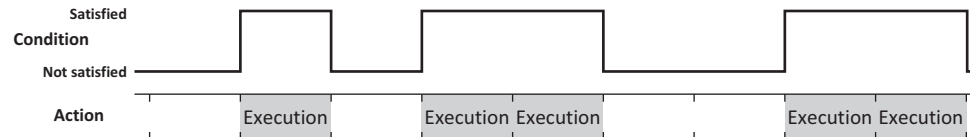

■ Data Type

Selects the data type to be handled by the condition formula.

Can only be set if **Satisfy the condition** or **While satisfying the condition** is selected as **Trigger Type**.

For details, refer to Chapter 2 "1.1 Available Data" on page 2-1.

■ Device Address

Specifies the bit device or the bit number of the word device to serve as condition.

Can only be set if **Rising-edge** or **Falling-edge** is selected as **Trigger Type**.

Click to display the Tag Editor. For the device address configuration procedure, refer to Chapter 2 "5.1 Device Address Settings" on page 2-70.

■ Condition

Specifies the conditional expression.

This option can only be configured when **Satisfy the condition** or **While satisfying the condition** is selected for **Trigger Type**.

Click to display the **Trigger Condition Settings** dialog box. For the conditional expression configuration procedure, refer to Chapter 2 "5.2 Setting Conditional Expressions" on page 2-73.

■ Comment

Used for entering comments about trigger conditions. The maximum number is 80 characters.

● Comment Tab

The **Comment** tab is used to specify the parts placed on the editing screen, and the popup text displayed when the mouse pointer is placed close to **No.**, **Name**, or **Type** in the object list.



When there are multiple parts of the same shape on the screen, this feature makes it possible to distinguish between the parts without displaying the Properties dialog box for each part, by just mousing over the part.

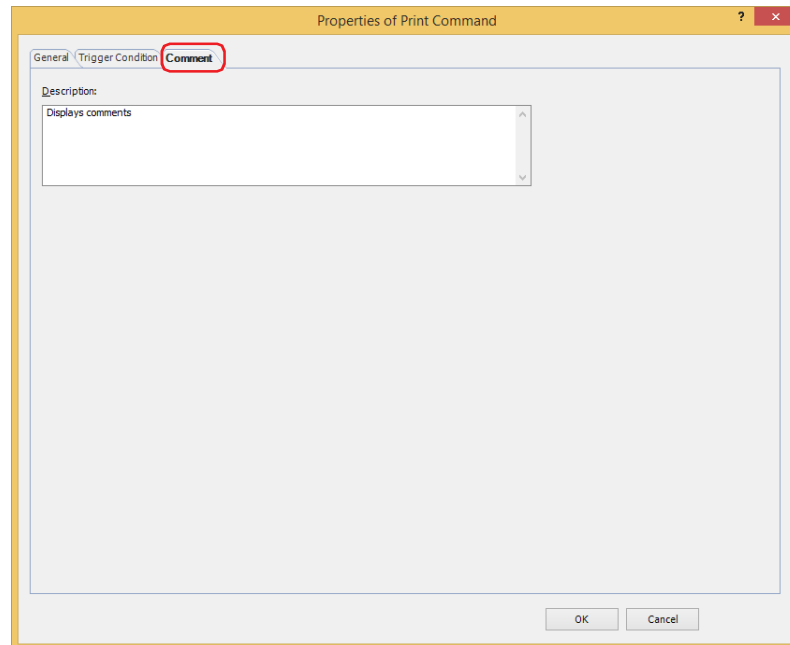

■ Description

Used for entering comments about parts. The maximum number is 80 characters.

Example: When mousing over the Print Command on the editing screen

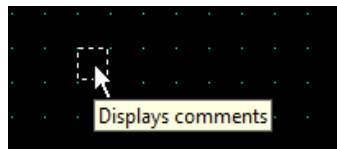

5 Script Command

HG2J-7U HG5G-V HG4G-V HG4G HG3G-V HG3G HG2G-V HG2G-5F HG2G-5T HG1G HG1P

5.1 How the Script Command is Used

Executes a script when certain conditions are satisfied.

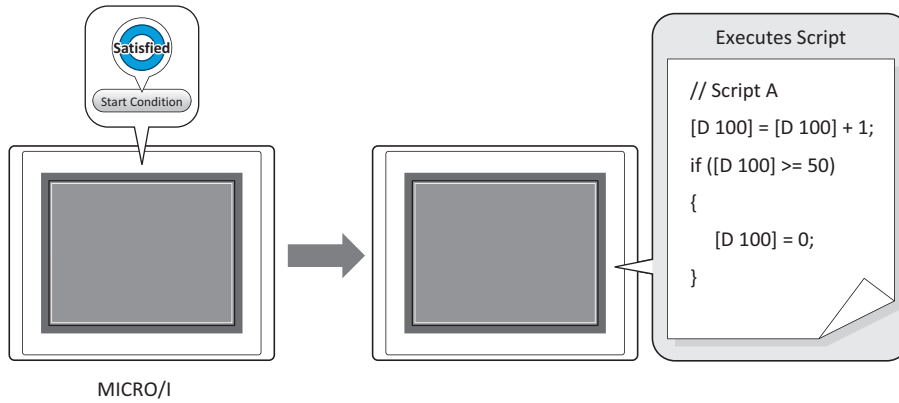

Complex processes such as conditional branching, logical operation, arithmetic operation, function, etc., can be programmed in a text format using Scripts. For details, refer to Chapter 20 "Script" on page 20-1.

5.2 Script Command Configuration Procedure

This section describes the configuration procedure for Script Commands.

- 1 On the **Home** tab, in the **Parts** group, click **Commands**, and then click **Script Command**.

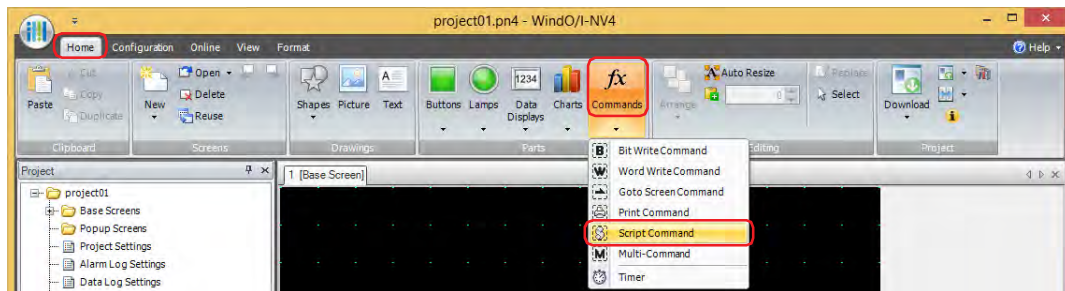

- 2 Click a point on the edit screen where you wish to place the Script Command.
- 3 Double-click the placed Script Command and a Properties dialog box will be displayed.
- 4 Change the settings on each tab as necessary.

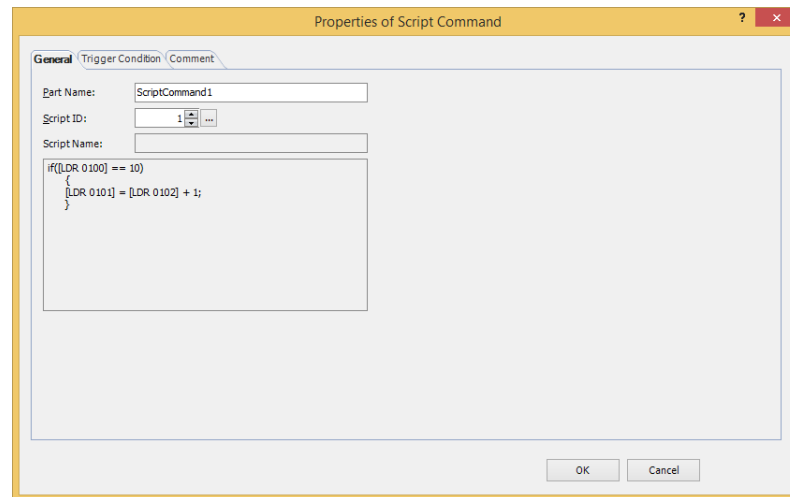

5.3 Properties of Script Command Dialog Box

This section describes items and buttons in the Properties dialog box.

● General Tab

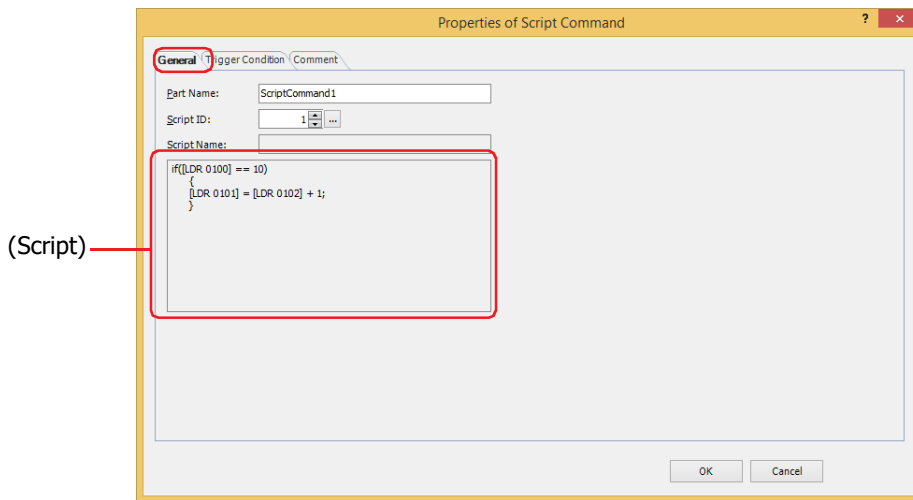

■ Part Name

Enter a name for the part. The maximum number is 20 characters.

■ Script ID

Specify the script ID (1-32000) of the script to operate.

The Script Manager will open when is clicked. Select a script from the script list. For details, refer to Chapter 20 "2.2 Script Manager" on page 20-7.

■ Script Name

Displays the name of the script selected in the Script Manager.

■ (Script)

Displays the contents of the script selected in the Script Manager.

Once this area is double clicked, the Script Editor will open and editing can be done.

For details, refer to Chapter 20 "2.3 Script Editor" on page 20-12.

● Trigger Condition Tab

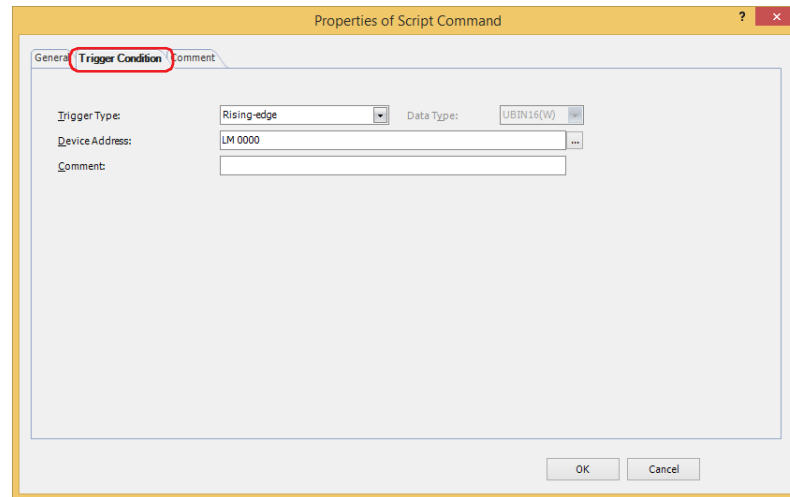

When the condition has been or is satisfied, the command is executed; when not satisfied, the command is not executed.

Example: When **Trigger Type** is **Rising-edge** and **Device Address** is **LM0**
The command is executed when LM0 changes from 0 to 1.

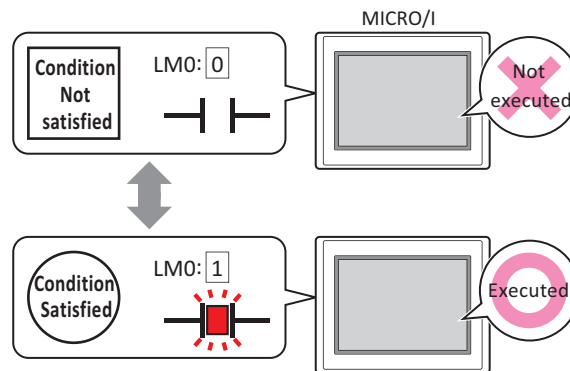

■ Trigger Type

Selects the condition to execute the command from the following.

Rising-edge: Command is executed when a value of device address changes from 0 to 1.

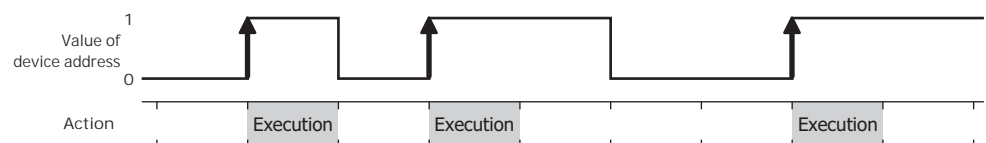

Falling-edge: Command is executed when a value of device address changes from 1 to 0.



Satisfy the condition: Command is executed when condition changes from not satisfied to satisfied.

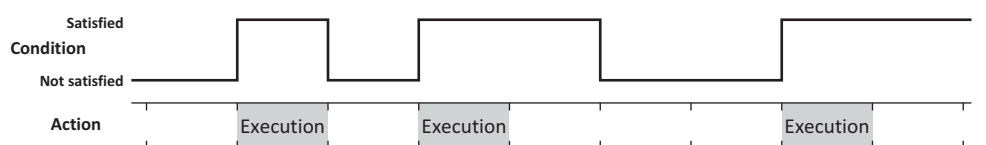

While satisfying the condition:

The command continues being executed while the condition is satisfied.

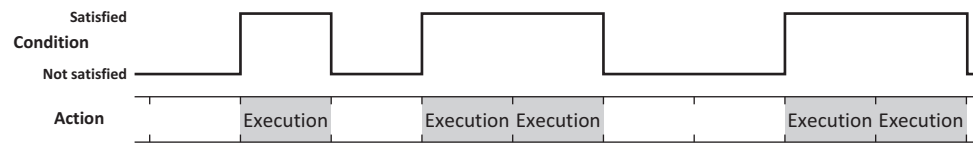

Fixed Period:

Command executes within a fixed time interval.

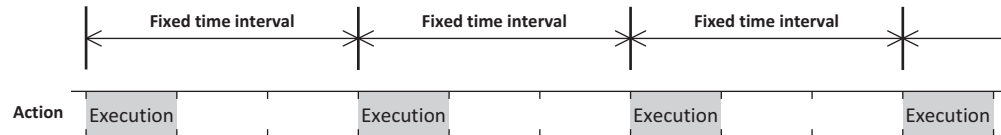

■ Data Type

Selects the data type to be handled by the condition formula.

Can only be set if **Satisfy the condition** or **While satisfying the condition** is selected as **Trigger Type**.

For details, refer to Chapter 2 "1.1 Available Data" on page 2-1.

■ Device Address

Specifies the bit device or the bit number of the word device to serve as condition.

Can only be set if **Rising-edge** or **Falling-edge** is selected as **Trigger Type**.

Click to display the Tag Editor. For the device address configuration procedure, refer to Chapter 2 "5.1 Device Address Settings" on page 2-70.

■ Condition

Specifies the conditional expression.

This option can only be configured when **Satisfy the condition** or **While satisfying the condition** is selected for **Trigger Type**.

Click to display the **Trigger Condition Settings** dialog box. For the conditional expression configuration procedure, refer to Chapter 2 "5.2 Setting Conditional Expressions" on page 2-73.

■ Period

Sets the period for command execution from 1 to 3600 (seconds).

Can only be set if **Fixed Period** is selected as **Trigger Type**.

■ Comment

Used for entering comments about trigger conditions. The maximum number is 80 characters.

● Comment Tab

The **Comment** tab is used to specify the parts placed on the editing screen, and the popup text displayed when the mouse pointer is placed close to **No.**, **Name**, or **Type** in the object list.



When there are multiple parts of the same shape on the screen, this feature makes it possible to distinguish between the parts without displaying the Properties dialog box for each part, by just mousing over the part.

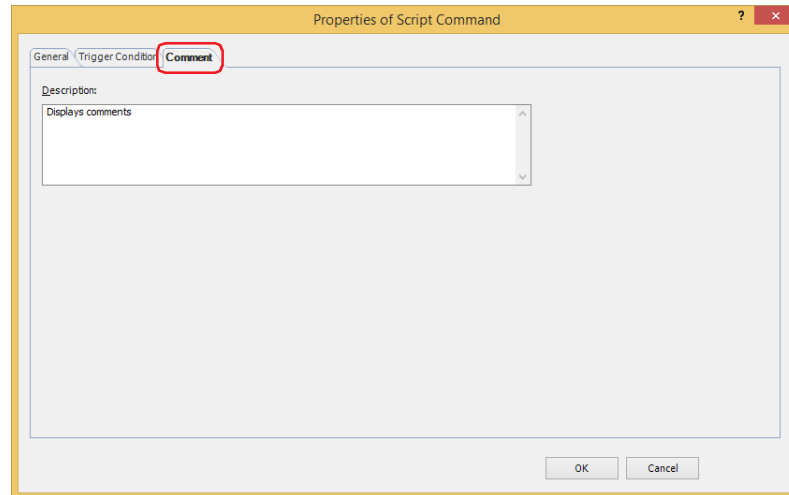

■ Description

Used for entering comments about parts. The maximum number is 80 characters.

Example: When mousing over the Script Command on the editing screen

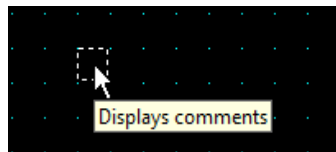

6 Multi-Command

HG2J-7U HG5G-V HG4G-V HG4G HG3G-V HG3G HG2G-V HG2G-5F HG2G-5T HG1G HG1P

6.1 How the Multi-Command is Used

Executes multiple commands at once.

These commands can be assigned to a Multi-Command.

Command	Description
Bit Write	Writes a 0 or 1 to the specified bit device.
Word Write	Writes a value to a word device. You can specify the destination address number indirectly, and perform arithmetic on the value to be written.
Goto Screen	Switches screens and opens other windows.
Print	Outputs a screenshot to the printer or the external memory device ^{*1} .
Key	Performs downloads, uploads, and file copying. Also used to manipulate other parts.
Script	Executes a script.

- Writes a 1 to a bit device, and the value in a word device to another device when the trigger condition is satisfied.

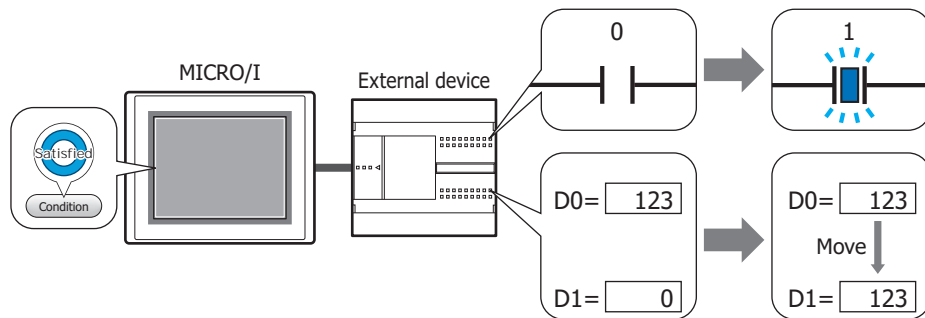

- Outputs a screenshot of the current screen to an external memory device ^{*1}, and then switches the Base Screen when the trigger condition is satisfied.

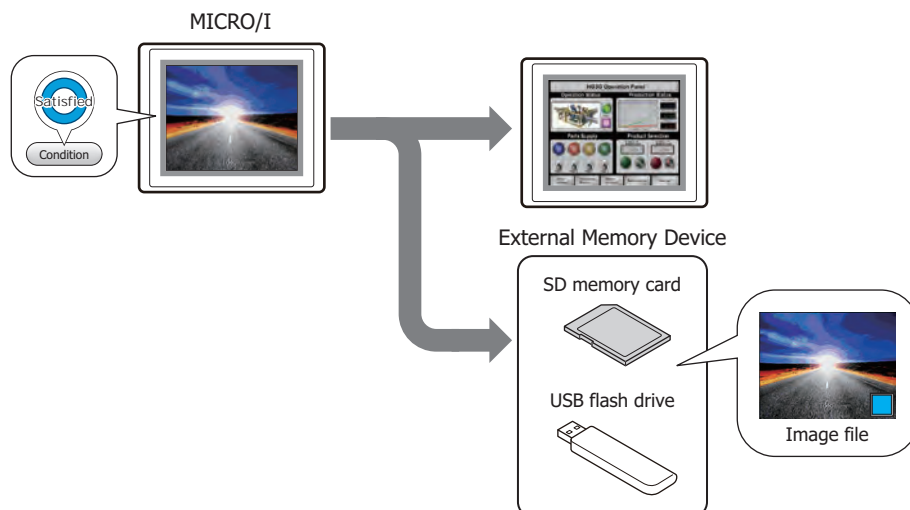

*1 USB flash drive inserted in USB1 for HG2J-7U, SD memory card for HG5G/4G/3G/2G-V, HG4G/3G and HG2G-5F, USB flash drive for HG2G-5T and HG1G/1P

6.2 Multi-Command Configuration Procedure

This section describes the configuration procedure for Multi-Commands.

- 1 On the **Home** tab, in the **Parts** group, click **Commands**, and then click **Multi-Command**.

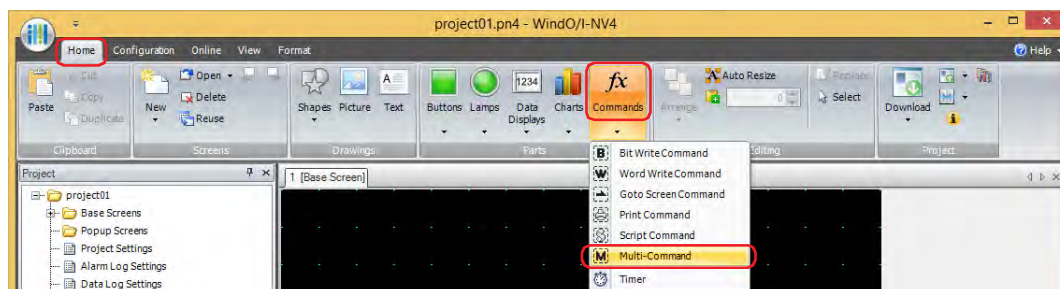

- 2 Click a point on the edit screen where you wish to place the Multi-Command.
- 3 Double-click the placed Multi-Command and a Properties dialog box will be displayed.
- 4 Change the settings on each tab as necessary.

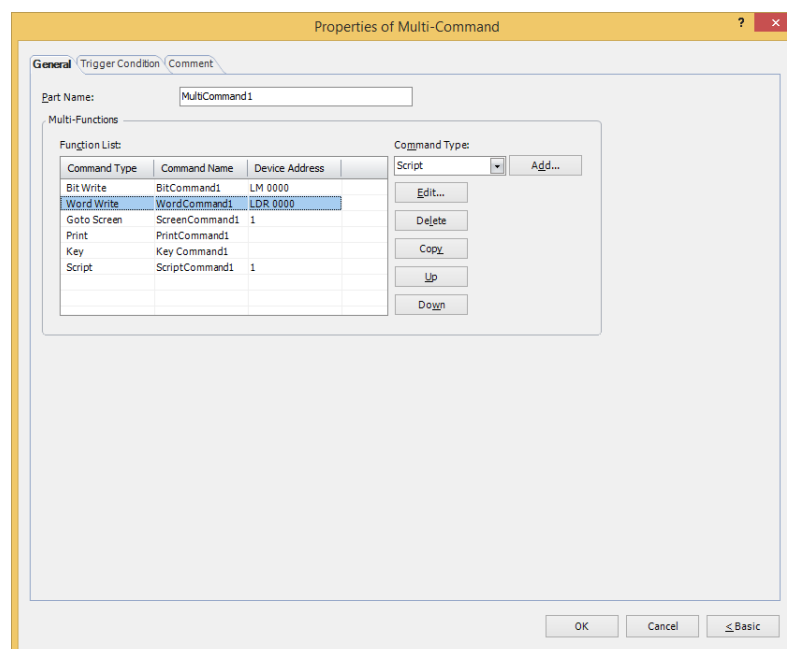

6.3 Properties of Multi-Command Dialog Box

This section describes items and buttons in the Properties dialog box.

● General Tab

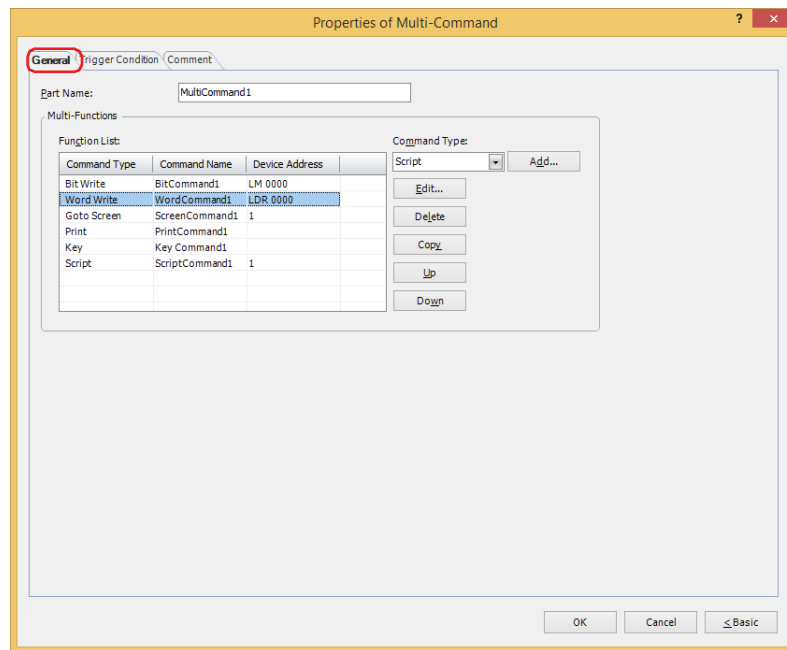

■ Part Name

Enter a name for the part. The maximum number is 20 characters.

■ Multi-Functions

Add and edit commands to be executed when the trigger condition is satisfied.

- Function List: Lists the commands to be executed.
- Command Type: Shows the command type.
- Command Name: Shows the command name.
- Device Address: Shows the setting when one of the following Command Type is selected.
Shows the destination device address for the **Bit Write** and **Word Write** commands.
Shows the screen number when **Goto Screen** is set to **Switch to Base Screen**, **Open Popup Screen**, or **Close Popup Screen**.
Shows the script ID for the **Script** command.



- Executes only the Goto Screen command at the end of the **Function List** when multiple **Switch to Base Screen** type commands are set for **Action Mode**.
- Goto Screen commands are not executed from top to bottom as they appear in the **Function List**. Rather, they are executed at the end of the scan when the trigger condition is satisfied.
- Key commands are executed in the scan that follows a scan that satisfies the trigger condition.
- If multiple Key commands are set, only the first and second Key commands in the **Function List** are executed. The third and following Key commands are not executed. Also, only the first Key command that specifies a Data Transfer function in the **Function List** is executed if multiple Key commands are set.

Command Type: Select the command to add.

Bit Write: Writes a 0 or 1 to the bit device or the bit number of the word device. For details, refer to "Properties of Bit Write for Multi-Functions Dialog Box" on page 12-42.

Word Write: Writes a value to a word device. Can be used to indirectly specify the destination address number or to perform operations on the written value. For details, refer to "Properties of Word Write for Multi-Functions Dialog Box" on page 12-43.

- Goto Screen:** Switches to another screen or displays a window. For details, refer to "Properties of Goto Screen for Multi-Functions Dialog Box" on page 12-45.
- Print:** Outputs a screenshot to a printer or an external memory device. For details, refer to "Properties of Print for Multi-Functions Dialog Box" on page 12-47.
- Key:** Performs a variety of functions including uploading and downloading, copying files, and operating other parts. For details, refer to "Properties of Key for Multi-Functions Dialog Box" on page 12-49.
- Script:** Executes a script. For details, refer to "Properties of Script for Multi-Functions Dialog Box" on page 12-56.
- Add:** Adds a command to the list. A maximum of 32 commands may be added.
Click this button to display the Properties dialog box for the command selected from **Command Type**.
- Edit:** Changes a command in the list.
Click this button to display the Properties dialog box for the command selected in **Function List**.
- Delete:** Deletes a command from the list.
Select the command in the list and click this button.
- Copy:** Copies a command in the list.
Select a command in the list and click this button. A copy of the selected command is added to the end of the list.
- Up:** Shifts the selected command upward in the list.
- Down:** Shifts the selected command downward in the list.

Properties of Bit Write for Multi-Functions Dialog Box

Sets the Bit Write command for the Multi-Command.

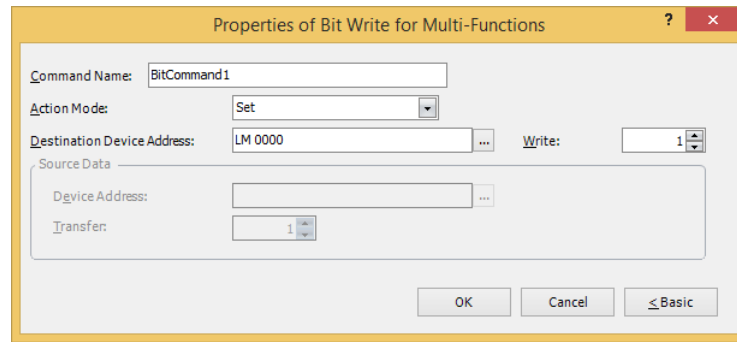

■ Command Name

Enter a name for the command. The maximum number is 20 characters.

■ Action Mode

Select the action to perform when the trigger condition is satisfied from the following:

- Set: Writes a 1 to the specified bit device when the trigger condition is satisfied.
- Reset: Writes a 0 to the specified bit device when the trigger condition is satisfied.
- Set & Reset: Writes a 1 to the specified bit device when the trigger condition is satisfied. When the trigger condition is no longer satisfied, a 0 is written to the specified bit device.
- Toggle: Toggles the value of the specified bit device when the trigger condition is satisfied. If the value of the bit device is 0 it changes to 1, and vice versa.
- Move: This function writes the value in the source bit device to the value in the destination bit device when the trigger condition is satisfied.



For details about the **Action Mode**, refer to "Action Mode" on page 12-4. However, **Set & Reset** for the Multi-Command has the same function as **Momentary** for the Bit Write Command.

■ Destination Device Address

Specify the destination bit device.

Click to display the Tag Editor. For the device address configuration procedure, refer to Chapter 2 "5.1 Device Address Settings" on page 2-70.

■ Write^{*1}

Specify the number of bit devices (1 to 64) at the destination.

This setting is enabled only if **Action Mode** is set to **Set** or **Reset**. For details, refer to "Write^{*1}" on page 12-5.

■ Source Data

Specifies the device address where the data to be written is stored.

This setting is enabled only if **Action Mode** is set to **Move**. For details, refer to "Source Data" on page 12-5.

Device Address: Specify the source bit device.

Click to display the Tag Editor. For the device address configuration procedure, refer to Chapter 2 "5.1 Device Address Settings" on page 2-70.

Transfer: Specify the number of bit devices (1 to 64) to move.

*1 Advanced mode only

Properties of Word Write for Multi-Functions Dialog Box

Sets the Word Write command for the Multi-Command.

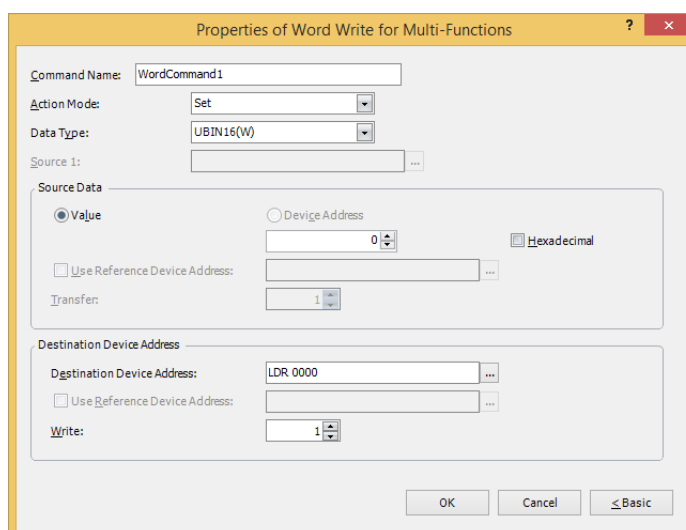

■ Command Name

Enter a name for the command. The maximum number is 20 characters.

■ Action Mode

Select the action to perform when the trigger condition is satisfied from the following:

- Set: Writes a fixed value to the specified word device when the trigger condition is satisfied.
- Move: Writes the value in the source device address to the destination word device when the trigger condition is satisfied.
- Set ON & OFF Data: Writes a fixed value of **ON Data** to the specified word device when the trigger condition is satisfied.
Writes a fixed value of **OFF Data** to the specified word device when the trigger condition is no longer satisfied.
- Add, Sub, Multi, Div, Mod, OR, AND, XOR: Performs arithmetic on the value of source device address and a fixed value or a value of device address and writes the result to a word device when the trigger condition is satisfied.



For details about the **Action Mode**, refer to "Action Mode" on page 12-12. However, **Set ON & OFF Data** for the Multi-Command has the same function as **Momentary** for the Word Write Command.

■ Data Type

Select the data type handled by the operation selected for **Action Mode**.

For details, refer to Chapter 2 "1.1 Available Data" on page 2-1.

UBIN16(W) and **UBIN32(D)** can only be set if **Action Mode** is set to **OR**, **AND**, or **XOR**.



UBIN16(W) and **UBIN32(D)** can only be set if **Action Mode** is set to **Move**. Because the number of device addresses to transfer is specified in Advanced mode, you do not need to set Data Type.



If **BCD4(B)**, **BCD8(EB)**, or **Float32(F)** is selected and the arithmetic data contains a value inexpressible in BCD, a 1 is written to System Area 2 Processing error bit (address number+2, bit 5) and an error message is displayed. For details, refer to Chapter 4 "Processing error" on page 4-32 and Chapter 36 "Processing error" on page 36-3.

■ Source 1

Specify the source word device.

Click to display the Tag Editor. For the device address configuration procedure, refer to Chapter 2 "5.1 Device Address Settings" on page 2-70.

This setting is enabled only if **Action Mode** is set to **Add**, **Sub**, **Multi**, **Div**, **Mod**, **OR**, **AND**, or **XOR**.

■ Source Data

Select the data handled by the operation selected for **Action Mode**.

Value: Use a constant value.

Only a **Value** can be handled if **Action Mode** is set to **Set** or **Set ON & OFF Data**.

If **Action Mode** is set to **Set ON & OFF Data**, the value in the **ON Data** is written when the trigger condition is satisfied, and the value in the **OFF Data** when the trigger condition is no longer satisfied.

Hexadecimal: Select this check box to enter the **ON Data** and **OFF Data** values as a hexadecimal.

Device Address: Use a value of device address.

Specify the device address.

Click to display the Tag Editor. For the device address configuration procedure, refer to Chapter 2 "5.1 Device Address Settings" on page 2-70.

Use Reference Device Address^{*1}: Select this check box and specify a device address to change the source word device according to the value of the specified device address.

This setting is enabled only if **Action Mode** is set to **Move**.

For details, refer to Chapter 2 "Indirect Read and Indirect Write Settings" on page 2-5.

Transfer^{*1}: Specify the number of word devices (1 to 64) to transfer.

This setting is enabled only if **Action Mode** is set to **Move**.

For details, refer to "Transfer^{*1}" on page 12-14.

■ Destination Device Address

Destination Device Address: Specify the destination word device.

Click to display the Tag Editor. For the device address configuration procedure, refer to Chapter 2 "5.1 Device Address Settings" on page 2-70.

Use Reference Device Address^{*1}: Select this check box and specify a device address to change the destination word device according to the value of the specified device address.

This setting is enabled only if **Action Mode** is set to **Move**.

For details, refer to Chapter 2 "Indirect Read and Indirect Write Settings" on page 2-5.

Write^{*1}: Specify the number of word devices (1 to 64) at the destination.

For **Move**, specify how many times to write.

This setting is enabled only if **Action Mode** is set to **Set**, **Move**, or **Set ON & OFF Data**.

For details, refer to "Write^{*1}" on page 12-14.

*1 Advanced mode only

Properties of Goto Screen for Multi-Functions Dialog Box

Sets the Goto Screen command for the Multi-Command.

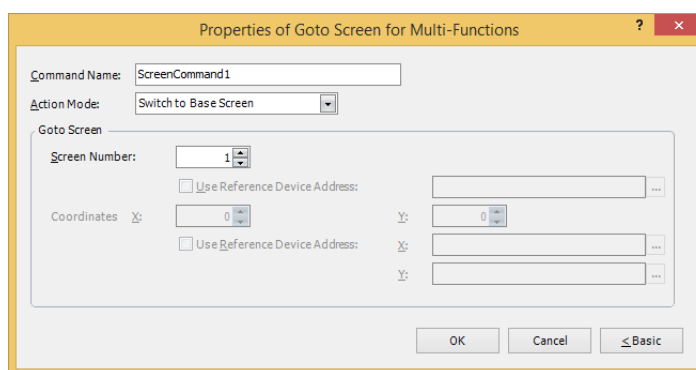

■ Command Name

Enter a name for the command. The maximum number is 20 characters.

■ Action Mode

Select the action to perform when the trigger condition is met from the following:

Back to previous Screen:	Switches to the previous screen. Returns to up to 16 earlier screens.
Switch to Base Screen:	Switches between Base Screen.
Open Popup Screen:	Opens a Popup Screen.
Close Popup Screen:	Closes a Popup Screen.
Open Device Monitor Screen:	Opens the Device Monitor Screen.
Close Device Monitor Screen:	Closes the Device Monitor Screen.
Open Password Screen:	Opens the Password Screen.
Close Password Screen:	Closes the Password Screen.
Open Adjust Brightness Screen:	Opens the Adjust Brightness Screen.
Close Adjust Brightness Screen:	Closes the Adjust Brightness Screen.
Open File Screen for movie files ^{*1} :	Opens the File Screen.
Close File Screen for movie files ^{*1} :	Closes the File Screen.
Switch to System Mode:	Switches to the Top Page in the System Mode.
Reset current screen:	Resets the current Base Screen. When the current screen is reset, the displayed Popup Screen is closed and the following internal devices restart as if the Base Screen is switched. <ul style="list-style-type: none"> • HMI Temporary Relay LBM0 to 127 • HMI Special Internal Relay LSM1, 2, 3, 11 • HMI Temporary Register LBR0 to 127
Open User Account Setting Screen:	Opens the User Account Setting Screen. For details, refer to Chapter 23 "5 Editing User Accounts on the MICRO/I" on page 23-50. When User Account Setting Screen is selected, the Configure Processing Area of User Account Setting Screen dialog box will be displayed. For details, refer to Chapter 8 "Configure Processing Area of User Account Setting Screen Dialog Box" on page 8-44. Specify the word device to use as the processing area of the User Account Setting Screen and click OK . When you return to the properties dialog box, Edit will be displayed. Edit: Click this button to display the Configure Processing Area of User Account Setting Screen dialog box.

*1 This is applicable for models with a video interface only.

■ Goto Screen

Screen Number: If **Action Mode** is set to **Switch to Base Screen**, specify the Base Screen number to switch to (from 1 to 3000). If **Action Mode** is set to **Open Popup Screen** or **Close Popup Screen**, specify the number of the Popup Screen to open or close (from 1 to 3015).

This setting is enabled only if **Action Mode** is set to **Switch to Base Screen**, **Open Popup Screen**, or **Close Popup Screen**.

Use Reference Device Address^{*2}: Select this check box and specify a device address to specify the screen number using the value of the specified device address.

Click  to display the Tag Editor. For the device address configuration procedure, refer to Chapter 2 "5.1 Device Address Settings" on page 2-70.

This setting is enabled only if **Action Mode** is set to **Open Popup Screen** or **Close Popup Screen**.

Coordinates X, Y: Specify the coordinates on the Base Screen for displaying a window.

X and Y specify the upper left corner of the window using the upper left corner of the screen as the origin.

This setting is enabled only if **Action Mode** is set to **Open Popup Screen**, **Open Device Monitor Screen**, **Open Password Screen**, **Open Adjust Brightness Screen**, or **Open File Screen for Movie Files**^{*1}.

Use Reference Device Address^{*2}: Select this check box and specify a device address to specify the coordinates using the value of the specified device address.

Click  to display the Tag Editor. For the device address configuration procedure, refer to Chapter 2 "5.1 Device Address Settings" on page 2-70.

This setting is enabled only if **Action Mode** is set to **Open Popup Screen**.

*1 This is applicable for models with a video interface only.

*2 Advanced mode only

Properties of Print for Multi-Functions Dialog Box

Sets the Print command for the Multi-Command.

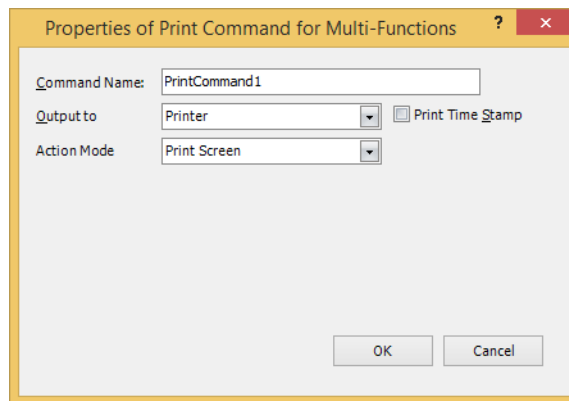

■ **Command Name**

Enter a name for the command. The maximum number is 20 characters.

■ **Output to**

Select where to direct the screenshot to.

Printer^{*1}:

Outputs the screenshot to the printer connected to the MICRO/I.

Print Time Stamp:

Adds the date and time of printing to the screenshot before sending it to the printer.

The date and time format depends on the language selected in

Language. Language is available on the **Project Details** tab of the **Project Settings** dialog box.

The display formats are shown below:

- Japanese: YYYY/MM/DD hh:mm
- English: MM/DD/YYYY hh:mm

YYYY: year, MM: month, DD: day, hh: hour, mm: minute

External Memory Device^{*2}: Outputs the screenshot as a file to the external memory device inserted in the MICRO/I.

Files are output as follows:

File format	File name	File size
JPEG	CAP***.JPG (***: date and time when file was output) Example: A file created at 18:50:25 on June 30, 2011 will be named "CAP110630_185025.JPG".	Depends on image being displayed.



- For details about printers, refer to Chapter 32 "Printer" on page 32-1.
- For details about external memory devices, refer to Chapter 31 "External Memory Devices" on page 31-1.

■ **Action Mode**

Select the behavior of the button from the following. This option is displayed only when **Printer** is selected in **Output to**.

Print Screen:

Outputs a screenshot of the current screen to the printer or the external memory device.

Cancel Printing^{*1}:

Cancels printout to the printer.

*1 HG5G/4G/3G/2G-V, HG4G/3G, HG2G-5F only

*2 USB flash drive inserted in USB1 for HG2J-7U, SD memory card for HG5G/4G/3G/2G-V, HG4G/3G and HG2G-5F, USB flash drive for HG2G-5T and HG1G/1P



- These operations cannot be performed simultaneously.
 - Outputting to the external memory device by pressing the Multi-Command.
 - Outputting to the printer by pressing the Multi-Command.*1
 - Printing alarm logs
- It may take some time to output screenshots when copying files using the USB Autorun function or a Key Button.
- MICRO/I cannot stop printing in the middle of a page, even when the print job is canceled. Print jobs after the current print job are canceled after the current page finishes printing.



The maximum number of screenshots that can be captured (1 to 999) can be set in HMI Special Data Register LSD65. (Default: 99)



The methods to erase screenshot files saved on the external memory device are as follows.

- To erase files during operation using parts, on the **External Memory Device** tab on the **Project Settings** dialog box, select the **Remove Files** check box and the **All Screenshot data** check box, and then configure the trigger device address. Assign that trigger device address to a part.
- To erase files with WindO/I-NV4, click **Clear** on the **Online** tab, and then click **Stored Data in External Memory Device** to open the Clear Data dialog box. Select the **Screenshot Data** check box and click **OK**.
- To erase files on the HG5G/4G/3G/2G-V, HG4G/3G and the HG2G-5F, go to the System Mode - File Manager. In the File Manager, select the files to be deleted by pressing **DEL**.

*1 HG5G/4G/3G/2G-V, HG4G/3G, HG2G-5F only

Properties of Key for Multi-Functions Dialog Box

Sets the Key command for the Multi-Command.

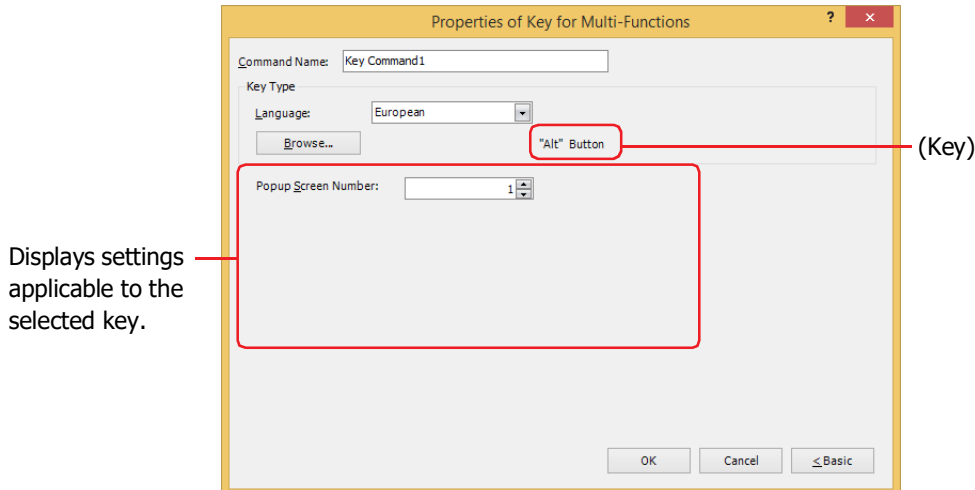

■ **Command Name**

Enter a name for the command. The maximum number is 20 characters.

■ **Key Type**

Select the function for the Key Button

Language: Switches the display of the key that is displayed when **Keypad** is selected in Key Browser. These languages are available:

Western, Japanese, Central European, Baltic, Cyrillic.

Browse: Opens the Key Browser when clicked. Select a key.
For details, refer to Chapter 8 "5.5 Key Browser" on page 8-99.

(Key): Displays the name of the key selected using the Key Browser.



- When you select a key for Multi-Button or Multi-Command, the label for that key is not assigned as the Registration Text.
- The function of Key Button will affect on the next scan when the trigger condition is satisfied.

The settings explained below appear depending on the type of key selected.

■ **Popup Screen Number**

The **Alt** key switches the current Popup Screen used as a Keypad when this button is pressed.

Specify the Popup Screen number to open a Keypad for.

This setting is enabled only if **Alt** was selected using the Key Browser.

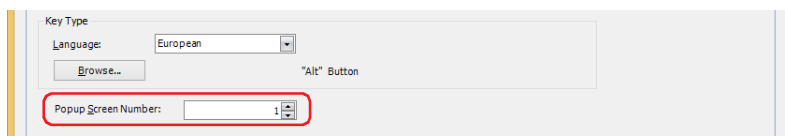

■ Scroll Size

Key Buttons **Page Up** and **Page Down** scroll the list up and down, respectively. Key Buttons **Up** and **Down** move the focus up and down, respectively. This settings specifies the number of pages or lines (1 to 1023 lines) to scroll or move the focus per each press of the button.

This setting is enabled only if **Page Up**, **Page Down**, **Up**, and **Down** are selected using the Key Browser.



■ Transfer Setting

Key Buttons **Download Project**, **Upload Project**, **Copy Files**, **Download PLC Program**, and **Upload PLC Program**, perform the data transfer function specified by their names. These settings specify the source, data to be transferred, and destination.

This setting is enabled only if one of these keys is selected after clicking **Data Transfer** in the Key Browser.

Download Project is selected.

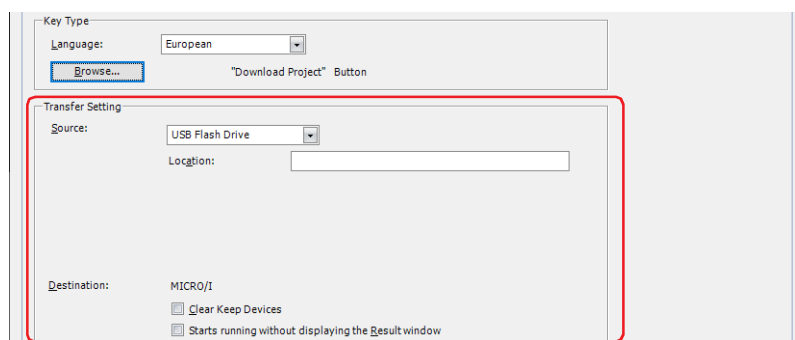

Source: Select the external memory where the project (ZNV Project File) to be transferred is stored:
SD Memory Card*1, USB Flash Drive*2, USB1*3 or USB2*3.

Location: Specify the location of the ZNV Project File (.znv). The maximum number is 247 characters. Only alphanumeric characters and symbols can be used. Path delimiters and characters that cannot be used vary based on the model.

Model	Delimiter	Characters that cannot be used
HG2J-7U	/	" # \$ & ' () * : ; < > ? \ ` ~
HG5G/4G/3G/2G-V, HG4G/3G, HG2G-5F/-5T, HG1G/1P	\	" * : ; < > ?

Example: To set "HG3G_DEMO_1.ZNV", a ZNV Project File, to be saved on the root directory of an external memory device:
HG3G_DEMO_1.ZNV

Destination: Displays a download destination of the project.

Clear Keep Devices:

Select this check box to clear keep devices after the project data is downloaded. However, when project data that changes the system software or settings of the data storage area is downloaded, the keep devices are always cleared.



When project data is downloaded, the alarm log data, data log data, and operation log data is deleted regardless of the state of the **Clear Keep Devices** check box.

Starts running without displaying the Result window:

Select this check box to start running MICRO/I without displaying the execution result screen after the project data is downloaded.

*1 HG5G/4G/3G/2G-V, HG4G/3G, HG2G-5F only

*2 HG5G/4G/3G/2G-V, HG4G/3G, HG2G-5F/-5T, HG1G/1P only

*3 HG2J-7U only

Upload Project is selected.

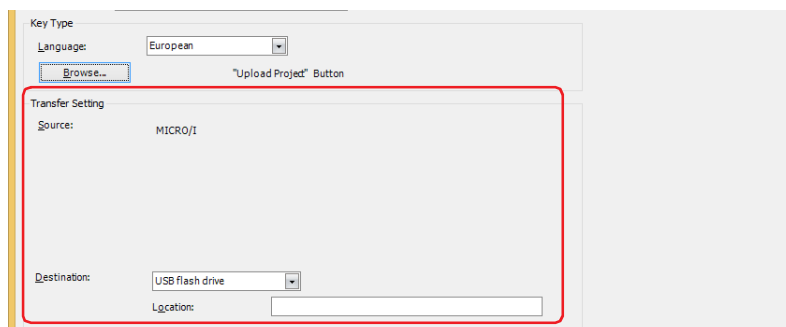

Destination: Specify where to save the project uploaded from MICRO/I. Select the location:

SD Memory Card^{*1}, USB Flash Drive^{*2}, USB1^{*3} or USB2^{*3}.

Location: Specify the location where the uploaded project will be saved. The maximum number is 247 characters. Only alphanumeric characters and symbols can be used. Path delimiters and characters that cannot be used vary based on the model.

Model	Delimiter	Characters that cannot be used
HG2J-7U	/	" # \$ & ' () * : ; < > ? \ ` ~
HG5G/4G/3G/2G-V, HG4G/3G, HG2G-5F/-5T, HG1G/1P	\	" * : ; < > ?

Example: To save a project to the folder "Uploaded_Project" in an external memory device:
Uploaded_Project



A uploaded project using the Data Transfer function is saved as a ZNV Project File(.zmv).

*1 HG5G/4G/3G/2G-V, HG4G/3G, HG2G-5F only

*2 HG5G/4G/3G/2G-V, HG4G/3G, HG2G-5F/-5T, HG1G/1P only

*3 HG2J-7U only

Copy Files^{*4} is selected.

Source: Select the source external memory: **SD Memory Card**^{*1}, **USB Flash Drive**^{*1}, **USB1**^{*3} or **USB2**^{*3}.

Location: Specify the location of the file to be transferred. The maximum number is 247 characters. Only alphanumeric characters and symbols can be used. Path delimiters and characters that cannot be used vary based on the model.

Model	Delimiter	Characters that cannot be used
HG2J-7U	/	" # \$ & ' () * : ; < > ? \ ` ~
HG5G/4G/3G/2G-V, HG4G/3G, HG2G-5F	\	" * : ; < > ?

Example: Copy a file "Error.wav" to the root directory of an external memory device:
Error.wav

Destination: Select the destination external memory: **SD Memory Card**^{*1}, **USB Flash Drive**^{*1}, **USB1**^{*3} or **USB2**^{*3}.

Location: Specify the location where the file will be transferred. The maximum number is 247 characters. Only alphanumeric characters and symbols can be used. Path delimiters and characters that cannot be used vary based on the model.

Model	Delimiter	Characters that cannot be used
HG2J-7U	/	" # \$ & ' () * : ; < > ? \ ` ~
HG5G/4G/3G/2G-V, HG4G/3G, HG2G-5F	\	" * : ; < > ?

Example: Save a file to the "SOUND" folder under "HGDATA01" folder in an external memory device:

HG2J-7U: HGDATA01/SOUND

HG5G/4G/3G/2G-V, HG4G/3G, HG2G-5F: HGDATA01\SOUND



- If a file name is specified as the source location, the specified file is copied. If a folder name is specified, all of the files and subfolders contained in the folder, and all of the files in the subfolders, are copied.
- The subfolders can be copied up to five levels.
- To prevent copying the subfolders and the files contained in the subfolders, HMI Special Internal Relay LSM30 must be set to 1 before executing the copy.
- To stop copying files during the copy operation, write 1 to HMI Special Internal Relay LSM31. However, it will continue to copy the file until it is finished then it will stop copying.

*1 HG5G/4G/3G/2G-V, HG4G/3G, HG2G-5F only

*3 HG2J-7U only

*4 HG2J-7U, HG5G/4G/3G/2G-V, HG4G/3G, HG2G-5F only

Download PLC Program is selected.

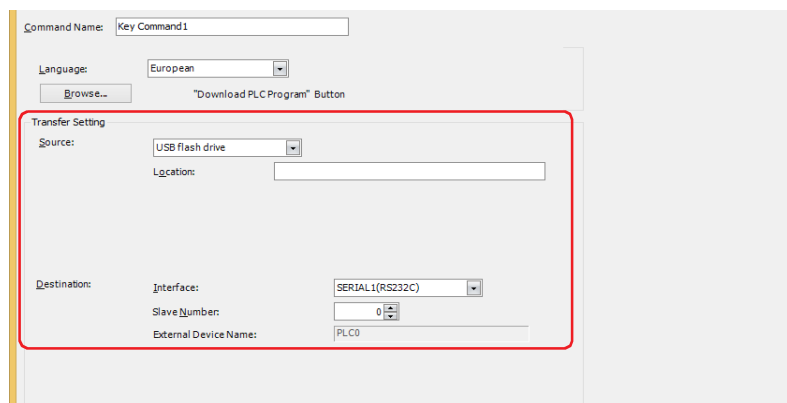

Source: Select the external memory where the PLC program (ZLD Project File) to be transferred is stored:

SD Memory Card*¹, USB Flash Drive*², USB1*³ or USB2*³.

Location: Specify the location of the ZLD Project File(.zld). The maximum number is 247 characters. Only alphanumeric characters and symbols can be used. Path delimiters and characters that cannot be used vary based on the model.

Model	Delimiter	Characters that cannot be used
HG2J-7U	/	" # \$ & ' () * : ; < > ? \ ` ~
HG5G/4G/3G/2G-V, HG4G/3G, HG2G-5F/-5T, HG1G/1P	\	" * : ; < > ?

Example: To set "LDR_PROGRAM.ZLD", a ZLD Project File, to be saved in folder "LDRDATA" of an external memory device:

HG2J-7U: LDRDATA/LDR_PROGRAM.ZLD

HG5G/4G/3G/2G-V, HG4G/3G, HG2G-5F/-5T, HG1G/1P: LDRDATA\LDR_PROGRAM.ZLD

Destination: Specify the destination PLC connected to the MICRO/I. The PLC type is configured in the **Project Settings** dialog box, on the **Communication Driver Network** tab. For details, refer to Chapter 4 "3.4 Communication Driver Network Tab" on page 4-52.

Interface: Select the communication interface in which the MICRO/I is connecting to the download destination PLC from serial interface or Ethernet. For details, refer to Chapter 4 "Interface Configuration" on page 4-35.

If serial interface is selected for **Interface**.

Slave Number: Specify the slave number of the download destination PLC (0 to 31).

External Device Name: The name of the specified PLC is displayed here.

If **Ethernet** is selected for **Interface**.

Select from the following method:

Specify External Device ID: Specify the External Device ID (0 to 31) of the destination PLC. This is the External Device ID number set in the **Project Settings** dialog box, on the **Communication Driver Network** tab.

External Device Name: The name of the specified PLC is displayed here.

Specify IP Address: Specify the IP address and port number of the destination PLC.

*1 HG5G/4G/3G/2G-V, HG4G/3G, HG2G-5F only

*2 HG5G/4G/3G/2G-V, HG4G/3G, HG2G-5F/-5T, HG1G/1P only

*3 HG2J-7U only

Upload PLC Program is selected.

The screenshot shows a software interface for uploading a PLC program. A red box highlights the 'Transfer Setting' section, which contains the following fields:

- Source:**
 - Interface: SERIAL1(RS232C)
 - Slave Number: 0
 - External Device Name: PLC0
- Destination:**
 - USB flash drive
 - Location: (empty text field)

Source: Specify the source PLC connected to the MICRO/I. The PLC type is configured in the **Project Settings** dialog box, on the **Communication Driver Network** tab. For details, refer to Chapter 4 "3.4 Communication Driver Network Tab" on page 4-52.

Interface: Select the communication interface in which the MICRO/I is connecting to the upload source PLC from serial interface or Ethernet. For details, refer to Chapter 4 "Interface Configuration" on page 4-35.

If serial interface is selected for **Interface**.

Slave Number: Specify the slave number of the upload source PLC (0 to 31).

External Device Name: The name of the specified PLC is displayed here.

If **Ethernet** is selected for **Interface**.

Select from the following method:

Specify External Device ID: Specify the External Device ID (0 to 31) of the upload source PLC. This is the External Device ID number set in the **Project Settings** dialog box, on the **Communication Driver Network** tab.

External Device Name: The name of the specified PLC is displayed here.

Specify IP Address: Specify the IP address and port number of the upload source PLC.

Destination: Specify where to save the PLC program uploaded from the PLC connected to the MICRO/I. Select the type of external memory: **SD Memory Card**^{*1}, **USB Flash Drive**^{*2}, **USB1**^{*3} or **USB2**^{*3}.

Location: Specify the location of the folder where the uploaded PLC program will be saved. The maximum number is 247 characters. Only alphanumeric characters and symbols can be used. Path delimiters and characters that cannot be used vary based on the model.

Model	Delimiter	Characters that cannot be used
HG2J-7U	/	" # \$ & ' () * : ; < > ? \ ` ~
HG5G/4G/3G/2G-V, HG4G/3G, HG2G-5F/-5T, HG1G/1P	\	" * : ; < > ?

Example: To save a program to the folder "Uploaded_Program" in an external memory device:
Uploaded_Program



A uploaded PLC program using the Data Transfer function is saved as a ZLD Project File(.zld).

*1 HG5G/4G/3G/2G-V, HG4G/3G, HG2G-5F only

*2 HG5G/4G/3G/2G-V, HG4G/3G, HG2G-5F/-5T, HG1G/1P only

*3 HG2J-7U only

■ Recording Channel*5

The recording of images starts.

Selects **Channel 1** or **Channel 2** to record a video only (no audio) out of the signals input from the device. This setting is enabled only if **Rec.** was selected using the Key Browser.

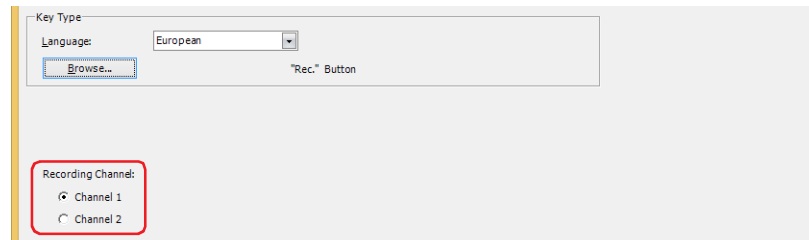

- Movie files cannot be recorded during playback.
- While data is being recorded after an event occurs with the event recording function and while data is being saved to the external memory device, recording cannot be executed with a Key Button, Multi-Button, or Multi-Command configured with the recording function. Also, during these situations, the value of HMI Special Data Register LSD155-0 changes to 1. For details, refer to Chapter 33 "HMI Special Data Register (LSD)" on page 33-8.

■ Recording Target*6

The recording of images and sound starts.

Select the target to record out of the signals input from the device. This setting is enabled only if **Rec.** was selected using the Key Browser.

Video and Audio: Records images and sound.

Video only (No Audio): Records images only.

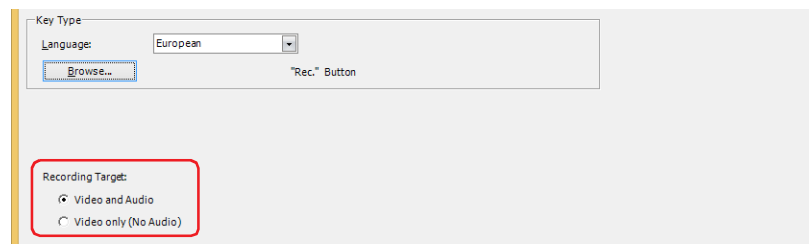

- Movie files cannot be recorded during playback.
- While data is being recorded after an event occurs with the event recording function and while data is being saved to the external memory device, recording cannot be executed with a Key Button, Multi-Button, or Multi-Command configured with the recording function. Also, during these situations, the value of HMI Special Data Register LSD155-0 changes to 1. For details, refer to Chapter 33 "HMI Special Data Register (LSD)" on page 33-8.

*5 HG5G/4G/3G-V only

*6 This is applicable for HG4G/3G with a video interface only.

Properties of Script for Multi-Functions Dialog Box

Sets the script for the Multi-Command.

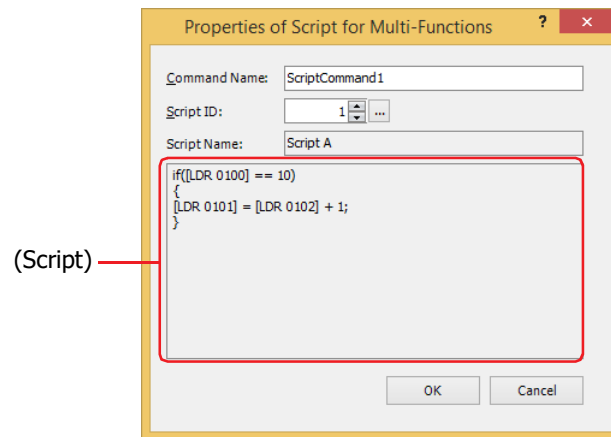

- **Command Name**
Enter a name for the command. The maximum number is 20 characters.
- **Script ID**
Specify the script ID (1 to 32000) of the script to operate.
Script Manager will open when is clicked. Select a script from the script list.
For details, refer to Chapter 20 "2.2 Script Manager" on page 20-7.
- **Script Name**
Displays the name of the script selected in Script Manager.
- **(Script)**
Displays the contents of the script selected in Script Manager.
Once this area is double clicked, the Script Editor will open and editing can be done.
For details, refer to Chapter 20 "2.3 Script Editor" on page 20-12.

● Trigger Condition Tab

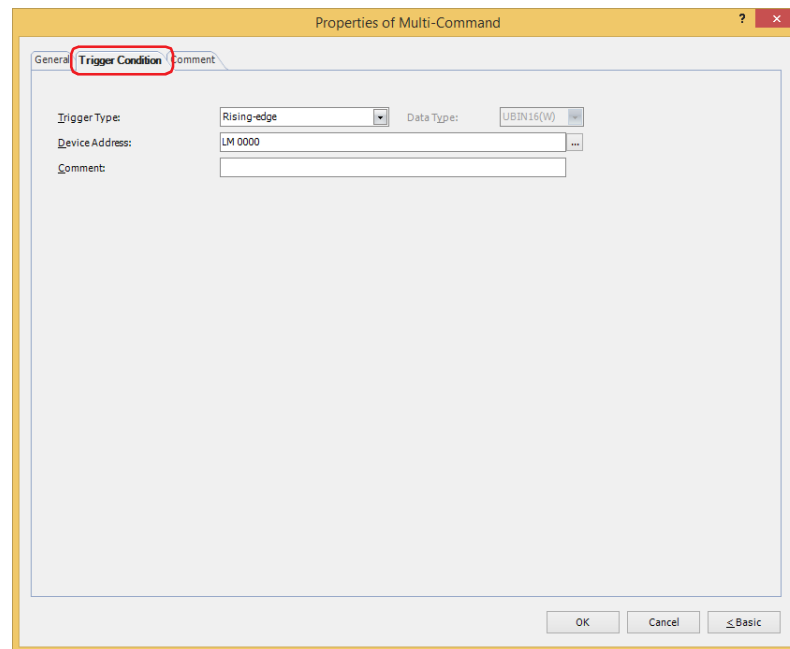

When the condition has been or is satisfied, the command is executed; when not satisfied, the command is not executed.

Example: When **Trigger Type** is **Rising-edge** and **Device Address** is **LM0**
The command is executed when LM0 changes from 0 to 1.

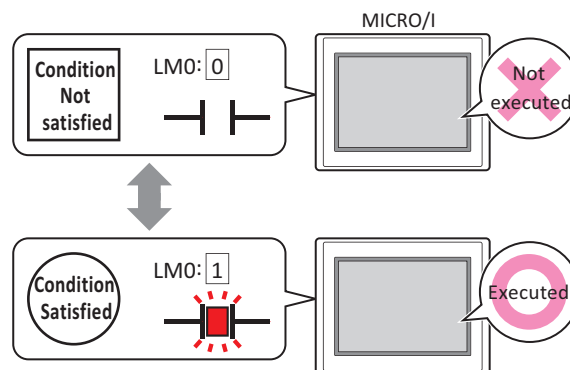

■ Trigger Type

Selects the condition to execute the command from the following.

Rising-edge: Command is executed when a value of device address changes from 0 to 1.

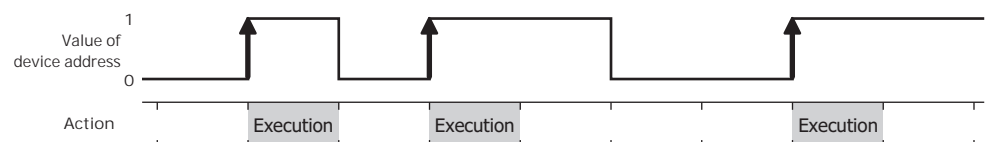

Falling-edge: Command is executed when a value of device address changes from 1 to 0.

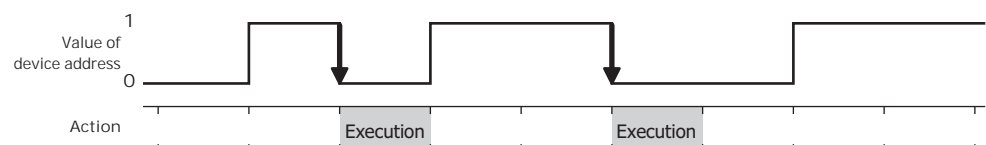

Satisfy the condition: Command is executed when condition changes from not satisfied to satisfied.

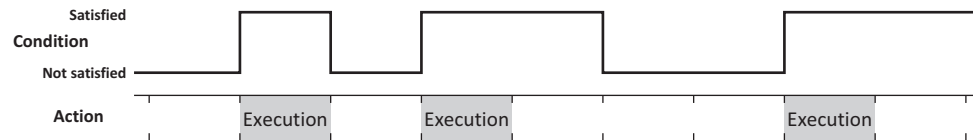

While satisfying the condition:

The command continues being executed while the condition is satisfied.

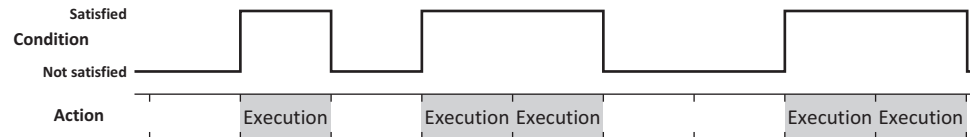

■ Data Type

Selects the data type to be handled by the condition formula.

Can only be set if **Satisfy the condition** or **While satisfying the condition** is selected as **Trigger Type**.

For details, refer to Chapter 2 "1.1 Available Data" on page 2-1.

■ Device Address

Specifies the bit device or the bit number of the word device to serve as condition.

Can only be set if **Rising-edge** or **Falling-edge** is selected as **Trigger Type**.

Click to display the Tag Editor. For the device address configuration procedure, refer to Chapter 2 "5.1 Device Address Settings" on page 2-70.

■ Condition

Specifies the conditional expression.

This option can only be configured when **Satisfy the condition** or **While satisfying the condition** is selected for **Trigger Type**.

Click to display the **Trigger Condition Settings** dialog box. For the conditional expression configuration procedure, refer to Chapter 2 "5.2 Setting Conditional Expressions" on page 2-73.

■ Comment

Used for entering comments about trigger conditions. The maximum number is 80 characters.

● Comment Tab

The **Comment** tab is used to specify the parts placed on the editing screen, and the popup text displayed when the mouse pointer is placed close to **No.**, **Name**, or **Type** in the object list.



When there are multiple parts of the same shape on the screen, this feature makes it possible to distinguish between the parts without displaying the Properties dialog box for each part, by just mousing over the part.

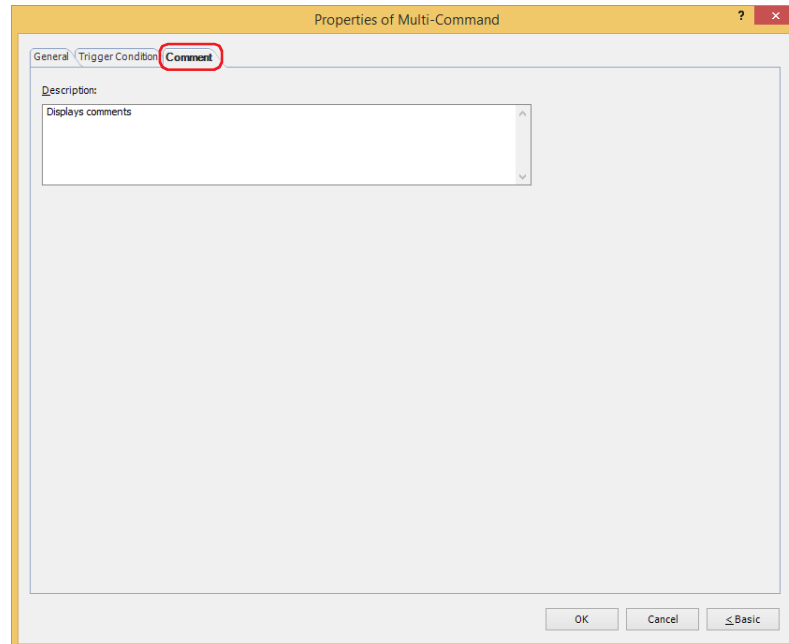

■ Description

Used for entering comments about parts. The maximum number is 80 characters.

Example: When mousing over the Multi-Command on the editing screen



7 Timer

HG2J-7U HG5G-V HG4G-V HG4G HG3G-V HG3G HG2G-V HG2G-5F HG2G-5T HG1G HG1P

7.1 How the Timer is Used

Starts a countdown when the trigger condition is satisfied, and writes 1 to an internal device (HMI Timer Relay LTC) once the set time has elapsed.

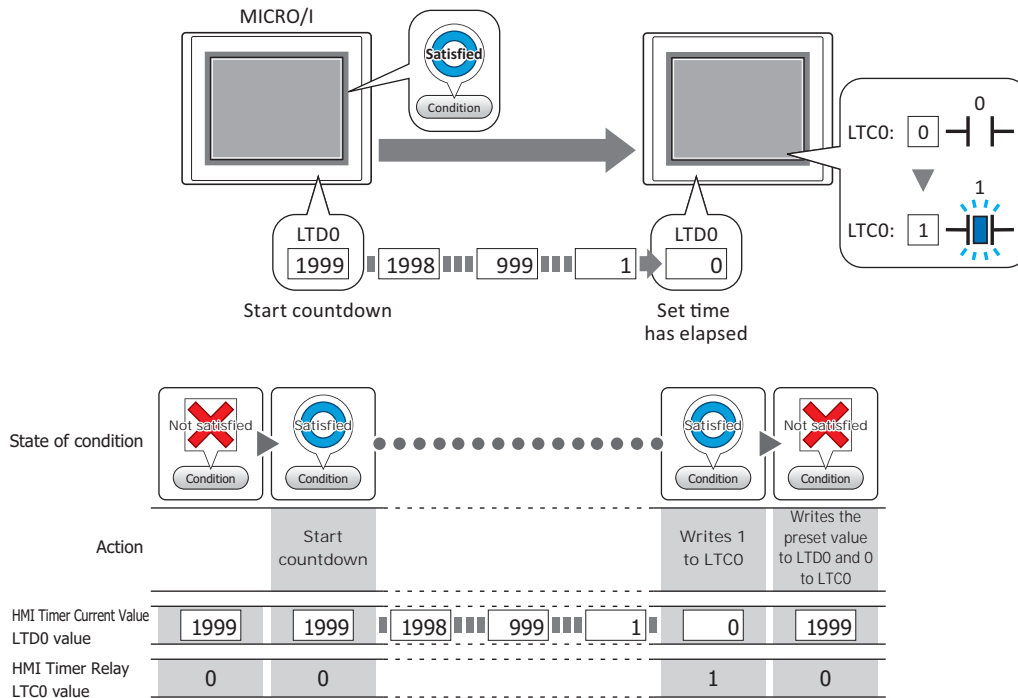

- The HMI Timer Relay LTC is an internal device (bit device) that changes to 1 once the time set for the timer has elapsed.
- The HMI Timer Current Value LTD is an internal device (word device) that stores current values for the timer.
- Once switched to the screen that the timer has been placed in, the following values will be given regardless of whether the trigger condition is satisfied or not satisfied.
 - HMI Timer Relay LTC: 0
 - HMI Timer Current Value LTD: Preset Value

7.2 Timer Configuration Procedure

This section describes the configuration procedure for Timers.

- 1 On the **Home** tab, in the **Parts** group, click **Commands**, and then click **Timer**.

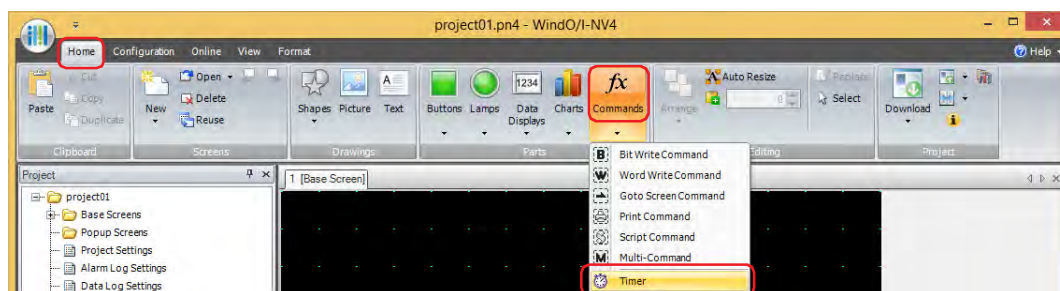

- 2 Click a point on the edit screen where you wish to place the Timer.
- 3 Double-click the placed Timer and a Properties dialog box will be displayed.
- 4 Change the settings on each tab as necessary.

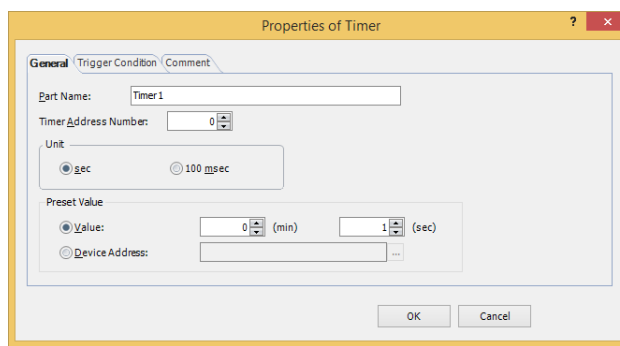

7.3 Properties of Timer Dialog Box

This section describes items and buttons in the Properties dialog box.

● General Tab

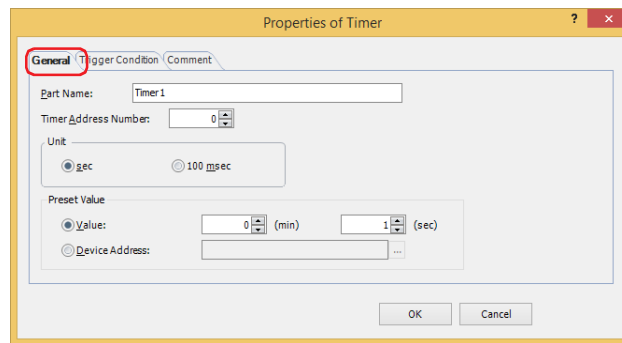

■ Part Name

Enter a name for the part. The maximum number is 20 characters.

■ Timer Address Number

Specifies the HMI timer address number (0 to 31).

The device type for the HMI timer relay is LTC. The device type where the current value is stored is LTD.

Example: When 0 is specified for **Timer Address Number**

HMI Timer Relay: LTC0

HMI Timer Current Value: LTD0

■ Unit

Select the unit of time from **sec** or **100 msec**.

■ Preset Value

Select the data type to use and enter the preset value.

The preset value is the time from when the timer starts its countdown until 1 is written to the HMI Timer Relay LTC.

Value: When selecting **sec** in **Unit**, the preset value is specified with 1 to 65535 (second units) up to a maximum of 1092 minutes 15 seconds.

When selecting **100 msec** in **Unit**, the preset value is specified with 1 to 65535 (100 msec units).

Device Address: Uses a value of device address.

Specify the device address.

Click to display the Tag Editor. For the device address configuration procedure, refer to Chapter 2 "5.1 Device Address Settings" on page 2-70.

● **Trigger Condition Tab**

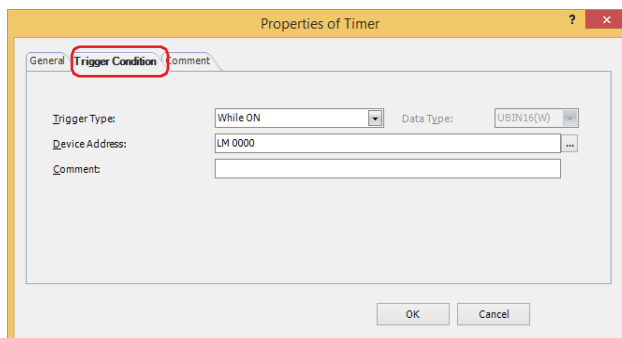

When the condition has been or is satisfied, the command is executed; when not satisfied, the command is not executed.

Example: When **Trigger Type** is **Rising-edge** and **Device Address** is **LM0**
The command is executed when LM0 changes from 0 to 1.

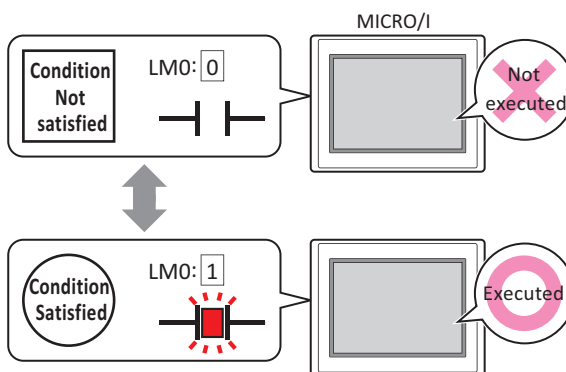

■ **Trigger Type**

Selects the condition to execute the command from the following.

While ON: Command is executed when a value of device address is 1.

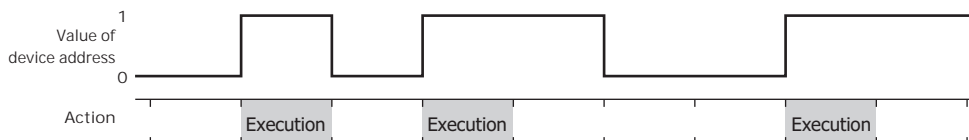

While OFF: Command is executed when a value of device address is 0.

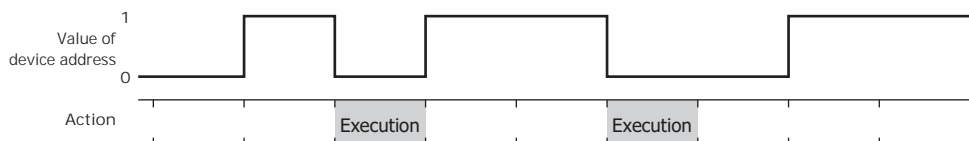

While satisfying the condition:

The command continues being executed while the condition is satisfied.

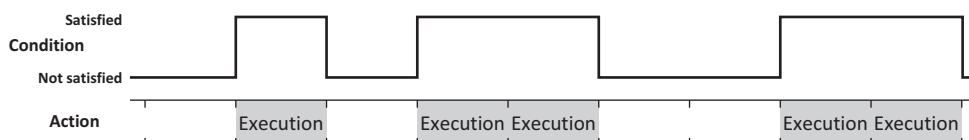

■ Data Type

Selects the data type to be handled by the condition formula.

Can only be set if **While satisfying the condition** is selected as **Trigger Type**.

For details, refer to Chapter 2 "1.1 Available Data" on page 2-1.

■ Device Address

Specifies the bit device or the bit number of the word device to serve as condition.

Can only be set if **While ON** or **While OFF** is selected as **Trigger Type**.

Click  to display the Tag Editor. For the device address configuration procedure, refer to Chapter 2 "5.1 Device Address Settings" on page 2-70.

■ Condition

Specifies the conditional expression.

This option can only be configured when **While satisfying the condition** is selected for **Trigger Type**.

Click  to display the **Trigger Condition Settings** dialog box. For the conditional expression configuration procedure, refer to Chapter 2 "5.2 Setting Conditional Expressions" on page 2-73.

■ Comment

Used for entering comments about trigger conditions. The maximum number is 80 characters.

● Comment Tab

The **Comment** tab is used to specify the parts placed on the editing screen, and the popup text displayed when the mouse pointer is placed close to **No.**, **Name**, or **Type** in the object list.



When there are multiple parts of the same shape on the screen, this features makes it possible to distinguish between the parts without displaying the Properties dialog box for each part, by just mousing over the part.

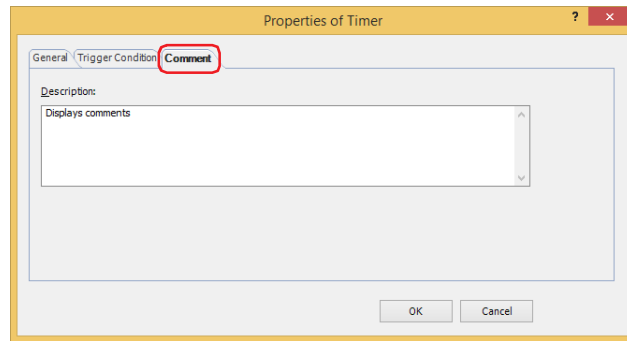

■ Description

Used for entering comments about parts. The maximum number is 80 characters.

Example: When mousing over the Timer on the editing screen

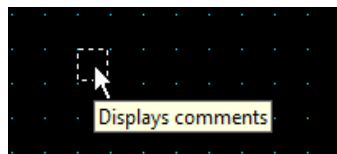

Chapter 13 Alarm Log Function

This chapter describes how to configure the Alarm Log function and its operation on the MICRO/I.

1 Overview

HG2J-7U HG5G-V HG4G-V HG4G HG3G-V HG3G HG2G-V HG2G-5F HG2G-5T HG1G HG1P

1.1 How the Alarm Log Function is Used

The Alarm Log function samples the occurrence of alarms and recovery information by monitoring and evaluating the state of device addresses.

The Alarm Log function can perform the following functions.

- Monitor states of device addresses and create Alarm Log data

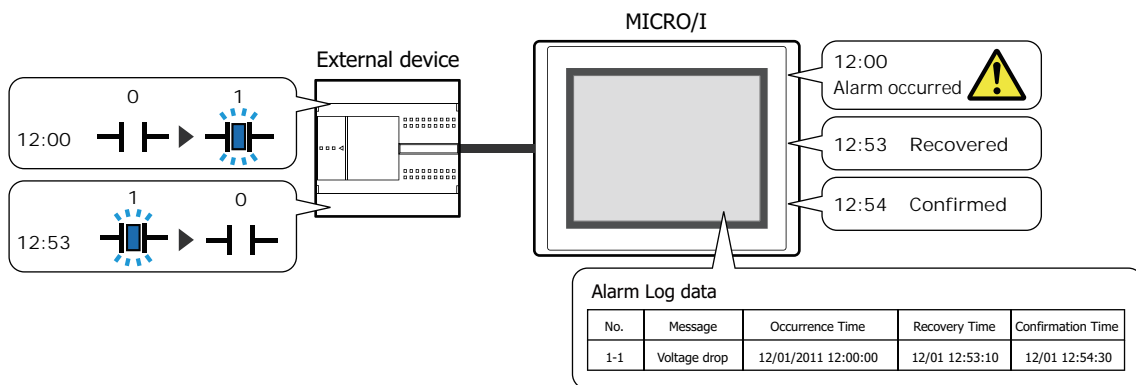

- Monitor states of device addresses and detect alarms

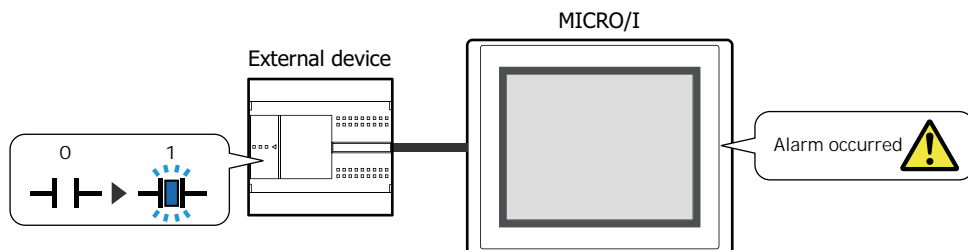

- Display an alarm screen when an alarm occurs

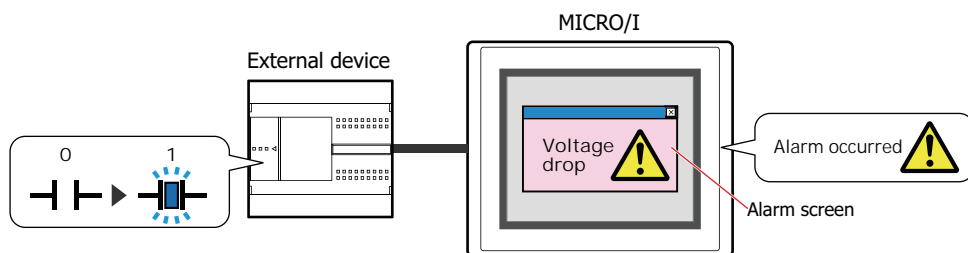

- Make a sound of the buzzer and screen flashing the screen when an alarm occurs

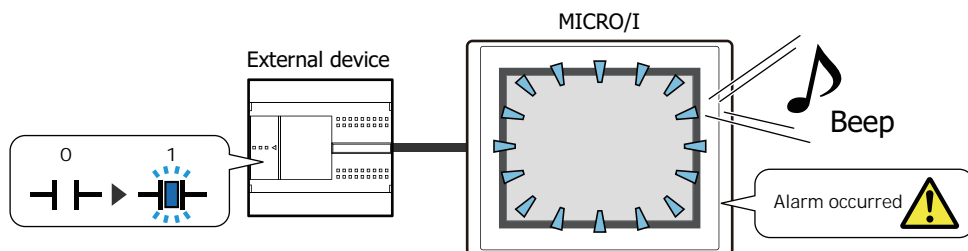

- Output Alarm Log data to the external memory device^{*1}

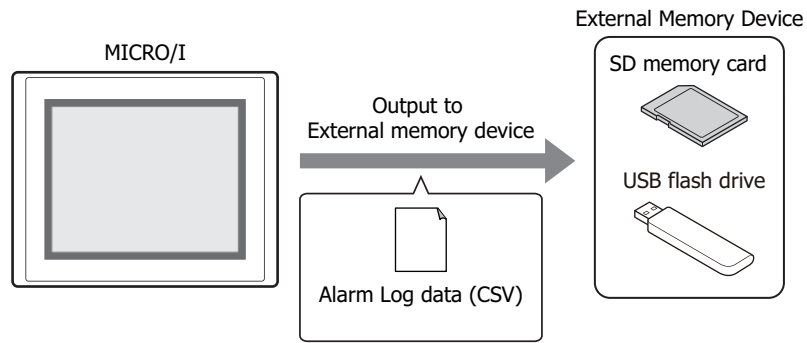

- Output Alarm Log data to the printer

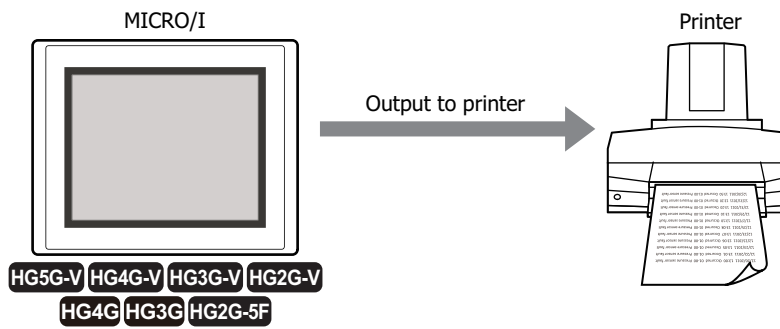

For compatible printers and instructions on how to connect one to the MICRO/I, refer to Chapter 32 "1.2 Connecting a Printer to MICRO/I" on page 32-1.

^{*1} USB flash drive inserted in USB1 for HG2J-7U, SD memory card for HG5G/4G/3G/2G-V, HG4G/3G and HG2G-5F, USB flash drive for HG2G-5T and HG1G/1P

1.2 Alarm States

Alarms have three states: occurred, recovered, and confirmed.

Alarm state	Details
Occurred	Indicates that an alarm has occurred. There are two types of alarms that occur. First Alarm: The first alarm that occurs in a state where no alarms have occurred. Second and later: An alarm that has occurred while another alarm is active.
Recovered	Indicates that the alarm that occurred has been recovered from. However, for channels set to lock, the alarm is not recovered from until a key button is pressed (CHECK or All Chk.).
Confirmed	Indicates the key button CHECK or All Chk. was pressed.

Example: When the source device address (the device address to monitor) is D100-0, the error state (when an alarm has occurred) is ON, the channel is set to **Unlock**, and the used key button is **CHECK**
When the source device address is ON, the alarm changes to the "Occurred" state. When the source device is OFF, the alarm changes to the "Recovered" state. When **CHECK** is pressed, the alarm changes to the "Confirmed" state.

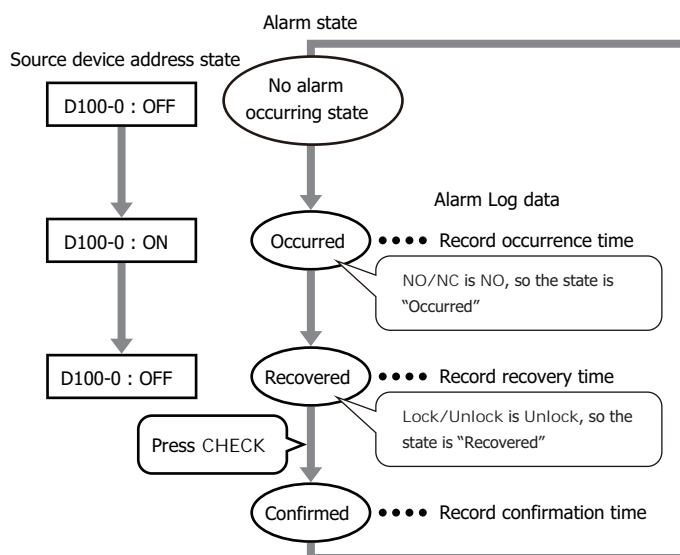

If **CHECK** is pressed before the source device address changes to OFF, the alarm changes to the "Confirmed" state regardless of the state of the source device address.

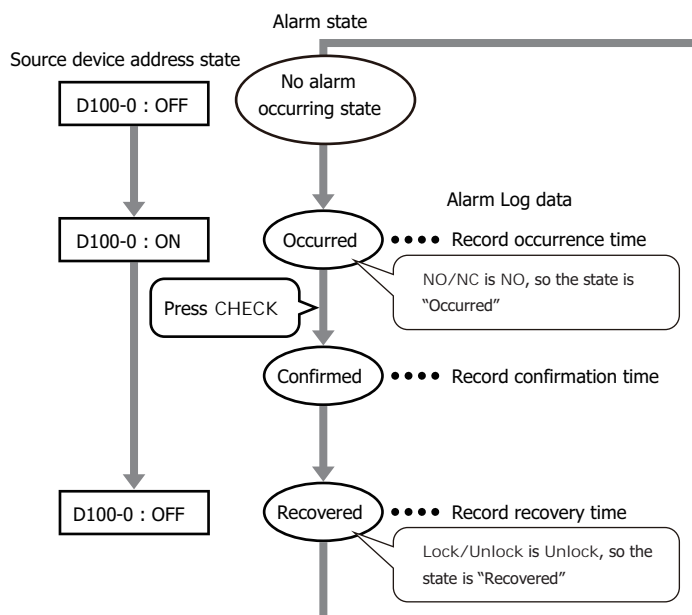

1.3 Sampling Data

Data is sampled each time the alarm occurs, is recovered from, or confirmed.

Example: When the message for channel number 1-1 is "Voltage drop" and the message for channel number 1-2 is "Abnormal temperature"

1	Channel No. 1-1: Alarm occurred (12:50:00)	Ch.No.	Message	Occurrence Time	Recovery Time	Confirmation Time
	Channel No. 1-2: No alarm	1-1	Voltage drop	12/01/2011 12:50:00	–	–
2	Channel No. 1-1: Alarm (12:50:00)	Ch.No.	Message	Occurrence Time	Recovery Time	Confirmation Time
	Channel No. 1-2: Alarm occurred (12:50:10)	1-1	Voltage drop	12/01/2011 12:50:00	–	–
3	Channel No. 1-1: Recovered from alarm (12:50:20)	Ch.No.	Message	Occurrence Time	Recovery Time	Confirmation Time
	Channel No. 1-2: Alarm (12:50:10)	1-2	Abnormal temperature	12/01/2011 12:50:10	–	–
4	Channel No. 1-1: CHECK pressed (12:50:30)	Ch.No.	Message	Occurrence Time	Recovery Time	Confirmation Time
	Channel No. 1-2: Alarm (12:50:10)	1-1	Voltage drop	12/01/2011 12:50:00	12/01 12:50:20	–
5	Channel No. 1-1: Alarm occurred (12:51:00)	Ch.No.	Message	Occurrence Time	Recovery Time	Confirmation Time
	Channel No. 1-2: Alarm (12:50:10)	1-2	Abnormal temperature	12/01/2011 12:50:10	–	–
6	Channel No. 1-1: Alarm (12:51:00)	Ch.No.	Message	Occurrence Time	Recovery Time	Confirmation Time
	Channel No. 1-2: CHECK pressed (12:52:10)	1-1	Voltage drop	12/01/2011 12:50:00	12/01 12:50:20	12/01 12:50:30
7	Channel No. 1-1: Alarm (12:51:00)	Ch.No.	Message	Occurrence Time	Recovery Time	Confirmation Time
	Channel No. 1-2: Recovered from alarm (12:52:10)	1-2	Abnormal temperature	12/01/2011 12:50:10	12/01 12:53:00	12/01 12:52:10
		Ch.No.	Message	Occurrence Time	Recovery Time	Confirmation Time
		1-1	Voltage drop	12/01/2011 12:51:00	–	–

1.4 Data Configuration

The sampled data is composed of the channel number, level, message, alarm state, time, and label. The relationship between the Alarm Log function settings and the sampled data is as follows.



1. Data storage amount: The amount of data that can be saved in the data storage area. For details, refer to "Data Storage Amount" on page 13-8.
2. Channel No.: Composed of (Block No.)-(Channel No.). The device addresses to monitor and the conditions for alarm occurrence and recovery are configured in the channels. When the sampled data is output as a CSV file, the displayed label is "Ch.No."
3. Level: It is the level of alarm.
Can only output when the **Output Alarm Level** check box in the **External Memory Device** tab on the Alarm Log Settings dialog box is selected.
4. Message: The message displayed when an alarm has occurred.
5. Alarm state and time: The alarm state (occurred, recovered, confirmed) and the time the alarm occurred, was recovered from, and confirmed. When the sampled data is output as a CSV file, the displayed label varies based on the output method.
6. Label: When the sampled data is output as a CSV file, this is the text displayed in the label row. This cannot be changed.

For sampled data, the format for displayed items varies based on the output method.

■ Batch

Batch output shows the recovery and confirmation time for an alarm that has occurred on a single line.

The labels displayed in the label row are "Ch.No.", "Level", "Message", "Occurrence Time", "Recovery Time", and "Confirmation Time".

Can only output the Level when the **Output Alarm Level** check box in the **External Memory Device** tab on the Alarm Log Settings dialog box is selected.

Example: The message for channel number 1-1 is "Voltage drop" and the Level is 8, and the message for channel number 1-2 is "Abnormal temperature" and the Level is 4.

Ch.No.	Level	Message	Occurrence Time	Recovery Time	Confirmation Time
1-1	Level 8	Voltage drop	12/01/2011 12:50:00	12/01 12:50:20	12/01 12:50:30
1-2	Level 4	Abnormal temperature	12/01/2011 12:50:10	--	12/01 12:52:10
1-1	Level 8	Voltage drop	12/01/2011 12:51:00	--	--

■ Real Time

Real time output displays the alarm state and the time the alarm became that state on a single line each time an alarm occurs, is recovered from, or is confirmed.

The labels displayed in the label row are "Time", "State", "Ch.No.", "Level", and "Message".

Can only output the Level when the **Output Alarm Level** check box in the **External Memory Device** tab on the Alarm Log Settings dialog box is selected.

Example: The message for channel number 1-1 is "Voltage drop" and the Level is 8, and the message for channel number 1-2 is "Abnormal temperature" and the Level is 4.

Time	State	Ch.No.	Level	Message
12/01/2011 12:50:00	Occurred	1-1	Level 8	Voltage drop
12/01/2011 12:50:10	Occurred	1-2	Level 4	Abnormal temperature
12/01/2011 12:50:20	Recovered	1-1	Level 8	Voltage drop

1.5 Saving and Deleting Data

● Saving Data

You can select whether or not to save the sampled data in the data storage area. The method to save data is configured on the **Channel** tab in the Alarm Log Settings dialog box.

When Saving Data to the Data Storage Area

Select **Store** under **Data** in the Auto-Setup dialog box or in the Individual Settings dialog box.

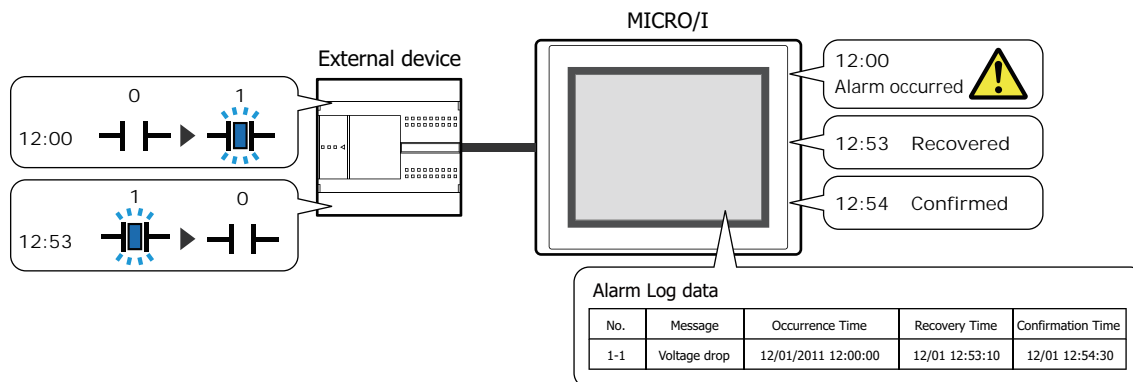

If the number of active alarms exceeds the Alarm Log data storage amount set for the data storage area, the data is processed with either of the following methods.

■ Fixed

If the saved data exceeds the Alarm Log data storage amount, the new data is not saved.

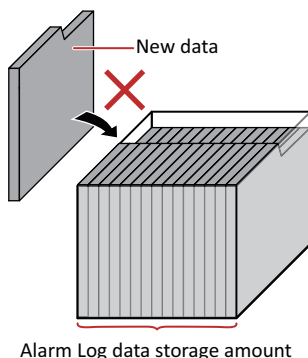

■ Rotate

If the saved data exceeds the Alarm Log data storage amount, the oldest data is deleted and the new data is saved.

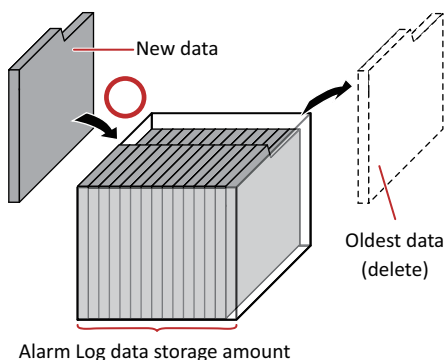

When the backup battery is depleted, the data in the Alarm Log is erased when the MICRO/I is turned off.

Data Storage Amount

The maximum amount of data that can be saved in the data storage area is as follows.

Model	Maximum amount of data that can be saved in the data storage area
HG5G/4G/3G/2G-V, HG4G/3G, HG2G-5F	11,660
HG2J-7U, HG2G-5T, HG1G/1P	5,520

When Not Saving Data to the Data Storage Area

Select **No Store** under **Data** in the Auto-Setup dialog box or in the Individual Settings dialog box.

Use this option to monitor a state of device address and display only detected active alarms on the Alarm List Display.

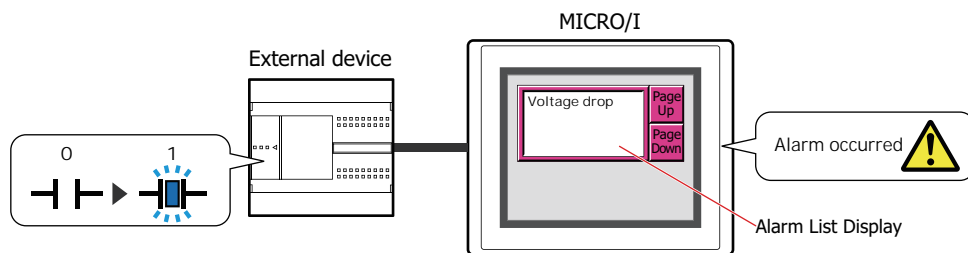

● Deleting Data

The method to delete sampled data from the data storage area is as follows.

- On the **Online** tab in WindO/I-NV4, click the arrow under **Clear**, and click **All** or **Alarm Log Data**. For details, refer to Chapter 24 "4 Clear" on page 24-26.
- In the System Mode, on the Main Menu screen, press **Initial Setting**, **Initialize**, **Alarm Log** in order.

1.6 Using Data and Detected Alarms

The saved data and detected alarms can be used in the following ways.

● Using Saved Data

The saved data can be used in the following ways.

Alarm Log data

Ch.No.	Message	Occurrence Time	Recovery Time	Confirmation Time
1-1	Voltage drop	12/01/2011 12:00:05	12/01 12:01:10	12/01 12:01:30
1-2	Abnormal temperature	12/01/2011 12:01:09	12/01 12:02:21	12/01 12:02:55
1-1	Voltage drop	12/01/2011 12:02:00	12/01 12:03:11	12/01 12:05:12
1-3	Overcurrent	12/01/2011 12:30:21	12/01 12:55:15	12/01 13:00:00
1-1	Voltage drop	12/01/2011 12:45:36	12/01 12:53:12	12/01 12:57:41



● Display data with the Alarm Log Display

Display Alarm Log data with the Alarm Log Display. For details, refer to Chapter 10 "8 Alarm Log Display" on page 10-153.

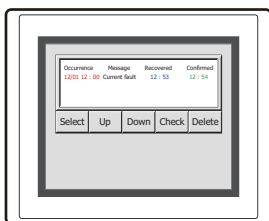

● Save to and read from an external memory device*1

Output data from the MICRO/I to the external memory device as a CSV file and use it on a computer. For details, refer to "4.4 Saving the Data as a CSV File" on page 13-38.

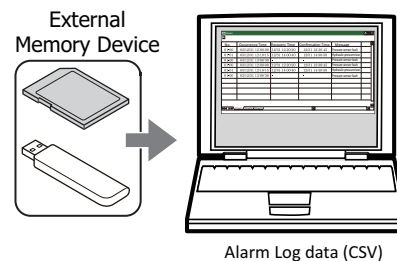

● Print data with the printer*2

Print Alarm Log data with the printer connected to the MICRO/I. For details, refer to Chapter 32 "Printer" on page 32-1

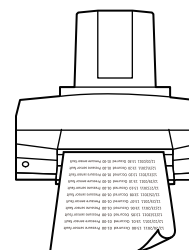

● Using Detected Alarms

● Display alarms with the Alarm List Display

Display detected alarms with the Alarm List Display. For details, refer to "4.2 Displaying Registered Messages with the Alarm List Display According to the Active Alarm" on page 13-33.

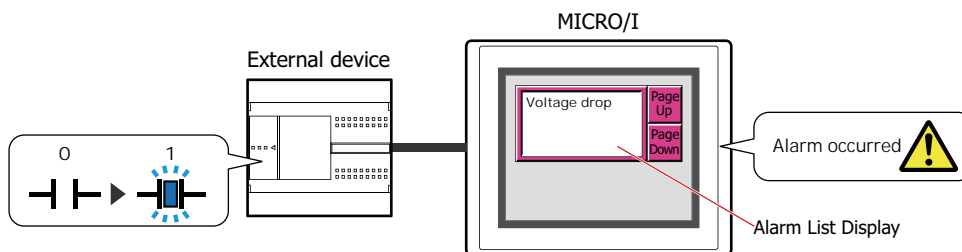

*1 USB flash drive inserted in USB1 for HG2J-7U, SD memory card for HG5G/4G/3G/2G-V, HG4G/3G and HG2G-5F, USB flash drive for HG2G-5T and HG1G/1P

*2 HG5G/4G/3G/2G-V, HG4G/3G, HG2G-5F only

2 Alarm Log Function Configuration Procedure

HG2J-7U HG5G-V HG4G-V HG4G HG3G-V HG3G HG2G-V HG2G-5F HG2G-5T HG1G HG1P

This section describes the configuration procedure for the Alarm Log function.

2.1 Configuring the Device Addresses to Monitor and the Alarm Detection Condition

- 1 On the **Configuration** tab, in the **System Setup** group, click **Alarm Log**.

The Alarm Log Settings dialog box is displayed.

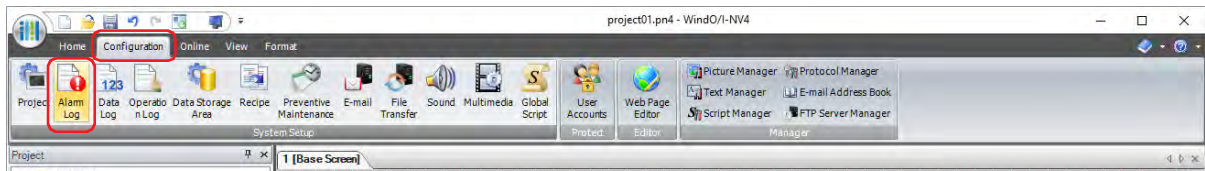

- 2 Select the type of device address to monitor under **Source Device Address Type** on the **Channel** tab.

If you select **Word**, device addresses are configured per block.

If you select **Bit**, device addresses are configured per channel.

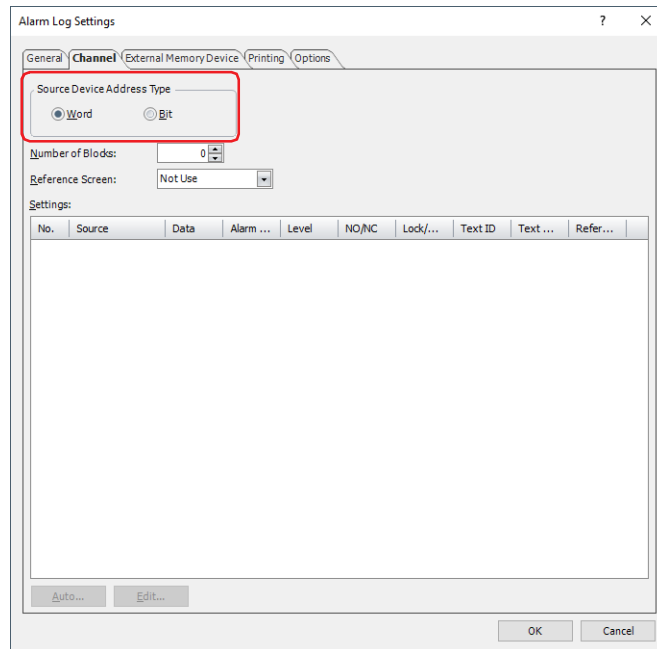

- 3 Set the number of blocks to manage in **Number of Blocks**.

1 channel is used for 1 device address to monitor. 1 block is 16 channels.

The number of blocks that can be set varies based on the **Source Device Address Type** setting and the model.

- 4 Select the reference screen type in **Reference Screen**.

The reference screen is associated with the channel. This screen is displayed when the key button **Ref.** is pressed.

If a reference screen is not displayed, select **Not Use**.

- 5 To batch register all channels, click **Auto**. To individually register each channel, click **Edit**.

An example when **Auto** is clicked is described here.

The Auto-Setup dialog box is displayed.

6 Specify the device address to monitor in **Source**.

Click to display the Tag Editor. For the device address configuration procedure, refer to Chapter 2 "5.1 Device Address Settings" on page 2-70.

For the Auto-Setup dialog box, the device addresses are sequentially set starting with the specified device address from the highlighted row in **Settings**.

The screenshot shows the 'Auto-Setup' dialog box with the following settings:

- Channel:** Block No.: , Channel No.:
- Block Settings:** Source: LDR.0000 (highlighted with a red box)
- Data:** Store, No Store
- Channel Settings:**
 - Alarm function: Enable, Disable
 - Level: 1
 - NO/NC: NO, NC
 - Lock/Unlock: Lock, Unlock
 - Text ID: 1
 - Text:
 - Reference Screen Number: 1

7 Under **Data**, select whether or not to save Alarm Log data in the date storage area.

To display Alarm Log data on the MICRO/I or to output the data to a file, select **Store**.

If you select **No Store**, Alarm Log data is not created, but states of device addresses are monitored.

8 Under **Alarm function**, select whether or not to use the alarm function.

For channels with **Disable** selected, states of device addresses are not monitored and Alarm Log data is not created.

9 Specifies the level (1 to 8) of the alarm in the **Level**.

Severity of the alarms is in ascending order (lowest to highest). Default is set to "1".

10 Under **NO/NC**, select the alarm detection condition.

If you select **NO**, the alarm occurs when the monitored bit changes from 0 to 1. If you select **NC**, the alarm occurs when the monitored bit changes from 1 to 0.

11 Under **Lock/Unlock**, select whether or not to automatically recover based on the state of the monitored bit.

If you select **Unlock**, the alarm is automatically recovered from based on the bit state when the monitored bit becomes the normal state.

If you select **Lock**, even if the monitored bit becomes the normal state, the alarm remains active until the key button **CHECK** is pressed.

12 Select the **Text ID** check box and specify the message to display when the alarm occurs as a Text Manager ID number (1 to 32000).

Number of blocks x 16 (number of channels) text IDs are used starting from the set ID number.

13 Specify the screen number (1 to 3000) to display when the key button **Ref.** is pressed in **Reference Screen Number**.

Number of blocks x 16 (number of channels) screens are used starting from the screen number.

This option can only be configured when **Base Screen** or **Popup Screen** is selected in **Reference Screen**.

14 Click **OK**.

The device addresses to monitor and the messages are batch configured and displayed in **Settings**.

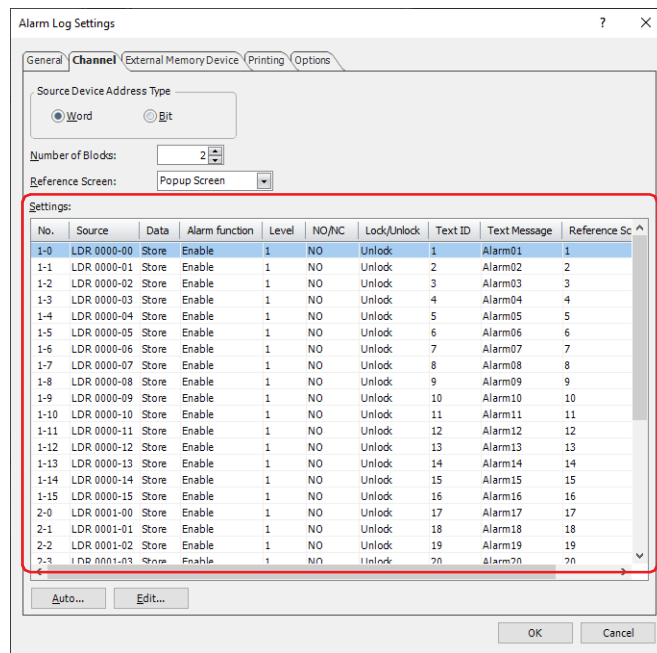
**15** Click **OK**.

The Alarm Log Settings dialog box closes.

This concludes configuring the device addresses to monitor and the alarm detection condition.

Next, configure the functions to execute using saved data and detected alarms.

☞ "4.1 Displaying Saved Data with the Alarm Log Display" on page 13-31

☞ "4.2 Displaying Registered Messages with the Alarm List Display According to the Active Alarm" on page 13-33

☞ "4.3 Make a Sound of the Buzzer and Flash the Screen when an Alarm has Occurred" on page 13-36

☞ "4.4 Saving the Data as a CSV File" on page 13-38



To use the Alarm Log settings configured on the project on another project, save it as a file, and then import it to a project. Right-click the **Alarm Log Settings** on the **Project** window to export or import the file.

3 Alarm Log Settings Dialog Box

HG2J-7U HG5G-V HG4G-V HG4G HG3G-V HG3G HG2G-V HG2G-5F HG2G-5T HG1G HG1P

This section describes items and buttons on the Alarm Log Settings dialog box.

3.1 Alarm Log Settings Dialog Box

● General Tab

The **General** tab is used to configure what kind of data to sample when an alarm occurs and the methods for saving and deleting the sampled data.

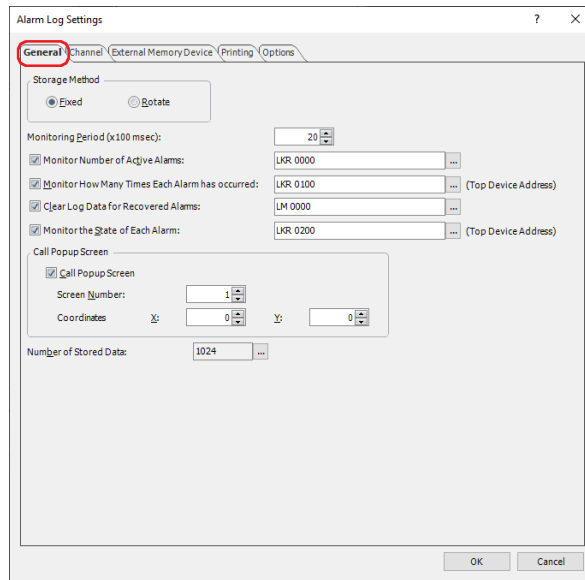

■ Storage Method

Selects the data processing method when the number of active alarms exceeds the Alarm Log data storage amount set for the data storage area.

Fixed: If the saved data exceeds the Alarm Log data storage amount, the new data is not saved.

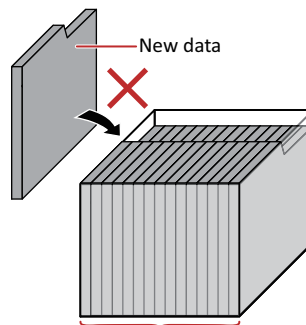

Alarm Log data storage amount

Rotate: If the saved data exceeds the Alarm Log data storage amount, the oldest data is deleted and the new data is saved.

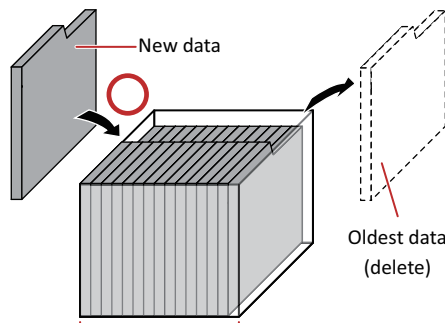

Alarm Log data storage amount

■ Monitoring Period (x 100 msec)

Specifies the period to write the state of the monitored device address to the MICRO/I (6 to 500 (100 ms units)).

■ Monitor Number of Active Alarms

Select this check box to count the number of active alarms.

(Destination Device Address): Specifies a word device to write the number of active alarms.

For the device address configuration procedure, refer to Chapter 2 "5.1 Device Address Settings" on page 2-70.

■ Monitor How Many Times Each Alarm has occurred

Select this check box to count the number of alarms that has occurred per channel.

(Top Device Address): Specifies a word device to write the number of alarms that has occurred. Number of blocks x 16 (number of channels) address numbers are used starting from the set device address. For the device address configuration procedure, refer to Chapter 2 "5.1 Device Address Settings" on page 2-70.

Example: When the number of blocks is 2 and LKR100 is specified as the start device address

The number of alarms that has occurred for channel number 1-0 is saved in LKR100. The number of alarms that has occurred for channel 1-1 is saved in LKR101, and this pattern continues up to LKR131 where the number of alarms that has occurred for channel number 2-15 is saved.

		Channel No.	
Block 1 16 channels	}	1-0	LKR100 ← Top Device Address
		1-1	LKR101
		1-2	LKR102
		⋮	⋮
		1-14	LKR114
		1-15	LKR115
Block 2 16 channels	}	2-0	LKR116
		2-1	LKR117
		2-2	LKR118
		⋮	⋮
		2-14	LKR130
		2-15	LKR131



- If you specify HMI Keep Registers (LKR) as the destination word device, the number of alarms that has occurred is retained even when the MICRO/I power is turned off.
- The amount of Alarm Log data saved in the data storage area with the Alarm Log function is stored in HMI Special Data Register LSD57.



- To monitor the number of alarms that has occurred, number of blocks x 16 (number of channels) device addresses are required from the set start device address. If the destination device address does not exist, "Device range error" occurs on the MICRO/I.
- If the values of the device addresses that are counting the number of alarms that has occurred are overwritten by another process, the alarms cannot be accurately counted.

■ Clear Log Data for Recovered Alarms

Select this check box to delete recovered data out of the saved Alarm Log data.

(Trigger Device Address): Specifies the bit device or the bit number of the word device to serve as condition to delete data. The recovered data is deleted when the value of the configured device address changes from 0 to 1. For the device address configuration procedure, refer to Chapter 2 "5.1 Device Address Settings" on page 2-70.

■ Monitor the State of Each Alarm

Select this check box to check the alarm state per channel.

(Top Device Address): Specifies a word device to write the alarm state. Number of blocks x 16 (number of channels) address numbers are used starting from the set device address.

For the device address configuration procedure, refer to Chapter 2 "5.1 Device Address Settings" on page 2-70.

The following values are written to the bits depending on the alarm state.

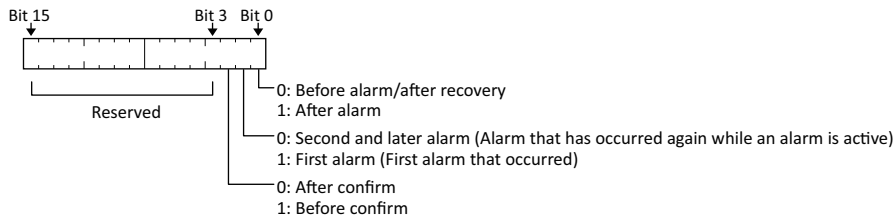

■ Call Popup Screen

These settings configure the popup screen to display when an alarm occurs. The popup screen displayed when an alarm occurs is called the alarm screen.

Call Popup Screen: Select this check box to display the alarm screen when an alarm occurs.

Screen Number: Specifies the alarm screen number (1 to 3015) to display when an alarm occurs.

Coordinates X, Y: Specifies the coordinates to display the alarm screen. With the upper-left corner of the screen as the origin, the upper-left corner of the alarm screen is the X and Y coordinates.

The units and range for the display coordinates is as follows.

Specify the coordinates in 1 dot units.

X: 0 to (base screen horizontal size - 1)

Y: 0 to (base screen vertical size - 1)

■ Number of Stored Data

Specifies the maximum amount of Alarm Log data saved in the data storage area. Data is saved up to the set amount. The maximum amount of data that can be saved in the data storage area is as follows.

HG5G/4G/3G/2G-V, HG4G/3G, HG2G-5F: 11,660

HG2J-7U, HG2G-5T, HG1G/1P: 5,520

Click to open the Data Storage Area Management dialog box. You can change the allocation of data storage area memory in the Data Storage Area Management dialog box. For details, refer to Chapter 16 "Data Storage Area" on page 16-1.

● Channel Tab

The **Channel** tab is used to configure the device addresses to monitor and the alarm detection condition.

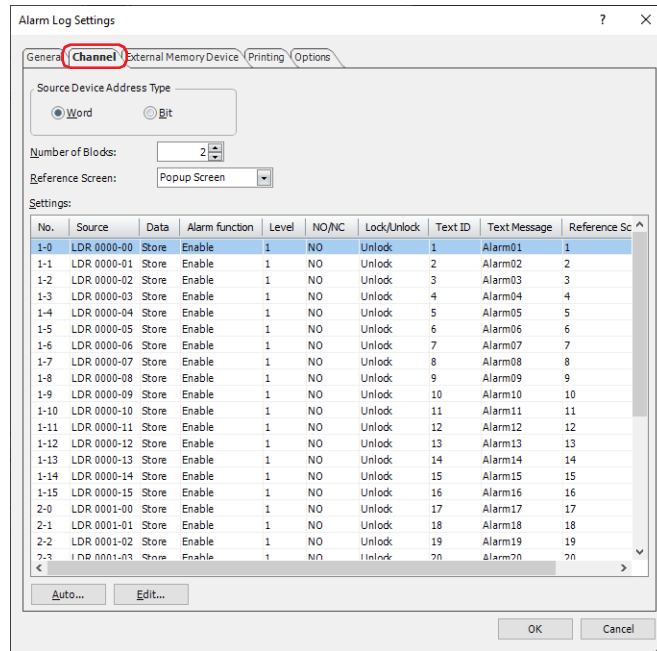

■ Source Device Address Type

Selects the type of device address to monitor.

Word: Uses a word device. Device Addresses are configured per block.

Bit: Uses a bit device. Device Addresses are configured per channel.

■ Number of Blocks

Configures the Alarm Log data in block units. The number of blocks that can be set varies based on the **Source Device Address Type** setting.

Word: 0 to 128

Bit: 0 to 8



1 block is composed of 16 channels. 1 device address can be monitored for each channel. The maximum number of device addresses that can be monitored is 16 for each block.

■ Reference Screen

Select the type of reference screen from the following items.

Base Screen, Popup Screen, Not Use

The reference screen is displayed when a message is selected on the Alarm List Display or the Alarm Log Display and the key button **Ref.** is pressed. It is the base screen or popup screen associated with each channel.

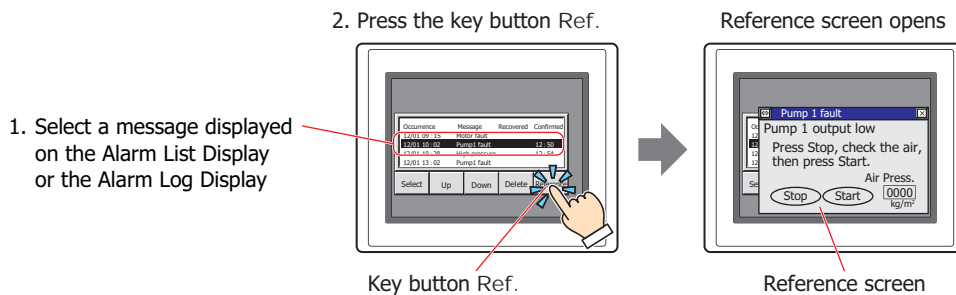

■ Settings

The Alarm Log settings for each channel are edited here.

No.:	Displayed as (Block No.)-(Channel No.). Double clicking the cell opens the Individual Settings dialog box.
Source:	Shows the bit device or the bit number of the word device to monitor. Double clicking the cell opens the Tag Editor. For the device address configuration procedure, refer to Chapter 2 "5.1 Device Address Settings" on page 2-70.
Data:	Shows whether or not to save Alarm Log data in the date storage area. Double clicking the cell switches between Store and No Store . Setting to Store makes the buzzer sound when the value of bit for the channel changes to 1.
Alarm function:	Shows whether or not the alarm function is used. Double clicking the cell switches between Enable and Disable . Channels switched to Disable cannot be configured. States of device addresses are not monitored and Alarm Log data is not created.
Level:	Displays the alarm level. Double clicking the cell allows you to change the level (1 to 8).
NO/NC:	Shows the alarm detection condition. Double clicking the cell switches between NO and NC .
Lock/Unlock:	Shows whether or not to automatically recover based on the state of the monitored bit. Double clicking the cell switches between Lock and Unlock .
Text ID:	Shows the Text Manager ID number to use for the message displayed when an alarm occurs. Double clicking the cell allows you to change the Text Manager ID number (1 to 32,000).
Text Manager:	Shows the text for the specified text ID. Double clicking the cell opens the Text Manager. Double clicking the cell allows you to specify the Text Manager ID number.
Reference Screen No.:	Shows the screen number to display when the key button Ref. is pressed. Double clicking the cell opens the Individual Settings dialog box. This option can only be configured when Base Screen or Popup Screen is selected in Reference Screen .

■ Auto

Batch registers or changes the settings for all the channels.

Click this button to open the Auto-Setup dialog box. The Auto-Setup dialog box settings are reflected in all the channels.

For details, refer to "Auto-Setup Dialog Box and Individual Settings Dialog Box" on page 13-18.

■ Edit

Registers or changes the settings for the selected channel.

Select a channel and click this button to open the Individual Settings dialog box. The settings for the selected channel are reflected in the Individual Settings dialog box.

For details, refer to "Auto-Setup Dialog Box and Individual Settings Dialog Box" on page 13-18.

Auto-Setup Dialog Box and Individual Settings Dialog Box

With the Auto-Setup dialog box, the Alarm Log settings for all channels are batch registered or changed.

With the Individual Settings dialog box, the Alarm Log settings for the selected channel are registered or changed.

■ Channel*1

Shows the block number and the channel number for the selected channel.

Block Number: Shows the block number for the channel selected in **Settings**.

Channel Number: Shows the channel number for the channel selected in **Settings**.

■ Block Settings

Configures **Source** and **Data** in block units.

Source: For the Auto-Setup dialog box, the device addresses are sequentially set from block number 1-channel number 1, starting with the specified device address.

For the Individual Settings dialog box, if **Source Device Address Type** on the **Channel** tab is **Word**, the 16 channels for the block selected at the start of the specified device address are batch configured. For **Bit**, the selected channel is individually configured.

Click to open the Tag Editor where you can edit the device address. For the device address configuration procedure, refer to Chapter 2 "5.1 Device Address Settings" on page 2-70.

Data: Selects whether or not to save Alarm Log data in the date storage area.

For the Auto-Setup dialog box, all the channels are batch configured.

For the Individual Settings dialog box, the 16 channels for the selected block are batch configured.

Store: Alarm Log data can be displayed on the MICRO/I or output to file.

No Store: Alarm Log data is not created, but states of device addresses are monitored.

*1 Individual Settings dialog box only

■ Channel Settings

The trigger condition for the channel is configured here.

- Alarm function: Selects whether or not to use the alarm function.
- Enable: Monitors the state of the device address configured for the channel and samples the alarm information.
- Disable: Does not monitor the state of the device address. No Alarm Log data is created.
- Level: Specifies the level (1 to 8) of the alarm.
Displays the alarm level. Double clicking the cell allows you to change the level (1 to 8).
- NO/NC: Selects the alarm detection condition.
- NO: The alarm occurs when the monitored bit changes from 0 to 1.
- NC: The alarm occurs when the monitored bit changes from 1 to 0.
- Lock/Unlock: Selects whether or not to automatically recover based on the state of the monitored bit.
- Lock: Even if the monitored bit returns the normal state, the alarm remains active until the key button **CHECK** is pressed.
- Unlock: The alarm is automatically recovered from based on the bit state when the monitored bit returns the normal state.

Example: **NO/NC** is **NO**

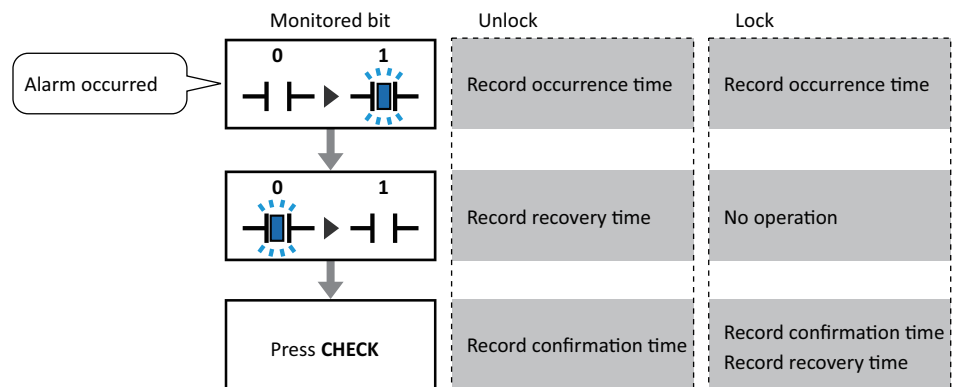

The display on the Alarm List Display disappears when the alarm is recovered from, regardless of the **Lock/Unlock** setting. To keep displaying the alarm until **CHECK** is pressed, use the Alarm Log Display.

- Text ID: To use text registered in Text Manager as the message to display when an alarm occurs, select this check box and specify the Text Manager ID number to use as the message. Number of blocks x 16 (number of channels) text IDs are used starting from the set ID number.
Click to open Text Manager where you can edit the text.
- Text: Shows the text for the specified text ID.
- Reference Screen Number: Specifies the screen number (1 to 3000) to display when the key button **Ref.** is pressed. Number of blocks x 16 (number of channels) screens are used starting from the screen number.
This option can only be configured when **Base Screen** or **Popup Screen** is selected in **Reference Screen**.

● External Memory Device Tab

The **External Memory Device** tab is used to configure whether or not to output saved data to the external memory device^{*1}.

The output data is stored in the "ALARMLOG" folder of the External Memory Device folder.

The default External Memory Device folder name is "HGDATA01". For details, refer to Chapter 31 "1.4 File structure" on page 31-3 and Chapter 31 "1.6 Setting the External Memory Device Folder" on page 31-12.



Sampled data after starting output to the external memory device is not included in the output data.

*1 USB flash drive inserted in USB1 for HG2J-7U, SD memory card for HG5G/4G/3G/2G-V, HG4G/3G and HG2G-5F, USB flash drive for HG2G-5T and HG1G/1P

■ Batch

Select this check box to batch output all the sampled data to the external memory device*¹.

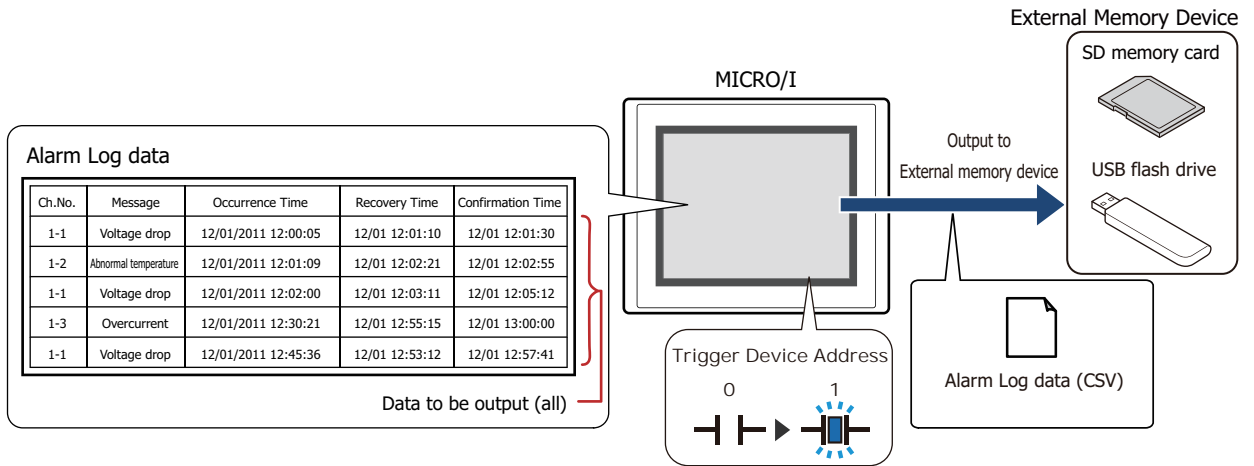

All the data is saved on the external memory device*¹ when the value of the Trigger Device Address changes from 0 to 1. If a file with the same name already exists on the external memory device*¹, that file is overwritten. The maximum amount of output data is the amount configured by the data storage area.



The storing of data stops if there is insufficient free space on the external memory device. The error information is stored in the following HMI Special Data Registers. For details about the error information, refer to Chapter 33 "HMI Special Data Register (LSD)" on page 33-8.

HG2J-7U, HG5G/4G/3G/2G-V, HG4G/3G, HG2G-5F: LSD42
 HG2G-5T, HG1G/1P: LSD33

Trigger Device Address: Specifies the bit device or the bit number of the word device to serve as condition for batch output. For the device address configuration procedure, refer to Chapter 2 "5.1 Device Address Settings" on page 2-70.

Data is output to file when the value of the Trigger Device Address changes from 0 to 1.

File Name: Enter the file name for the output data or shows the file name.

The default is "ALMHTO.CSV". To change the file name, enter a new file name. The maximum number is 120 characters (including the extension).

Specify File Name by Value of Device Address: Select this check box to assign a file name for the output data using a value of device address specified in the File Name Device Address.

(File Name Device Address): Specifies a word device to create a file name. The file name is set by reading the values sequentially from the starting device specified with the File Name Device Address and handling those values as character data up to the character before NULL (00). The maximum number of device addresses is 40 (2 characters per word device, maximum of 80 single-byte characters). You can only specify an internal device. For the device address configuration procedure, refer to Chapter 2 "5.1 Device Address Settings" on page 2-70.

Example: When the device address specified by (File Name Device Address) is LDR100 and the text to set is "IDEC":

(File Name Device Address)	LDR100	←	'I'	'D'	4944(Hex)
	LDR101	←	'E'	'C'	4543(Hex)
	LDR102	←	[NULL]		0000(Hex)

The file name at this time becomes "IDEC.CSV".

*1 USB flash drive inserted in USB1 for HG2J-7U, SD memory card for HG5G/4G/3G/2G-V, HG4G/3G and HG2G-5F, USB flash drive for HG2G-5T and HG1G/1P

Add Device Address data to File Name: Select this check box to add the bottom three digits of the value of the device address configured by (File Name Device Address) to the end of the file name for the output data.

(File Name Device Address): Specifies the word device that is the source for the value to add to the file name. For the device address configuration procedure, refer to Chapter 2 "5.1 Device Address Settings" on page 2-70. This option can only be configured when the **Add Device Address data to File Name** check box is selected.

Example: When **File Name** is "ALMHTO01" and the value of device address in (File Name Device Address) is 123, the file name is "ALMHTO01123.CSV".

Add Time Stamp: Select from the following format for date and time to be added to the file name when data is output:

**None, YY, YY+MM, YY+MM+DD, YY+MM+DD+HH,
YY+MM+DD+HH+MM, YY+MM+DD+HH+MM+SS**

The format is YYMMDD_hhmmss (YY: year, MM: month, DD: day, hh: hour, mm: minute, ss: second).

Example: **File Name** is "ALMHTO01" on September 15 2013 at 23:30:50

YY:	ALMHTO01_13
YY+MM:	ALMHTO01_1309
YY+MM+DD:	ALMHTO01_130915
YY+MM+DD+HH:	ALMHTO01_130915_23
YY+MM+DD+HH+MM:	ALMHTO01_130915_2330
YY+MM+DD+HH+MM+SS:	ALMHTO01_130915_233050

Set limit on files: Specifies the upper limit (1 to 100) when limiting the number of files to be output.

Output Alarm Level: Select this check box to output the level settings.



When the **Set limit on files** check box is selected, note the following points.

- If the number of data files saved on the external memory device increases, it may take some time for the data output processing, or the output of the next data may not be processed normally.
- When displaying pictures saved on the external memory device and processing the output of data both occur simultaneously, the pictures may not be displayed.
- When parts that blink overlap pictures saved to the external memory device, the blinking period may slow down when data output processing occurs.



The following single-byte characters cannot be used in the file name configured by **File Name** or **Specify File Name by Value of Device Address**.

" * / : ; < > ? \ |

- File names that exceed the limits in **Specify File Name by Value of Device Address** and file names configured with characters that cannot be used are as follows.
 - When the text of the file name exceeds the maximum number of device addresses (no NULL), the text stored in device addresses up to the maximum number of device addresses from the start is configured.
 - When a character that cannot be used is set, the text is up to that character.
 - When the first character is a character that cannot be used, the text is that set for **File Name**.
- The operation when the **Set limit on files** check box is selected is as follows.
 - The files are output up to the set limit, and then for additional files, the new files are saved by discarding the old files in order of the oldest first.
 - If the number of files saved on the external memory device already exceeds the limit when operation starts, the number of files at that time is the limit. From there the data is discarded in order from the oldest data and replaced with new data with each file output.

■ Real Time

Select this check box to output data to the external memory device^{*1} in real time.

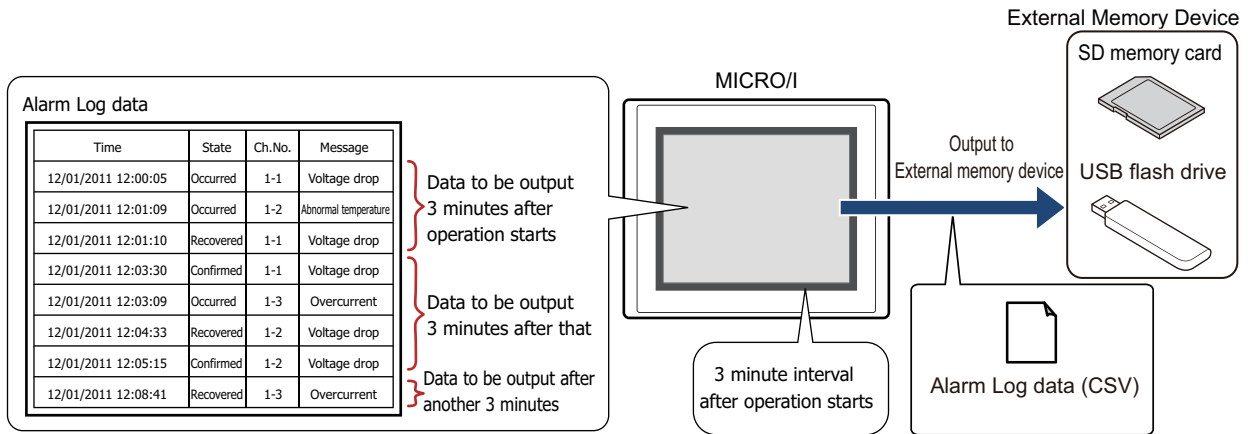

With real time output, data is saved to the external memory device^{*1} in three minute intervals after the MICRO/I starts running. If the accumulated data reaches 819th item, then the data is forcibly saved to the external memory device^{*1}. When there is already data with the same file name on the external memory device^{*1}, data is appended to that file. If there was no update to the data during the three minutes, it is not output.

Data is appended to the file until the size of the file reaches the restriction size (256 MB), so the maximum amount of output data varies based on the settings for the output channel such as the amount of data, the data size, and the labels.

If the interval to update the Alarm Log is shorter than real time output (the interval for writing to the external memory device), that Alarm Log is recorded up to the 1023rd item, and then afterwards, old data is discarded in order and replaced with new data.



Real time output stops when the file size of the Alarm Log data exceeds 256 MB or when there is insufficient space on the external memory device. The error information is stored in the following HMI Special Data Registers. For details about the error information, refer to Chapter 33 "HMI Special Data Register (LSD)" on page 33-8.

HG2J-7U, HG5G/4G/3G/2G-V, HG4G/3G, HG2G-5F: LSD42
 HG2G-5T, HG1G/1P: LSD33



- When the value of the following HMI Special Internal Relays changes from 0 to 1, the data at that time is first output in real time to the external memory device, and then access to the external memory device is stopped. For details, refer to Chapter 33 "HMI Special Relay (LSM)" on page 33-2.

HG2J-7U, HG5G/4G/3G/2G-V, HG4G/3G, HG2G-5F: LSD20
 HG2G-5T, HG1G/1P: LSD18

- The amount of free space on the external memory device is saved to the following HMI Special Data Registers. For details about the free space on the External Memory Devices, refer to Chapter 33 "HMI Special Data Register (LSD)" on page 33-8.

HG2J-7U, HG5G/4G/3G/2G-V, HG4G/3G, HG2G-5F: LSD43, 44
 HG2G-5T, HG1G/1P: LSD34, 35

Trigger Condition: Select the check boxes for the items that will trigger the output of Alarm Log data to the external memory device.

Occurrence: Alarm Log data is output to the external memory device when an alarm has occurred.

Recovery: Alarm Log data is output to the external memory device when the alarm is recovered from.

Confirmation: Alarm Log data is output to the external memory device when the key button **CHECK** was pressed.



Month/day/year hour:minute:second is output for the trigger condition occurrence time, recovery time, and confirmation time.

*1 USB flash drive inserted in USB1 for HG2J-7U, SD memory card for HG5G/4G/3G/2G-V, HG4G/3G and HG2G-5F, USB flash drive for HG2G-5T and HG1G/1P

File Name: Enter the file name for the output data or shows the file name.
The default is "ALMHTA.CSV". To change the file name, enter a new file name. The maximum number is 120 characters (including the extension).

Specify File Name by Value of Device Address:

Select this check box to specify the name of the file for the output data with the value of the device address configured by (File Name Device Address).

(File Name Device Address): Specifies the word device that is the source of the data to use as the file name. The file name is set by reading the values sequentially from the starting device address specified with the File Name Device Address and handling those values as character data up to the character before NULL (00).

The maximum number of device addresses is 40 (80 single-byte characters). You can only specify an internal device. For the device address configuration procedure, refer to Chapter 2 "5.1 Device Address Settings" on page 2-70.

Example: When the device address specified by (File Name Device Address) is LDR100 and the text to set is "IDEC":

(File Name Device Address)	LDR100	←	' I ' ' D '	4944(Hex)
	LDR101	←	' E ' ' C '	4543(Hex)
	LDR102	←	(NULL)	0000(Hex)

The file name at this time becomes "IDEC.CSV".

Add Device Address data to File Name:

Select this check box to add the bottom three digits of the value of the device address configured by (File Name Device Address) to the end of the file name for the output data.

(File Name Device Address): Specifies the word device that is the source for the value to add to the file name. For the device address configuration procedure, refer to Chapter 2 "5.1 Device Address Settings" on page 2-70. This option can only be configured when the **Add Device Address data to File Name** check box is selected.

Example: **File Name** is "ALMHTA" and the value of the device address configured by (File Name Device Address) is 123, the file name is "ALMHTA123.CSV".

Add Time Stamp: Selects the format of the output date and time to add to the file name for the output data.

None, YY, YY+MM, YY+MM+DD

The format is YYMMDD (YY: year, MM: month, DD: day).

Example: **File Name** is "ALMHTA" on September 15 2013

YY:	ALMHTA_13
YY+MM:	ALMHTA_1309
YY+MM+DD:	ALMHTA_130915

Realtime Output: Select this check box to forcibly output the data and save it to file at the desired timing.

(Trigger Device Address): Specifies the bit device or the bit number of the word device to serve as the condition to forcibly output the data. You can only specify an internal device. For the device address configuration procedure, refer to Chapter 2 "5.1 Device Address Settings" on page 2-70.
Data is output to file when the value of Trigger Device Address changes from 0 to 1.

Set limit on files: Specifies the upper limit (1 to 100) when limiting the number of files to be output.

Output Alarm Level: Select this check box to output the level settings.



When the **Set limit on files** check box is selected, note the following points.

- If the number of data files saved on the external memory device increases, it may take some time for the data output processing, or the output of the next data may not be processed normally.
- When displaying pictures saved on the external memory device and processing the output of data both occur simultaneously, the pictures may not be displayed.
- When parts that blink overlap pictures saved to the external memory device, the blinking period may slow down when data output processing occurs.



The following single-byte characters cannot be used in the file name configured by **File Name** or **Specify File Name by Value of Device Address**.

" * / : ; < > ? \ |

- File names that exceed the limits in **Specify File Name by Value of Device Address** and file names configured with characters that cannot be used are as follows.
 - When the text of the file name exceeds the maximum number of device addresses (no NULL), the text stored in device addresses up to the maximum number of device addresses from the start is configured.
 - When a character that cannot be used is set, the text is up to that character.
 - When the first character is a character that cannot be used, the text is that set for **File Name**.
- The operation when the **Set limit on files** check box is selected is as follows.
 - The files are output up to the set limit, and then for additional files, the new files are saved by discarding the old files in order of the oldest first.
 - If the number of files saved on the external memory device already exceeds the limit when operation starts, the number of files at that time is the limit. From there the data is discarded in order from the oldest data and replaced with new data with each file output.
- The following operations are as follows if the **Realtime Output** check box is selected.
 - Even if the data is outputted forcibly, the real time output period (3 minute interval) is not reset.
 - While data is being output with the real time output function, the file is not output when the value of the **Realtime Output** device address is 1.
 - Even when output has finished, the value of device does not automatically change to 0.



- The function to sample data operates when Alarm Log data is being saved to the external memory device.
- The batch output or real time output status of the Alarm Log data can be checked with the value of HMI Special Internal Relay LSM36. When the data starts to be written to the external memory device, the value of device address is 1. When writing is complete, the value is 0.
- The methods to erase Alarm Log files saved on the external memory device are as follows.
 - To erase files during operation using parts, on the **External Memory Device** tab on the Project Settings dialog box, select the **Remove Files** check box and the **All Alarm Log data** check box, and then configure the trigger device address. Assign that trigger device address to a part.
 - To erase files with WindO/I-NV4, click **Clear** on the **Online** tab, and then click **Stored Data in External Memory Device** to open the **Clear Data** dialog box. Select the **Alarm Log Data** check box and click **OK**.
 - To erase files on the HG5G/4G/3G/2G-V, HG4G/3G and the HG2G-5F, go to the System Mode - File Manager. In the File Manager, select the files to be deleted by pressing **DEL**.

Output Data File Name

The file name format is as follows.

File Name Value of Device Address_YYMMDD_hhmmss.CSV

- File Name: The text entered in **File Name** or the text entered according to the value of the device address set by **Specify File Name by Value of Device Address**
- Value of Device Address: The lower 3 digits of the value of the device address configured by **Add Device Address data to File Name**
- YYMMDD: The year, month, and day of the month set on **Add Time Stamp**
- hhmmss: The hour, minute, and second of the time configured on **Add Time Stamp**

■ **Example 1**

Item	Setting	
File Name	ALMHTO	
Add value of Device Address to File Name	(File Name Device Address) is LDR200	LDR200 value: 123
Add Time Stamp	YY+MM	Date when data was output: September 2013

Result: The file name is "ALMHTO123_1309.CSV".

■ **Example 2**

Item	Setting	
Specify File Name by Value of Device Address	(File Name Device Address) is LDR100 Text to set is "IDEC"	LDR100 value: 4944 (Hex) LDR101 value: 4543 (Hex) LDR102 value: 0000 (Hex)
Add value of Device Address to File Name	(File Name Device Address) is LDR200	LDR200 value: 123
Add Time Stamp	YY+MM+DD+HH+MM+SS	Date and time when data was output: September 15 2013 at 23:30:50

Result: The file name is "IDEC123_130915_233050.CSV".

● **Printing Tab**

HG2J-7U HG5G-V HG4G-V HG4G HG3G-V HG3G HG2G-V HG2G-5F HG2G-5T HG1G HG1P

The **Printing** tab is used to configure whether or not to output saved data to the printer.

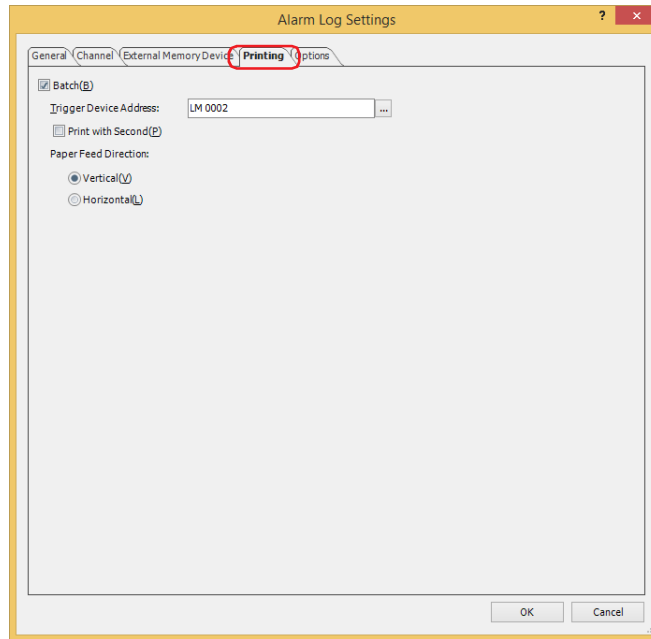

■ **Batch**

Select this check box to batch output all the sampled data to the printer.

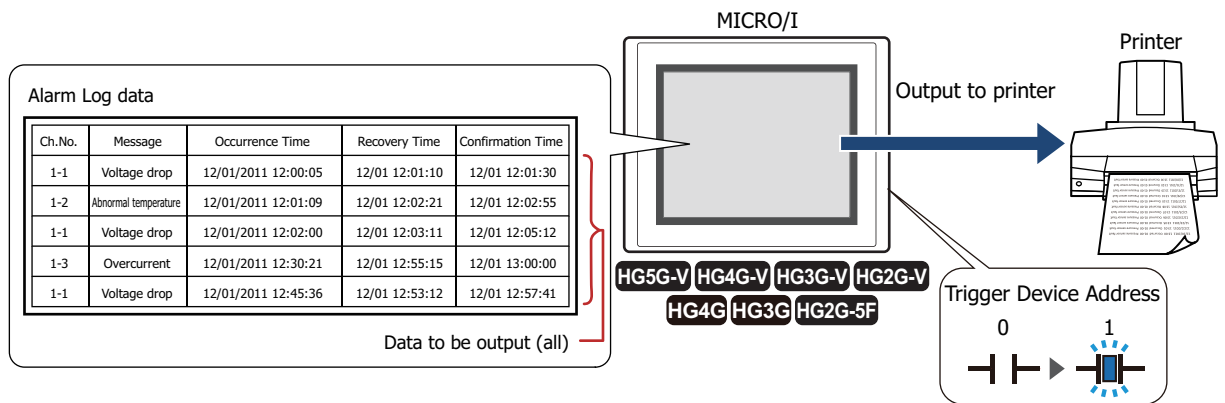

Printing of all the data starts when the value of the Trigger Device Address changes from 0 to 1. Alarm Log data that occurs after the start of printing is not printed.

Trigger Device Address: Specifies the bit device or the bit number of the word device to serve as condition to print. For the device address configuration procedure, refer to Chapter 2 "5.1 Device Address Settings" on page 2-70.

The data prints when the value of the Trigger Device Address changes from 0 to 1.

Batch output example (printing)

No.	Occurrence Time	Recovery Time	Confirmation Time	Message
01-00	12/31/11 12:00:00	12/31 12:20:20	12/31 12:30:45	Pressure sensor fault
01-01	12/31/11 12:10:15	12/31 14:00:40	12/31 14:30:50	Hydraulic pressure low
01-00	12/31/11 13:00:30	-	-	Pressure sensor fault
	⋮			

Print with Second: Select this check box to print the time including seconds.

Paper Feed Direction: Selects the paper feed direction as either **Vertical** or **Horizontal**.

Vertical:

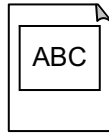

Horizontal:

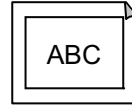

- For A4 size paper, up to 40 items of Alarm Log data are printed on a single sheet.
- The year is not printed for recovery times and confirmation times.



The function to sample data operates when Alarm Log data is printing.

● Options Tab

The **Options** tab is used to configure whether or not the MICRO/I's internal buzzer operates and the screen flashing.

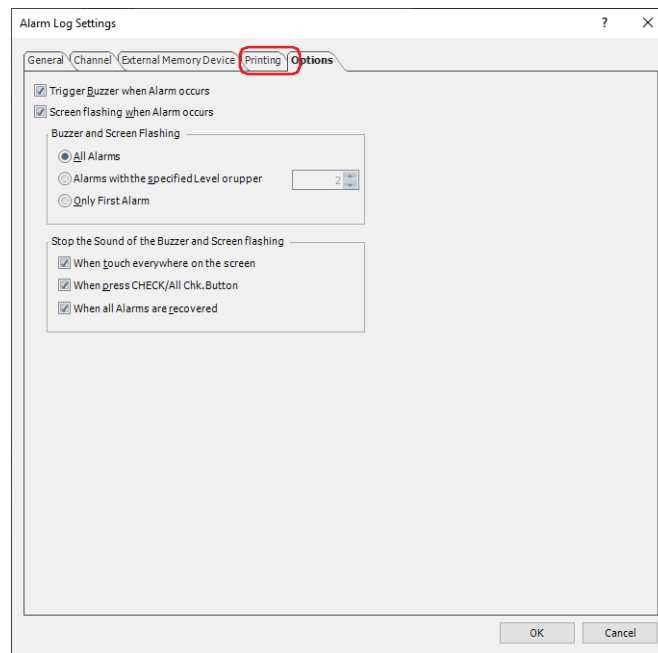

■ Trigger Buzzer when Alarm occurs

Select this check box to sound a beep when an alarm has occurred.

■ Screen flashing when Alarm occurs

Select this check box to have the screen flash when an alarm occurs.

■ Buzzer and Screen Flashing

This item selects the condition for the alarm to sound the buzzer or to flash the screen. This item can only be configured when the **Buzzer when Alarm occurs** or the **Screen flashing when Alarms occurs** is selected.

All Alarms:	The buzzer is triggered and the screen flashing each time an alarm occur.
Alarms with the specified Level or upper:	Specifies the level (2 to 8). Each time alarm with the specified level or upper sets off, the buzzer gets triggered and screen starts flashing.
Only First Alarm:	The buzzer is triggered and the screen flashing only when the first alarm ^{*1} occurs. No beeps will sound and no screen will flash when another alarm is already active.

■ Stop the Sound of the Buzzer and Screen flashing

Select the check box for the items that will trigger the sound of the buzzer and screen flashing to stop.

When touch everywhere on the screen:	The sound of the buzzer and screen flashing stops when you touch anywhere on the screen.
When press CHECK or All Chk. button:	The sound of the buzzer and screen flashing stops when you touch the key buttons CHECK or All Chk. on the Alarm Log Display.
When all Alarms are recovered:	The sound of the buzzer and screen flashing stops when all the alarms are recovered from.

*1 The first alarm that has occurred in a state where no alarms are active



- While the beep is sounding, System Area 1 (address number+1, bit 6) is 1.
 - While the screen is flashing, System Area 1 (address number+1, bit 2) is 1.
 - To stop the sound of the buzzer and the screen flashing when an alarm has occurred, use the following methods.
 - Press the key button **Stop the Sound of the Buzzer and Screen flashing**
 - When a condition selected with the **Stop the Sound of the Buzzer and Screen flashing** check boxes is satisfied
 - To stop the sound of the buzzer, set System Area 1 (address number+1, bit 6) to 0
 - To stop the screen flashing, set System Area 1 (address number+1, bit 1 to 4) to 0
- However, when System Area 1 (address number+1, bit 6) is 1 for a reason other than the occurrence of an alarm, the sound of the buzzer does not stop until 0 is written. When System Area 1 (address number+1, bit 1 to 4) are 1, the alarm is triggered, however, the screen flashing doesn't stop until 0 is written into it.
- If you stop the screen flashing, the backlight turns off when System Area 1 (address number+1, bit 0), and the backlight turns on when it is 1.
-

4 Using Data and Detected Alarms

HG2J-7U HG5G-V HG4G-V HG4G HG3G-V HG3G HG2G-V HG2G-5F HG2G-5T HG1G HG1P

4.1 Displaying Saved Data with the Alarm Log Display

1 On the **Configuration** tab, in the **System Setup** group, click **Alarm Log**.

The Alarm Log Settings dialog box is displayed.

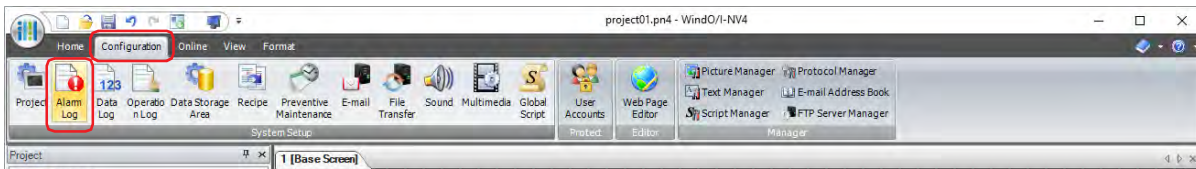

2 Select the type of device address to monitor under **Source Device Address Type** on the **Channel** tab and specify **Number of Blocks**.

3 Select the channel number to register and click **Edit**.

The Individual Settings dialog box is displayed.

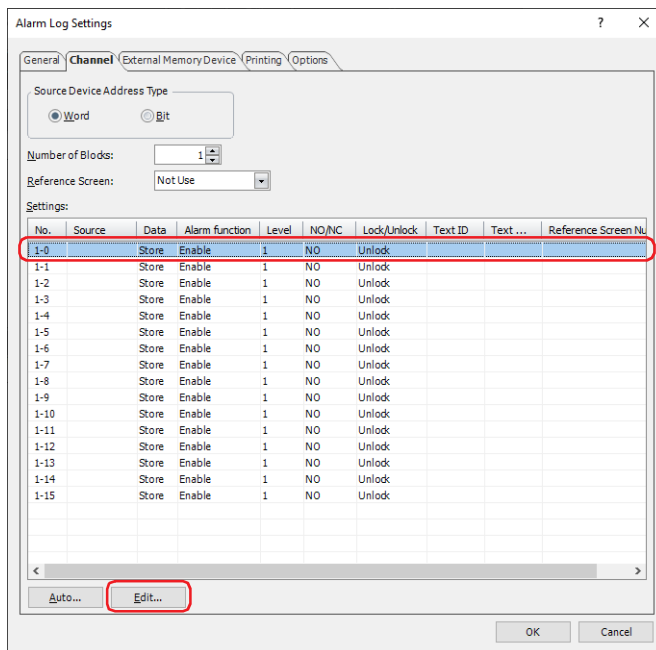

4 Specify the device address to monitor in **Source** and select **Store** under **Data**.

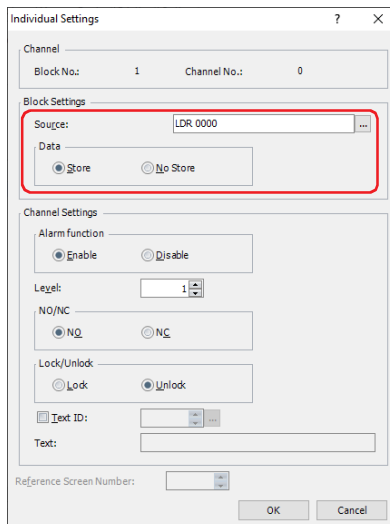

- 5 Select **Enable** under **Alarm function**, configure **Level**, **NO/NC** and **Lock/Unlock**, and click **OK**.
You are returned to the Alarm Log Settings dialog box.
- 6 Repeat steps 3 through 5 to register all the channels.
- 7 Click **OK**.
The Alarm Log Settings dialog box closes.
- 8 On the **Home** tab, in the **Parts** group, click **Data Displays**, and then click **Alarm Log Display**.

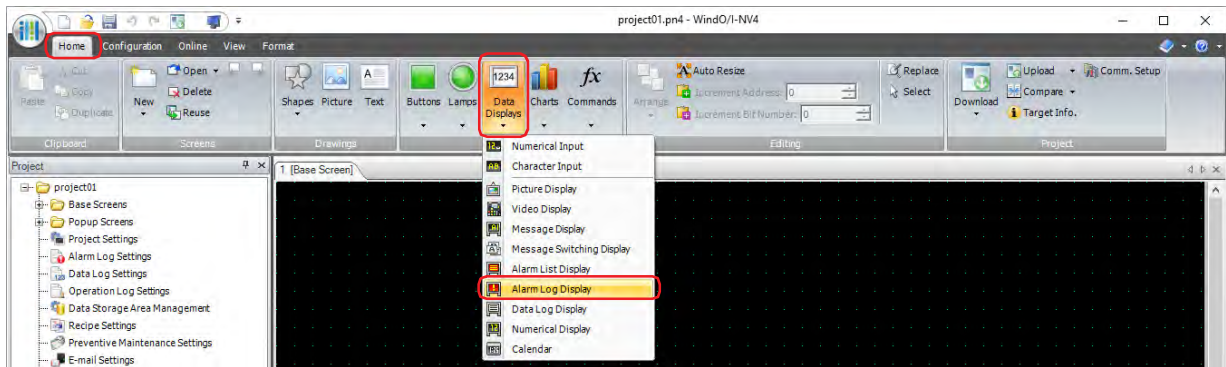

- 9 Click a point on the edit screen where you wish to place the Alarm Log Display.
- 10 Double-click the placed Alarm Log Display and a Properties dialog box will be displayed.

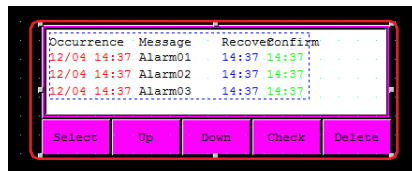

- 11 Change the settings on each tab as necessary.
For details, refer to Chapter 10 "8.3 Properties of Alarm Log Display Dialog Box" on page 10-155.

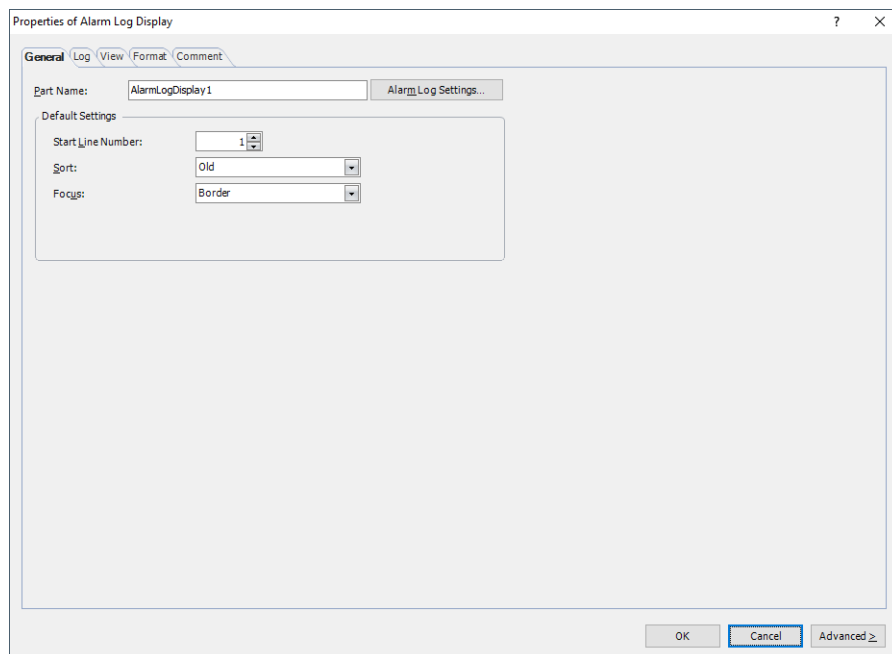

- 12 Click **OK**.
The Properties of Alarm Log Display dialog box closes.
This concludes configuring the MICRO/I to display saved data with the Alarm Log Display.

4.2 Displaying Registered Messages with the Alarm List Display According to the Active Alarm

- 1 On the **Configuration** tab, in the **System Setup** group, click **Alarm Log**.

The Alarm Log Settings dialog box is displayed.



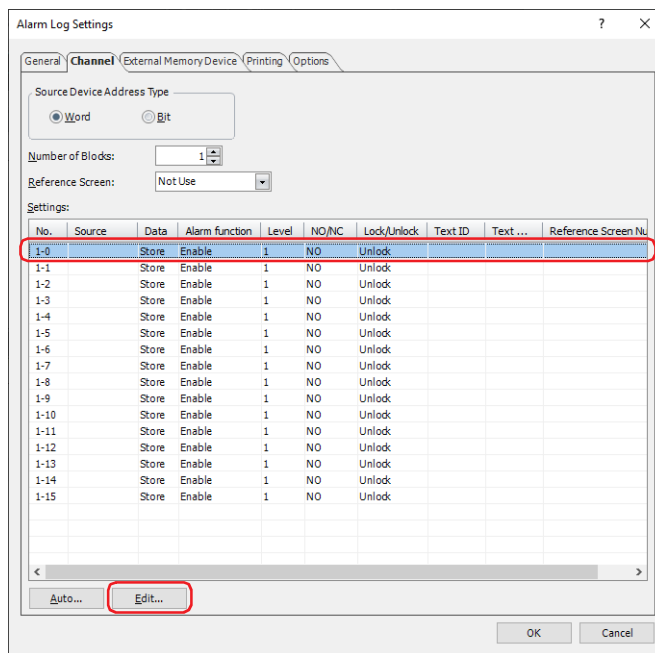

- 2 Select the type of device address to monitor under **Source Device Address Type** on the **Channel** tab and specify **Number of Blocks**.
- 3 Select the channel number to register a message to and click **Edit**.

The Individual Settings dialog box is displayed.

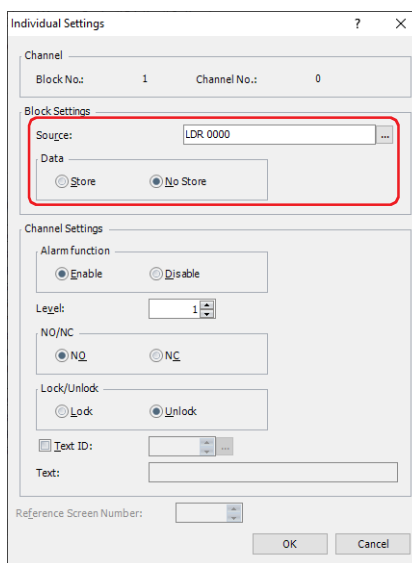

- 4 Specify the device address to monitor in **Source** and select **No Store** under **Data**.



- 5 Select **Enable** under **Alarm function** and configure **Level**, **NO/NC** and **Lock/Unlock**.
- 6 Select the **Text ID** check box and click .
Text Manager opens.
- 7 Double click the (Text) and enter the message.

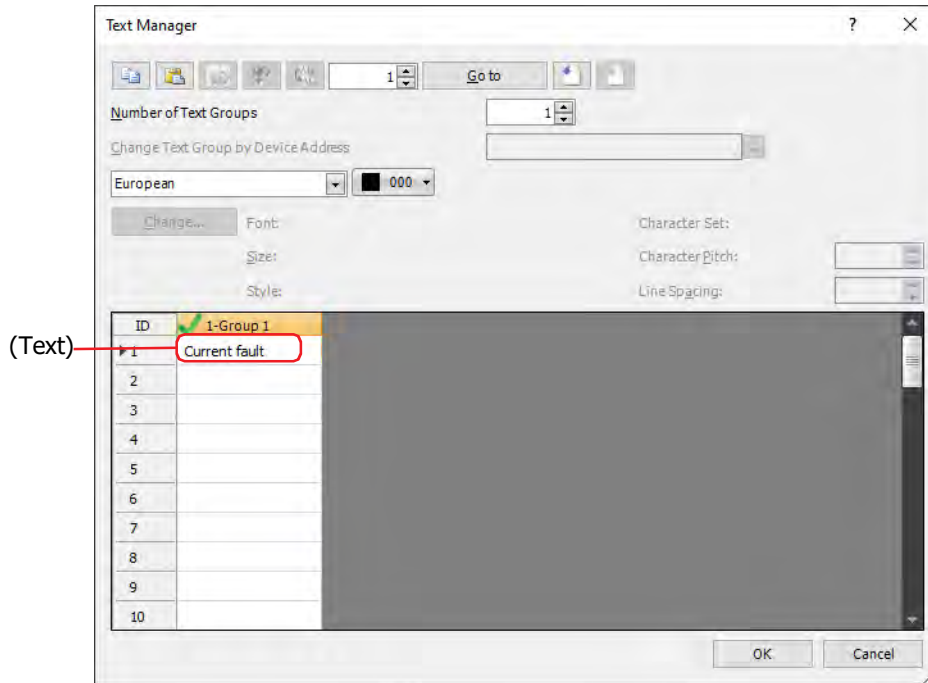

- 8 Click **OK**.
You are returned to the Individual Settings dialog box.
- 9 Click **OK**.
The registered message is displayed in **Settings**.

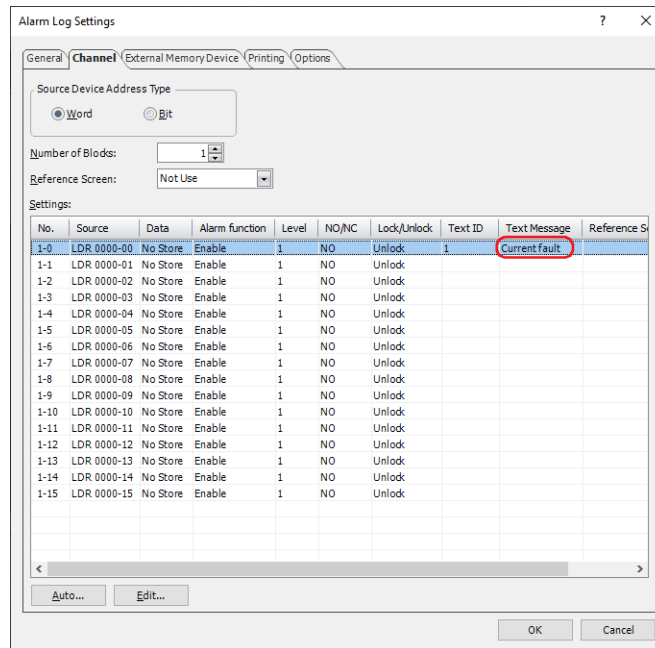

- 10 Repeat steps 3 through 9 to register messages for all the channels.



The messages to use can be registered in advance in Text Manager.

- 11 Click **OK**.

The Alarm Log Settings dialog box closes.

- 12 On the **Home** tab, in the **Parts** group, click **Data Displays**, and then click **Alarm List Display**.

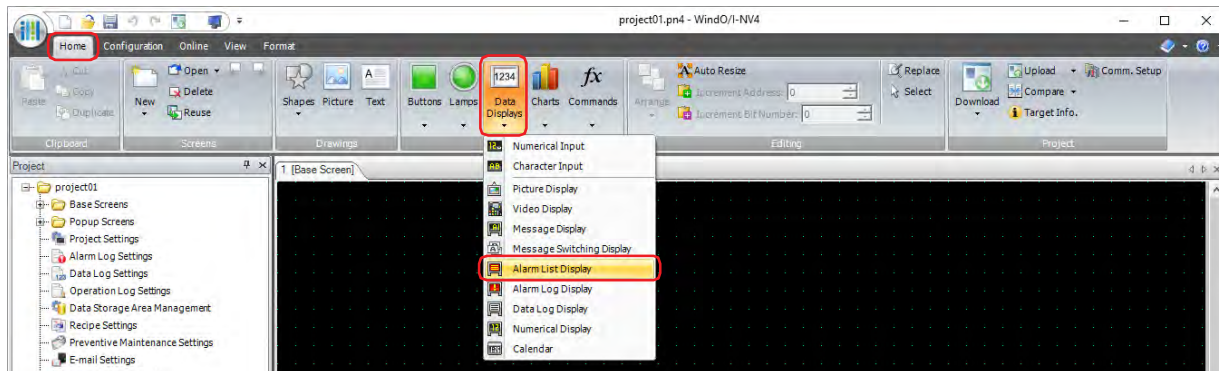

- 13 Click a point on the edit screen where you wish to place the Alarm List Display.

- 14 Double-click the placed Alarm List Display and a Properties dialog box will be displayed.

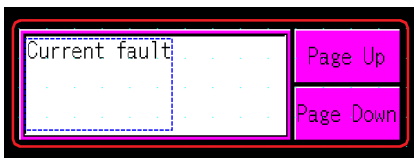

- 15 On the **General** tab, under **Message Settings**, select **Use Alarm Log Settings**.

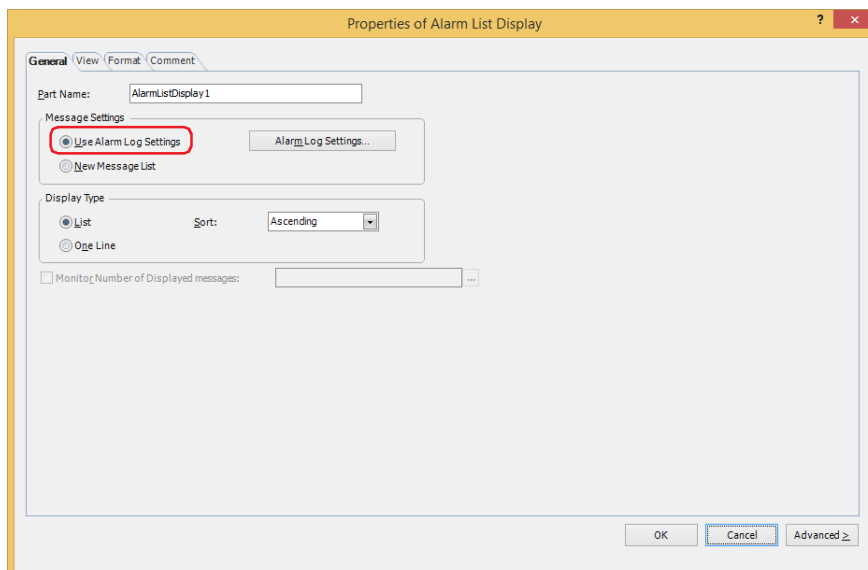

- 16 Configure the other settings and the settings on each tab as necessary.

For details, refer to Chapter 10 "7.3 Properties of Alarm List Display Dialog Box" on page 10-138.

- 17 Click **OK**.

The Properties of Alarm List Display dialog box closes.

This concludes configuring the MICRO/I to display registered messages with the Alarm List Display according to the active alarm.

4.3 Make a Sound of the Buzzer and Flash the Screen when an Alarm has Occurred

- 1 On the **Configuration** tab, in the **System Setup** group, click **Alarm Log**.

The Alarm Log Settings dialog box is displayed.

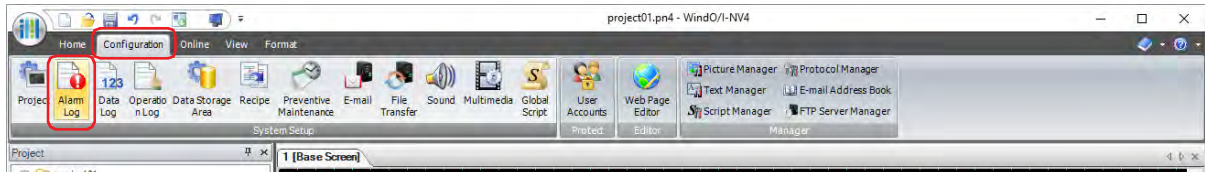

- 2 Select the type of device address to monitor under **Source Device Address Type** on the **Channel** tab and specify **Number of Blocks**.
- 3 Select the channel number to register a message to and click **Edit**.

The Individual Settings dialog box is displayed.

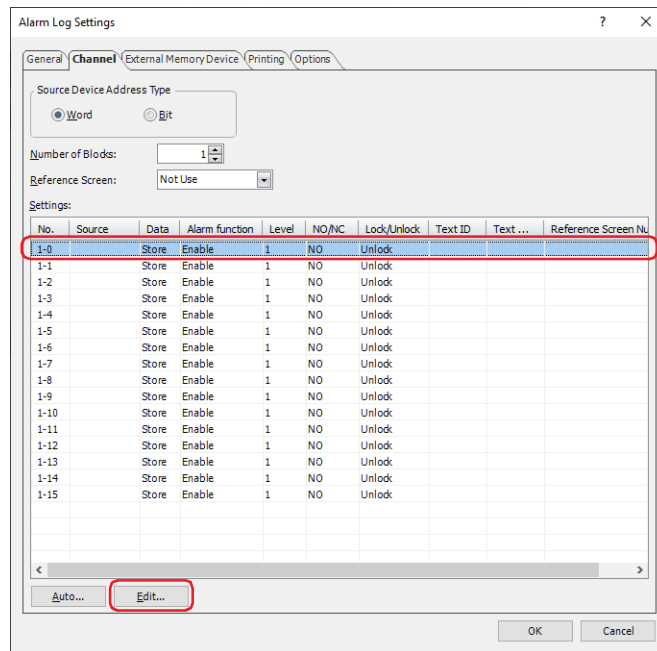

- 4 Specify the device address to monitor in **Source** and select **Store** under **Data**.

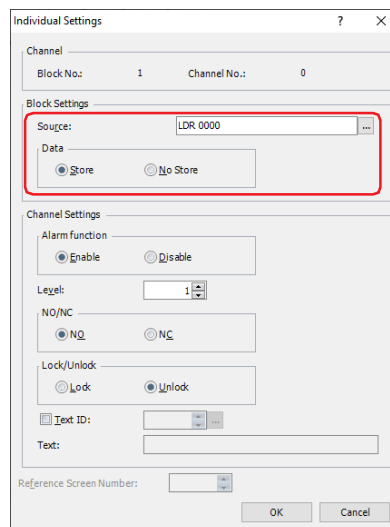

- 5 Select **Enable** under **Alarm function**, configure **Level**, **NO/NC** and **Lock/Unlock**, and click **OK**.
You are returned to the Alarm Log Settings dialog box.

- 6 Click the **Options** tab in the Alarm Log Settings dialog box.

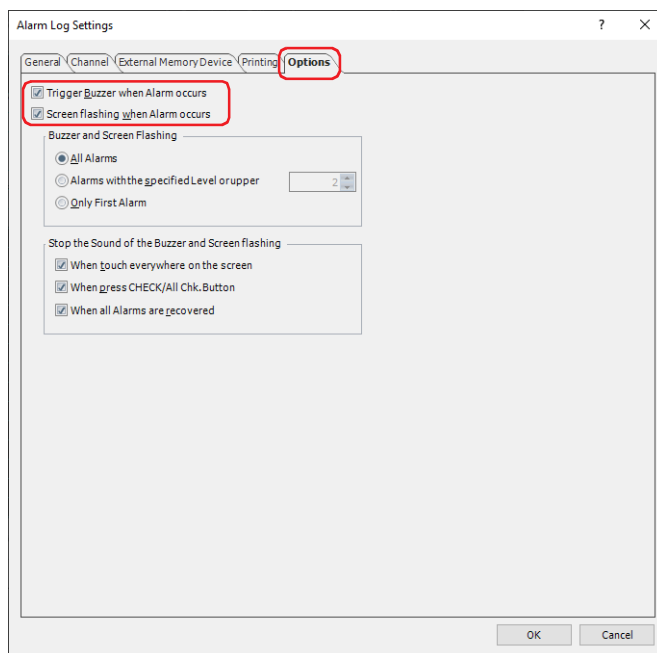

- 7 Select the **Trigger Buzzer when Alarm occurs** check box to make a sound of the buzzer when an alarm has occurred.
- 8 Select the **Screen flashing when Alarm occurs** check box to have the screen flashing when an alarm has occurred.
- 9 Click **OK**.

The Alarm Log Settings dialog box closes.

This concludes configuring the settings to make a sound of the buzzer and the screen flashing when an alarm has occurred.

4.4 Saving the Data as a CSV File

● Saving the Data as a CSV File

The Alarm Log data can be saved to the external memory device*1 as a CSV file or uploaded to a computer.

The procedure to save the data is as follows.

- To save the data to an external memory device, click **Alarm Log** on the WindO/I-NV4 **Configuration** tab to open the Alarm Log Settings dialog box. Select an output method check box on the **External Memory Device** tab and configure the items. The data can be saved to the External Memory Device folder on the external memory device. For details, refer to "External Memory Device Tab" on page 13-20.
- To upload the data to a computer, click on ▼ to the right of  (Upload) on the toolbar in Data File Manager, and then click the **Upload All Log Data** or **Upload Alarm Log Data** to open the Browser For Folder dialog box. Specify the location to save the file and click **OK** to save the file to the specified folder. For details, refer to the Data File Manager User's Manual.

● Data Structure and Output Example

The data structure for files output with batch output and real time output is different.

■ Batch

Batch output shows the recovery and confirmation time for an alarm that has occurred on a single line.

The data structure of files output with batch output is as follows. Bold items are replaced by the Alarm Log settings, the sampled data, the running project name, and WindO/I-NV4 version number.

Headers	"Project Name", Project name , Version number
	"File Type", Log type
	Blank row
Title row	"Ch.No.", "Level", "Message", "Occurrence Time", "Recovery Time", "Confirmation Time"
Data row	Channel number , Level , Message , MM/DD/YYYY hh:mm:ss , MM/DD/YYYY hh:mm:ss , MM/DD/YYYY hh:mm:ss
	⋮

Output example

"Project Name", "Dimmer Console", "V4.50"	Data size of each row
"File Type", "Alarm Log Data"	- 41 bytes
	- 30 bytes
	- 2 bytes
"Ch.No.", "Level", "Message", "Occurrence Time", "Recovery Time", "Confirmation Time"	- 82 bytes
"1-0", "Level 8", "Voltage drop", "08/11/2011 14:46:12", "08/11 14:46:13", "08/11 14:46:16"	- 88 bytes
"1-1", "Level 4", "Abnormal temperature", "08/11/2011 14:47:18", "08/11 14:47:19", "08/11 14:47:20"	- 96 bytes
⋮	

*1 USB flash drive inserted in USB1 for HG2J-7U, SD memory card for HG5G/4G/3G/2G-V, HG4G/3G and HG2G-5F, USB flash drive for HG2G-5T and HG1G/1P

■ Real Time

Real time output displays the alarm state and the time the alarm became that state on a single line each time an alarm occurs, is recovered from, or is confirmed.

The data structure of files output with real time output is as follows. Bold items are replaced by the Alarm Log settings, the sampled data, the running project name, and WindO/I-NV4 version number.

Headers	"Project Name", "Project name" , "Version number"
	"File Type", "Log type"
	Blank row
Title row	"Time", "State", "Ch.No.", "Level", "Message"
Data row	" MM/DD/YYYY hh:mm:ss ", "State" , "Channel number" , "Level" , "Message"
	⋮

Output example

"Project Name", "Dimmer Console", "V4.50"	Data size of each row - 41 bytes
"File Type", "Alarm Log Data"	- 30 bytes
	- 2 bytes
"Time", "State", "Ch.No.", "Level", "Message"	- 43 bytes
"08/11/2011 14:46:12", "Occurred", "1-0", "Level 8", "Voltage drop"	- 65 bytes
"08/11/2011 14:46:13", "Recovered", "1-0", "Level 8", "Voltage drop"	- 66 bytes
"08/11/2011 14:46:16", "Confirmed", "1-0", "Level 8", "Voltage drop"	- 66 bytes
"08/11/2011 14:47:18", "Occurred", "1-1", "Level 4", "Abnormal temperature"	- 73 bytes
⋮	



- The data size for each row is counted as 2 bytes for full-width characters, 1 byte for half-width characters, and 2 bytes for newlines. The total for each row is the total amount of space for the file.
- Can only output the Level when the **Output Alarm Level** check box in the **External Memory Device** tab on the Alarm Log Settings dialog box is selected.
- A space is inserted before the date in the data row.
- The display type for the date and time varies based on the language configured in **Project Settings**, on the **Project Details** tab, in **Language**.
 - Japanese: YYYY/MM/DD hh:mm:ss
 - Western, Simplified Chinese, Traditional Chinese, Hangu, Central European, Baltic, Cyrillic: MM/DD/YYYY hh:mm:ss

Chapter 14 Data Log Function

This chapter describes how to configure the Data Log function and its operation on the MICRO/I.

1 Overview

HG2J-7U HG5G-V HG4G-V HG4G HG3G-V HG3G HG2G-V HG2G-5F HG2G-5T HG1G HG1P

1.1 How the Data Log Function is Used

The Data Log function samples values of device addresses with the MICRO/I using the configured sampling condition and Condition of Writing to Data Storage Area. The sampled values of device addresses are saved in internal memory or external memory device along with the sampling time.

The Data Log function can perform the following functions.

- Sample values of device addresses at a fixed interval

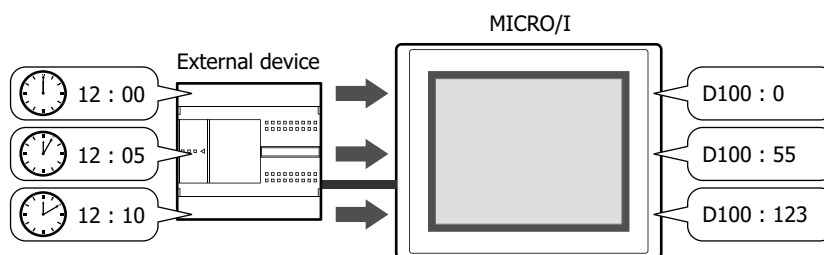

- Sample values of device addresses when a value of device address changes

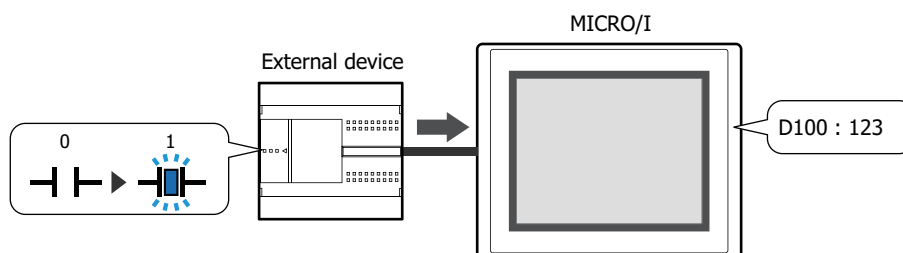

- Output Data Log data to the external memory device^{*1}

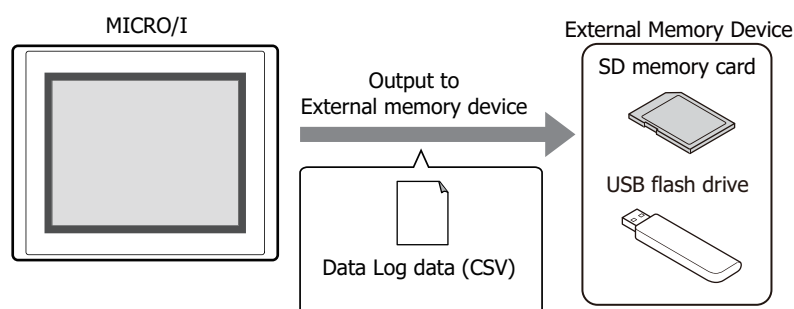

*1 USB flash drive inserted in USB1 for HG2J-7U, SD memory card for HG5G/4G/3G/2G-V, HG4G/3G and HG2G-5F, USB flash drive for HG2G-5T and HG1G/1P

- Copy Data Log data to internal devices

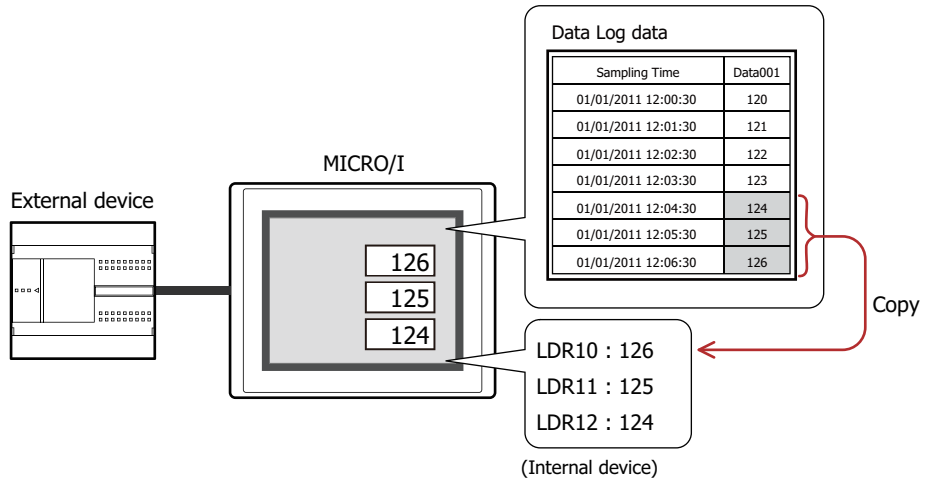

1.2 Sampling Values of Device Addresses

The MICRO/I samples values of target device addresses at a regular interval or when a value of device address changes.

● Sampling Value of Device Addresses at a Regular Interval

When sampling values of device addresses (D100 to D102) at a 5 minute interval (Time: 300 seconds) with the data storage amount in the data storage area is set to 3, the MICRO/I samples Data Log data as follows.

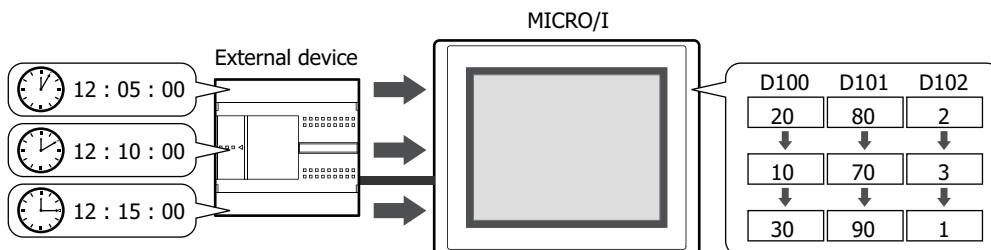

- 1 5 minutes after data sampling starts, the MICRO/I stores the values for device addresses D100 to D102.
- 2 10 minutes after data sampling starts, the MICRO/I stores the values for device addresses D100 to D102.
- 3 15 minutes after data sampling starts, the MICRO/I stores the values for device addresses D100 to D102.

Time	Value		
	D100	D101	D102
01/01/2011 12:01:00	10	70	3
01/01/2011 12:02:00	20	80	2
01/01/2011 12:03:00	30	90	1
01/01/2011 12:04:00	10	70	3
01/01/2011 12:05:00	20	80	2
01/01/2011 12:06:00	30	90	1
01/01/2011 12:07:00	10	70	3
01/01/2011 12:08:00	20	80	2
01/01/2011 12:09:00	30	90	1
01/01/2011 12:10:00	10	70	3
01/01/2011 12:11:00	20	80	2
01/01/2011 12:12:00	30	90	1
01/01/2011 12:13:00	10	70	3
01/01/2011 12:14:00	20	80	2
01/01/2011 12:15:00	30	90	1
01/01/2011 12:16:00	10	70	3

Sampling Time	Value		
	Data 1	Data 2	Data 3
01/01/2011 12:05:00	20	80	2
01/01/2011 12:10:00	10	70	3
01/01/2011 12:15:00	30	90	1

- 4 20 minutes after data sampling starts, the MICRO/I stores the values for device addresses D100 to D102.

Since the data storage amount in the data storage area is set to 3, the oldest data is deleted in order to make room for the newest data.

Time	Value		
	D100	D101	D102
⋮	⋮	⋮	⋮
01/01/2011 12:17:00	40	60	2
01/01/2011 12:18:00	30	60	1
01/01/2011 12:19:00	10	90	3
01/01/2011 12:20:00	20	80	2

Sampling Time	Value		
	Data 1	Data 2	Data 3
01/01/2011 12:10:00	10	70	3
01/01/2011 12:15:00	30	90	1
01/01/2011 12:20:00	20	80	2

● Sampling Values of Device Addresses when a Value of Device Address Changes

If sample values of device addresses (D100 to D102), when the bit device or the bit number of the word device configured as the Condition of Writing to Data Storage Area switches from 0 to 1 and the data storage amount in the data storage area is set to 3, the MICRO/I samples Data Log data as follows. (When **Sampling Method** is **While satisfying the condition of writing to data storage area**)

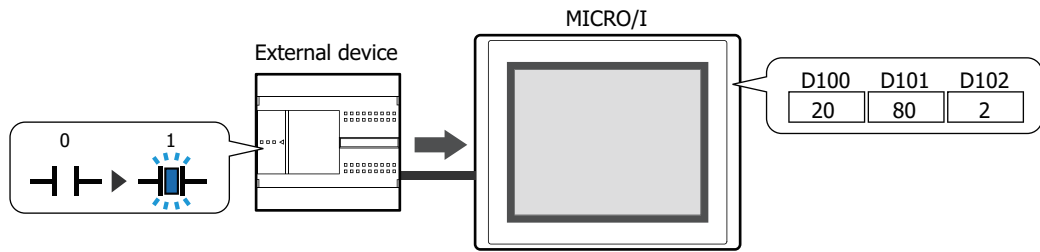

- 1 When data sampling starts and the value of device address configured as the Condition of Writing to Data Storage Area switches from 0 to 1, the MICRO/I stores the values for device addresses D100 to D102.
- 2 When the value of device address configured as the Condition of Writing to Data Storage Area switches from 0 to 1 the second time, the MICRO/I stores the values for device addresses D100 to D102.
- 3 When the value of device address configured as the Condition of Writing to Data Storage Area switches from 0 to 1 the third time, the MICRO/I stores the values for device addresses D100 to D102.

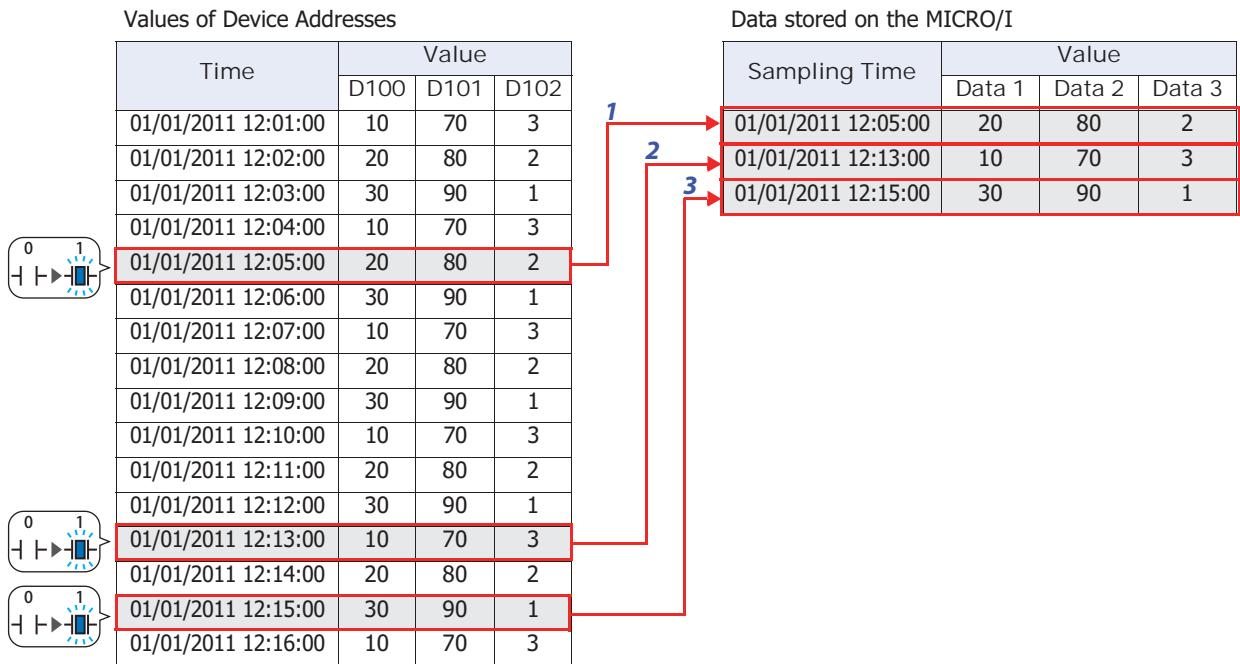

- 4 When the value of device address configured as the Condition of Writing to Data Storage Area switches from 0 to 1 the fourth time, the MICRO/I stores the values for device addresses D100 to D102.

Since the data storage amount in the data storage area is set to 3, the oldest data is deleted in order to make room for the newest data.

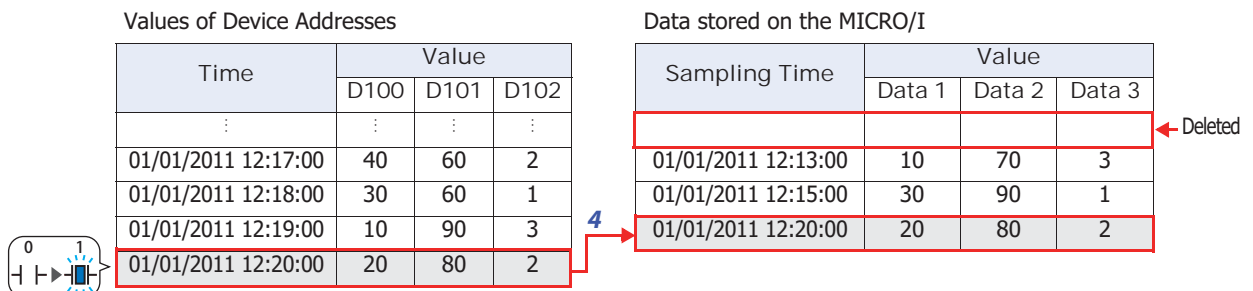

1.3 Data Configuration

The sampled data is composed of the sampling time, values of device addresses, and labels.
The relationship between the Data Log function settings and the sampled data is as follows.

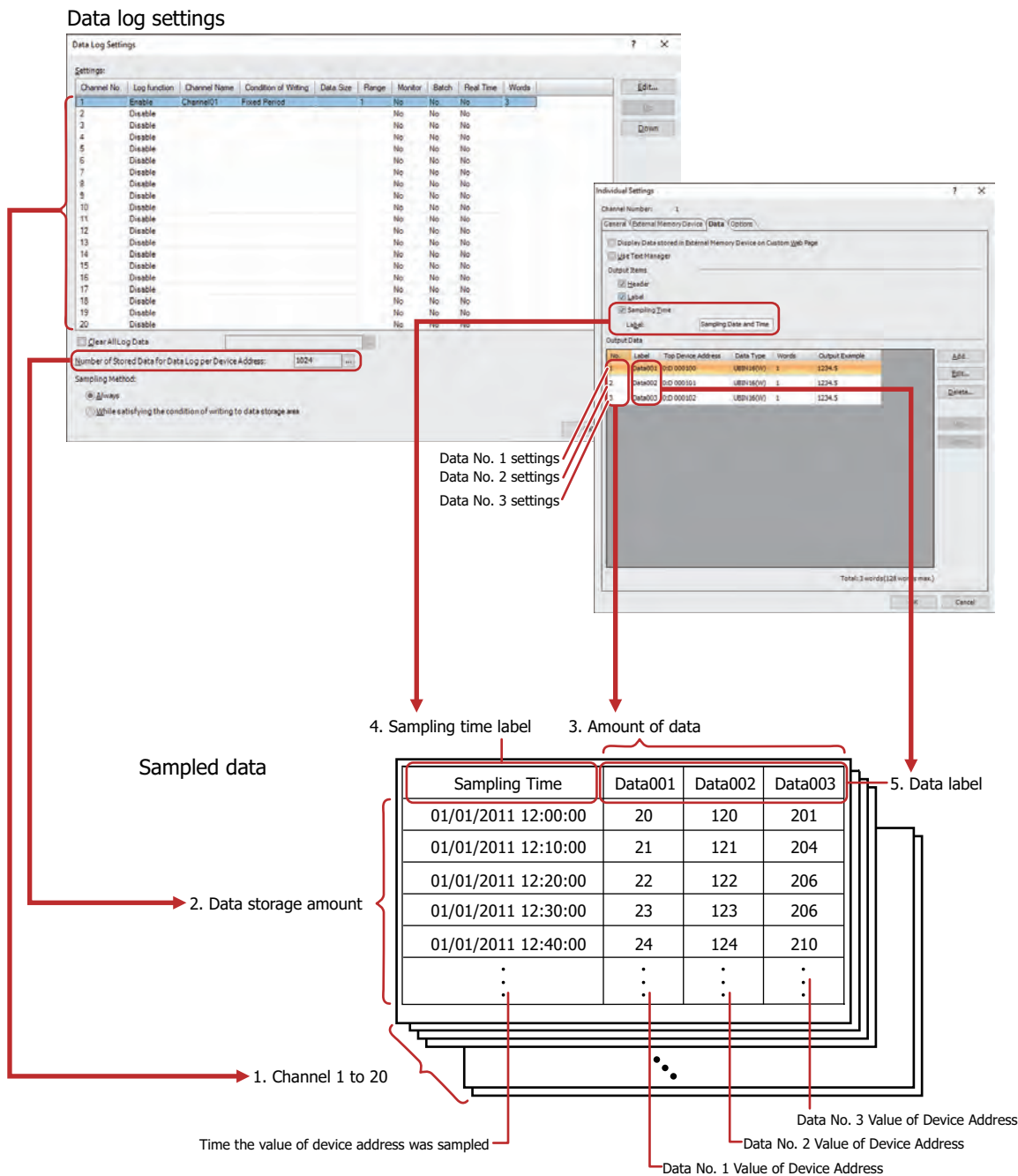

- 1. Channel
The sampled data is in channel units. A maximum of 20 channels can be configured.
- 2. Data storage amount:
The amount of sampled data to save. The maximum amount that can be configured per device address differs according to the model. For details, refer to "Data Storage Amount" on page 14-6.
- 3. Amount of data:
The amount of data registered to a channel. The maximum amount of data that can be set will depend on the **Sampling Method** setting. For details, refer to "Sampling Method" on page 14-14.
- 4. Sampling time label:
When the sampled data is output as a CSV file, this label is displayed in the label row for the sampling time column.
- 5. Data label:
When the sampled data is output as a CSV file, this label is displayed in the label row for the data number columns.

1.4 Saving and Deleting Data

● Saving Data

The sampled values of device addresses along with the sampling time are all saved in the data storage area.

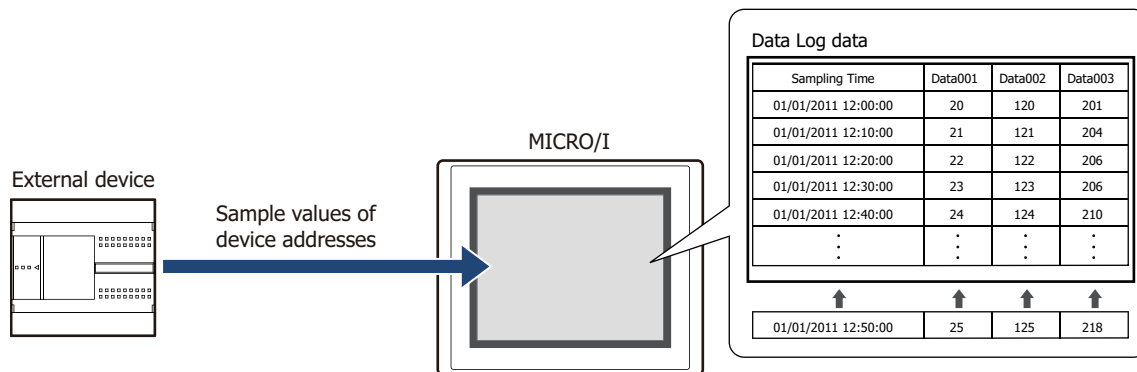

If the saved data exceeds the Data Log data storage amount per device address, the old data is deleted and the new data is saved.

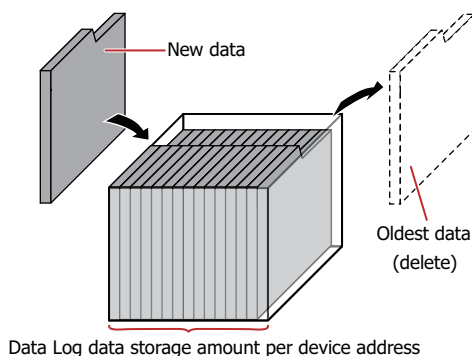

When the backup battery is depleted, the data in the Data Log is erased when the MICRO/I is turned off.

Data Storage Amount

When saving the sampled data to the data storage area, set the data storage amount per device address. The amount of data that can be saved in the data storage area is calculated from the configured data storage amount per device address and data amount for each channel.

The maximum amount of data that can be saved in the data storage area is as follows.

Model	Maximum amount of data that can be saved in the data storage area
HG5G/4G/3G/2G-V, HG4G/3G, HG2G-5F	29,165
HG2J-7U, HG2G-5T, HG1G/1P	13,808

● Deleting Data

The method to delete sampled data from the data storage area is as follows.

- On the **Online** tab in WindO/I-NV4, click the arrow under **Clear**, and click **All** or **Data Log Data**. For details, refer to Chapter 24 "4 Clear" on page 24-26.
- In the System Mode, on the Main Menu screen, press **Initial Setting**, **Initialize**, **Data Log** in order.

1.5 Using the Data

The saved data can be used in the following ways.

Data Log data

Sampling Time	Data001	Data002	Data003
01/01/2011 12:00:00	20	120	201
01/01/2011 12:10:00	21	121	204
01/01/2011 12:20:00	22	122	206
01/01/2011 12:30:00	23	123	206
01/01/2011 12:40:00	24	124	210
⋮	⋮	⋮	⋮

To use with the MICRO/I

To use with devices other than the MICRO/I

- **Display the data in the Line Chart**

Configure the data channel numbers and data numbers and display the data in the Line Chart. For details, refer to "4.1 Displaying the Data in the Line Chart" on page 14-33.

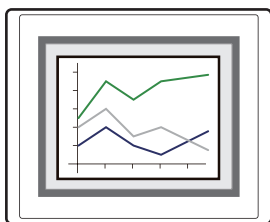

- **Display the data with the Data Log Display**

Lists the Data Log data saved in the data storage area and the external memory device. For details, refer to "4.2 Displaying Data on the Data Log Display" on page 14-35.

Sampling Time	Data001	Data002	Data003
2011/01/01 12:00:00	20	120	201
2011/01/01 12:10:00	21	121	204
2011/01/01 12:20:00	22	122	206
2011/01/01 12:30:00	23	123	206
2011/01/01 12:40:00	24	124	210
2011/01/01 12:50:00	25	125	210
2011/01/01 12:55:00	26	126	218

- **Display the data with the Numerical Input or the Numerical Display**

Copy the data to an internal device and display it with the Numerical Input or the Numerical Display. For details, refer to "4.3 Displaying Data as Numerical Values" on page 14-36.

Data001	24
Data002	124
Data003	210

- **Save to and read from an external memory device*1**

Output data from the MICRO/I to the an external memory device as a CSV file and use it on a computer.

For details, refer to "4.4 Saving the Data as a CSV File" on page 14-45.

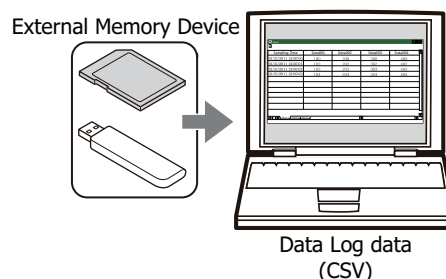

*1 USB flash drive inserted in USB1 for HG2J-7U, SD memory card for HG5G/4G/3G/2G-V, HG4G/3G and HG2G-5F, USB flash drive for HG2G-5T and HG1G/1P

2 Data Log Function Configuration Procedure

HG2J-7U HG5G-V HG4G-V HG4G HG3G-V HG3G HG2G-V HG2G-5F HG2G-5T HG1G HG1P

This section describes the configuration procedure for the Data Log function.

2.1 Configuring the Data Log Function

- 1 On the **Configuration** tab, in the **System Setup** group, click **Data Log**.

The **Data Log Settings** dialog box is displayed.

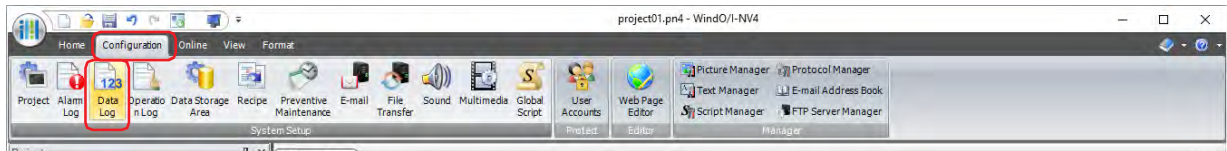

- 2 Under **Sampling Method**, select the method that will be used by the MICRO/I to read data.

- **Always**

The values of the device addresses set for the data of each channel are always read. When the condition of writing to the data storage area is satisfied, the values that were read at that point in time are written to the data storage area.

- **While satisfying the condition of writing to data storage area**

The values of the device addresses set for the data of each channel are read when the condition of writing to the data storage area is satisfied, and those values are written to the data storage area.

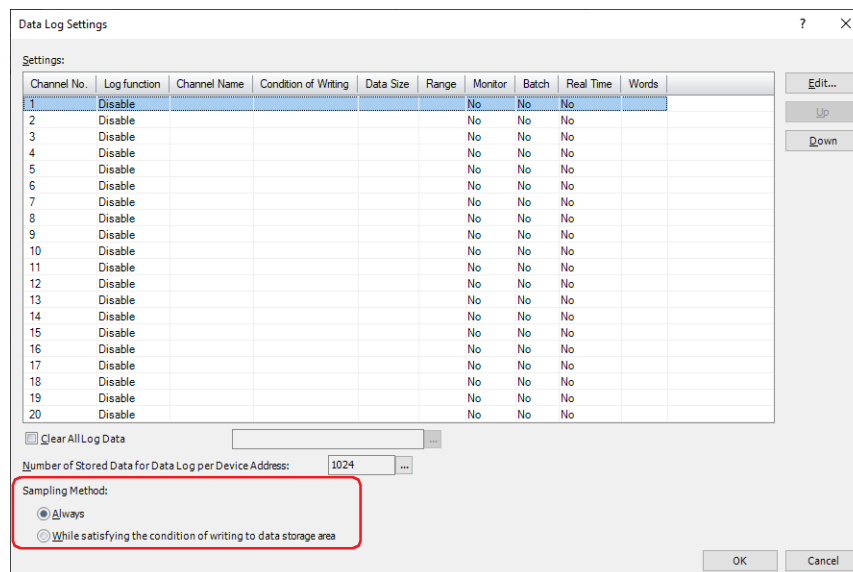

- 3 Select the channel number to register the Data Log settings to in **Settings**, then click **Edit**.

The **Individual Settings** dialog box is displayed.

- 4 On the **General** tab, under **Log function**, select **Enable**.

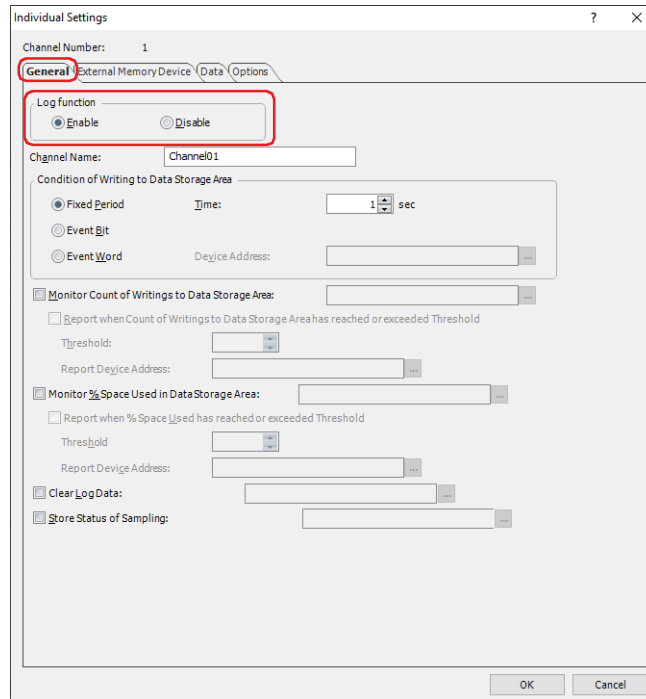

The channel number selected on the **Data Log Settings** dialog box is displayed in **Channel No.**

- 5 Enter the name of the channel in **Channel Name**.
- 6 Under **Condition of Writing to Data Storage Area**, select the condition that will be used to write the values of the sampled device addresses to the data storage area.

■ **Fixed Period**

Writes the value of source device address at a fixed interval. If **Fixed Period** is selected, specify **Time** in seconds.

■ **Event Bit**

Writes the value of source device address each time the monitored bit device or the bit number of the word device changes from 0 to 1. If **Event Bit** is selected, specify the device address to monitor as the condition for writing data in **Device Address**.

Click to display the Tag Editor. For the device address configuration procedure, refer to Chapter 2 "5.1 Device Address Settings" on page 2-70.

■ **Event Word**

Writes the value of source device address each time the value of monitored word device changes. If **Event Word** is selected, select the data size for the word device to monitor in **Data Size**, and specify the device address to monitor as the condition for Writing data in **Device Address**.

Click to display the Tag Editor. For the device address configuration procedure, refer to Chapter 2 "5.1 Device Address Settings" on page 2-70.

- 7 Click the **Data** tab.

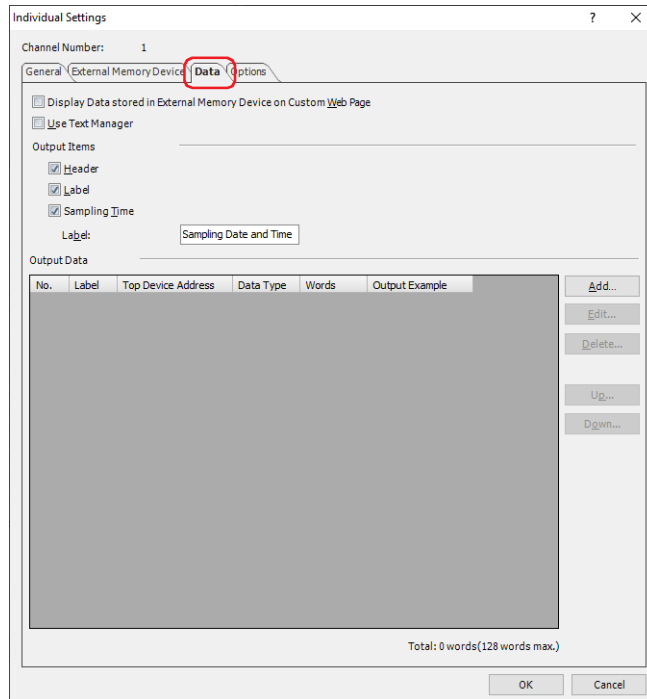

- 8 Under **Output Items**, select the items that will be output when data is output as CSV.

Select the check boxes of the items to output.

If the **Label** check box is selected, enter the label to display in the sampling time column when the data is output as CSV.

To use text registered in Text Manager, select the **Use Text Manager** check box and specify the ID number of the text to use as the label.

Click  to open Text Manager where you can edit the text.

- 9 Click **Add** in the **Output Data**.

The **Add Data** dialog box is displayed.

- 10 In **Number of Data**, specify the amount of data to add to the channel.

The configured number of sequential device addresses from the start device address are displayed in **Output Data**.

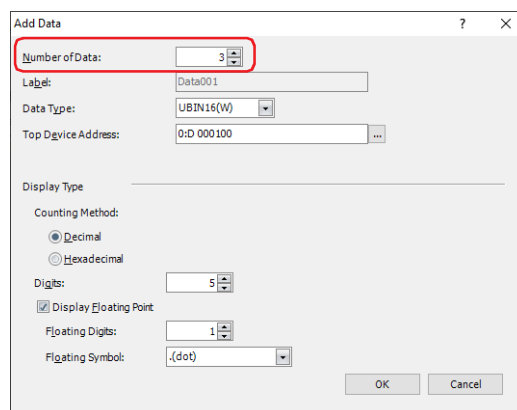

11 In **Label**, enter the text to display for the label of the data.

The label is used for the label row of the data number columns when the data is output as CSV.

- When **Number of Data** is 2 or higher, "Data+Number" is automatically entered.
Example: Data001, Data002, Data003
- If the **Use Text Manager** check box is selected on the **Data** tab, specify a text ID to use for the label in **Label(Start Text ID)**.

12 In **Top Device Address**, specify the starting device address of the word devices that will be read for sampling data.

Click to display the Tag Editor. For the device address configuration procedure, refer to Chapter 2 "5.1 Device Address Settings" on page 2-70.

13 Select the data type of the sampled device value in **Data Type**.

The data type selected here is the data type for the numerical values when the data is output as CSV.

When **String(S)** is selected, use **Words** to specify the number of words of device addresses to read starting from the set device address and proceed to step **15**. The set number of words of consecutive device addresses from the starting device address will be output as CSV.

14 Under **Display Type**, set the display type for numerical values when data is output as CSV.

■ **Counting Method**

Select the display type as **Decimal** or **Hexadecimal** for numerical values.

■ **Digits**

Specifies the digits to display. The range of digits that can be set varies based on the display type and data type.

■ **Display Floating Point**

Select this check box to display the decimal point.

■ **Floating Digits**

Specifies the number of digits for the fractional part of the decimal value out of the number of digits specified by **Digits**.

This option can only be configured when the **Display Floating Point** check box is selected.

■ **Floating Symbol**

Selects the decimal point symbol from the following.

.(dot), :(colon), ;(semicolon), ,(comma), /(slash)

This option can only be configured when the **Display Floating Point** check box is selected.

15 Click **OK** to close the **Add Data** dialog box.

You are returned to the **Individual Settings** dialog box.

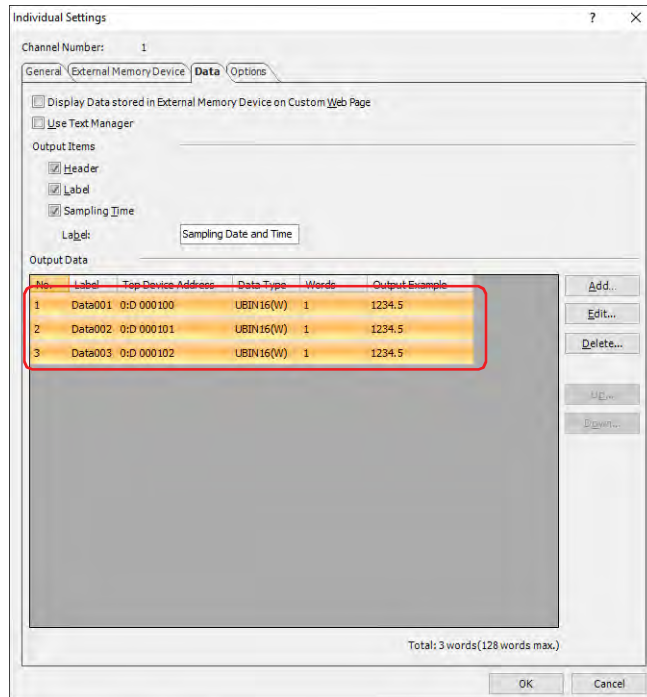

To individually register Data Log settings, repeat steps 9 through 14.

16 Click **OK** to close the **Individual Settings** dialog box.

You are returned to the **Data Log Settings** dialog box.

17 Repeat steps 3 through 16 to register Data Log settings for all of the channel numbers to use.

18 Click **OK**.

The **Data Log Settings** dialog box closes.

This concludes configuring the sampling conditions and device addresses for sampling data.

Next, configure the functions to execute using sampled data.

☞ "4.1 Displaying the Data in the Line Chart" on page 14-33

☞ "4.3 Displaying Data as Numerical Values" on page 14-36

☞ "4.4 Saving the Data as a CSV File" on page 14-45

3 Data Log Settings Dialog Box

HG2J-7U HG5G-V HG4G-V HG4G HG3G-V HG3G HG2G-V HG2G-5F HG2G-5T HG1G HG1P

This section describes the items and buttons on the **Data Log Settings** dialog box and the **Individual Settings** dialog box.

3.1 Data Log Settings Dialog Box

All the device addresses to sample values from and their sampling conditions and Condition of Writing to Data Storage Area are collectively managed in the **Data Log Settings** dialog box.

Channel No.	Log function	Channel Name	Condition of Writing	Data Size	Range	Monitor	Batch	Real Time	Words
1	Enable	Channel01	Fixed Period		1	No	No	No	3
2	Disable					No	No	No	
3	Disable					No	No	No	
4	Disable					No	No	No	
5	Disable					No	No	No	
6	Disable					No	No	No	
7	Disable					No	No	No	
8	Disable					No	No	No	
9	Disable					No	No	No	
10	Disable					No	No	No	
11	Disable					No	No	No	
12	Disable					No	No	No	
13	Disable					No	No	No	
14	Disable					No	No	No	
15	Disable					No	No	No	
16	Disable					No	No	No	
17	Disable					No	No	No	
18	Disable					No	No	No	
19	Disable					No	No	No	
20	Disable					No	No	No	

■ Settings

Edits the Data Log settings for each channel.

- Channel No.: Shows the channel number. Double clicking the cell displays the **Individual Settings** dialog box where you can edit the settings. For details, refer to “3.2 Individual Settings Dialog Box” on page 14-15.
- Log function: Shows whether or not the Data Log function is used. Double clicking the cell switches between **Enable** and **Disable**. If switched to **Disable**, that channel’s settings all return to the default settings.
- Channel Name: Shows the channel name. Double clicking the cell displays the **Individual Settings** dialog box where you can edit the settings. For details, refer to “3.2 Individual Settings Dialog Box” on page 14-15. This option can only be set when **Enable** is selected in **Log Function**.
- Condition of Writing: Shows the condition for writing to data storage area. Double clicking the cell switches between **Fixed Period**, **Event Bit**, and **Event Word**. This option can only be set when **Enable** is selected in **Log Function**.
- Data Size: Shows the data size for the device address that is the **Condition of Writing to Data Storage Area**. Double clicking the cell switches between **16-bit** and **32-bit**. This option can only be set when **Event Word** is selected in **Condition of Writing to Data Storage Area**.
- Range: Shows the time in seconds (1 to 9999) to sample data in a fixed interval when **Fixed Period** is selected in **Condition of Writing to Data Storage Area**. Double clicking the cell displays the **Individual Settings** dialog box where you can edit the settings. For details, refer to “3.2 Individual Settings Dialog Box” on page 14-15.
- Shows the device address that is the condition of writing to Data Storage Area when **Event Bit** or **Event Word** is selected in **Condition of Writing to Data Storage Area**. Double clicking the cell displays the Tag Editor where you can edit the device address. For the device address configuration procedure, refer to Chapter 2 “5.1 Device Address Settings” on page 2-70.

Monitor:	Shows the write destination device address when monitor count of writings to Data Storage Area. Shows No when not monitoring. Double clicking the cell displays the Individual Settings dialog box where you can edit the settings. For details, refer to "3.2 Individual Settings Dialog Box" on page 14-15. This option can only be set when Enable is selected in Log Function .
Batch:	Shows the trigger device address that triggers batch output when batch outputting all the data saved in the data storage area to the external memory device. Shows No when there is no batch output. Double clicking the cell displays the Individual Settings dialog box where you can edit the settings. For details, refer to "3.2 Individual Settings Dialog Box" on page 14-15.
Real Time:	Shows whether or not to perform real time output. Double clicking the cell switches between Yes and No . Data is output to the external memory device in 3 minute intervals for Yes channels. This option can only be set when Enable is selected in Log Function .
Words:	Shows the total number of words of the device addresses that will be sampled by the channel. Double clicking the cell displays the Individual Settings dialog box where you can edit the settings. For details, refer to "3.2 Individual Settings Dialog Box" on page 14-15. This option can only be set when Enable is selected in Log Function .

■ Edit

Registers or changes the settings for the selected channel number.

Select a channel number and click this button to display the **Individual Settings** dialog box. The settings for the selected channel are reflected in the **Individual Settings** dialog box.

For details, refer to "3.2 Individual Settings Dialog Box" on page 14-15.

■ Up

Shifts the selected settings upward in the list.

■ Down

Shifts the selected settings downward in the list.

■ Clear All Log Data

Select this check box to erase the all log data saved in the data storage area.

(Trigger Device Address): Specifies the bit device or the bit number of the word device that triggers the erasure of the data. The data for all channels is erased when the value of the configured device address changes from 0 to 1. For the device address configuration procedure, refer to Chapter 2 "5.1 Device Address Settings" on page 2-70.

■ Number of Stored Data for Data Log per Device Address

Shows the maximum amount of data storage per device address for Data Log data saved in the data storage area. If data is saved up the maximum amount and then the maximum is exceeded, the old data is deleted and the new data is saved.

The default is 1024.

Click  to display the **Data Storage Area Management** dialog box where you can change the allocation of data storage area memory. For details, refer to Chapter 16 "Data Storage Area" on page 16-1.

■ Sampling Method

Sets the method that will be used by the MICRO/I to read the values of device addresses.

Always: The values of the device addresses set for the data of each channel are always read. When the condition of writing to the data storage area is satisfied, the values that were read at that point in time are written to the data storage area.

While satisfying the condition of writing to data storage area:

The values of the device addresses set for the data of each channel are read when the condition of writing to the data storage area is satisfied, and those values are written to the data storage area.



The total number of words of data that can be registered to the data log settings will depend on **Sampling Method**.

- If **Sampling Method** is **Always**, the total number of words in all channels is 128 words or less.
- If **Sampling Method** is **While satisfying the condition of writing to data storage area**, the total number of words per channel is 128 words or less.

3.2 Individual Settings Dialog Box

Use the **Individual Settings** dialog box to register or edit the Data Log settings for the selected channel.

- **Channel Number**

Shows the channel number selected in **Settings** in the **Data Log Settings** dialog box.

- **General Tab**

Sets the channel name and device address values to write to the data storage area.

- **Log function**

Selects whether or not to use the Data Log function.

Enable: Samples values of device addresses and saves the data along with the sampling time.

Disable: Does not sample values of device addresses.

- **Channel Name**

Enter a name of the channel. The maximum number is 40 characters.

■ Condition of Writing to Data Storage Area

Sets the condition to write to the sampled address values to the data storage area.

- Fixed Period: Writes the value of source device address at a fixed interval. If **Fixed Period** is selected, specify **Time** in seconds.
- Time: Specifies the time in seconds (1 to 9999).
This option can only be set when **Fixed Period** is selected.
- Event Bit: Writes the value of source device address each time the monitored bit device or the bit number of the word device changes from 0 to 1.
- Event Word: Writes the value of source device address each time the value of monitored word device changes.
- Data Size: Selects the data size of the monitored device address as **16-bit** or **32-bit**.
This option can only be set when **Event Word** is selected.
- Device Address: Specifies the device address to monitor as the condition for Writing data.
For the device address configuration procedure, refer to Chapter 2 "5.1 Device Address Settings" on page 2-70.
This option can only be set when **Event Bit** or **Event Word** is selected.



If this setting is different from other channels, it cannot be displayed in the Line Chart.

■ Monitor Count of Writings to Data Storage Area

Select this check box to monitor count of writings to Data Storage Area. The count of writings to Data Storage Area is written to the specified device address.

- (Destination Device Address): Specifies the destination word device.
For the device address configuration procedure, refer to Chapter 2 "5.1 Device Address Settings" on page 2-70.
- Report when Count of Writings to Data Storage Area has reached or exceeded Threshold:
- Writes 1 in the Report Device Address when the current count of writings to Data Storage Area reaches or exceeds the set threshold.
- Threshold: Specifies the count of writings to Data Storage Area that is the basis for reporting (1 to 65535).
- Report Device Address: Specifies the destination bit device or the bit number of the destination word device.
For the device address configuration procedure, refer to Chapter 2 "5.1 Device Address Settings" on page 2-70.

■ Monitor % Space Used in Data Storage Area

Select this check box to monitor the usage of the allocated data storage area as the save destination for Data Log data. The usage is calculated from the data storage amount allocated to the data storage area and the amount of saved data, and then written to the specified device address.

Usage = Current amount of Data Log data ÷ Data Log data storage amount per device address (omits values after the decimal point)

- (Destination Device Address): Specifies the destination word device to write the current usage of the amount of Data Log data storage.
For the device address configuration procedure, refer to Chapter 2 "5.1 Device Address Settings" on page 2-70.
- Report when % Space Used has reached or exceeded Threshold:
- Writes 1 in the Report Device Address when the current usage reaches or exceeds the set threshold.
- Threshold: Specifies the usage (1 to 100) that is the basis for reporting.
- Report Device Address: Specifies the destination bit device or the bit number of the destination word device.
For the device address configuration procedure, refer to Chapter 2 "5.1 Device Address Settings" on page 2-70.

■ Clear Log Data

Select this check box to erase the Data Log data for the selected channel from the Data Storage Area.

(Trigger Device Address): Specifies the bit device or the bit number of the word device that triggers the erasure of the data. The data for selected channels is erased when the value of the configured device address changes from 0 to 1. For the device address configuration procedure, refer to Chapter 2 "5.1 Device Address Settings" on page 2-70.



If the amount of log data for the channel differs, the Line Chart cannot be displayed.

If differing channels of data were displayed in the same chart, the chart can no longer be displayed if the Data Log data is erased by channel units.

■ Store Status of Sampling

Select this check box to check the reading status of data.

(Status Device Address): Specify the word device that will store the reading status. For the device address configuration procedure, refer to Chapter 2 "5.1 Device Address Settings" on page 2-70.

Bit	Function	Description
0	Reading	This bit is 1 while reading the data from the external device and 0 when reading has completed.
1	Read error	This bit is 1 when the condition of writing to the data storage area was satisfied again while reading data from the external device and data was lost. To clear this bit, write 1 to the Clear error bit (bit 15).
2 to 14	Reserved	-
15	Clear error	Write 1 to this bit to clear the read error (bit 1). This bit automatically changes to 0 when processing is finished.

● External Memory Device Tab

The **External Memory Device** tab is used to configure whether or not to output saved data to the external memory device^{*1}.

Individual Settings

Channel Number: 1

General **External Memory Device** Data Options

Batch

Trigger Device Address: LM 0003

File Name: LOGO01 ###.CSV

Specify File Name by Value of Device Address: LDR 0100

Add Device Address data to File Name: LDR 0200

Add Time Stamp: None

Store File Path: LDR 0300 (LDR 0300 - LDR 0363)

Set limit on files: 30

Real Time

File Name: LOGA01 ###.CSV

Specify File Name by Value of Device Address: LDR 0400

Add Device Address data to File Name: LDR 0500

Add Time Stamp: None

Store File Path: LDR 0600 (LDR 0600 - LDR 0663)

Maximum of File Number: 30

Realtime Output: LM 0004

Save Data Log Data and Display in Line Chart or Data Log Display:

File Name: LOGA01.BIN

OK Cancel

The output data is stored in the "DATALOG" folder of the External Memory Device folder.

The default External Memory Device folder name is "HGDATA01". For details, refer to Chapter 31 "1.4 File structure" on page 31-3 and Chapter 31 "1.6 Setting the External Memory Device Folder" on page 31-12.



Data that is sampled after starting output to the external memory device is not included in the output data.

*1 USB flash drive inserted in USB1 for HG2J-7U, SD memory card for HG5G/4G/3G/2G-V, HG4G/3G and HG2G-5F, USB flash drive for HG2G-5T and HG1G/1P

Batch

Select this check box to batch output all the sampled data to the external memory device*1.

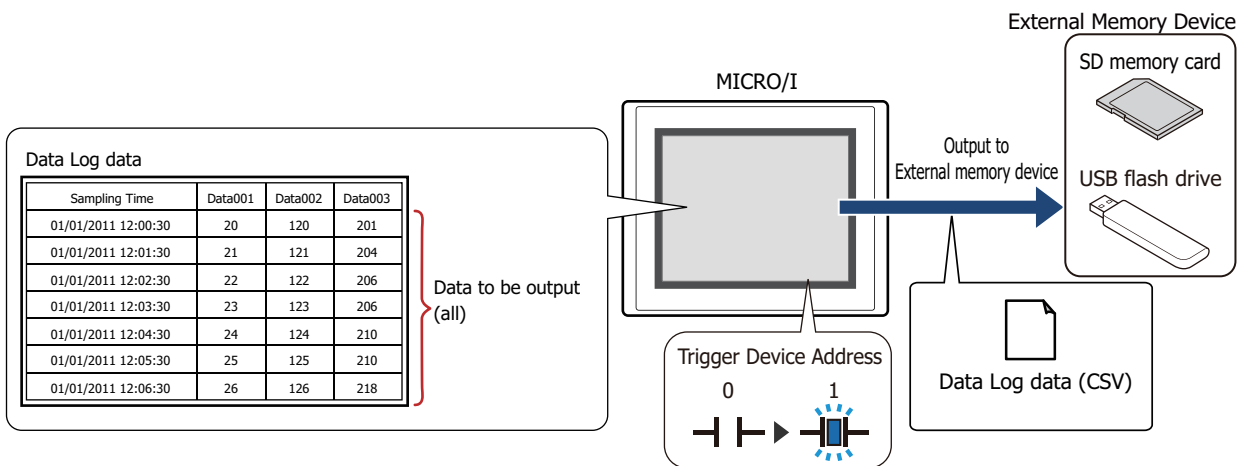

All the data is saved on the external memory device*1 when the trigger device addresses changes from 0 to 1. If a file with the same name already exists on the external memory device*1, that file is overwritten. The maximum amount of output data is the amount configured by the data storage area.

! The storing of data stops if there is insufficient free space on the external memory device. The error information is stored in the following HMI Special Data Registers. For details about the error information, refer to Chapter 33 "HMI Special Data Register (LSD)" on page 33-8.

HG2J-7U, HG5G/4G/3G/2G-V, HG4G/3G, HG2G-5F: LSD42
 HG2G-5T, HG1G/1P: LSD33

Trigger Device Address: Specifies the bit device or the bit number of the word device to serve as condition for batch output. For the device address configuration procedure, refer to Chapter 2 "5.1 Device Address Settings" on page 2-70.

Data is output to file when the value of the Trigger Device Address changes from 0 to 1.

File Name: Enter the file name for the output data or shows the file name.

The default is "LOGO*n*.CSV". (*n*: Data log channel number)
 To change the file name, enter a new file name. The maximum number is 120 characters (including the extension).

Specify File Name by Value of Device Address: Select this check box to assign a file name for the output data using a value of device address specified in the File Name Device Address.

(File Name Device Address): Specifies a word device to create a file name. The file name is set by reading the values sequentially from the starting device address specified with the File Name Device Address and handling those values as character data up to the character before NULL(00h).
 The maximum number of device addresses is 40 (2 characters per word device, maximum of 80 single-byte characters). You can only specify an internal device. For the device address configuration procedure, refer to Chapter 2 "5.1 Device Address Settings" on page 2-70.

Example: **from Upper byte** is selected as the **Storage Method of String Data** on the **System** tab in the Project Settings dialog box, and the device address specified by (File Name Device Address) is LDR100 and the text to set is "IDEC":

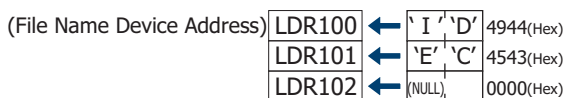

The file name at this time becomes "IDEC.CSV".

*1 USB flash drive inserted in USB1 for HG2J-7U, SD memory card for HG5G/4G/3G/2G-V, HG4G/3G and HG2G-5F, USB flash drive for HG2G-5T and HG1G/1P

Add Device Address data to File Name:

Select this check box to add the bottom three digits of the value of the device address configured by (File Name Device Address) to the end of the file name for the output data.

(File Name Device Address): Specifies the word device that is the source for the value to add to the file name. For the device address configuration procedure, refer to Chapter 2 "5.1 Device Address Settings" on page 2-70. This option can only be configured when the **Add Device Address data to File Name** check box is selected.

Example: When **File Name** is "LOGO01" and the value of device address in (File Name Device Address) is 123, the file name is "LOGO01123.CSV".

Add Time Stamp: Select from the following format for date and time to be added to the file name when data is output:

None, YY, YY+MM, YY+MM+DD, YY+MM+DD+HH, YY+MM+DD+HH+MM, YY+MM+DD+HH+MM+SS

The format is YYMMDD_hhmmss (YY: year, MM: month, DD: day, hh: hour, mm: minute, ss: second).

Example: **File Name** is "LOGO01" on September 15 2013 at 23:30:50

YY: LOGO01_13
YY+MM: LOGO01_1309
YY+MM+DD: LOGO01_130915
YY+MM+DD+HH: LOGO01_130915_23
YY+MM+DD+HH+MM: LOGO01_130915_2330
YY+MM+DD+HH+MM+SS: LOGO01_130915_233050

Store File Path: Select this check box to store the file path of the output data in device addresses.

(Destination Device Address): Specifies the file path destination of word device. For the device address configuration procedure, refer to Chapter 2 "5.1 Device Address Settings" on page 2-70.

Set limit on files: Specifies the upper limit (1 to 100) when limiting the number of files to be output.



When the **Set limit on files** check box is selected, note the following points.

- If the number of data files saved on the external memory device increases, it may take some time for the data output processing, or the output of the next data may not be processed normally.
- When displaying pictures saved on the external memory device and processing the output of data both occur simultaneously, the pictures may not be displayed.
- When parts that blink overlap pictures saved to the external memory device, the blinking period may slow down when data output processing occurs.



• The following single-byte character cannot be used in the file name configured by **File Name** or **Specify File Name by Value of Device Address**.

" * / ; < > ? \ |

- File names that exceed the limits in **Specify File Name by Value of Device Address** and file names configured with characters that cannot be used are as follows.
 - When the text of the file name exceeds the maximum number of device addresses (no NULL(00h)), the text stored in device addresses up to the maximum number of device addresses from the start is configured.
 - When a character that cannot be used is set, the text is up to that character.
 - When the first character is a character that cannot be used, the text is that set for **File Name**.
- The operation when the **Set limit on files** check box is selected is as follows.
 - The files are output up to the set limit, and then for additional files, the new files are saved by discarding the old files in order of the oldest first.
 - If the number of files saved on the external memory device already exceeds the limit when operation starts, the number of files at that time is the limit. From there the data is discarded in order from the oldest data and replaced with new data with each file output.

Real Time

Select this check box to output data to the external memory device^{*1} in real time.

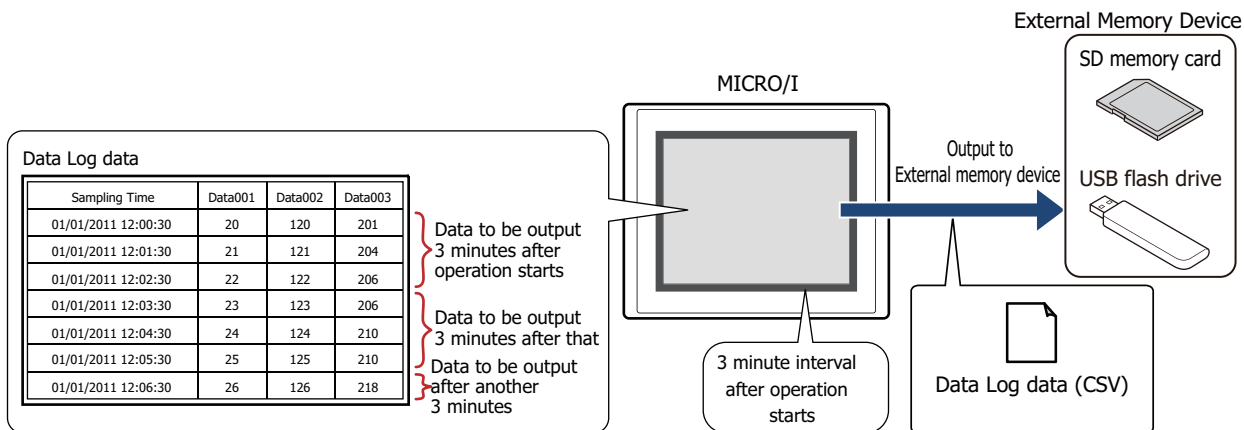

With real time output, data is saved to the external memory device^{*1} in three minute intervals after the MICRO/I starts running. If the accumulated data reaches 80% of the amount set in the Data Storage Area, then the data is forcibly saved to the external memory device^{*1}. When there is already data with the same file name on the external memory device^{*1}, data is appended to that file. If there was no update to the data during the three minutes, it is not output. Data is appended to the file until the size of the file reaches the restriction size (256 MB), so the maximum amount of output data differs according to the settings for the output channel such as the amount of data, the data size, and the labels.

If the sampling interval is shorter than real time output (the interval for writing to the external memory device^{*1}), that Data Log is recorded up to the data storage amount - 1, and then afterwards, old data is discarded in order and replaced with new data.

! Real time output stops when the file size of the Data Log data exceeds 256 MB or when there is insufficient space on the external memory device. The error information is stored in the following HMI Special Data Registers. For details about the error information, refer to Chapter 33 "HMI Special Data Register (LSD)" on page 33-8.

HG2J-7U, HG5G/4G/3G/2G-V, HG4G/3G, HG2G-5F:	LSD42
HG2G-5T, HG1G/1P:	LSD33

💡

- When the value of the following HMI Special Internal Relays changes from 0 to 1, the data at that time is first output in real time to the external memory device, and then access to the external memory device is stopped. For details, refer to Chapter 33 "HMI Special Relay (LSM)" on page 33-2.

HG2J-7U, HG5G/4G/3G/2G-V, HG4G/3G, HG2G-5F:	LSD20
HG2G-5T, HG1G/1P:	LSD18
- The amount of free space on the external memory device is saved to the following HMI Special Data Registers. For details about the free space on the External Memory Devices, refer to Chapter 33 "HMI Special Data Register (LSD)" on page 33-8.

HG2J-7U, HG5G/4G/3G/2G-V, HG4G/3G, HG2G-5F:	LSD43, 44
HG2G-5T, HG1G/1P:	LSD34, 35

*1 USB flash drive inserted in USB1 for HG2J-7U, SD memory card for HG5G/4G/3G/2G-V, HG4G/3G and HG2G-5F, USB flash drive for HG2G-5T and HG1G/1P

File Name: Enter the file name for the output data or shows the file name.

The default is "LOGO n .CSV". (n : Data log channel number)

To change the file name, enter a new file name. The maximum number is 120 characters (including the extension).

Specify File Name by Value of Device Address:

Select this check box to specify the name of the file for the output data with the value of the device address configured by (File Name Device Address).

(File Name Device Address): Specifies the word device that is the source of the data to use as the file name. The file name is set by reading the values sequentially from the starting device address specified with the File Name Device Address and handling those values as character data up to the character before NULL (00).

The maximum number of device addresses is 40 (80 single-byte characters). You can only specify an internal device. For the device address configuration procedure, refer to Chapter 2 "5.1 Device Address Settings" on page 2-70.

Example: When the device address specified by (File Name Device Address) is LDR100 and the text to set is "IDEC":

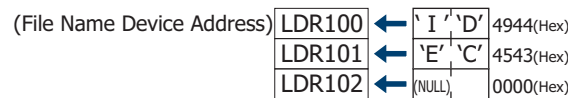

The file name at this time becomes "IDEC.CSV".

Add Device Address data to File Name:

Select this check box to add the bottom three digits of the value of the device address configured by (File Name Device Address) to the end of the file name for the output data.

(File Name Device Address): Specifies the word device that is the source for the value to add to the file name. For the device address configuration procedure, refer to Chapter 2 "5.1 Device Address Settings" on page 2-70. This option can only be configured when the **Add Device Address data to File Name** check box is selected.

Example: When **File Name** is "LOGA01" and the value of the device address configured by (File Name Device Address) is 123, the file name is "LOGA01123.CSV".

Add Time Stamp:

Selects the format of the output date and time to add to the file name for the output data.

None, YY, YY+MM, YY+MM+DD

The format is YYMMDD (YY: year, MM: month, DD: day).

Example: **File Name** is "LOGA01" on September 15 2013

YY: LOGO01_13

YY+MM: LOGO01_1309

YY+MM+DD: LOGO01_130915

Store File Path: Select this check box to store the file path of the output data in device addresses.

(Destination Device Address): Specifies the file path destination of word device. For the device address configuration procedure, refer to Chapter 2 "5.1 Device Address Settings" on page 2-70.

Set limit on files: Specifies the upper limit (1 to 100) when limiting the number of files to be output.

Realtime Output: Select this check box to forcibly output the data and save it to file at the desired timing.

(Trigger device address): Specifies the bit device or the bit number of the word device to serve as the condition to forcibly output the data. You can only specify an internal device. For the device address configuration procedure, refer to Chapter 2 "5.1 Device Address Settings" on page 2-70. Data is output to file when the trigger device address changes from 0 to 1.

Save Data Log Data and Display in Line Chart or Data Log Display:

Select this check box to save the Data Log data to the external memory device for displaying large number of data on the Line Chart or Data Log Display.

Writes the data to the file (.BIN) at the same timing as the real time output. The maximum file size is 256 MB. If the file size exceeds 256 MB at writing, the data will be deleted in order from the oldest data and replaced with new data.

Creates a "DATA" folder in the "DATALOG" folder of the external memory folder and save files for each channel.

Configures the **Display of the saved data** in the **X-Axis** tab of the **Properties of Line Chart** dialog box to display the data in the saved file on the Line Chart. For details, refer to Chapter 11 "Display of the saved data" on page 11-30.

File Name: This is the name (except extension) set in the **File Name**.

However, the settings of **Specify File Name by Value of Device Address**, **Add Device Address data to File Name** and **Add Time Stamp** are not applied.

The default is "LOGAn.BIN". (*n*: Data log channel number)



When the **Set limit on files** check box is selected, note the following points.

- If the number of data files saved on the external memory device increases, it may take some time for the data output processing, or the output of the next data may not be processed normally.
- When displaying pictures saved on the external memory device and processing the output of data both occur simultaneously, the pictures may not be displayed.
- When parts that blink overlap pictures saved to the external memory device, the blinking period may slow down when data output processing occurs.



- The following single-byte characters cannot be used in the file name configured by **File Name** or **Specify File Name by Value of Device Address**.
" * / : ; < > ? \ |
- File names that exceed the limits in **Specify File Name by Value of Device Address** and file names configured with characters that cannot be used are as follows.
 - When the text of the file name exceeds the maximum number of device addresses (no NULL(00h)), the text stored in device addresses up to the maximum number of device addresses from the start is configured.
 - When a character that cannot be used is set, the text is up to that character.
 - When the first character is a character that cannot be used, the text is that set for **File Name**.
- The operation when the **Set limit on files** check box is selected is as follows.
 - The files are output up to the set limit, and then for additional files, the new files are saved by discarding the old files in order of the oldest first.
 - If the number of files saved on the external memory device already exceeds the limit when operation starts, the number of files at that time is the limit. From there the data is discarded in order from the oldest data and replaced with new data with each file output.
- The following operations are as follows if the **Realtime Output** check box is selected.
 - Even if the data is outputted forcibly, the real time output period (3 minute interval) is not reset.
 - While data is being output with the real time output function, the file is not output when the value of the **Realtime Output** device address is 1.
 - Even when output has finished, the value of device address does not automatically change to 0.
- Deleting the Data Log data in the data storage area deletes the file (.BIN) saved in the external memory. For details about the BIN file, refer to "Save Data Log Data and Display in Line Chart or Data Log Display".
 - Operations to delete all files (.BIN)
 - Click **Clear** on the **Online** tab, and then click **All** or **Data Log Data**.
 - Executes **Clear All Log Data** configured in the Data Log Settings.
 - Clears the Data Log data when the project data is downloaded.
 - Operations to delete target files (.BIN)
 - Executes **Clear Log Data** configured in the Individual Settings of the Data Log Settings.



- The function to sample data operates when Data Log data is being saved to the external memory device.
 - The batch output or real time output status of the Data Log data can be checked with the value of HMI Special Internal Relay LSM35. When the data starts to be written to the external memory device, the value of device address is 1. When writing is complete, the value is 0.
 - The methods to erase Data Log files saved on the external memory device are as follows.
 - To erase files during operation using parts, on the **External Memory Device** tab on the **Project Settings** dialog box, select the **Remove Files** check box and the **All Data Log data** check boxes, and then configure the trigger device address. Assign that trigger device address to a part.
 - To erase files with WindO/I-NV4, click **Clear** on the **Online** tab, and then click **Stored Data in External Memory Device** to open the **Clear Data** dialog box. Select the **Data Log Data** check box and click **OK**.
 - To erase files on the HG5G/4G/3G/2G-V, HG4G/3G and HG2G-5F, go to the System Mode - File Manager. In the File Manager, select the files to be deleted by pressing **DEL**.
-

Output Data File Name

The file name format is as follows.

File Name Value of Device Address_YYMMDD_hhmmss.CSV

- File Name: The text entered in **File Name** or the text entered according to the value of the device address set by **Specify File Name by Value of Device Address**
- Value of Device Address: The lower 3 digits of the value of the device address configured by **Add Device Address data to File Name**
- YYMMDD: The year, month, and day of the month set on **Add Time Stamp**
- hhmmss: The hour, minute, and second of the time configured on **Add Time Stamp**

■ **Example 1**

Item	Setting	
File Name	LOGO01	
Add value of Device Address to File Name	(File Name Device Address) is LDR200	LDR200 value: 123
Add Time Stamp	YY+MM	Date when data was output: September 2013

Result: The file name is "LOGO01123_1309.CSV".

■ **Example 2**

Item	Setting	
Specify File Name by Value of Device Address	(File Name Device Address) is LDR100 Text to set is "IDEC"	LDR100 value: 4944 (Hex) LDR101 value: 4543 (Hex) LDR102 value: 0000 (Hex)
Add value of Device Address to File Name	(File Name Device Address) is LDR200	LDR200 value: 123
Add Time Stamp	YY+MM+DD+HH+MM+SS	Date and time when data was output: September 15 2013 at 23:30:50

Result: The file name is "IDEC123_130915_233050.CSV".

● Data Tab

The **Data** tab is used to configure the data to sample.

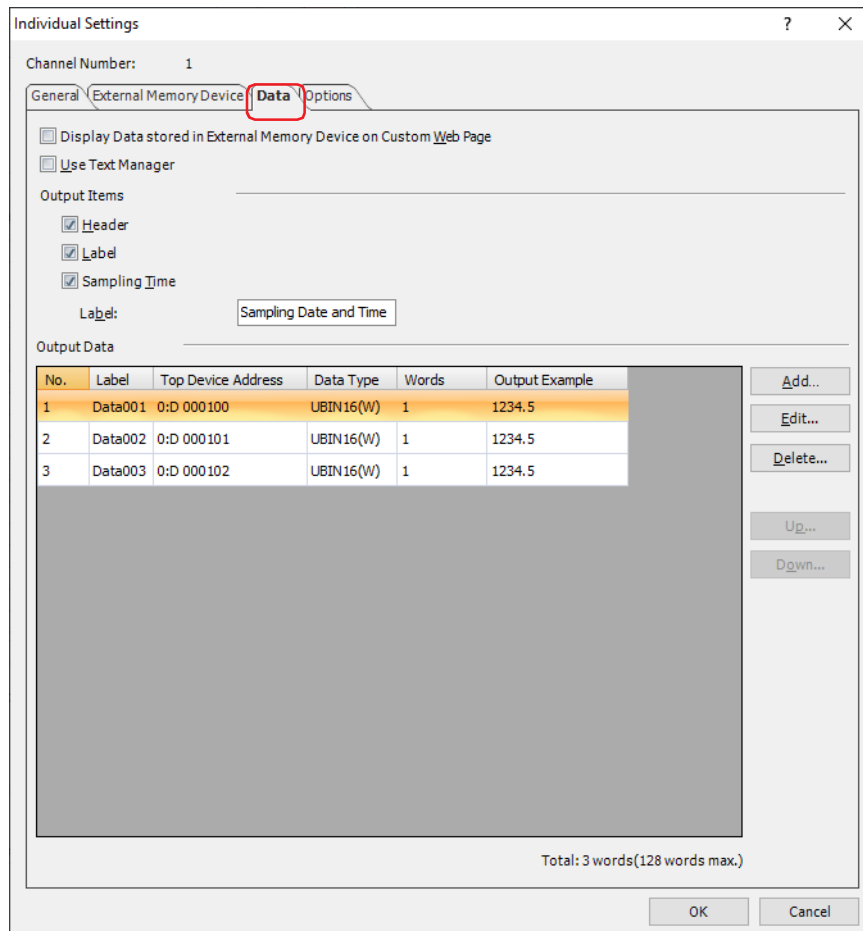

■ Display Data stored in External Memory Device on Custom Web Page

Select this check box to display the data stored in external memory device on Custom Web Page.

■ Use Text Manager

Select this check box to use text registered in the Text Manager for labels when outputting data as CSV.

■ Output Items

Select the output items when data is output as CSV. Select the check boxes of the items to output.

Header, Label, Sampling Time

When **Label** is selected, specifies the label to display in the sampling time column when outputting data as CSV.

Label(Text ID): Specifies the Text Manager ID number (1 to 32000) when text registered in Text Manager are used for labels.

Click to open Text Manager where you can edit the text.

This option is only enabled if you select the **Use Text Manager** check box.

Label: Enter the text to display in the label. The maximum number is 40 characters.

Text can only be entered when the **Use Text Manager** check box is cleared. The registered text is displayed when a text ID is specified.

■ Output Data

Output Data is used to configure the details of the data to sample for each data number in the selected channel.

No.: Shows the data numbers for the registered data. Double clicking the cell displays the **Edit Data** dialog box. The data number cannot be edited. For details, refer to "Add Data Dialog Box and Edit Data Dialog Box" on page 14-28.

- Text ID:** Shows the Text Manager ID number when text registered in Text Manager is used for labels. Double clicking the cell allows you to edit the text.
Text ID is only displayed when you select the **Use Text Manager** check box.
- Label:** Shows the text to display as labels when data is output as CSV. When the **Use Text Manager** check box is cleared, double clicking the cell allows you to edit the label. The maximum number is 40 characters. The default label is "Data" and the data number.
Example: Data001
If the **Use Text Manager** check box is selected, the text of the specified text ID is displayed. Double clicking the cell displays Text Manager where you can edit the text.
- Top Device Address:** Shows the starting device address of the word devices that will be read for sampling data. Double clicking the cell displays the **Edit Data** dialog box where the device address can be edited. For details, refer to "Add Data Dialog Box and Edit Data Dialog Box" on page 14-28.
- Data Type:** Shows the data type for numerical values when data is output as CSV. Double clicking the cell displays the **Edit Data** dialog box where you can edit the data settings. For details, refer to "Add Data Dialog Box and Edit Data Dialog Box" on page 14-28.
- Words:** Shows the number of words of word devices that will be read (1 to 128). Double clicking the cell displays the **Edit Data** dialog box. For details, refer to "Add Data Dialog Box and Edit Data Dialog Box" on page 14-28.
- Output Example:** Shows an output example of the data when data is output as CSV. Double clicking the cell displays the **Edit Data** dialog box. For details, refer to "Add Data Dialog Box and Edit Data Dialog Box" on page 14-28.

■ Add

Registers the data settings to the selected channel.

Click this button to display the **Add Data** dialog box. The details configured on the **Add Data** dialog box are registered for all the data.

For details, refer to "Add Data Dialog Box and Edit Data Dialog Box" on page 14-28.

■ Edit

Changes the settings for the selected data.

Select the data and click this button to display the **Edit Data** dialog box. Change the data with the content set in the **Edit Data** dialog box.

For details, refer to "Add Data Dialog Box and Edit Data Dialog Box" on page 14-28.



To edit multiple numbers at one time, press and hold SHIFT or CTRL while you click the specific items to select multiple lines and click **Edit**. The content configured in the **Edit Data** dialog box is applied to all selected data settings.

■ Delete

Deletes the selected data.

Select a data and click this button.

■ Up

Shifts the selected settings upward in the list.

■ Down

Shifts the selected settings downward in the list.

■ Total: *n* words (128 words max.)

Shows the total number of words of data that will be sampled. (*n*: Total number of words)



The maximum number of words that can be configured for one channel is 128 words. However, if **Sampling Method is Always**, the total number of words in all channels is 128 words or less. For details, refer to "Sampling Method" on page 14-14.

Add Data Dialog Box and **Edit Data** Dialog Box

With the **Add Data** dialog box, the data is registered to the selected channel.

With the **Edit Data** dialog box, the selected data for the selected channel is registered or changed.

- **Number of Data**^{*1}

Specifies the number of items of data to add to the channel (1 to 128).

- **Data Number**^{*2}

Displays the data number for the selected data.

- **Label(Text ID)**

Specifies the Text Manager ID number (1 to 32000) when text registered in Text Manager are used for labels. For the **Add Data** dialog box, **Text ID** is automatically configured sequentially starting with the specified text ID.

Click to open Text Manager where you can edit the text.

Text ID can only be configured when you select the **Use Text Manager** check box.

- **Label**

Enter the text to display as the label when data is output as CSV. The maximum number is 40 characters.

This is displayed only when the **Use Text Manager** check box is cleared.

When **Number of Data** is 2 or higher, "Data+Number" is automatically entered.^{*1}

Example: Data001, Data002, Data003



Automatically entered labels cannot be edited here. Those labels can be edited by double clicking the cell to open the **Individual Settings** dialog box.

- **Data Type**

Select the data type for numerical values when data is output as CSV. For details, refer to Chapter 2 "1.1 Available Data" on page 2-1.

When **Float32(F)** is selected, the maximum number of digits is 10 for the integer part and 5 for the decimal part.

- **Top Device Address**

Specify the starting device address of the word devices that will be read for sampling data.

For the device address configuration procedure, refer to Chapter 2 "5.1 Device Address Settings" on page 2-70.

You can only specify the bit device when **Bit** is selected for **Data Type. Words** for the bit device is counted as one.

*1 Add Data dialog box only

*2 Edit Data dialog box only

■ Words

Reads the value of specified number of word device address from **Top Device Address** and output as CSV. Specifies the number of word devices to read (1 to 128).

This is displayed only when **String(S)** is selected for **Data Type**.

Example: When **Number of Data** is 2, **Top Device Address** of the data to register to Data Number 1 is LDR0000, and **Words** is 3

Device addresses used in Data Number 1: LDR0000, LDR0001, LDR0002

Device addresses used in Data Number 2: LDR0003, LDR0004, LDR0005

LDR0003 is registered as the starting device address of Data Number 2.

■ Display Type

Sets the display type for numerical values when data is output as CSV.

This is displayed only when **UBIN16(W)**, **BIN16(I)**, **UBIN32(D)**, **BIN32(L)**, **BCD4(B)**, **BCD8(EB)**, or **Float32(F)** is selected for **Data Type**.

Counting Method: Select the display type as **Decimal** or **Hexadecimal** for numerical values.

Digits: Specifies the digits to display. The range of digits that can be set varies based on the display type and data type. The digits that can be set are as follows.

Display Type	Data Type	Digits
Decimal display	UBIN16(W), BIN16(I)	1 to 5
	UBIN32(D), BIN32(L)	1 to 10
	BCD4(B)	1 to 4
	BCD8(EB)	1 to 8
	Float32(F)	1 to 10
Hexadecimal display	UBIN16(W)	1 to 4
	UBIN32(D)	1 to 8

Display Floating Point: Select this check box to display the decimal point.



When the **Display Floating Point** check box is selected and **UBIN16(W)**, **BIN16(I)**, **UBIN32(D)**, **BIN32(L)**, **BCD4(B)**, or **BCD8(EB)** is selected for **Data Type**, the source device is an integer, but the value is output with the decimal point added at the configured floating digits.

However, if **Float32(F)** is selected for **Data Type**, the source data is a decimal value.

Floating Digits: Specifies the number of digits for the fractional part of the decimal value out of the number of digits specified by **Digits**.

This option can only be configured when the **Display Floating Point** check box is selected. The range of digits that can be set for the fractional part varies based on the display type and data type. The range of digits that can be set for the fractional part is as follows.

Display Type	Data Type	Floating Digits
Decimal display	UBIN16(W), BIN16(I)	1 to Digits
	UBIN32(D), BIN32(L)	1 to Digits
	BCD4(B)	1 to Digits
	BCD8(EB)	1 to Digits
	Float32(F)	1 to Digits or 8
Hexadecimal display	UBIN16(W)	--
	UBIN32(D)	--

Floating Symbol: Selects the decimal point symbol from the following.

.(dot), **:(colon)**, **;(semicolon)**, **,(comma)**, **/(slash)**

This option can only be configured when the **Display Floating Point** check box is selected.

Example: When **Digits** is 4 and **Floating Digits** is 2

When **Floating Symbol** is **.(dot)** 12.34

When **Floating Symbol** is **/(slash)** 12/34

● Options Tab

To display the data saved in the data storage area as numerical values on the MICRO/I, copy this data to the specified internal device.

The screenshot shows the 'Individual Settings' dialog box with the 'Options' tab selected. The 'Copy Data Log Data' checkbox is checked. The 'Destination Device Address' is set to 'LDR 0005'. Under 'Starting Point', 'Specify by Value of Device Address' is selected with 'LDR 0006'. Under 'Number of Data', 'Value' is selected with a value of 5. Under 'Stored Order of Data', 'From Newest to Oldest' is selected. Under 'Target Data', 'Sampling Time' and 'Value of Device Address' are checked. 'Data Number' is 'Value', 'Start Number' is 1, and 'End Number' is 1. Under 'Trigger Condition', 'Device Address' is selected with 'LM 0003'. The 'OK' and 'Cancel' buttons are at the bottom right.

■ Copy Data Log Data

Select this check box to copy data to a device address.

Destination Device Address: Specifies the destination device address for copied data. You can only specify an internal device.

For the device address configuration procedure, refer to Chapter 2 "5.1 Device Address Settings" on page 2-70.

Starting Point

Selects the starting point of the data to copy.

Newest Data: Sets the starting point as the newest data.

Oldest Data: Sets the starting point as the oldest data.

Specify by Value of Device Address: Specifies which data from the oldest data to set as the starting point by the value of device address.

Specifies the source device address. You can only specify an internal device.

For the device address configuration procedure, refer to Chapter 2 "5.1 Device Address Settings" on page 2-70.

- Example: 1. For **Newest Data**, the starting point is the newest sampling time data.
 2. For **Oldest Data**, the starting point is the oldest sampling time data.
 3. For **Specify by Value of Device Address** and source device address: 3, the starting point is the third item of data from the oldest sampling time data.

Data log data

Sampling Time	Value
12/18/2011 17:44:10	20
12/18/2011 18:34:10	21
12/19/2011 19:24:43	22
12/19/2011 20:01:54	24
12/19/2011 21:39:21	26
12/20/2011 05:57:06	28

2. Oldest Data read starting point →

3. Specify by Value of Device Address read starting point (source device address: 3) →

1. Newest Data read starting point →

Number of Data

Selects the specification method for the amount of data to copy.

Value: Uses a constant value.
 Specifies the amount to copy (1 to 64).

Device Address: Uses a value of device address.
 Specifies the source device address. You can only specify an internal device.
 For the device address configuration procedure, refer to Chapter 2 "5.1 Device Address Settings" on page 2-70.



The maximum amount of data that can be copied to the internal device is 64.

Stored Order of Data

Selects the order to copy data.

From Newest to Oldest: Of the data to copy, copies from the start point in order of the newest data first.

From Oldest to Newest: Of the data to copy, copies from the start point in order of the oldest data first.

Example: When **Starting Point** is **Newest Data** and **Number of Data** is 3, data is copied in the following order starting from device address LDR10 configured in **Destination Device Address**.

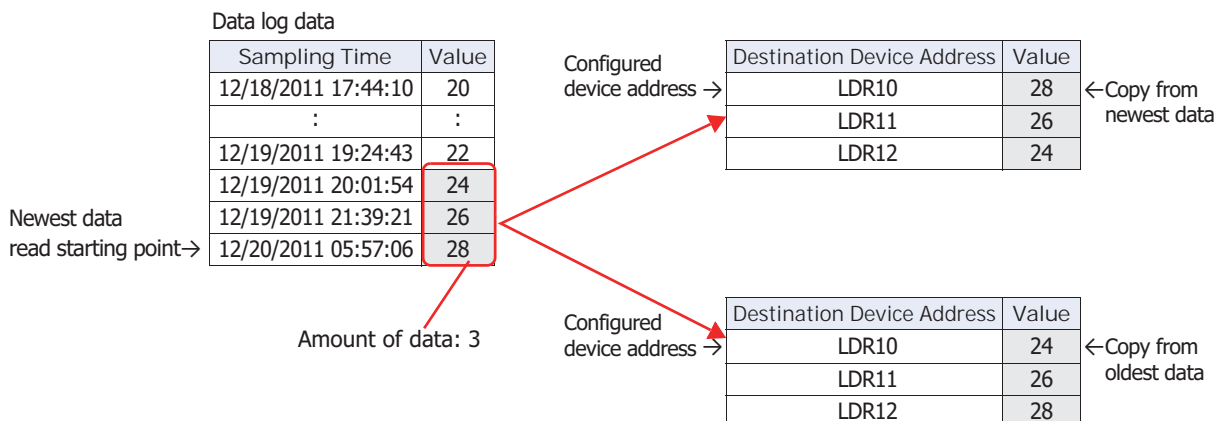

■ Target Data

Selects the data to copy from the Data Log data.

Sampling Time: Select this check box to copy the sampling time data from the Data Log data. When this check box is selected, values of device addresses are copied in order from the data for data number 1.

Value of Device Address: Select this check box to copy the value of device address from the Data Log data.

Data Number: Selects the specification method for the data number of the value to copy.

Value: Uses a constant value.

Device Address: Uses a value of device address.

Start Number: Of the data to copy, specifies the data number of the data to start copying.

If you select **Value**, specify the data number (1 to 128).

If you select **Device Address**, specify the source device address. You can only specify an internal device. For the device address configuration procedure, refer to Chapter 2 "5.1 Device Address Settings" on page 2-70.

When the **Sampling Time** check box is selected, the data number is 1. This cannot be changed.

End Number: Of the data to copy, specifies the data number of the data to end copying.

If you select **Value**, specify the data number (1 to 128).

If you select **Device Address**, specify the source device address. You can only specify an internal device. For the device address configuration procedure, refer to Chapter 2 "5.1 Device Address Settings" on page 2-70.

Example: When **Start Number** is 2 and **End Number** is 4, data 2 to 4 is the copy target.

		Start No.		End No.	
Data No.:	1	2	3	4	5
	↓	↓	↓	↓	↓
Sampling Time	Data 1	Data 2	Data 3	Data 4	Data 5
10/01/2011 12:34:56	100	60	240	60	240
10/02/2011 03:45:12	200	80	450	80	450

Copy target

■ Trigger Condition

Selects the condition to start copying.

Always: Copies each time the data is updated.

Device Address: Specifies the device address that triggers the start of copying the data. Copies the data when the value of the specified device address changes from 0 to 1.

For the device address configuration procedure, refer to Chapter 2 "5.1 Device Address Settings" on page 2-70.

4 Using the Data

HG2J-7U HG5G-V HG4G-V HG4G HG3G-V HG3G HG2G-V HG2G-5F HG2G-5T HG1G HG1P

4.1 Displaying the Data in the Line Chart

You can display the sampled data in the Line Chart.

- 1 On the **Home** tab, in the **Parts** group, click **Charts**, and then click **Line Chart**.

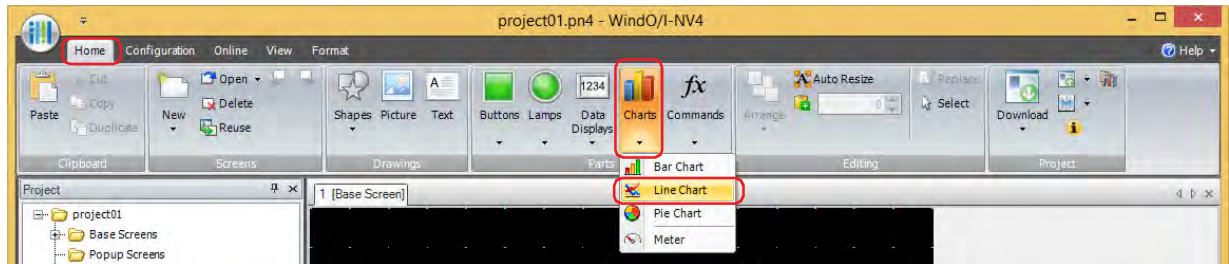

- 2 Click a point on the edit screen where you wish to place the Line Chart.
- 3 Double-click the placed Line Chart and a Properties dialog box will be displayed.

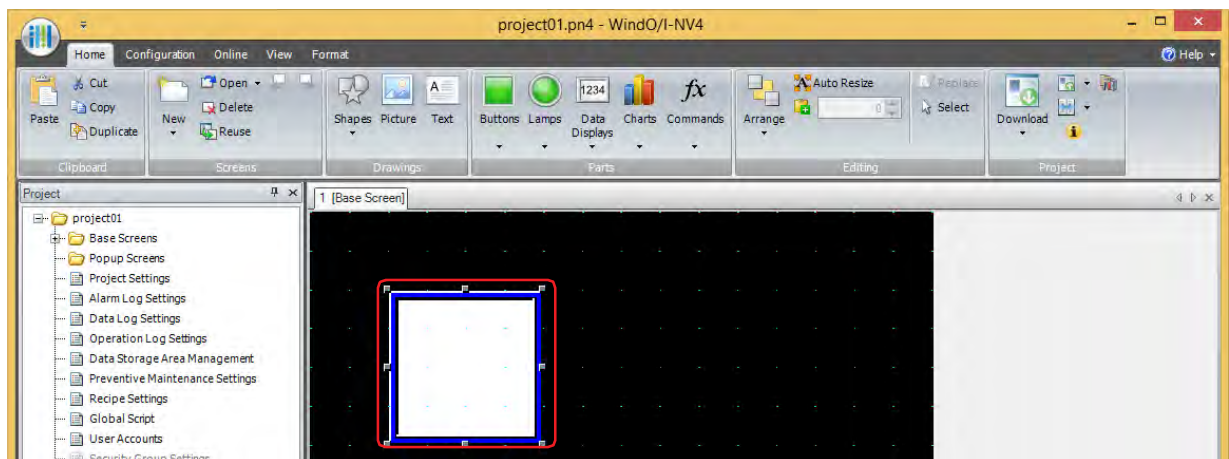

- 4 On the **General** tab, select **Chart Type** as **Log Trend (Normal)** or **Log Trend (Pen Recorder)**.

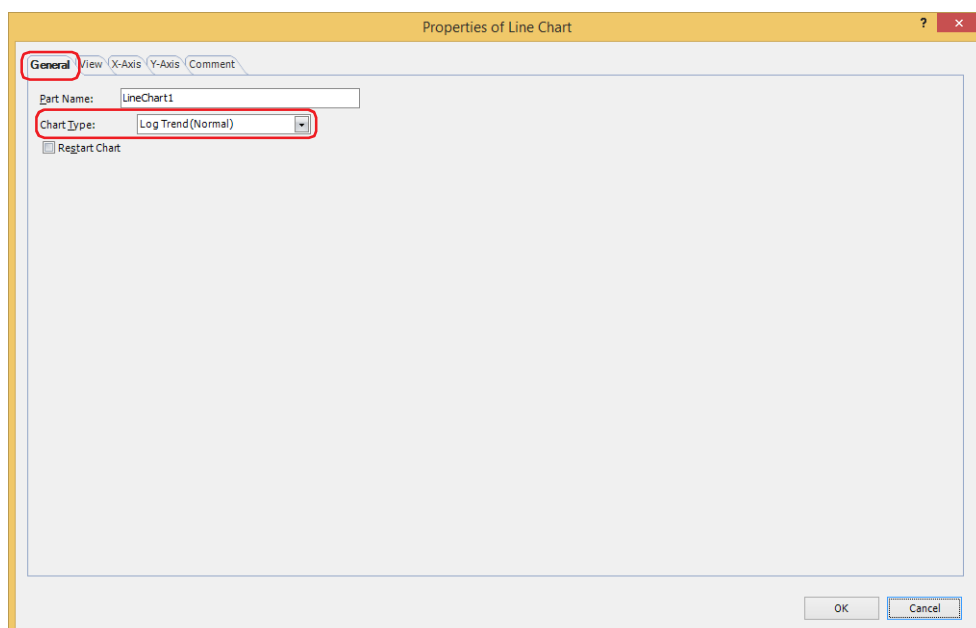

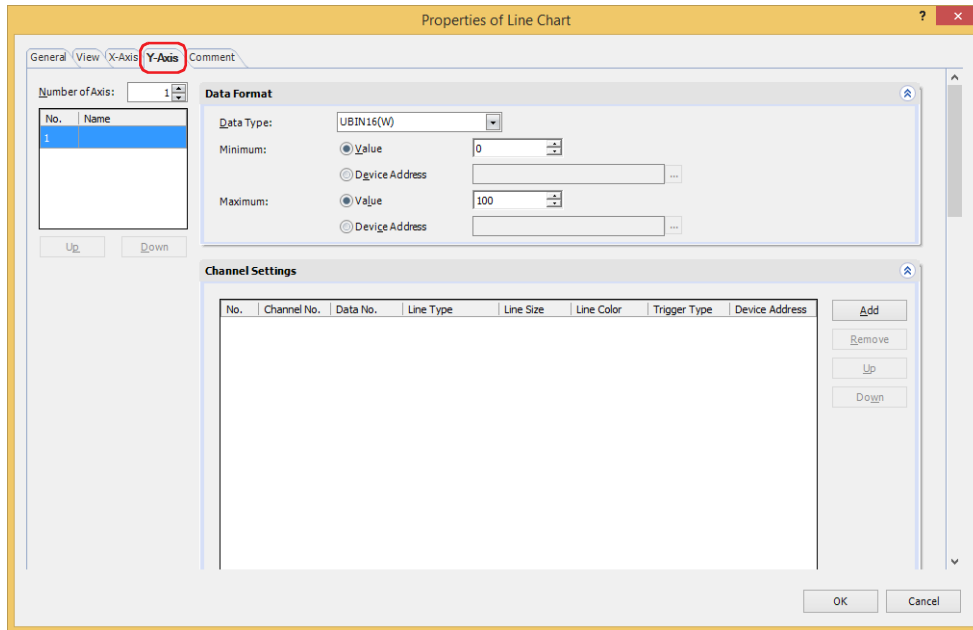
5 Click the **Y-Axis** tab.6 Specify the number (1 to 4) of Y-axis in **Number of Axes**.7 Selects the Y-axis for to configure in the **(Y-Axis)** and enters the name of the Y-axis.

The maximum number is 40 characters.

8 Click **Add** to add a channel to the list.

The total of all the Y-axis is 20 channels maximum.

9 Configures **Channel No.**, **Data No.**, **Line Type**, **Line Size**, **Line Color** and **Trigger Type** for the data to display on the chart.

The channel number and the data number can be checked on the **Data Log Settings** dialog box.

When **While ON** is selected as **Trigger Type**, displays the graph when the value of device address is 1. Specifies the bit device or the bit number of the word device in **Device Address** to serve as condition.

Click  to display the Tag Editor. For the device address configuration procedure, refer to Chapter 2 "5.1 Device Address Settings" on page 2-70.

The data to display in the chart is registered in the channel number (Ch1 to Ch20) for the chart selected in **Channel Settings**.

10 Repeat steps 7 and 9 to register the data to display in the chart.

11 Click **OK**.

The Properties dialog box closes.

This concludes configuring the Line Chart.

4.2 Displaying Data on the Data Log Display

Lists the Data Log data saved in the data storage area and the external memory device.

- 1 On the **Home** tab, in the **Parts** group, click **Data Displays**, and then click **Data Log Display**.

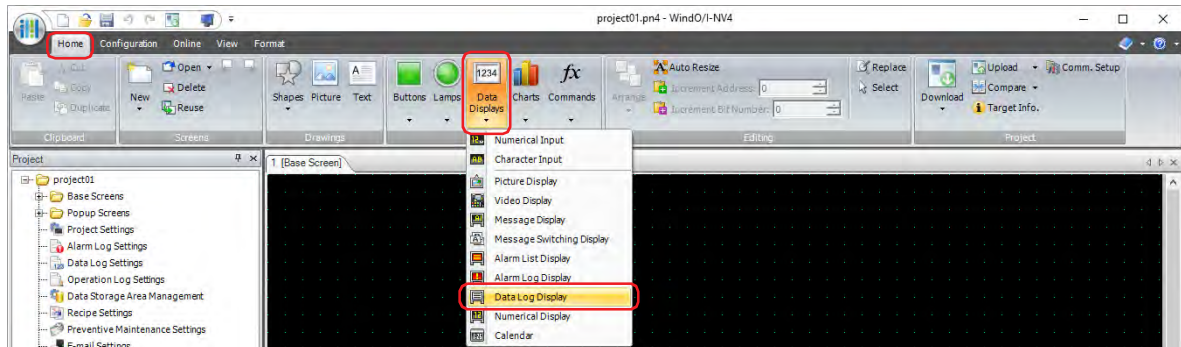

- 2 Click a point on the edit screen where you wish to place the Data Log Display.
- 3 Double-click the placed Data Log Display, and a Properties dialog box will be displayed.

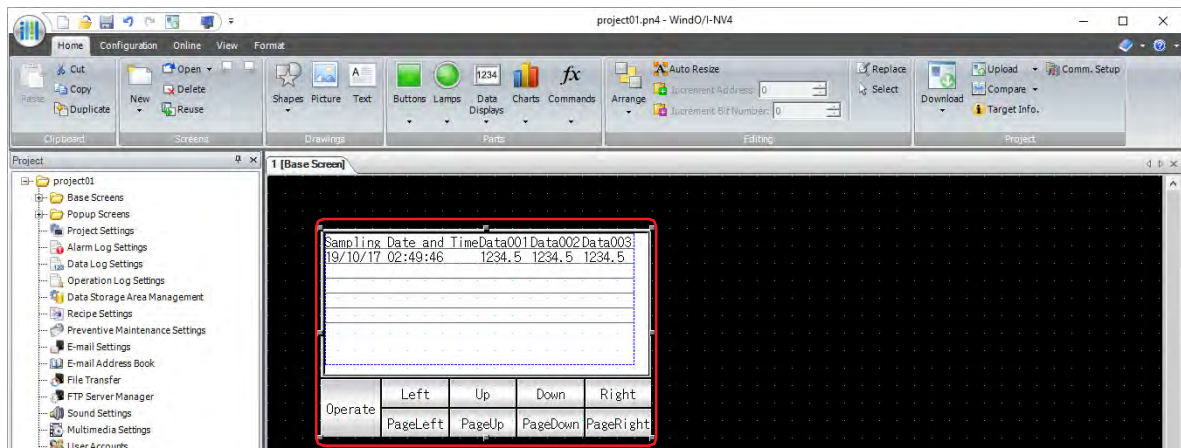

- 4 Click the **Log** tab.

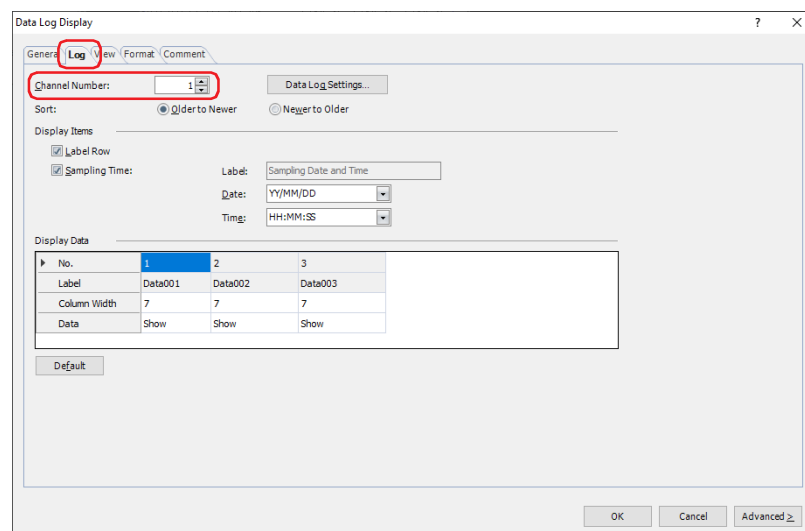

- 5 Configures the **Channel Number** for the data to display on the Data Log Display.
The channel number can be checked on the Data Log Settings dialog box.
- 6 Click **OK**.
The Properties dialog box closes.
This concludes configuring the Data Log Display.

4.3 Displaying Data as Numerical Values

You can display data in the Numerical Display by copying data saved in the data storage area to an internal device according to the conditions configured with the **Options** tab on the **Individual Settings** dialog box.

● Copying Data to Internal Devices

Copying Sampling Time Data

Sampling time data is copied as a BCD value to the six sequential device addresses starting with the device address configured by **Destination Device Address**.

The sampling time data is copied in year, month, day, hour, minute, second order regardless of the **Stored Order of Data** setting.

■ Example

When the sampling time 10/01/2011 12:01:30 is copied to the destination device address

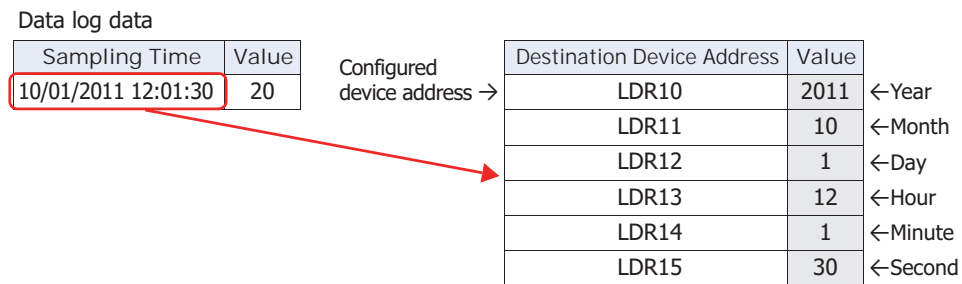

Data Read Start Position and Copy Order of Data to the Destination Device Address

The data to copy and the order differs according to the **Starting Point** and the **Stored Order for Data** settings.

■ Example 1

Copying three items of the newest data in the Data Log to the destination device address

Item	Setting
Destination Device Address	LDR10
Starting Point	Newest Data
Number of Data	3
Stored Order of Data	From Newest to Oldest

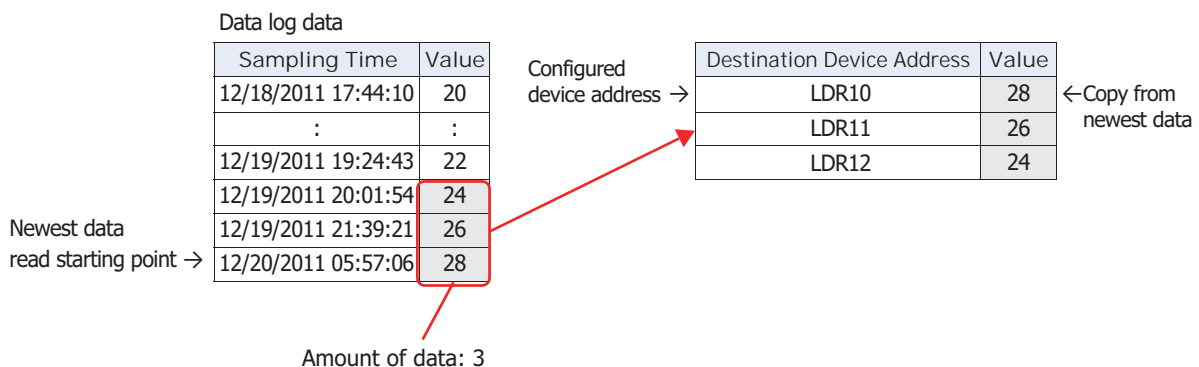

■ Example 2

Copying three items of the newest data in the Data Log in order from the oldest to the destination device address

Item	Setting
Destination Device Address	LDR10
Starting Point	Newest Data
Number of Data	3
Stored Order of Data	From Oldest to Newest

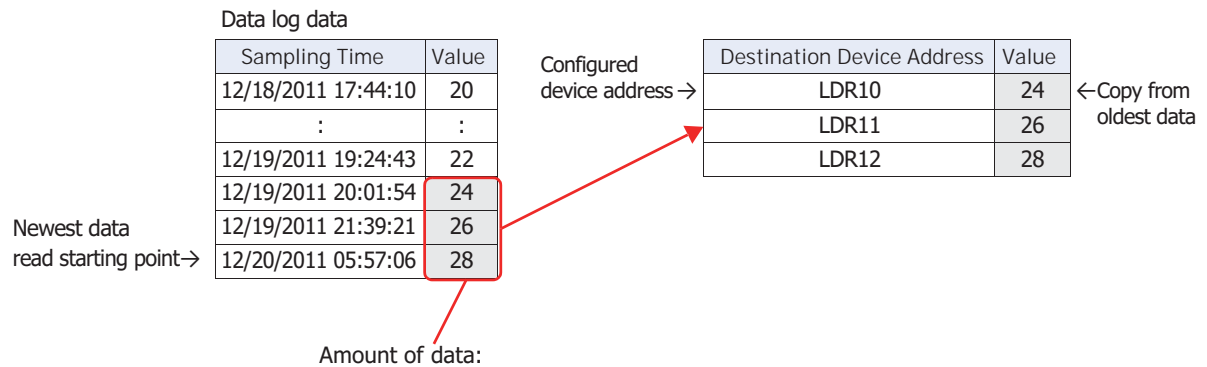

■ Example 3

Setting the starting point to the fourth item of the oldest data in the Data Log and copying three items of data from the newest to the destination device address

Item	Setting
Destination Device Address	LDR10
Starting Point	Specify by Value of Device Address (value is 4)
Number of Data	3
Stored Order of Data	From Newest to Oldest

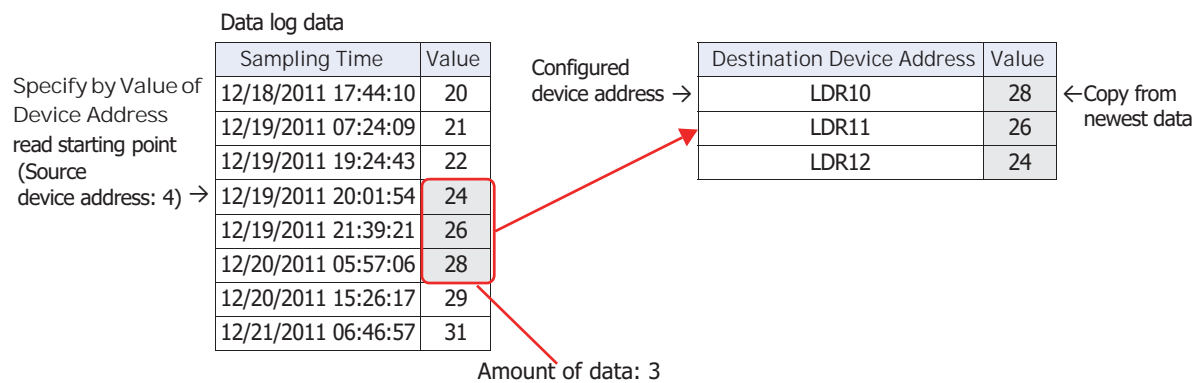

Copying Data when UBIN32(D), BIN32(L), BCD8(EB) or Float32(F) is Selected as the Data Type

When one of **UBIN32(D)**, **BIN32(L)**, **BCD8(EB)** or **Float32(F)** is selected for **Data Type** on the **Data** tab in the **Individual Settings** dialog box, two destination device addresses are required for a single item of data.

■ **Example**

Copying the newest data in the Data Log with the **Data Type** selected as **UBIN32(D)** to the destination device address LDR10.

Item	Setting
Destination Device Address	LDR10
Starting Point	Newest Data
Number of Data	2
Stored Order of Data	From Newest to Oldest

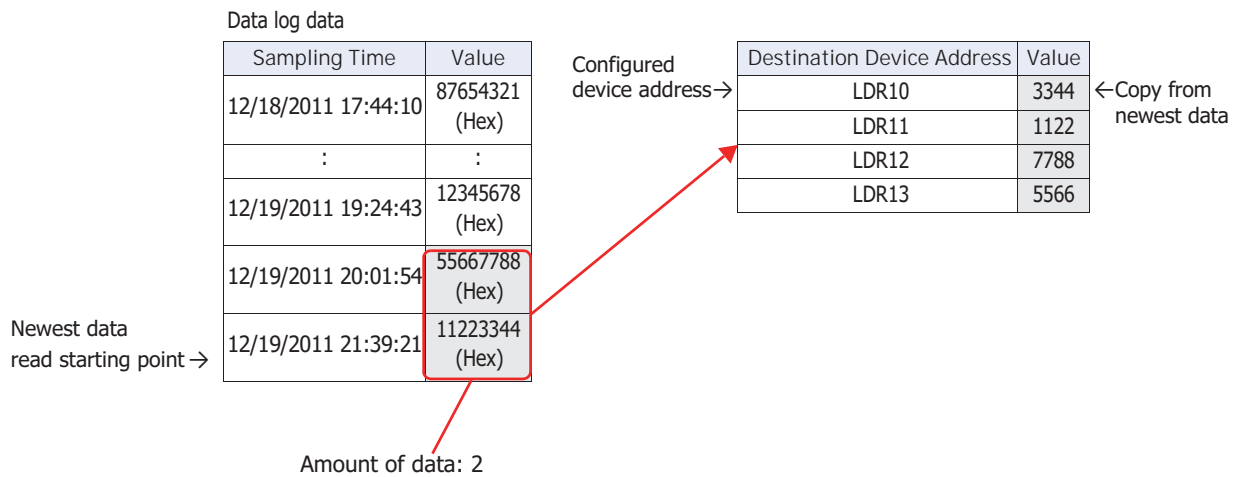

The data copy order of the device address selected from **UBIN32(D)**, **BIN32(L)**, **BCD8(EB)**, or **Float32(F)** as the Data type can be configured in the **Storage Method of 32-bit Numerical Data for the Internal Devices** on the **System** tab in the Project Settings dialog box or **Storage Method of 32-bit Numerical Data** on the **Communication Driver** tab. For details, refer to Chapter 4 "Storage Method of 32-bit Numerical Data for Internal Devices" on page 4-29, Chapter 4 "Storage Method of 32-bit Numerical Data" on page 4-48.

Copying Multiple Items of Data

When copying multiple items of data, first all the sampling times for the data are copied in order starting with the device address configured as the destination device address, then the values of device addresses for all the data are copied in order.

For example, data is copied in this order: first sampling time → second sampling time → ... → first data 1 value of device address → first data 2 value of device address → second data 1 value of device address → second data 2 value of device address and so on.

■ Example

The sampling time and values of device addresses from data start number 1 to end number 3 are copied to the destination device address as two items of data.

Item	Setting
Destination Device Address	LDR10
Starting Point	Newest Data
Number of Data	2
Stored Order of Data	From Oldest to Newest
Target Data	Sampling Time, Value of Device Address Data No.: Start No. 1, End No. 3

Data log data

	Sampling Time	Data 1	Data 2	Data 3	Data 4	Data 5
	10/01/2011 12:00:30	10	40	100	20	120
1.	10/01/2011 12:34:56	100	60	240	30	200
2.	10/02/2011 03:45:12	200	80	450	70	400

3. 4. 5.

← Newest Data read starting point

	Destination Device Address	Value	
	LDR10	2011	← Copy from oldest data
	LDR11	10	
	LDR12	01	
1.	LDR13	12	← First sampling time
	LDR14	34	
	LDR15	56	
	LDR16	2011	
2.	LDR17	10	← Second sampling time
	LDR18	02	
	LDR19	03	
	LDR20	45	
	LDR21	12	
3.	LDR22	100	← First data 1 value
	LDR23	200	← Second data 1 value
4.	LDR24	60	← First data 2 value
	LDR25	80	← Second data 2 value
5.	LDR26	240	← First data 3 value
	LDR27	450	← Second data 3 value

Configured device address →



When writing with the following settings, "Device range error" is displayed.

- **Starting Point** is 0 or a value larger than the amount of saved data
- **Start Number** is 0 or a value larger than **Data Number**
- **End Number** is 0 or a value larger than **Data Number**
- **Start Number** is a value larger than **End Number**

- **Displaying Data on the Numerical Display**

You can copy sampled data to an internal device and display it with the Numerical Display.

- 1 On the **Configuration** tab, in the **System Setup** group, click **Data Log**.

The **Data Log Settings** dialog box is displayed.

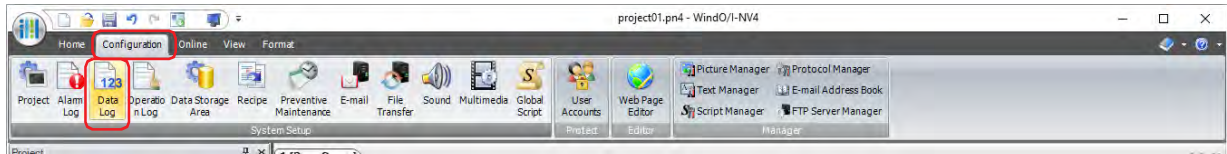

- 2 Under **Sampling Method**, select the condition that will be used by the MICRO/I to read data.

- **Always**

The values of the device addresses set for the data of each channel are always read. When the condition of writing to the data storage area is satisfied, the values that were read at that point in time are written to the data storage area.

- **While satisfying the condition of writing to data storage area**

The values of the device addresses set for the data of each channel are read when the condition of writing to the data storage area is satisfied, and those values are written to the data storage area.

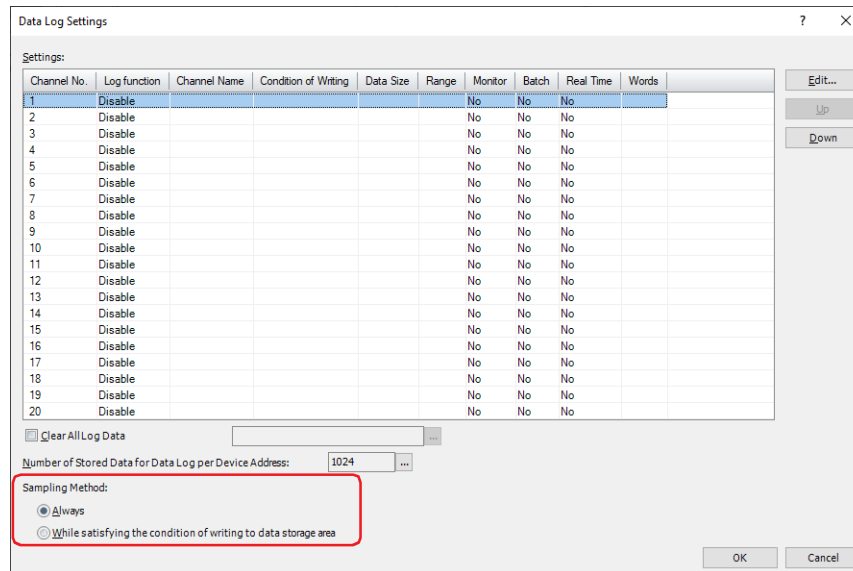

- 3 Under **Settings**, select the channel number for the data to display numerical values of on the Numerical Display, then click **Edit**.

The **Individual Settings** dialog box is displayed.

- 4 Select **Enable** for **Log function** on the **General** tab and configure **Channel Name**, and **Condition of Writing to Data Storage Area**.

- 5 Under **Output Data** on the **Data** tab, set **Top Device Address**, Data Type, and the other settings for each item of data.

- 6 Click the **Options** tab.

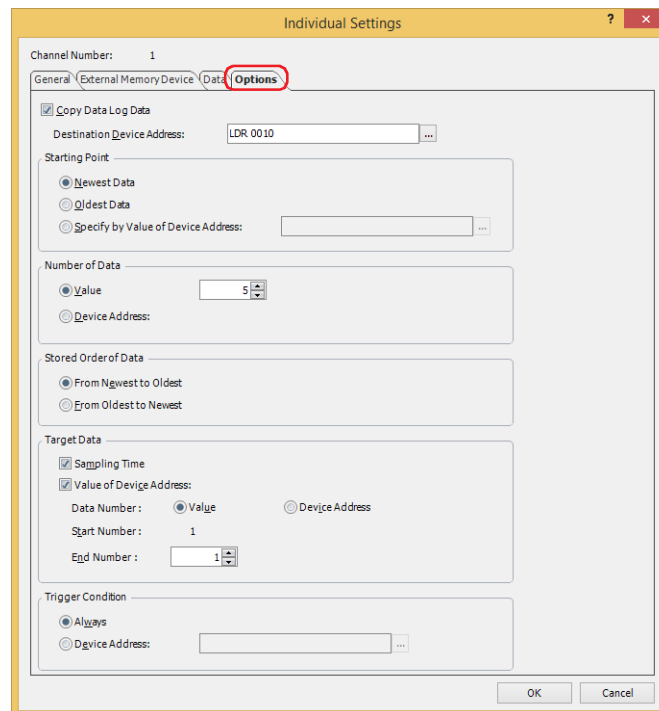

- 7 Select the **Copy Data Log Data** check box.

- 8 Specify the destination device address for the copied data in **Destination Device Address**.

You can only specify an internal device.

Click to display the Tag Editor. For the device address configuration procedure, refer to Chapter 2 "5.1 Device Address Settings" on page 2-70.

- 9 Select the data that is the start point for copying data in **Starting Point**.

■ **Newest Data**

Set the starting point to read as the newest data.

■ **Oldest Data**

Set the starting point to read as the oldest data.

■ **Specify by Value of Device Address**

Specifies which data from the oldest data to set as the starting point to read by value of device address, and sets that data as the starting point to read.

Specifies the source device address. You can only specify an internal device.

Click to display the Tag Editor. For the device address configuration procedure, refer to Chapter 2 "5.1 Device Address Settings" on page 2-70.

10 Select the specification method for the amount of data to copy in **Number of Data**.

- **Value**

Use a constant.

Specifies the amount to copy (1 to 64).

- **Device Address**

Use a word device.

Specifies the source device address. You can only specify an internal device.

Click to display the Tag Editor. For the device address configuration procedure, refer to Chapter 2 "5.1 Device Address Settings" on page 2-70.



The maximum amount of data that can be copied to the internal device is 64.

11 Select the order to copy data in **Stored Order of Data**.

- **From Newest to Oldest**

Of the data to copy, copies from the start point in order of the newest data first.

- **From Oldest to Newest**

Of the data to copy, copies from the start point in order of the oldest data first.

12 Select the data to copy from the data in **Target Data**.

Select the **Sampling Time** check box to copy the sampling time data from the data.

Select the **Value of Device Address** check box to copy the value of device address from the data. When not copying the value of device address, proceed to step **16**.

13 Select the specification method for the data number to copy the value in **Data Number**.

- **Value**

Use a constant.

- **Device Address**

Use a word device.

14 Specify the data number of the data to start copying out of the data to copy with **Start Number**.

If you select **Value**, specify the data number (1 to 128).

If you select **Device Address**, specify the source device address. You can only specify an internal device. Click to display the Tag Editor. For the device address configuration procedure, refer to Chapter 2 "5.1 Device Address Settings" on page 2-70.

When the **Sampling Time** check box is selected, the data number is 1. This cannot be changed.

15 Specify the data number of the data to end copying out of the data to copy with **End Number**.

If you select **Value**, specify the data number (1 to 128).

If you select **Device Address**, specify the source device address. You can only specify an internal device. Click to display the Tag Editor. For the device address configuration procedure, refer to Chapter 2 "5.1 Device Address Settings" on page 2-70.

16 Select the condition to start copying in **Trigger Condition**.

- **Always**

Copies each time the data is updated.

- **Device Address**

Specifies the device address that triggers the start of copying the data. Copies the data when the value of the specified device address changes from 0 to 1. Click to display the Tag Editor. For the device address configuration procedure, refer to Chapter 2 "5.1 Device Address Settings" on page 2-70.

17 Click **OK** to close the **Individual Settings** dialog box.

You are returned to the **Data Log Settings** dialog box.

18 Click **OK**.

The **Data Log Settings** dialog box closes.

19 On the **Home** tab, in the **Parts** group, click **Data Displays**, and then click **Numerical Display**.

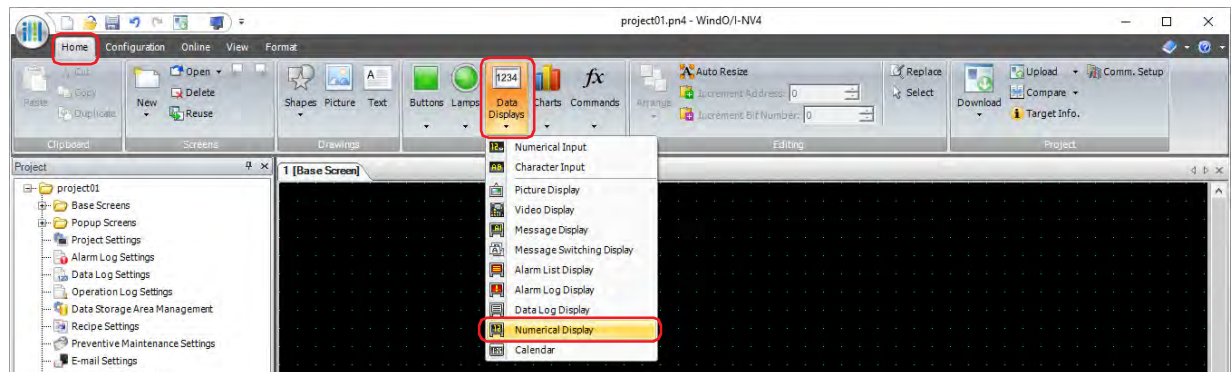

20 Click a point on the edit screen where you wish to place the Numerical Display.

21 Double-click the placed Numerical Display and a Properties dialog box will be displayed.

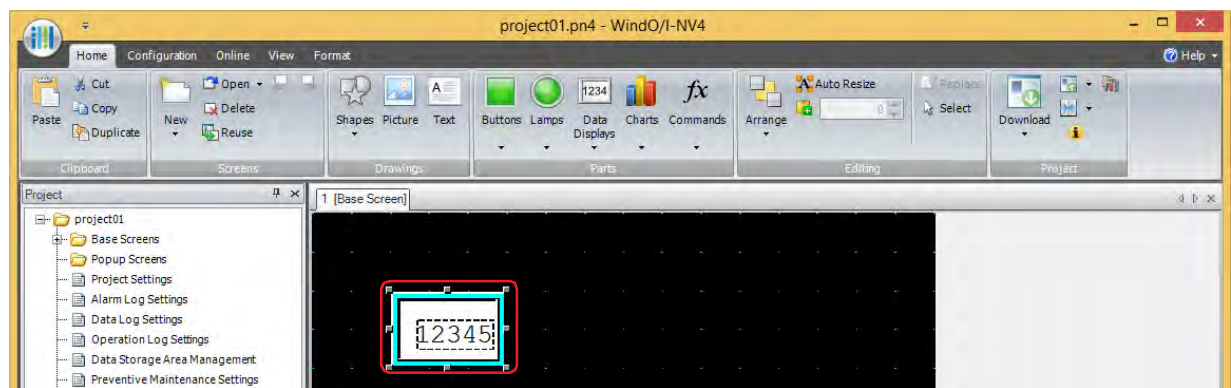

22 Select the display type for the copied data with **Display Type** on the **General** tab.

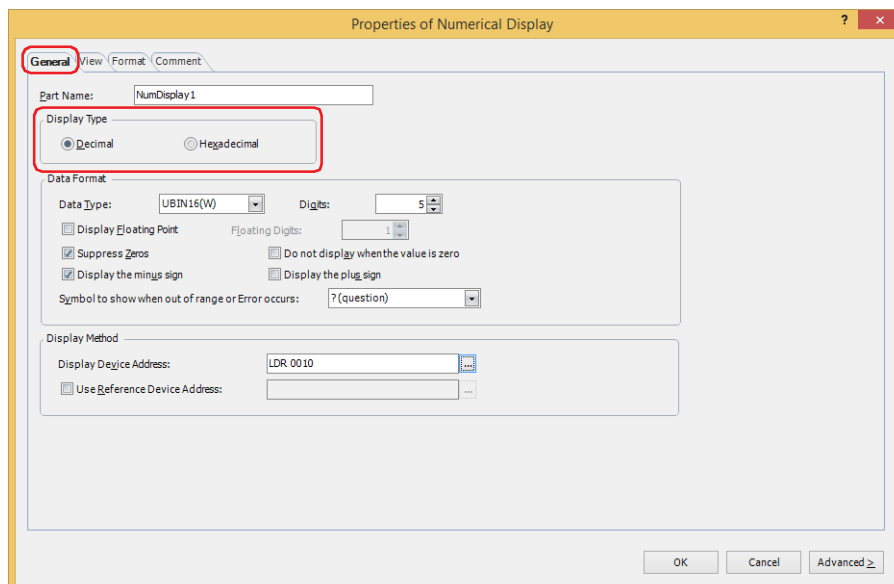

23 Select the data type for the copied data in **Data Type** under **Data Format**.

24 Specify the number of digits to display in **Digits** under **Data Format**.

The range of digits that can be set differs according to the display type and data type.

25 Specify the source device address for the copied data in **Display Device Address** under **Display Method**.

For sequential device addresses of the amount of data to copy starting with **Destination Device Address** configured on the **Options** tab on the Data Log Settings **Individual Settings** dialog box, set **Display Device Address** for each Numerical Display to those device addresses.

Example: When **Destination Device Address** is LDR10, **Number of Data** is 3

Specify three Numerical Displays with **Display Device Address** specified as LDR10, LDR11, LDR12

Click  to display the Tag Editor. For the device address configuration procedure, refer to Chapter 2 "5.1 Device Address Settings" on page 2-70.

26 Click **OK**.

The Properties dialog box closes.

27 Repeat step 19 through 26 to configure the Numerical Displays for the amount of data to copy.

This concludes configuring the Numerical Display.

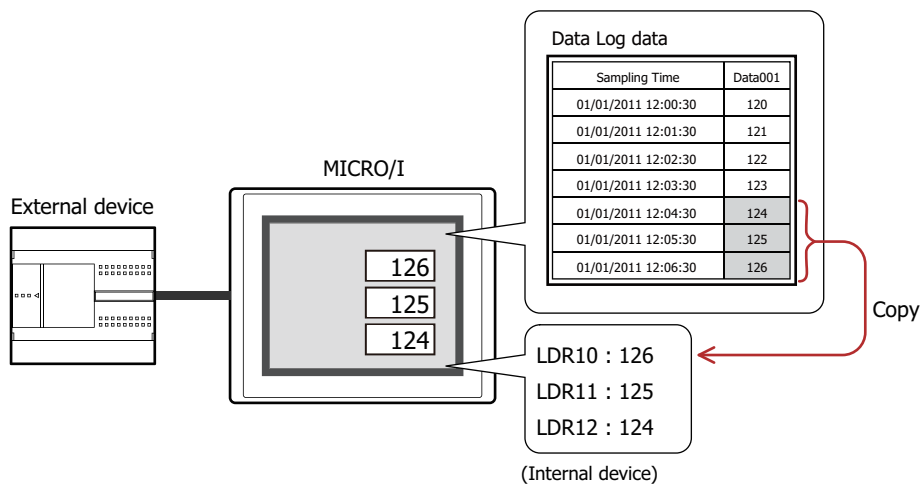

4.4 Saving the Data as a CSV File

● Saving the Data as a CSV File

The Data Log data can be saved to the external memory device*1 as a CSV file or uploaded to a computer.

The procedure to save the data is as follows.

- To save the data to an external memory device, click **Data Log** on the WindO/I-NV4 **Configuration** tab to display the **Data Log Settings** dialog box. Select a channel number to save to the external memory device and click **Edit** to display the **Individual Settings** dialog box. Select an output method check box on the **External Memory Device** tab and configure the items. The data can be saved to the External Memory Device folder on the external memory device. For details, refer to "External Memory Device Tab" on page 14-18.
- To upload the data to a computer, click on ▼ to the right of  (Upload) on the toolbar in Data File Manager, and then click the **Upload All Log Data** or **Upload Data Log Data** to open the Browser For Folder dialog box. Specify the location to save the file and click **OK** to save the file to the specified folder. For details, refer to the Data File Manager User's Manual.

● Data Structure and Output Example

The data structure of the output file is as follows. The data structure for files output with batch output and real time output is the same.

Bold items are replaced by the Data Log settings, the sampled data, the running project name, and WindO/I-NV4 version number.

Headers*2	"Project Name", " Project name ", " Version number " "File Type", " Log type " "Channel No.", " Channel number " "Source", " Top Device Address (data number 1) " "Sampling Method", " Condition of Writing to Data Storage Area (type) " " Condition of Writing to Data Storage Area (label) ", " Condition of Writing to Data Storage Area (configuration details) " Blank row
Label row*3	" Label (sampling time) *4", " Label (data number 1) ", " Label (data number 2) "... times the amount of data
Data row	" MM/DD/YYYY hh:mm:ss *4", Data number 1 data value , Data number 2 data value ... times the amount of data : :

Output example

"Project Name", "Dimmer Console", "1.7.0.0" "File Type", "Data Log Data" "Channel No.", "1" "Source", "LDR100" "Sampling Method", "Fixed Period" "Time[Sec]", "1" "Sampling Time", "Data001", "Data002" "08/23/2011 18:32:04", 171,234 : :	Data size of each row - 41 bytes - 29 bytes - 19 bytes - 20 bytes - 34 bytes - 17 bytes - 2 bytes - 37 bytes - 32 bytes
---	--

*1 USB flash drive inserted in USB1 for HG2J-7U, SD memory card for HG5G/4G/3G/2G-V, HG4G/3G and HG2G-5F, USB flash drive for HG2G-5T and HG1G/1P

*2 Only when the Header check box is selected on the Data tab in the Individual Settings dialog box

*3 Only when the Label check box is selected on the Data tab in the Individual Settings dialog box

*4 Only when the Sampling Time check box is selected on the Data tab in the Individual Settings dialog box



- The data size for each row is counted as 2 bytes for full-width characters, 1 byte for half-width characters, and 2 bytes for newlines. The total for each row is the total amount of space for the file.
- A space is inserted before the year in the data row.
- The display type for the date and time differs according to the language configured in **Project Settings**, on the **Project Details** tab, in **Language**.

Japanese: YYYY/MM/DD hh:mm:ss

Western, Simplified Chinese, Traditional Chinese, Hangul, Central European, Baltic, Cyrillic:
MM/DD/YYYY hh:mm:ss

- The output values of the data row will depend on **Data Type** of the data.

- When **Data Type** of the data is **String(S)**

The values of the set amount of words of device addresses stored from **Top Device Address** are converted to a string and output.

However, if NULL(00h) appears in the string, the characters after NULL(00h) are not output.

The order of characters output to the CSV file is set according to **Storage Method of String Data** on the **System** tab in the **Project Settings** dialog box.

Example: Starting device address: LDR0, number of words: 3

Stored values: LDR0=0x3132, LDR1=0x3334, LDR2=0x3536 => Output value: 123456

Stored values: LDR0=0x3132, LDR1=0x3300, LDR2=0x3435 => Output value: 123

If the string contains the following codes, the entire string will be enclosed with double quotation marks (") and output.

Comma (,)

Newline codes (CR, LF, and CR+LF)

Double quotation mark (")

If the string contains a double quotation mark ("), a double quotation mark (") will be added in front of it.

Example: Starting device address: LDR0, number of words: 3

Stored values: LDR0=0x312C, LDR1=0x3334, LDR2=0x0000 => Output value: "1,34"

Stored values: LDR0=0x310D, LDR1=0x3334, LDR2=0x0000 => Output value: "1[CR]34"

Stored values: LDR0=0x3122, LDR1=0x3334, LDR2=0x0000 => Output value: "1""34"

- When **Data Type** is **UBIN16(W)**, **BIN16(I)**, **UBIN32(D)**, **BIN32(L)**, **BCD4(B)**, **BCD8(EB)**, or **Float32(F)**

The value is output according to the setting of **Display Type**.

The zeros in the value are suppressed.

If the stored value exceeds the number of display digits, the upper portion of the value is cut and only the lower portion of the value is output for data types other than **Float32(F)** (source data: integer value). For **Float32(F)** (source data: decimal value), the upper value of the integer part and lower value of the decimal part are cut and the value is output in the number of display digits.

If an invalid number has been stored, #N/A is output.

If a comma (,) is used as the decimal point, the entire string is enclosed with double quotation marks (") and output.

Example: Starting device address: LDR0, number of words: 1

Stored value: LDR0=0x04D2

Data Type is **UBIN16(W)**, **Display Digits** is 5 => Output value: 1234

Data Type is **UBIN16(W)**, **Display Digits** is 2 => Output value: 34

Data Type is **UBIN16(W)**, **Display Digits** is 2, **Floating Digits** is 1, **Floating Symbol** is . (dot) => Output value: 3.4

Data Type is **UBIN16(W)**, **Display Digits** is 2, **Floating Digits** is 1, **Floating Symbol** is , (comma) => Output value: "3,4"

Data Type is **BCD4(B)**, **Display Digits** is 4 => Output value: #N/A

Example: Starting device address: LDR0, number of words: 2

Stored values: LDR0=0xA000, LDR1=0x0000

Data Type is **BIN16(I)**, **Display Digits** is 5 => Output value: -24576

Data Type is **BIN16(I)**, **Display Digits** is 2 => Output value: -76

Data Type is **BIN16(I)**, **Display Digits** is 2, **Floating Digits** is 1, **Floating Symbol** is . (dot) => Output value: -7.6

Data Type is **Float32(F)**, **Display Digits** is 10 => Output value: #N/A

Chapter 15 Operation Log Function

This chapter describes how to configure the Operation Log function and its operation on the MICRO/I.

1 Overview

HG2J-7U HG5G-V HG4G-V HG4G HG3G-V HG3G HG2G-V HG2G-5F HG2G-5T HG1G HG1P

1.1 How the Operation Log Function is Used

The Operation Log function records events that have occurred on the MICRO/I, including user operations such as pressing a button or changing the operation mode.

You can perform the following actions using the Operation Log function.

- Record turning on the MICRO/I power

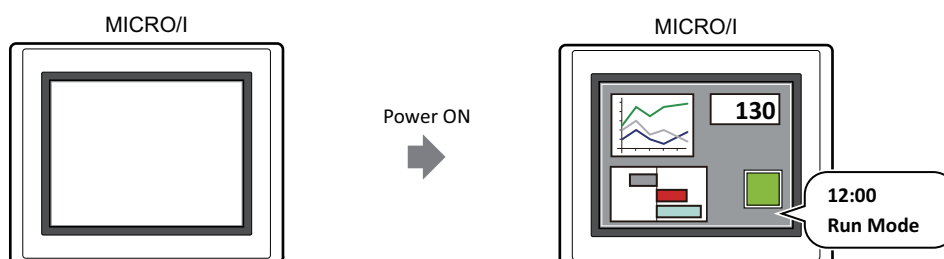

- Record switching the base screen

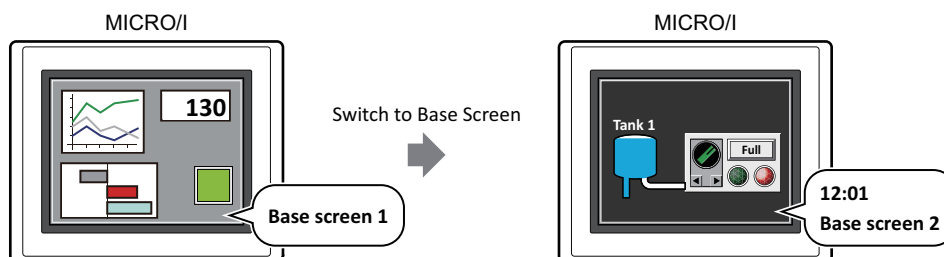

- Record changing the user

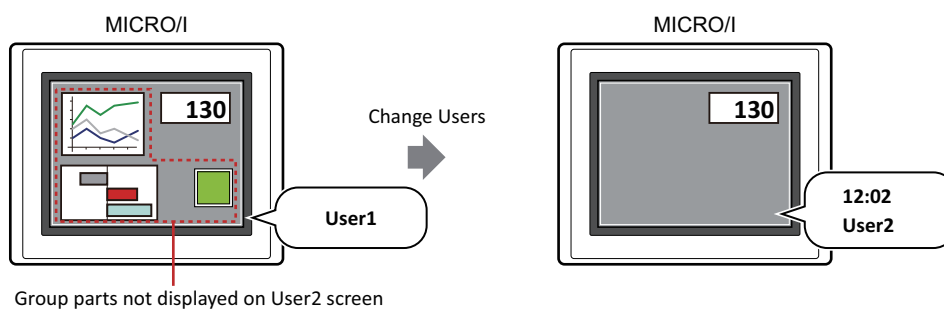

- Record changing the operation mode

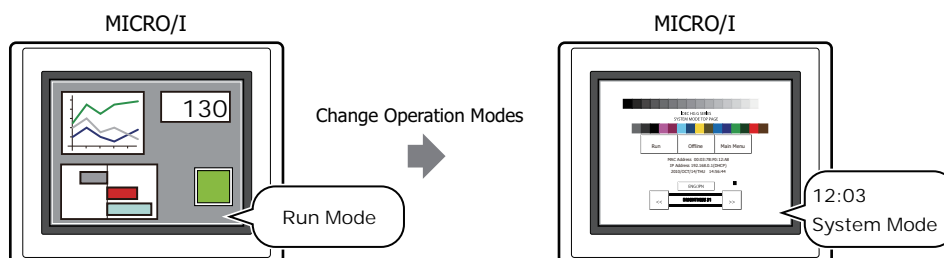

- Record pressing a touch switch

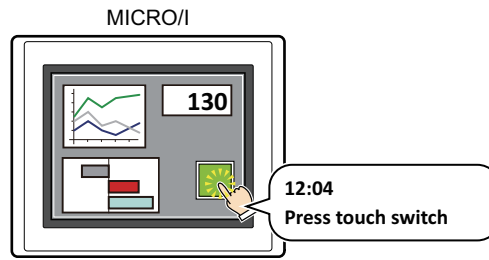

- Record writing a value to a device address by pressing a touch switch

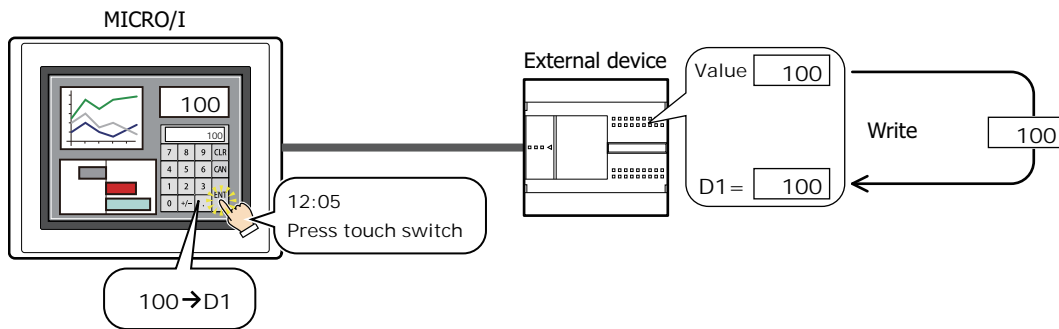

- Output Operation Log data to the external memory device^{*1}

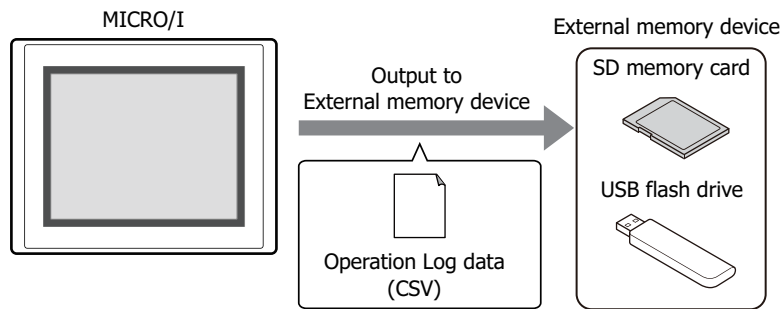

*1 USB flash drive inserted in USB1 for HG2J-7U, SD memory card for HG5G/4G/3G/2G-V, HG4G/3G and HG2G-5F, USB flash drive for HG2G-5T and HG1G/1P

1.2 Recorded Events

The recorded events are as follows.

■ Power ON

This operation is recorded when the MICRO/I power is turned on.

■ Switch to Base Screen

This operation is recorded by the following events.

- Switched the base screen by pressing the Goto Screen Button or a Multi-Button
- Switched the base screen by pressing the key button **Ref.** on the Alarm List Display or the Alarm Log Display
- Switched the base screen by executing the Goto Screen Command or a Multi-Command
- Switched the base screen by writing a screen number to System Area 1 address number + 0 (displayed screen number)

■ Change Users

This operation is recorded by the following events.

- Switched the user by entering a password on the Password Screen
- Switched the user by writing a value of device address
- Switched to the default user



- If User is selected in **Default User** in the **Security** dialog box, a **Change Users** event occurs when the power is turned on and when the operation mode is changed.
- If the **Switch to Base Screen** check box is selected, a **Switch to Base Screen** event also occurs when a **Change Users** event occurs.

■ Change Operation Modes

This operation is recorded by the following events.

- Switched to System Mode by pressing the Goto Screen Button or a Multi-Button
- Switched to System Mode by executing the Goto Screen Command or a Multi-Command
- Switched to System Mode by pressing **System Mode** on the Maintenance screen
- Switched to Run Mode from System Mode by pressing **Run** on the Top Page in the System Mode
- Switched to Monitor Mode from Run Mode by clicking **Start Monitor** on the WindO/I-NV4 **Online** tab
- Switched to Run Mode from Monitor Mode by clicking **Stop Monitor** on the WindO/I-NV4 **Online** tab
- Switched to Offline Mode from Monitor Mode by clicking **Go Offline** on the WindO/I-NV4 **Online** tab
- Switched to Monitor Mode from Offline Mode by clicking **Go Online** on the WindO/I-NV4 **Online** tab



The Operation Log is only recorded during Run Mode.

Switching from Run Mode to System Mode and switching from System Mode to Run Mode is recorded. Switching from System Mode to Data Transfer Mode and switching from Data Transfer Mode to System Mode is not recorded.

■ Press buttons

This operation is recorded by the following events.

- Pressing a Bit Button, Word Button, Goto Screen Button, Multi-Button, Selector Switch, Potentiometer, Numerical Input, Character Input
- Pressing the key buttons **ENT**, **Download Project**, **Upload Project**, **Copy Files**, **Download PLC Program**, **Upload PLC Program**, **All Chk.**, **Del. All**, **Ref.**, **Stop Buzzer and Screen Flashing**, **Record**



The Operation Log only records button presses for parts created in WindO/I-NV4.

Operations for the buttons displayed in the System Mode, the Password Screen, the System Error Message and the title bar of Popup Screen are not recorded.

■ Write Data to any Device Addresses

This operation is recorded by the following event.

Writing a value to a device address by pressing a Bit Button, Word Button, Multi-Button, Selector Switch, Potentiometer, Numerical Input, Character Input

1.3 Data Configuration

The recorded data is composed of a label, time, user name, screen number, event name, part name, device address, and content after the change.

The relationship between the Operation Log function settings and the recorded data is as follows.

Operation Log settings

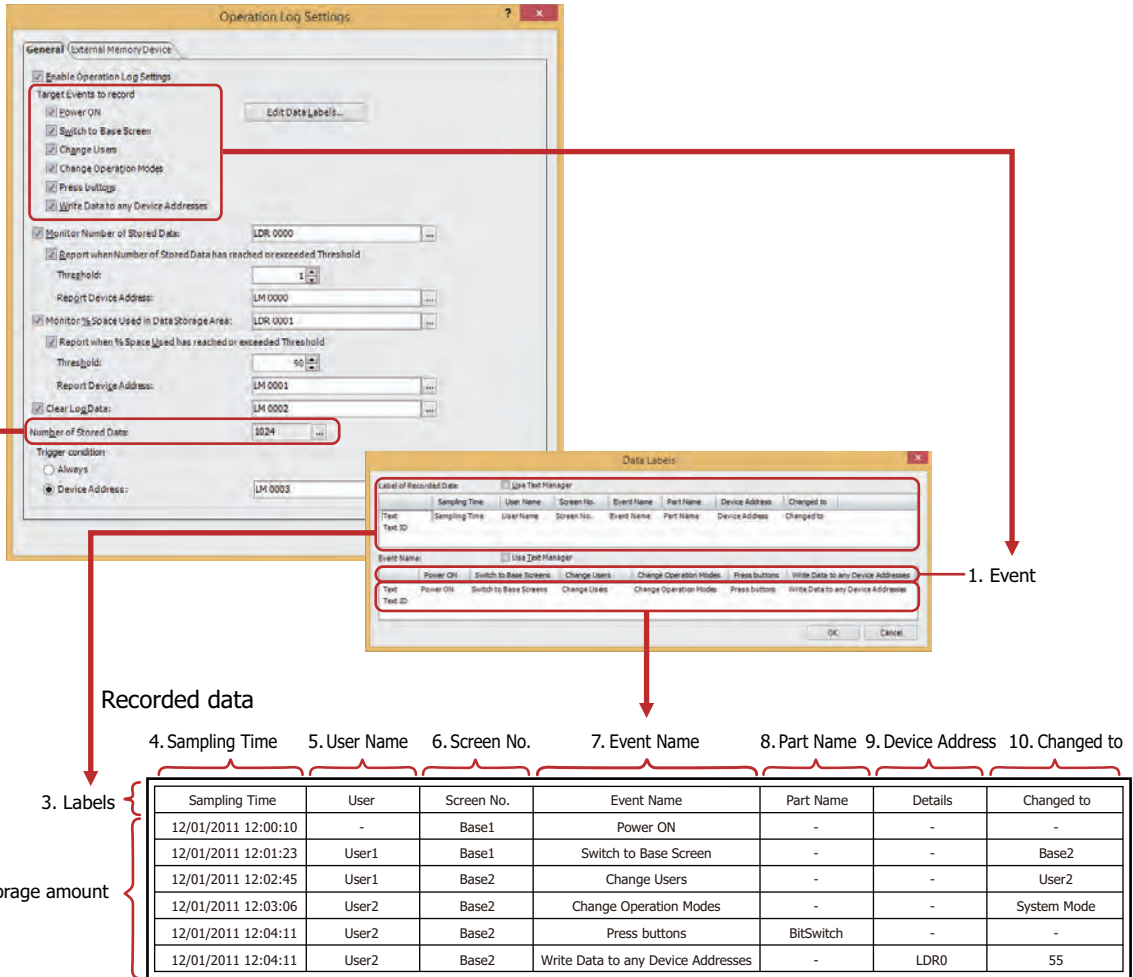

1. Event: Events that occur on the MICRO/I due to operations including user operations. Only the checked events are recorded.
2. Data storage amount: The amount of data to record. For details, refer to "Data Storage Data Amount" on page 15-6.
3. Label: When the recorded data is output as a CSV file, this is the text displayed in the label row.
4. Sampling Time: The time the event occurred.
The display type for the date and time varies based on the language configured in **Project Settings**, on the **Project Details** tab, in **Language**.
YYYY/MM/DD hh:mm:ss: Japanese
MM/DD/YYYY hh:mm:ss: Western, Simplified Chinese, Traditional Chinese, Hangul, Central European, Baltic, Cyrillic
5. User Name: The user name when the event occurred.
The user name is only recorded when the **Use Security functions** check box is selected on the **General** tab in the **Security** dialog box.
6. Screen No.: The screen type and number that was displayed when the event occurred.
Base *n*: Base screen (*n*: screen number)
Example: Base 1
Popup *n*: Popup screen (*n*: screen number)
Example: Popup 10

7. Event Name: When the recorded data is output as a CSV file, this is the text displayed as a label to describe the event that occurred. This item is configured in the Data Labels dialog box.
8. Part Name: The part name for the pressed touch switch when the **Press buttons** event occurs.
9. Device Address: The destination device address when the **Write Data to any Device Addresses** event occurs.
When an indirect write is used, the device address specified by the indirect value is recorded.
Example: When the device address configured as the destination for the value 100 is LDR100 and the indirect value is 3

	Event Name	Part Name	Details	Changed to
	Press buttons	WordSwitch1	–	–
	Write Data to any Device Addresses	–	LDR103	100

10. Changed to: The result produced from the event that occurred. The recorded content varies based on the event that occurred.

Switch to Base Screen: The screen type and number after switching.

Base *n*: Base screen (*n*: screen number)

Example: Base 1

Change Users: The user name after the change.

Change Operation Modes: The operation mode after the change.

Run Mode: Run Mode

System Mode: System Mode

Monitor Mode: Monitor Mode

Offline Mode: Offline Mode

Write Data to any Device Addresses:

The value written to the device address by pressing the touch switch. This value is handled as UBIN16(W). For details, refer to Chapter 2 "1.1 Available Data" on page 2-1.

The value written to the device address is recorded as UBIN16(W) regardless of the data type.

Example: When -10 (0xFF6) is written to device address D0

	Event Name	Part Name	Details	Changed to
	Press buttons	WordSwitch1	–	–
	Write Data to any Device Addresses	–	D0	65526 (0xFF6)

If the written value is 2 words (32 bits), each word is recorded (16 bits). For the storage order for 32-bit device address data, the upper word and lower word are stored following the **Storage Method of 32-bit Numerical Data for Internal Devices** or the **Storage Method of 32-bit Numerical Data** setting. For details, refer to Chapter 4 "Storage Method of 32-bit Numerical Data for Internal Devices" on page 4-29 and Chapter 4 "Storage Method of 32-bit Numerical Data" on page 4-48.

Example: The **from Lower word** is selected as the **Storage Method of 32-bit Numerical Data** in the **Communication Driver** tab on the Project Settings dialog box and 12345678 (0xBC614E) is written to device address D0 with the data type UBIN32(D).

	Event Name	Part Name	Details	Changed to
	Press buttons	WordSwitch1	–	–
	Write Data to any Device Addresses	–	D0	24910 (0x614E)
	Write Data to any Device Addresses	–	D1	188 (0xBC)

1.4 Saving and Deleting Data

● Saving Data

The recorded data is saved in the data storage area.

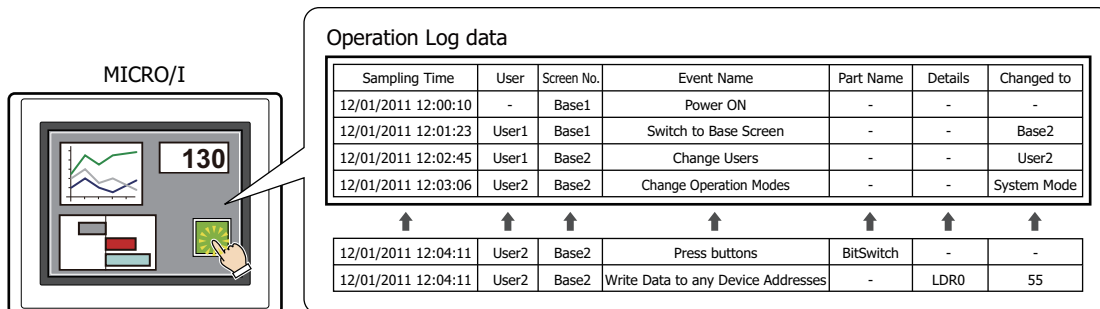

If the saved data exceeds the Operation Log data storage amount, the oldest data is deleted and the new data is saved.

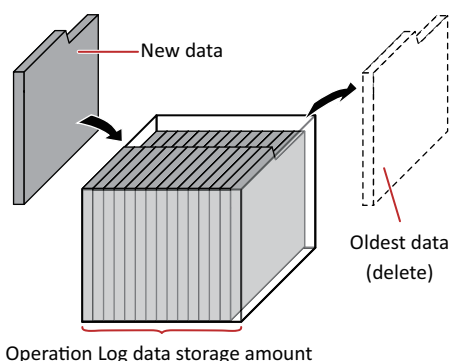

When there is no remaining battery power, the data in the Operation Log is erased when the MICRO/I is turned off.

Data Storage Amount

The maximum amount of data that can be saved in the data storage area is as follows.

Model	Maximum amount of data that can be saved in the data storage area
HG5G/4G/3G/2G-V, HG4G/3G, HG2G-5F	8,330
HG2J-7U, HG2G-5T, HG1G/1P	3,945



The maximum amount of data that can be recorded by a single operation is 150 items. When writing to multiple device addresses in a single operation using the Multi-Button or other part, data over 150 items cannot be recorded. If the data to be recorded in a single operation exceeds 150 items, HMI Special Internal Relay LSM22 is set to 1. For details, refer to Chapter 33 "HMI Special Relay (LSM)" on page 33-2.

● Deleting Data

The method to delete recorded data from the data storage area is as follows.

- On the **Online** tab in WindO/I-NV4, click the arrow under **Clear**, and click **All** or **Operation Log Data**. For details, refer to Chapter 24 "4 Clear" on page 24-26.
- In the System Mode, on the Main Menu screen, perform the following operation;
 - HG2J-7U, HG5G/4G/3G/2G-V, HG4G/3G, HG2F-5F: Press **Initial Setting**, **Initialize**, **Operation Log** in order.
 - HG2G-5T, HG1G/1P: Press **Initial Setting**, **Initialize**, **Op. Log** in order.

1.5 Using the Data

The saved data can be used in the following ways.

Operation Log data

Sampling Time	User	Screen No.	Event Name	Part Name	Details	Changed to
12/01/2011 12:00:10	-	Base1	Power ON	-	-	-
12/01/2011 12:01:23	User1	Base1	Switch to Base Screen	-	-	Base2
12/01/2011 12:02:45	User1	Base2	Change Users	-	-	User2
12/01/2011 12:03:06	User2	Base2	Change Operation Modes	-	-	System Mode
12/01/2011 12:04:11	User2	Base2	Press buttons	BitSwitch	-	-
12/01/2011 12:04:11	User2	Base2	Write Data to any Device Addresses	-	LDR0	55



- **Save to and read from an external memory device *1**

Output data from the MICRO/I to the external memory device as a CSV file and use it on a computer.

For details, refer to "4.1 Saving the Data as a CSV File" on page 15-21.

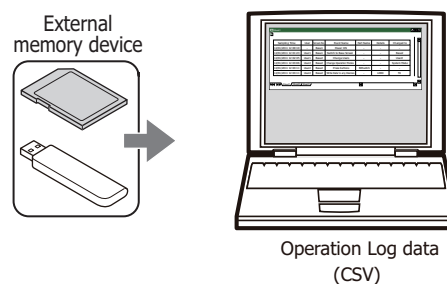

*1 USB flash drive inserted in USB1 for HG2J-7U, SD memory card for HG5G/4G/3G/2G-V, HG4G/3G and HG2G-5F, USB flash drive for HG2G-5T and HG1G/1P

2 Operation Log Function Configuration Procedure

HG2J-7U HG5G-V HG4G-V HG4G HG3G-V HG3G HG2G-V HG2G-5F HG2G-5T HG1G HG1P

This section describes the configuration procedure for the Operation Log function.

2.1 Configuring the Events and the Condition for Recording

- 1 On the **Configuration** tab, in the **System Setup** group, click **Operation Log**.

The Operation Log Settings dialog box is displayed.

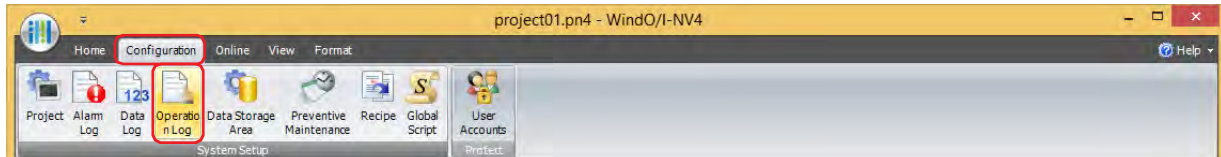

- 2 Select the **Enable Operation Log Settings** check box.

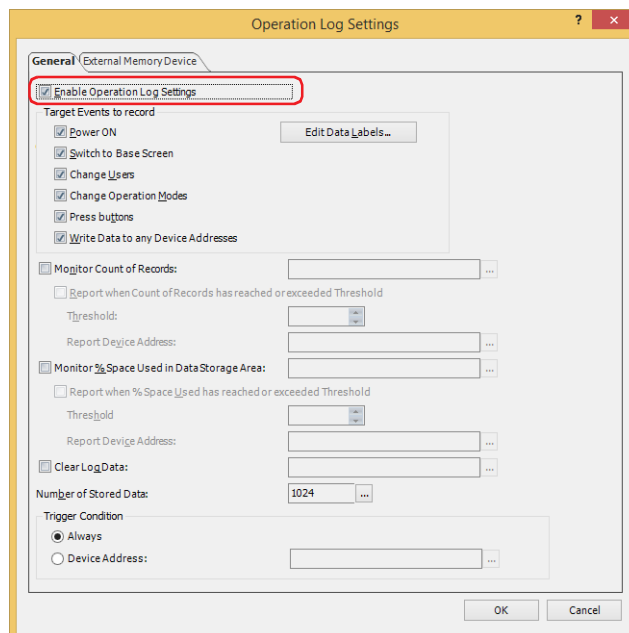

- 3 Select the check boxes for the events to record under **Target Events to record**.

Power ON:	The following items are recorded when the MICRO/I power is turned on. Time, Screen Number, Event Name
Switch to Base Screen:	The following items are recorded when the base screen is switched. Time, User Name, Screen Number, Event Name, Changed to
Change Users:	The following items are recorded when the user is changed. Time, User Name, Screen Number, Event Name, Changed to
Change Operation Modes:	The following items are recorded when the operation mode is changed. Time, User Name, Screen Number, Event Name, Changed to
Press buttons:	The following items are recorded when a touch switch is pressed. Time, User Name, Screen Number, Event Name, Part Name
Write Data to any Device Addresses:	The following items are recorded when a value is written to a device address by pressing a touch switch. Time, User Name, Screen Number, Event Name, Device Address, Changed to

4 Configure the Operation Log data storage amount in **Number of Stored Data**.

Click  to display the Data Storage Area Management dialog box.

Specify the Operation Log data storage amount in **Number of Stored Data for Operation Log** and click **OK**.
The Data Storage Area Management dialog box closes.

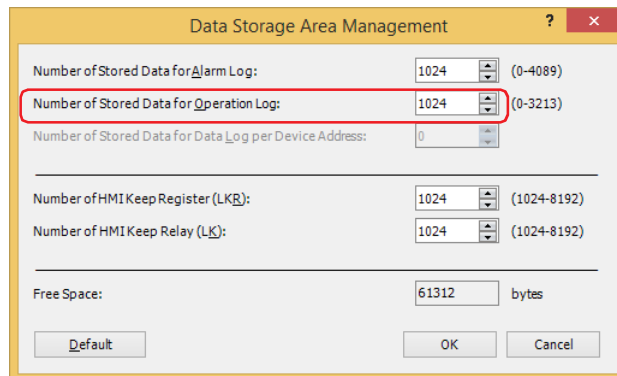

5 Select the condition to record events in **Trigger condition**.

■ **Always**

Always records events.

■ **Device Address**

Records events when the specified device address is 1. You can only specify an internal device.

For the device address configuration procedure, refer to Chapter 2 "5.1 Device Address Settings" on page 2-70.

6 Click **OK**.

The Operation Log Settings dialog box closes.

This concludes configuring the events and the condition for recording.

3 Operation Log Settings Dialog Box

HG2J-7U HG5G-V HG4G-V HG4G HG3G-V HG3G HG2G-V HG2G-5F HG2G-5T HG1G HG1P

This section describes items and buttons on the Operation Log Settings dialog box.

3.1 Operation Log Settings Dialog Box

● General Tab

The **General** tab is used to configure the events and the condition for recording.

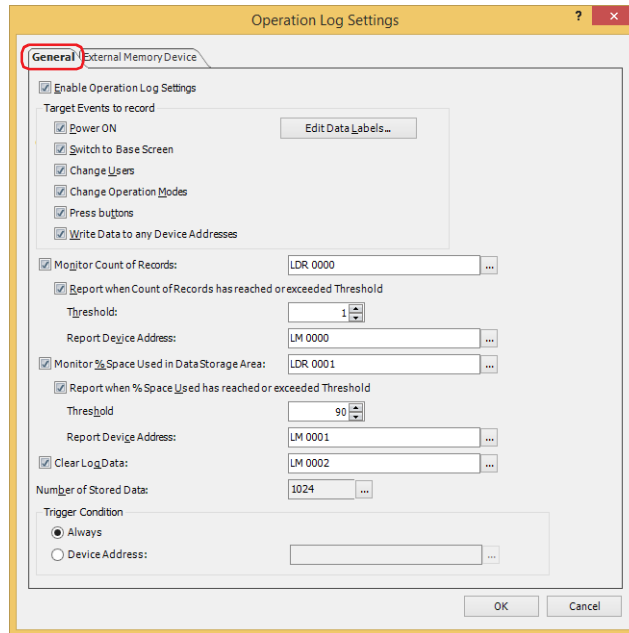

■ Enable Operation Log Settings

Select this check box to use the Operation Log function.

■ Target Events to record

Selects the events to record. Select the check boxes for the events to record.

- | | |
|-------------------------------------|--|
| Power ON: | The following items are recorded when the MICRO/I power is turned on.
Time, screen number, event name |
| Switch to Base Screen: | The following items are recorded when the base screen is switched.
Time, user name, screen number, event name, changed to |
| Change Users: | The following items are recorded when the user is changed.
Time, user name, screen number, event name, changed to |
| Change Operation Modes: | The following items are recorded when the operation mode is changed.
Time, user name, screen number, event name, changed to |
| Press buttons: | The following items are recorded when a touch switch is pressed.
Time, user name, screen number, event name, part name |
| Write Data to any Device Addresses: | The following items are recorded when a value is written to a device address by pressing a touch switch.
Time, user name, screen number, event name, device address, changed to |
| Edit Data Labels: | Displays the Data Labels dialog box.
The Data Labels dialog box is used to edit the text displayed in the label row and the event names displayed in the data rows when the recorded data is output as a CSV file.
For details, refer to "Data Labels Dialog Box" on page 15-12. |

■ Monitor Count of Records

Select this check box to count the number of stored data. The number of stored data is written to the specified device address.

(Destination Device Address): Specifies the destination word device.

For the device address configuration procedure, refer to Chapter 2 "5.1 Device Address Settings" on page 2-70.

Report when Count of Records has reached or exceeded Threshold:

Writes 1 to the Report Device Address when the number of record count reaches or exceeds the set threshold.

Threshold: Specifies the number of stored data (1 to 65535) that is the basis for reporting.

Report Device Address: Specifies the destination bit device or the bit number of the destination word device.

For the device address configuration procedure, refer to Chapter 2 "5.1 Device Address Settings" on page 2-70.

■ Monitor % Space Used in Data Storage Area

Select this check box to monitor the usage of the data storage area allocated as the save destination for Operation Log data. The usage is calculated from the data storage amount allocated to the data storage area and the amount of saved data, and then written to the specified device address.

Usage = Current amount of Operation Log data ÷ Operation Log data storage amount (omits values after the decimal point)

(Destination Device Address): Specifies the destination word device to write the current usage of the amount of Operation Log data storage.

For the device address configuration procedure, refer to Chapter 2 "5.1 Device Address Settings" on page 2-70.

Report when % Space Used has reached or exceeded Threshold:

Writes 1 in the Report Device Address when the current usage reaches or exceeds the set threshold.

Threshold: Specifies the usage (1 to 100) that is the basis for reporting.

Report Device Address: Specifies the destination bit device or the bit number of the destination word device.

For the device address configuration procedure, refer to Chapter 2 "5.1 Device Address Settings" on page 2-70.

■ Clear Log Data

Select this check box to erase the Operation Log data saved in the data storage area.

(Trigger Device Address): Specifies the bit device that triggers the erasure of the data. The saved data is erased when the value of the configured device address changes from 0 to 1. For the device address configuration procedure, refer to Chapter 2 "5.1 Device Address Settings" on page 2-70.

■ Number of Stored Data

Shows the maximum amount of Operation Log data to save in the data storage area. Data is saved up to the set amount. The maximum amount of data that can be saved in the data storage area is listed next.

HG5G/4G/3G/2G-V, HG4G/3G, HG2G-5F:	8,330
HG2J-7U, HG2G-5T, HG1G/1P:	3,945

Click to open the Data Storage Area Management dialog box where you can change the allocation of data storage area memory. For details, refer to Chapter 16 "Data Storage Area" on page 16-1.

■ Trigger Condition

Selects the trigger condition for the Operation Log function.

Always: Always records events.

Device Address: Records events when the value of the specified device address is 1.

For the device address configuration procedure, refer to Chapter 2 "5.1 Device Address Settings" on page 2-70.

Data Labels Dialog Box

The Data Labels dialog box is where you can edit labels for recorded data and event names when saving data as a CSV file.

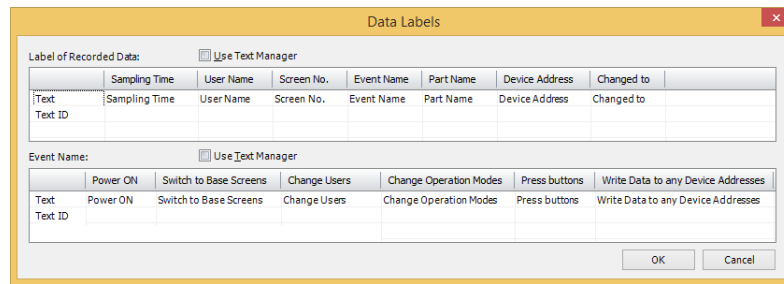

Label of Recorded Data

■ Use Text Manager

Select this check box to use text registered in Text Manager for recorded data labels when saving data as a CSV file.

■ Label of Recorded Data

Specifies the text to display in the label row in **Text** or **Text ID**.

Text: Double click the cell to enter the text to display as the label. The maximum number is 40 characters.

Text can only be entered when the **Use Text Manager** check box is cleared.

Text ID: Double click the cell to specify the Text Manager ID number (1 to 32000) when using text registered in Text Manager as the label.

This option is only enabled if you select the **Use Text Manager** check box.

The details for each label row label is as follows.

Sampling Time: The label for the column to display the time the event occurred.

User Name: The label for the column to display the user name when the event occurred.

Screen No.: The label for the column to display the screen type and number that was displayed when the event occurred.

Event Name: The label for the column to display the name of the event that occurred on the MICRO/I by an operation including a user operation.

Part Name: The label for the column to display the part name for the pressed touch switch when the **Press buttons** event occurs.

Device Address: The label for the column to display the destination device address when the **Write Data to any Device Addresses** event occurs.

Changed to: The label for the column to display the result produced from the event that occurred. The recorded content varies based on the event that occurred.

Event Name

■ Use Text Manager

Select this check box to use text registered in Text Manager for the event names when saving data as a CSV file.

■ Event Name

Specifies the text to display in Event Name in **Text** or **Text ID**.

Text: Double click the cell to enter the text to display as the event name. The maximum number is 40 characters.

Text can only be entered when the **Use Text Manager** check box is cleared.

Text ID: Double click the cell to specify the Text Manager ID number (1 to 32000) when using text registered in Text Manager as the event name.

This option is only enabled if you select the **Use Text Manager** check box.

Event name details are as follows.

Power ON: The event name when the MICRO/I power is turned on.

Switch to Base Screens: The event name when the base screen is switched.

Change Users: The event name when the user is changed.

Change Operation Modes: The event name when the MICRO/I operation mode is changed.

Press buttons: The event name when a touch switch is pressed.

Write Data to any Device Addresses: The event name when a value is written to a device address by pressing a touch switch.

● External Memory Device Tab

The **External Memory Device** tab is used to configure whether or not to output saved data to the external memory device^{*1}.

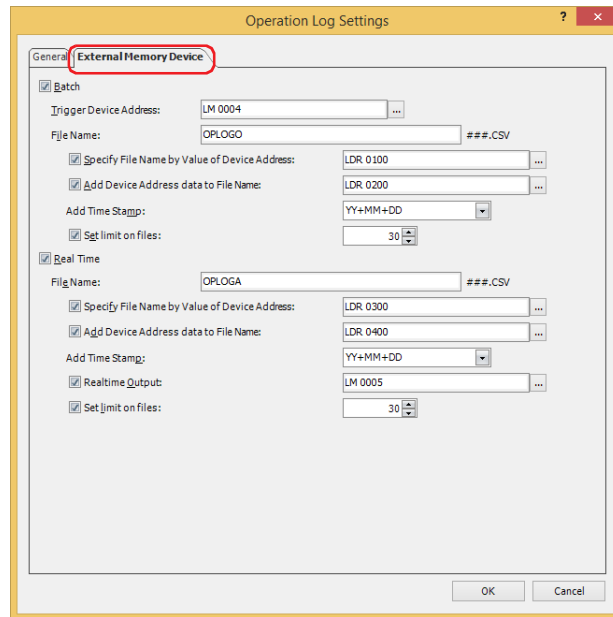

The output data is stored in the "OPERATIONLOG" folder of the External Memory Device folder.

The default External Memory Device folder name is "HGDATA01". For details, refer to Chapter 31 "1.4 File structure" on page 31-3 and Chapter 31 "1.6 Setting the External Memory Device Folder" on page 31-12.



Data recorded after starting output to the external memory device is not included in the output data.

*1 USB flash drive inserted in USB1 for HG2J-7U, SD memory card for HG5G/4G/3G/2G-V, HG4G/3G and HG2G-5F, USB flash drive for HG2G-5T and HG1G/1P

Batch

Select this check box to batch output all the sampled data to the external memory device*1.

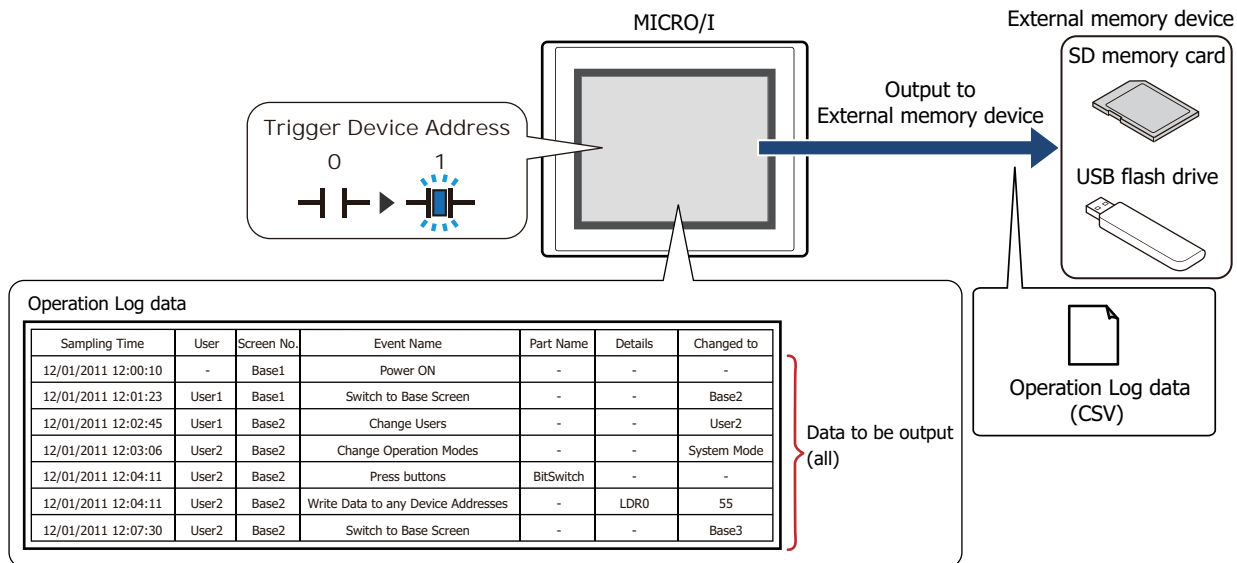

All the data is saved on the external memory device*1 when the value of the trigger device address changes from 0 to 1. If a file with the same name already exists on the external memory device*1, that file is overwritten. The maximum amount of output data is the amount configured by the data storage area.

The storing of data stops if there is insufficient free space on the external memory device. The error information is stored in the following HMI Special Data Registers. For details about the error information, refer to Chapter 33 "HMI Special Data Register (LSD)" on page 33-8.

HG2J-7U, HG5G/4G/3G/2G-V, HG4G/3G, HG2G-5F: LSD42

HG2G-5T, HG1G/1P: LSD33

Trigger Device Address: Specifies the bit device or the bit number of the word device to serve as condition for batch output. For the device address configuration procedure, refer to Chapter 2 "5.1 Device Address Settings" on page 2-70.
Data is output to file when the value of the trigger device address changes from 0 to 1.

File Name: Enter the file name for the output data or shows the file name.
The default is "OPLOGO.CSV".
To change the file name, enter a new file name. The maximum number is 120 characters (including the extension).

Specify File Name by Value of Device Address: Select this check box to assign a file name for the output data using a value of device address specified in the File Name Device Address.

(File Name Device Address): Specifies a word device to create a file name. The file name is set by reading the values sequentially from the starting device address specified with the File Name Device Address and handling those values as character data up to the character before NULL (00).
The maximum number of device addresses is 40 (2 characters per word device, maximum of 80 single-byte characters). You can only specify an internal device.
For the device address configuration procedure, refer to Chapter 2 "5.1 Device Address Settings" on page 2-70.

Example: When the device address specified by (File Name Device Address) is LDR100 and the text to set is "IDEC":

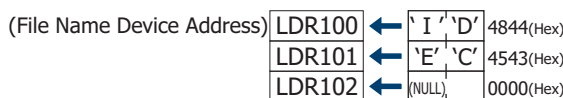

The file name at this time becomes "IDEC.CSV".

*1 USB flash drive inserted in USB1 for HG2J-7U, SD memory card for HG5G/4G/3G/2G-V, HG4G/3G and HG2G-5F, USB flash drive for HG2G-5T and HG1G/1P

Add Device Address data to File Name: Select this check box to add the bottom three digits of the value of the device address configured by (File Name Device Address) to the end of the file name for the output data.

(File Name Device Address): Specifies the word device that is the source for the value to add to the file name. For the device address configuration procedure, refer to Chapter 2 "5.1 Device Address Settings" on page 2-70. This option can only be configured when the **Add Device Address data to File Name** check box is selected.

Example: **File Name** is "OPLOGO" and the value of device address in (File Name Device Address) is 123, the file name is "OPLOGO123.CSV".

Add Time Stamp: Select from the following format for date and time to be added to the file name when data is output:

None, YY, YY+MM, YY+MM+DD, YY+MM+DD+HH, YY+MM+DD+HH+MM, YY+MM+DD+HH+MM+SS

The format is YYMMDD_hhmmss (YY: year, MM: month, DD: day, hh: hour, mm: minute, ss: second).

Example: **File Name** is "OPLOGO" on September 15 2013 at 23:30:50

YY:	OPLOGO_13
YY+MM:	OPLOGO_1309
YY+MM+DD:	OPLOGO_130915
YY+MM+DD+HH:	OPLOGO_130915_23
YY+MM+DD+HH+MM:	OPLOGO_130915_2330
YY+MM+DD+HH+MM+SS:	OPLOGO_130915_233050

Set limit on files: Specifies the upper limit (1 to 100) when limiting the number of files to be output.



When the **Set limit on files** check box is selected, note the following points.

- If the number of data files saved on the external memory device increases, it may take some time for the data output processing, or the output of the next data may not be processed normally.
- When displaying pictures saved on the external memory device and processing the output of data both occur simultaneously, the pictures may not be displayed.
- When parts that blink overlap pictures saved to the external memory device, the blinking period may slow down when data output processing occurs.



- The following single-byte characters cannot be used in the file name configured by **File Name** or **Specify File Name by Value of Device Address**.

" * / ; < > ? \ |

- File names that exceed the limits in **Specify File Name by Value of Device Address** and file names configured with characters that cannot be used are as follows.
 - When the text of the file name exceeds the maximum number of device addresses (no NULL), the text stored in device addresses up to the maximum number of device addresses from the start is configured.
 - When a character that cannot be used is set, the text is up to that character.
 - When the first character is a character that cannot be used, the text is that set for **File Name**.
- The operation when the **Set limit on files** check box is selected is as follows.
 - The files are output up to the set limit, and then for additional files, the new files are saved by discarding the old files in order of the oldest first.
 - If the number of files saved on the external memory device already exceeds the limit when operation starts, the number of files at that time is the limit. From there the data is discarded in order from the oldest data and replaced with new data with each file output.

Real Time

Select this check box to output data to the external memory device^{*1} in real time.

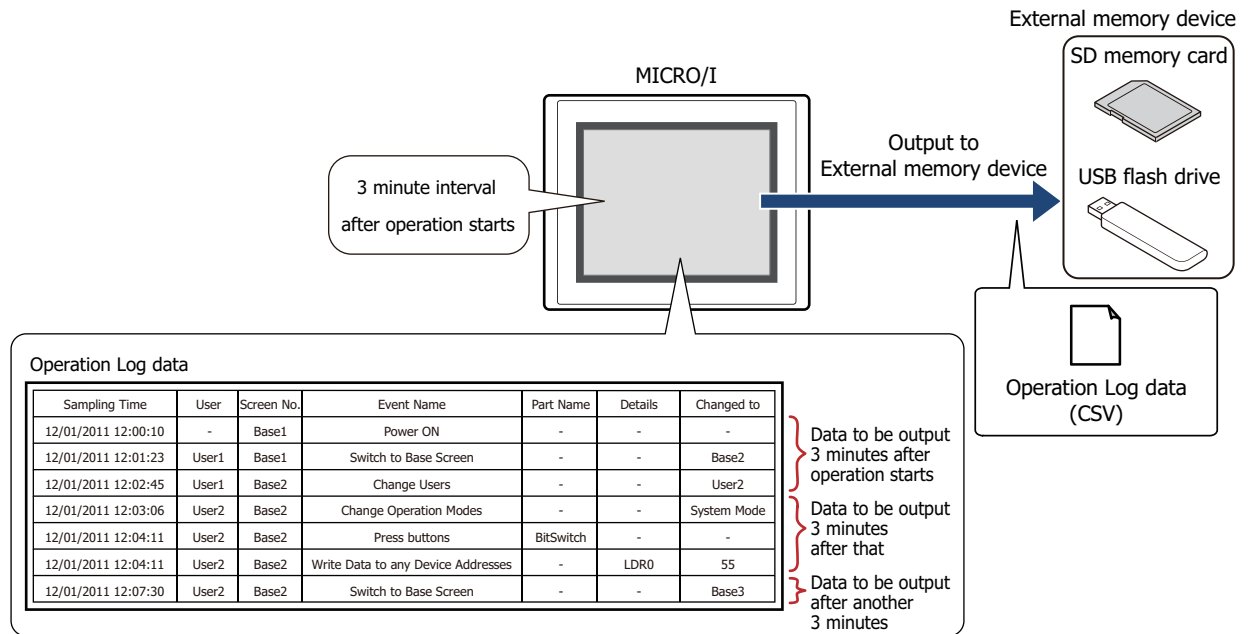

With real time output, data is saved to the external memory device^{*1} in three minute intervals after the MICRO/I starts running. If the accumulated data reaches 80% of the amount set in the Data Storage Area, then the data is forcibly saved to the external memory device^{*1}. When there is already data with the same file name on the external memory device^{*1}, data is appended to that file. If there was no update to the data during the three minutes, it is not output. Data is appended to the file until the size of the file reaches the restriction size (256 MB), so the maximum amount of output data varies based on the settings for the output channel such as the amount of data, the data size, and the labels. If the interval events occur more quickly than the time it takes to accomplish the real time output (the interval for writing to the external memory device^{*1}), the Operation Log is recorded up to the data storage amount - 1, and then afterwards, old data is discarded in order and replaced with new data.



Real time output stops when the file size of the Operation Log data exceeds 256 MB or when there is insufficient space on the external memory device. The error information is stored in the following HMI Special Data Registers. For details about the error information, refer to Chapter 33 "HMI Special Data Register (LSD)" on page 33-8.

HG2J-7U, HG5G/4G/3G/2G-V, HG4G/3G, HG2G-5F: LSD42

HG2G-5T, HG1G/1P: LSD33



- When the value of the following HMI Special Internal Relays changes from 0 to 1, the data at that time is first output in real time to the external memory device, and then access to the external memory device is stopped. For details, refer to Chapter 33 "HMI Special Relay (LSM)" on page 33-2.

HG2J-7U, HG5G/4G/3G/2G-V, HG4G/3G, HG2G-5F: LSD20

HG2G-5T, HG1G/1P: LSD18

- The amount of free space on the external memory device is saved to the following HMI Special Data Registers. For details about the free space on the External Memory Devices, refer to Chapter 33 "HMI Special Data Register (LSD)" on page 33-8.

HG2J-7U, HG5G/4G/3G/2G-V, HG4G/3G, HG2G-5F: LSD43, 44

HG2G-5T, HG1G/1P: LSD34, 35

*1 USB flash drive inserted in USB1 for HG2J-7U, SD memory card for HG5G/4G/3G/2G-V, HG4G/3G and HG2G-5F, USB flash drive for HG2G-5T and HG1G/1P

File Name: Enter the file name for the output data or shows the file name.

The default is "OPLOGA.CSV".

To change the file name, enter a new file name. The maximum number is 120 characters (including the extension).

Specify File Name by Value of Device Address: Select this check box to specify the name of the file for the output data with the value of the device address configured by (File Name Device Address).

(File Name Device Address): Specifies the word device that is the source of the data to use as the file name. The file name is set by reading the values sequentially from the starting device address specified with the File Name Device Address and handling those values as character data up to the character before NULL (00).

The maximum number of device addresses is 40 (80 single-byte characters). You can only specify an internal device. For the device address configuration procedure, refer to Chapter 2 "5.1 Device Address Settings" on page 2-70.

Example: When the device address specified by (File Name Device Address) is LDR100 and the text to set is "IDEC":

(File Name Device Address)	LDR100	←	'I'	'D'	4844(Hex)
	LDR101	←	'E'	'C'	4543(Hex)
	LDR102	←	{NULL}		0000(Hex)

The file name at this time becomes "IDEC.CSV".

Add Device Address data to File Name: Select this check box to add the bottom three digits of the value of the device address configured by (File Name Device Address) to the end of the file name for the output data.

(File Name Device Address): Specifies the word device that is the source for the value to add to the file name. For the device address configuration procedure, refer to Chapter 2 "5.1 Device Address Settings" on page 2-70. This option can only be configured when the **Add Device Address data to File Name** check box is selected.

Example: When **File Name** is "OPLOGA" and the value of the device address configured by (File Name Device Address) is 123, the file name is "OPLOGA123.CSV".

Add Time Stamp: Selects the format of the output date and time to add to the file name for the output data.

None, YY, YY+MM, YY+MM+DD

The format is YYMMDD (YY: year, MM: month, DD: day).

Example: **File Name** is "OPLOGA" on September 15 2013

YY: OPLOGA_13
YY+MM: OPLOGA_1309
YY+MM+DD: OPLOGA_130915

Realtime Output: Select this check box to forcibly output the data and save it to file at the desired timing.

(Trigger device address): Specifies the bit device or the bit number of the word device to serve as the condition to forcibly output the data. You can only specify an internal device. For the device address configuration procedure, refer to Chapter 2 "5.1 Device Address Settings" on page 2-70. Data is output to file when the trigger device address changes from 0 to 1.

Set limit on files: Specifies the upper limit (1 to 100) when limiting the number of files to be output.



When the **Set limit on files** check box is selected, note the following points.

- If the number of data files saved on the external memory device increases, it may take some time for the data output processing, or the output of the next data may not be processed normally.
- When displaying pictures saved on the external memory device and processing the output of data both occur simultaneously, the pictures may not be displayed.
- When parts that blink overlap pictures saved to the external memory device, the blinking period may slow down when data output processing occurs.



The following single-byte characters cannot be used in the file name configured by **File Name** or **Specify File Name by Value of Device Address**.

" * / ; ; < > ? \ |

- File names that exceed the limits in **Specify File Name by Value of Device Address** and file names configured with characters that cannot be used are as follows.
 - When the text of the file name exceeds the maximum number of device addresses (no NULL), the text stored in device addresses up to the maximum number of device addresses from the start is configured.
 - When a character that cannot be used is set, the text is up to that character.
 - When the first character is a character that cannot be used, the text is that set for **File Name**.
- The operation when the **Set limit on files** check box is selected is as follows.
 - The files are output up to the set limit, and then for additional files, the new files are saved by discarding the old files in order of the oldest first.
 - If the number of files saved on the external memory device already exceeds the limit when operation starts, the number of files at that time is the limit. From there the data is discarded in order from the oldest data and replaced with new data with each file output.
- The following operations are as follows if the **Realtime Output** check box is selected.
 - Even if the data is outputted forcibly, the real time output period (3 minute interval) is not reset.
 - While data is being output with the real time output function, the file is not output when the value of the **Realtime Output** device address is 1.
 - Even when output has finished, the value of device address does not automatically change to 0.



- The function to record data operates when Operation Log data is being saved to the external memory device.
- The batch output or real time output status of the Operation Log data can be checked with the value of HMI Special Internal Relay LSM37. When the data starts to be written to the external memory device, the value of device is 1. When writing is complete, the value is 0.
- The methods to erase Operation Log files saved on the external memory device are as follows.
 - To erase files during operation using parts, on the **External Memory Device** tab in the Project Settings dialog box, select the **Remove Files stored in External Memory Device** check box and the **All Operation Log data** check box, and then configure the trigger device address. Assign that trigger device address to a part.
 - To erase files with WindO/I-NV4, click **Clear** on the **Online** tab, and then click **Stored Data in External Memory Device** to open the Clear Data dialog box. Select the **Operation Log Data** check box and click **OK**.
 - To erase files on the HG5G/4G/3G/2G-V, HG4G/3G and HG2G-5F, go to the System Mode - File Manager. In the File Manager, select the files to be deleted by pressing **DEL**.

Output Data File Name

The file name format is as follows.

File Name Value of Device Address_YYMMDD_hhmmss.CSV

- File Name: The text entered in **File Name** or the text entered according to the value of the device address set by **Specify File Name by Value of Device Address**
- Value of Device Address: The lower 3 digits of the value of the device address configured by **Add Device Address data to File Name**
- YYMMDD: The year, month, and day of the month set on **Add Time Stamp**
- hhmmss: The hour, minute, and second of the time configured on **Add Time Stamp**

■ **Example 1**

Item	Setting	
File Name	OPLOGA	
Add value of Device Address to File Name	(File Name Device Address) is LDR200	LDR200 value: 123
Add Time Stamp	YY+MM	Date when data was output: September 2013

Result: The file name is "OPLOGA123_1309.CSV".

■ **Example 2**

Item	Setting	
Specify File Name by Value of Device Address	(File Name Device Address) is LDR100 Text to set is "IDEC"	LDR100 value: 4944 (Hex) LDR101 value: 4543 (Hex) LDR102 value: 0000 (Hex)
Add value of Device Address to File Name	(File Name Device Address) is LDR200	LDR200 value: 123
Add Time Stamp	YY+MM+DD+HH+MM+SS	Date and time when data was output: September 15 2013 at 23:30:50

Result: The file name is "IDEC123_130915_233050.CSV".

4 Using the Data

HG2J-7U HG5G-V HG4G-V HG4G HG3G-V HG3G HG2G-V HG2G-5F HG2G-5T HG1G HG1P

4.1 Saving the Data as a CSV File

● Saving the Data as a CSV File

The Operation Log data can be saved to the external memory device*¹ as a CSV file or uploaded to a computer. The procedure to save the data is as follows.

- To save the data to an external memory device, click **Operation Log** on the WindO/I-NV4 **Configuration** tab to open the Operation Log Settings dialog box. Select an output method check box on the **External Memory Device** tab and configure the items. The Operation Log data is saved to the External Memory Device folder on the external memory device according to the **External Memory Device** tab settings. For details, refer to "External Memory Device Tab" on page 15-14.
- To upload the data to a computer, click on ▼ to the right of  (Upload) on the toolbar in Data File Manager, and then click the **Upload All Log Data** or **Upload Data Operation Log Data** to open the Browser For Folder dialog box. Specify the location to save the file and click **OK** to save the file to the specified folder. For details, refer to the Data File Manager User's Manual.

● Data Structure and Output Example

The data structure of the output file is as follows. The data structure for files output with batch output and real time output is the same.

Bold items are replaced by the Operation Log settings, the recorded data, the running project name, and WindO/I-NV4 version number.

Headers	"Project Name", " Project name ", " Version number " "File Type", " Log type " Blank row
Label row	" Sampling Time ", " User Name ", " Screen No. ", " Event Name ", " Part Name ", " Device Address ", " Changed to "
Data row	" MM/DD/YYYY hh:mm:ss ", " User Name ", " Screen Type & No. ", " Event ", " Part Name ", " Device Address ", " Changed to " : :

Output example

	Data size of each row
"Project Name", "Dimmer Console", "V4.50"	- 41 bytes
"File Type", "Operation Log Data"	- 34 bytes
	- 2 bytes
"Sampling Time", "User", "Screen No.", "Operation", "Part Name", "Details", "Changed to"	- 85 bytes
" 12/01/2011 12:00:10", "-", "Base 1", "Power ON", "-", "-", "-"	- 60 bytes
" 12/01/2011 12:01:23", "User1", "Base 1", "Switch to Base Screen", "-", "-", "Base2"	- 81 bytes
:	



- The data size for each row is counted as 2 bytes for full-width characters, 1 byte for half-width characters, and 2 bytes for newlines. The total for each row is the total amount of space for the file.
- A space is inserted before the date in the data row.
- The display type for the date and time varies based on the language configured in **Project Settings**, on the **Project Details** tab, in **Language**.

Japanese: YYYY/MM/DD hh:mm:ss

Western, Simplified Chinese, Traditional Chinese, Hangul, Central European, Baltic, Cyrillic:
MM/DD/YYYY hh:mm:ss

*1 USB flash drive inserted in USB1 for HG2J-7U, SD memory card for HG5G/4G/3G/2G-V, HG4G/3G and HG2G-5F, USB flash drive for HG2G-5T and HG1G/1P

This chapter describes how to configure the data storage area and its operation on the MICRO/I.

1 Overview

HG2J-7U HG5G-V HG4G-V HG4G HG3G-V HG3G HG2G-V HG2G-5F HG2G-5T HG1G HG1P

1.1 What is the Data Storage Area?

The data storage area is the area in the MICRO/I's internal memory where saved data is not erased even when the power is turned off.

The following data can be saved in the data storage area.

- Alarm Log data
☞ Chapter 13 "Alarm Log Function" on page 13-1
- Data Log data
☞ Chapter 14 "Data Log Function" on page 14-1
- Operation Log data
☞ Chapter 15 "Operation Log Function" on page 15-1



- When there is no remaining battery, the data in the data storage area is erased when the MICRO/I is turned off.
- If you download the project data from WindO/I-NV4, Alarm Log data, Operation Log data, and Data Log data is erased. The data saved in the HMI Keep Register (LKR) and the HMI Keep Relay (LK) is saved.

1.2 Data Storage Area

The capacity of the data storage area and the types and sizes of data that can be saved there differ according to the MICRO/I model.

● Data Storage Area Capacity and Types of Storable Data

You can allocate areas to save Alarm Log data, Operation Log data, and Data Log data, as well as areas to use as HMI Keep Register (LKR) and HMI Keep Relay (LK). The unallocated leftover area is free space.

HG5G/4G/3G/2G-V, HG4G/3G, HG2G-5F

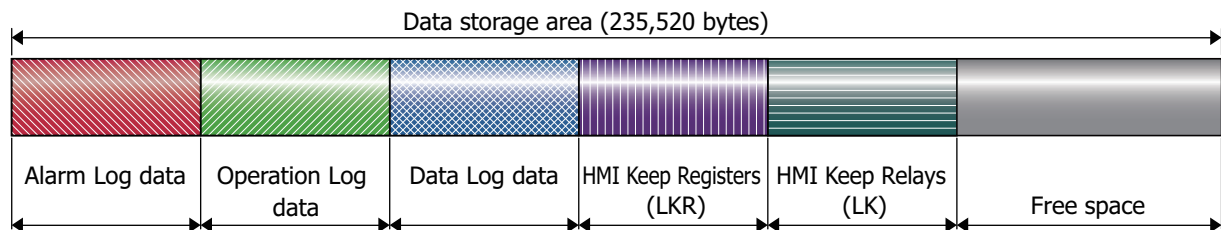

HG2J-7U, HG2G-5T, HG1G/1P

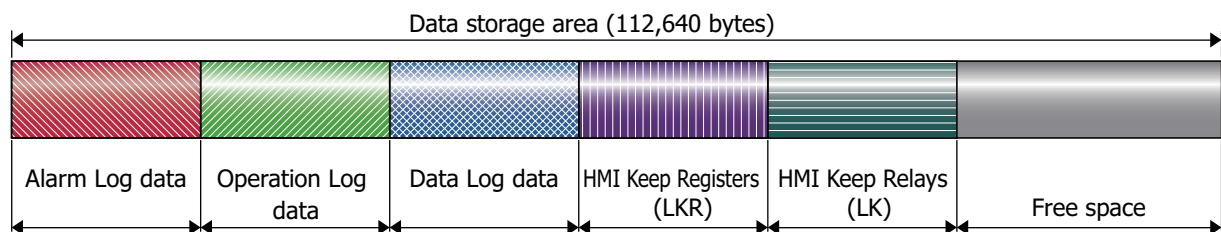

● Minimum and Maximum Amount of Data Storage and Number of Addresses

The minimum and maximum amount of data storage and the minimum and maximum number of addresses that can be configured for the data storage area is as follows.

Data type	HG5G/4G/3G/2G-V, HG4G/3G, HG2G-5F		HG2J-7U, HG2G-5T, HG1G/1P	
	Minimum	Maximum	Minimum	Maximum
Number of Stored Data for Alarm Log	0	11660	0	5520
Number of Stored Data for Operation Log	0	8330	0	3945
Number of Stored Data for Data Log per Device Address	0	29165	0	13808
Number of HMI Keep Register (LKR)	1024	8192	1024	8192
Number of HMI Keep Relay (LK)	1024	8192	1024	8192

2 Data Storage Area Configuration Procedure

HG2J-7U HG5G-V HG4G-V HG4G HG3G-V HG3G HG2G-V HG2G-5F HG2G-5T HG1G HG1P

This section describes the configuration procedure for the data storage area.

- 1 On the **Configuration** tab, in the **System Setup** group, click **Data Storage Area**.

The **Data Storage Area Management** dialog box is displayed.

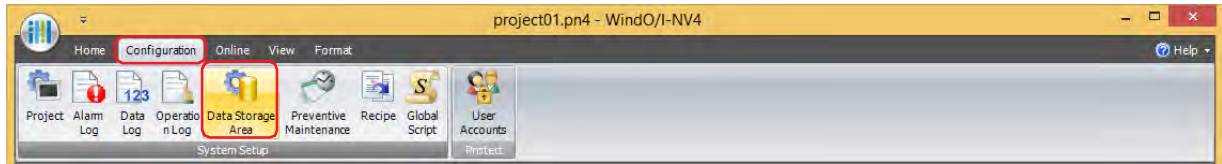

- 2 Specify the amount of Alarm Log data to save in the data storage area in **Number of Stored Data for Alarm Log** (HG5G/4G/3G/2G-V, HG4G/3G, HG2G-5F: 0 to 11660, HG2J-7U, HG2G-5T, HG1G/1P: 0 to 5520).

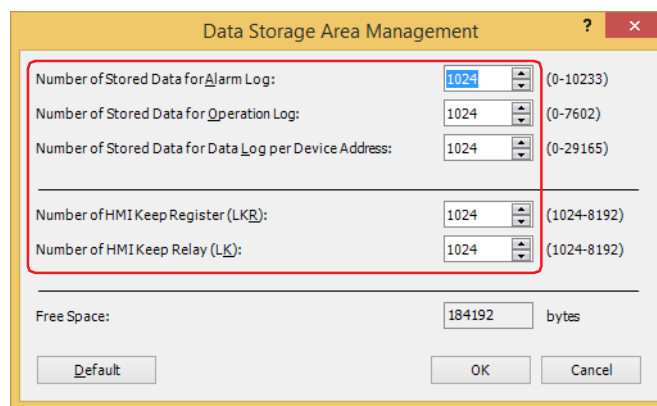

- 3 Specify the amount of Operation Log data to save in the data storage area in **Number of Stored Data for Operation Log** (HG5G/4G/3G/2G-V, HG4G/3G, HG2G-5F: 0 to 8330, HG2J-7U, HG2G-5T, HG1G/1P: 0 to 3945).
- 4 Specify the amount of Data Log data per device address to save in the data storage area in **Number of Stored Data for Data Log per Device Address** (HG5G/4G/3G/2G-V, HG4G/3G, HG2G-5F: 0 to 29165, HG2J-7U, HG2G-5T, HG1G/1P: 0 to 13808).
- 5 Specify the number of HMI Keep Register (LKR) addresses in **Number of HMI Keep Register (LKR)** (1024 to 8192).
- 6 Specify the number of HMI Keep Relay (LK) addresses in **Number of HMI Keep Relay (LK)** (1024 to 8192).
- 7 Click **OK**.

The **Data Storage Area Management** dialog box closes.

This concludes configuring the data storage area.

3 Data Storage Area Management Dialog Box

HG2J-7U HG5G-V HG4G-V HG4G HG3G-V HG3G HG2G-V HG2G-5F HG2G-5T HG1G HG1P

This section describes items and buttons on the **Data Storage Area Management** dialog box.

- **Number of Stored Data for Alarm Log**

Specifies the amount of Alarm Log data to save in the data storage area (HG5G/4G/3G/2G-V, HG4G/3G, HG2G-5F: 0 to 11660, HG2J-7U, HG2G-5T, HG1G/1P: 0 to 5520).

Alarm Log data is only saved in the data storage area when **Store** is selected under **Block Settings, Data** in the **Auto-Setup** dialog box or in the **Individual Settings** dialog box for Alarm Log Settings.

- **Number of Stored Data for Operation Log**

Specifies the amount of Operation Log data to save in the data storage area (HG5G/4G/3G/2G-V, HG4G/3G, HG2G-5F: 0 to 8330, HG2J-7U, HG2G-5T, HG1G/1P: 0 to 3945).

- **Number of Stored Data for Data Log per Device Address**

Specifies the amount of Data Log data per device address to save in the data storage area (HG5G/4G/3G/2G-V, HG4G/3G, HG2G-5F: 0 to 29165, HG2J-7U, HG2G-5T, HG1G/1P: 0 to 13808).

Data Log data is only saved in the data storage area when **Enable** is selected under **Log function** on the **General** Tab in the **Individual Settings** dialog box for Data Log Settings.

- **Number of HMI Keep Register (LKR)**

Specifies the number of HMI Keep Register (LKR) addresses (1024 to 8192).

- **Number of HMI Keep Relay (LK)**

Specifies the number of HMI Keep Relay (LK) addresses (1024 to 8192).

- **Free Space**

Shows the amount of free space in the data storage area (in bytes).

- **Default**

Returns the configured values to their default values.

Chapter 17 Preventive Maintenance Function

This chapter describes how to configure the Preventive Maintenance function and its operation on the MICRO/I.

1 Overview

HG2J-7U HG5G-V HG4G-V HG4G HG3G-V HG3G HG2G-V HG2G-5F HG2G-5T HG1G HG1P

1.1 How the Preventive Maintenance Function is Used

The Preventive Maintenance function monitors the state of device addresses and counts the time the monitored device addresses are 1, as well as the number of times the values of monitored device addresses change to 1. The Preventive Maintenance function can perform the following functions.

- Monitor device addresses that turn on lighting or warning lights and count the operation time

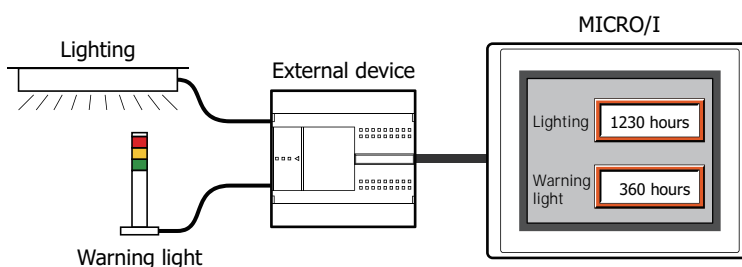

- Report the replacement time for lighting and warning lights by the counted operation time

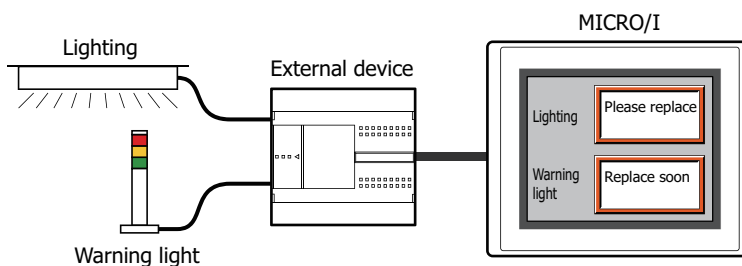

- Monitor device addresses connected to buttons and relays and count the operation count

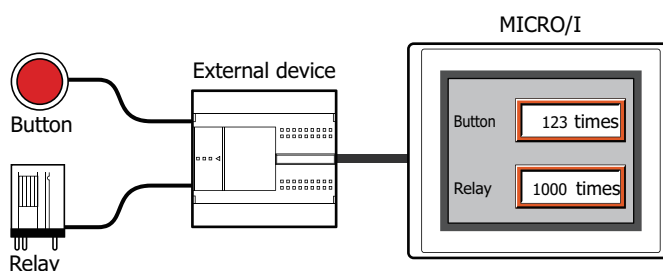

- Report the inspection time for buttons and relays by the counted operation count

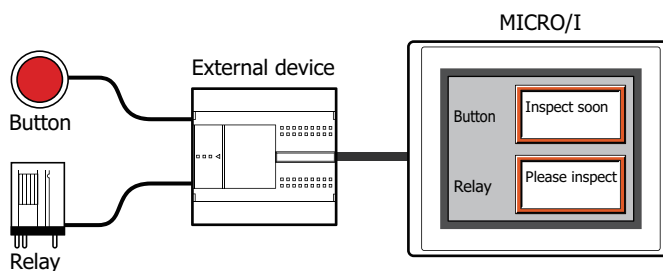

1.2 Counting the Operation Time and Operation Count

The operation time and operation count are counted up to the set maximum value. The counted operation time and operation count are saved in HMI Keep Registers (LKR) and the values are retained until they are reset. To reset a counted value, set the value of the configured HMI Keep Register (LKR) to 0.

The maximum value that can be configured varies based on the data type of the destination device address for the operation time and operation count.

● Counting the Operation Time

While the value of the monitored device address is 1, 1 is added to the value of the device address (Operation Time Device Address) configured in **Measure Operation Time** for each second that elapses. The operation time is not counted when it is less than one second.

The counted operation time is written to the device address configured in **Measure Operation Time**.

Example: When the value of monitored device address M0 is 1, 1 is added to the value of Operation Time Device Address LKR0.

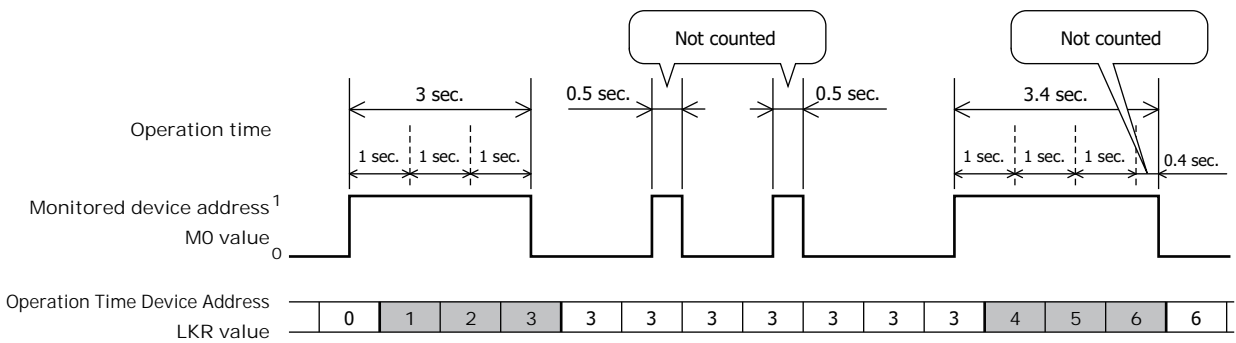

● Counting the Operation Count

When the value of the monitored device address changes from 0 to 1, 1 is added to the value of the device address (operation count device address) configured in **Measure Operation Count**.

The counted operation count is written to the device address configured in **Measure Operation Count**.

Example: When the value of monitored device address M0 changes from 0 to 1, 1 is added to the value of operation count device address LKR0.

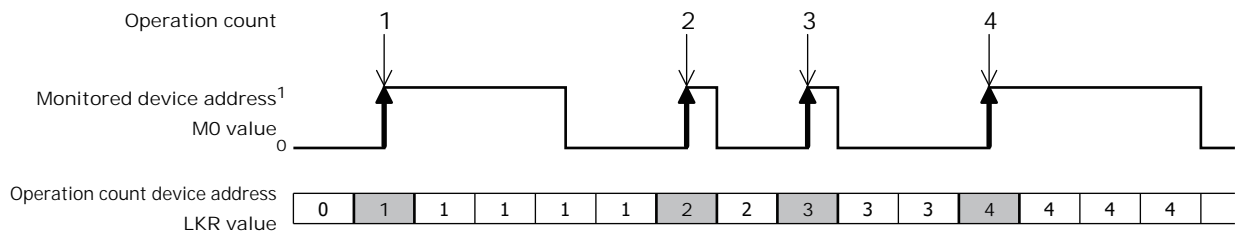

! If the value of monitored device addresses changes from 0 to 1 in an interval shorter than the MICRO/I scan time and the communication cycle with external devices, the operation time and operation count is not counted normally. You can check the maximum MICRO/I scan time (x 1 ms) with the value of HMI Special Data Register LSD4. You can check the communication cycle with external devices (x 1 ms) with the value of HMI Special Data Register LSD6. For details, refer to Chapter 33 "HMI Special Data Register (LSD)" on page 33-8.

1.3 Thresholds

The threshold is a value that is the criterion for reporting to a configured device address (Report Device Address) when the value counted for the operation time or operation count (a value of Operation Time Device Address or Operation Count Device Address) has reached the threshold value. 1 is written to the configured device address when the operation time and operation count reach the threshold.

Example: When the value of Operation Time Device Address LKR0 reaches the threshold set for level 1 through level 3, 1 is written to the Report Device Address configured for each level, LM1 through LM3.

Level	Threshold	Report Device Address
Level 1	10	LM1
Level 2	15	LM2
Level 3	20	LM3

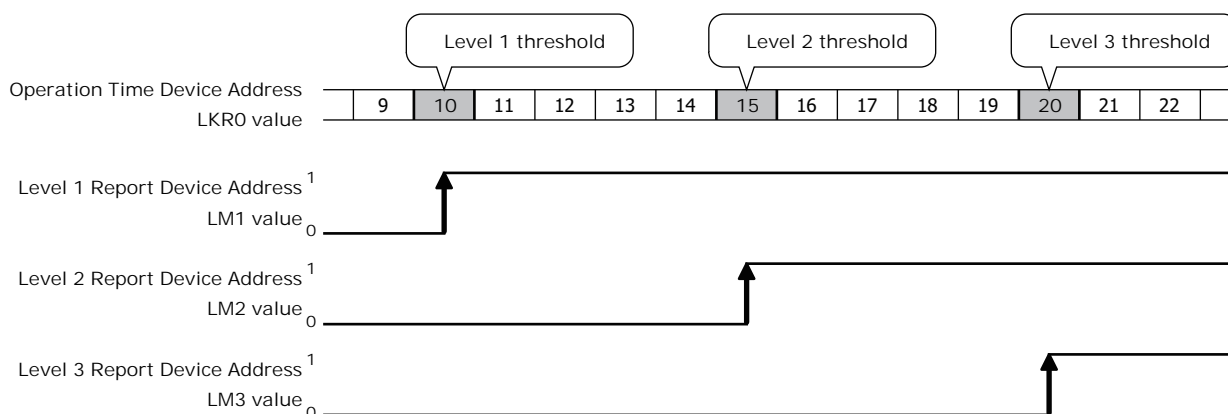

2 Preventive Maintenance Function Configuration Procedure

HG2J-7U HG5G-V HG4G-V HG4G HG3G-V HG3G HG2G-V HG2G-5F HG2G-5T HG1G HG1P

This section describes the configuration procedure for the Preventive Maintenance function.

2.1 Counting Operation Time and Operation Count

- 1 On the **Configuration** tab, in the **System Setup** group, click **Preventive Maintenance**. The **Preventive Maintenance Settings** dialog box is displayed.



- 2 Specify the number of device addresses to monitor in **Number of Items**.

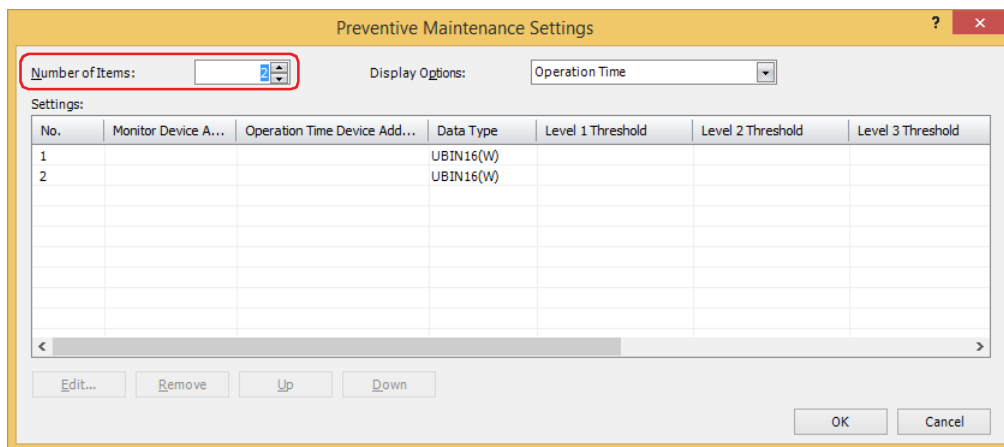

- 3 Select the item to display in **Settings** with **Display Options**. Select **Operation Time + Operation Count**. The **Operation Time** and **Operation Count** settings are displayed in **Settings**.
- 4 Select the number to register the Preventive Maintenance settings to in **Settings**, then click **Edit**. The **Individual Settings** dialog box is displayed.
- 5 Specify the bit device or the bit number of the word device to monitor with **Monitor Device Address**. Click **...** to display the Tag Editor. For the device address configuration procedure, refer to Chapter 2 "5.1 Device Address Settings" on page 2-70.

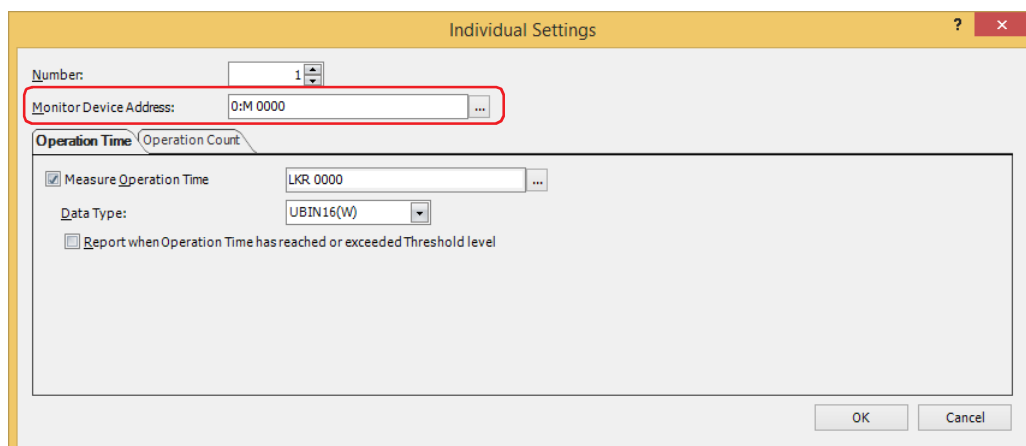

- 6 Select the **Measure Operation Time** check box on the **Operation Time** tab.
If you are not counting the operation time, leave the **Measure Operation Time** check box cleared and proceed to step 9.
- 7 Specify the destination device address for the counted operation time.
You can only specify an HMI Keep Register (LKR).
Click to display the Tag Editor. For the device address configuration procedure, refer to Chapter 2 "5.1 Device Address Settings" on page 2-70.
- 8 Select the data type for the value of **Measure Operation Time** device address with **Data Type**.
This concludes configuring operation time counting.
- 9 Click the **Operation Count** tab.

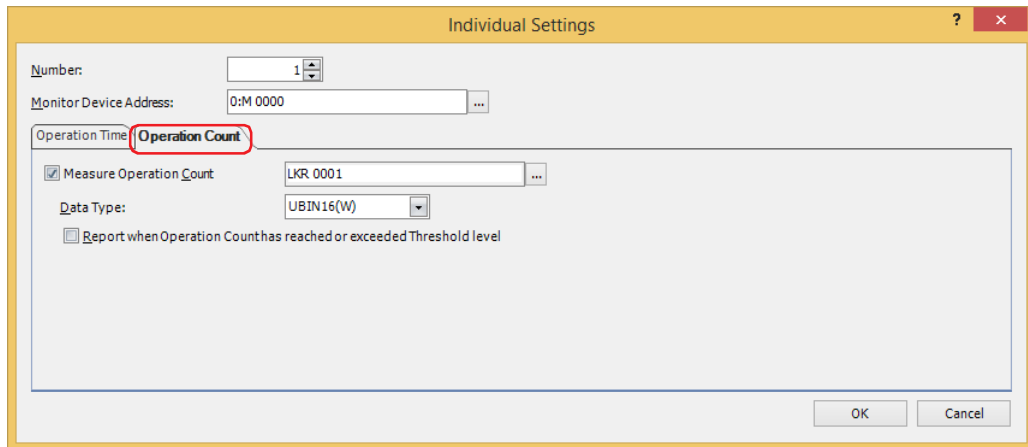

- 10 Select the **Measure Operation Count** check box.
If you are not counting the operation count, leave the **Measure Operation Count** check box cleared and proceed to step 13.
- 11 Specify the destination device address for the counted operation count.
You can only specify an HMI Keep Register (LKR).
Click to display the Tag Editor. For the device address configuration procedure, refer to Chapter 2 "5.1 Device Address Settings" on page 2-70.
- 12 Select the data type for the value of **Measure Operation Count** device address with **Data Type**.
This concludes configuring operation count counting.
- 13 Click **OK** to close the **Individual Settings** dialog box.
You are returned to the **Preventive Maintenance Settings** dialog box.
- 14 Repeat steps 2 to 13 to register settings to count the operation time and operation count in all the used numbers.
This concludes configuring operation time and operation count counting.

Next, configure the functions to execute using counted data.

☞ "4.1 Displaying the Counted Operation Count on a Numerical Display" on page 17-11

☞ "4.2 Notifying with a Beep when the Counted Operation Time Reaches the Threshold" on page 17-14

3 Preventive Maintenance Settings Dialog Box

HG2J-7U HG5G-V HG4G-V HG4G HG3G-V HG3G HG2G-V HG2G-5F HG2G-5T HG1G HG1P

This section describes the items and buttons on the **Preventive Maintenance Settings** dialog box and the **Individual Settings** dialog box.

3.1 Preventive Maintenance Settings Dialog Box

The **Preventive Maintenance Settings** dialog box is used to manage the preventive maintenance settings for each monitored device address.

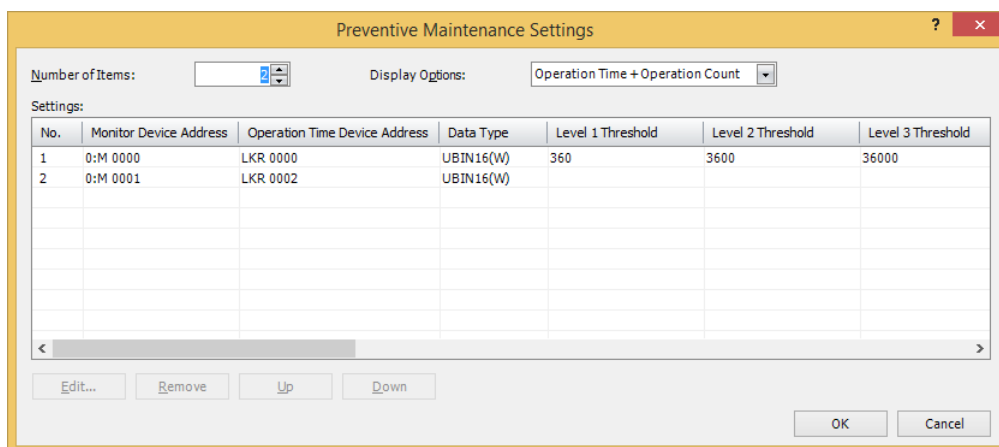

■ Number of Items

Specifies the number of device addresses (1 to 256) to monitor. The numbers for the amount of configured devices is displayed in **Settings**.

■ Display Options

Select the item to display in **Settings** from the following:

- Operation Time: Operation time settings are displayed in **Settings**.
 Operation Count: Operation count settings are displayed in **Settings**.
 Operation Time + Operation Count: Operation time and operation count settings are displayed in **Settings**.

■ Settings

Edits the settings for each number.

- No.: Shows the number of the preventive maintenance settings to manage. Double clicking the cell displays the **Individual Settings** dialog box. For details, refer to "3.2 Individual Settings Dialog Box" on page 17-8.
- Monitor Device Address: Shows the bit device or the bit number of the word device to count the operation time or operation count. Double clicking the cell displays the Tag Editor. For the device address configuration procedure, refer to Chapter 2 "5.1 Device Address Settings" on page 2-70.
- Operation Time Device Address: Shows the destination device address for the counted operation time. You can only specify an HMI Keep Register (LKR). Double clicking the cell displays the Tag Editor. For the device address configuration procedure, refer to Chapter 2 "5.1 Device Address Settings" on page 2-70. This option is displayed only when **Operation Time** or **Operation Time + Operation Count** is selected as **Display Options**.
- Data Type: Shows the date type of the Operation Time Device Address. Double clicking the cell displays the **Individual Settings** dialog box. For details, refer to "3.2 Individual Settings Dialog Box" on page 17-8. This option is displayed only when **Operation Time** or **Operation Time + Operation Count** is selected as **Display Options**.

- Level 1 to 3 Threshold:** Shows the time as a constant or a device address that is the criterion for reporting at level 1 through level 3. For a constant, double clicking the cell displays the **Individual Settings** dialog box. For details, refer to "3.2 Individual Settings Dialog Box" on page 17-8. For a device address, the Tag Editor is displayed. For the device address configuration procedure, refer to Chapter 2 "5.1 Device Address Settings" on page 2-70.
This option is displayed only when **Operation Time** or **Operation Time + Operation Count** is selected as **Display Options**.
- Level 1 to 3 Report Device Address:** Shows the bit device or the bit number of the word device for reporting when the operation time reaches or exceeds the level 1 through level 3 thresholds. Double clicking the cell displays the Tag Editor. For the device address configuration procedure, refer to Chapter 2 "5.1 Device Address Settings" on page 2-70.
This option is displayed only when **Operation Time** or **Operation Time + Operation Count** is selected as **Display Options**.
- Operation Count Device Address:** Shows the destination device address for the counted operation count. You can only specify an HMI Keep Register (LKR).
Double clicking the cell displays the Tag Editor. For the device address configuration procedure, refer to Chapter 2 "5.1 Device Address Settings" on page 2-70.
This option is displayed only when **Operation Count** or **Operation Time + Operation Count** is selected as **Display Options**.
- Data Type:** Shows the date type of the operation count device address. Double clicking the cell displays the **Individual Settings** dialog box. For details, refer to "3.2 Individual Settings Dialog Box" on page 17-8.
This option is displayed only when **Operation Count** or **Operation Time + Operation Count** is selected as **Display Options**.
- Level 1 to 3 Threshold:** Shows the count as a constant or a device address that is the criterion for reporting at level 1 through level 3. For a constant, double clicking the cell displays the **Individual Settings** dialog box. For details, refer to "3.2 Individual Settings Dialog Box" on page 17-8. For a device address, the Tag Editor is displayed. For the device address configuration procedure, refer to Chapter 2 "5.1 Device Address Settings" on page 2-70.
This option is displayed only when **Operation Count** or **Operation Time + Operation Count** is selected as **Display Options**.
- Level 1 to 3 Report Device Address:** Shows the bit device or the bit number of the word device for reporting when the operation count reaches or exceeds the level 1 through level 3 thresholds. Double clicking the cell displays the Tag Editor. For the device address configuration procedure, refer to Chapter 2 "5.1 Device Address Settings" on page 2-70.
This option is displayed only when **Operation Count** or **Operation Time + Operation Count** is selected as **Display Options**.
- **Edit**
Registers or changes the settings for the selected number.
Select a number and click this button to display the **Individual Settings** dialog box. The configured content for the selected number is reflected in the **Individual Settings** dialog box. For details, refer to "3.2 Individual Settings Dialog Box" on page 17-8.
 - **Remove**
Deletes the settings for the selected number.
Select a number and click this button.
 - **Up**
Shifts the selected settings upward in the list.
 - **Down**
Shifts the selected settings downward in the list.

3.2 Individual Settings Dialog Box

The **Individual Settings** dialog box is used to configure the operation time and operation count settings for each monitored device address.

- Number:** Shows the number selected in **Settings** in the **Preventive Maintenance Settings** dialog box. To change the set number, specify a number (1 to 256). You can only specify a number of the amount of devices configured by **Number of Items** in the **Preventive Maintenance Settings** dialog box.
- Monitor Device Address:** Specifies the bit device or the bit number of the word device to count the operation time or operation count.
- Click to display the Tag Editor. For the device address configuration procedure, refer to Chapter 2 "5.1 Device Address Settings" on page 2-70.

● Operation Time Tab

The **Operation Time** tab is used to configure the destination device address for the counted operation time and the report conditions when the threshold is reached or exceeded.

■ Measure Operation Time

Select this check box to count the operation time.

(Operation Time Device Address): Specifies the destination device address for the counted operation time. You can only specify an HMI Keep Register (LKR).

Click to display the Tag Editor. For the device address configuration procedure, refer to Chapter 2 "5.1 Device Address Settings" on page 2-70.



If you specify the same device address as the Operation Time Device Address for multiple numbers, the counted operation time is added in total by all the monitored device addresses for each number and the function will not be able to count normally.

■ Data Type

Select the data type for the Operation Time Device Address as **UBIN16(W)** or **UBIN32(D)**. For details, refer to Chapter 2 "1.1 Available Data" on page 2-1.

■ Report when Operation Time has reached or exceeded Threshold level

Select this check box to report when the counted operation time reaches or exceeds the threshold.

■ (Data Type)

Selects the type of data for the threshold.

Value: Uses a constant as the threshold.

Device Address: Uses a value of device address as the threshold.

■ Level 1

Configures the level 1 threshold and Report Device Address.

Threshold Specifies the time as a constant or a device address that is the criterion for reporting at level 1. For a constant, the range that can be set varies based on the data type. For a device address, click to display the Tag Editor. For the device address configuration procedure, refer to Chapter 2 "5.1 Device Address Settings" on page 2-70.

Report Device Address: Specifies the bit device or the bit number of the word device for reporting when the operation time reaches or exceeds the level 1 threshold.
Click to display the Tag Editor. For the device address configuration procedure, refer to Chapter 2 "5.1 Device Address Settings" on page 2-70.

■ Level 2

Select this check box to configure the level 2 threshold and Report Device Address.

Threshold Specifies the time as a constant or a device address that is the criterion for reporting at level 2. For a constant, the range that can be set varies based on the data type. For a device address, click to display the Tag Editor. For the device address configuration procedure, refer to Chapter 2 "5.1 Device Address Settings" on page 2-70.

Report Device Address: Specifies the bit device or the bit number of the word device for reporting when the operation time reaches or exceeds the level 2 threshold.
Click to display the Tag Editor. For the device address configuration procedure, refer to Chapter 2 "5.1 Device Address Settings" on page 2-70.

■ Level 3

Select this check box to configure the level 3 threshold and Report Device Address.

Threshold Specifies the time as a constant or a device address that is the criterion for reporting at level 3. For a constant, the range that can be set varies based on the data type. For a device address, click to display the Tag Editor. For the device address configuration procedure, refer to Chapter 2 "5.1 Device Address Settings" on page 2-70.

Report Device Address: Specifies the bit device or the bit number of the word device for reporting when the operation time reaches or exceeds the level 3 threshold.
Click to display the Tag Editor. For the device address configuration procedure, refer to Chapter 2 "5.1 Device Address Settings" on page 2-70.

● Operation Count Tab

The **Operation Count** tab is used to configure the destination device address for the counted operation count and the report conditions when the threshold is reached or exceeded.

■ Measure Operation Count

Select this check box to count the operation count.

(Operation Count Device Address): Specifies the destination device address for the counted operation count. You can only specify an HMI Keep Register (LKR).

Click to display the Tag Editor. For the device address configuration procedure, refer to Chapter 2 "5.1 Device Address Settings" on page 2-70.



If you specify the same device address as the operation count device address for multiple numbers, the counted operation count is added in total by all the monitored device addresses for each number and the function will not be able to count normally.

■ Data Type

Select the data type for the operation count device address as **UBIN16(W)** or **UBIN32(D)**. For details, refer to Chapter 2 "1.1 Available Data" on page 2-1.

■ Report when Operation Count has reached or exceeded Threshold level

Select this check box to report when the counted operation count reaches or exceeds the threshold.

■ (Data Type)

Selects the type of data for the threshold.

Value: Uses a constant as the threshold.

Device Address: Uses a value of device address as the threshold.

■ Level 1

Configures the level 1 threshold and Report Device Address.

Threshold Specifies the count as a constant or a device address that is the criterion for reporting at level 1. For a constant, the range that can be set varies based on the data type. For a device address, click to display the Tag Editor. For the device address configuration procedure, refer to Chapter 2 "5.1 Device Address Settings" on page 2-70.

Report Device Address: Specifies the bit device or the bit number of the word device for reporting when the operation count reaches or exceeds the level 1 threshold.

Click to display the Tag Editor. For the device address configuration procedure, refer to Chapter 2 "5.1 Device Address Settings" on page 2-70.

■ Level 2

Select this check box to configure the level 2 threshold and Report Device Address.

Threshold Specifies the count as a constant or a device address that is the criterion for reporting at level 2. For a constant, the range that can be set varies based on the data type. For a device address, click to display the Tag Editor. For the device address configuration procedure, refer to Chapter 2 "5.1 Device Address Settings" on page 2-70.

Report Device Address: Specifies the bit device or the bit number of the word device for reporting when the operation count reaches or exceeds the level 2 threshold.

Click to display the Tag Editor. For the device address configuration procedure, refer to Chapter 2 "5.1 Device Address Settings" on page 2-70.

■ Level 3

Select this check box to configure the level 3 threshold and Report Device Address.

Threshold Specifies the count as a constant or a device address that is the criterion for reporting at level 3. For a constant, the range that can be set varies based on the data type. For a device address, click to display the Tag Editor. For the device address configuration procedure, refer to Chapter 2 "5.1 Device Address Settings" on page 2-70.

Report Device Address: Specifies the bit device or the bit number of the word device for reporting when the operation count reaches or exceeds the level 3 threshold.

Click to display the Tag Editor. For the device address configuration procedure, refer to Chapter 2 "5.1 Device Address Settings" on page 2-70.

4 Using the Data

HG2J-7U HG5G-V HG4G-V HG4G HG3G-V HG3G HG2G-V HG2G-5F HG2G-5T HG1G HG1P

17

Preventive Maintenance Function

4.1 Displaying the Counted Operation Count on a Numerical Display

- 1 On the **Configuration** tab, in the **System Setup** group, click **Preventive Maintenance**.
The **Preventive Maintenance Settings** dialog box is displayed.

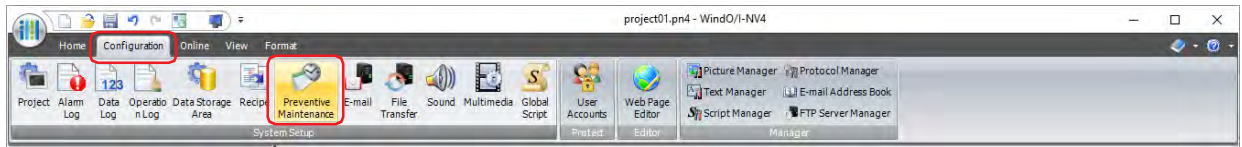

- 2 Specify the number of device addresses to monitor in **Number of Items**.

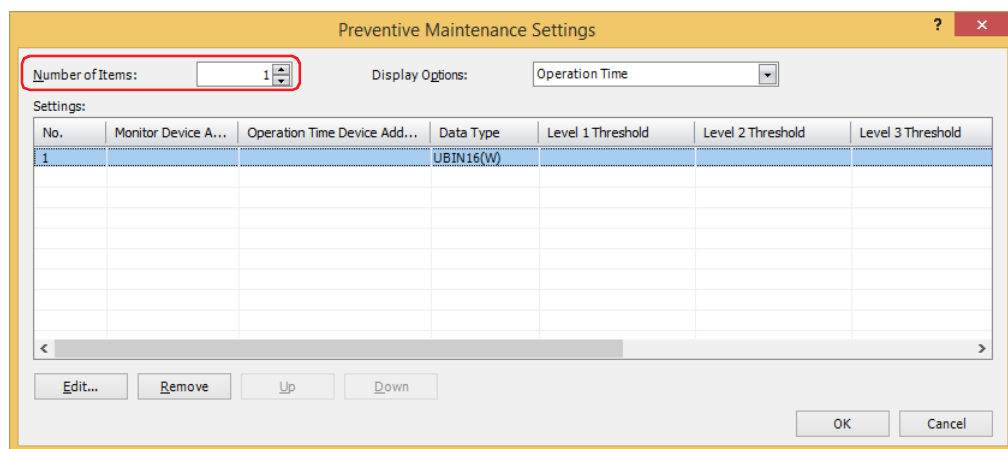

- 3 Select the item to display in **Settings** with **Display Options**.
Select **Operation Count**.
Operation count settings are displayed in **Settings**.
- 4 Select the number to register the Preventive Maintenance settings to in **Settings**, then click **Edit**.
The **Individual Settings** dialog box is displayed.
- 5 Specify the bit device or the bit number of the word device to monitor with **Monitor Device Address**.

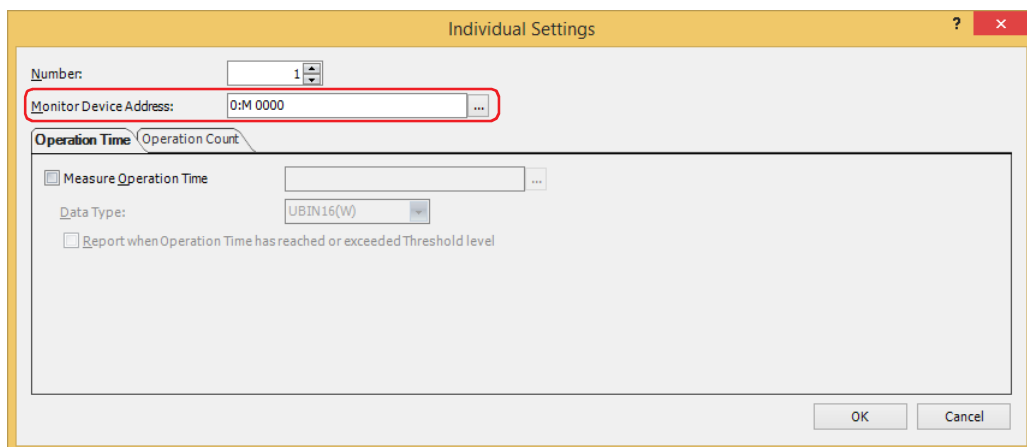

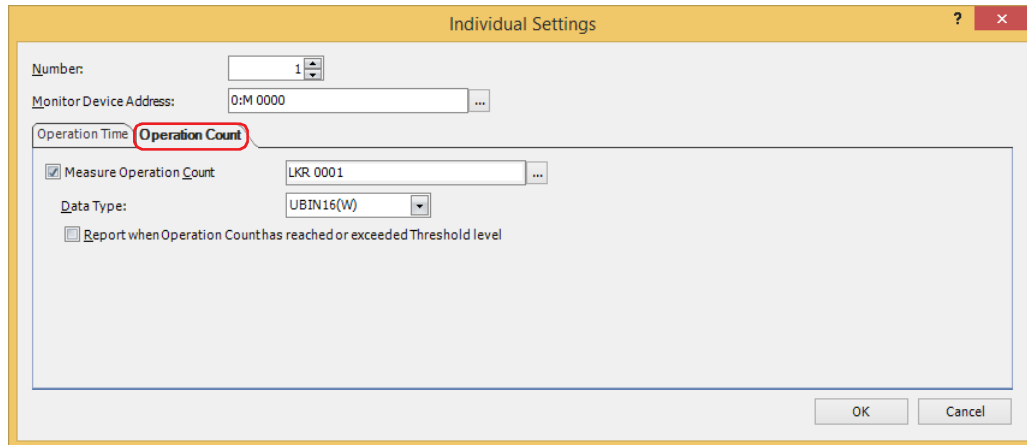
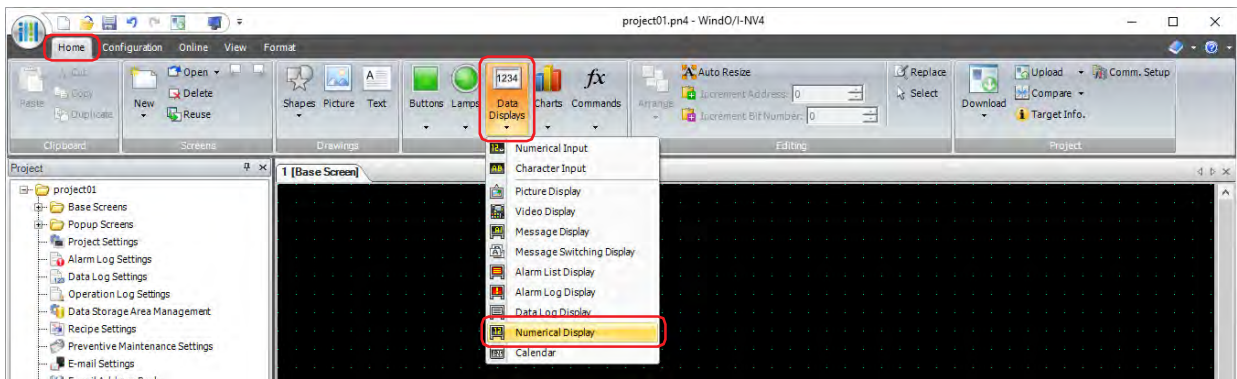
6 Click the **Operation Count** tab.7 Select the **Measure Operation Count** check box and specify the destination device address for the counted operation count.8 Select the data type for the value of **Measure Operation Count** device address with **Data Type**.9 On the **Home** tab, in the **Parts** group, click **Data Displays**, and then click **Numerical Display**.

10 Click a point on the edit screen where you wish to place the Numerical Display.

11 Double-click the placed Numerical Display and the Properties dialog box is displayed.

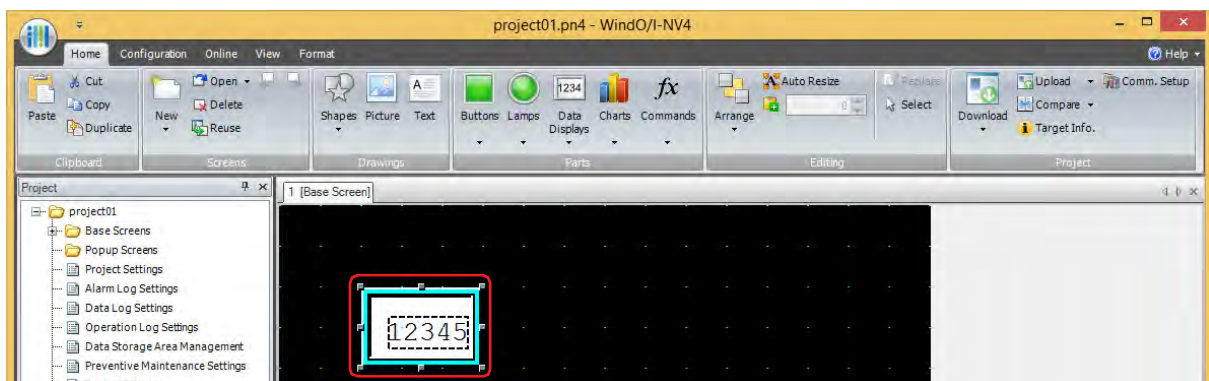

- 12 On the **General** tab, under **Display Type**, click **Decimal**.

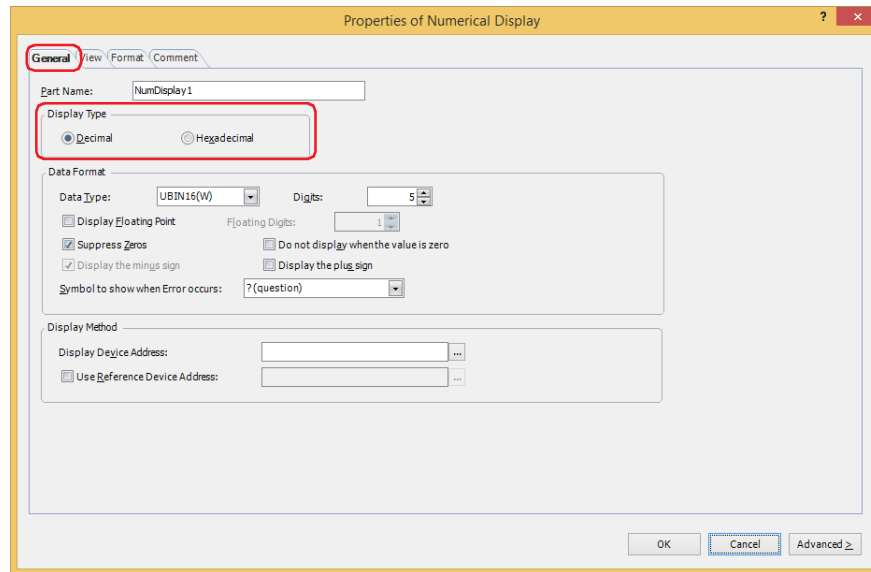

- 13 Under **Data Format**, in **Data Type**, select the data type for the value to display.
Select the same data type as the data type selected on the **Operation Count** tab in the Preventive Maintenance settings **Individual Settings** dialog box.
- 14 Specify **Digits** for the value to display.
The digits that can be set varies based on the display type or data type.
- 15 Under **Display Method**, in **Display Device Address**, specify the destination device address for the counted operation count.
Select the same device address as the device configured with **Measure Operation Count** on the **Operation Count** tab in the Preventive Maintenance settings **Individual Settings** dialog box.
- 16 Click **OK**.
The properties dialog box closes.
This concludes the configuration to display the counted operation count on a Numerical Display.

4.2 Notifying with a Beep when the Counted Operation Time Reaches the Threshold

- 1 On the **Configuration** tab, in the **System Setup** group, click **Preventive Maintenance**.
The **Preventive Maintenance Settings** dialog box is displayed.

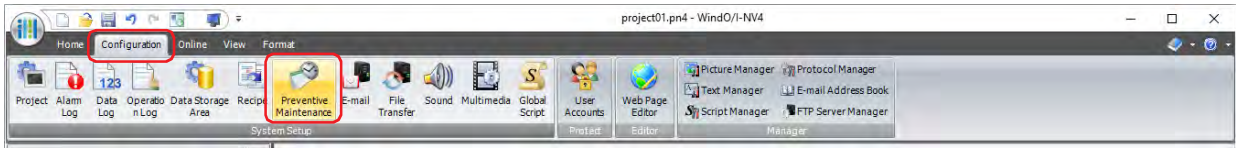

- 2 Specify the number of device addresses to monitor in **Number of Items**.

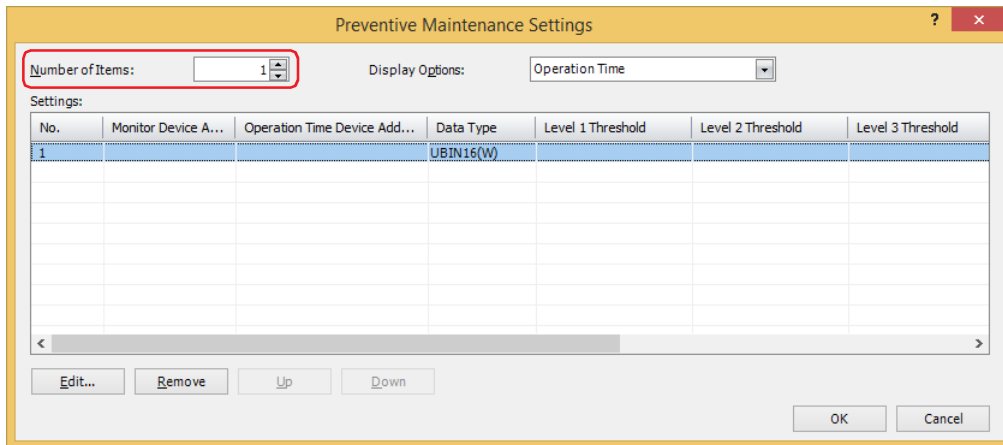

- 3 Select the number to register the Preventive Maintenance settings to in **Settings**, then click **Edit**.
The **Individual Settings** dialog box is displayed.
- 4 Specify the bit device or the bit number of the word device to monitor with **Monitor Device Address**.

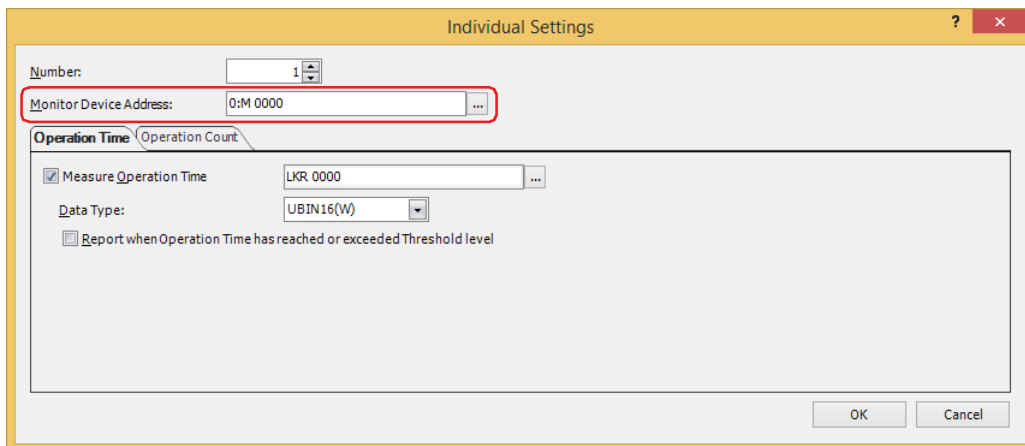

- 5 Select the **Measure Operation Time** check box on the **Operation Time** tab and specify the destination device address for the counted operation time.
- 6 Select the data type for the value of **Measure Operation Time** device address with **Data Type**.

- 7 Select the **Report when Operation Time has reached or exceeded Threshold level** check box.

- 8 Select the type of data for the threshold.

If you select **Value**, specify the threshold as a constant.

If you select **Device Address**, specify the threshold as a value of device address.

- 9 Configure **Threshold** for level 1.

When you select **Value** as the threshold data type, specify the threshold as a constant. The range for the constant that can be set varies based on the data type.

When you select **Device Address** as the threshold data type, specify the threshold as a value of device address. Click  to display the Tag Editor. For the device address configuration procedure, refer to Chapter 2 "5.1 Device Address Settings" on page 2-70.

- 10 Configure **Report Device Address** for level 1.

Specify the bit device or the bit number of the word device for reporting when the threshold is reached or exceeded.

Click  to display the Tag Editor. For the device address configuration procedure, refer to Chapter 2 "5.1 Device Address Settings" on page 2-70.

You can only specify an internal device.

- 11 Click **OK** to close the **Individual Settings** dialog box.

You are returned to the **Preventive Maintenance Settings** dialog box.

- 12 Click **OK**.

The **Preventive Maintenance Settings** dialog box closes.

- 13 On the **Configuration** tab, in the **System Setup** group, click **Alarm Log**.

The **Alarm Log Settings** dialog box is displayed.

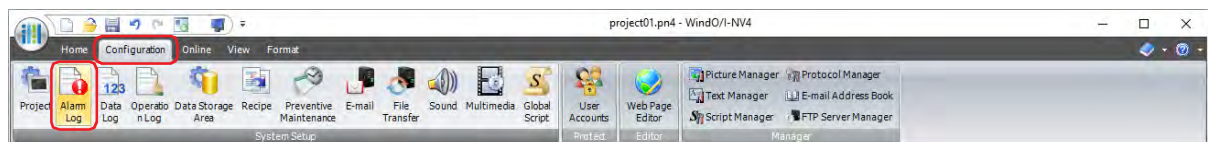

- 14 On the **Channel** tab, under **Source Device Address Type**, select **Bit** and specify **Number of Blocks**.

Alarm Log Settings

General **Channel** External Memory Device Printing Options

Source Device Address Type

Word Bit

Number of Blocks: 1

Reference Screen: Not Use

Settings:

No.	Source	Data	Alarm ...	Level	NO/NC	Lock/...	Text ID	Text ...	Refer...
1-0		Store	Enable	1	NO	Unlock			
1-1		Store	Enable	1	NO	Unlock			
1-2		Store	Enable	1	NO	Unlock			
1-3		Store	Enable	1	NO	Unlock			
1-4		Store	Enable	1	NO	Unlock			
1-5		Store	Enable	1	NO	Unlock			
1-6		Store	Enable	1	NO	Unlock			
1-7		Store	Enable	1	NO	Unlock			
1-8		Store	Enable	1	NO	Unlock			
1-9		Store	Enable	1	NO	Unlock			
1-10		Store	Enable	1	NO	Unlock			
1-11		Store	Enable	1	NO	Unlock			
1-12		Store	Enable	1	NO	Unlock			
1-13		Store	Enable	1	NO	Unlock			
1-14		Store	Enable	1	NO	Unlock			
1-15		Store	Enable	1	NO	Unlock			

Auto... Edit...

OK Cancel

- 15 Select the channel number to register the level 1 Report Device Address to and click **Edit**. The **Individual Settings** dialog box is displayed.
- 16 Specify the level 1 Report Device Address in **Source** and select **Store** under **Data**. Set **Source** to the level 1 Report Device Address configured on the **Operation Time** tab in the Preventive Maintenance settings **Individual Settings** dialog box.

Individual Settings

Channel

Block No.: 1 Channel No.: 0

Block Settings

Source: LM 0000

Data

Store No Store

Channel Settings

Alarm function

Enable Disable

Level: 1

NO/NC

NO NC

Lock/Unlock

Lock Unlock

Text ID:

Text:

Reference Screen Number:

OK Cancel

- 17 Select **Enable** under **Alarm function**, select **NO** under **NO/NC**, and click **OK**.

- 18 On the **Alarm Log Settings** dialog box, switch the alarm function for all the unused channel numbers to **Disable**. Select all the unused channels with the **Shift** key + click or the **Ctrl** key + click and click **Edit**. The **Individual Settings** dialog box is displayed.

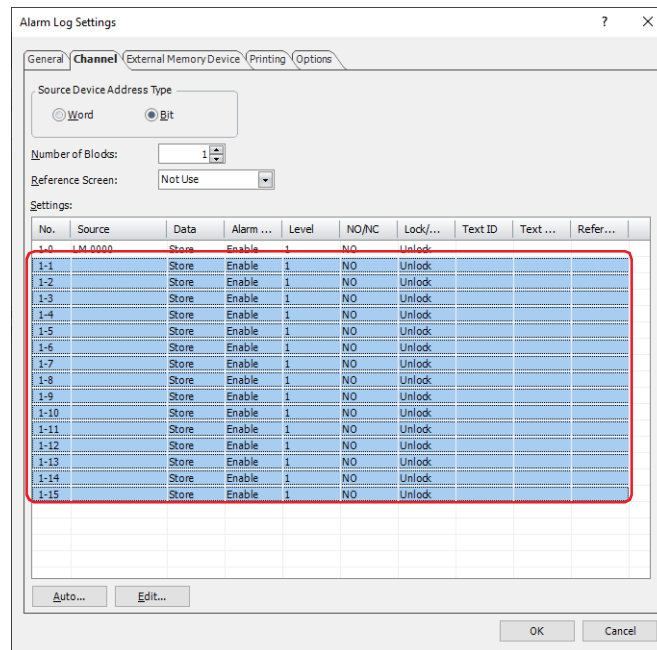

Under **Channel Settings - Alarm function**, select **Disable** and click **OK**.

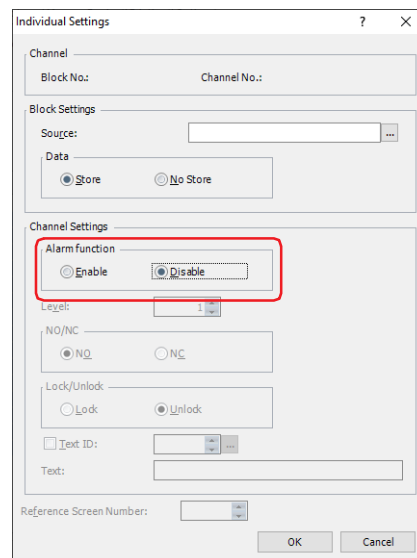

- 19 Click the **Options** tab in the **Alarm Log Settings** dialog box.

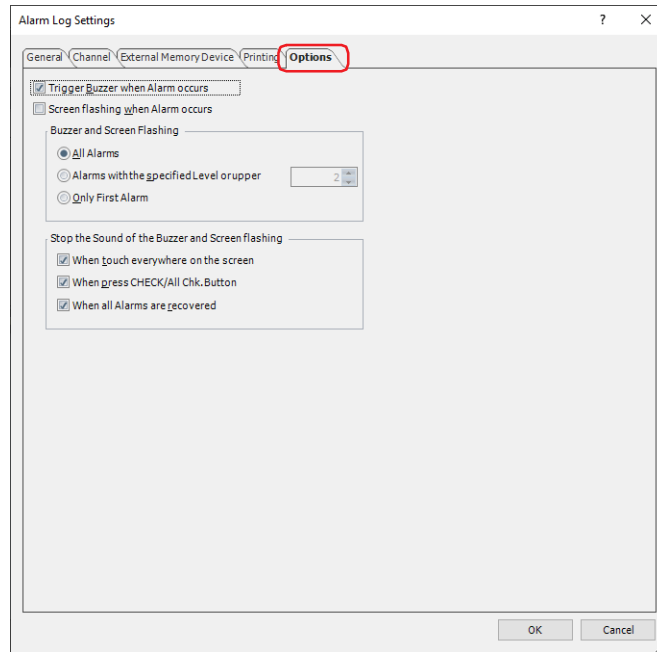

- 20 Select the **Trigger Buzzer when Alarm occurs** check box.

- 21 Click **OK**.

The **Alarm Log Settings** dialog box closes.

This concludes the configuration to notify with a beep when the counted operation time reaches the threshold.

Chapter 18 Recipe Function

This chapter describes how to configure the Recipe function and its operation on the MICRO/I.

1 Overview

HG2J-7U HG5G-V HG4G-V HG4G HG3G-V HG3G HG2G-V HG2G-5F HG2G-5T HG1G HG1P

1.1 How the Recipe Function is Used

The Recipe function writes values prepared in advance to specified device addresses and reads the values for specified device addresses according to the state of a device address in a batch. Use this function for situations such as configuring the initial values of an external device when the MICRO/I starts running. The data used by the Recipe function is called recipe data for the data saved in internal memory, a recipe file for data saved to the external memory device, and recipe values for the values written to device addresses that were saved in recipe data and recipe files. The Recipe function can perform the following functions.

- Batch write the recipe values saved in internal memory to device addresses when a value of device address changes from 0 to 1

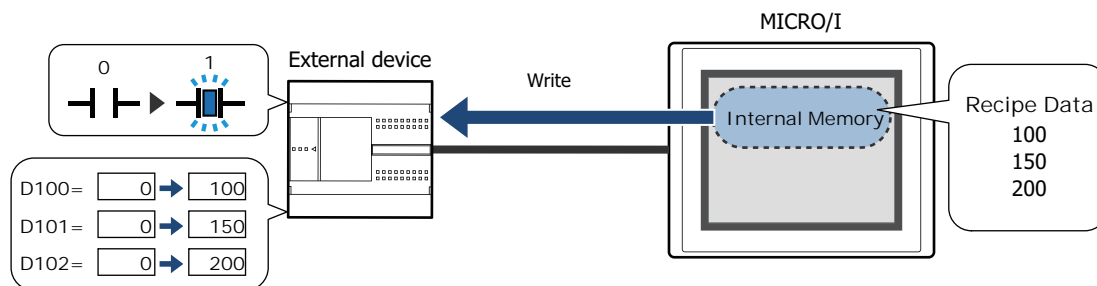

- Batch write the recipe values saved on the external memory device^{*1} to device addresses when a value of device address changes from 0 to 1

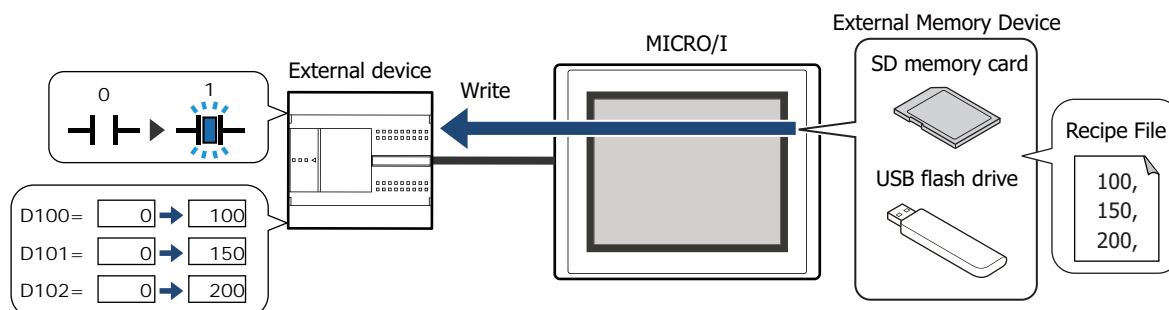

- Batch read values of device addresses and save them to the external memory device^{*1} as a recipe file when a value of device address changes from 0 to 1

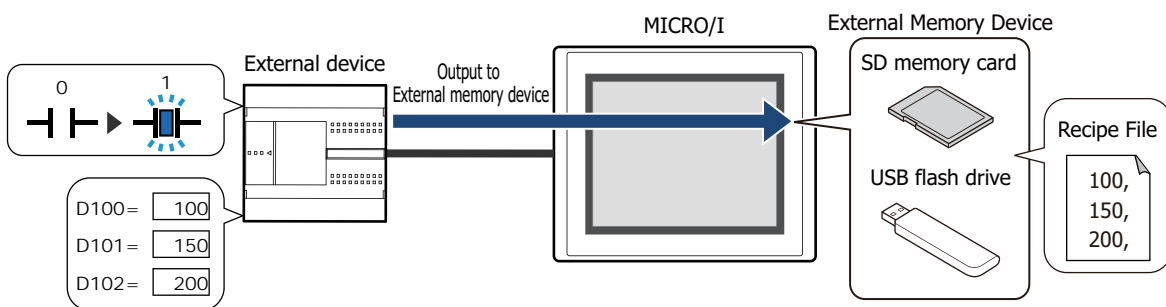

The values of device addresses can be retained when the power is turned off by reading values of device addresses to the external memory device and saving them as a recipe file and then writing those values the next time the power is turned on.

*1 USB flash drive inserted in USB1 for HG2J-7U, SD memory card for HG5G/4G/3G/2G-V, HG4G/3G and HG2G-5F, USB flash drive for HG2G-5T and HG1G/1P

1.2 Data for Recipes

The data handled by the Recipe function is based on the top device address and the amount of data selected.

Example: The top device address is D100 and the amount of data is 10.

Device Address	Value
D100	1111
D101	2222
D102	3333
D103	4444
D104	5555
D105	6666
D106	7777
D107	8888
D108	9999
D109	11111

1.3 Data Configuration

The relationship between the Recipe function settings and the data for recipes is as follows.

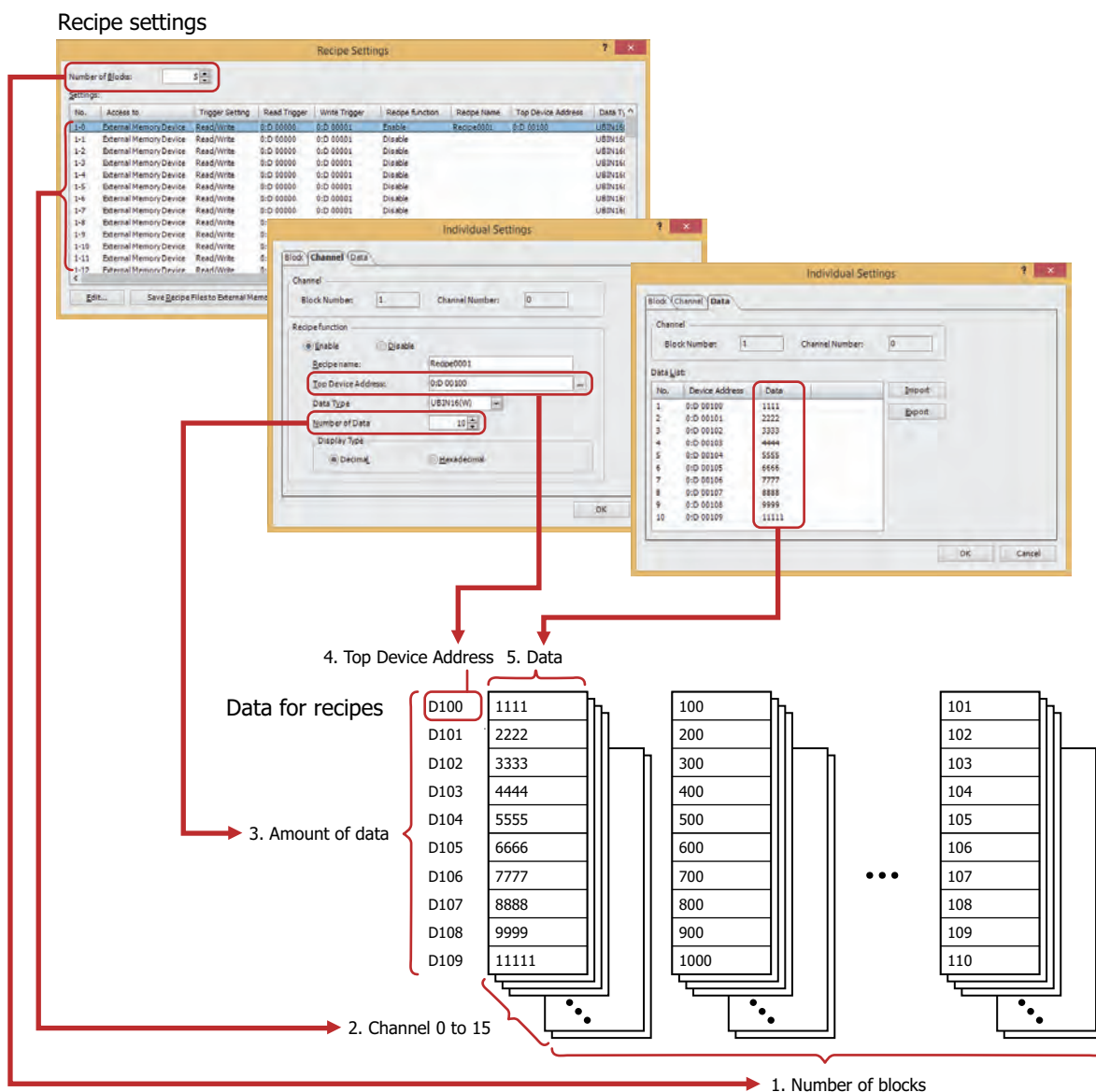

1. Number of blocks: The operation using the data for the recipe is configured in blocks (0 to 64). 1 block is 16 channels.
2. Channels: Destination device addresses and recipe values are configured in channels. 1 channel is used for 1 item of data for the recipe.
3. Amount of data: The amount of data configured for one channel. The maximum amount of data that can be configured is 8192.
4. Top Device Address: The start address of the destination device addresses for recipe values and the source device addresses for values of device addresses.
5. Data: The values to write to the device addresses.



If there are many word devices for the data for the recipe, it will take time to read and write them. For example, when using the Recipe function to configure initial values, if other processes are executed before the function is finished writing all the settings, you may experience unexpected results. Monitor System Area 2 Transferring recipe bit (address number+3, bit4) while the recipe is transferring and wait until reading and writing the data for the recipe is finished before executing other processes. For details, refer to Chapter 4 "System Area" on page 4-30.



If **Float32(F)** is selected for **Data Type** on the **Channel** tab, the values of device addresses that were read are saved to the recipe file in the floating point type. However, when a value that was read is 8 digits or larger, it is saved in the exponential type.

2 Recipe Function Configuration Procedure

HG2J-7U HG5G-V HG4G-V HG4G HG3G-V HG3G HG2G-V HG2G-5F HG2G-5T HG1G HG1P

This section describes the configuration procedure for the Recipe function.

2.1 Configuring Recipe Function Operations and Device Addresses

- 1 On the **Configuration** tab, in the **System Setup** group, click **Recipe**.

The **Recipe Settings** dialog box is displayed.



- 2 Specify the number of blocks to use as data for the recipe in **Number of Blocks**.

The operation using the data for the recipe is configured in blocks (0 to 64). 1 channel is used for 1 item of data for the recipe. 1 block is 16 channels.

The maximum number of blocks that can be configured is 64 blocks. The maximum number of device addresses that can be configured for 1 channel is 8192 devices.

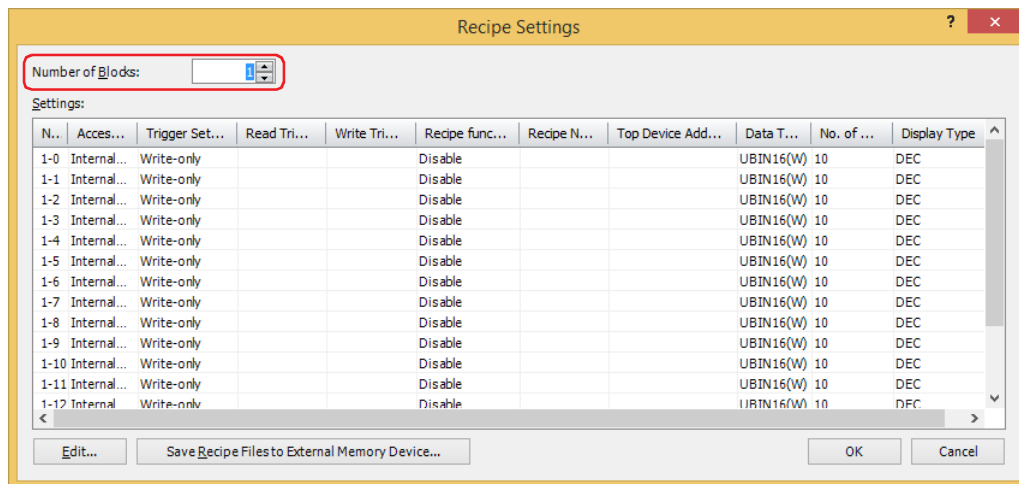

- 3 Select the number of the data for the recipe to configure in **Settings**, then click **Edit**.

The **Individual Settings** dialog box is displayed.

- 4 On the **Channel** tab, under **Recipe function**, select **Enable**.

The channel for the block number displayed in **Channel** is enabled.

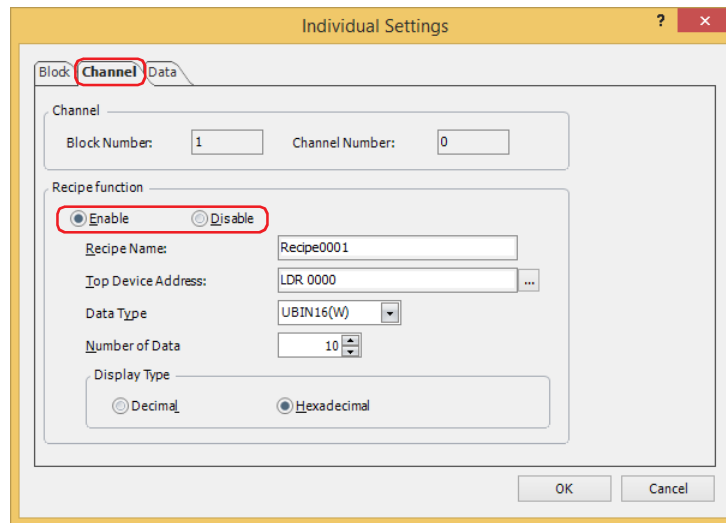

- 5 Enter the name for the Recipe function in **Recipe Name**.

The maximum number is 40 characters.

- 6 Specify the destination device address for the Recipe values in **Top Device Address**.

To read values of device addresses and save them as a recipe file, specify the source device address of the values.

Click **...** to display the Tag Editor.

For the device address configuration procedure, refer to Chapter 2 "5.1 Device Address Settings" on page 2-70.

The specified device addresses are configured sequentially from the number 1 in **Data List** on the **Data** tab.

- 7 Select the data type for the values to write with **Data Type**.

To read values of device addresses and save them as a recipe file, specify the type of data for the read values.

- 8 With **Number of Data**, specify the number of destination device addresses starting with the device address configured by **Top Device Address**.

To read values of device addresses and save them as a recipe file, specify the number of source device addresses.

The sequential device addresses from the start address for the number of configured device addresses are displayed in **Settings** on the **Data** tab.

The amount of data that can be set varies based on the data type. When **UBIN16(W)**, **BIN16(I)**, or **BCD4(B)** is selected for **Data Type**, up to 8192 items of data can be configured. When **UBIN32(D)**, **BIN32(L)**, **BCD8(EB)**, or **Float32(F)** is selected, up to 4096 items of data can be configured.

- 9 With **Display Type**, select the display type for **Data** to configure in **Data List** on the **Data** tab.

To save data to a recipe file, the display type is decimal for all.

- 10 Click the **Data** tab.

Individual Settings

Block Channel **Data**

Channel

Block Number: 1 Channel Number: 0

Data List:

No.	Device Address	Data
1	LDR 0000	1111
2	LDR 0001	2222
3	LDR 0002	3333
4	LDR 0003	4444
5	LDR 0004	5555
6	LDR 0005	6666
7	LDR 0006	7777
8	LDR 0007	8888
9	LDR 0008	9999
10	LDR 0009	11111

Import Export

OK Cancel

The data for the recipe in the amount specified by **Number of Data** on the **Channel** tab is configured in **Data List**. In **Device Address**, the devices are sequentially configured starting from the device address specified by **Top Device Address**.

- 11 Double click the data cell for each number in **Data List** to enter the value to write to the device address.

The value for the device address that can be configured varies based on **Data Type** and **Display Type** configured on the **Channel** tab.

When **Read-only** is selected under **Trigger Setting** on the **Block** tab, entering values of device addresses is unnecessary.

- 12 Click the **Block** tab.

Individual Settings

Block Channel Data

Access to

External Memory Device Internal Memory

File Name RCP0001 .CSV

Trigger Setting

Read/Write Read-only Write-only

Read Trigger: 0:D 00000 Device Address >> Recipe

Write Trigger: 0:D 00001 Recipe >> Device Address

Monitoring Period (x100 msec): 20
(Monitoring Period is determined in Alarm Log Settings)

OK Cancel

- 13 Select the destination to save recipe data to under **Access to**.

This option is set by block.

■ **External Memory Device***1

Use a recipe file saved to the external memory device.

■ **Internal Memory**

Use recipe data saved to internal memory.

If you selected **Internal Memory**, proceed to step 17.

*1 USB flash drive inserted in USB1 for HG2J-7U, SD memory card for HG5G/4G/3G/2G-V, HG4G/3G and HG2G-5F, USB flash drive for HG2G-5T and HG1G/1P

14 Enter the file name for the recipe file in **File Name**.

The default file name is "RCP n .CSV". (n : 4 digit sequential number)

To change the file name, enter a new file name. The maximum number is 120 characters (including the extension).

The file is overwritten when there is a recipe file with the same name on the external memory device.

15 Select the operation using the data for the recipe under **Trigger Setting**.

This option is set by block.

- **Read/Write**

Save batch read values of device addresses to the external memory device as a recipe file or write them to device addresses as recipe values.

This option can only be configured when **External Memory Device** is selected under **Access to**.

- **Read-only**

Save batch read values of device addresses to the external memory device as a recipe file.

This option can only be configured when **External Memory Device** is selected under **Access to**.

- **Write-only**

Write recipe values to device addresses.

If you select **Write-only**, proceed to step **17**.

16 Specify the device address that triggers batch reading values of device addresses and saving them to the external memory device as a recipe file in **Read Trigger**.

This option is set by block.

Click to display the Tag Editor.

For the device address configuration procedure, refer to Chapter 2 "5.1 Device Address Settings" on page 2-70.

This option can only be configured when **Read/Write** or **Read-only** is selected under **Trigger Setting**.

If you selected **Read-only**, proceed to step **18**.

17 Specify the device address that triggers batch writing recipe values to device addresses in **Write Trigger**.

This option is set by block.

Click to display the Tag Editor.

For the device address configuration procedure, refer to Chapter 2 "5.1 Device Address Settings" on page 2-70.

This option can only be configured when **Read/Write** or **Write-only** is selected under **Trigger Setting**.

18 Click **OK** to close the **Individual Settings** dialog box.

You are returned to the **Recipe Settings** dialog box.

19 Repeat steps **3** through **18** to register data for the recipe to all the used channels.**20** Click **OK**.

The **Recipe Settings** dialog box closes.

For details on how to create and edit the data for recipes, refer to "4 Creating and Deleting Data for Recipes" on page 18-14.

3 Recipe Settings Dialog Box

HG2J-7U HG5G-V HG4G-V HG4G HG3G-V HG3G HG2G-V HG2G-5F HG2G-5T HG1G HG1P

This section describes the items and buttons on the **Recipe Settings** dialog box and the **Individual Settings** dialog box.

3.1 Recipe Settings Dialog Box

Use the **Recipe Settings** dialog box to collectively manage the save destination of data for recipes, the device addresses for writing recipe values and reading values of device addresses, and those execution conditions.

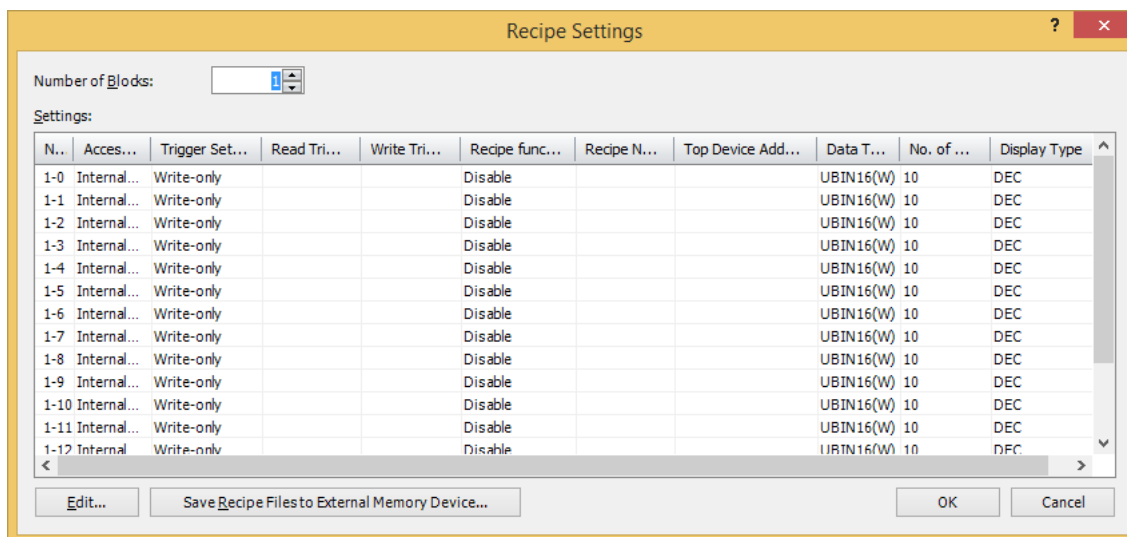

■ Number of Blocks

The operation using the data for the recipe is configured in blocks (0 to 64). 1 channel is used for 1 item of data for the recipe. 1 block is 16 channels.

The maximum number of blocks that can be configured is 64 blocks. The maximum number of device addresses that can be configured for 1 channel is 8192 devices.

■ Settings

Edits the recipe settings for each channel.

- No.:
- Displayed as (Block No.)-(Channel No.). Double clicking the cell displays the **Individual Settings** dialog box. For details, refer to "3.2 Individual Settings Dialog Box" on page 18-10.
- Access to:
- Shows the save destination for the data for the recipe. Double clicking the cell switches between **Internal Memory** and **External Memory Device**.
- Trigger Setting:
- Shows the operation using the data for the recipe. When **External Memory Device** is selected for **Access to**, double clicking the cell switches between **Write-only**, **Read/Write**, and **Read-only**. Shows **Write-only** when **Internal Memory** is selected for **Access to**.
- Read Trigger:
- Shows the device address that triggers saving the recipe file. Double clicking the cell displays the Tag Editor. For the device address configuration procedure, refer to Chapter 2 "5.1 Device Address Settings" on page 2-70.
- This option can only be configured when **Read/Write** or **Read-only** is selected under **Trigger Setting**.
- Write Trigger:
- Shows the device address that triggers writing recipe values to device addresses. Double clicking the cell displays the Tag Editor. For the device address configuration procedure, refer to Chapter 2 "5.1 Device Address Settings" on page 2-70.
- This option can only be configured when **Read/Write** or **Write-only** is selected under **Trigger Setting**.
- Recipe function:
- Shows whether or not to use the Recipe function. Double clicking the cell switches between **Enable** and **Disable**.

- Recipe Name:** Shows the name of the Recipe function for each channel. Double clicking the cell displays the **Individual Settings** dialog box. For details, refer to “3.2 Individual Settings Dialog Box” on page 18-10.
- Top Device Address:** Shows the start device of the destination device addresses for recipe values and the source device addresses for values of device addresses. Double clicking the cell displays the Tag Editor. For the device address configuration procedure, refer to Chapter 2 “5.1 Device Address Settings” on page 2-70.
This option can only be configured when **Recipe function** is **Enable**.
- Data Type:** Shows the data type of the values of source or destination device addresses. Double clicking the cell displays the **Individual Settings** dialog box. For details, refer to “3.2 Individual Settings Dialog Box” on page 18-10.
- No. of Data:** Shows the number of source or destination device addresses starting with the device address configured by **Top Device Address**. Double clicking the cell displays the **Individual Settings** dialog box. For details, refer to “3.2 Individual Settings Dialog Box” on page 18-10.
- Display Type:** Shows the display type of **Data** in **Data List** configured on the **Data** tab in the **Individual Settings** dialog box. Double clicking the cell displays the **Individual Settings** dialog box. For details, refer to “3.2 Individual Settings Dialog Box” on page 18-10.

■ Edit

Registers or changes the settings for the selected number.

Select a number in **Settings** and click this button to display the **Individual Settings** dialog box. The settings for the selected channel are reflected in the **Individual Settings** dialog box.

For details, refer to “3.2 Individual Settings Dialog Box” on page 18-10.



To register or edit multiple numbers as a group, press and hold SHIFT or CTRL while you click the specific items to select multiple lines and click **Edit**. The details configured on the **Individual Settings** dialog box are collectively configured.

■ Save Recipe Files to External Memory Device

Saves all the settings in every channel on the **Recipe Settings** dialog box to the external memory device as a recipe file.

Click this button to display the **Select Drive** dialog box.

Only saves channels configured with **Access to** set to **External Memory Device** and **Recipe Function** set to **Enable**.

3.2 Individual Settings Dialog Box

Use the **Individual Settings** dialog box to register or edit the recipe settings for the selected channel.

● Block Tab

The **Block** tab is used to configure settings that are managed by blocks such as the save destination for the data for the recipe to use, the Recipe function operation, and the operation trigger.

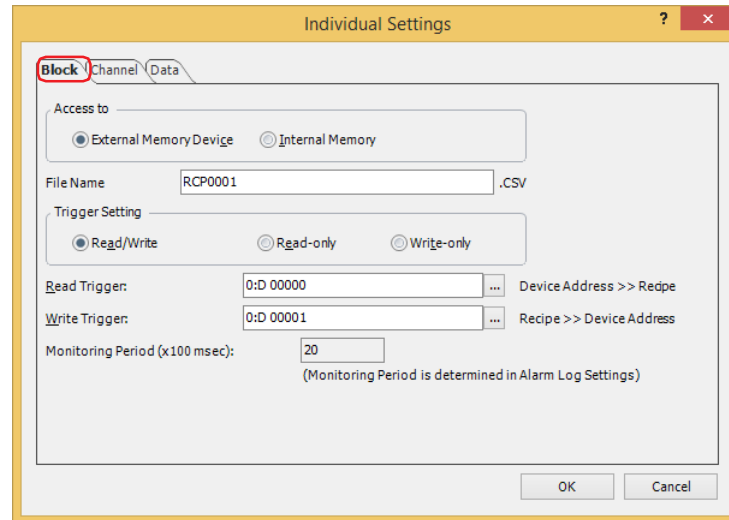

■ Access to

Selects the save destination for data for the recipe to use when writing values to device addresses.

External Memory Device^{*1}: Uses a recipe file saved to the external memory device.

Requires an external memory device with a saved recipe file. For details, refer to "4.2 Creating Recipe Files" on page 18-17.

Internal Memory:

Uses recipe data saved to internal memory.

Since recipe data is handled as a portion of project data, it may put pressure on the volume of project data that can be downloaded. One item of recipe data uses 2 bytes when the top device address data type is 16 bits and it uses 4 bytes when the top device address data type is 32 bits.

Example: When the top device address data type is 16 bits and using 1 block of 16 channels of recipe data with a data amount of 10

$$2 \times 10 \times 1 \times 16 = 320 \text{ bytes}$$

When the top device address data type is 32 bits and using 64 blocks of 16 channels of recipe data with a data amount of 100

$$4 \times 100 \times 64 \times 16 = 409.6 \text{ kilobytes}$$

■ File Name

Enter the file name of the recipe file to save on the external memory device.

The default file name is "RCP n .CSV". (n : 4 digit sequential number)

To change the file name, enter a new file name. The maximum number is 120 characters (including the extension).

The file is overwritten when there is a recipe file with the same name on the external memory device.

*1 USB flash drive inserted in USB1 for HG2J-7U, SD memory card for HG5G/4G/3G/2G-V, HG4G/3G and HG2G-5F, USB flash drive for HG2G-5T and HG1G/1P

■ Trigger Setting

Selects the operation using the data for the recipe.

- Read/Write: Saves batch read values of device addresses to the external memory device as a recipe file and writes them to device addresses as recipe values.
This option can only be configured when **External Memory Device** is selected under **Access to**.
- Read-only: Saves batch read values of device addresses to the external memory device as a recipe file.
This option can only be configured when **External Memory Device** is selected under **Access to**.
- Write-only: Writes recipe values to device addresses.



If **Float32(F)** is selected for **Data Type** on the **Channel** tab, the values of device addresses that were read are saved to the recipe file in the floating point type. However, when a value that was read is 8 digits or larger, it is saved in the exponential type.

■ Read Trigger

Specifies the device address that triggers batch reading values of device addresses and saving them to the external memory device as a recipe file.

Click  to display the Tag Editor. For the device address configuration procedure, refer to Chapter 2 "5.1 Device Address Settings" on page 2-70.

This option can only be configured when **Read/Write** or **Read-only** is selected under **Trigger Setting**.



Each bit of the word device configured by the read trigger device address corresponds to a channel. When a bit changes from 0 to 1, a read to the device address is executed.

Example: When the block 1 read trigger device address is specified as LDR0000
LDR0000-0 corresponds to channel 1-0, LDR0000-1 to channel 1-1, through to LDR0000-15 which corresponds to channel 1-15.

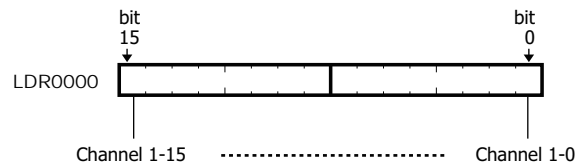

■ Write Trigger

Specifies the device address that triggers batch writing recipe values to device addresses by block.

Click  to display the Tag Editor. For the device address configuration procedure, refer to Chapter 2 "5.1 Device Address Settings" on page 2-70.

This option can only be configured when **Read/Write** or **Write-only** is selected under **Trigger Setting**.



Each bit of the word device configured by the write trigger device address and the read trigger device address corresponds to a channel.

When a bit changes from 0 to 1, a write to the device address is executed.

Example: When the block 1 write trigger device address is specified as LDR0000
LDR0000-0 corresponds to channel 1-0, LDR0000-1 to channel 1-1, through to LDR0000-15 which corresponds to channel 1-15.

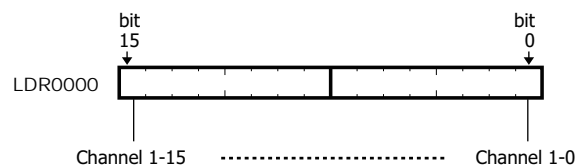

■ Monitoring Period

Shows the period to monitor the write trigger device address and the read trigger device address. This period is for detecting alarms so it is the same as the period to monitor states of device addresses. This option is configured on the **General** tab in the **Alarm Log Settings** dialog box.



- If **Access to** is set to **External Memory Device** and no recipe file exists in the "RECIPE" folder located in the External Memory Device folder on the external memory device, the recipe values are not written to the device addresses.
- If value of device address reads and recipe value writes occur simultaneously, first the values of device addresses are read, then the recipe values are written.

● Channel Tab

The **Channel** tab is used to configure the recipe name for the selected channel and the device addresses to read and write values to.

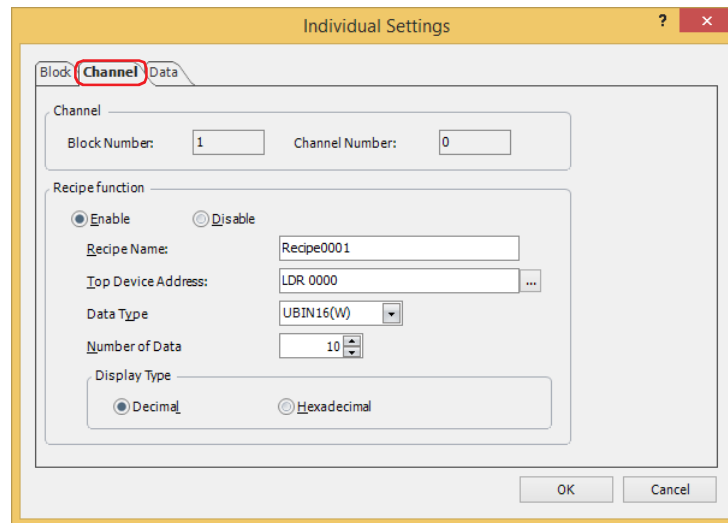

■ Channel

Shows the block number and the channel number for the selected channel.

Block Number: Shows the block number for the channel selected in **Settings**.

Channel Number: Shows the channel number for the channel selected in **Settings**.

■ Recipe function

Selects whether or not to use the Recipe function.

Enable: Writes recipe values to device addresses, reads values of device addresses and saves them to the external memory device as a recipe file.

Disable: The Recipe function is not used.

■ Recipe Name

Enter the name for the Recipe function to differentiate the channel. The maximum number is 40 characters. The default is "Recipe*n*". (*n*: 4 digit sequential number)

■ Top Device Address

Specifies the start device address of the destination device addresses for recipe values and the source device addresses for values of device addresses.

Click  to display the Tag Editor. For the device address configuration procedure, refer to Chapter 2 "5.1 Device Address Settings" on page 2-70.

The specified device addresses are configured sequentially from the number 1 in **Data List** on the **Data** tab.

■ Data Type

Selects the type of data for recipe values to write and values of device addresses that are read. For details, refer to Chapter 2 "1.1 Available Data" on page 2-1.

■ Number of Data

Specifies the number of source or destination device addresses starting with the device address configured by **Top Device Address**.

The sequential device addresses from the start address for the number of configured device addresses is displayed in **Settings** on the **Data** tab.

The amount of data that can be set varies based on the data type. When **UBIN16(W)**, **BIN16(I)**, or **BCD4(B)** is selected for **Data Type**, up to 8192 items of data can be configured. When **UBIN32(D)**, **BIN32(L)**, **BCD8(EB)**, or **Float32(F)** is selected, up to 4096 items of data can be configured.

■ Display Type

Selects the display type for **Data** in **Data List** configured on the **Data** tab as **Decimal** or **Hexadecimal**.

Values when saving data to a recipe file are decimal.

● Data Tab

The **Data** tab is used to configure recipe values written to device addresses.

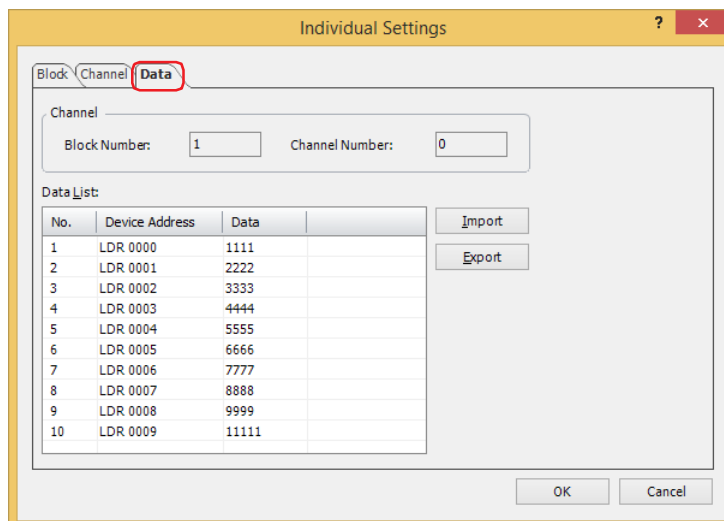

■ Channel

Shows the block number and the channel number for the selected channel.

Block Number: Shows the block number for the channel selected in **Settings**.

Channel Number: Shows the channel number for the channel selected in **Settings**.

■ Data List

Enter the recipe values to write to device addresses for each number in the selected channel.

No.: Shows the data numbers for the amount of data specified by **Number of Data**.

Device Address: Devices are sequentially configured starting from the device address specified by **Top Device Address** on the **Channel** tab.

Data: Double click a cell to enter a recipe value. The value that can be configured varies based on **Data Type** and **Display Type** configured on the **Channel** tab.
When **Read-only** is selected under **Trigger Setting** on the **Block** tab, entering recipe values is unnecessary.

■ Import

Displays the **Open** dialog box.

Select a recipe file and click **Open** to overwrite the data in **Data List** with the selected recipe file.

■ Export

Displays the **Save As** dialog box.

Select the location to save the recipe file, enter a file name, and then click **Save** to save the recipe file for the selected channel.

The saved recipe file can be edited using Notepad, commercially available text editors, and spreadsheet software.

4 Creating and Deleting Data for Recipes

HG2J-7U HG5G-V HG4G-V HG4G HG3G-V HG3G HG2G-V HG2G-5F HG2G-5T HG1G HG1P

4.1 Editing Recipe Data

You can export recipe data for the selected channel, edit the recipe values in a saved file, and import a recipe file back into WindO/I-NV4.

- 1 On the **Configuration** tab, in the **System Setup** group, click **Recipe**.

The **Recipe Settings** dialog box is displayed.

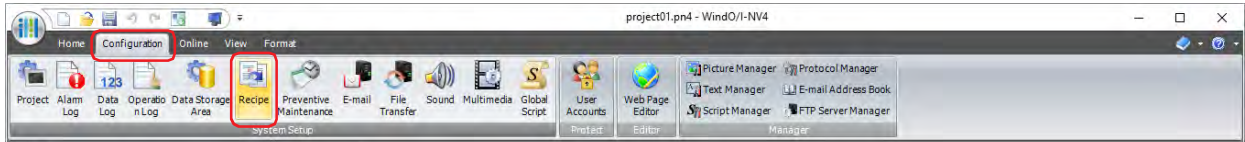

- 2 Select the channel number to export its recipe data in **Settings**, then click **Edit**.

The **Individual Settings** dialog box is displayed.

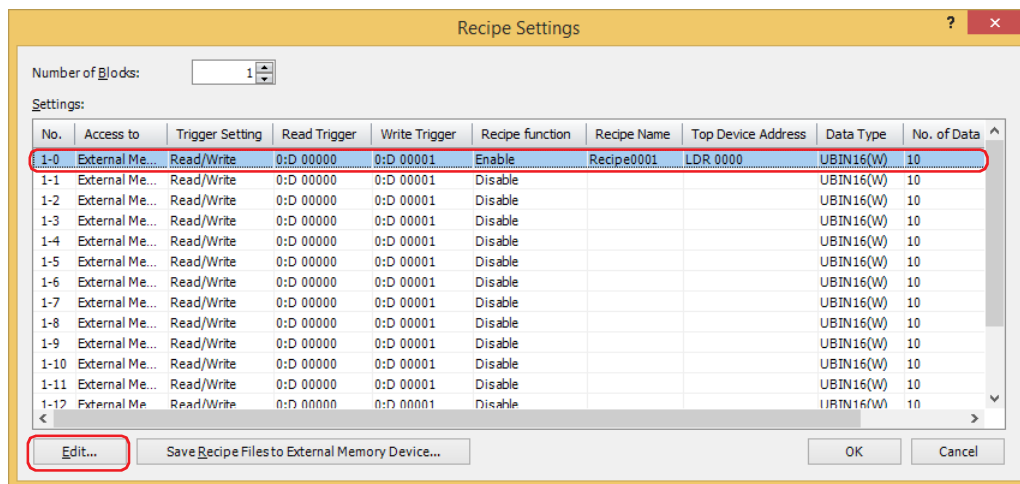

- 3 Click the **Data** tab, then click **Export**.

The **Save As** dialog box is displayed.

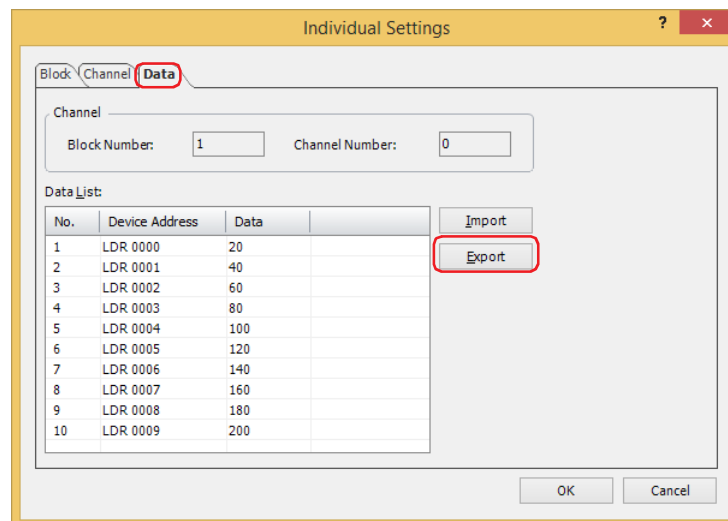

4 Specify the save location and click **Save**.

The file name specified on the **Block** tab in the **Individual Settings** dialog box is entered in **File name**.

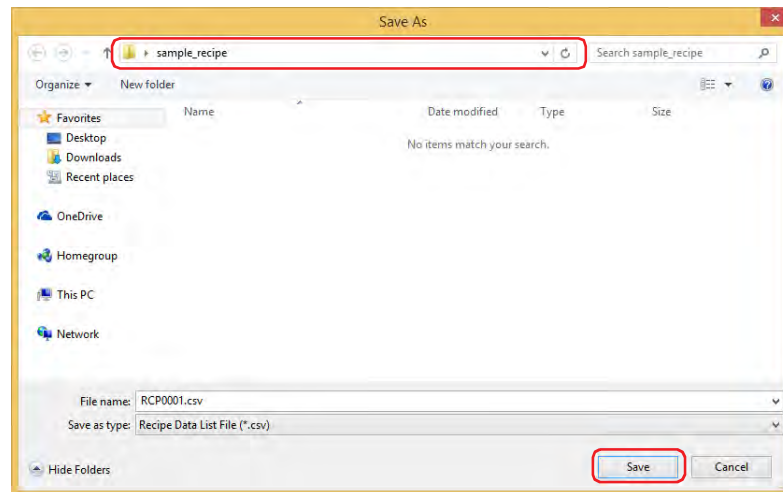

5 Open the exported recipe data file.

Use Notepad, a commercially available text editor, or spreadsheet software.

6 Edit the values and save the file.

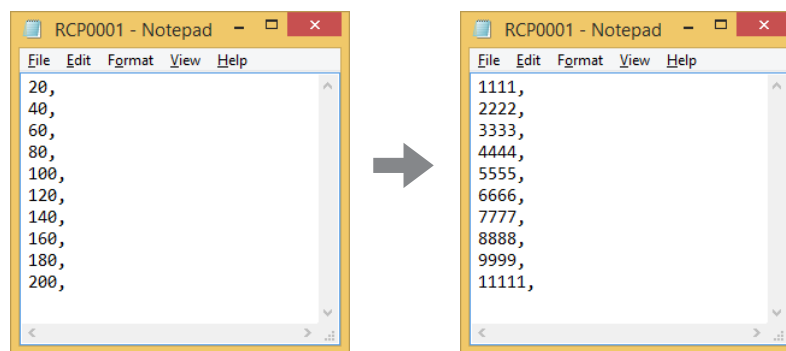

7 Return to the **Data** tab in the **Individual Settings** dialog box and click **Import**.

The **Open** dialog box is displayed.

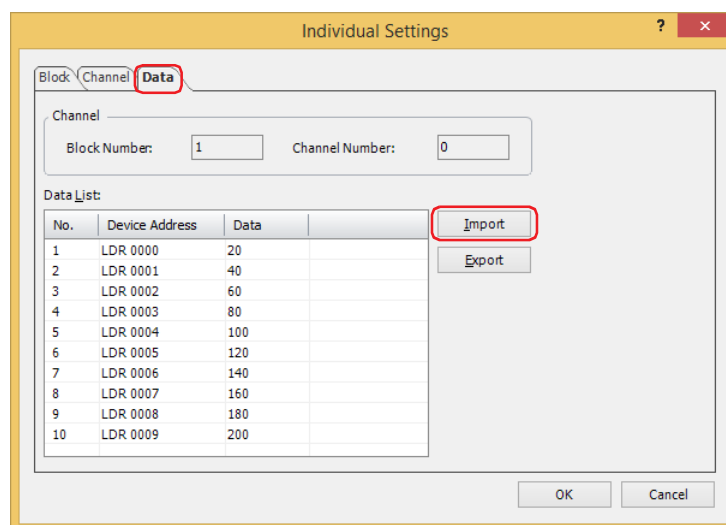

- 8 Specify the file and click **Open**.

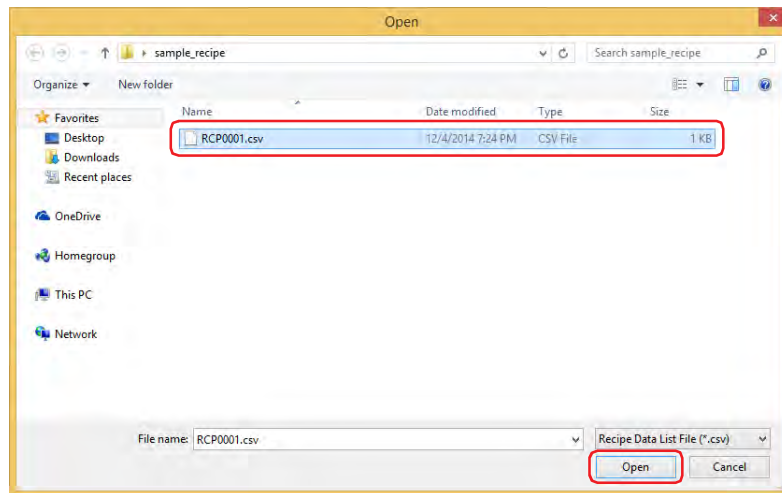

The recipe data is imported.

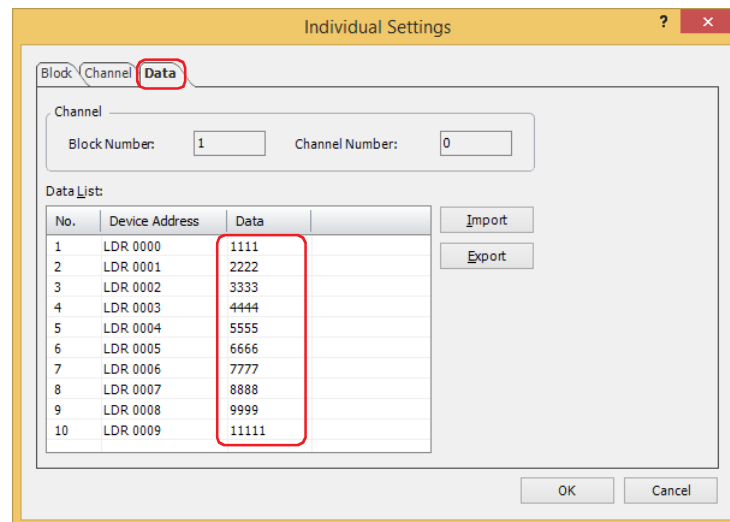

- 9 Click **OK**.

The **Individual Settings** dialog box closes.

- 10 Click **OK**.

The **Recipe Settings** dialog box closes.

This concludes editing recipe data.

4.2 Creating Recipe Files

Recipe files can be created on the external memory device*¹ with the following procedure. The recipe values configured on the **Data** tab in the **Individual Settings** dialog box are saved in recipe files.

☞ "Creating Recipe Files in the Recipe Settings Dialog Box" on page 18-17

☞ "Creating Recipe Files when Downloading Project Data" on page 18-19

☞ "Creating Recipe Files with a Text Editor" on page 18-20

● Creating Recipe Files in the **Recipe Settings** Dialog Box

- 1 Insert an external memory device in the computer.

Insert an external memory device*¹ into the USB port or memory card slot of your computer, or via a docking station, etc.

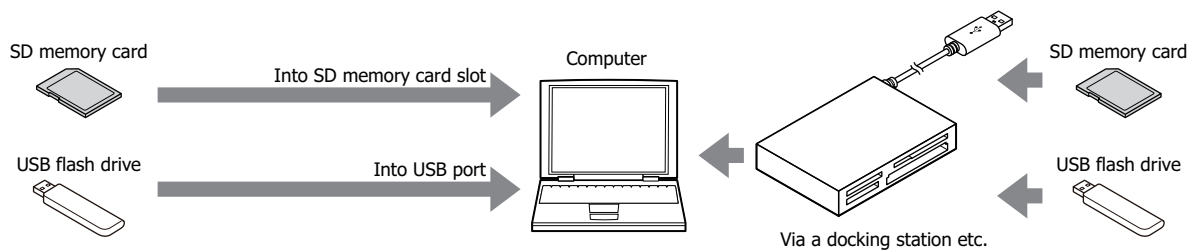

- 2 On the **Configuration** tab, in the **System Setup** group, click **Recipe**.

The **Recipe Settings** dialog box is displayed.

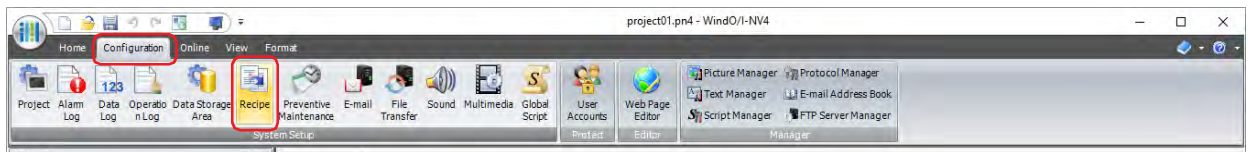

- 3 Click **Save Recipe Files to External Memory Device**.

The **Select Drive** dialog box is displayed.

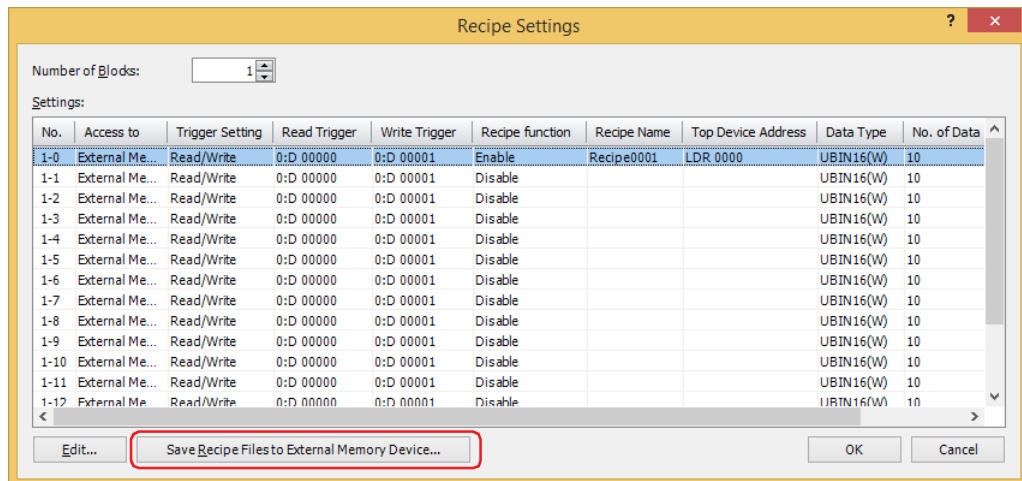

*1 USB flash drive inserted in USB1 for HG2J-7U, SD memory card for HG5G/4G/3G/2G-V, HG4G/3G and HG2G-5F, USB flash drive for HG2G-5T and HG1G/1P

- 4 Specify the drive for the external memory device, then click **OK**.

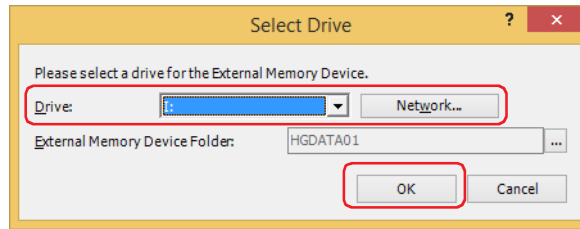

■ **Drive**

Specifies the drive assigned to the external memory device.

■ **Network**

Displays the **Map Network Drive** dialog box. This dialog box allows you to specify a drive on the network.

■ **External Memory Device Folder**

Specifies the folder to save the created recipe file.

Click **...** to display the **Project Settings** dialog box. You can specify the External Memory Device folder used as the save destination.

- 5 Click **OK**.

The **Recipe Settings** dialog box closes.

The "RECIPE" folder is created in the External Memory Device folder used as the save destination, and the recipe files for the channels configured with **Access to** set to **External Memory Device** and **Recipe Function** set to **Enable** in the **Recipe Settings** dialog box are created.

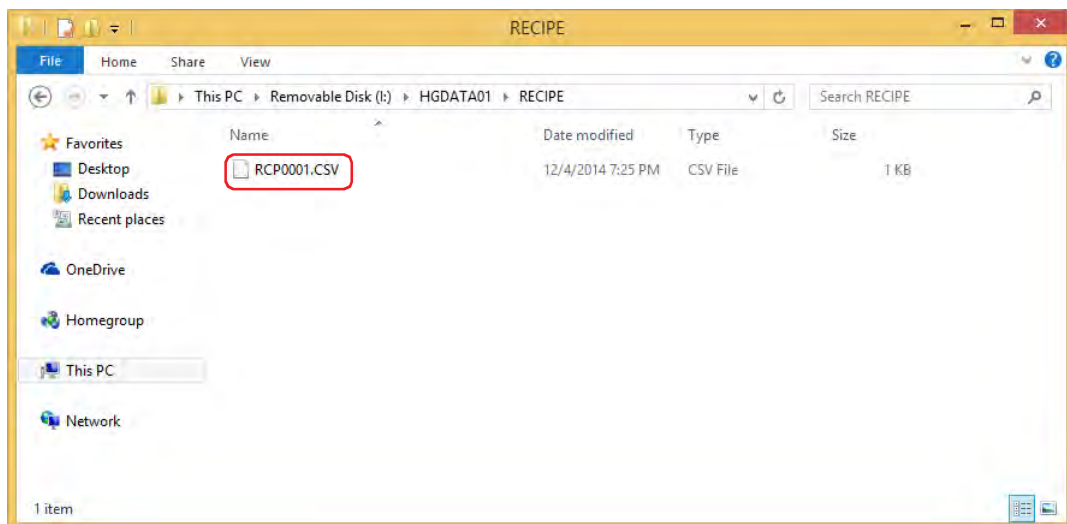

● Creating Recipe Files when Downloading Project Data

When a project download is executed, the "RECIPE" folder is created in the External Memory Device folder on the external memory device*¹ inserted in the MICRO/I and the recipe files are created. The recipe files are only created for channels configured with **Access to** set to **External Memory Device** and **Recipe Function** set to **Enable** in the **Recipe Settings** dialog box.



The External Memory Device folder is configured in the **Project Settings** dialog box. For details, refer to Chapter 31 "1.6 Setting the External Memory Device Folder" on page 31-12.

- 1 Insert an external memory device into the MICRO/I.

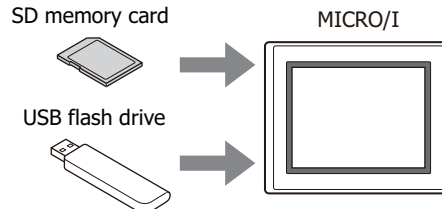

- 2 On the **Home** tab, in the **Project** group, click the **Download** icon. The **Download** dialog box is displayed.

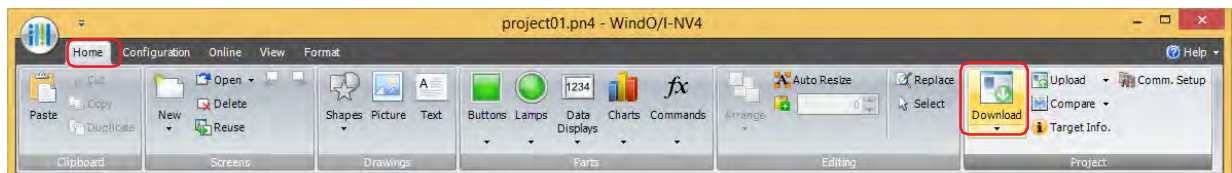

If the project data was changed, a confirmation message to save the project data is displayed.

Click **OK** to save the project data and display the **Download** dialog box.

Click **Cancel** to return to the editing screen without saving the project data.

- 3 Select the **Recipe Files** check box under **Download following files to External Memory Device**.

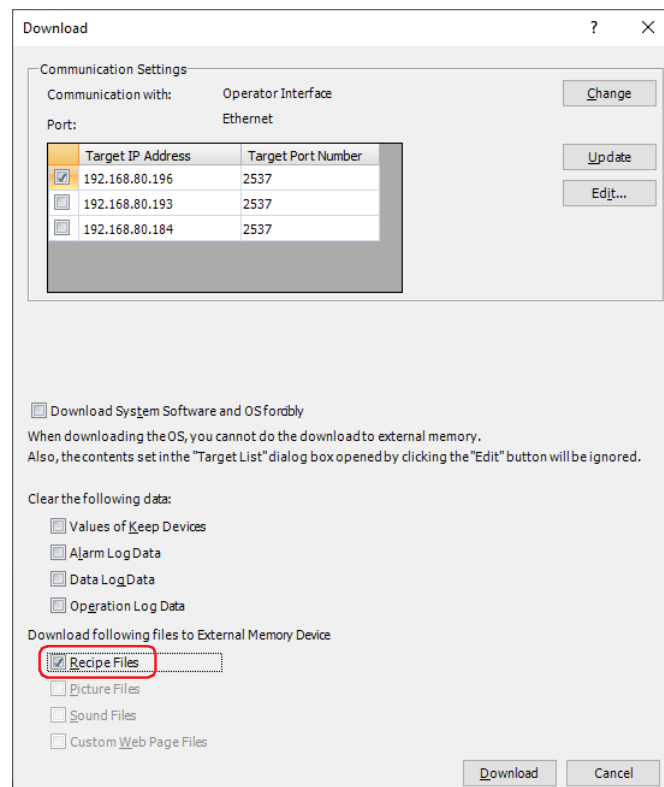

*1 USB flash drive inserted in USB1 for HG2J-7U, SD memory card for HG5G/4G/3G/2G-V, HG4G/3G and HG2G-5F, USB flash drive for HG2G-5T and HG1G/1P

4 Verify **Communication Settings** and click **Download**.

Since the recipe files are downloaded to the external memory device inserted in the MICRO/I, use the same settings as when communicating with the MICRO/I.

To change **Communication Settings**, click **Change** to display the **Communication Settings** dialog box. Change **Communicate with**, **Port**, and **Baud Rate**. For details, refer to Chapter 24 "1 Communicating with the MICRO/I" on page 24-1.



If security is enabled in the MICRO/I project, the Password Screen is displayed. Select the user name and enter the password. For details, refer to Chapter 23 "User Accounts and the Security Function" on page 23-1.

5 Click **Yes**.

The **Download Project** dialog box is displayed and the project files start downloading.

When finished downloading, a completion message is displayed.

6 Click **OK**.

You are returned to the **Download Project** dialog box.

7 Click **Close**.**●** Creating Recipe Files with a Text Editor

You can edit recipe files using Notepad, commercially available text editors, or spreadsheet software.

1 Write the data for the amount of data in "value of device address" comma (,) new line order.

If the amount of data in the recipe file is lower than the amount of data for the top device address configured on the **Channel** tab in the **Individual Settings** dialog box, 0 is written in the rest of the device addresses.

2 Save the file with the ".csv" extension.

Give the file the file name configured on the **Block** tab in the **Individual Settings** dialog box. If the file name is different, 0 is written to all the device addresses.

3 Copy the edited recipe files to the "RECIPE" folder in the External Memory Device folder on the external memory device.

4.3 Editing Recipe Files

You can read and display the data saved from the MICRO/I to the external memory device^{*1} as a recipe file on a computer.

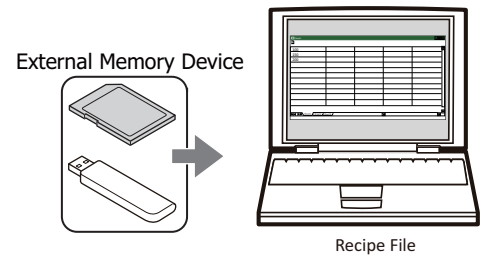

The recipe file that was read can be edited using Notepad, commercially available text editors, or spreadsheet software.



You can upload recipe files from the external memory device using WindO/I-NV4.

On the **Online** tab, click the arrow under **Upload**, and click **Stored Data in External Memory Device** to display the **Upload Data from External Memory Device** dialog box. Select the **Recipe Files** check box, specify the location to save the recipe files in **Location**, and click **OK** to be able to save the recipe files in the specified folder.

*1 USB flash drive inserted in USB1 for HG2J-7U, SD memory card for HG5G/4G/3G/2G-V, HG4G/3G and HG2G-5F, USB flash drive for HG2G-5T and HG1G/1P

4.4 Deleting Recipe Files

The methods to delete recipe files saved on the external memory device ^{*1} are as follows.

- To delete files with WindO/I-NV4, on the **Online** tab, in the **MICRO/I** group, click **Clear**, and then click **Stored Data in External Memory Device** to display the **Clear Data** dialog box. Select the **Recipe Files** check box and click **OK**.
- To delete files on the HG5G/4G/3G/2G-V, HG4G/3G and HG2G-5F, go to the System Mode - File Manager. In the File Manager, select the files to be deleted by pressing **DEL**.

*1 USB flash drive inserted in USB1 for HG2J-7U, SD memory card for HG5G/4G/3G/2G-V, HG4G/3G and HG2G-5F, USB flash drive for HG2G-5T and HG1G/1P

Chapter 19 Text Group

This chapter describes the Text Group function and how to configure text groups and text.

1 Overview

HG2J-7U HG5G-V HG4G-V HG4G HG3G-V HG3G HG2G-V HG2G-5F HG2G-5T HG1G HG1P

19

Text Group

1.1 How to Create the Text Groups and Text Registrations

Text groups are a function where the text used for such purposes as registration text, messages for parts, chart labels, and titles for Popup Screens are registered in advance. The registered text is loaded and displayed when displaying parts and screens. The text can be managed collectively including editing the registered text and adding or deleting text.

Text groups can perform the following functions.

- Switch the displayed language by value of device address.

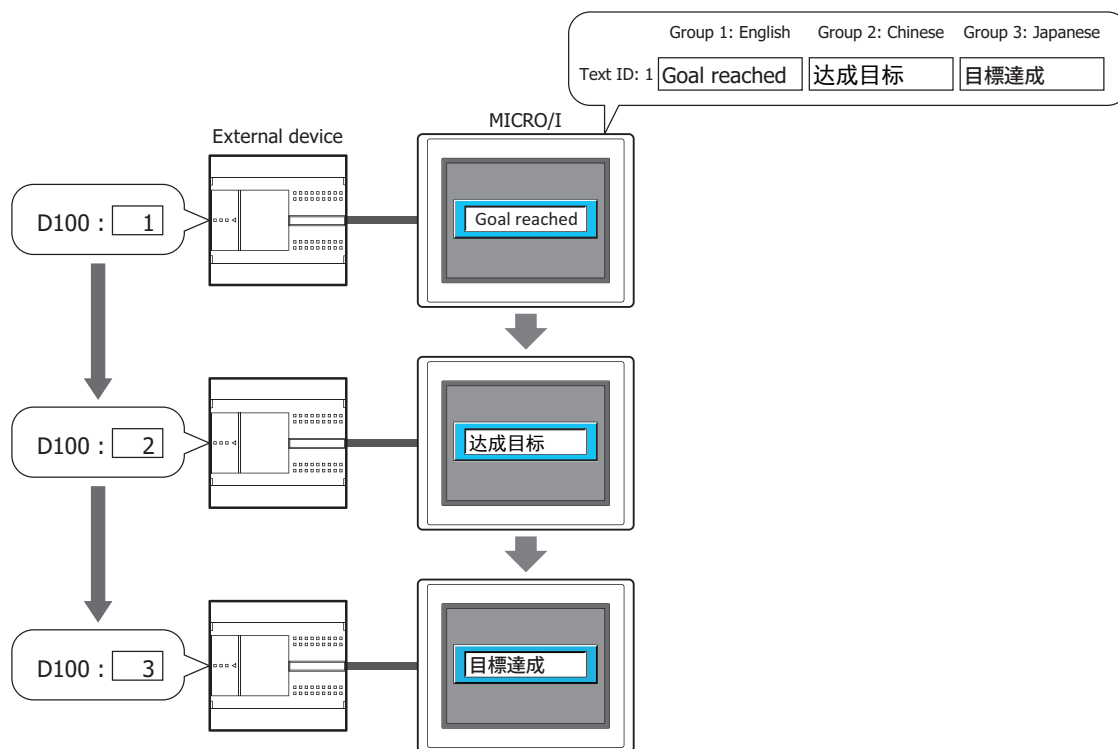

- Use common text for parts.

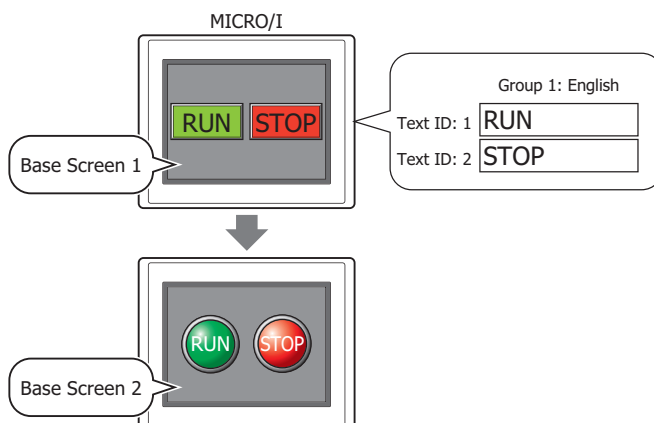

1.2 Functions that Support Text Groups

The functions that support text groups are as follows.

Item		Setting
Screen	Popup Screen	Title
	Password Input Screens	Title
Drawings	Text	Text
Buttons	Bit Button	Registration Text
	Word Button	Registration Text
	Goto Screen Button	Registration Text
	Print Button	Registration Text
	Key Button	Registration Text
	Multi-Button	Registration Text
	Selector Switch	Registration Text
Lamps	Pilot Lamp	Registration Text
	Multi-State Lamp	Registration Text
Data Displays	Numerical Input	Unit
	Message Display	Message
	Message Switching Display	Message
	Alarm List Display	Message
	Alarm Log Display	Message, Title
	Data Log Display	Label
	Numerical Display	Unit
Charts	Bar Chart	X-axis and Y-axis scale labels
	Line Chart	X-axis and Y-axis scale labels
Alarm Log		Messages displayed in data output as CSV
Data Log		Labels displayed in data output as CSV
Operation Log		Recorded item labels and event names displayed in data output as CSV



- When the text group is switched, the displayed Base Screen is reset. When the current screen is reset, the displayed Popup Screen is closed and the internal devices restart as if the Base Screen is switched. The behavior of the internal devices differs according to the internal devices. For details, refer to Chapter 33 "Internal Devices" on page 33-1.
- Enter the password for projects created with WindO/I-NV4 Ver. 1.11.4 or earlier using only 4 to 15 uppercase letters and numbers.

2 Text Groups and Text Configuration Procedure

HG2J-7U HG5G-V HG4G-V HG4G HG3G-V HG3G HG2G-V HG2G-5F HG2G-5T HG1G HG1P

This section describes the configuration procedure for text groups and text.

2.1 How to Create the Text Groups and Text Registrations

- 1 On the **Configuration** tab, in the **Manager** group, click **Text Manager**.

Text Manager is displayed.



- 2 In **Number of Text Groups**, specify the number of text groups to create (1 to 32).

The configured number of text groups are enabled.

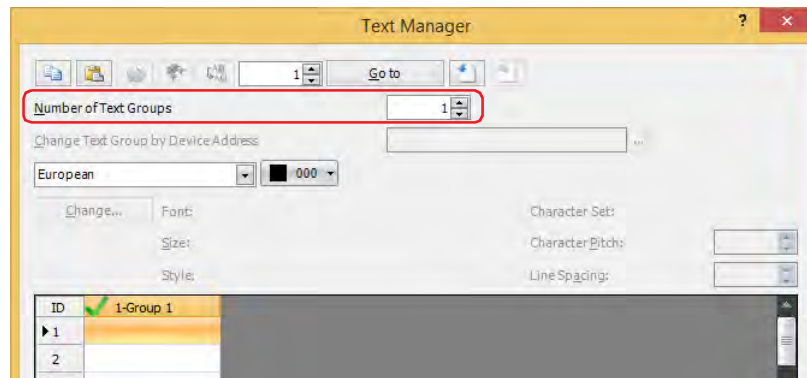

- 3 Double click (Text Group Name).

The Text Group Settings dialog box is displayed.

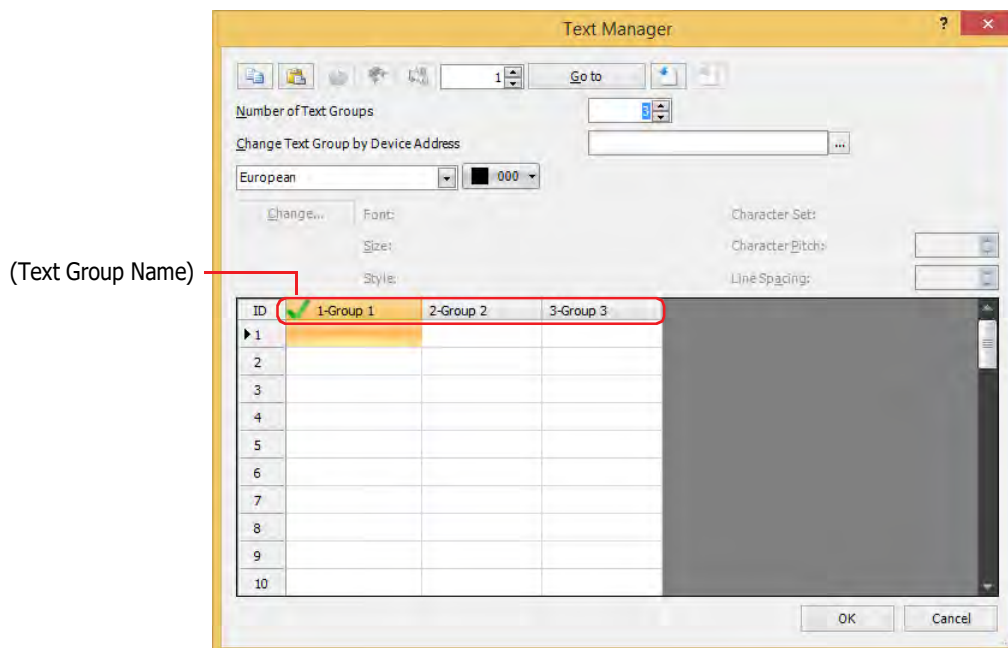

- Under **Text Group Name**, enter the name for the text group.
The maximum number for the Text Group Name is 20 characters.

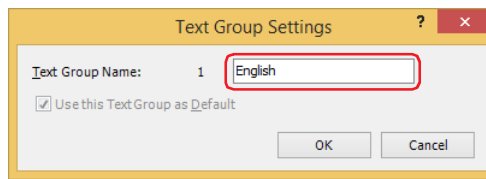

To use when the MICRO/I power is turned on or switched to Run Mode, select the **Use this Text Group as Default** check box.

The text group displayed with  in Text Manager is the default.

- Click **OK**.
The Text Group Settings dialog box closes.
For one text group, proceed to step **8**.
- Repeat steps **3** through **5** to create the necessary text group.
- With **Change Text Group by Device Address**, specify the word device as the condition to switch the text group.
Click  to display the Tag Editor. For the device address configuration procedure, refer to Chapter 2 "5.1 Device Address Settings" on page 2-70.
These options can only be configured when **Number of Text Groups** is specified as two or more.





When the value of device address is 0, the text group switches to the text group set as the default.
If the value of device address is invalid, the text group is not switched.

- With **(Font)**, select the font to use for the text to register from the following.
Western, Japanese, Simplified Chinese, Traditional Chinese, Hangul, Central European, Baltic, Cyrillic, Windows



When **Windows** is selected, all the fonts installed on the computer can be used. This allows you to display fonts and languages that are not installed on the MICRO/I.

Click **Change** to display the Font Settings dialog box. Configure the details such as the font, style, and size.
For details, refer to Chapter 2 "Windows Font" on page 2-13.

(Font) 
(Text Color) 

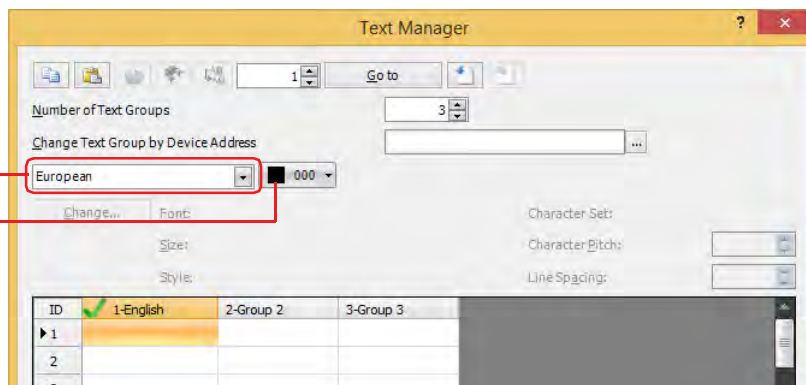

- With **(Text Color)**, select the color of the text to register (color: 256 colors, monochrome: 16 shades).
Click **Color** to display the Color Palette. Select a color from the Color Palette.

10 To register the text, double click the cell and enter the text in the Text Manager.

The maximum number is 3750 characters.

The characters that can be entered vary based on the font selected. For details, refer to Chapter 2 “1.2 Available Text” on page 2-6.



You can enter multi-line text by inserting a newline. The newline is counted as two characters.

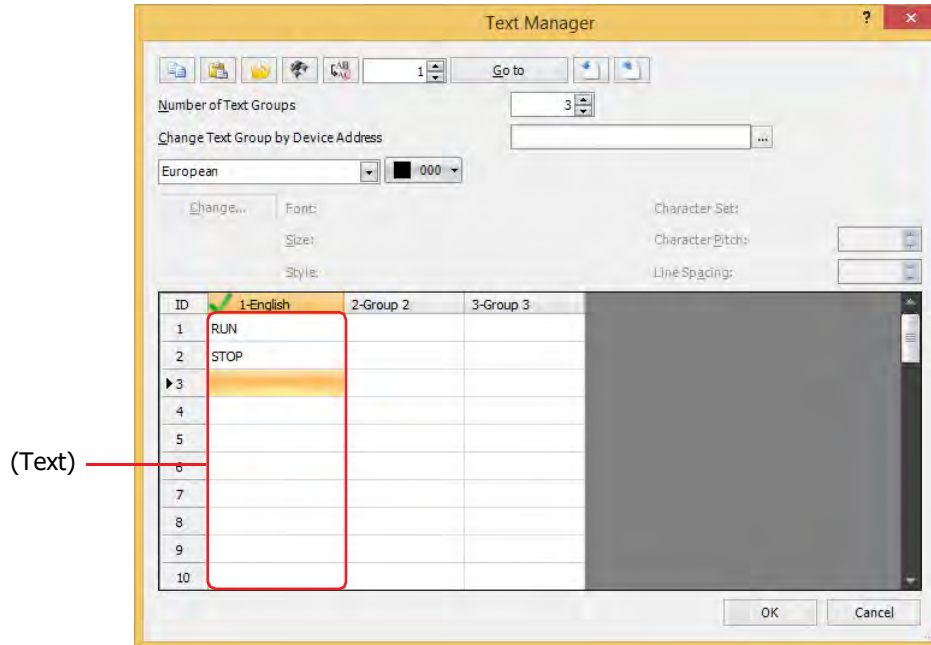

11 Repeat steps 8 through 10 to create the necessary text in each text group.

12 Click **OK**.

This concludes creating text groups and registering text.

● Saving Registered Text in Unicode Text Format

To use registered text in another project, save the text as a Unicode text file or as a CSV file. This file is called a text list.

1 On the **Configuration** tab, in the **Manager** group, click **Text Manager**.

Text Manager is displayed.



2 Select the (Text) of the Text Group to export.

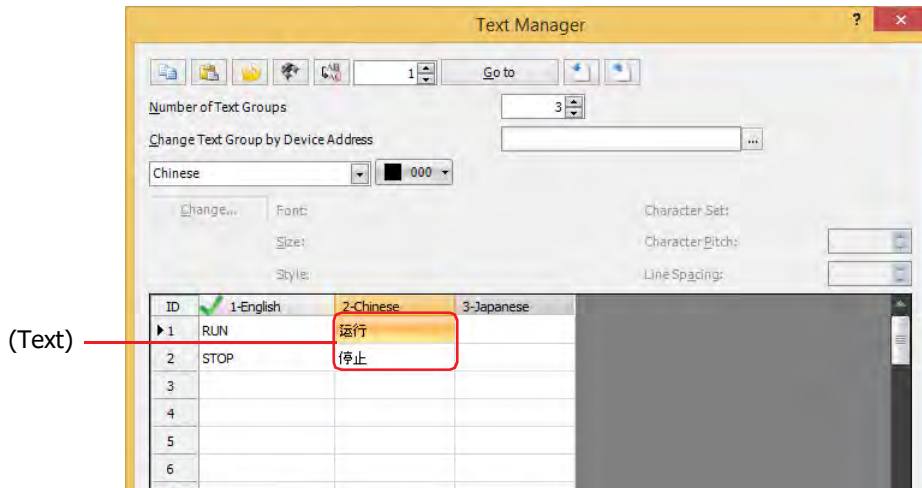

To export multiple text groups, select all of (Text) for the text groups to export. To select multiple items of (Text), press and hold SHIFT or CTRL while you click the specific items.

3 Click (Export).

The Export dialog box is displayed.

4 Enter the location to **Location**, and then select the file format (*.txt or *.csv) as the **Save as type**.

The file name becomes "TextGroup**". (** is the same number as the group, 01 to 32)

Example: Save the text for text group 1 and text group 2 as a Unicode text file

TextGroup01.txt and TextGroup02.txt files are saved in the specified location.

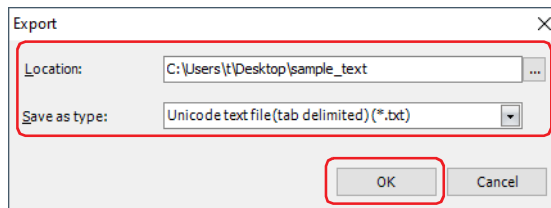

5 Click **OK**.

This concludes saving a text list.

● Importing Text from a Text List

A text list saved as a Unicode text file or as a CSV file can be imported into Text Manager for the project being edited.

1 On the **Configuration** tab, in the **Manager** group, click **Text Manager**.

Text Manager is displayed.



2 Select the (Text) of the Text Group to import.

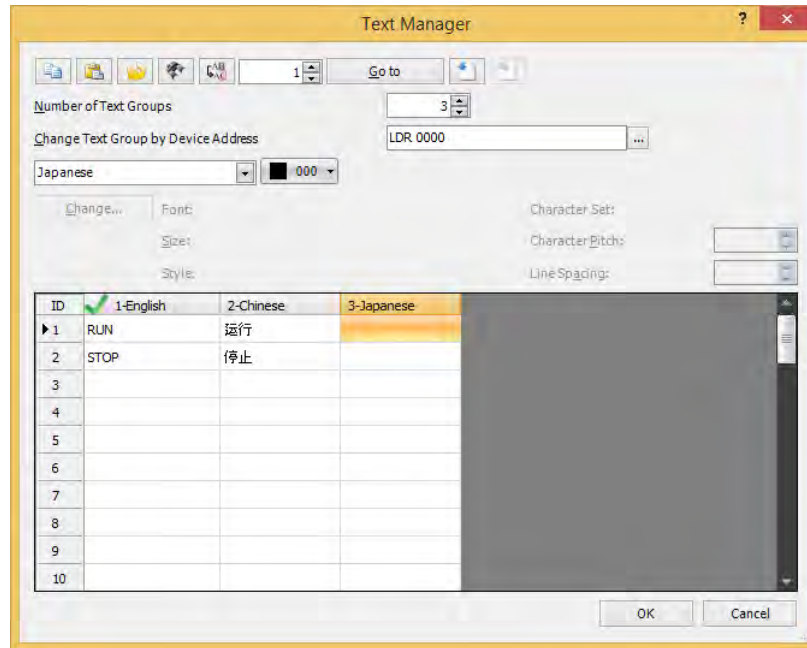

3 Click (Import).

The Open dialog box is displayed.

4 Select a saved text list and click **Open**.

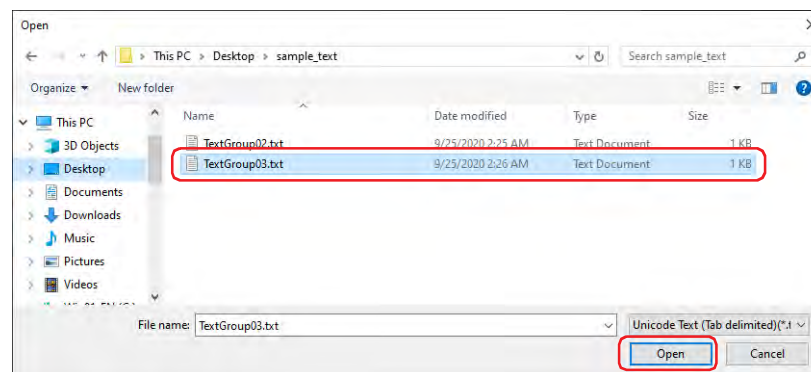

To import multiple text lists, select all of the text lists to import. To select multiple text lists, press and hold SHIFT or CTRL while you click the specific items.

An Import dialog box is displayed if a text ID is included in the text list however it has already been registered on the Text Manager. Here are your options:

- Click **Yes** to overwrite the text in the text list with the text of the displayed text ID, and then to display confirmation to overwrite the next text ID.
- Click **Yes To All** to overwrite all the text in the text list without displaying the Import dialog box subsequently.
- Click **No** to display the next confirmation to overwrite without overwriting the text with the displayed Text Manager ID.
- Click **Cancel** to stop importing text.

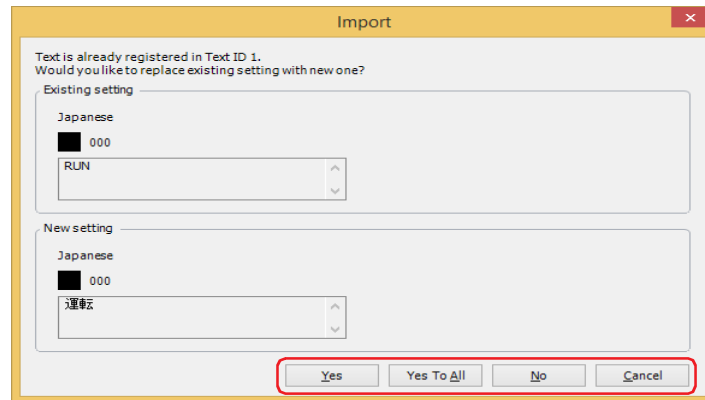

The imported text is displayed in the Text Manager.

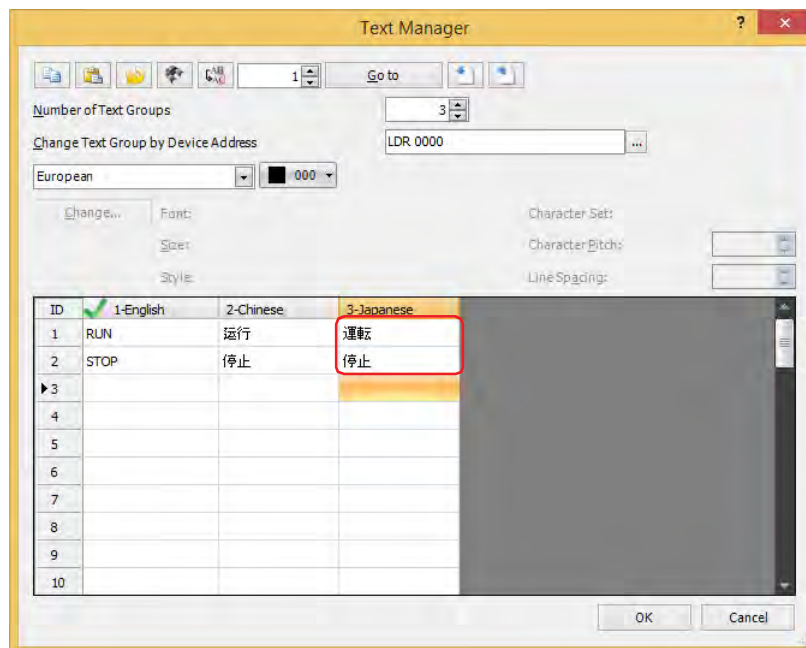

This concludes importing text from a text list.

2.2 Switching the Displayed Language by Value of Device Address

When multiple text groups have been created, the text group can be switched with a value of device address to display a different language.

This section describes an example when the registration text for a button changes between English, Chinese, and Japanese.

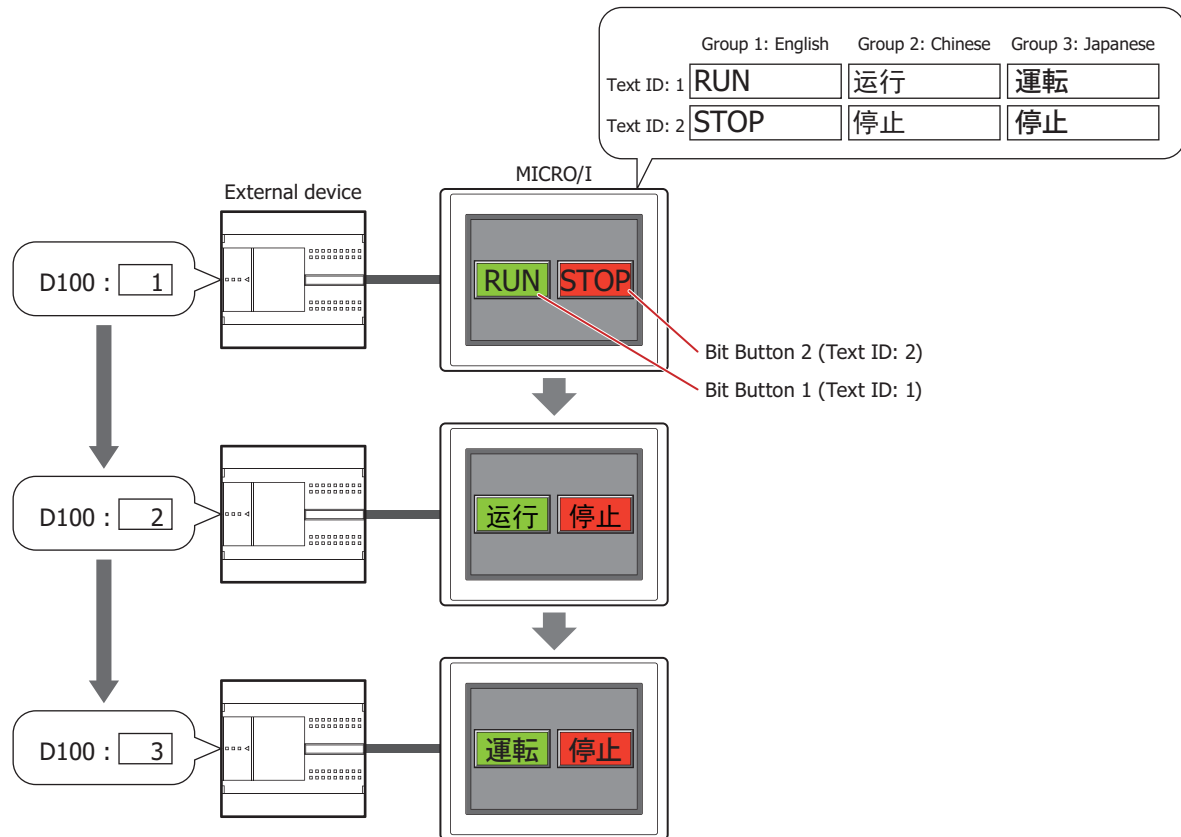

- Following the steps in "2.1 How to Create the Text Groups and Text Registrations" on page 19-3, specify **Number of Text Groups** as 3, and under **Text Group Name**, enter "English" for **Group 1**, "Chinese" for **Group 2**, and "Japanese" for **Group 3**. Set **Change Text Group by Device Address** to D100. Register the following text.

	Group 1: English	Group 2: Chinese	Group 3: Japanese
Text ID: 1	RUN	运行	運転
Text ID: 2	STOP	停止	停止

- Create a Bit Button.
On the **Home** tab, in the **Parts** group, click **Buttons**, and then click **Bit Button**.

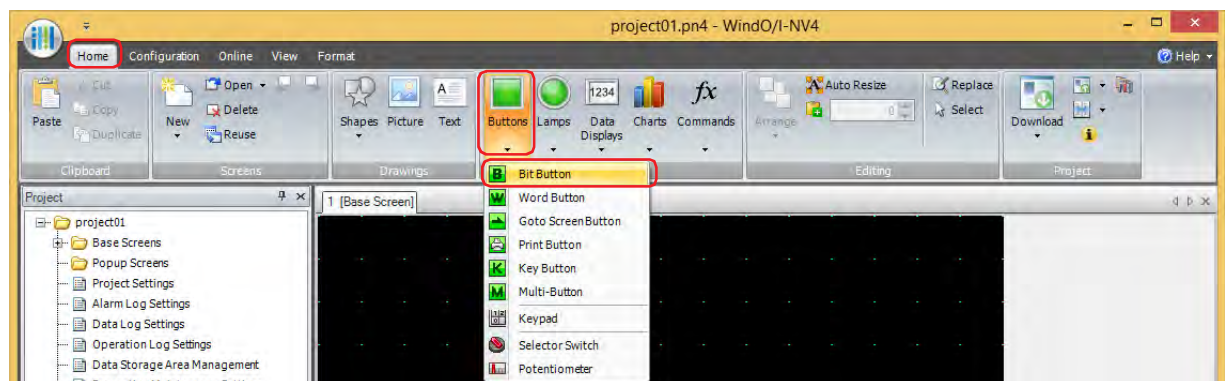

- Click a point on the edit screen where you want to place the Bit Button.

- 4 Double-click the placed Bit Button and the properties dialog box is displayed.

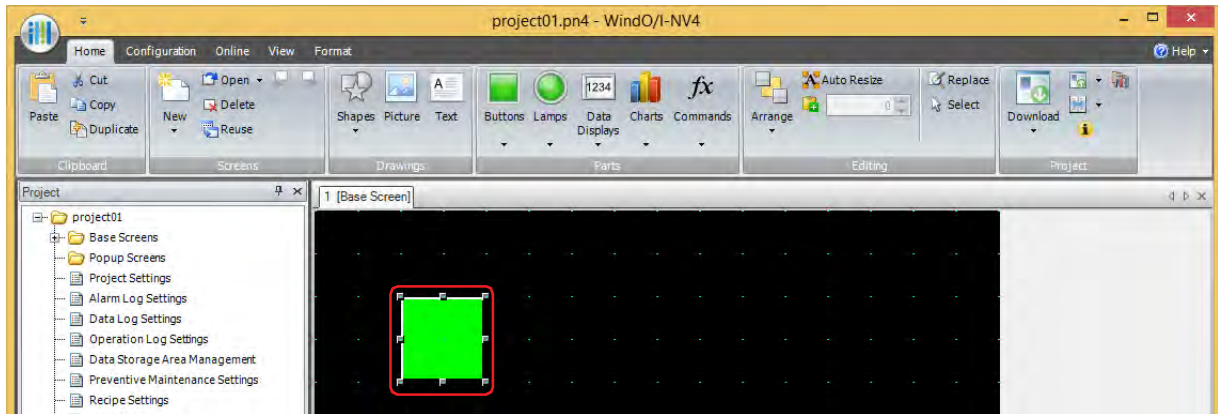

- 5 Click the **Registration Text** tab, and then select the **Use Text Manager** check box.

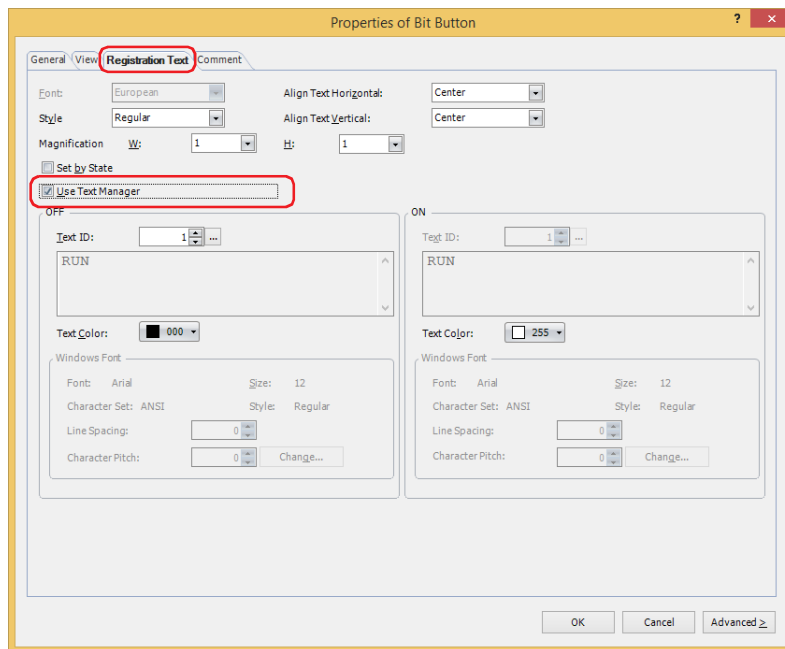

- 6 Specify 1 for the **Text ID** under **OFF**.
- 7 Configure the settings on each tab as necessary, and then click **OK**.
The Properties of Bit Button dialog box closes.
- 8 Repeat steps 2 through 7 and create a Bit Button to use text ID 2 for the registration text.
This concludes configuring the settings to switch the displayed language by a value of device address.

3 Text Manager

HG2J-7U HG5G-V HG4G-V HG4G HG3G-V HG3G HG2G-V HG2G-5F HG2G-5T HG1G HG1P

This section describes items and buttons in Text Manager.

3.1 Text Manager

The text that is loaded and displayed when objects and Popup Screens are displayed is collectively managed with Text Manager.

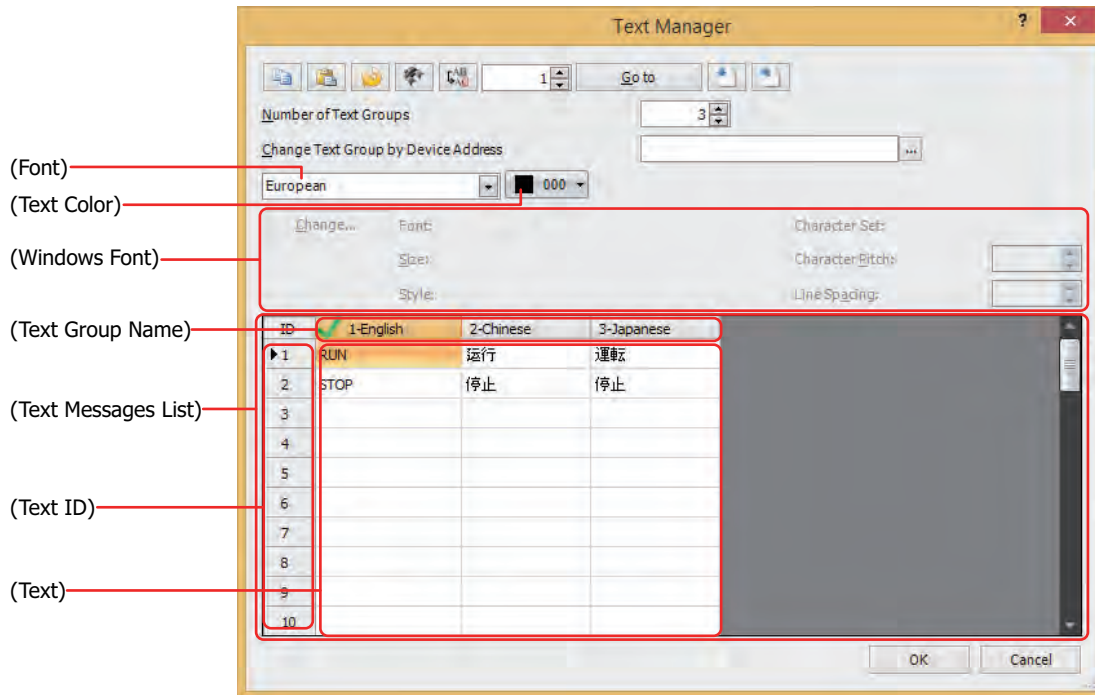

■ (Copy)

Select (Text) and click  to copy the text and its attributes to the clipboard.



- To select multiple items of (Text), press and hold SHIFT or CTRL while you click the specific items.
- Click (Text ID) to select the entire row.

■ (Paste)

Select (Text) and click  to paste the clipboard contents to that cell.



- To select multiple items of (Text), press and hold SHIFT or CTRL while you click the specific items.
- Click (Text ID) to select the entire row.

■ (Delete Unused Texts)

Deletes the text with Text ID numbers that are registered in the Text Manager but are not used in the project.

■  **(Find)**

Displays the Find dialog box.

The text entered in **Find what** is searched for in (Text) in the (Text Messages List).

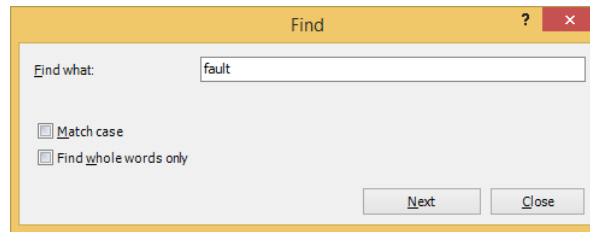

■  **(Replace)**

Displays the Replace dialog box.

The text entered in **Find what** is searched for in (Text) in the (Text Messages List) and that text is replaced with the text entered in **Replace with**.

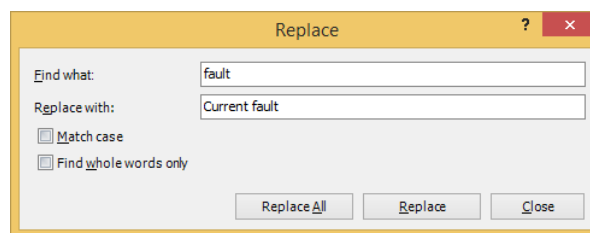

■  **(Destination)**

Specifies the text ID to move the focus (1 to 32,000).

■ **Go to**

Moves the focus to the text ID specified in (Destination).

■  **(Import)**

Imports text in a text list saved as a Unicode text file or as a CSV file.

Click this button to display the Open dialog box. For details, refer to "Importing Text from a Text List" on page 19-7.

■  **(Export)**

Saves the text for the text group being edited as a Unicode text file or as a CSV file. This file is called a text list. The types of files that can be saved are as follows.

- Unicode text file (tab delimited) (*.txt)
- CSV file (comma delimited) (*.csv)
- CSV file (semicolon delimited) (*.csv)

Click this button to display the Save As dialog box. For details, refer to "Saving Registered Text in Unicode Text Format" on page 19-6.

The saved text list can be imported with  (Import).



When **Unicode text file (tab delimited) (*.txt)** is selected, the file can handle multiple languages by using a commercially available text editor or spreadsheet software that supports Unicode.

■ Number of Text Groups

Specifies the number of text groups (1 to 32).

■ Change Text Group by Device Address

Switches the text group according to the value of device address. Specify the word device to use as the condition to switch the text group.

Click  to display the Tag Editor. For the device address configuration procedure, refer to Chapter 2 "5.1 Device Address Settings" on page 2-70.

These options can only be configured when Number of Text Groups is specified as two or more.



When the value of device address is 0, the text group switches to the text group set as the default.
If the value of device address is invalid, the text group is not switched.

■ (Font)

Selects the font used for displaying text from the following.

Western, Japanese, Simplified Chinese, Traditional Chinese, Hangul, Central European, Baltic, Cyrillic, Windows

■ (Text Color)

Selects the color of the text to register (color: 256 colors, monochrome: 16 shades).

Click **Color** to display the Color Palette. Select a color from the Color Palette.

■ (Windows Font)

Sets the font to be used as the Windows Font.

Select **Windows** using (Font) to display the current setting. You can specify the character spacing (0 to 100) and the line spacing (0 to 100). To change the settings other than the character spacing and line spacing, click **Change** to display the Font Settings dialog box.

For details, refer to Chapter 2 "Windows Font" on page 2-13.

■ (Text Messages List)

The attributes for the registered text are displayed in this list.

(Text Group Name): Double clicking this item displays the Text Group Settings dialog box. For details, refer to "Text Group Settings Dialog Box" on page 19-14.

(Text ID): Displays the ID number (1 to 32,000).

(Text): Displays the registered text.

When registering text, double click the cell for the text group and text ID (1 to 32,000) to register, and then enter the text.

The maximum number is 3,750 characters.

The characters that can be entered depend on the font selected font. For details, refer to Chapter 2 "1.2 Available Text" on page 2-6.



A line feed will be added with pressing and holding ALT and ENTER keys. You can enter multi-line text by inserting a newline. The newline is displayed as `\n` and is counted as two characters.

● **Text Group Settings Dialog Box**

This dialog box is used to configure the Text Group Name and the default.

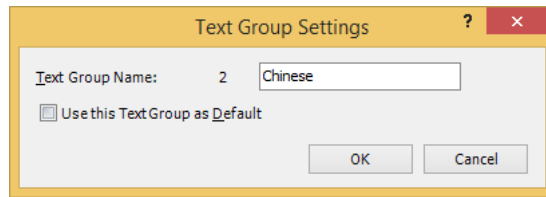

■ **Text Group Name**

Enters the names of the text groups.

The maximum number for the Text Group Name is 20 characters.

■ **Use this Text Group as Default**

Select this check box to setup the group to use when the MICRO/I power is turned on and when switching to run mode.



The text group set as the default is displayed with  next to (Text Group Name).

Chapter 20 Script

This chapter explains the script function, editing and management of the script, definition method, and definition sample.

1 About the Script Function

HG2J-7U HG5G-V HG4G-V HG4G HG3G-V HG3G HG2G-V HG2G-5F HG2G-5T HG1G HG1P

1.1 Overview of the Script Function

● What is the script function?

Complex processes such as conditional branching, logical operation, arithmetic operation, functions, etc., can be programmed in a text format using Script Function.

As an example, the logical product (AND) calculation described as  in a ladder diagram is described as `[LM 100] & [LM 101]` in text format in the script.

■ Description and management of the script

The script is programmed by WindO/I-NV4 script editor, and managed by Script Manager.



- By using the Script Editor, conditional expressions, operators, and functions can be inserted by selecting them from a list, and an error in the script can be checked as well. The script can also be exported as a text file, so the script can be edited by a text editor such as Notepad, and the edited script can be imported back into the Script Editor by saving it as a text file. For details, refer to "2.3 Script Editor" on page 20-12.
- Script Manager can manage the script collectively by adding, deleting, organizing, importing, exporting, etc., the script created by the Script Editor. For details, refer to "2.2 Script Manager" on page 20-7.

■ Example of using the script

As an example, when reading the data from the external device and displaying on the MICRO/I, the load on the external device can be reduced for processes such as conditional branching or function calculation, which apply a heavy load on the external device, by processing it with a script on the MICRO/I.

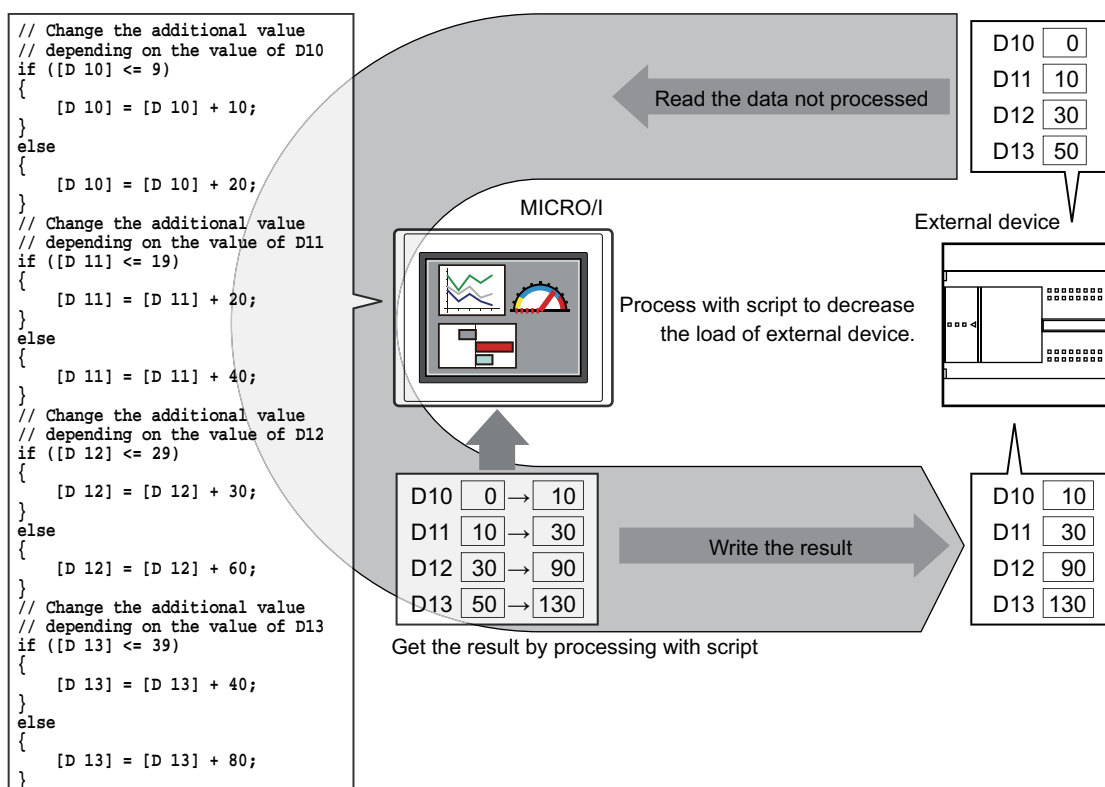

1.2 Types and Trigger Conditions of the Script

● Types of scripts

There are 3 types of scripts used.

■ Script Command

This is a script that executes in accordance with trigger conditions in the same way as other parts, such as switches or lamps, for each screen.

- It is executed only in the screens where it is placed.
- Multiple scripts can be set for each screen.

For details, refer to Chapter 12 "5 Script Command" on page 12-32.

■ Global Script

This is a script that operates within the whole project. This script is executed at the end of MICRO/I scan process in accordance with the trigger condition. The amount of Global Scripts which can be used in a project is maximum of 16 scripts. For details about setup, refer to "3 Global Script" on page 20-16.

■ Cyclic Script*1

This is a script that can be repeated in fixed intervals independent of the scan process of the MICRO/I. Input delay and output delay of the expansion module can be kept to a minimum by this script.

Only one cyclic script can be set to a project.

For details, refer to Chapter 30 "4 Cyclic Script" on page 30-29.

● Trigger condition of the script

Trigger conditions that can be set for the script are as follows:

Script	Trigger Condition					
	Rising-edge	Falling-edge	Satisfy the condition	While satisfying the condition	Fixed Period	Always ON
Script Command	YES	YES	YES	YES	YES	NO
Global Script	YES	YES	NO	NO	YES	YES
Fixed interval script*1	NO	NO	NO	NO	YES	NO

■ Rising-edge

Script is executed when trigger device address changes from 0 to 1.

■ Falling-edge

Script is executed when trigger device address changes from 1 to 0.

■ Satisfy the condition

Script is executed when the set condition is met.

This can only be set for the Script Command.

■ While satisfying the condition

Script is executed while the set condition is met.

This can only be set for the Script Command.

■ Fixed Period

Script is executed at set intervals.

■ Always Enabled

Script is executed on every scan of the MICRO/I.

This can only be set for the Global Script.

*1 HG5G/4G/3G/2G-V, HG4G/3G, HG2G-5F only

1.3 Data Type of the Script

It is required to set the data type appropriate for the range of data to be used, such as the maximum and minimum values of the data used in the script, negative numbers or real numbers required, etc., considering what is to be processed with the script. Data type is set by the Script Editor. For the setting method, refer to "2.3 Script Editor" on page 20-12.

● Data Types

There are 7 types of data that can be processed by the script function.

For details about the data types, refer to Chapter 2 "1.1 Available Data" on page 2-1.

Types of the data type	Required word count	Range that can be processed
UBIN16(W)	1	0 to 65,535
BIN16(I)	1	-32,768 to 32,767
UBIN32(D)	2	0 to 4,294,967,295
BIN32(L)	2	-2,147,483,648 to 2,147,483,647
BCD4(B)	1	-999 to 9,999
BCD8(EB)	2	-9,999,999 to 99,999,999
Float32(F)	2	-3.4×10 ³⁸ to -1.18×10 ⁻³⁸ 0 1.18×10 ⁻³⁸ to 3.4×10 ³⁸



Function that can be used is based on the selected data type. For details, refer to "4 Script Definition Method" on page 20-21.

1.4 Script Error

This section describes the types, cause, and information of script errors.

● Error information

Script error information is stored in the following locations. An error message is displayed on the screen when a script error has occurred.

Category	Storage location	Stored value	
Existence of a script error	Bit 10 of the System Area address number +2	0	No error
		1	Error
Script ID of the script with an error	HMI Special Data Register LSD52	1 to 32,000	Script ID
Types of script errors	HMI Special Data Register LSD53	1	Processing error
		2	Execution time over error
		3	Writing count error
		4	Indirect device error
		5	Parameter error
		6	Fixed Interval Script execution time over
		7	Fixed interval execution error



If there is a script error, bit 10 (11th bit) of the beginning device address +2 (third word from the beginning) of the System Area will be 1.

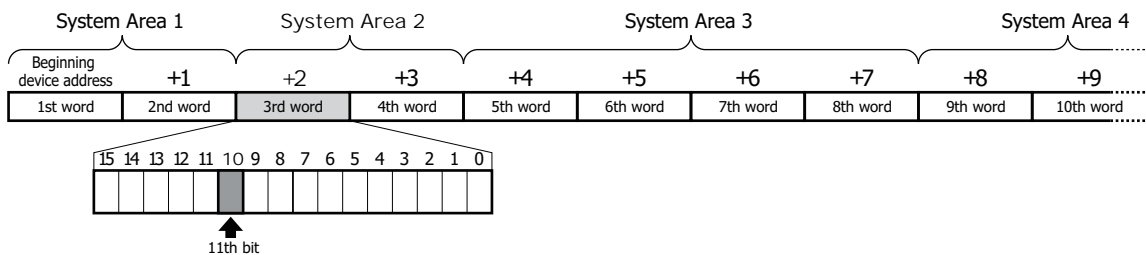

Beginning device address of the System Area is set in the **System** tab of the **Project Settings** dialog box. For details about the System Area, refer to Chapter 4 "System Area" on page 4-30.

● Types and causes of script errors

Script will stop running when an error occurs.

Types of script error	Cause
Processing error	Dividend was divided by 0 for division and residue calculation.
	Data types are BCD4(B), BCD8(EB), Float32(F) and value out of range is specified.
Execution time over error	The execution time for one script exceeded 3,000 milliseconds.
Fixed Interval Script execution time over	
Writing count error	Data count written to the external device address in one script has exceeded 64.
Indirect device error	During the indirect read of external device address, the value of external device address was read.
	Indirect read or indirect write of external device address is performed with the Global Script.
Parameter error	Value out of range was specified as argument for LINE function, RECTANGLE function, or CIRCLE function.
	Executed the LINE function, RECTANGLE function, and CIRCLE function in a Cyclic Script.
Fixed interval execution error	Execution interval is automatically adjusted since the execution of the Fixed Interval Script has taken more time than half of the execution interval specified in the Fixed Interval Script.

2 Editing and Management of the Script

HG2J-7U HG5G-V HG4G-V HG4G HG3G-V HG3G HG2G-V HG2G-5F HG2G-5T HG1G HG1P

2.1 Script Registration Procedure

This section describes the procedure to create a script and register it in the project.

The registered script can be used in a Multi-Button, Script Command, Multi-Command, Global Script, and Cyclic Script.

- 1 On the **Configuration** tab, in the **Manager** group, click **Script Manager**.

Script Manager opens.

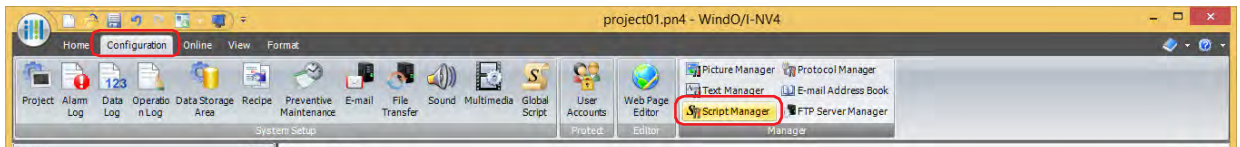

- 2 Click **Add**.

Script Editor opens.

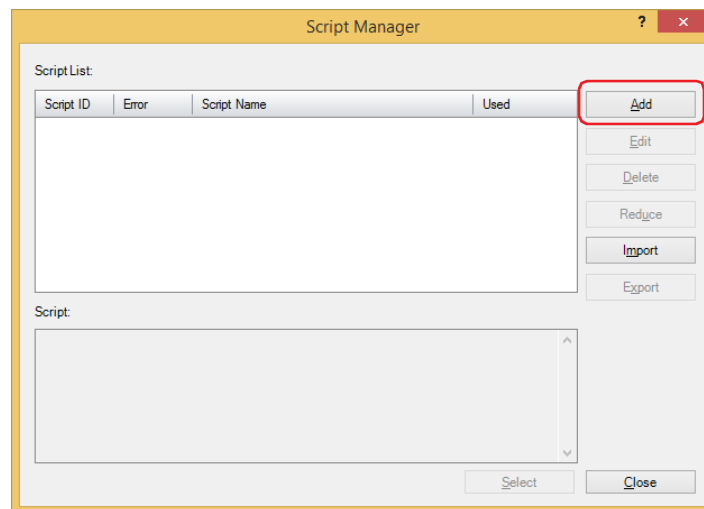

- 3 Specify **Script ID**.

When creating a new script, enter the script ID (1 to 32000).

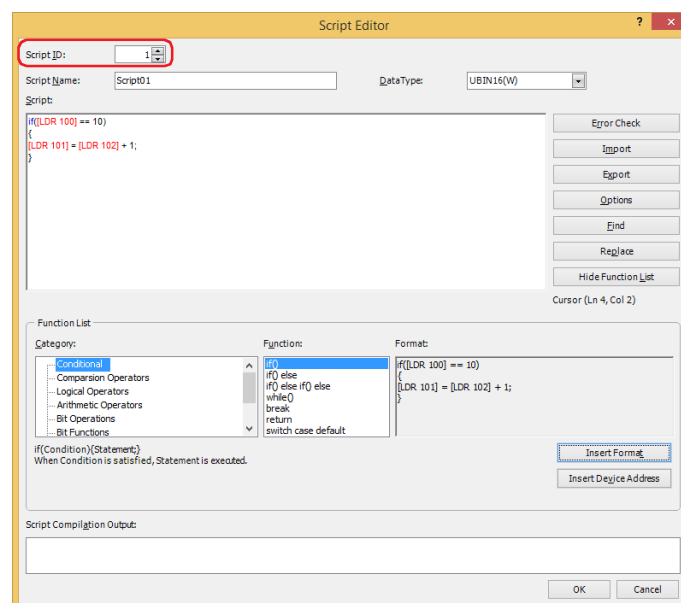

4 Enter Script Name.

Maximum number for the script name is 40 characters.

5 Select Data Type.

Be sure to match the Data Type of the script with the types of data being used within the script.

For example, if a fractional value is contained in a script, select **Float32(F)** for the Data Type of the script. If there are only integer values from 0 to 65,535, select **UBIN16(W)**.

6 Code a program in Script.

To create a script using the samples provided by WindO/I-NV4, under **Function List**, select **Category** and **Function**, and then click **Insert Format**. The sample shown in **Format** is inserted at the cursor position in **Script**.

7 When the script is finished, click OK.

The created script is shown in **Script List**.

8 Click Close.

The scripts are saved in the project data and Script Manager closes.

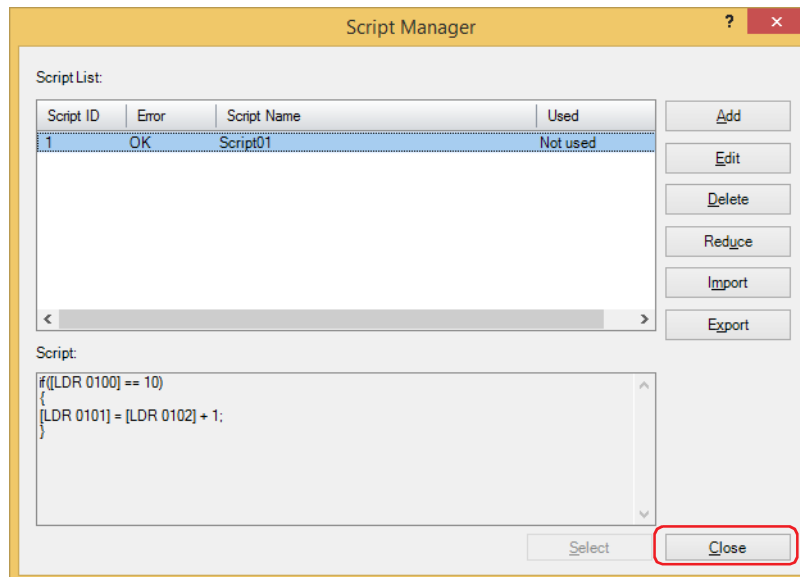

When you are in the following dialog boxes, clicking  will open the Script Manager. When you close the Script Manager, you will be taken back to the original dialog box.

- Global Script **General** tab
- Script Command properties **General** tab
- Multi-function script properties for Multi-Buttons and Multi-Commands
- Project Settings **Expansion Module** tab

2.2 Script Manager

Script Manager can add, delete and manage the script created by Script Editor.

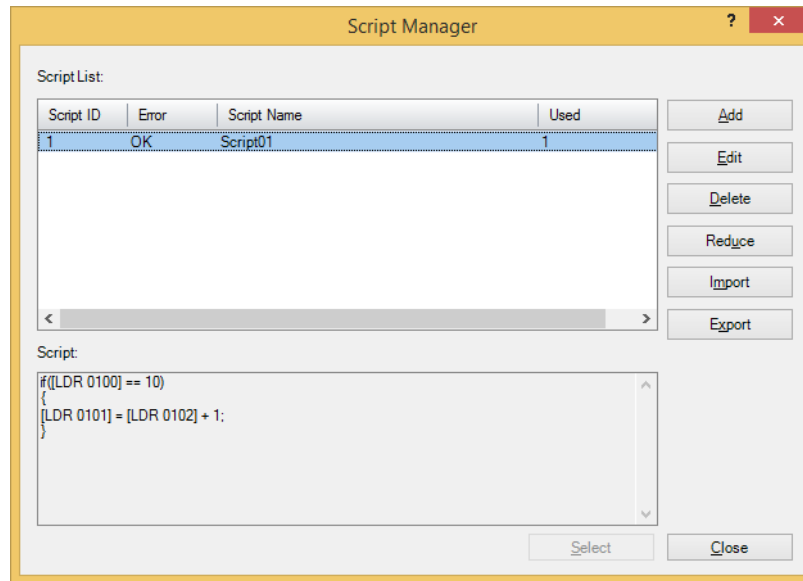

■ Script List

Displays a list of registered scripts.

Script ID: Displays the script ID (1-32000) of the registered scripts.

Error: OK is displayed when there is no error in the registered script and NG is displayed when there is an error.

Script Name: Displays the script name of the registered scripts.

Used: Displays how many times the registered script has used.

■ Script

Displays the contents of the script selected in the script list.

■ Add

Displays the **Script Editor** dialog box to add a script.

For details, refer to "2.3 Script Editor" on page 20-12.

■ Edit

Displays the **Script Editor** dialog box to allow editing of the selected script. For details, refer to "2.3 Script Editor" on page 20-12.

■ Delete

Deletes the script selected in the script list.

If a script is used in a project or parts, it cannot be deleted.

■ Reduce

Deletes the scripts that are registered in the script list but are not used in the project.

■ Import

Imports a saved script file with **Export**. Click this button to display the **Open** dialog box. For details, refer to "Importing script" on page 20-10.

■ Export

Saves a selected script in **Script List** as a file.

Click this button to display the **Browse For Folder** dialog box. For details, refer to "Saving registered script as a file" on page 20-8.

The saved script file can be imported using **Import**.

■ Select

The highlighted script in the script list is selected and the Script Manager is closed.



The contents executed by the script used in the project can be checked with the debug function of the simulator. For details, refer to Chapter 26 "3.5 Script Debugger" on page 26-15.

● Using registered script on another project

To use the script registered in Script Manager on another project, save it as a file, and then import it to a project.

Saving registered script as a file

- 1 On the **Configuration** tab, in the **Manager** group, click **Script Manager**.

Script Manager opens.

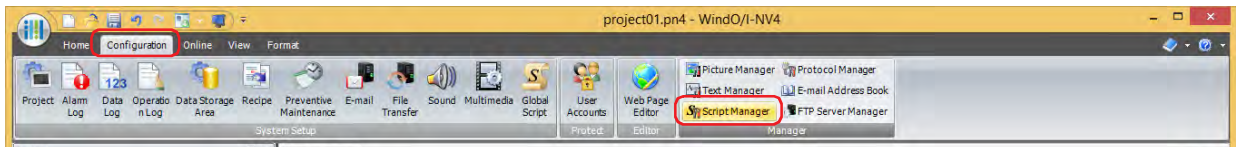

- 2 Select the script in **Script List**, and then click **Export**.

The **Browse For Folder** dialog box is displayed.

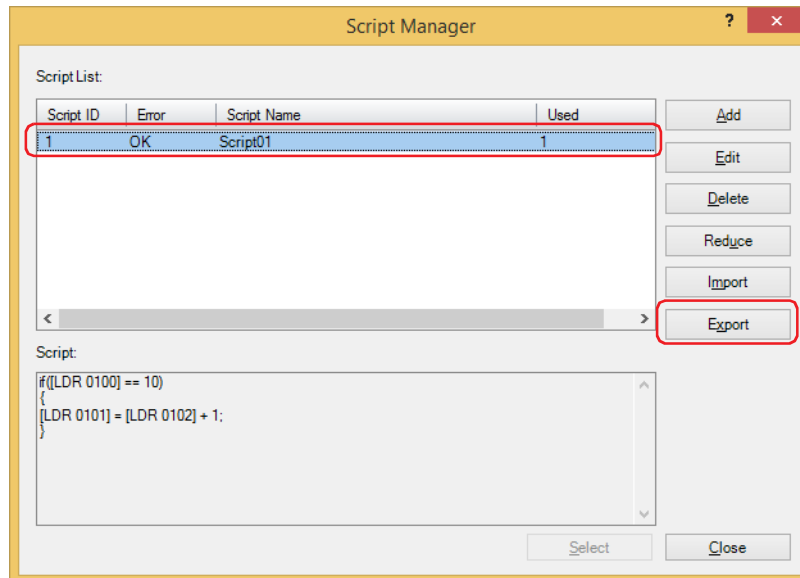

To export multiple scripts, select all scripts to export. To select multiple scripts, press and hold SHIFT or CTRL while you click the specific items.

3 Specify a save location and click **OK**.

The script file is output.

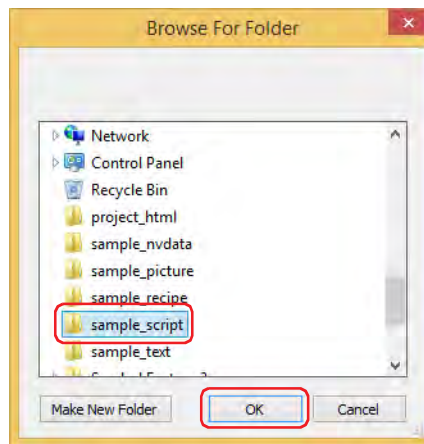

The file name of the exported script is

"Script"(fixed text) + "{Script ID}" + "_"(underscore) + "{Script Name}" + ".txt"(file extension).

If the number of the script ID is less than 5 digits, 0 is written in the rest of the digits. It is omitted if the script name is not configured.

Example 1: In Script List on the Script Manager dialog box, {Script ID} is "12345" and {Script Name} is "sample".
Script12345_sample.txt

Example 2: In Script List on the Script Manager dialog box, {Script ID} is "6" and {Script Name} is blank.
Script00006_.txt

4 Click **OK**.

This concludes exporting script.

Importing script

- 1 On the **Configuration** tab, in the **Manager** group, click **Script Manager**.

Script Manager opens.

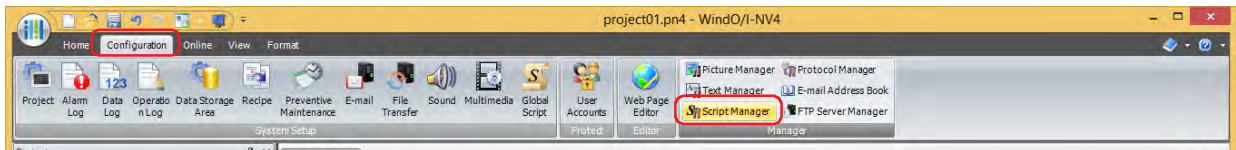

- 2 Click **Import**.

Open dialog box is displayed.

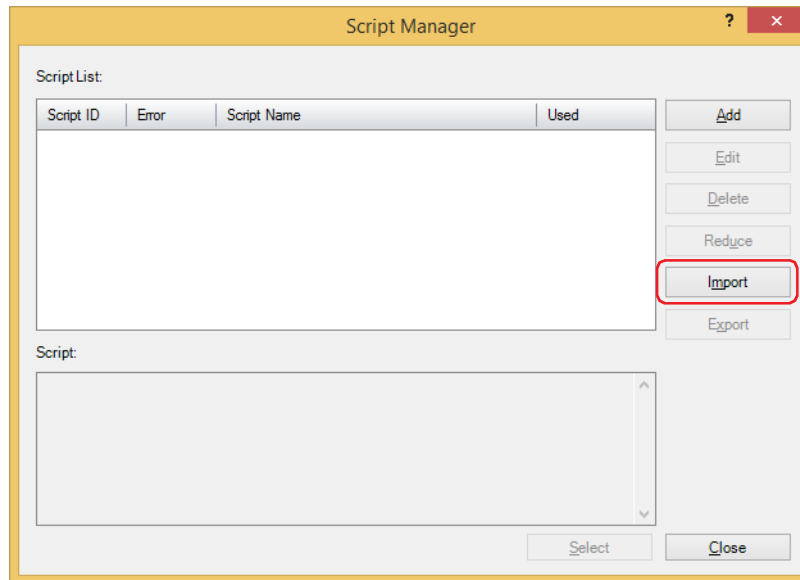

- 3 Select a file for the Script, and then click Open.

The script is added to the Script Manager.

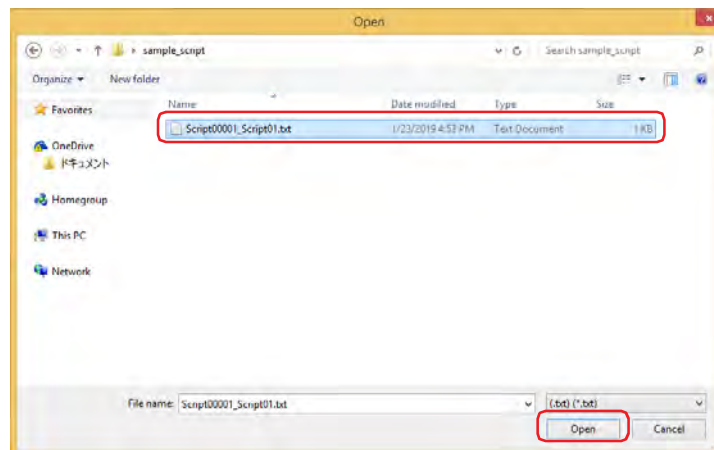

If there is a script with a script ID already registered on the Script Manager, an overwrite confirmation message is displayed.

- Click **Yes** to overwrite the script displayed in the confirmation message.
- Click **Yes To All** to overwrite all the scripts.
- Click **No** to display the next confirmation message without overwriting the script displayed in the confirmation message.
- Click **Cancel** to stop importing scripts.



To import multiple scripts, select all of the script files to import. To select multiple script files, press and hold SHIFT or CTRL while you click the specific items.

4 Click **OK**.

The imported script is displayed on the Script Manager.

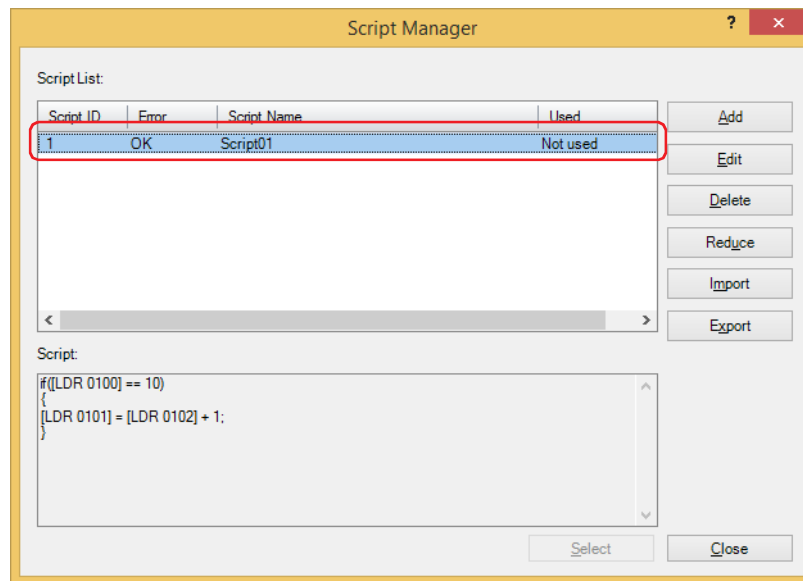

This concludes importing script.

2.3 Script Editor

A new script can be created or the script selected in the Script Manager can be edited using Script Editor.

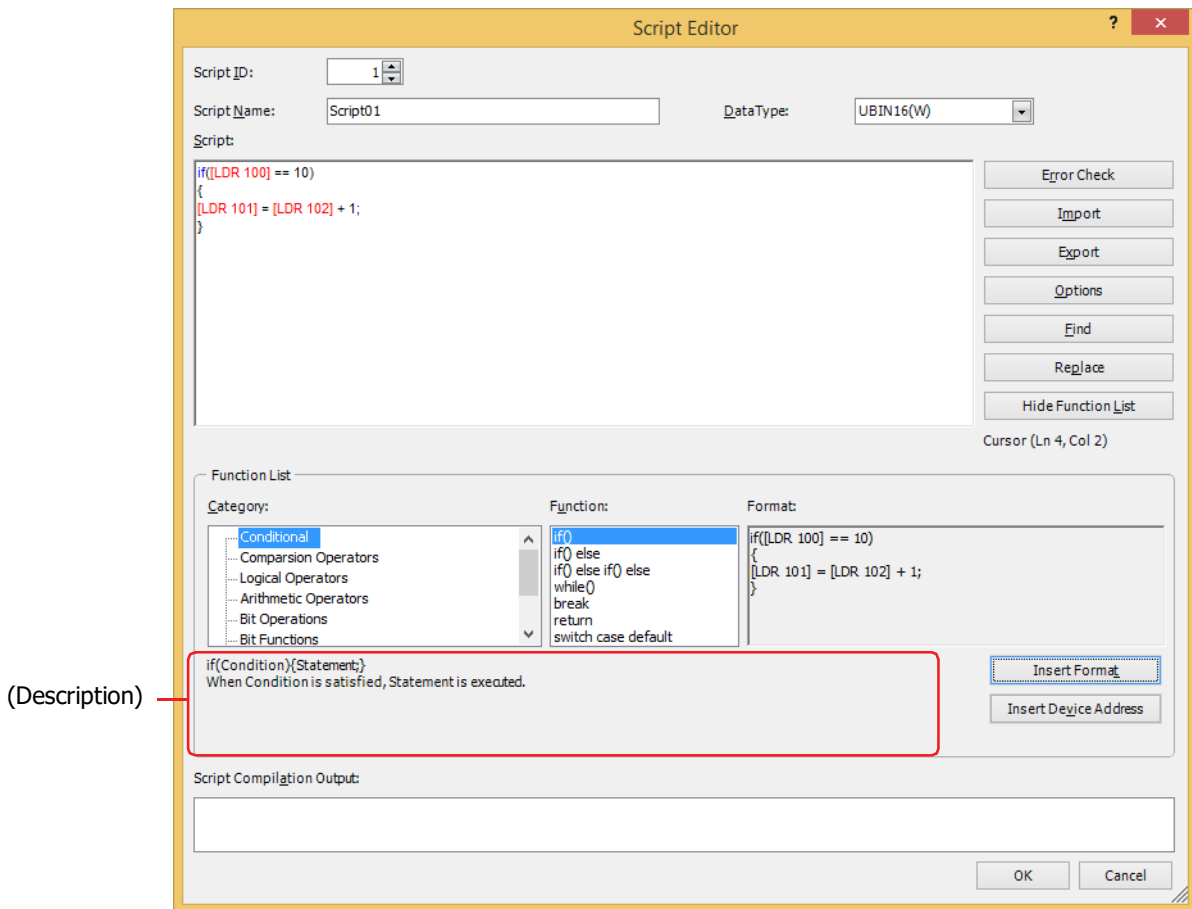

■ Script ID

To create a new script, enter the script ID (1-32000).
To edit an existing script, the set script ID is displayed.

■ Script Name

Enter the script name. Maximum number for script name is 40 characters.

■ Data Type

Selects the default for the data type used in the script.
For details about the data type, refer to "1.3 Data Type of the Script" on page 20-3.



You can change the data type in the script. For details, refer to "Data Type Designations" on page 20-30.

■ Script

Enter the **script**.

Single script limitation is 240 characters per line with up to 1024 lines.



When you add a descriptive text to the written script or invalidate it, add "///" at the beginning of the line to comment out it.

To select multiple lines in Script, press and hold SHIFT or CTRL while you click the specific items, or drag them.

The keyboard shortcuts are as follows.

- Ctrl+.(period): Comment out the selected line.
- Ctrl+,(comma): Uncomment the cursor position.

■ Error Check

The script being edited is checked for errors.

■ Import

The **Open** dialog box is displayed.

By selecting a script saved (exported) in a text format (*.txt) and clicking on the Open button, the imported script is inserted at the cursor position of the script being edited.

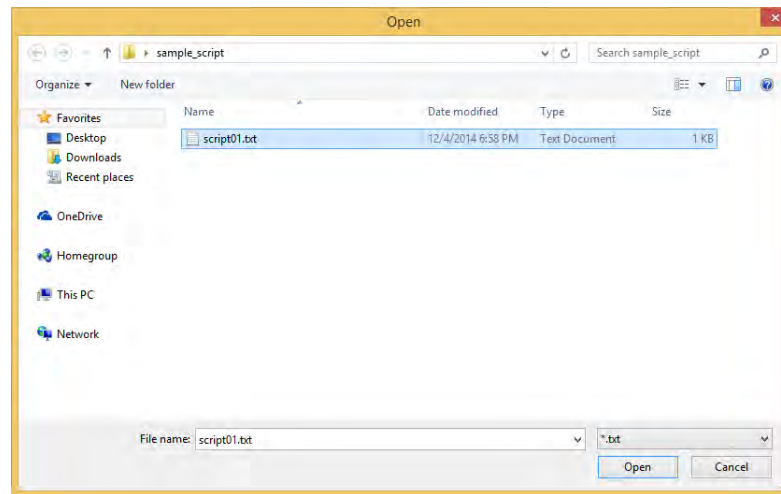

■ Export

The **Save As** dialog box is displayed.

By selecting a save location and clicking on the **Save** button, the script being edited is saved in text format (*.txt). A saved script can be inserted in the script using the **Import** button.

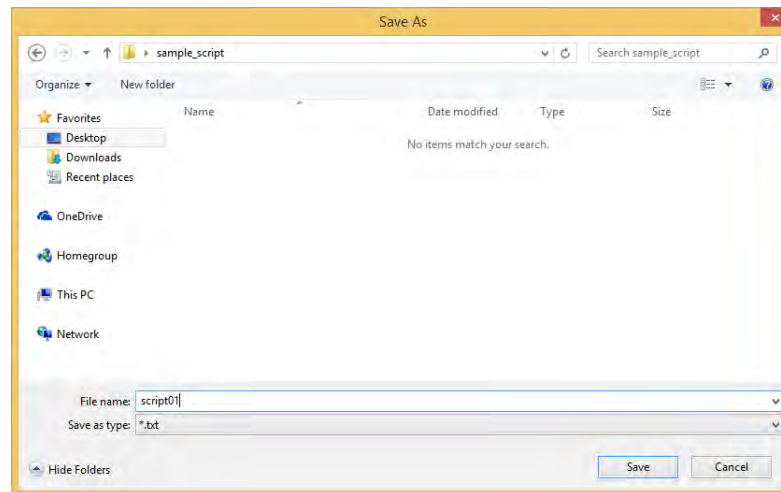

■ Options

The Options dialog box is displayed.

The fonts and color of the text, tab indents, etc., used in the **Script** text box are set in the Options dialog box. For details, refer to “Options Dialog Box” on page 20-15.

■ Find

The **Find** dialog box is displayed.

Enter the text to be searched for in the Find What box.

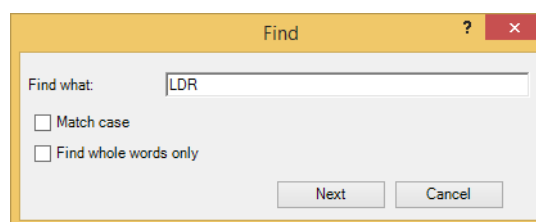

When the **Find** button is clicked after selecting a range in the **Script** text box, it will only search within the selected range.

■ Replace

The **Replace** dialog box is displayed.

Text entered in **Find what** will be replaced with the text entered in **Replace with**.

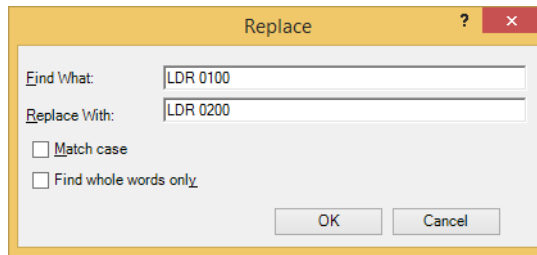

- This is useful when replacing device addresses.
- When the **Replace** button is clicked after selecting a range in the **Script** text box, it will only search and replace within the selected range.

■ Show/Hide Function List

Switches between showing and not showing the **Function List** and **Script Compilation Output**.



The size of the script edit box can be changed by dragging the right bottom corner of the Script Editor. By hiding the **Function List** and **Script Compilation Output**, the script editing area (text box) will become larger, making the editing of script easier.

■ Cursor

Displays the current position of the cursor in the **Script** text box by line number and column number.

■ Function List

Category:	Lists the categories of the functions.
Function:	Lists the functions of the selected category.
Format:	Displays the definition example of the selected function.
(description):	Displays the description of the selected function.
Insert Format:	Contents displayed in the selected Format are inserted at the cursor position.
Insert Device Address:	The Tag Editor is displayed. By specifying the device address and clicking on the OK button, specified device address is inserted at the cursor position.

■ Script Compilation Output

The contents of any errors found when using error check are displayed.

By double-clicking on the comment displayed in the **Script Compilation Output**, the part corresponding to the error is highlighted in the **Script** text box.



Depending on the error, there may be an error in the line that is different from the line displayed in the Script Compilation Output, or multiple errors may be displayed.

● Options Dialog Box

Font, **Size**, and **Color** used in the **Script** text box of the Script Editor can be specified.

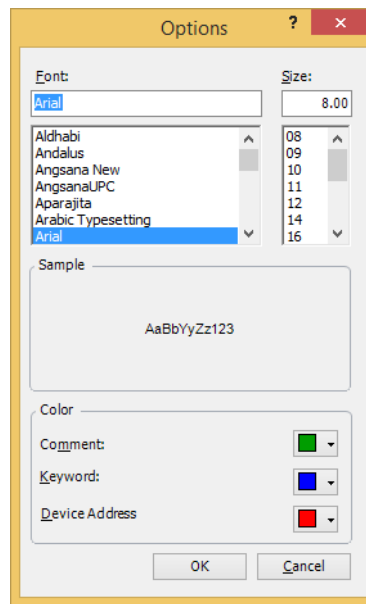

■ Font

The font name for the text displayed in the **Script** is entered or selected.

■ Size

The font size (dots) for the text displayed in the **Script** is entered or selected.

■ Sample

Displays a sample of the text with the **Font** and **Size** as specified in the **Script** text box.

■ Color

Displays each of the text colors for **Comment**, **Keyword**, and **Device Address**.

To change the text color, click ▼ on the right of the color to display the Color Palette and select the color.

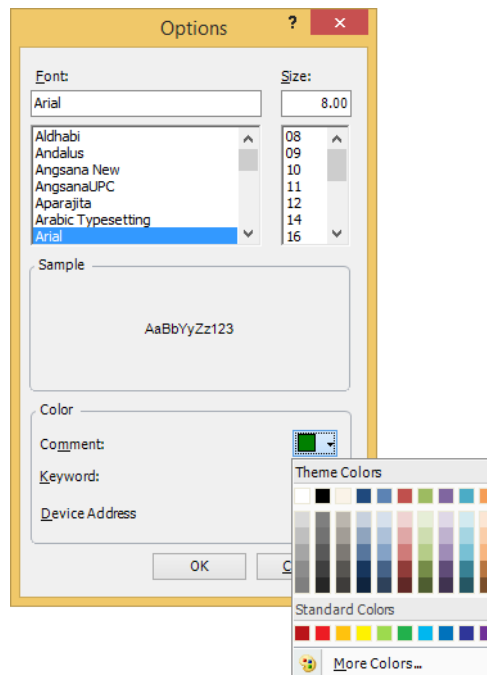

Text other than comment, keyword, or device address is displayed in black.

3 Global Script

HG2J-7U HG5G-V HG4G-V HG4G HG3G-V HG3G HG2G-V HG2G-5F HG2G-5T HG1G HG1P

A Global Script operates for the entire project. The scripts are executed in order on the list and in accordance with the trigger conditions after the parts on the MICRO/I screen are processed. A maximum of 16 Global Scripts can be set to a project.

3.1 Setting procedures for Global Script

Global Script is setup using the following procedures.

- 1 On the **Configuration** tab, in the **System Setup** group, click **Global Script**. The **Global Script Settings** dialog box is displayed.



- 2 Under **Settings**, select the script ID to configure, and then click **Edit**. The **Global Script** dialog box is displayed.

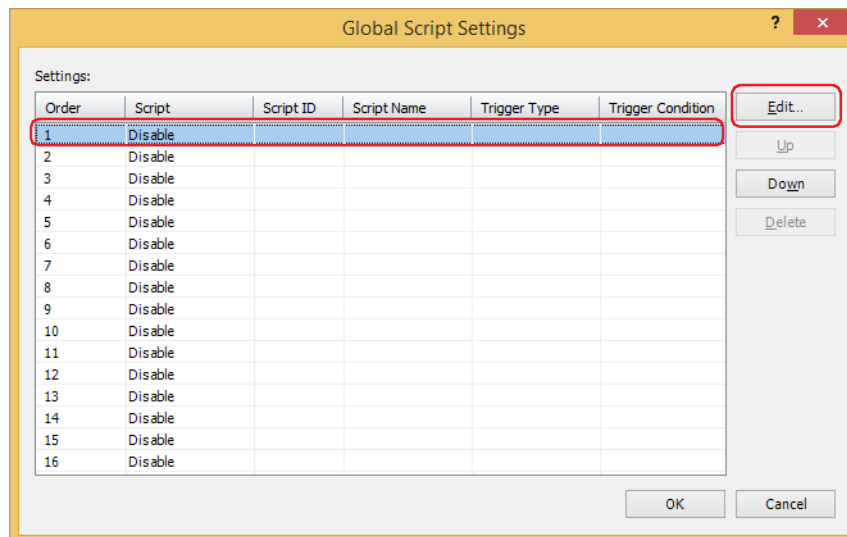

- 3 On the **General** tab, select the **Use Global Script** check box.

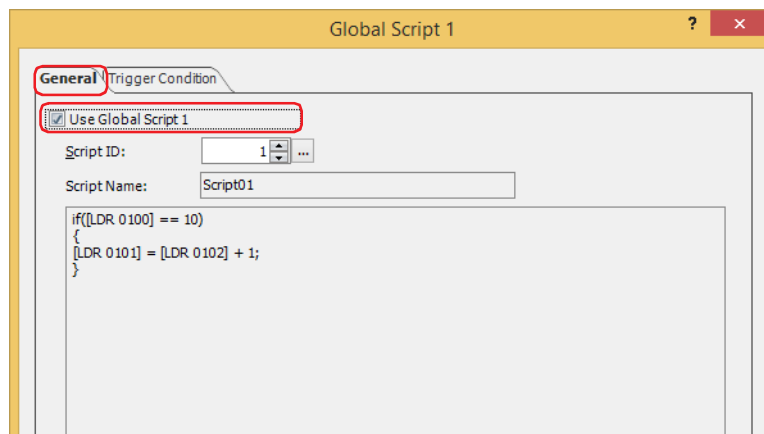

With Global Script, you cannot do indirect read and indirect write of the external device address. For details about the indirect read and indirect write, refer to Chapter 2 "Indirect Read and Indirect Write Settings" on page 2-5.

- 4 Specify the script ID (1 to 32,000) of the script to execute.

The Script Manager is displayed when the button is clicked. The script can be selected from the script list of the Script Manager. For details, refer to "2.2 Script Manager" on page 20-7.

- 5 Click **Trigger Condition** tab.

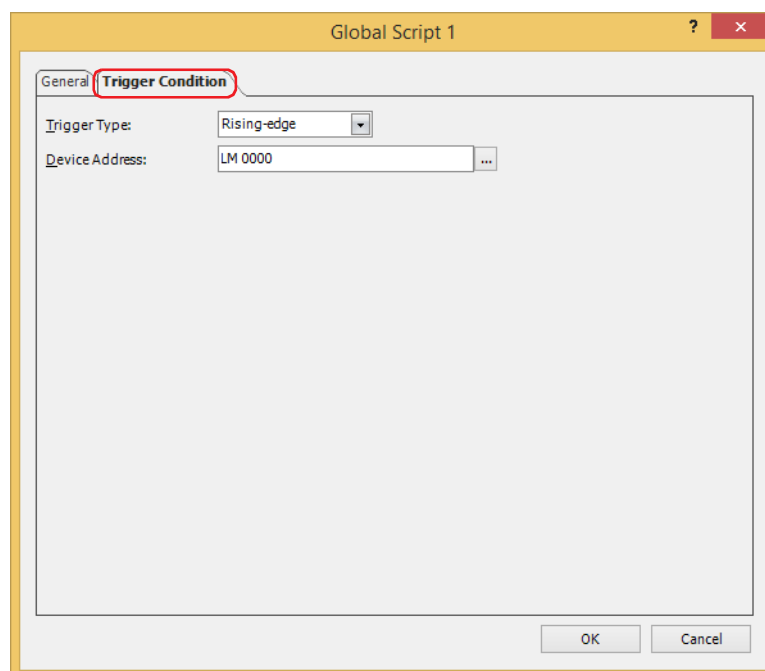

- 6 With **Trigger Type**, select the condition to execute the script.

- **Rising-edge**

Script is executed when trigger device address changes from 0 to 1. Specify the bit device or the bit number of the word device for **Device Address**.

Click to display the Tag Editor. For the device address configuration procedure, refer to Chapter 2 "5.1 Device Address Settings" on page 2-70.

- **Falling-edge**

Script is executed when trigger device address changes from 1 to 0. Specify the bit device or the bit number of the word device for **Device Address**.

Click to display the Tag Editor. For the device address configuration procedure, refer to Chapter 2 "5.1 Device Address Settings" on page 2-70.

- **Always Enabled**

The script is executed on every scan of the MICRO/I.

- **Fixed Period**

Script is executed at set intervals. Specify **Period** in seconds.

- 7 Click **OK** to close the **Global Script** dialog box.
- 8 Click **Close** on the **Global Script Settings** dialog box.
This concludes the Global Script configuration.

3.2 Global Script Settings Dialog Box

This section describes items and buttons on the **Global Script Settings** dialog box. Global Script is managed as a group in the **Global Script Settings** dialog box.

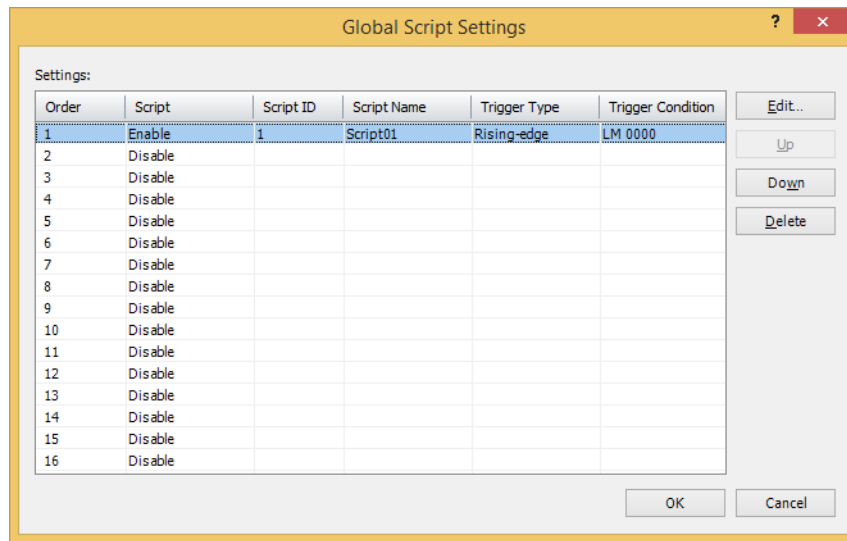

■ Settings

This area is for editing the Global Script settings.

Order: Displays the number (1 to 16) for the order to execute the Global Script.

Script: Displays whether or not to use the Global Script. Double clicking the cell switches between **Enable** and **Disable**.

Script ID: Specify the script ID (1 to 32,000) of the script to execute.

Script Name: Displays the name of the script specified by the script ID.

Trigger Type: Specify the condition to execute the script.

Trigger Condition: Displays details about the condition to execute the script. The displayed content varies based on **Trigger Type**.

Rising-edge, Falling-edge: Displays the bit device or the bit number of the word device to serve as condition.

Always Enabled: Nothing is displayed.

Fixed Period: Displays the specified period.

■ Edit

Registers or changes the Global Script settings for the selected line.

Click this button to display the **Global Script** dialog box.

The **Global Script** dialog box settings are reflected on the selected line.

For details, refer to "3.3 Global Script Dialog Box" on page 20-19.

■ Up

Shifts the selected Global Script settings up the list.

■ Down

Shifts the selected Global Script settings down the list.

■ Delete

Deletes the registered settings from the list.

3.3 Global Script Dialog Box

This section describes items and buttons on the **Global Script** dialog box.

● General Tab

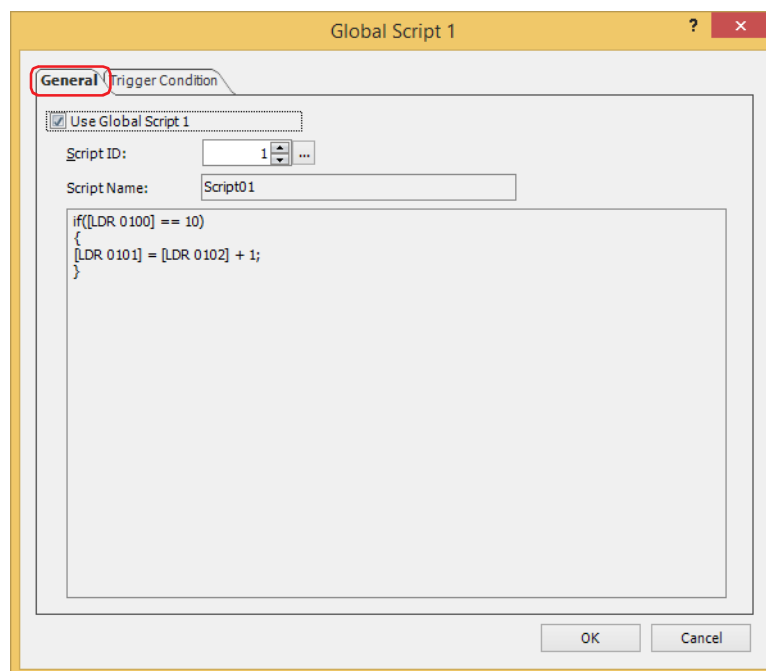

■ Use Global Script *n*

To use the Global Script, select the **Use Global Script *n*** (*n*: Order number) check box.



With Global Script, you cannot do indirect read and indirect write of the external device address. For details about the indirect read and indirect write, refer to Chapter 2 "Indirect Read and Indirect Write Settings" on page 2-5.

■ Script ID

Specify the script ID (1 to 32,000) of the script to execute.

The Script Manager is displayed when the  button is clicked. The script can be selected from the script list of the Script Manager. For details, refer to "2.2 Script Manager" on page 20-7.

■ Script Name

Displays the name of the script specified by the script ID.

■ Script

Displays the contents of the script specified by the script ID.

● Trigger Condition Tab

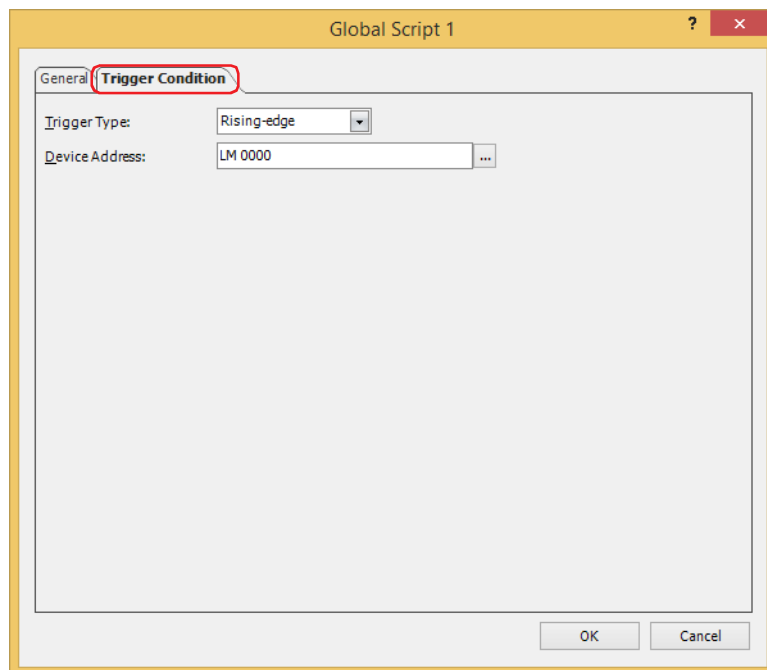

■ Trigger Type

Specify the condition to execute the script.

Rising-edge: Script is executed when trigger device address changes from 0 to 1.

Falling-edge: Script is executed when trigger device address changes from 1 to 0.

Always Enabled: The script is executed on every scan of the MICRO/I.

Fixed Period: Script is executed at set intervals.

■ Device Address

Specify the bit device or the bit number of the word device.

This is enabled only when **Rising-edge** or **Falling-edge** is selected in **Trigger Type**.

■ Period (sec)

Specify the scan frequency in seconds (1 to 3,600).

This is enabled only when **Fixed Period** is selected in **Trigger Type**.

4 Script Definition Method

HG2J-7U HG5G-V HG4G-V HG4G HG3G-V HG3G HG2G-V HG2G-5F HG2G-5T HG1G HG1P

4.1 Format List

This section describes the format and operation of control statements, operators, functions, data type designations, etc.

Enter everything except comments in single-byte. For specific definition examples, refer to "5 Script Coding Examples" on page 20-32.

● Control statements

Conditional expressions are described as `(Cond. expr.)`, `(Cond. expr. 1)`, `(Cond. expr. 2)` here. Execution lines are described as `(Exe. line)`, `(Exe. line 1)`, `(Exe. line 2)` ...

■ Conditional branching

	Format	Description
if else else if	<pre> if (Cond. expr.) { (Exe. line); } </pre>	Execution line is executed if the conditional expression is satisfied.
	<pre> if (Cond. expr.) { (Exe. line 1); } else { (Exe. line 2); } </pre>	Execution line 1 is executed if the conditional expression is satisfied. Execution line 2 is executed if it is not satisfied.
	<pre> if (Cond. expr.1) { (Exe. line 1); } else if (Cond. expr.2) { (Exe. line 2); } else { (Exe. line 3); } </pre>	Execution line 1 is executed if the conditional expression 1 is satisfied. Conditional expression 2 is determined if conditional expression 1 is not satisfied, and execution line 2 is executed if conditional expression 2 is satisfied. Execution line 3 is executed if conditional expression 2 is not satisfied too.
switch case default	<pre> switch (Cond. expr.) { case constant 1: (Exe. line 1); break; case constant2: (Exe. line 2); break; default: (Exe. line 3); break; } </pre>	Execution line 1 is executed if the value of conditional expression matches constant 1. Execution line 2 is executed if the value of conditional expression matches constant 2. Execution line 3 is executed if the value of conditional expression does not match constant 1 nor constant 2.

■ Repeat

Format		Description
while	<pre>while ((Cond. expr.)) { (Exe. line); }</pre>	<p>Execution line is repeatedly executed while the conditional expression is satisfied.</p> <ul style="list-style-type: none"> • It will go into an infinite loop when the conditional expression is always satisfied, so do not set fixed values or device addresses that do not change as the conditional expression. • Do not write a value to the external device address in the while definition.

■ Halt and exit

Format		Description
break	<pre>while ((Cond. expr. 1)) { if ((Cond. expr. 2)) { (Exe. line 1); break; } (Exe. line 2); } (Exe. line 3);</pre>	<p>Process will be as follows while the conditional expression 1 is satisfied.</p> <ul style="list-style-type: none"> • Execution line 2 is continuously executed while the conditional expression 2 is not satisfied. • Once the conditional expression is satisfied, it will go out of the loop by break (not executing execution line 2), and execution line 3 is executed.
	<pre>switch ((Cond. expr.)) { case constant 1: (Exe. line 1); break; case constant 2: (Exe. line 2); break; } (Exe. line 3);</pre>	<p>When the conditional expression 2 matches the constant 1, it will halt the determination of constant 2 by break after executing execution line 1, and process will move to execution line 3.</p>
return	return;	It will exit the script, and execute the next parts or script.

● Operator

Device address, constant, and Temporary Variable are described as \boxed{a} , \boxed{b} here, and expression is described as $\boxed{\text{Expr.}}$, $\boxed{\text{Expr. 1}}$, $\boxed{\text{Expr. 2}}$.

■ Relational operator

Operator	Format	Description
=	$\boxed{a} = \boxed{b}$	Compares if \boxed{a} is equal to \boxed{b} .
!=	$\boxed{a} != \boxed{b}$	Compares if \boxed{a} is not equal to \boxed{b} .
<	$\boxed{a} < \boxed{b}$	Compares if \boxed{a} is less than \boxed{b} .
<=	$\boxed{a} <= \boxed{b}$	Compares if \boxed{a} is equal or less than \boxed{b} .
>	$\boxed{a} > \boxed{b}$	Compares if \boxed{a} is greater than \boxed{b} .
>=	$\boxed{a} >= \boxed{b}$	Compares if \boxed{a} is equal or greater than \boxed{b} .

■ Logical operator

Operator	Format	Description
&&	$\boxed{\text{Expr. 1}} \ \&\& \ \boxed{\text{Expr. 2}}$	Calculates the logical product (AND) of $\boxed{\text{Expr. 1}}$ and $\boxed{\text{Expr. 2}}$.
	$\boxed{\text{Expr. 1}} \ \ \boxed{\text{Expr. 2}}$	Calculates the logical sum (OR) of $\boxed{\text{Expr. 1}}$ and $\boxed{\text{Expr. 2}}$.
!	$! \ \boxed{\text{Expr.}}$	Reverses the logic of $\boxed{\text{Expr.}}$.

■ Arithmetic operator

Operator	Format	Description
+	$\boxed{a} + \boxed{b}$	Adds \boxed{a} and \boxed{b} .
-	$\boxed{a} - \boxed{b}$	Subtracts \boxed{b} from \boxed{a} .
*	$\boxed{a} * \boxed{b}$	Multiplies \boxed{a} and \boxed{b} .
/	\boxed{a} / \boxed{b}	Divides \boxed{a} by \boxed{b} .
%	$\boxed{a} \% \boxed{b}$	Calculates remainder after dividing \boxed{a} by \boxed{b} .
=	$\boxed{a} = \boxed{b}$	Assigns \boxed{b} to \boxed{a} .

■ Bit operator

Operator	Format	Description
&	$\boxed{a} \ \& \ \boxed{b}$	Calculates the logical product (AND) of each bit of \boxed{a} and \boxed{b} .
	$\boxed{a} \ \ \boxed{b}$	Calculates the logical sum (OR) of each bit of \boxed{a} and \boxed{b} .
^	$\boxed{a} \ \wedge \ \boxed{b}$	Calculates the exclusive logical sum (XOR) of each bit of \boxed{a} and \boxed{b} .
~	$\sim \boxed{a}$	Reverses the logic of each bits of \boxed{a} . For word device and fixed values, 0 will be 65535, and 65535 will be 0. For bit device, 0 will be 1, and 1 will be 0.
<<	$\boxed{a} \ \ll \ \boxed{b}$	Shifts each bit of \boxed{a} to left for \boxed{b} bit(s).
>>	$\boxed{a} \ \gg \ \boxed{b}$	Shifts each bit of \boxed{a} to right for \boxed{b} bit(s).

● Function

Device address, constant, and Temporary Variable are described as \boxed{a} , \boxed{b} , \boxed{c} , \boxed{d} ... here.
Function that can be used is based on the selected data type.

■ Bit function

Function	Format	Description
Bit set	SET (\boxed{a});	Turns bit device \boxed{a} to 1. It will be same result as $\boxed{a} = 1;$.
Bit reset	RST (\boxed{a});	Turns bit device \boxed{a} to 0. It will be same result as $\boxed{a} = 0;$.
Bit reverse	REV (\boxed{a});	Reverses the 1 and 0 of bit device \boxed{a} . It will be same result as $\boxed{a} = \sim \boxed{a};$.

■ Word function

Arithmetic operation

Function	Format	Description
Maximum value	MAX (\boxed{a} , \boxed{b} , \boxed{c})	Maximum value out of argument \boxed{a} , \boxed{b} , \boxed{c} is returned. Up to 15 arguments can be defined.
Minimum value	MIN (\boxed{a} , \boxed{b} , \boxed{c})	Minimum value out of argument \boxed{a} , \boxed{b} , \boxed{c} is returned. Up to 15 arguments can be defined.
Exponential function	EXP (\boxed{a})	Exponential function of argument \boxed{a} is returned. This function can only be configured when the Float32(F) is specified as the Data Type .
Natural logarithm (Base: e)	LOGE (\boxed{a})	Natural logarithm (base is e) for argument \boxed{a} is returned. Set a value larger than 0 for argument. This function can only be configured when the Float32(F) is specified as the Data Type .
Common logarithm (Base: 10)	LOG10 (\boxed{a})	Common logarithm (base is 10) for argument \boxed{a} is returned. Set a value larger than 0 for argument. This function can only be configured when the Float32(F) is specified as the Data Type .
Exponentiation	POW (\boxed{a} , \boxed{b})	\boxed{a} to the \boxed{b} power is returned. This function can only be configured when the Float32(F) is specified as the Data Type .
Square root	ROOT (\boxed{a})	Square root of \boxed{a} is returned. This function can only be configured when the Float32(F) is specified as the Data Type .
Sine	SIN (\boxed{a})	Sine of \boxed{a} (-1 - +1) is returned. Specify arbitrary formula to represent angle (units in radian) for argument \boxed{a} . This function can only be configured when the Float32(F) is specified as the Data Type .
Cosine	COS (\boxed{a})	Cosine of \boxed{a} (-1 - +1) is returned. Specify arbitrary formula to represent angle (units in radian) for argument \boxed{a} . This function can only be configured when the Float32(F) is specified as the Data Type .
Tangent	TAN (\boxed{a})	Tangent of \boxed{a} (-1 - +1) is returned. Specify arbitrary formula to represent angle (units in radian) for argument \boxed{a} . This function can only be configured when the Float32(F) is specified as the Data Type .

(Continued to next page)

Arithmetic operation (Continued)

Function	Format	Description
Arcsine	ASIN (<input type="text" value="a"/>)	Arcsine of <input type="text" value="a"/> (-1 - +1) in radian value (- $\pi/2$ - + $\pi/2$) is returned. Specify arbitrary formula for argument <input type="text" value="a"/> . This function can only be configured when the Float32(F) is specified as the Data Type .
Arccosine	ACOS (<input type="text" value="a"/>)	Arccosine of <input type="text" value="a"/> (-1 - +1) in radian value (0 - π) is returned. Specify arbitrary formula for argument <input type="text" value="a"/> . This function can only be configured when the Float32(F) is specified as the Data Type .
Arctangent	ATAN (<input type="text" value="a"/>) ;	Arctangent of <input type="text" value="a"/> (-1 - +1) in radian value (- $\pi/2$ - + $\pi/2$) is returned. Specify arbitrary formula for argument <input type="text" value="a"/> . This function can only be configured when the Float32(F) is specified as the Data Type .
Conversion from Angle to Radian	RAD (<input type="text" value="a"/>) ;	Value of <input type="text" value="a"/> is converted from degree ($^{\circ}$) to radian, and the value is returned. This function can only be configured when the Float32(F) is specified as the Data Type .
Conversion from Radian to Angle	DEG (<input type="text" value="a"/>) ;	Value of <input type="text" value="a"/> is converted from radian to degree ($^{\circ}$), and the value is returned. This function can only be configured when the Float32(F) is specified as the Data Type .

Data type conversion

Function	Format	Description
Conversion from BCD to Binary	BCD2BIN (<input type="text" value="a"/>)	BCD value of <input type="text" value="a"/> is returned in binary value. This function can only be configured when UBIN16(W) , BIN16(I) , UBIN32(D) or BIN32(L) is specified as the Data Type .
Conversion from Binary to BCD	BIN2BCD (<input type="text" value="a"/>)	Binary value of <input type="text" value="a"/> is returned in BCD value. This function can only be configured when UBIN16(W) , BIN16(I) , UBIN32(D) or BIN32(L) is specified as the Data Type .
Conversion from Floating point to Binary	FLOAT2BIN (<input type="text" value="a"/>)	Float32 value of <input type="text" value="a"/> is returned in floating point value. Values under the decimal point is truncated. This function can only be configured when UBIN32(D) or BIN32(L) is specified as the Data Type .
Conversion from Binary to Floating point	BIN2FLOAT (<input type="text" value="a"/>)	Binary value of <input type="text" value="a"/> is returned in floating point value. This function can only be configured when UBIN32(D) or BIN32(L) is specified as the Data Type .
Conversion from Decimal to String character	DEC2ASCII (<input type="text" value="a"/> , <input type="text" value="b"/>)	Decimal number value <input type="text" value="b"/> is converted to a character string, and store in order with <input type="text" value="a"/> as a beginning device address. This function can only be configured when UBIN16(W) , BIN16(I) , UBIN32(D) , BIN32(L) , BCD4(B) or BCD8(EB) is specified as the Data Type .
Conversion from String character to Decimal	ASCII2DEC (<input type="text" value="a"/>)	Character string <input type="text" value="a"/> is returned as decimal number value. This function can only be configured when UBIN16(W) , BIN16(I) , UBIN32(D) , BIN32(L) , BCD4(B) or BCD8(EB) is specified as the Data Type .

Data comparison and copy

Function	Format	Description
Data comparison	MEMCMP (<input type="text" value="a"/> , <input type="text" value="b"/> , <input type="text" value="c"/>)	<input type="text" value="a"/> : Beginning device address of comparison target 1 <input type="text" value="b"/> : Beginning device address of comparison target 2 <input type="text" value="c"/> : Range of comparison (in words) Values of device address <input type="text" value="a"/> for <input type="text" value="c"/> words and values of device address <input type="text" value="b"/> for <input type="text" value="c"/> words are compared. 1 is returned if all the values of device addresses match, and 0 is returned if any of the value does not match. Specified range is compared in word unit, and result is returned.
Data copy	MEMCPY (<input type="text" value="a"/> , <input type="text" value="b"/> , <input type="text" value="c"/>)	<input type="text" value="a"/> : Beginning device address of copy source <input type="text" value="b"/> : Beginning device address of copy target <input type="text" value="c"/> : Range of copy (in words) Values of device address from <input type="text" value="a"/> for <input type="text" value="c"/> words are copied to <input type="text" value="b"/> for <input type="text" value="c"/> words respectively. Specified range is copied in word unit.

Character string operation

Only internal devices can be specified as an argument for character string operation function.

Termination character NULL (0x00) is treated as end of character string when character string is handled. Also, termination character NULL is not included in the length of the character string.

Function	Format	Description
Character string copy	STRCUT (<input type="text" value="a"/> , <input type="text" value="b"/> , <input type="text" value="c"/> , <input type="text" value="d"/>)	<input type="text" value="a"/> : Beginning device address of copy target <input type="text" value="b"/> : Beginning device address containing copy source character string <input type="text" value="c"/> : Start location of copy (0-127) <input type="text" value="d"/> : Number of characters to copy (1-128) From the character string starting from <input type="text" value="b"/> , character string from <input type="text" value="c"/> bytes forward for <input type="text" value="d"/> characters are stored into <input type="text" value="a"/> for <input type="text" value="d"/> characters.
Character number count	STRLEN (<input type="text" value="a"/>)	Number of characters for character string starting from <input type="text" value="a"/> is returned.
Character string concatenation	STRCAT (<input type="text" value="a"/> , <input type="text" value="b"/>)	To the character string starting from <input type="text" value="a"/> , the character string starting from <input type="text" value="b"/> is concatenated, and <input type="text" value="a"/> is returned to beginning.
Character string search	STRSTR (<input type="text" value="a"/> , <input type="text" value="b"/>)	From the character string starting from <input type="text" value="a"/> , character string starting from <input type="text" value="b"/> is searched, and location found (number of characters from beginning -1) is returned. Maximum number for character string to search is 128 characters.

Draw

- This is a function to draw an object on the screen. Top left corner of the screen is coordinates X=0 and Y=0.
- When a device address is used as an argument, an object is drawn with the changed value when the value is changed. However, the object that is already drawn is not erased. To erase the drawn object, overwrite it with the background color.
- When an out-of-range value is used as an argument, 5 is stored in the HMI Special Data Register LSD53 and script is halted.
- Objects that are drawn with scripts for parts placed on the top layer are not drawn on the top layer.

Example: The Multi-Button is placed on the top layer of a base screen and the script CIRCLE is executed to draw a circle or ellipse by pressing the Multi-Button
 The settings of the script CIRCLE: center coordinate X is 80, center coordinate Y is 120, X-axis radius is 60, Y-axis radius is 60, line width is 1, line type is 1, foreground color is 20, background color is 0, and the pattern is 2

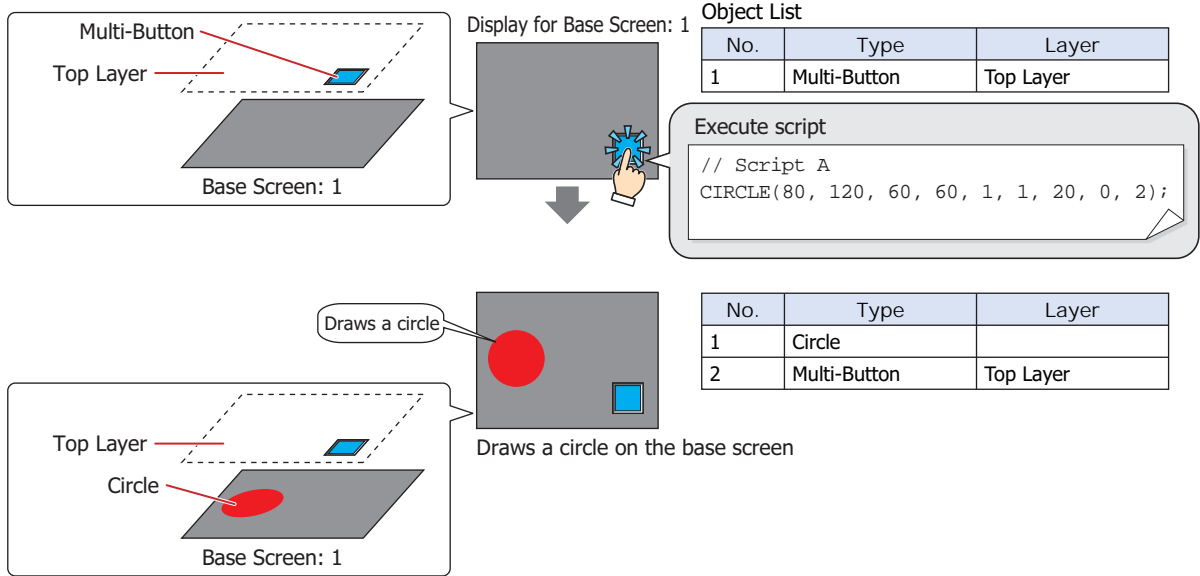

Function	Format	Description													
Drawing of straight line	LINE (<input type="text" value="a"/> , <input type="text" value="b"/> , <input type="text" value="c"/> , <input type="text" value="d"/> , <input type="text" value="e"/> , <input type="text" value="f"/> , <input type="text" value="g"/>)	Straight line connecting the start coordinate and end coordinate is drawn. <input type="text" value="a"/> : Start coordinate X, <input type="text" value="b"/> : Start coordinate Y, <input type="text" value="c"/> : End coordinate X, <input type="text" value="d"/> : End coordinate Y, <input type="text" value="e"/> : Line width, <input type="text" value="f"/> : Line type, <input type="text" value="g"/> : Line color • <input type="text" value="e"/> : Line width, <input type="text" value="f"/> : Line type, <input type="text" value="g"/> : Line color can be omitted. • Specification of <input type="text" value="e"/> : Line width is as follows: <table border="1" style="margin-left: 20px;"> <thead> <tr> <th>Preset Value</th> <th>1</th> <th>2</th> <th>3</th> <th>5</th> </tr> </thead> <tbody> <tr> <td>Line Width</td> <td>1 dot</td> <td>2 dots</td> <td>3 dots</td> <td>5 dots</td> </tr> </tbody> </table> It will be set to 1 (1 dot) when omitted.	Preset Value	1	2	3	5	Line Width	1 dot	2 dots	3 dots	5 dots			
	Preset Value	1	2	3	5										
Line Width	1 dot	2 dots	3 dots	5 dots											
LINE (<input type="text" value="a"/> , <input type="text" value="b"/> , <input type="text" value="c"/> , <input type="text" value="d"/>)	• Specification of <input type="text" value="f"/> : Line type is as follows. <table border="1" style="margin-left: 20px;"> <thead> <tr> <th>Preset Value</th> <th>1</th> <th>2</th> <th>3</th> <th>4</th> <th>5</th> <th>6</th> </tr> </thead> <tbody> <tr> <td>Line Type</td> <td>Solid</td> <td>Dot</td> <td>Dash</td> <td>Long Dash</td> <td>Long Dash Dot</td> <td>Long Dash Dot Dot</td> </tr> </tbody> </table> It will be set to 1 (Solid) when omitted or when the line width is set to anything other than 1 (1 dot). • <input type="text" value="g"/> : Line color is specified by the color data. It will be set to 255 (white) when omitted. For color data, refer to Appendix "Color Data Correspondence Table" on page A-1.	Preset Value	1	2	3	4	5	6	Line Type	Solid	Dot	Dash	Long Dash	Long Dash Dot	Long Dash Dot Dot
Preset Value	1	2	3	4	5	6									
Line Type	Solid	Dot	Dash	Long Dash	Long Dash Dot	Long Dash Dot Dot									

(Continued to next page)

Draw (Continued)

Function	Format	Description																																		
Drawing of Rectangle	<pre> RECTANGLE ([a] , [b] , [c] , [d] , [e] , [f] , [g] , [h] , [i] , [j] , [k]) </pre>	<p>Rectangle with left top corner as start coordinate and bottom right corner as end coordinate is drawn.</p> <p>[a] : Start coordinate X, [b] : Start coordinate Y, [c] : End coordinate X, [d] : End coordinate Y, [e] : Line width, [f] : Line type, [g] : Foreground color, [h] : Background color, [i] : Pattern, [j] : Rounded corner type, [k] : Rounded corner radius</p> <ul style="list-style-type: none"> • [e] : Line width, [f] : Line type, [g] : Foreground color, [h] : Background color, [i] : Pattern, [j] : Rounded corner type, [k] : Rounded corner radius can be omitted. • Specification of [e] : Line width is as follows: <table border="1" data-bbox="778 521 1394 577"> <tr> <td>Preset Value</td> <td>1</td> <td>2</td> <td>3</td> <td>5</td> </tr> <tr> <td>Line Width</td> <td>1 dot</td> <td>2 dots</td> <td>3 dots</td> <td>5 dots</td> </tr> </table> <p>It will be set to 1 (1 dot) when omitted.</p> <ul style="list-style-type: none"> • Specification of [f] : Line type is as follows. <table border="1" data-bbox="778 647 1394 725"> <tr> <td>Preset Value</td> <td>1</td> <td>2</td> <td>3</td> <td>4</td> <td>5</td> <td>6</td> </tr> <tr> <td>Line Type</td> <td>Solid</td> <td>Dot</td> <td>Dash</td> <td>Long Dash</td> <td>Long Dash Dot</td> <td>Long Dash Dot Dot</td> </tr> </table> <p>It will be set to 1 (Solid) when omitted or when the line width is set to anything other than 1 (1 dot).</p>	Preset Value	1	2	3	5	Line Width	1 dot	2 dots	3 dots	5 dots	Preset Value	1	2	3	4	5	6	Line Type	Solid	Dot	Dash	Long Dash	Long Dash Dot	Long Dash Dot Dot										
	Preset Value	1	2	3	5																															
Line Width	1 dot	2 dots	3 dots	5 dots																																
Preset Value	1	2	3	4	5	6																														
Line Type	Solid	Dot	Dash	Long Dash	Long Dash Dot	Long Dash Dot Dot																														
	<pre> RECTANGLE ([a] , [b] , [c] , [d]) </pre>	<ul style="list-style-type: none"> • [g] : Foreground color, [h] : Background color is specified by the color data. It will be set to 255 (white) when omitted. For color data, refer to Appendix "Color Data Correspondence Table" on page A-1. • Specification of [i] : Pattern is as follows. <table border="1" data-bbox="778 943 1431 1021"> <tr> <td>Preset Value</td> <td>0</td> <td>2</td> <td>3</td> <td>4</td> <td>7</td> <td>8</td> </tr> <tr> <td>Line Type</td> <td>None</td> <td>Foreground 100%</td> <td>Foreground 25%</td> <td>Foreground 50%</td> <td>Background 100%</td> <td>Horizontal lines</td> </tr> </table> <table border="1" data-bbox="778 1032 1342 1111"> <tr> <td>Preset Value</td> <td>9</td> <td>10</td> <td>11</td> <td>12</td> <td>13</td> </tr> <tr> <td>Line Type</td> <td>Vertical lines</td> <td>Slant Upwards</td> <td>Slant Down-wards</td> <td>Cross-hatch</td> <td>Tint</td> </tr> </table> <p>It will be set to 0 (None) when omitted.</p> <ul style="list-style-type: none"> • Specification of [j] : Rounded corner type is as follows. <table border="1" data-bbox="778 1182 1394 1238"> <tr> <td>Preset Value</td> <td>0</td> <td>1</td> <td>2</td> </tr> <tr> <td>Line Type</td> <td>None</td> <td>Straight</td> <td>Curve</td> </tr> </table> <p>It will be set to 0 (None) when omitted.</p> <ul style="list-style-type: none"> • [k] : Rounded corner radius is specified with number of dots (0 - 200). It will be set to 0 (0 dot) when omitted. 	Preset Value	0	2	3	4	7	8	Line Type	None	Foreground 100%	Foreground 25%	Foreground 50%	Background 100%	Horizontal lines	Preset Value	9	10	11	12	13	Line Type	Vertical lines	Slant Upwards	Slant Down-wards	Cross-hatch	Tint	Preset Value	0	1	2	Line Type	None	Straight	Curve
Preset Value	0	2	3	4	7	8																														
Line Type	None	Foreground 100%	Foreground 25%	Foreground 50%	Background 100%	Horizontal lines																														
Preset Value	9	10	11	12	13																															
Line Type	Vertical lines	Slant Upwards	Slant Down-wards	Cross-hatch	Tint																															
Preset Value	0	1	2																																	
Line Type	None	Straight	Curve																																	

(Continued to next page)

Draw (Continued)

Function	Format	Description																																																		
Drawing of circle and ellipse	CIRCLE (<input type="text" value="a"/> , <input type="text" value="b"/> , <input type="text" value="c"/> , <input type="text" value="d"/> , <input type="text" value="e"/> , <input type="text" value="f"/> , <input type="text" value="g"/> , <input type="text" value="h"/> , <input type="text" value="i"/>)	<p>A circle with specified radius from center coordinate is drawn.</p> <p><input type="text" value="a"/> : Center coordinate X, <input type="text" value="b"/> : Center coordinate Y, <input type="text" value="c"/> : X axis radius, <input type="text" value="d"/> : Y axis radius, <input type="text" value="e"/> : Line width, <input type="text" value="f"/> : Line type, <input type="text" value="g"/> : Foreground color, <input type="text" value="h"/> : Background color, <input type="text" value="i"/> : Pattern</p> <ul style="list-style-type: none"> <input type="text" value="e"/> : Line width, <input type="text" value="f"/> : Line type, <input type="text" value="g"/> : Foreground color, <input type="text" value="h"/> : Background color, <input type="text" value="i"/> : Pattern can be omitted. Specification of <input type="text" value="e"/> : Line width is as follows: <table border="1"> <thead> <tr> <th>Preset Value</th> <th>1</th> <th>2</th> <th>3</th> <th>5</th> </tr> </thead> <tbody> <tr> <td>Line Width</td> <td>1 dot</td> <td>2 dots</td> <td>3 dots</td> <td>5 dots</td> </tr> </tbody> </table> <p>It will be set to 1 (1 dot) when omitted.</p> <ul style="list-style-type: none"> Specification of <input type="text" value="f"/> : Line type is as follows. <table border="1"> <thead> <tr> <th>Preset Value</th> <th>1</th> <th>2</th> <th>3</th> <th>4</th> <th>5</th> <th>6</th> </tr> </thead> <tbody> <tr> <td>Line Type</td> <td>Solid</td> <td>Dot</td> <td>Dash</td> <td>Long Dash</td> <td>Long Dash Dot</td> <td>Long Dash Dot Dot</td> </tr> </tbody> </table> <p>It will be set to 1 (Solid) when omitted or when the line width is set to anything other than 1 (1 dot).</p> <ul style="list-style-type: none"> <input type="text" value="g"/> : Foreground color, <input type="text" value="h"/> : Background color is specified by the color data. It will be set to 255 (white) when omitted. For color data, refer to Appendix "Color Data Correspondence Table" on page A-1. Specification of <input type="text" value="i"/> : Pattern is as follows. <table border="1"> <thead> <tr> <th>Preset Value</th> <th>0</th> <th>2</th> <th>3</th> <th>4</th> <th>7</th> <th>8</th> </tr> </thead> <tbody> <tr> <td>Line Type</td> <td>None</td> <td>Foreground 100%</td> <td>Foreground 25%</td> <td>Foreground 50%</td> <td>Background 100%</td> <td>Horizontal lines</td> </tr> </tbody> </table> <table border="1"> <thead> <tr> <th>Preset Value</th> <th>9</th> <th>10</th> <th>11</th> <th>12</th> <th>13</th> </tr> </thead> <tbody> <tr> <td>Line Type</td> <td>Vertical lines</td> <td>Slant Upwards</td> <td>Slant Down-wards</td> <td>Cross-hatch</td> <td>Tint</td> </tr> </tbody> </table> <p>It will be set to 0 (none) when omitted.</p>	Preset Value	1	2	3	5	Line Width	1 dot	2 dots	3 dots	5 dots	Preset Value	1	2	3	4	5	6	Line Type	Solid	Dot	Dash	Long Dash	Long Dash Dot	Long Dash Dot Dot	Preset Value	0	2	3	4	7	8	Line Type	None	Foreground 100%	Foreground 25%	Foreground 50%	Background 100%	Horizontal lines	Preset Value	9	10	11	12	13	Line Type	Vertical lines	Slant Upwards	Slant Down-wards	Cross-hatch	Tint
	Preset Value	1	2	3	5																																															
Line Width	1 dot	2 dots	3 dots	5 dots																																																
Preset Value	1	2	3	4	5	6																																														
Line Type	Solid	Dot	Dash	Long Dash	Long Dash Dot	Long Dash Dot Dot																																														
Preset Value	0	2	3	4	7	8																																														
Line Type	None	Foreground 100%	Foreground 25%	Foreground 50%	Background 100%	Horizontal lines																																														
Preset Value	9	10	11	12	13																																															
Line Type	Vertical lines	Slant Upwards	Slant Down-wards	Cross-hatch	Tint																																															
	CIRCLE (<input type="text" value="a"/> , <input type="text" value="b"/> , <input type="text" value="c"/> , <input type="text" value="d"/>)																																																			

Offset

Function	Format	Description
Indirect specification	OFFSET (<input type="text" value="a"/> , <input type="text" value="b"/>)	<p><input type="text" value="a"/> : Reference device address <input type="text" value="b"/> : Device address to store the indirect value (0 to 32767) Specify the device address <input type="text" value="b"/> words from <input type="text" value="a"/>.</p> <p>Indirect read Specify OFFSET function to the right of the assignment statement. Format example: <input type="text" value="c"/> = OFFSET (<input type="text" value="a"/> , <input type="text" value="b"/>) Operation: Stores the value of device address in <input type="text" value="b"/> words from <input type="text" value="a"/> into <input type="text" value="c"/>.</p> <p>Indirect write Specify OFFSET function to the left of the assignment statement. Format example: OFFSET (<input type="text" value="a"/> , <input type="text" value="b"/>) = <input type="text" value="c"/> Operation: Stores the value of <input type="text" value="c"/> into the device address <input type="text" value="b"/> words from <input type="text" value="a"/>.</p> <ul style="list-style-type: none"> Store the value appropriate for the data type as the indirect value. As an example, when the data type is BCD4(B), store the indirect value of BCD4(B) into the device address.

● Data Type Designations

You can specify individual data types for the operations in braces "{}". Here, the abbreviations are shown in parentheses and the Execution lines are described as (Exe. line 1), (Exe. line 2), ...

Function	Format		Description
Specifies the UBIN16(W)	asword (asw)	asword { (Exe. line 1); } (Exe. line 2);	Executes the executable statement 1 with the data type UBIN16 (W). Executes the executable statement 2 with the data type configured in the Data Type on the Script Editor.
Specifies the BIN16(I)	asinteger (asi)	asinteger { (Exe. line 1); } (Exe. line 2);	Executes the executable statement 1 with the data type BIN16(I). Executes the executable statement 2 with the data type configured in the Data Type on the Script Editor.
Specifies the UBIN32(D)	asdoubleword (asd)	asdoubleword { (Exe. line 1); } (Exe. line 2);	Executes the executable statement 1 with the data type UBIN32(D). Executes the executable statement 2 with the data type configured in the Data Type on the Script Editor.
Specifies the BIN32(L)	aslong (asl)	aslong { (Exe. line 1); } (Exe. line 2);	Executes the executable statement 1 with the data type BIN32(L). Executes the executable statement 2 with the data type configured in the Data Type on the Script Editor.
Specifies the BCD4(B)	asbcd4 (asb4)	asbcd4 { (Exe. line 1); } (Exe. line 2);	Executes the executable statement 1 with the data type BCD4(B). Executes the executable statement 2 with the data type configured in the Data Type on the Script Editor.
Specifies the BCD8(EB)	asbcd8 (asb8)	asbcd8 { (Exe. line 1); } (Exe. line 2);	Executes the executable statement 1 with the data type BCD8(EB). Executes the executable statement 2 with the data type configured in the Data Type on the Script Editor.
Specifies the Float32(F)	asfloat (asf)	asfloat { (Exe. line 1); } (Exe. line 2);	Executes the executable statement 1 with the data type Float32(F). Executes the executable statement 2 with the data type configured in the Data Type on the Script Editor.

● Other

This section provides definitions for constant, device address, Temporary Variable, and comment.

■ Constant

Constant can be defined as decimal or hexadecimal numbers.

Sample definition of decimal numbers

```
1234
```

Define the numeric value directly.

```
-1234
```

Define the negative number with a "-" (minus) symbol at the beginning.

```
12.34
```

Decimal number can be defined for real numbers (Float32(F)). Define a "." (period) between the whole numbers and decimal numbers.

There are 2 ways to define hexadecimal numbers.

Sample definition of hexadecimal numbers

```
0x12AB
```

Define "0" (zero) and "x" (lower case x) at the beginning of the value.

```
12ABh
```

Append "h" at the tail of the value.

■ Device Address

Device Address is defined with the device type and address within "[" and "]".

Definition of the device address

```
[Device type_address number]
```

("_" represents a space.)

Sample definition

```
[LDR 100]
```

■ Temporary Variable

The Temporary Variable is a variable that can be used only with the script. The data size of the Temporary Variable is 2 words.

Writes "@" (at sign) and number (1 to 16).

Definition of the Temporary Variable

```
@Number
```

Space between the "@" (at sign) and the number is not required.

Sample definition

```
@2
```

Temporary Variable 2



All the values for the Temporary Variables are set to "0" when the execution of the script is started.

■ Comment

A note defined in the script is called a comment. The line with "//" defined at the beginning of a line will become a comment. "//" is defined with a single-byte. Double-byte characters can be used after "//".

Definition of comment

```
// Arbitrary note
```

Sample definition

```
// Store the initial value to calculation
data [LDR 100] for process A
[LDR 100] = 1234;
:
:
```

← This line is not executed.



- It will be useful to use comments to explain the contents of the script (especially when the editor of the script has changed or some time has passed since editing).
- Comments are ignored (not executed) when the script is executed, so they can be defined freely without worrying about the execution time.

5 Script Coding Examples

HG2J-7U HG5G-V HG4G-V HG4G HG3G-V HG3G HG2G-V HG2G-5F HG2G-5T HG1G HG1P

This section provides script coding examples for control statements, arithmetic operators, and functions, as well as the descriptions of their operations.

5.1 Control Statements

■ Example 5.1.1 Conditional branch

Script

```
if ([LDR 100])
{
    [LDR 200] = 100;
}
```

Operation description

If the value of LDR100 is not 0, then 100 is stored in LDR200.

■ Example 5.1.2 Conditional branching

Script

```
if ([LM 100])
{
    [LDR 200] = [LDR 300] + [LDR 400] + [LDR 500];
}
```

Operation description

If the value of LM100 is not 0, then LDR300, LDR400, and LDR500 are added and that value is stored in LDR200.

■ Example 5.1.3 Conditional branching

Script

```
if (0 != [LDR 100])
{
    if (0 != [LDR 200])
    {
        [LDR 300] = 0x1234;
    }
}
```

Operation description

If the value of LDR100 is not 0 and the value of LDR200 is also not 0, then 0x1234 is stored in LDR300.

If the value of LDR100 is not 0 and the value of LDR200 is 0, then nothing is executed.

If the value of LDR100 is 0, then nothing is executed regardless of the value of LDR200.

■ Example 5.1.4 Conditional branching

Script

```
if ((0 != [LDR 100]) || (0 != [LDR 200]))
{
    [LDR 300] = 100;
}
else
{
    [LDR 400] = [LDR 500] + 100;
}
```

Operation description

If either the value of LDR100 or the value of LDR200 is not 0, then 100 is stored in LDR300.

If the value of both LDR100 and LDR200 is 0, 100 is added to LDR500 and that value is stored in LDR400.

■ Example 5.1.5 Conditional branching

Script

```
if ([LDR 100] == 0)
{
    [LDR 200] = 0x1234;
}
else if ([LDR 100] == 1)
{
    [LDR 200] = 0x5678;
}
else
{
    [LDR 200] = 0x9999;
}
```

Operation description

If the value of LDR100 is 0, then 0x1234 is stored in LDR200.

If the value of LDR100 is 1, then 0x5678 is stored in LDR200.

If the value of LDR100 is not 0 or 1, then 0x9999 is stored in LDR200.

■ Example 5.1.6 Conditional branching

Script

```
if ([LDR 100])
{
    if ([LDR 200])
    {
        if ([LDR300])
        {
            [LDR 400] = 100;
        }
        else
        {
            [LDR 400] = 200;
        }
    }
}
```

Operation description

If the values of LDR100, LDR200, and LDR300 are all not 0, then 100 is stored in LDR400.

If the values of LDR100 and LDR200 are not 0 and the value of LDR300 is 0, then 200 is stored in LDR400.

If either the value of LDR100 or LDR200 is 0, then nothing is executed regardless of the value of LDR300.

■ Example 5.1.7 Iteration**Script**

```
[LDR 100] = 10;  
[LDR 200] = 10;  
  
while (0 < [LDR 100])  
{  
    [LDR 200] = [LDR 200] + 1;  
    [LDR 100] = [LDR 100] - 1;  
}
```

Operation description

If the value of LDR100 is larger than 0, then 1 is repeatedly added to the value of LDR200 and 1 is repeatedly subtracted from the value of LDR100.

In the script example above, when the while statement repeats ten times, the value of LDR100 becomes 0 and the while statement ends.

After this script executes, the value of LDR100 is 0 and the value of LDR200 is 20.

■ Example 5.1.8 Iteration**Script**

```
[LDR 100] = 0;  
[LDR 200] = 3;  
[LDR 300] = 5;  
  
while ([LDR 100] == 0)  
{  
    [LDR 200] = [LDR 200] + 1;  
  
    if ([LDR 300] = [LDR 200])  
    {  
        SET([LM 0]);  
        break;  
    }  
}
```

Operation description

While the value of LDR100 is 0, the while statement repeats.

Inside the while statement, if the values of LDR200 and LDR300 are equal, the while statement will terminate, and after [LM 0] changes to 1, execution breaks out of the while statement.

In the script example above, the values of LDR200 and LDR300 are equal when the while statement repeats twice, and after LMO changes to 1, execution breaks out of the while statement loop. After execution, the value of LDR100 is 0, the value of LDR200 is 5, the value of LDR300 is 5, and LMO is 1.

■ Example 5.1.9 Indirect write and indirect read using iteration (while statement)

Script

```
// Transfer LDR10 through LDR19 to LDR100 through LDR109

// Initialize the indirect value
[LDR 0] = 0;

// Loop ten times
while ([LDR 0] < 10)
{
    // Transfer 1 word by indirect assignment
    OFFSET([LDR 100], [LDR 0]) = OFFSET([LDR 10], [LDR 0]);
    // Increment indirect value
    [LDR 0] = [LDR 0] + 1
}
```

This script stores the values of LDR10 through LDR19 in LDR100 through LDR109.

It operates as follows.

First, the indirect value LDR0 is initialized and set to 0.

First iteration (loop): The value of LDR0 is 0, so the condition "[LDR 0] < 10" is true and the statements inside while are executed.

- The value of LDR10, 0 words from LDR10, is stored in LDR100, 0 words from LDR100.
- 1 is added to the value of the indirect value LDR0 so that it becomes 1.

Second iteration (loop): The value of LDR0 is 1, so the condition "[LDR 0] < 10" is true and the statements inside while are executed.

- The value of LDR11, 1 word from LDR10, is stored in LDR101, 1 word from LDR100.
- 1 is added to the value of the indirect value LDR0 so that it becomes 2.

:

(Repeats in this manner for the third to ninth iterations)

:

Tenth iteration (loop): The value of LDR0 is 9, so the condition "[LDR 0] < 10" is true and the statements inside while are executed.

- The value of LDR19, 9 words from LDR10, is stored in LDR109, 9 words from LDR100.
- 1 is added to the value of the indirect value LDR0 so that it becomes 10.

The value of LDR0 is 10, so the condition "[LDR 0] < 10" is false and execution breaks out of the while loop.

After execution, the values of LDR100 through LDR109 are the values of LDR10 through LDR19.

■ Example 5.1.10 Decimal to octal conversion using a while statement**Script**

```
// Convert a decimal value to octal
// - For example, convert 10 (Dec) to 12 (Oct), 16 (Dec) to 20 (Oct)
// - Convert a value to octal up to 4 digits max

@1 = 0;           // while counter
@2 = [LDR 100];  // gets original data
@3 = 1;          // decimal base
@4 = 0;          // calculation results

// repeat four times
while (@1 < 4)
{
    // Extract 1st octal digit from original data. Store working result in @10.
    @10 = @2 % 8;
    // Convert the extracted results to decimal and add to results
    @4 = @4 + (@10 * @3);

    // Increase the decimal base by one digit
    @3 = @3 * 10;
    // Reduce the original data by one digit
    @2 = @2 / 8;
    // If @2 is 0, terminate the while statement
    if (0 == @2)
    {
        break;
    }

    // Increment while counter by 1
    @1 = @1 + 1;
}

// Store the calculation result in LDR200
[LDR 200] = @4;
```

Operation description

This example converts a decimal value to octal using a while statement.

By repeating the process to divide the original decimal data by 8 and converting each digit to octal in a while statement, the conversion is implemented up to four digits.

The unconverted decimal value is stored in LDR100. After the script is executed, the converted octal value is stored in LDR200.

■ Example 5.1.11 Conditional branching with switch

Script

```
switch ([LDR 100])
{
    case 10:
        [LDR 200] = 0x1234;
        break;
    case 999:
        [LDR 200] = 0x5678;
        SET([LM 10]);
        break;
}
```

Operation description

If the value of LDR100 is 10, then 0x1234 is stored in LDR200.

If the value of LDR100 is 999, then 0x5678 is stored in LDR200 and LM10 turns on.

If the value of LDR100 is not 10 or 999, then nothing is executed.

■ Example 5.1.12 Conditional branching with switch using the default statement

Script

```
switch ([LDR 100])
{
    case 0:
        [LDR 200] = 0x1234;
        break;
    case 1:
        [LDR 200] = 0x5678;
        break;
    default:
        [LDR 200] = 0x9999;
        break;
}
```

Operation description

If the value of LDR100 is 0, then 0x1234 is stored in LDR200.

If the value of LDR100 is 1, then 0x5678 is stored in LDR200.

If the value of LDR100 is not 0 or 1, then 0x9999 is stored in LDR200.

■ Example 5.1.13 Terminate the script with the return statement

Script

```
if (0x1234 == [LDR 100])
{
    [LDR 200] = 0x5678;
    return;
}
[LDR 300] = 0;
```

Operation description

If the value of LDR100 is not 0x1234, then 0 is stored in LDR300.

If the value of LDR100 is 0x1234, then 0x5678 is stored in LDR200 and the script terminates.

The return statement does not break out of a function like the break statement, it terminates the script and executes the next part or script.

■ Example 5.1.14 Break out of a loop with the break statement**Script**

```
[LDR 100] = 0;
[LDR 200] = 3;
[LDR 300] = 5;

while ([LDR 100] == 0)
{
    [LDR 200] = [LDR 200] + 1;

    if ([LDR 200] == [LDR 300])
    {
        SET([LM 0]);
        break;
    }
}
```

Operation description

While the value of LDR100 is 0, the while statement repeats until LDR200 and LDR300 are equal.

Inside the while statement, if the values of LDR200 and LDR300 are equal, the while statement will end and execution breaks out of the while statement.

In the script example above, the values of LDR200 and LDR300 are equal when the while statement repeats twice, and after LM0 changes to 1, the while statement ends. After execution, the value of LDR100 is 0, the value of LDR200 is 5, the value of LDR300 is 5, and the value of LM0 is 1.

5.2 Relational Operators

■ Example 5.2.1 Equal to**Script**

```
if ([LDR 100] == [LDR 200])
{
    [LDR 300] = 0x100;
}
```

Operation description

If the value of LDR100 is equal to the value of LDR200, then 0x100 is stored in LDR300.

■ Example 5.2.2 Not equal to**Script**

```
if ([LDR 100] != [LDR 200])
{
    [LDR 300] = 0x100;
}
```

Operation description

If the value of LDR100 is not equal to the value of LDR200, then 0x100 is stored in LDR300.

■ Example 5.2.3 Less than**Script**

```
if ([LDR 100] < [LDR 200])
{
    [LDR 300] = 0x100;
}
```

Operation description

If the value of LDR100 is less than the value of LDR200, then 0x100 is stored in LDR300.

■ Example 5.2.4 Less than or equal to**Script**

```
if ([LDR 100] <= [LDR 200])
{
    [LDR 300] = 0x100;
}
```

Operation description

If the value of LDR100 is less than or equal to the value of LDR200, then 0x100 is stored in LDR300.

■ Example 5.2.5 Greater than**Script**

```
if ([LDR 100] > [LDR 200])
{
    [LDR 300] = 0x100;
}
```

Operation description

If the value of LDR100 is greater than the value of LDR200, then 0x100 is stored in LDR300.

■ Example 5.2.6 Greater than or equal to**Script**

```
if ([LDR 100] > [LDR 200])
{
    [LDR 300] = 0x100;
}
```

Operation description

If the value of LDR100 is greater than or equal to the value of LDR200, then 0x100 is stored in LDR300.

5.3 Logical Operators

■ Example 5.3.1 Logical AND

Script

```
if (([LDR 100] == [LDR 200]) && ([LDR 300] == [LDR 400] + [LDR 500]))
{
    [LDR 600] = 100;
}
```

Operation description

If the value of LDR100 is equal to the value of LDR200, and if the value of LDR300 is equal to the value of LDR400 and LDR500 added together, then 100 is stored in LDR600.

If either `([LDR 100] == [LDR 200])` or `([LDR 300] == [LDR 400] + [LDR 500])` is false, the processing in the brackets “{ }” is not executed.

■ Example 5.3.2 Logical OR

Script

```
if ((0 != [LDR 100]) || (0 != [LDR 200]))
{
    [LDR 300] = 100;
}
```

Operation description

If the value of LDR100 is not 0 or the value of LDR200 is not 0, then 100 is stored in LDR300.

If either is true, the processing in the brackets “{ }” is executed.

■ Example 5.3.3 Logical inversion

Script

```
if (!( [LDR 100] == 0x1234))
{
    [LDR 300] = 100;
}
```

Operation description

If the value of LDR100 is not equal to 0x1234, then 100 is stored in LDR300.

■ Example 5.3.4 Logical inversion

Script

```
if (!(0 != [LDR 100]))
{
    [LDR 300] = 100 ;
}
```

Operation description

If the value of LDR100 is 0, then 100 is stored in LDR300.

This is the same as the code “if (0==[LDR 100])”.

5.4 Arithmetic Operators

■ Example 5.4.1 Addition

Script

```
[LDR 300] = [LDR 100] + [LDR 200];
```

Operation description

The values of LDR100 and LDR200 are added together and the result is stored in LDR300.

■ Example 5.4.2 Subtraction

Script

```
[LDR 300] = [LDR 100] - [LDR 200];
```

Operation description

The value of LDR200 is subtracted from the value of LDR100 and the result is stored in LDR300.

■ Example 5.4.3 Multiplication

Script

```
[LDR 300] = [LDR 100] * [LDR 200];
```

Operation description

The values of LDR100 and LDR200 are multiplied together and the result is stored in LDR300.

■ Example 5.4.4 Division

Script

```
[LDR 300] = [LDR 100] / [LDR 200];
```

Operation description

The value of LDR100 is divided into the value of LDR200 and the result is stored in LDR300.

■ Example 5.4.5 Modulo

Script

```
[LDR 300] = [LDR 100] % [LDR 200];
```

Operation description

The value of LDR100 is divided into the value of LDR200 and the remainder is stored in LDR300.

5.5 Bitwise Operators

■ Example 5.5.1 Logical AND

Script

```
if ([LM 100] & [LM 101])
{
    SET([LM 200]);
}
else
{
    RST([LM 200]);
}
```

Operation description

If the bitwise logical AND operation on the values of LM100 and LM101 is 1, LM200 changes to 1.
If the bitwise logical AND operation on the values of LM100 and LM101 is 0, LM200 changes to 0.
The operation is the same as the following ladder diagram.

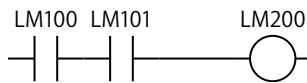

■ Example 5.5.2 Logical OR

Script

```
if ([LM 100] | [LM 101])
{
    SET([LM 200]);
}
else
{
    RST([LM 200]);
}
```

Operation description

If the bitwise logical OR operation on the values of LM100 and LM101 is 1, LM200 changes to 1.
If the bitwise logical OR operation on the values of LM100 and LM101 is 0, LM200 changes to 0.
The operation is the same as the following ladder diagram.

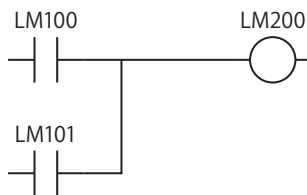

■ Example 5.5.3 Logical XOR (exclusive OR)

Script

```
[LDR 200] = [LDR 100] ^ 0xFF;
```

Operation description

The logical XOR operation on the value of LDR100 and each bit in 0xFF is stored in LDR200.
For example, if the value of LDR100 is 15 (0x0F), then LDR200 is 240 (0xF0).

■ Example 5.5.4 Inversion

Script

```
[LDR 200] = ~[LDR 100];
```

Operation description

The bits in the value of LDR100 are flipped and stored in LDR200.
For example, if the value of LDR100 is 0, then LDR200 is 65535.

■ Example 5.5.5 Inversion

Script

```
if (([LM 100] & ~ [LM 101]) | [LM 102])
{
    SET([LM 200]);
}
else
{
    RST([LM 200]);
}
```

Operation description

If the bitwise logical OR operation on the value of LM102 and the result of the bitwise logical AND operation on the value of LM100 and the inverted result of the value of LM101 is 1, then LM200 changes to 1.

If the bitwise logical OR operation on the value of LM102 and the result of the bitwise logical AND operation on the value of LM100 and the inverted result of the value of LM101 is 0, then LM200 changes to 0.

The operation is the same as the following ladder diagram.

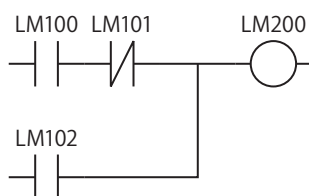

■ Example 5.5.6 Left shift

Script

```
[LDR 300] = [LDR 100] << [LDR 200];
```

Operation description

The value of LDR100 is shifted left by only the amount of the value of LDR200 and the result is stored in LDR300.

For example, if the value of LDR100 is 1 and the value of LDR200 is 3, 1 is shifted 3 bits to the left and the result 8 is stored in LDR300.

■ Example 5.5.7 Right shift

Script

```
[LDR 300] = [LDR 100] >> [LDR 200];
```

Operation description

The value of LDR100 is shifted right by only the amount of the value of LDR200 and the result is stored in LDR300.

For example, if the value of LDR100 is 8 and the value of LDR200 is 3, 8 is shifted 3 bits to the right and the result 1 is stored in LDR300.

5.6 Bit Functions

■ Example 5.6.1 Set a bit

Script

```
SET([LM 100]);
```

Operation description

Turns LM100 to 1. The result is the same as $[LM\ 100] = 1$.

■ Example 5.6.2 Reset a bit

Script

```
RST([LM 100]);
```

Operation description

Turns LM100 to 0. The result is the same as $[LM\ 100] = 0$.

■ Example 5.6.3 Invert a bit

Script

```
REV([LM 100]);
```

Operation description

Flips LM100 1 and 0. The result is the same as $[LM\ 100] = \sim[LM\ 100]$.

5.7 Word Functions

● Arithmetic operations

■ Example 5.7.1 Maximum value

Script

```
[LDR 200] = MAX([LDR 100], [LDR 110], [LDR 120], [LDR 130], [LDR 140]);
```

Operation description

Out of the values stored in LDR100, LDR110, LDR120, LDR130, and LDR140, stores the maximum value in LDR200. Up to 15 arguments can be used.

■ Example 5.7.2 Minimum value

Script

```
[LDR 200] = MIN([LDR 100], [LDR 110], [LDR 120], [LDR 130], [LDR 140]);
```

Operation description

Out of the values stored in LDR100, LDR110, LDR120, LDR130, and LDR140, stores the minimum value in LDR200. Up to 15 arguments can be used.

■ Example 5.7.3 Exponential function

Script

```
[D 10] = EXP([D 20]);
```

Operation description

Calculates the exponential function of the value of D20 and the result is stored in D10. Only the data type Float32(F) can be used.

■ Example 5.7.4 Natural logarithm

Script

```
[D 10] = LOGE([D 20]);
```

Operation description

Calculates the natural logarithm of the value of D20 and the result is stored in D10. Only the data type Float32(F) can be used.

■ Example 5.7.5 Common logarithm

Script

```
[D 10] = LOG10([D 20]);
```

Operation description

Calculates the logarithm of the value of D20 with 10 as the base and the result is stored in D10. Only the data type Float32(F) can be used.

■ Example 5.7.6 Power

Script

```
[D 10] = POW([D 20], [D 30]);
```

Operation description

Calculates the power of a value.

For example, when the value of D20 is 10 and the value of D30 is 5, the function calculates 10 to the power of 5 and stores the result in D10.

Only the data type Float32(F) can be used.

■ Example 5.7.7 Square root**Script**

```
[D 10] = ROOT([D 20]);
```

Operation description

Calculates the square root of the value of [D 20] and the result is stored in [D 10]. Only the data type Float32(F) can be used.

■ Example 5.7.8 Sine**Script**

```
[D 10] = SIN([D 20]);
```

Operation description

Calculates the sine of the radian value of D20 and stores the result in D10. Only the data type Float32(F) can be used.

■ Example 5.7.9 Cosine**Script**

```
[D 10] = COS([D 20]);
```

Operation description

Calculates the cosine of the radian value of D20 and stores the result in D10. Only the data type Float32(F) can be used.

■ Example 5.7.10 Tangent**Script**

```
[D 10] = TAN([D 20]);
```

Operation description

Calculates the tangent of the radian value of D20 and stores the result in D10. Only the data type Float32(F) can be used.

■ Example 5.7.11 Arcsine**Script**

```
[D 10] = ASIN([D 20]);
```

Operation description

Calculates the arcsine of the value of D20 and stores the result as radians in D10. Only the data type Float32(F) can be used.

■ Example 5.7.12 Arccosine**Script**

```
[D 10] = ACOS([D 20]);
```

Operation description

Calculates the arccosine of the value of D20 and stores the result as radians in D10. Only the data type Float32(F) can be used.

■ Example 5.7.13 Arctangent**Script**

```
[D 10] = ATAN([D 20]);
```

Operation description

Calculates the arctangent of the value of D20 and stores the result as radians in D10.
Only the data type Float32(F) can be used.

■ Example 5.7.14 Convert angle to radians**Script**

```
[D 10] = RAD([D 20]);
```

Operation description

Converts the value of D20 from degrees (°) to radians and stores the result in D10.
Only the data type Float32(F) can be used.

■ Example 5.7.15 Convert radians to angle**Script**

```
[D 10] = DEG([D 20]);
```

Operation description

Converts the value of D20 from radians to degrees (°) and stores the result in D10.
Only the data type Float32(F) can be used.

- Data type conversions

- **Example 5.7.16** Convert BCD to binary

Script

```
[LDR 200] = BCD2BIN([LDR 100]);
```

Operation description

Converts the BCD value in LDR100 to a binary value and stores it in LDR200.

For example, if the BCD value 10 (16 as a binary value) is stored in LDR100, 10 (binary value) is stored in LDR200.

- **Example 5.7.17** Convert binary to BCD

Script

```
[LDR 200] = BIN2BCD([LDR 100]);
```

Operation description

Converts the binary value in LDR100 to a BCD value and stores it in LDR200.

For example, if the binary value 16 (10 as a BCD value) is stored in LDR100, 16 (BCD value) is stored in LDR200.

- **Example 5.7.18** Convert floating point to binary

Script

```
[LDR 200] = FLOAT2BIN([LDR 100]);
```

Operation description

Converts the floating point value in LDR100 to a binary value and stores it in LDR200.

For example, if the floating point value 1234 (0x449A4000 as a binary value) is stored in LDR100, 1234 (binary value) is stored in LDR200. If the floating point value 1234.56 (0x449A51EC as a binary value) is stored in LDR100, the value after the decimal point is discarded and 1234 (binary value) is stored in LDR200.

- **Example 5.7.19** Convert binary to floating point

Script

```
[LDR 200] = BIN2FLOAT([LDR 100]);
```

Operation description

Converts the binary value in LDR100 to a floating point value and stores it in LDR200.

For example, if the binary value 1234 is stored in LDR100, the floating point value 1234 (0x449A4000 as a binary value) is stored in LDR200.

■ Example 5.7.20 Convert decimal to string

Script

```
DEC2ASCII([LDR 100], [LDR 200]);
```

Operation description

Converts the decimal numeric value in LDR200 to a string and stores it in order with LDR100 as the starting address number.



- This function can only be configured when **UBIN16(W)**, **BIN16(I)**, **UBIN32(D)**, **BIN32(L)**, **BCD4(B)** or **BCD8(EB)** is specified as the **Data Type**.
- You can only specify an internal device.
- When using functions that handle strings, check the **Storage Method of string data** setting on the **System** tab in the **Project Settings** dialog box. Depending on the setting, the upper and lower bytes are stored in the reverse of the following explanation. For details, refer to Chapter 4 "3.1 System Tab" on page 4-25.
- A NULL terminating character (0x00) is added to the end of the string.

Converting 1234 (when the data type is UBIN16(W))

Device address	Stored value	Stored value	
		Upper byte	Lower byte
LDR200	1234	'1' = 0x31	'2' = 0x32
LDR100		'3' = 0x33	'4' = 0x34
LDR101		0x00	0x00
LDR102			

Terminating character

Converting -12345 (when the data type is BIN16(I))

Device address	Stored value	Stored value	
		Upper byte	Lower byte
LDR200	-12345	'-' = 0x2D	'1' = 0x31
LDR100		'2' = 0x32	'3' = 0x33
LDR101		'4' = 0x34	'5' = 0x35
LDR102		0x00	0x00
LDR103			

Terminating character

Converting 1234567890 (when the data type is UBIN32(D))

Device address	Stored value	Stored value	
		Upper byte	Lower byte
LDR200	1234567890	'1' = 0x31	'2' = 0x32
LDR201			
LDR100		'3' = 0x33	'4' = 0x34
LDR101		'5' = 0x35	'6' = 0x36
LDR102		'7' = 0x37	'8' = 0x38
LDR103		'9' = 0x39	'0' = 0x30
LDR104		0x00	0x00
LDR105			

Terminating character

Converting -1234567890 (when the data type is BIN32(L))

Device address	Stored value	Stored value	
		Upper byte	Lower byte
LDR200	-1234567890	'-' = 0x2D	'1' = 0x31
LDR201			
LDR100		'2' = 0x32	'3' = 0x33
LDR101		'4' = 0x34	'5' = 0x35
LDR102		'6' = 0x36	'7' = 0x37
LDR103		'8' = 0x38	'9' = 0x39
LDR104		'0' = 0x30	0x00
LDR105			

Terminating character

■ Example 5.7.21 Convert string to decimal

Script

```
[LDR 100] = ASCII2DEC([LDR 200]);
```

Operation description

Converts the stored string starting at LDR200 to a decimal and stores the result in LDR100.

The number of digits that can be converted is the maximum number of digits for each data type with added sign.

If the string to convert contains NULL or characters that cannot be converted to numeric values, the string is converted up to that character.



- This function can only be configured when **UBIN16(W)**, **BIN16(I)**, **UBIN32(D)**, **BIN32(L)**, **BCD4(B)** or **BCD8(EB)** is specified as the **Data Type**.
- You can only specify an internal device.
- When using functions that handle strings, check the **Storage Method of string data** setting on the **System** tab in the **Project Settings** dialog box. Depending on the setting, the upper and lower bytes are stored in the reverse of the following explanation. For details, refer to Chapter 4 "3.1 System Tab" on page 4-25.

Setting the string "1234" (when the data type is UBIN16(W))

Device address	Stored value	
	Upper byte	Lower byte
LDR200	'1' = 0x31	'2' = 0x32
LDR201	'3' = 0x33	'4' = 0x34
LDR202	0x00	0x00

Terminating character

⇒

Device address	Stored value
LDR100	1234

Setting the string "1234567" (when the data type is UBIN16(W))

Device address	Stored value	
	Upper byte	Lower byte
LDR200	'1' = 0x31	'2' = 0x32
LDR201	'3' = 0x33	'4' = 0x34
LDR202	'5' = 0x35	'6' = 0x36
LDR203	'7' = 0x37	0x00

Terminating character

⇒

Device address	Stored value
LDR100	12345

Setting the string "-12345" (when the data type is BIN16(I))

Device address	Stored value	
	Upper byte	Lower byte
LDR200	'1' = 0x2D	'1' = 0x31
LDR201	'2' = 0x32	'3' = 0x33
LDR202	'4' = 0x34	'5' = 0x35
LDR203	0x00	0x00

Terminating character

⇒

Device address	Stored value
LDR100	-12345

String "1234567890" (when the data type is UBIN32(D))

Device address	Stored value	
	Upper byte	Lower byte
LDR200	'1' = 0x31	'2' = 0x32
LDR201	'3' = 0x33	'4' = 0x34
LDR202	'5' = 0x35	'6' = 0x36
LDR203	'7' = 0x37	'8' = 0x38
LDR204	'9' = 0x39	'0' = 0x30
LDR205	0x00	0x00

Terminating character

⇒

Device address	Stored value
LDR100 - 101	1234567890

● Data comparison and copying

■ Example 5.7.22 Word-unit data comparison

Script

```
[LDR 0] = MEMCMP([LDR 100], [LDR 200], 10);
```

Operation description

Compares the value of 10 words from LDR100 (up to LDR109) with the value of 10 words from LDR200 (up to LDR209).

If the value for each is entirely equal, 1 is stored in LDR0. If even a single one is not equal, 0 is stored.

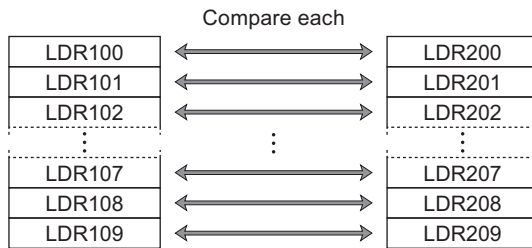

Even if the **Data Type** is set to **UBIN32(D)**, **BIN32(L)**, **BCD8(EB)**, or **Float32(F)**, the comparison is performed from the start device address in word units.

■ Example 5.7.23 Bit-unit data comparison

Script

```
[LDR 0] = MEMCMP([LDR 100-2], [LM 0], 10);
```

Operation description

Compares the third bit of LDR100 through the third bit of LDR109 with the state of the bits from LM0 to LM9.

If the value for each is entirely equal, 1 is stored in LDR0. If even a single one is not equal, 0 is stored.

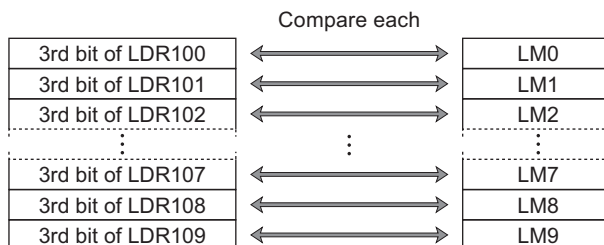

Even if the **Data Type** is set to **UBIN32(D)**, **BIN32(L)**, **BCD8(EB)**, or **Float32(F)**, the comparison is performed from the start device address in bit units.

■ Example 5.7.24 Word-unit data copy

Script

```
MEMCPY([LDR 100], [LDR 200], 10);
```

Operation description

Copies the value of 10 word device addresses from LDR200 (up to LDR209) to 10 word device addresses from LDR100 (up to LDR109).

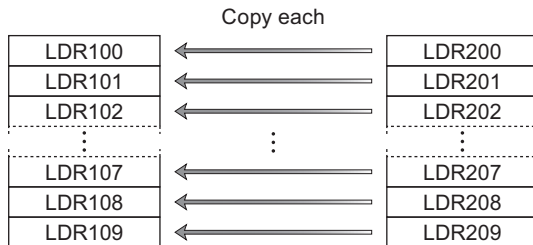

Even if the **Data Type** is set to **UBIN32(D)**, **BIN32(L)**, **BCD8(EB)**, or **Float32(F)**, the data is copied from the start device address in word units.

■ Example 5.7.25 Bit-unit data copy

Script

```
MEMCPY([LM 0], [LDR 100-2], 10);
```

Operation description

Copies the third bit of 10 words from LDR100 (up to LDR109) to the bit state for 10 of device addresses from LM0 (up to LM9).

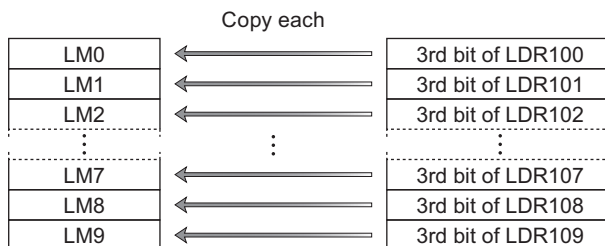

Even if the **Data Type** is set to **UBIN32(D)**, **BIN32(L)**, **BCD8(EB)**, or **Float32(F)**, the bits are copied from the start device address in bit units.

● String operations

When using functions that handle string data, check the **Storage Method of string data** setting in the project settings.

For details, refer to Chapter 4 "3.1 System Tab" on page 4-25.

■ Example 5.7.26 Copy a string

Script

```
STRCUT([LDR 100], [LDR 200], 2, 3);
```

Operation description

Stores in order from LDR100 character count 3 (3 characters worth) from start position 2 (starting from 0, so the 3rd character) of the string "ABCDEFGH" that starts from LDR200.



The start position can be specified in the range from 0 to 127, the character count can be specified in the range from 1 to 128.

Copy from string "ABCDEFGH" at start position 2, character count 3

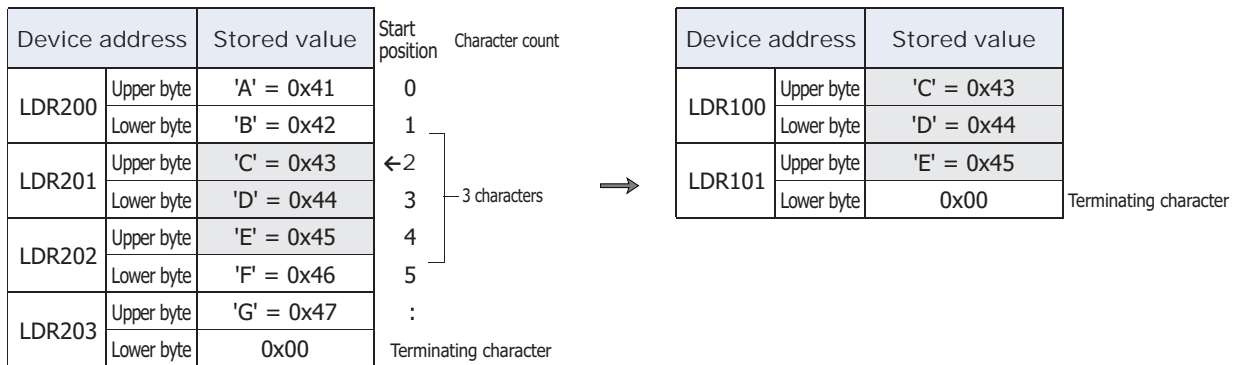

Script

```
STRCUT([LDR 100], [LDR 200], 1, 4);
```

Copy from string "ABCDEFGH" at start position 1, character count 4

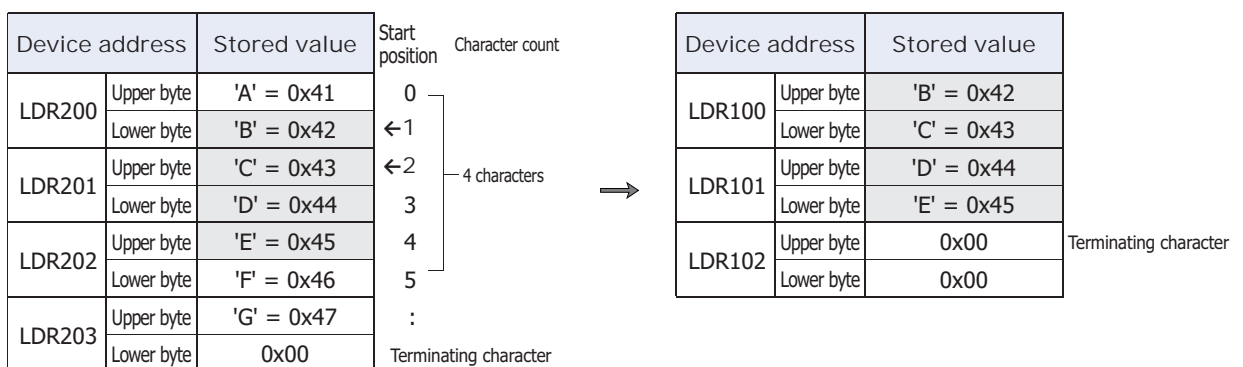

■ Example 5.7.27 Count a string

Script

```
[LDR 100] = STRLEN([LDR 200]);
```

Operation description

Finds the length (character count) of the string starting from LDR200 and stores that in LDR100.



- The only device addresses that can be specified as function arguments in string operations are internal devices.
- The NULL terminating character (0x00) is the end of the string. (The terminating character is not included in the string length.)

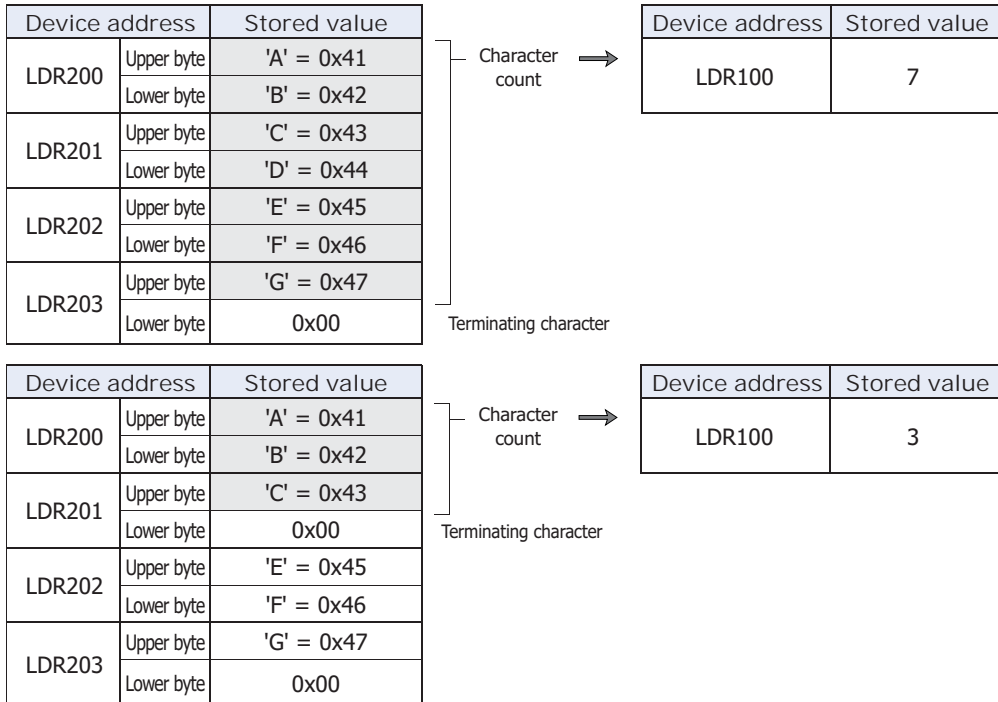

■ Example 5.7.28 Concatenate strings

Script

```
STRCAT([LDR 100], [LDR 200]);
```

Operation description

Concatenates the string starting from LDR200 to the string starting from LDR100.



- The only device addresses that can be specified as function arguments in string operations are internal devices.
- The NULL terminating character (0x00) is the end of the string. (The terminating character is not included in the string length.)

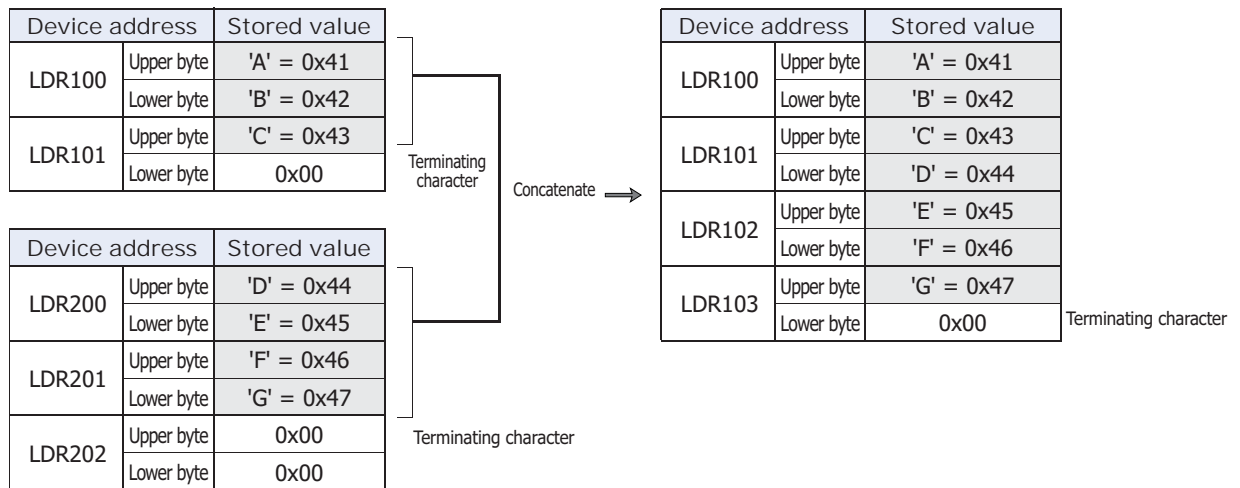

■ Example 5.7.29 Search a string

Script

```
[LDR 0] = STRSTR([LDR 100], [LDR 200]);
```

Operation description

Searches for the search string "DEFG" that starts from LDR200 in the string to be searched "ABCDEFGHIJKLMNO" that starts from LDR100 and stores the position of the occurrence of the string in LDR0. If not found, -1 is stored in LDR0.

If "?" is specified as a character to search for, it is handled as an arbitrary single-byte character.

When specifying "~?" (0x3F) as a character, specify it as "~~?" (0x7E3F) in two bytes.

When specifying "~~" (0x7E) as a character, specify it as "~~" (0x7E7E) in two bytes.



- The maximum number for the search string is 128 characters.
- The only device addresses that can be specified in all arguments are internal devices.

When searching for "DEFG" and the string was found

Search string			String to be searched			Position	Search result	
Device address	Upper byte	Stored value	Device address	Upper byte	Stored value		Device address	Stored value
LDR200	Upper byte	'D' = 0x44	LDR100	Upper byte	'A' = 0x41	0	LDR0	3
	Lower byte	'E' = 0x45		Lower byte	'B' = 0x42	1		
LDR201	Upper byte	'F' = 0x46	LDR101	Upper byte	'C' = 0x43	2		
	Lower byte	'G' = 0x47		Lower byte	'D' = 0x44	3		
LDR202	Upper byte	0x00	LDR102	Upper byte	'E' = 0x45	4		
	Lower byte	0x00		Lower byte	'F' = 0x46	5		
			LDR103	Upper byte	'G' = 0x47	6		
				Lower byte	'H' = 0x48	7		
			LDR104	Upper byte	'I' = 0x49	8		
				Lower byte	'J' = 0x4A	9		
			LDR105	Upper byte	'K' = 0x47	10		
				Lower byte	'L' = 0x4C	11		
			LDR106	Upper byte	'M' = 0x4D	12		
				Lower byte	'N' = 0x4E	13		
			LDR107	Upper byte	'O' = 0x4F	14		
				Lower byte	0x00	Terminating character		

When searching for "WXYZ" and the string was not found

Search string			String to be searched			Position	Search result	
Device address	Upper byte	Stored value	Device address	Upper byte	Stored value		Device address	Stored value
LDR200	Upper byte	'W' = 0x57	LDR100	Upper byte	'A' = 0x41	0	LDR0	-1
	Lower byte	'X' = 0x58		Lower byte	'B' = 0x42	1		
LDR201	Upper byte	'Y' = 0x59	LDR101	Upper byte	'C' = 0x43	2		
	Lower byte	'Z' = 0x5A		Lower byte	'D' = 0x44	3		
LDR202	Upper byte	0x00	LDR102	Upper byte	'E' = 0x45	4		
	Lower byte	0x00		Lower byte	'F' = 0x46	5		
			LDR103	Upper byte	'G' = 0x47	6		
				Lower byte	'H' = 0x48	7		
			LDR104	Upper byte	'I' = 0x49	8		
				Lower byte	'J' = 0x4A	9		
			LDR105	Upper byte	'K' = 0x47	10		
				Lower byte	'L' = 0x4C	11		
			LDR106	Upper byte	'M' = 0x4D	12		
				Lower byte	'N' = 0x4E	13		
			LDR107	Upper byte	'O' = 0x4F	14		
				Lower byte	0x00	Terminating character		

When searching for "?" as an arbitrary single-byte character

Search string			String to be searched				Search result	
Device address		Stored value	Device address	Stored value	Position	Device address	Stored value	
LDR200	Upper byte	'E' = 0x45	LDR100	Upper byte	'A' = 0x41	0	LDR0	4
	Lower byte	'?' = 0x3F		Lower byte	'B' = 0x42	1		
LDR201	Upper byte	'G' = 0x47	LDR101	Upper byte	'C' = 0x43	2		
	Lower byte	'H' = 0x48		Lower byte	'D' = 0x44	3		
LDR202	Upper byte	0x00	LDR102	Upper byte	'E' = 0x45	4		
	Lower byte	0x00		Lower byte	'F' = 0x46	5		
			LDR103	Upper byte	'G' = 0x47	6		
			LDR103	Lower byte	'H' = 0x48	7		
				Upper byte	'I' = 0x49	8		
			LDR104	Lower byte	'J' = 0x4A	9		
				Upper byte	'K' = 0x47	10		
			LDR105	Lower byte	'L' = 0x4C	11		
				Upper byte	'M' = 0x4D	12		
			LDR106	Lower byte	'N' = 0x4E	13		
				Upper byte	'O' = 0x4F	14		
			LDR107	Lower byte	0x00	Terminating character		

Terminating character

When searching for "?" as a character

Search string			String to be searched				Search result	
Device address		Stored value	Device address	Stored value	Position	Device address	Stored value	
LDR200	Upper byte	'E' = 0x45	LDR100	Upper byte	'A' = 0x41	0	LDR0	4
	Lower byte	'~' = 0x7E		Lower byte	'B' = 0x42	1		
LDR201	Upper byte	'?' = 0x3F	LDR101	Upper byte	'C' = 0x43	2		
	Lower byte	'G' = 0x47		Lower byte	'D' = 0x44	3		
LDR202	Upper byte	'H' = 0x48	LDR102	Upper byte	'E' = 0x45	4		
	Lower byte	0x00		Lower byte	'?' = 0x3F	5		
			LDR103	Upper byte	'G' = 0x47	6		
			LDR103	Lower byte	'H' = 0x48	7		
				Upper byte	'I' = 0x49	8		
			LDR104	Lower byte	'J' = 0x4A	9		
				Upper byte	'K' = 0x47	10		
			LDR105	Lower byte	'L' = 0x4C	11		
				Upper byte	'M' = 0x4D	12		
			LDR106	Lower byte	'N' = 0x4E	13		
				Upper byte	'O' = 0x4F	14		
			LDR107	Lower byte	0x00	Terminating character		

Terminating character

When searching for "~" as a character

Search string			String to be searched				Search result	
Device address		Stored value	Device address	Stored value	Position	Device address	Stored value	
LDR200	Upper byte	'E' = 0x45	LDR100	Upper byte	'A' = 0x41	0	LDR0	4
	Lower byte	'~' = 0x7E		Lower byte	'B' = 0x42	1		
LDR201	Upper byte	'~' = 0x7E	LDR101	Upper byte	'C' = 0x43	2		
	Lower byte	'G' = 0x47		Lower byte	'D' = 0x44	3		
LDR202	Upper byte	'H' = 0x48	LDR102	Upper byte	'E' = 0x45	4		
	Lower byte	0x00		Lower byte	'~' = 0x7E	5		
			LDR103	Upper byte	'G' = 0x47	6		
			LDR103	Lower byte	'H' = 0x48	7		
				Upper byte	'I' = 0x49	8		
			LDR104	Lower byte	'J' = 0x4A	9		
				Upper byte	'K' = 0x47	10		
			LDR105	Lower byte	'L' = 0x4C	11		
				Upper byte	'M' = 0x4D	12		
			LDR106	Lower byte	'N' = 0x4E	13		
				Upper byte	'O' = 0x4F	14		
			LDR107	Lower byte	0x00	Terminating character		

Terminating character

● Drawing

■ Example 5.7.30 Draw a line

Script

```
LINE(20, 20, 60, 60, 3, 1, 20);
```

Operation description

Draws a line connecting the start coordinates X=20, Y=20 and the end coordinates X=60, Y=60 on the screen where the script is running. The line has a line width of 3 (3 pixels), line type of 1 (solid line), and line color of 20 (red).

■ Example 5.7.31 Draw a line (omitting arguments)

Script

```
LINE(0, 0, 150, 100);
```

Operation description

Draws a line connecting the start coordinates X=0, Y=0 and the end coordinates X=150, Y=100 on the screen where the script is running. The line width, line type, and line color have been omitted, so the line's line width is 1 (1 pixel), the line type is 1 (solid line), and the line color is 255 (white).

■ Example 5.7.32 Draw a rectangle

Script

```
RECTANGLE(20, 20, 100, 60, 1, 2, 24, 22, 13, 2, 5);
```

Operation description

Draws a rectangle with the start coordinates (the coordinates of the rectangle's upper-left corner) X=20, Y=20 and the end coordinates (the coordinates of the rectangle's lower-right corner) X=100, Y=60 on the screen where the script is running. The rectangle's line width is 1 (1 pixel), line type is 2 (dotted line), foreground color is 24 (green), background color is 22 (yellow), pattern is 13 (tint), rounding type is 2 (curve), and rounding radius is 5 (5 pixels).

■ Example 5.7.33 Draw a rectangle (omitting arguments)

Script

```
RECTANGLE(0, 0, 150, 100);
```

Operation description

Draws a rectangle with the start coordinates (the coordinates of the rectangle's upper-left corner) X=0, Y=0 and the end coordinates (the coordinates of the rectangle's lower-right corner) X=150, Y=100 on the screen where the script is running. The line width, line type, foreground color, background color, pattern, rounding type, and rounding radius are omitted, so the rectangle's line width is 1 (1 pixel), line type is 1 (solid line), foreground color and background color is 255 (white), pattern is 0 (none), rounding type is 0 (none), and rounding radius is 0 (0 pixels).

■ Example 5.7.34 Draw a circle or ellipse

Script

```
CIRCLE(100, 100, 60, 60, 1, 2, 26, 0, 4);
```

Operation description

Draws a circle with the center coordinate X=100, Y=100, the X-axis radius 60 pixels, and the Y-axis radius 60 pixels. The circle's line width is 1 (1 pixel), line type is 2 (dotted line), foreground color is 26 (light blue), background color is 0 (black), and pattern is 4 (foreground 50%).

■ Example 5.7.35 Draw a circle or ellipse (omitting arguments)

Script

```
CIRCLE(100, 100, 80, 40);
```

Operation description

Draws an ellipse with the center coordinate X=100, Y=100, the X-axis radius 80 pixels, and the Y-axis radius 40 pixels. The line width, line type, foreground color, background color, and pattern are omitted, so the ellipse's line width is 1 (1 pixel), line type is 1 (solid line), foreground color and background color is 255 (white), and pattern is 0 (none).

- Indirect assignment

- **Example 5.7.36** Indirect read

Script

```
[LDR 200] = OFFSET([LDR 10],[D 20]);
```

Operation description

When the value of D20 is 8, the value of LDR18, the device address 8 words from LDR10, is read and stored in LDR200.

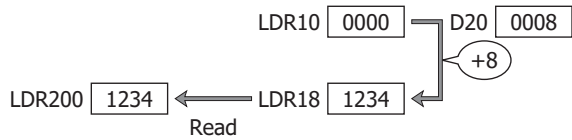

- **Example 5.7.37** Indirect write

Script

```
OFFSET([LDR 10],[D 20]) = 1234;
```

Operation description

When the value of D20 is 3, the constant 1234 is stored in LDR13, the device address 3 words from LDR10.

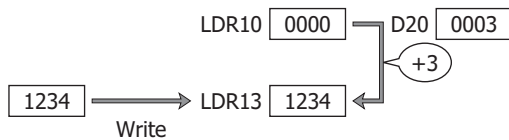

5.8 Data Type Designations

- Example 5.8.1** Specify the **UBIN16(W)** as the **Data Type** on the Script Editor and the **from Lower word** as the **Storage Method of 32-bit Numerical Data for Internal Devices** on the **System** tab in the **Project Settings** dialog box.

Script

```
[LDR 100] = 65535;
[LDR 101] = 0;
[LDR 200] = 0;
[LDR 300] = 0;
asdoubleword
{
    [LDR 100] = [LDR 100]+1;
}
[LDR 200] = [LDR 100];
asdoubleword
{
    [LDR 300] = [LDR 100];
}
```

Operation description

Stores 65535 in LDR100, 0 in LDR101, LDR200 and LDR300.

Data Type	Device Address	Stored value
UBIN16(W)	LDR100	65535
	LDR101	0
	LDR200	0
	LDR300	0

Changes the Data Type to UBIN32(D).

Data Type	Device Address	Storage Method	Stored value	Stored value
UBIN32(D)	LDR100	Lower word	65535	65535
	LDR101	Upper word	0	

+1

Stored value	Stored value
0	65536
1	

The value obtained by adding 1 to the value of the LDR100 is stored in the LDR100 as the "UBIN32(D)".

Returns the Data Type to the default UBIN16(W).

Data Type	Device Address	Stored value
UBIN16(W)	LDR100	0
	LDR101	1
	LDR200	0

Stored value
0
1
0

Stores the value of LDR100 in LDR200.

Changes the Data Type to UBIN32(D).

Data Type	Device Address	Storage Method	Stored value	Stored value
UBIN32(D)	LDR100	Lower word	0	65536
	LDR101	Upper word	1	
	LDR300	Lower word	0	0
	LDR301	Upper word	0	

Stored value	Stored value
0	65536
1	
0	65536
1	

Stores the value of LDR100 in LDR300.



The handling method of 32-bit numerical data follows the data storage method specified in the **Project Settings** dialog box. For details, refer to Chapter 4 "Storage Method of 32-bit Numerical Data for Internal Devices" on page 4-29 and Chapter 4 "Storage Method of 32-bit Numerical Data" on page 4-48.

6 Important Notes

HG2J-7U HG5G-V HG4G-V HG4G HG3G-V HG3G HG2G-V HG2G-5F HG2G-5T HG1G HG1P

This section describes important notes when defining a script.

6.1 Important Notes Regarding the While Definition

- **Define so it will not go into an infinite loop.**

The execution expression is repeatedly executed while the conditional expression is satisfied. However, it will go into an infinite loop when the conditional expression is satisfied continually.

```
[LDR 100] = 10;

while (0 != [LDR 100])
{
    [LDR 200] = [LDR 200] + 1;
}
```

In the conditional expression of the while definition, it states to exit the loop when the value of LDR100 turns 0. However, the value stored in the LDR100 is not changed after storing 10 in the first line of the script, so it will go into an infinite loop.

When using the while definition, define it so it will not go into an infinite loop.

The value of LDR100 will become 0 when the while definition is repeated 10 times in the next example, and it will get out of the while definition.

```
[LDR 100] = 10;

while (0 != [LDR 100])
{
    [LDR 200] = [LDR 200] + 1;
    [LDR 100] = [LDR 100] - 1;
}
```

- **Define it so it will not continue the process for longer than the time limit.**

When the processing of a single script continues for more than the time limit due to a while definition, etc., an execution time over error occurs and that script will be halted. Define the script so the execution time for one script does not exceed 3,000 milliseconds.

For details, refer to "1.4 Script Error" on page 20-4.

- **Do not write into the external device address.**

When it is written into an external device address in the while definition, a script error will occur.

6.2 Important Notes Regarding the Data Type Designations

- **Do not set a Data Type Designations in the braces "{}" for the Data Type Designations.**

The maximum number of the hierarchy for the Data Type Designations is one.

An error occurs when the Data Type Designations is set in the braces "{}" for the Data Type Designations.

6.3 Regarding Communication Error

If the external device address is used for the Global Script or the Script Command that configured to the displayed screens, unless the target device is connected, a communication error will occur even if the Trigger Condition is not satisfied.

6.4 Number of Device Addresses That Can Be Used

The number of external device addresses that can be used in the script are as follows:

Item	Number of devices
Destination external device addresses	64 max.
Source external device addresses	64 max.



- The maximum number of source external device addresses which can be used as a trigger condition and in scripts executed as Global Script is 256.
- When the total number of write data to an external device address exceeds 64 in a single script while executing a script with MICRO/I, that script will be halted with an error.

6.5 About the Priority of the Operator

As a basic rule, operators are calculated in order from left of the line, but when multiple calculations are combined, they are calculated in following priority.

Priority	Operator
	High
	()
	! ~ -(Negative number)
	* / %
	+ -(Subtraction)
	<< >>
	&
	^
	< <= > >=
	== !=
	&&
	Low
=	

Chapter 21 Sound Function

This chapter describes the setup for the sound function and related MICRO/I operations.

1 Function and Settings

HG2J-7U HG5G-V HG4G-V HG4G HG3G-V HG3G HG2G-V HG2G-5F HG2G-5T HG1G HG1P

1.1 Overview - How the Sound Function is Used

The following functions can be used by connecting the HG2J-7U to a USB speaker or the MICRO/I equipped with an audio interface (AUDIO OUT) to a speaker that supports AUDIO OUT.



When using the HG2J-7U, note the following points:

- To use the speaker, USB port must be configured. Select the **USB1(USB-A)** or the **USB2(USB-A)** in the **Interface** under the **Interface Configuration** on the **Communication Interface** tab in the **Project Settings** dialog box, and then select the **Speaker** in the **Function**.
- To play a sound file saved in an external memory device, configure the **Speaker** to the **USB2(USB-A)** in the **Interface** under the **Interface Configuration** on the **Communication Interface** tab in the **Project Settings** dialog box.



Check the IDEC web site for more information about compatible USB speakers.

- Play a sound file when an arbitrary Device Address changes to 1

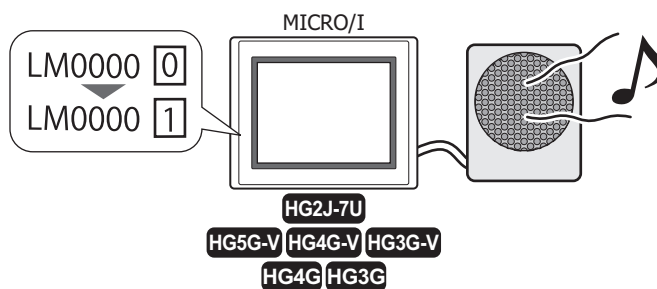

- Play a sound file when the screen is pressed instead of a beep

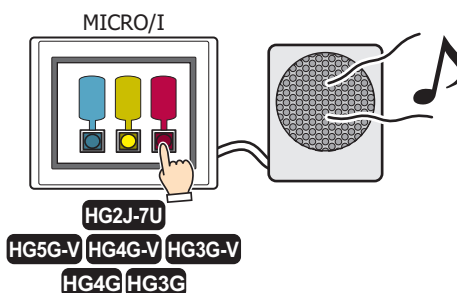

1.2 Supported Sound Files

Sound files that meet the following specifications can be played with MICRO/I:

Item	Description
File format	WAVE file (*.WAV)
Data format	PCM
Sampling rate	8000, 11025, 12000, 16000, 24000, 22050, 32000, 44100, 48000* ¹ Hz
Quantization bit rate	16-bit
Audio type	Mono or stereo
File size	Max. 512 kB

*1 HG2J-7U only

2 Sound Function Configuration Procedure

HG2J-7U HG5G-V HG4G-V HG4G HG3G-V HG3G HG2G-V HG2G-5F HG2G-5T HG1G HG1P

This section describes the configuration procedure for the Sound function.

2.1 Configuring Sound Files & Trigger Conditions

- To play a sound file when a value of device address changes from 0 to 1

- 1 On the **Configuration** tab, in the **System Setup** group, click **Sound**.
The **Sound Settings** dialog box is displayed.

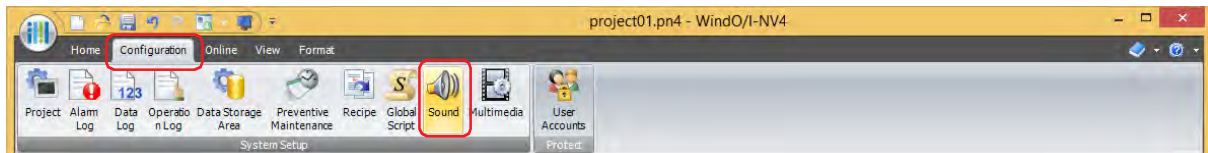

- 2 Double-click the cell in the **File Name** column to register a sound file.
The **Open** dialog box is displayed.

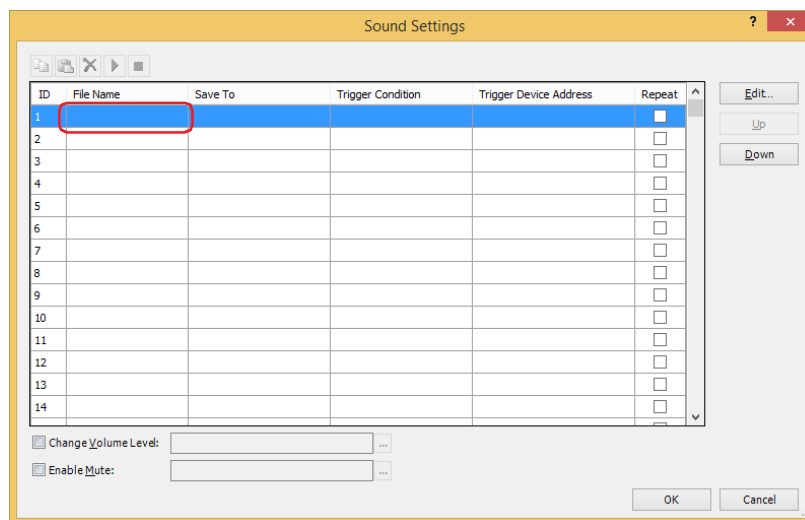

- 3 Specify the sound file to register and click **Open**.



Only sound files with file names that use alphanumeric characters are supported. However, if **Save To** is set to **Internal Memory**, file names with double-byte characters and symbols are also supported.

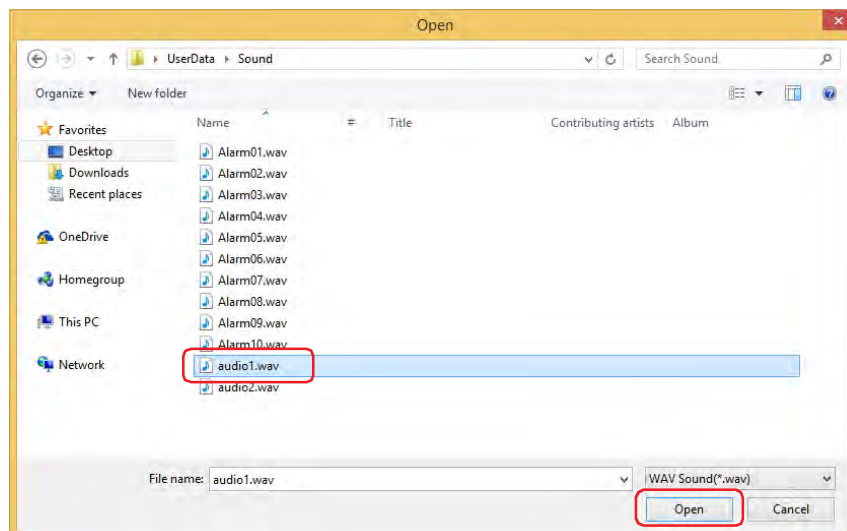

4 Double click the cell under **Save To** and select the save destination for the sound file.

■ **Internal Memory**

Saves the sound file to internal memory.

■ **External Memory Device**

Saves the sound file to external memory device*1 inserted in the MICRO/I.



The procedures to save the sound file to the external memory device are as follows.

- On the **Home** tab, click the arrow under **Download**, and click **Project Data** to display the **Download** dialog box. Select the **Sound Files** check box of **Download following files to External Memory Device**, and click **OK**.
- On the **Home** tab, click the arrow under **Download**, and click **Files to External Memory Device** to display the **Open** dialog box. Specify a sound file and click **Open**.

5 Double click the cell under **Trigger Condition** and select **Device Address**.

6 Specify the device address that will trigger playing the sound file in **Trigger Device Address**.

Double-click the cell or click the cell and then click  in the **Trigger Device Address** column to select a device address from the Tag Editor. For the device address configuration procedure, refer to Chapter 2 "5.1 Device Address Settings" on page 2-70.

7 Configure **Repeat**, **Change Volume Level***2, and any other options, and then click **OK**.

The **Sound Settings** dialog box closes.

This concludes the configuration to play a sound file when a value of device address changes to 1.

- To play a sound file as a touch sound instead of a beep.

1 On the **Configuration** tab, in the **System Setup** group, click **Sound**.

The **Sound Settings** dialog box is displayed.

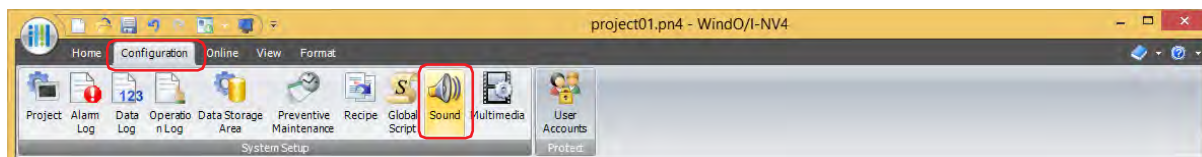

2 Double-click the cell in the **File Name** column to register a sound file.

The **Open** dialog box is displayed.

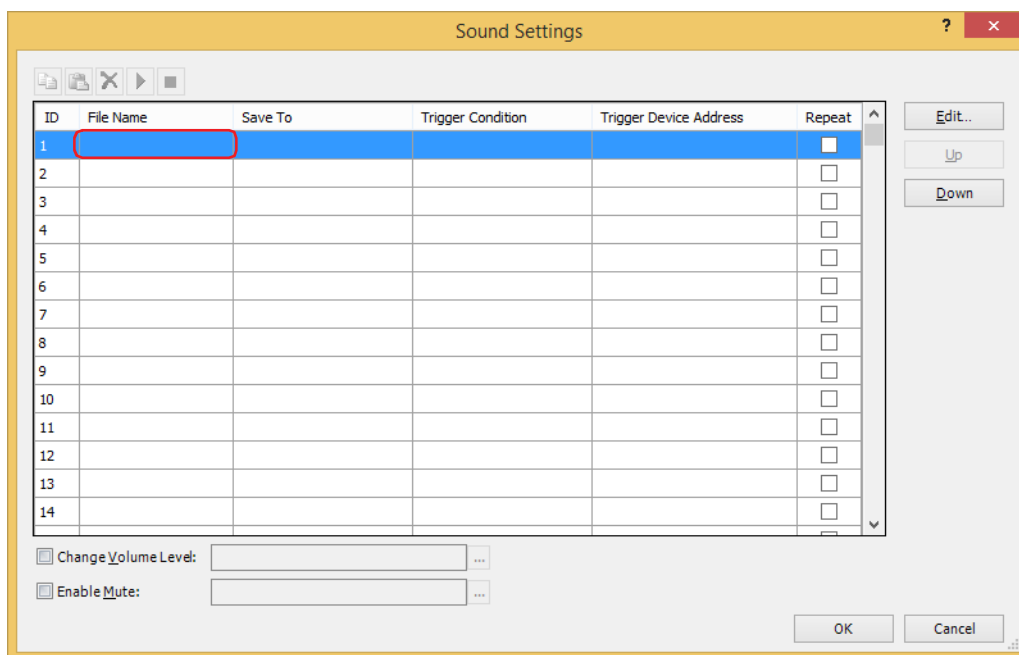

*1 USB flash drive inserted in USB1 for HG2J-7U, SD memory card for HG5G/4G/3G-V and HG4G/3G

*2 HG5G/4G/3G-V, HG4G/3G only

3 Specify the sound file to register and click **Open**.



Only sound files with file names that use alphanumeric characters are supported. However, if **Save To** is set to **Internal Memory**, file names with double-byte characters and symbols are also supported.

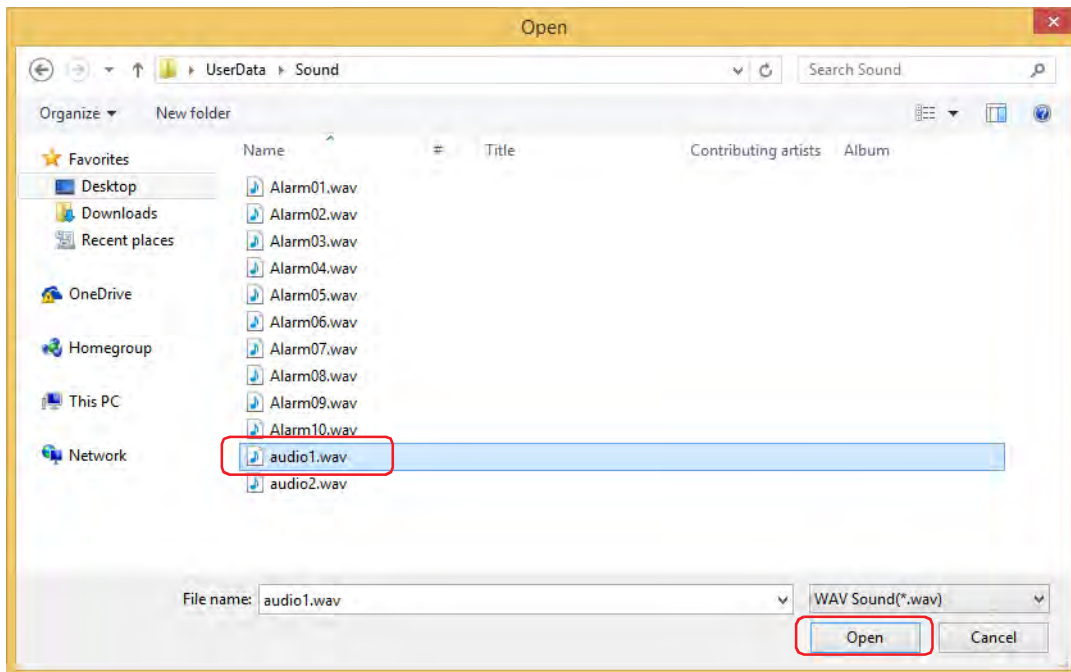

4 Double click the cell under **Save To** and select the save destination for the sound file.

■ **Internal Memory**

Saves the sound file to internal memory.

■ **External Memory Device**

Saves the sound file to external memory device*¹ inserted in the MICRO/I.



The procedures to save the sound file to the external memory device are as follows.

- On the **Home** tab, click the arrow under **Download**, and click **Project Data** to display the **Download** dialog box. Select the **Sound Files** check box of **Download following files to External Memory Device**, and click **OK**.
- On the **Home** tab, click the arrow under **Download**, and click **Files to External Memory Device** to display the **Open** dialog box. Specify a sound file and click **Open**.

5 Double click the cell under **Trigger Condition** and select **None**.

6 Click **OK**.

The **Sound Settings** dialog box closes.

7 On the **Configuration** tab, in the **System Setup** group, click **Project**.

The **Project Settings** dialog box is displayed.

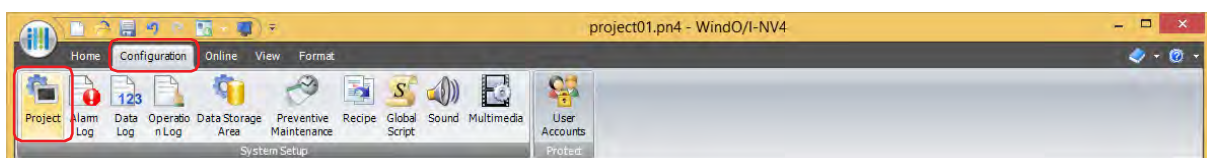

*1 USB flash drive inserted in USB1 for HG2J-7U, SD memory card for HG5G/4G/3G-V and HG4G/3G

- 8 Select the **Enable Touch Sound** check box.
- 9 Select **Sound File** and specify the ID of the sound file to play in **Sound ID**.

Enter a sound ID number or click  to specify the sound ID number with the displayed **Sound Settings** dialog box.

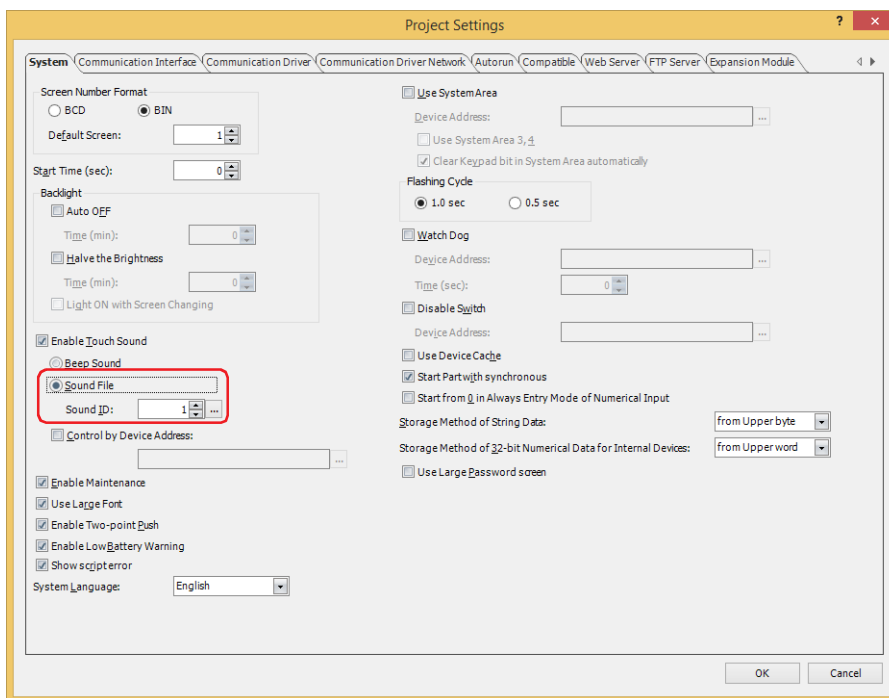

- 10 Click the **OK** button.

The **Sound Settings** dialog box closes.

This concludes the configuration to play a sound file as the touch sound.

3 Sound Settings Dialog Box

HG2J-7U HG5G-V HG4G-V HG4G HG3G-V HG3G HG2G-V HG2G-5F HG2G-5T HG1G HG1P

This section describes items and buttons in the **Sound Settings** dialog box.

3.1 Sound Settings Dialog Box

All the sound files used with the MICRO/I and their trigger conditions are managed in the **Sound Settings** dialog box.



For HMI Special Data Register and HMI Special Internal Relay related to the sound function, refer to Chapter 33 "Internal Devices" on page 33-1.

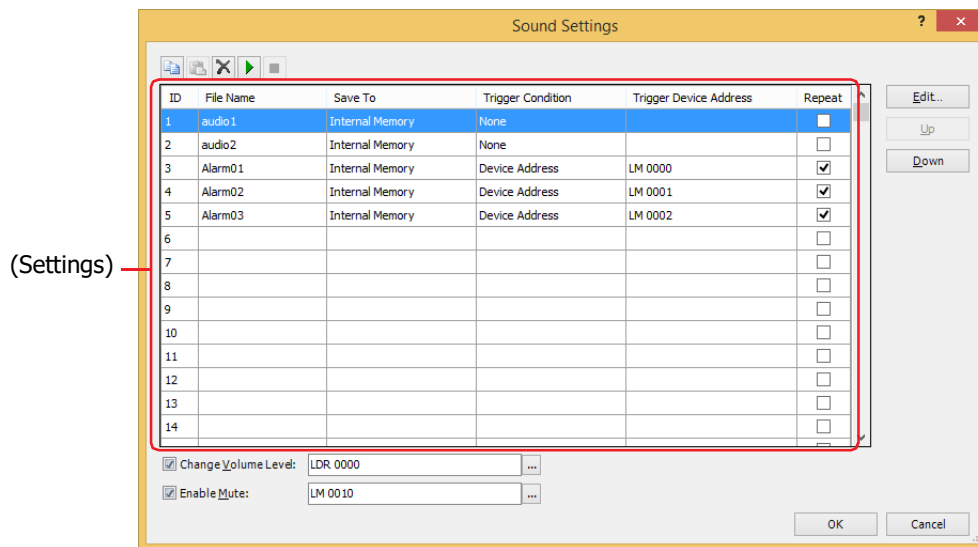

(Copy)

Select an ID and click the button to copy the contents of that row to the clipboard.

(Paste)

Select an ID and click the button to paste the contents of the clipboard to that row.



If the contents of multiple IDs are on the clipboard, the contents are pasted in ascending order from the initially selected ID.

Pasting stops when the ID reaches 1024.

(Delete)

Select an ID and click the button to delete the contents of that row.

(Sound file play)

Select an ID and click the button to play that row's sound file.



If you select multiple IDs, only the sound file of the first selected ID will play. The sound files will not play continuously.

(Sound file stop)

Stops playing the sound file.

■ (Settings)

Displays a list of the settings for sound files used by MICRO/I.



You can edit the (Settings) cell by using the right click menu.

ID: Shows the sound ID (1 to 1024) of the sound file to play.
Double clicking the cell displays the **Individual Settings** dialog box. For details, refer to "Individual Settings Dialog Box" on page 21-8.



To select multiple IDs, press and hold SHIFT or CTRL while you click the specific items.

Multiple IDs cannot be selected when the **Sound Settings** dialog box has been displayed by clicking in **Sound ID** on the **Project Settings** dialog box.

File Name: Shows the sound file name that was set.
Double clicking the cell displays the **Open** dialog box. Then specify a sound file with the **Open** dialog box.



- If the specified sound file does not exist, the file name will appear in red.
- Only sound files with file names that use alphanumeric characters are supported. However, if **Save To** is set to **Internal Memory**, file names with double-byte characters and symbols are also supported.

Save To: Select the location to save the sound file to as **Internal Memory** or **External Memory Device** *1.
Double click the cell to change.

Trigger Condition: Select **Device Address** or **None** for the condition to play the sound file.
Double click the cell to change.

Device Address: Plays the sound file according to the value of device address.

None: Select when playing a sound file as a touch sound.

Trigger Device Address: When **Trigger Condition** is **Device Address**, specify the Device Address that will be used as the condition to play the sound file.

Double-click the cell or click the cell and then click in the **Trigger Device Address** column to select a device address from the Tag Editor. For the device address configuration procedure, refer to Chapter 2 "5.1 Device Address Settings" on page 2-70.

The address cannot be specified when **Trigger Condition** is **None**.



The maximum number of external device addresses that can be used as trigger device addresses is 128. However, when the bit numbers of a word device are specified, if those bits are in the same word device, it counts as one device even when multiple bits are used.

Repeat: Select this check box to play the sound file repeatedly. The file will play repeatedly until the Trigger Condition is no longer met.
When this check box is cleared, the file only plays once.

■ Edit

Edit the settings of the selected ID.

Select an ID and click this button to display the **Individual Settings** dialog box. The settings that configure in the Individual Settings dialog box are applied to the selected ID only. For details, refer to "Individual Settings Dialog Box" on page 21-8.



To edit the settings of multiple IDs at once, press and hold SHIFT or CTRL while you click the specific rows, and then click Edit. The settings configured in the **Individual Settings** dialog box are applied to all selected IDs.

■ Up

Shifts the selected settings upward in the list.

■ Down

Shifts the selected settings downward in the list.

*1 USB flash drive inserted in USB1 for HG2J-7U, SD memory card for HG5G/4G/3G-V and HG4G/3G

■ Change Volume Level*2

Adjust the volume (0 to 31) of sound files and movie files played by the MICRO/I.

The volume changes according to the value of the specified Device Address.

The sound is muted when the Device Address value is 0, and the volume is maximum when the value is 31 or out of range.

Enter the Device Address in the text box or click to specify the address in the displayed Tag Editor. For the device address configuration procedure, refer to Chapter 2 "5.1 Device Address Settings" on page 2-70.



When the **Change Volume Level** check box is cleared, MICRO/I plays sound files and movie files at maximum volume.

■ Enable Mute*2

Mute the volume of sound files and movie files played by the MICRO/I.

When the value of the specified Device Address is 1, the sound is muted.

When the sound is muted while a sound file is playing, it continues playing without making a sound.

Enter the Device Address in the text box or click to specify the address in the displayed Tag Editor. For the device address configuration procedure, refer to Chapter 2 "5.1 Device Address Settings" on page 2-70.

● Individual Settings Dialog Box

Register or change the settings of the selected ID.

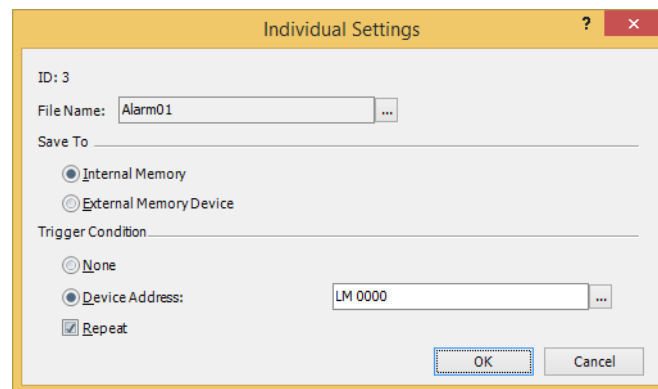

■ ID

Shows the Sound ID (1 to 1024) of the sound file to be played.

If the **Individual Settings** dialog box is opened with multiple IDs selected in **Settings**, **ID** number will not be displayed.

■ File Name

Specify the sound file.

Click the button to display the **Open** dialog box. Then specify a sound file with the **Open** dialog box.

If the **Individual Settings** dialog box is opened with multiple IDs selected in **Settings**, **File Name** will not be displayed.

■ Save To

Select the location to save the sound file to as **Internal Memory** or **External Memory Device***1.

*1 USB flash drive inserted in USB1 for HG2J-7U, SD memory card for HG5G/4G/3G-V and HG4G/3G

*2 HG5G/4G/3G-V, HG4G/3G only

■ Trigger Condition

Select **None** or **Device Address** for the condition for playing the sound file.

None: Select to play the sound file as a touch sound.

Device Address: Play the sound file according to the value of device address.

(Trigger Device Address): Specify the device address that will be the condition for playing the sound file. Click to display Tag Editor and specify the device address. For the device address configuration procedure, refer to Chapter 2 "5.1 Device Address Settings" on page 2-70.

Repeat: Select this check box to play the sound file repeatedly. The file will play repeatedly until the Trigger Condition is no longer met. When this check box is cleared, the file only plays once.



The maximum number of external device addresses that can be used as trigger device addresses is 128. However, when the bit numbers of a word device are specified, if those bits are in the same word device, it counts as one device even when multiple bits are used.

● Exporting sound files

The sound file can be exported by the steps below.

- 1 Select and right-click the ID of the sound file to be exported, and click **Export Sound Files**.
The **Browse For Folder** dialog box is displayed.
- 2 Specify a save location and click **OK**.

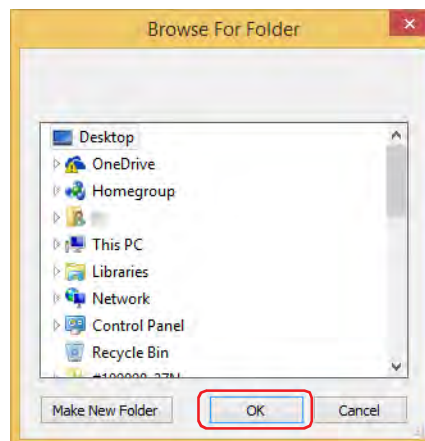

The sound file is exported using the current file name.

4 Operation

HG2J-7U HG5G-V HG4G-V HG4G HG3G-V HG3G HG2G-V HG2G-5F HG2G-5T HG1G HG1P

The MICRO/I only plays a single sound file at a time. It cannot simultaneously play multiple sound files. Therefore, if multiple trigger device addresses simultaneously change to 1 or if a sound file is set as the touch sound, the sound file played changes according to the trigger conditions.

■ Touch sound (beep) and sound file by trigger device addresses

The touch sound's beep and a sound file can be played simultaneously.

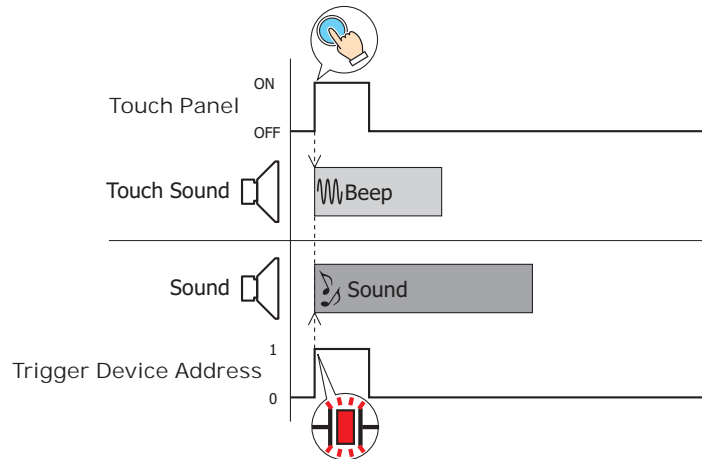

■ When touch panel is touched twice (before sound from first touch has finished playing)

For the same touch sound file, the one played later has priority.

If the touch panel is pressed twice (before the sound has finished playing from the first touch), playback of the sound file stops and the same sound file plays again from the beginning.

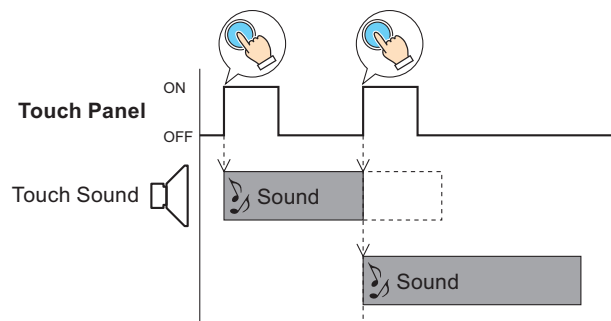

■ Touch sound (sound file) and sound file by trigger device address

When both a touch sound file and sound file set by the trigger device address are programmed, the sound file set by the trigger device address is given priority.

- As soon as the touch panel is pressed the sound file is played. However, if the trigger device address changes to 1, the touch sound file stops and the trigger device address sound file plays.

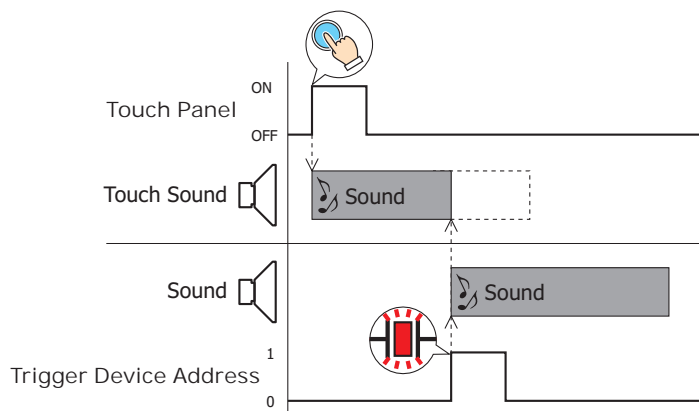

- If a sound file is playing because it was turned on by a trigger device address, the touch sound file will not play even if the touch panel is pressed.

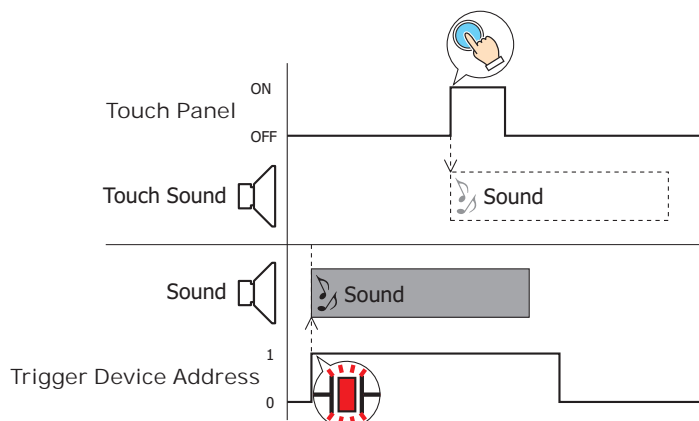

■ Sound file set by 2 triggering device addresses

For sound files set by trigger device addresses, the one played first has priority. If both change to 1 simultaneously, the smaller sound ID has priority.

- When multiple trigger device addresses change to 1 simultaneously, the smaller sound ID has priority and the sound files play in order.

For example, when playing sound ID1 when trigger device address 1 is 1 and sound ID2 when trigger device address 2 is 1, if trigger device address 1 and trigger device address 2 change to 1 simultaneously, sound ID1 playback starts and after it finishes, if trigger device address 2 is 1, sound ID2 playback starts.

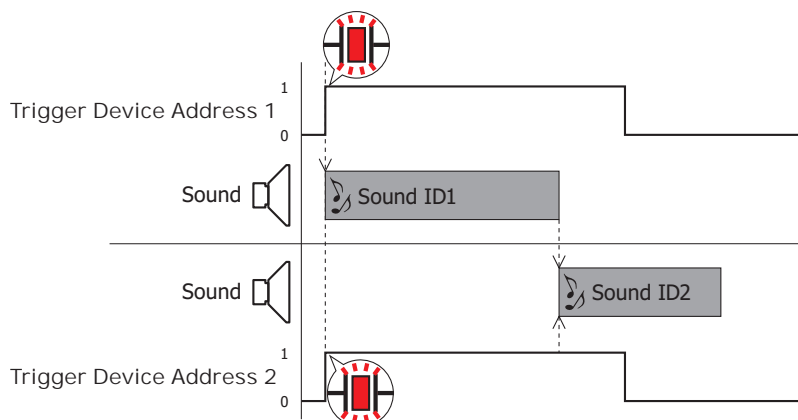

- While a sound file is playing, the sound ID for the trigger device address that changed to 1 is put into a queue for playback.

For example, when playing sound ID1 when trigger device address 1 is 1 and sound ID2 when trigger device address 2 is 1, if trigger device address 2 changes to 1 while sound ID1 is playing, then sound ID2 playback starts if trigger device address 2 is 1 when sound ID1 finishes playing.

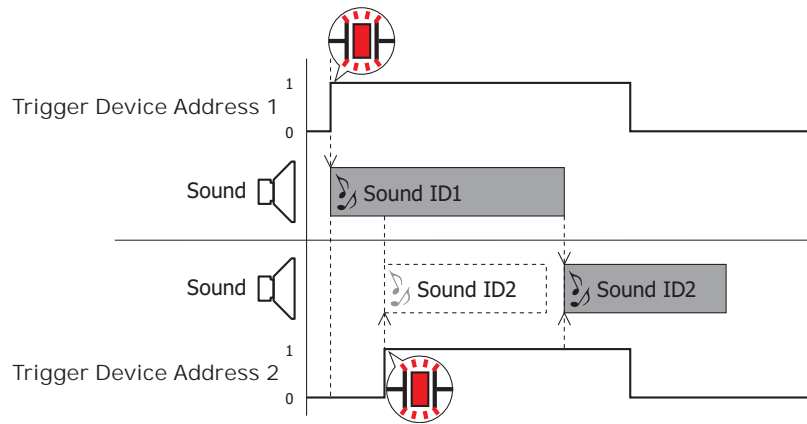

However, if the trigger device address for sound ID2 is 0 when sound ID1 finishes playing, sound ID2 does not play.

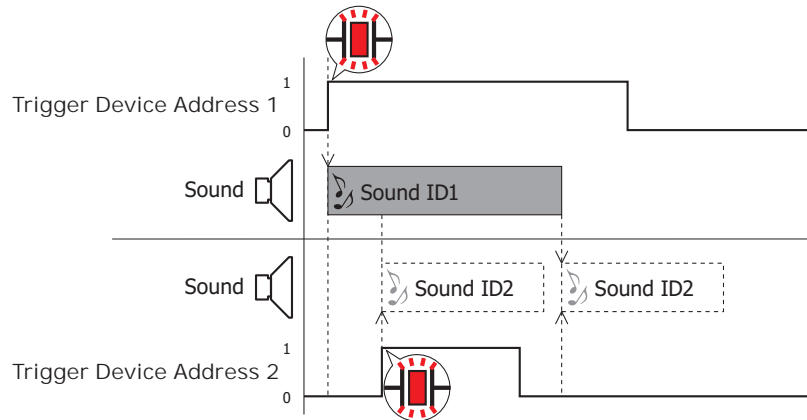

- When the sound ID currently playing is set to **Repeat: Enabled**, no other sound IDs will play until the trigger condition for this sound ID is no longer satisfied.

For example, when playing sound ID1 when trigger device address 1 is 1 and sound ID2 when trigger device address 2 is 1, even if sound ID2's trigger device address changes to 1 while sound ID1 is set to **Repeat: Enabled** and repeatedly playing, sound ID1 playback continues. When sound ID1's trigger device address changes to 0, sound ID2 playback starts if trigger device address 2 is 1.

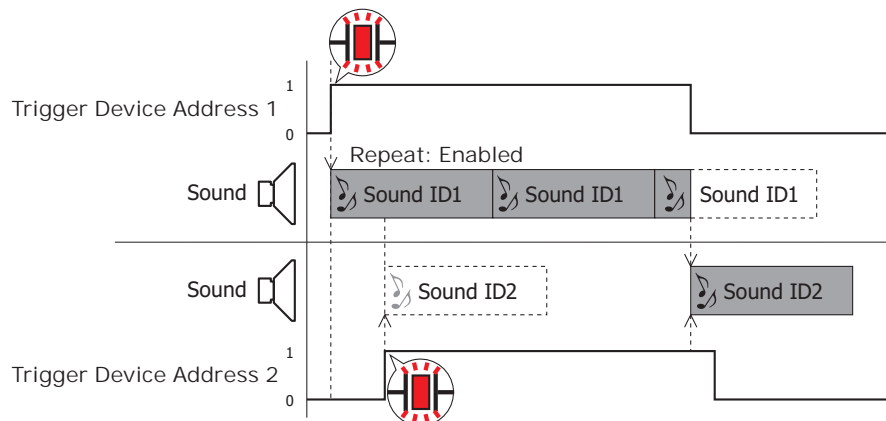

Chapter 22 Multimedia Function

This chapter describes how to register and play movie files played on the Video Display, how to save video and audio to the external memory device before and after an event occurs, how to play saved video and audio, and how to configure the video input.

This function is only supported by models that are equipped with a video interface.

1 Function and Settings

HG2J-7U HG5G-V HG4G-V HG4G HG3G-V HG3G HG2G-V HG2G-5F;HG2G-5T;HG1G HG1P

1.1 How the Multimedia Function is Used

With its built-in video interface (VIDEO IN/OUT) and audio interface (AUDIO IN^{*1}/OUT), a video camera or microphone^{*1} can be connected to the MICRO/I and used in the following ways. Multimedia function uses the SD memory card as the external memory device.

- Register movie files to play with the MICRO/I and play the movie files on the Video Display

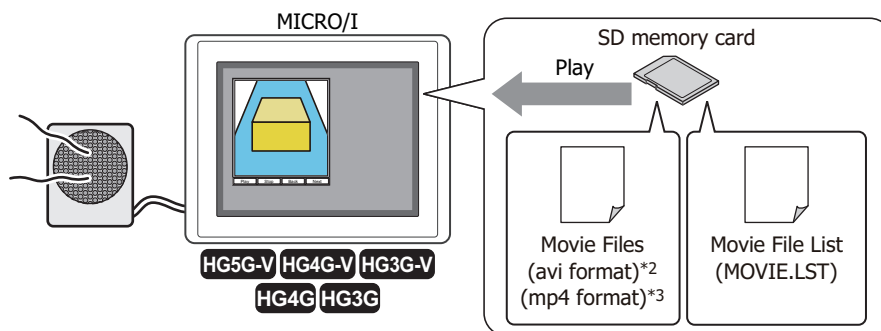

- Save video camera images and microphone audio^{*1} to the external memory device before and after an event occurs.

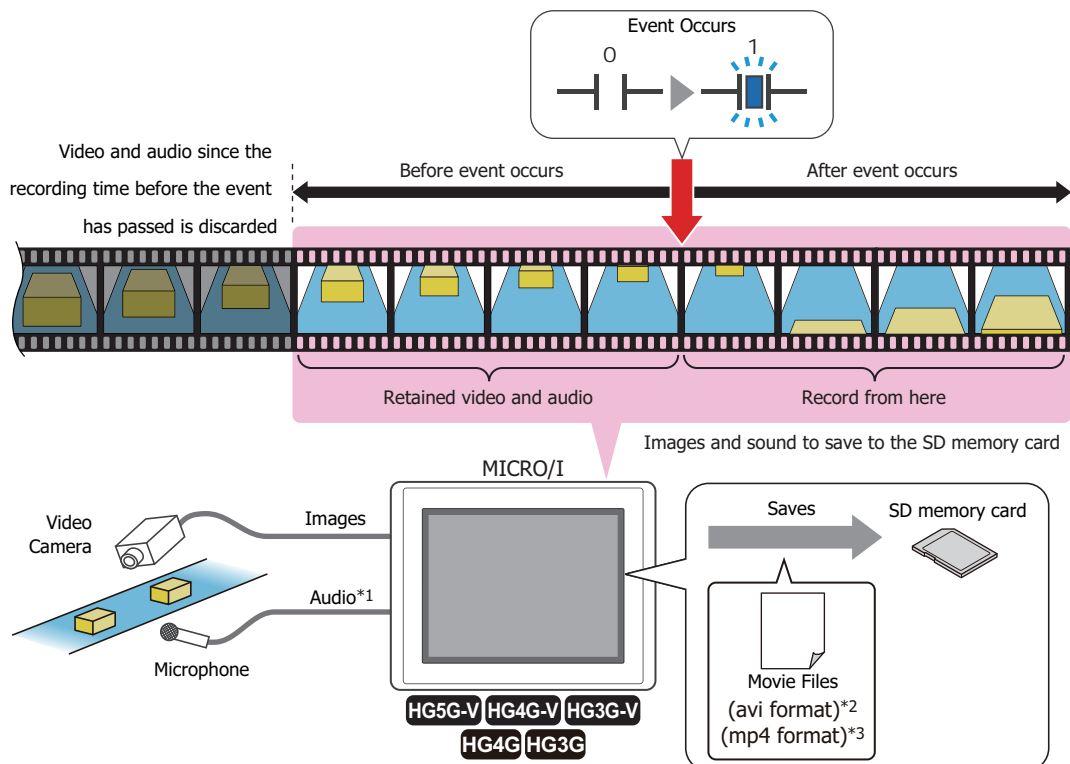

*1 Recording sound function is for HG4G/3G only

*2 HG5G/4G/3G-V only

*3 This is applicable for HG4G/3G with a video interface only.

- Configure the video input for the device connected to the MICRO/I

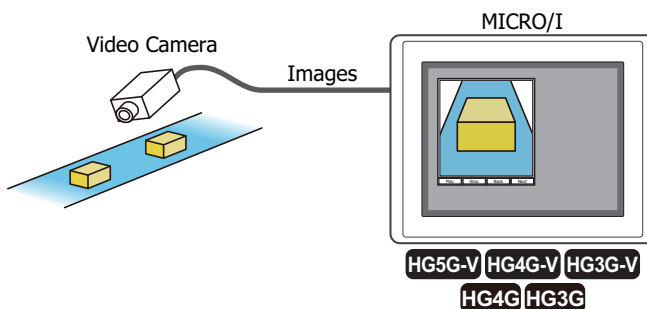

- Input images from two video cameras*2

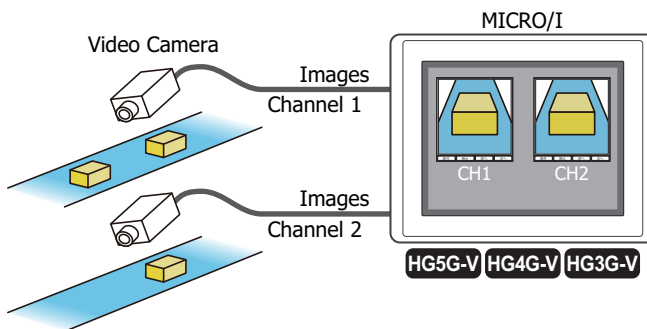

- The MICRO/I can play movie files, display video, and output audio using the Video Display.
 - ☞ Chapter 10 "4 Video Display" on page 10-81
- The MICRO/I can record and play video and audio using the key buttons.
 - ☞ Chapter 8 "Recording Images and Sound" on page 8-103
 - ☞ Chapter 8 "Playing Recorded Images and Sound" on page 8-106

1.2 Supported Movie Files

Movie files that meet the following specifications can be played with the MICRO/I:

Item	Description
File format	HG5G/4G/3G-V: AVI file (.avi) HG4G/3G: MP4 file (.mp4)
Movie	HG5G/4G/3G-V: Motion JPEG HG4G/3G: MPEG-4 Simple Profile
Audio	HG5G/4G/3G-V: PMC (Sampling rate 8000, 11025, 12000, 16000, 24000, 22050, 32000, 44100Hz) HG4G/3G: AAC-LC (Bit rate 32 kbps or less recommended)
Frame rate	30 fps or less (15 fps or less recommended)
Resolution	720 x 480 dots or less (640 x 480 dots or less recommended)
File size	64 Mbyte or less (32 Mbyte or less recommended)

The MICRO/I may not be able to play the formats above correctly depending on the minimum system requirements. In this situation, shrink the size of the file by lowering the frame rate or the resolution of the file or by lowering the bit rate of the audio. If audio is unnecessary, set to a file without sound.

*2 HG5G/4G/3G-V only

2 Multimedia Function Configuration Procedure

HG2J-7U HG5G-V HG4G-V HG4G HG3G-V HG3G HG2G-V HG2G-5F HG2G-5T HG1G HG1P

This section describes the configuration procedure for the Multimedia function.

2.1 Registering Movie Files

- 1 On the **Configuration** tab, in the **System Setup** group, click **Multimedia**.

The **Multimedia Settings** dialog box is displayed.

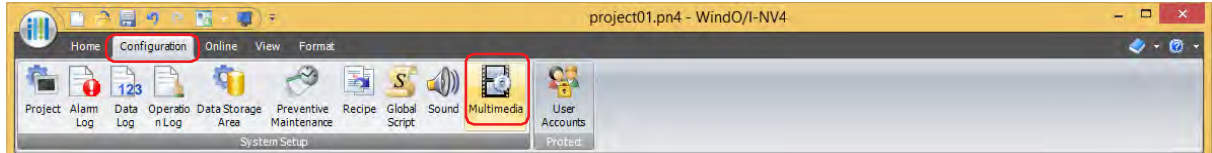

- 2 Select the ID to be used to register the movie file in **Movie File List** on the **Movie** tab. Click the **File Path** cell and enter the file path of the movie file.

The maximum number is 250 alphanumeric characters.

Example: When specifying the movie file "sample01.mp4" that has been saved to the "MOVIE" folder in the External Memory Device folder "HGDATA01"

Enter "sample01".

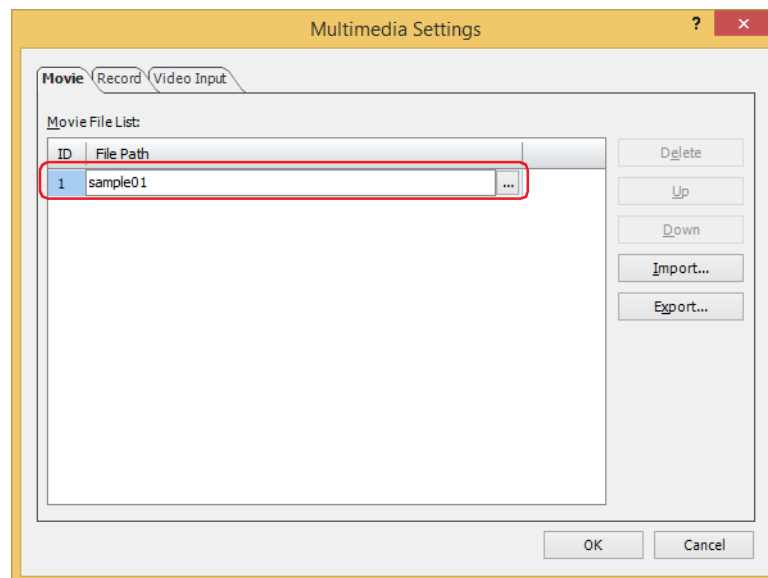

To specify in the Open dialog box, double-click the cell or click the cell and click **...** to open the **Open** dialog box.

- 3 Repeat steps 2 to add all the movie files to play (1 to 64).

- 4 Click **OK**.

The **Multimedia Settings** dialog box closes.

This concludes the configuration to register movie files.

● Playing a Movie File List on the Video Display

- 1 Following the procedure in “2.1 Registering Movie Files” on page 22-3, register the movie files to play on the Video Display.
- 2 On the **Home** tab, in the **Parts** group, click **Data Displays**, and then click **Video Display**.

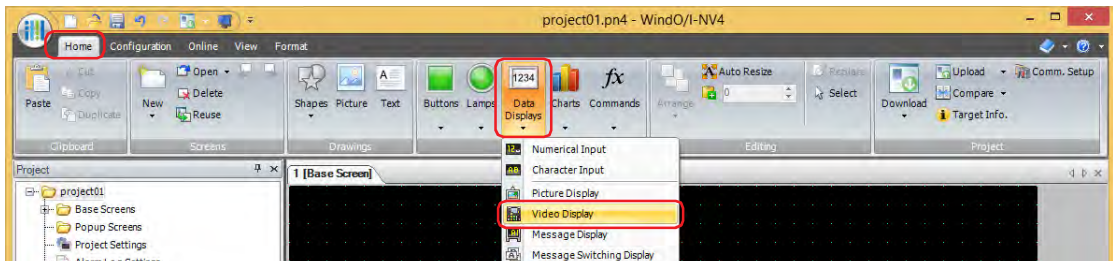

- 3 Click a point on the edit screen where you wish to place the Video Display.
- 4 Double-click the placed Video Display and the Properties dialog box is displayed.

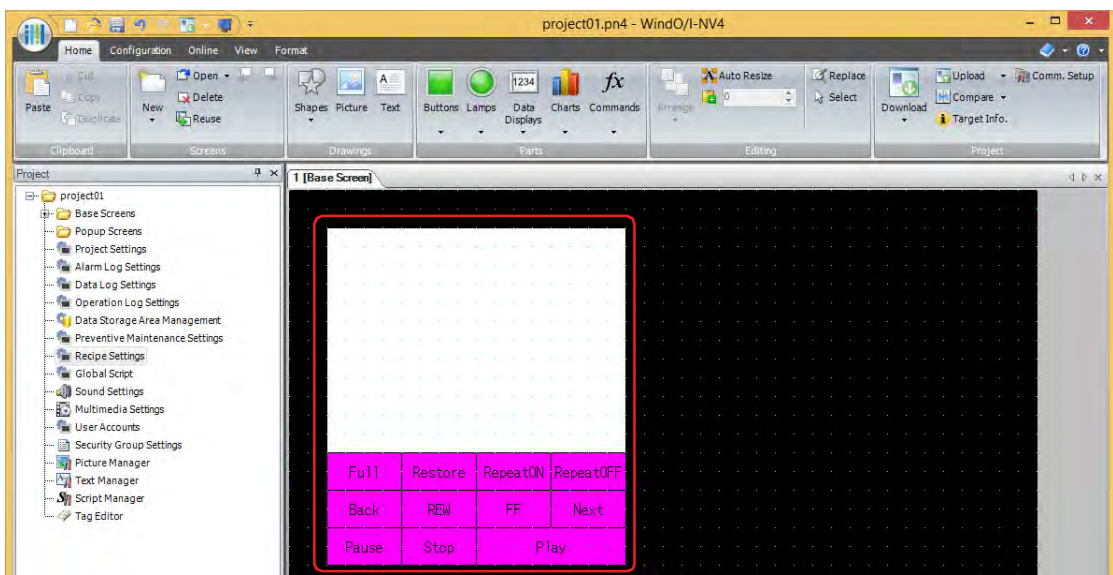

- 5 On the **General** tab, under **Action**, select **Play the Movie File List**.
This option plays all the movies registered in **Movie File List** in the **Multimedia Settings** dialog box.

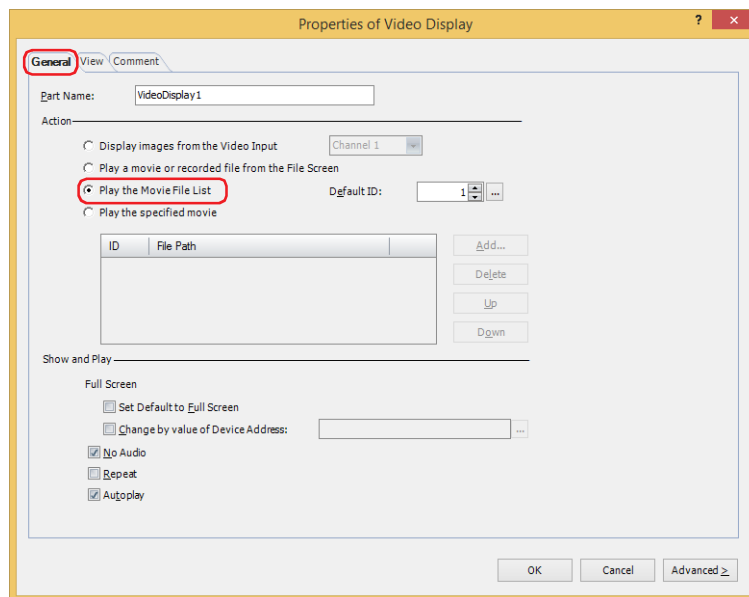

- 6 In **Default ID**, specify the ID number (1 to 64) of the movie file to play when the Play button is pressed.

Click  to display the **Multimedia Settings** dialog box. Select the ID number from the movie file list. The movie files registered in the movie file list are played in order from the specified ID number.

- 7 Click **OK**.

The Properties of Video Display dialog box closes.

This concludes the configuration to play a movie file list on the Video Display.

2.2 Configuring the Event Recording Function

- 1 On the **Configuration** tab, in the **System Setup** group, click **Multimedia**.
The **Multimedia Settings** dialog box is displayed.

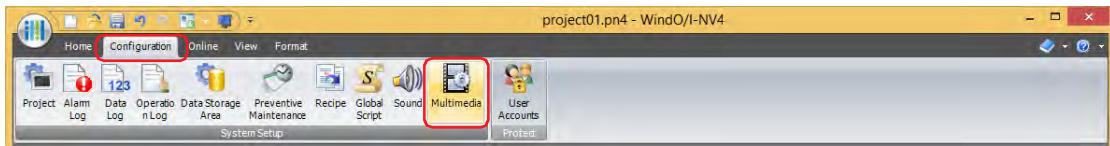

- 2 Click the **Record** tab.

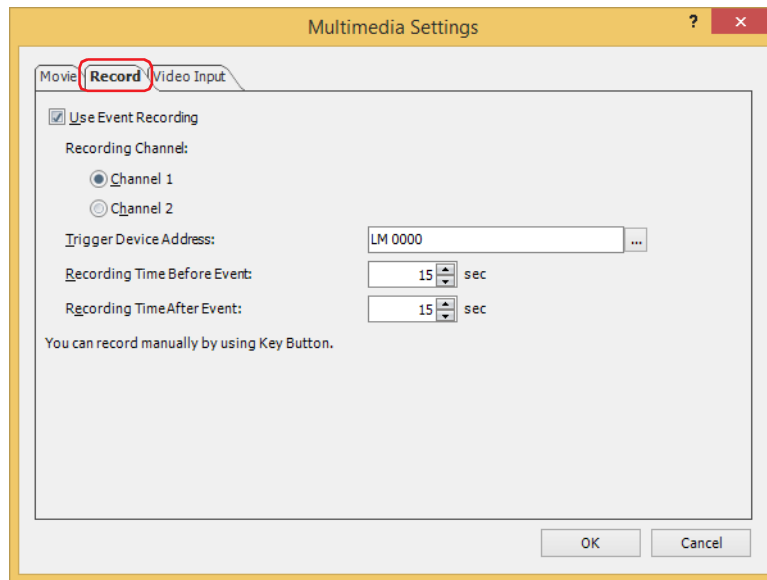

- 3 Select the **Use Event Recording** check box.
- 4 Select a recording channel*¹ or a recording target*².
 - **Recording Channel*¹**
Selects **Channel 1** or **Channel 2** to record a video only (no audio) out of the signals input from the device.
 - **Recording Target*²**
In the signals input from the device, select **Video and Audio** or **Video only (No Audio)** as the recording target.
- 5 Specify the bit device that will trigger the start of recording in **Trigger Device Address**.
Click **...** to display the Tag Editor. For the device address configuration procedure, refer to Chapter 2 "5.1 Device Address Settings" on page 2-70.
- 6 Specify the recording time before and after the event occurs.
 - **Recording Time Before Event**
With the point in time when the value of device address changes from 0 to 1 as the start point, this setting specifies how many seconds to record before the start point (1 to 15 sec.).
 - **Recording Time After Event**
Specifies the time (1 to 15 sec.) until recording stops from when the value of device address changed from 0 to 1.
- 7 Click **OK**.
The **Multimedia Settings** dialog box closes.
This concludes configuring the Record function.

*1 HG5G/4G/3G-V only

*2 This is applicable for HG4G/3G with a video interface only.

- **Playing Images Recorded with the Event Recording Function**
Play the recorded movie file on the Video Display.

Configuration Procedure

- 1 Create the Video Display to play the recorded images.
On the **Home** tab, in the **Parts** group, click **Data Displays**, and then click **Video Display**.

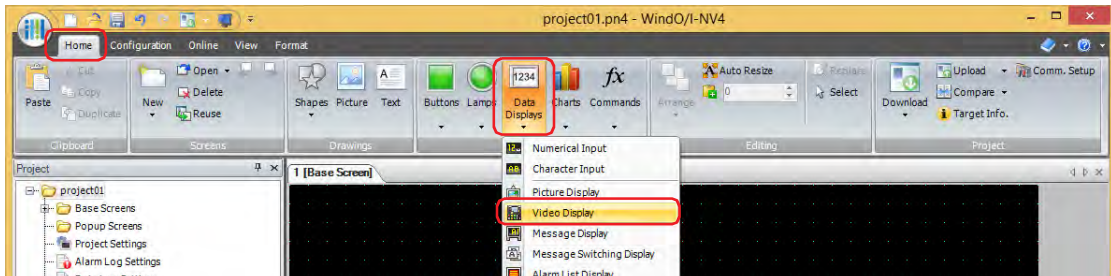

- 2 Click a point on the edit screen where you wish to place the Video Display.
- 3 Double-click the placed Video Display and the Properties dialog box is displayed.

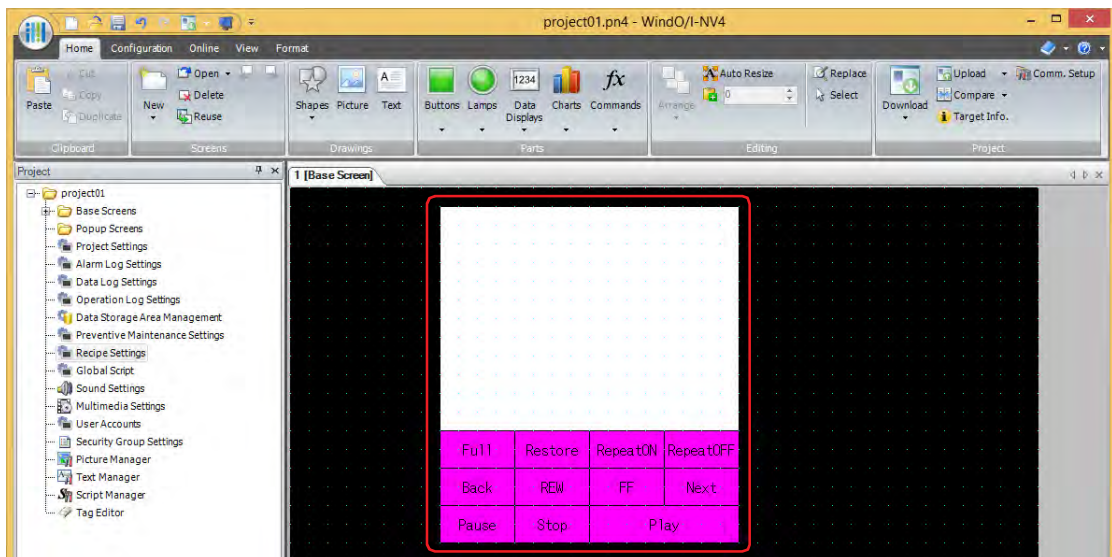

- 4 On the **General** tab, under **Action**, select **Play a movie or recorded file from the File Screen**.
This option selects and plays movie files using the File Screen.

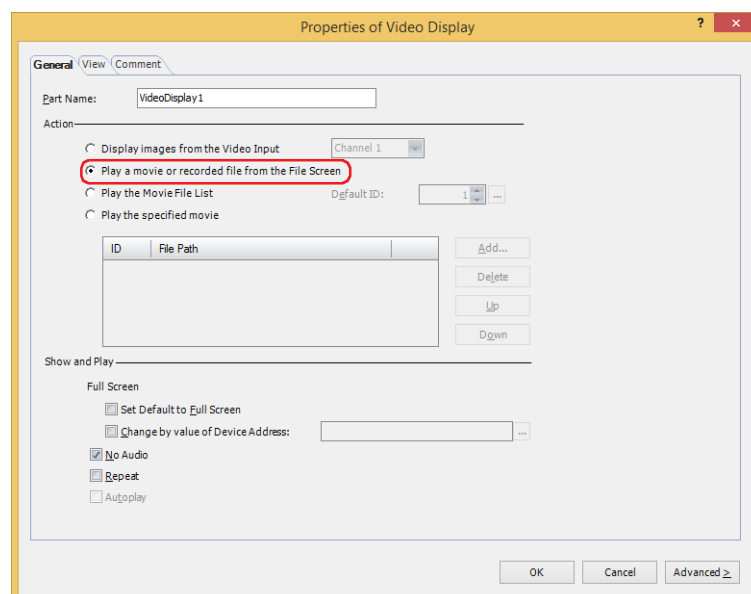

5 Click **OK**.

The Properties of Video Display dialog box closes.

6 Create a button to open the screen to select a recorded images.

On the **Home** tab, in the **Parts** group, click **Buttons**, and then click **Goto Screen Button**.

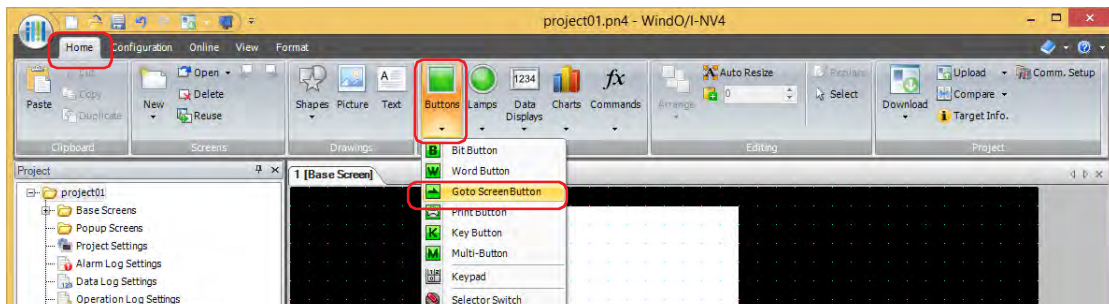

7 Click a point on the edit screen where you wish to place the Goto Screen Button.

8 Double-click the placed Goto Screen Button and a Properties dialog box will be displayed.

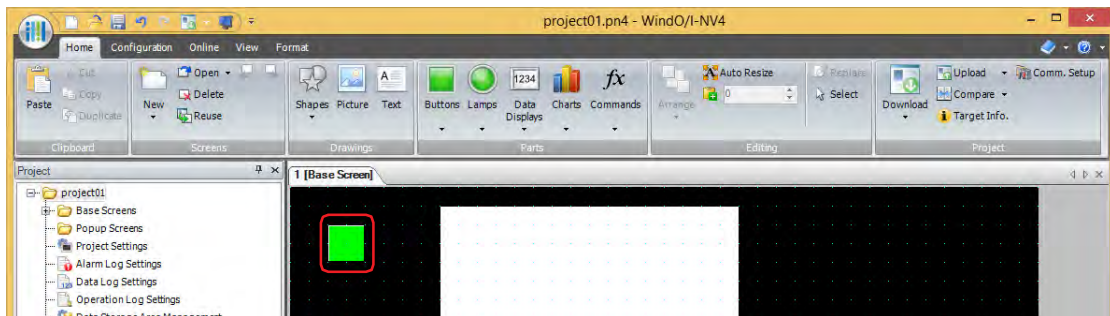

9 On the **General** tab, select **Open File Screen for Movie Files** for **Action Mode**.

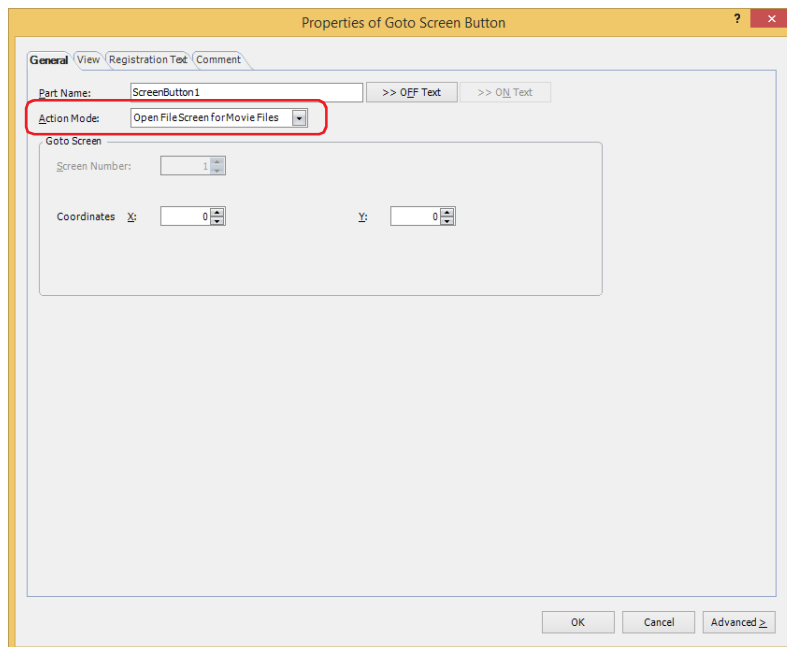

10 Specify the display location in coordinates for the movie file screen to open above the base screen with **Coordinates X, Y**.

With the upper-left corner of the screen as the origin, the upper-left corner of the window is the X and Y coordinates.

X: 0 to (base screen horizontal size - 1)

Y: 0 to (base screen vertical size - 1)

11 Click **OK**.

Close the Properties of Goto Screen Button dialog box.
This concludes configuring playback of recorded images.

Operating Procedure

To play sound, the MICRO/I must be connected to speakers.

This section describes the example of playing the movie file "123000.avi" located in the "20110313" folder under the "RECORD" folder when the External Memory Device folder is "HGDATA01".



Movie files that meet the following specifications can be played with the MICRO/I:

- HG5G/4G/3G-V: AVI file (.avi)
- HG4G/3G: MP4 file (.mp4)

For details, refer to Chapter 2 "1.6 Available Movie Files" on page 2-37.

1 Press the Goto Screen Button set to **Open File Screen for Movie Files**.

The File Screen is displayed.

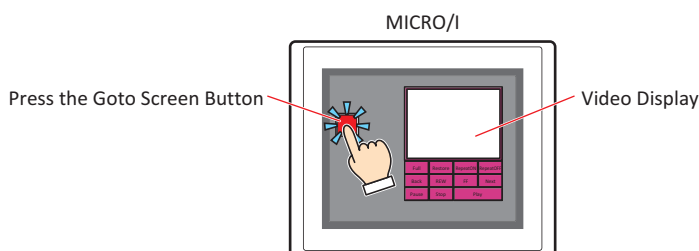

2 Select the folder with the date of the recorded images.

Press ▼ to select "20110313" and then press **Select**.
The contents of the "20110313" folder will be displayed.

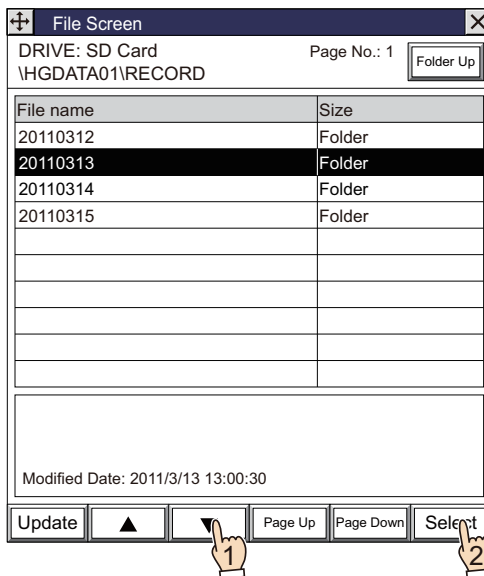

Once the File Screen is opened, the "RECORD" folder in the External Memory Device folder will be displayed. If the "RECORD" folder does not exist, the External Memory Device folder will be displayed.

3 Select a movie file.

Press **▼** to select "123000.avi" and then press **Select**.

The movie file will be selected and the File Screen will close.

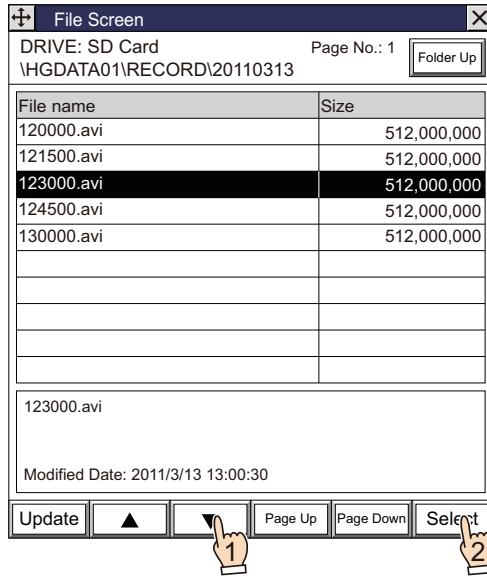

4 Press **Play** on the Video Display.

The movie file is played.

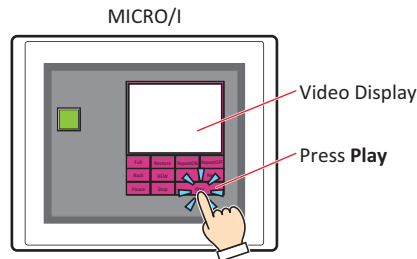

! While data is being recorded after an event occurs with the event recording function, while data is being recorded with a Key Button, Multi-Button, or Multi-Command configured with the recording function, or while data is being saved to the external memory device, movie files cannot be played. While data is recording after an event occurs and while data is being saved to the external memory device, the value of HMI Special Data Register LSD155-0 changes to 1. For details, refer to Chapter 33 "HMI Special Data Register (LSD)" on page 33-8.

2.3 Configuring the Video Input

- 1 On the **Configuration** tab, in the **System Setup** group, click **Multimedia**.
The **Multimedia Settings** dialog box is displayed.

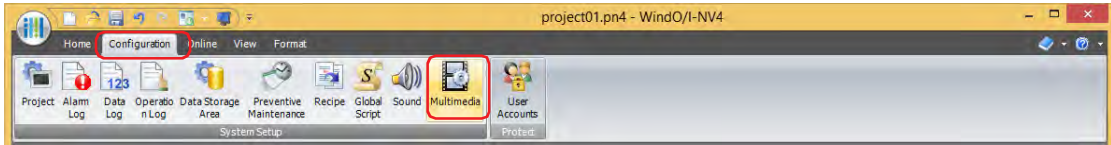

- 2 Click the **Video Input** tab.

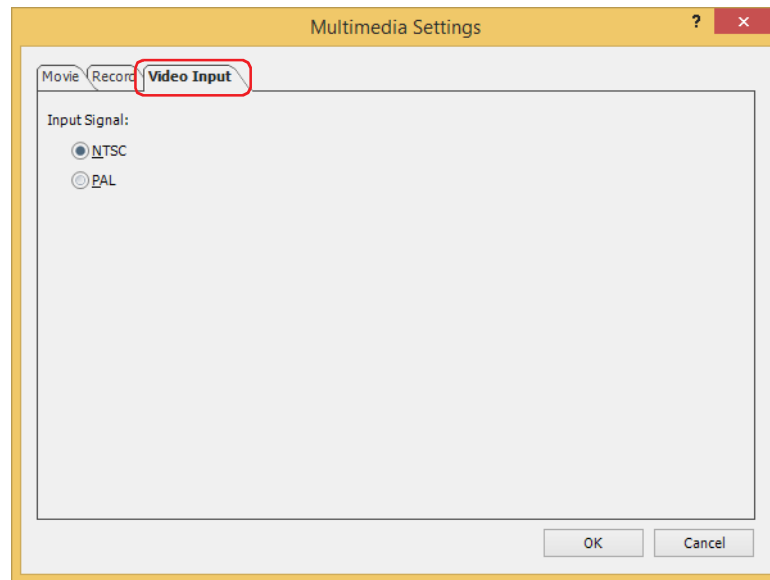

- 3 Select **NTSC** or **PAL** for the signal standard of the device connected to the MICRO/I.



The adopted format for the signal standard differs according to the country or region.

NTSC: Japan, Korea, Taiwan, North America, Central America, South America, others

PAL: Europe, China, the Middle East, South East Asia, others

- 4 Click **OK**.

The **Multimedia Settings** dialog box closes.
This concludes configuring the video input.

3 Multimedia Settings Dialog Box

HG2J-7U HG5G-V HG4G-V HG4G HG3G-V HG3G HG2G-V HG2G-5F HG2G-5T HG1G HG1P

This section describes items and buttons on the **Multimedia Settings** dialog box.

3.1 Multimedia Settings Dialog Box

● Movie Tab

Create and edit a list of movie files to be used with project data.

Based on the contents that have been set a movie file list, "MOVIE.LST", is automatically created in the root folder of the External Memory Device folder in the external memory device.

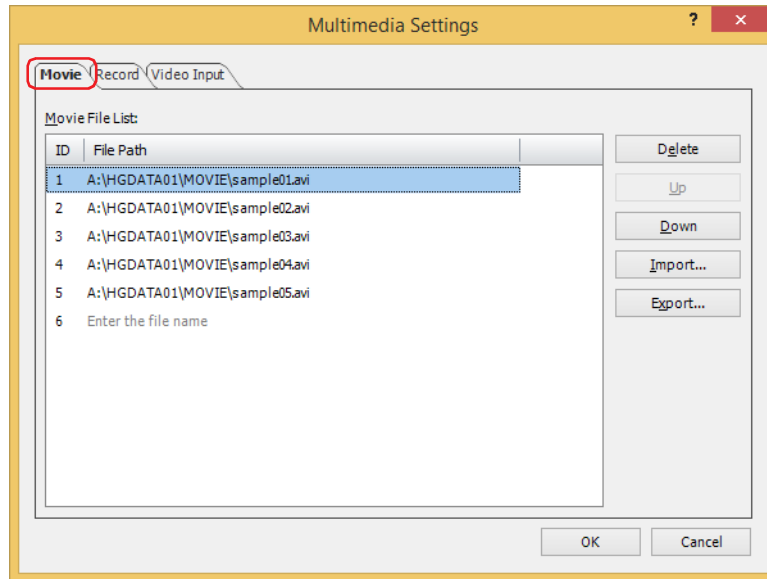

■ Movie File List:

Displays a list of movie files to be used with project data.

ID: Displays the movie file list ID.

File Path: Displays the file path of the movie file.

Click the cell, and then enter the file path of a movie file. The maximum number is 250 characters. Only alphanumeric characters and symbols can be used.

To specify a movie file saved in the "MOVIE" folder in the External Memory Device folder configured on the **External Memory Device** tab in the **Project Settings** dialog box, only enter the file name.

Example: When the name of the External Memory Device folder is "HGDATA01"

Enter "sample01" and the file name is:

A:\HGDATA01\MOVIE\sample01.file extension*1

Click the cell, and then click to display the **Open** dialog box. Then specify a movie file with the **Open** dialog box.



You cannot use the following characters in the file path.

" * , / : ; < > ? |

However, a colon (:) can be used to indicate a drive letter, such as "A:".

*1 avi for HG5G/4G/3G-V, mp4 for HG4G/3G

Delete

Deletes movie files from the movie file list.

Select a movie file from the movie file list and then click this button.



Even if the file path of a movie file is deleted from the movie file list, the movie file itself will not be deleted.

Up

Shifts the selected movie file upward on this list.

Down

Shifts the selected movie file downward on this list.

Import

Imports an exported movie file list.

Existing movie file lists will be overwritten.

Export

Exports a movie file list with the file name "MOVIE.LST".

● Record Tab

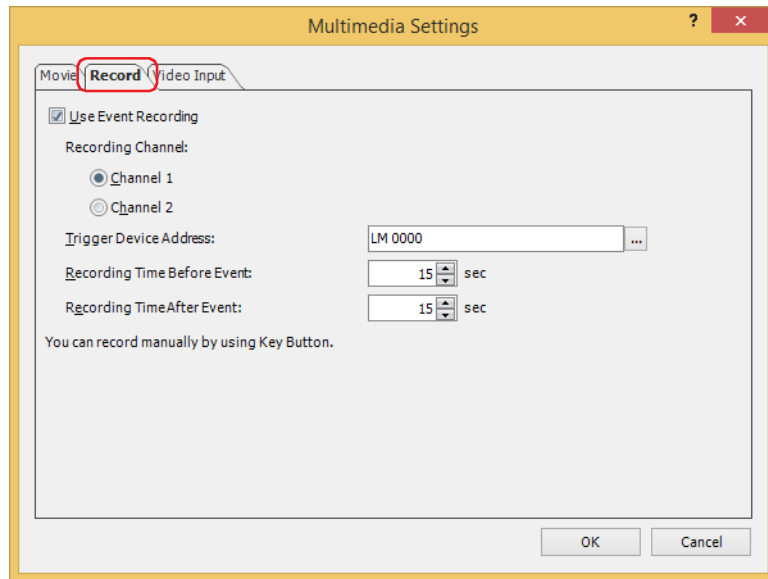

■ Use Event Recording

Select this check box to use the event recording function.

The event recording function has the MICRO/I monitor the state of a trigger device address. When the value of device address changes from 0 to 1 (when an event occurs), the function records the video and audio before and after the event.

■ Recording Channel*1

Selects **Channel 1** or **Channel 2** to record a video only (no audio) out of the signals input from the device.

■ Recording Target*2

Select the target to record out of the signals input from the device.

Video and Audio: Records images and sound.

Video only (No Audio): Records images only.

■ Trigger Device Address

Specifies the bit device that will trigger the start of recording. This option can only be set when **Use Event Recording** is selected.

Click  to display the Tag Editor. For details, refer to Chapter 2 "5.1 Device Address Settings" on page 2-70.

■ Recording Time Before Event

Specifies the amount of time (1 to 15 sec.) to record before the value of trigger device address changes from 0 to 1. This option can only be set when **Use Event Recording** is selected.

■ Recording Time After Event

Specifies the amount of time (1 to 15 sec.) to record after the value of trigger device address changes from 0 to 1. This option can only be set when **Use Event Recording** is selected.



While data is being recorded after an event occurs with the event recording function and while recorded data is being saved to the external memory device, data cannot be recorded with a Key Button, Multi-Button, or Multi-Command configured with the recording function and movie files cannot be played. Also, during these situations, the value of HMI Special Data Register LSD155-0 changes to 1. For details, refer to Chapter 33 "HMI Special Data Register (LSD)" on page 33-8.

*1 HG5G/4G/3G-V only

*2 This is applicable for HG4G/3G with a video interface only.

● Video Input Tab

Set the signal standard for the device that will connect to the MICRO/I.

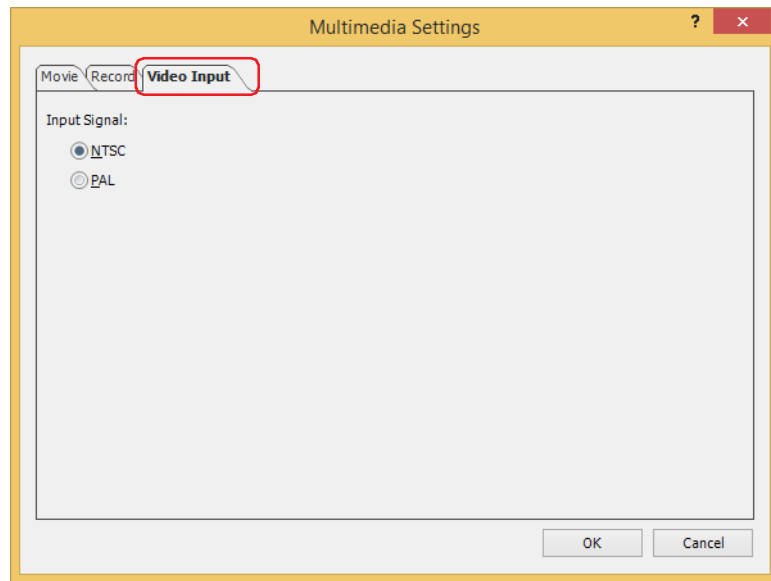

■ Input Signal

Select from **NTSC** or **PAL** for the signal standard of the device connected with the MICRO/I.



The adopted format for signal standards will differ depending on the country or region.

NTSC: Japan, Korea, Taiwan, North America, Central America, South America, etc.

PAL: Europe, China, The Middle East, South East Asia, etc.

4 Checking the Status of the Function

HG2J-7U HG5G-V HG4G-V HG4G HG3G-V HG3G HG2G-V HG2G-5F HG2G-5T HG1G HG1P

You can check various kinds of information for the multimedia function through the values of the HMI Special Data Register. Details on HMI Special Data Register are given below:

■ LSD 155: Event Recording Function Status Information

Bit number	Description
0	While data is recording after an event occurs and while recorded data is being saved to the external memory device, the value changes to 1.
1 to 15	Reserved

■ LSD 165: Error Information

Function name	Description	Status
Multimedia Function Error Information	Stores error information for the multimedia function.	0: Normal 1: Specified file does not exist 2: File format is incorrect 3: Specified parameter value is out of range

5 Restrictions

HG2J-7U HG5G-V HG4G-V HG4G HG3G-V HG3G HG2G-V HG2G-5F HG2G-5T HG1G HG1P

- When you have a movie file (.mp4) and a sound file (.WAV), you cannot play both of them at the same time.
- Movie files and sound files cannot be played while recording.
Sound files cannot be played if the event recording function is enabled.
- Movie files cannot be played and video cannot be displayed while the Maintenance Screen is being displayed.
- If the zoom magnification for the movie file is greater than 2x, the zoom magnification is adjusted to 2x and the movie is centered and displayed.
- If **SIEMENS S7-MPI** is selected in Communication Driver, the speed of the MICRO/I scan process decreases by playing movie files and by displaying or recording video from video input.
- If writing to an external memory device occurs while playing a movie file, the image and sound of the video may be disturbed.
- When using the Cyclic Script, movie file playback and displaying or recording video from video input may be interrupted.
- If the MICRO/I Installation direction is set to Vertical installation, movie file playback and displayed video is performed in the same direction as the Horizontal installation.
To play movie files on a Vertical installation MICRO/I, use movie files with the display orientation rotated to match the installation direction.
- When using the event recording function, the event recording function is paused if you record with a Key Button, Multi-Button, or Multi-Command configured with the recording function or play movie files, so take note of the following.
 - While recording with parts and while playing movie files, nothing is recorded if an event occurs.
 - When data was recorded with a part, it takes approximately 1 second after the data is finished being saved to the external memory device until the event recording function resumes operating.
 - When a movie file was played, it takes approximately 1 second from stopping playback until the event recording function resumes operating.
- While data is being recorded after an event occurs with the event recording function and while recorded data is being saved to the external memory device, data cannot be recorded with a Key Button, Multi-Button, or Multi-Command configured with the recording function and movie files cannot be played. Also, during these situations, the value of HMI Special Data Register LSD155-0 changes to 1. For details, refer to Chapter 33 "HMI Special Data Register (LSD)" on page 33-8.
- Movie files which allow to use the FF key and the REW key in the Video Display are as follows
 - If the playback time is 10 minutes or less, files with 1 or more I-frames every 2 seconds
 - If the playback time is 10 minutes or more, files with 1 or more I-frames every 5 seconds
- If a popup screen is moved that has a Video Display showing a video or playing a movie file, the display may briefly remain in the position before being moved.
- If it takes a long time to recognize the SD memory card, movie files cannot be played directly after starting operation. In this case, play the movie file after HMI Special Internal Relay LSM21 changes to 1. For details, refer to Chapter 33 "HMI Special Relay (LSM)" on page 33-2.



The time to save data to the external memory device varies based on the write speed of the external memory device used.

Chapter 23 User Accounts and the Security Function

This chapter outlines user accounts and the Security function, how to configure them, and their operation on the MICRO/I and in WindO/I-NV4.

1 Overview

HG2J-7U HG5G-V HG4G-V HG4G HG3G-V HG3G HG2G-V HG2G-5F HG2G-5T HG1G HG1P

1.1 User Accounts

The Security function protects access to data and MICRO/I displays and operations using accounts. Accounts are the privileges to use the MICRO/I and data. By assigning accounts to users, you can protect the MICRO/I from being inappropriately operated and protect project data from alterations and misuse.

Accounts assigned to users are called user accounts.

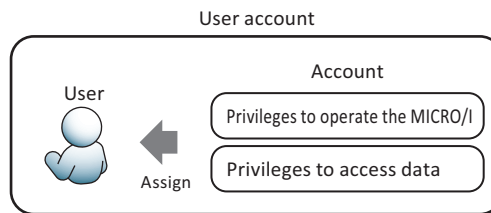

In WindO/I-NV4, security groups are used as accounts.

There are two types of security groups: provided security groups (Administrator, Operator, and Reader) and user-created security groups. One or more of these security groups can be assigned to users.

One or more users must always be assigned to Administrator.

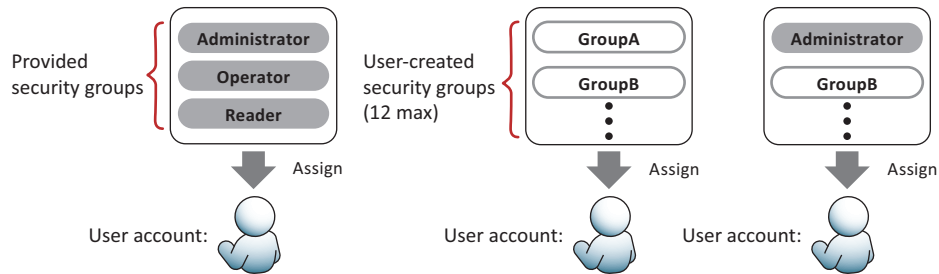

A user name and password are associated with a user account and up to 15 user accounts can be created.

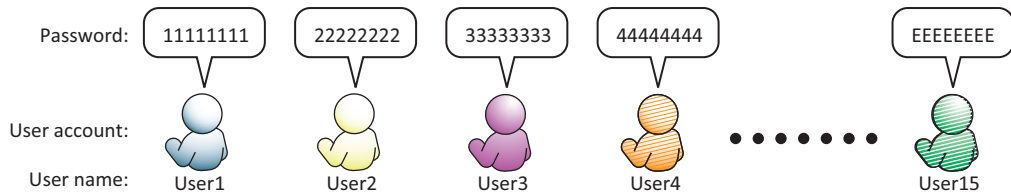

If you configure a password for a user account assigned to a security group, access to data and MICRO/I displays and operations are password protected.

For password protected operations, users are prompted to enter their user name and password as necessary on the MICRO/I Password screen or the WindO/I-NV4 **Enter Password** dialog box.

Password screen

Password											
User										▲	▼

1	2	3	4	5	6	7	8	9	0	BS	
Q	W	E	R	T	Y	U	I	O	P	CLR	
123 abc	A	S	D	F	G	H	J	K	L	CAN	
!/?#	Z	X	C	V	B	N	M	ENT			

Enter Password dialog box



- You can set a dedicated password when opening the project. In the **Security** dialog box, on the **Options** tab, select the **Use Password to open a Project** check box, and then set the password.
- If a password is not configured for a user account, access to data and MICRO/I displays and operations cannot be protected.
- The Password Input Screen can only be created when the **Use Security functions** check box and the **Customize Password Input Screens** check box in the Security dialog box are selected. If you are using the Password Input Screen provided by MICRO/I, you do not need to create the screen.

1.2 Protecting Data

● Protecting Access to Data

Security groups that protect access to data can perform the following functions.

- Protect from changes by editing project data

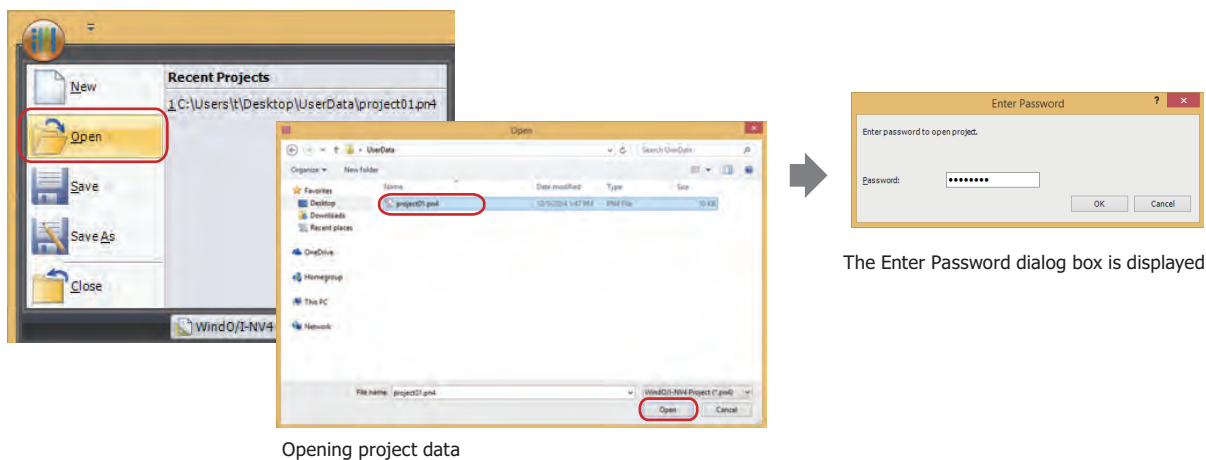

- Protect from alterations or misuse by downloading data

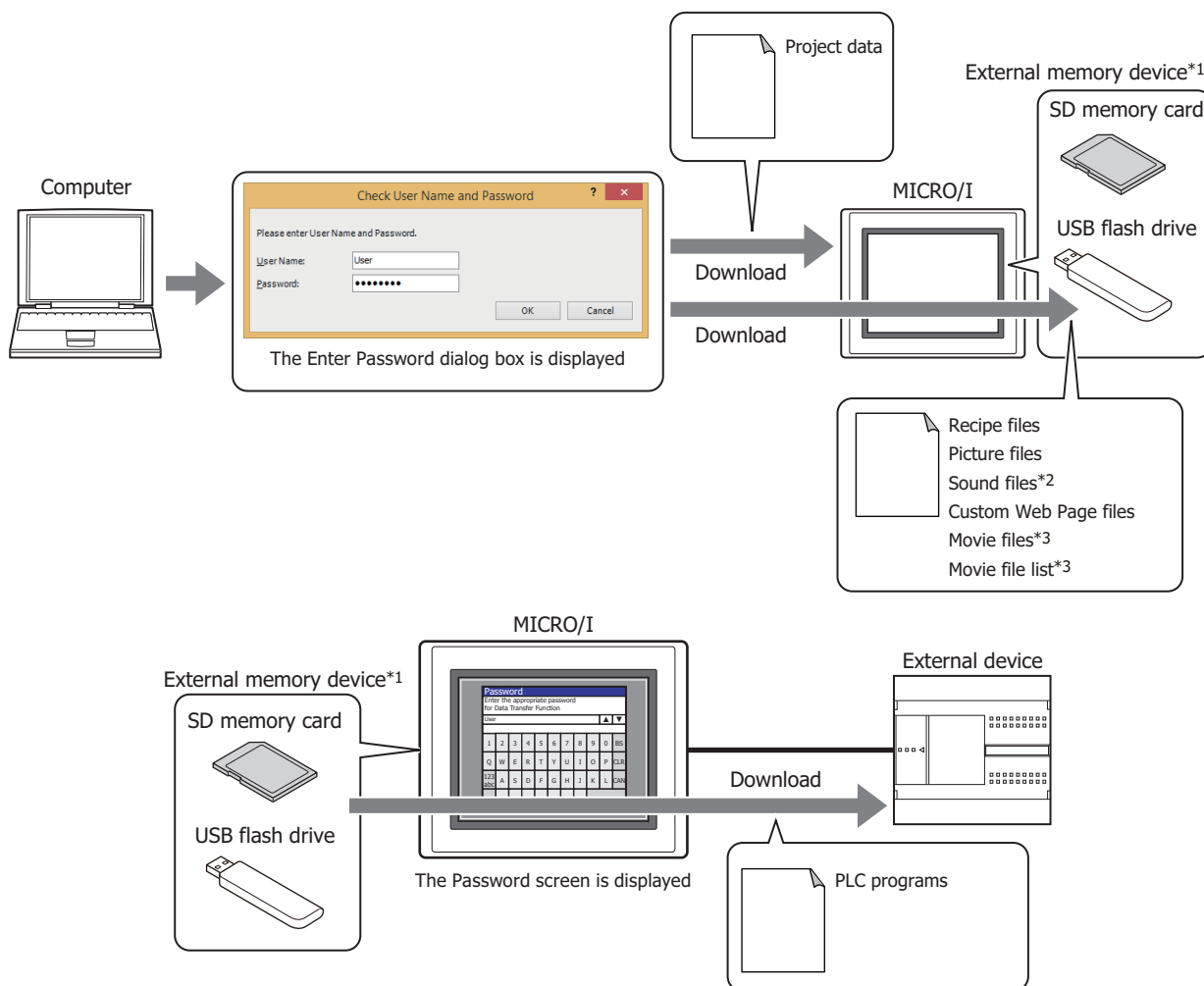

*1 USB flash drive inserted in USB1 for HG2J-7U, SD memory card for HG5G/4G/3G/2G-V, HG4G/3G and HG2G-5F, USB flash drive for HG2G-5T and HG1G/1P

*2 This is applicable for HG2J-7U and models with an audio interface only.

*3 This is applicable for models with a video interface only.

- Protect from the loss of data by upload

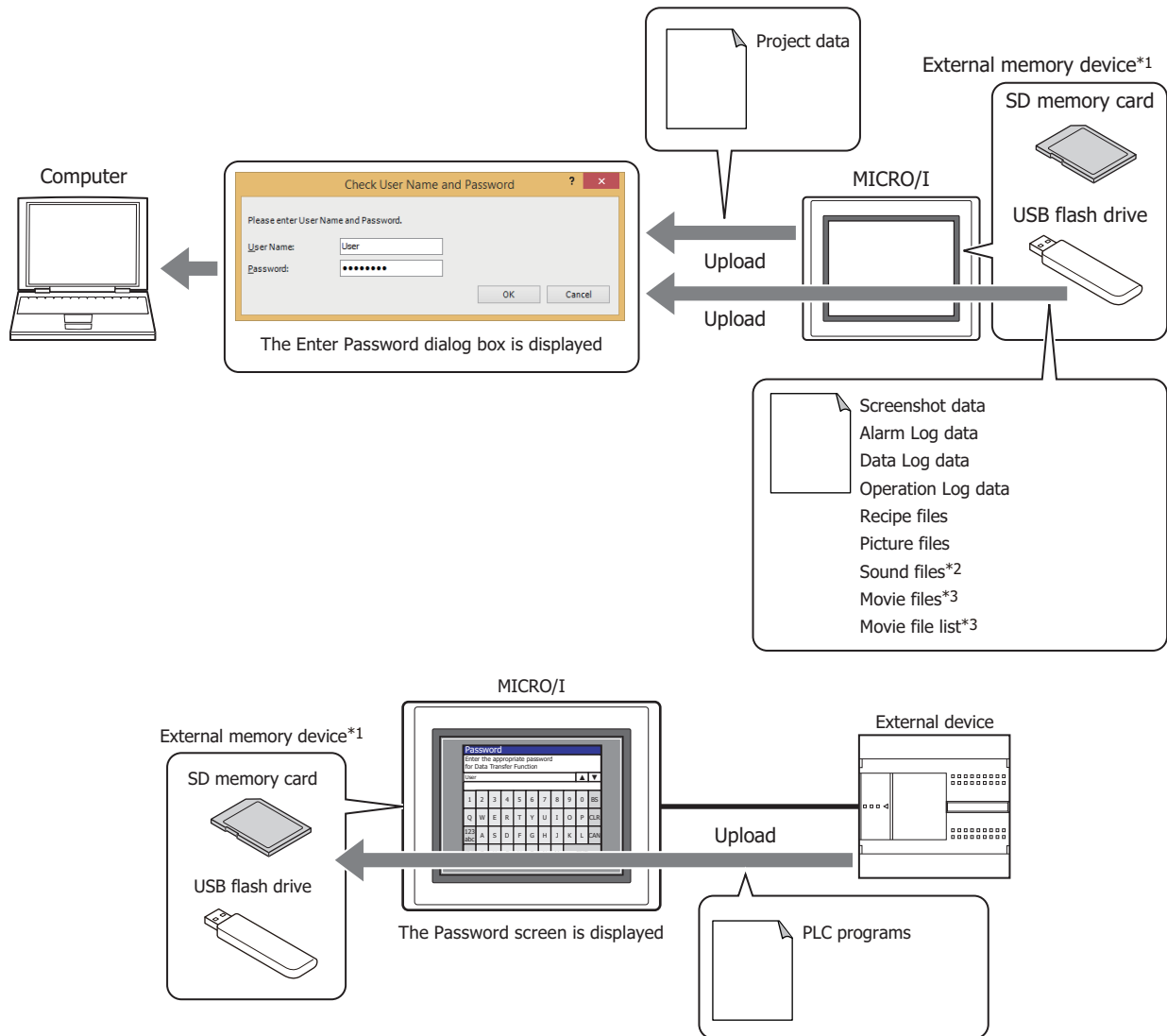

- Protect from data erasures and formatting*5 external memory device*4 by unauthorized access

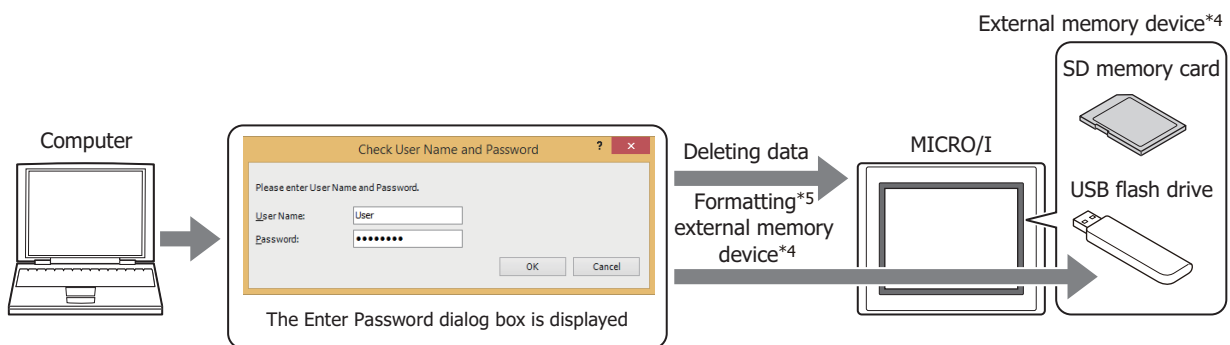

*1 USB flash drive inserted in USB1 for HG2J-7U, SD memory card for HG5G/4G/3G/2G-V, HG4G/3G and HG2G-5F, USB flash drive for HG2G-5T and HG1G/1P
 *2 This is applicable for HG2J-7U and models with an audio interface only.
 *3 This is applicable for models with a video interface only.
 *4 SD memory card for HG5G/4G/3G/2G-V, HG4G/3G and HG2G-5F, USB flash drive for HG2G-5T and HG1G/1P
 *5 HG5G/4G/3G/2G-V, HG4G/3G, HG2G-5F/-5T, HG1G/1P only

- Protect from alterations and misuse by operating the MICRO/I under the System Mode

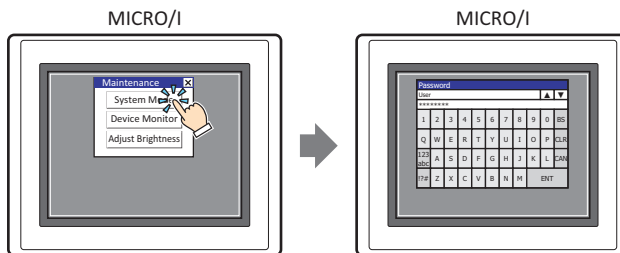

The Password screen is displayed

- Protect from unauthorized browsing by displaying Device Monitor

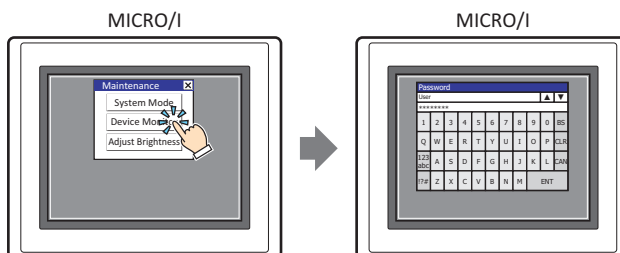

The Password screen is displayed

- Protect from the loss of data by copying*7 files between external memory devices*6

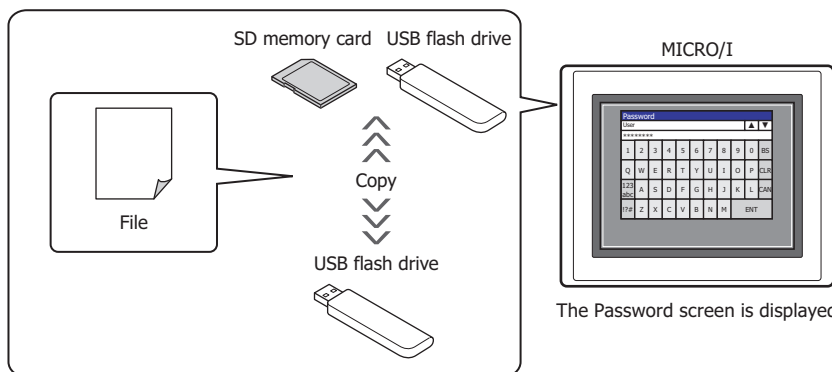

The Password screen is displayed

- Protect from the loss of data or alterations by the execution of the USB Autorun function

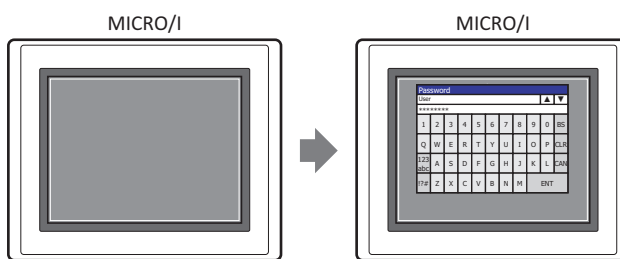

The Password screen is displayed

*6 Between USB flash drives inserted in USB1 and USB2 for HG2J-7U, between SD memory card and USB flash drive for HG5G/4G/3G/2G-V, HG4G/3G and HG2G-5F

*7 HG2J-7U, HG5G/4G/3G/2G-V, HG4G/3G, HG2G-5F only

- Protect from remote unauthorized browsing and unauthorized operations using a web browser terminal on a computer or smartphone.

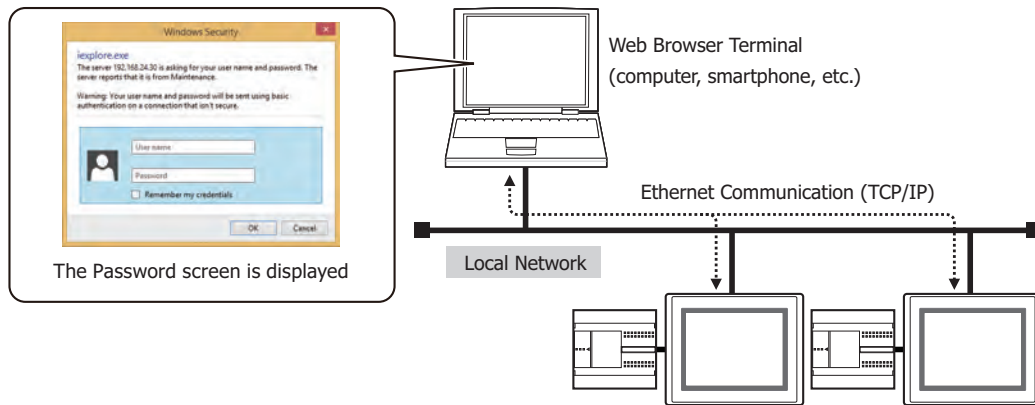

● Provided security groups

There are three types of provided security groups with different security levels: Administrator, Operator, and Reader.

■ Administrator

The Administrator group possesses complete access rights to project data. This security group can execute all necessary operations including editing project data and changing MICRO/I project data. One or more users must be assigned to this group.

■ Operator

The Operator group can partially change project data by changing values of device addresses. This security group download data to external memory device and copy files from USB flash drives to SD memory cards.

■ Reader

The Reader group can read data stored on external memory device, copy files from SD memory cards to USB flash drives, and read values of device addresses with the Web Server function.



The provided user account has the security groups Administrator, Operator, and Reader allocated to it. Passwords have not been configured for this user account. To protect access to data, a password must be configured for the user account.

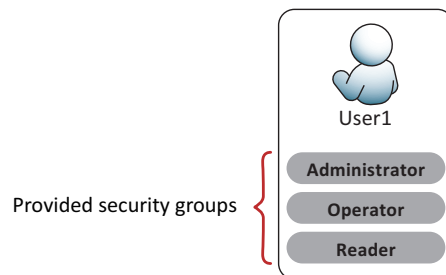

● Operations Subject to Password Protection

If you configure a password for a user account assigned to a security group to protect access to data, access to data is password protected. The operations that are subject to password protection and the security group that the password is valid for are as follows.

Operations subject to password protection		Security group that the password is valid for			
		Administrator	Operator	Reader	User-created
Data editing	Opening projects	YES	NO	NO	YES ^{*1}
Modifying data	Downloading a project data	YES	NO	NO	YES ^{*1}
	Uploading a project data	YES	NO	NO	YES ^{*1}
	Delete data stored in the internal memory	YES	NO	NO	NO
	Downloading files to an external memory device ^{*2}	YES	NO	NO	NO
	Uploading files from an external memory device ^{*2}	YES	YES	YES	NO
	Downloading files to an external memory device ^{*2} while the MICRO/I is running	YES	YES	NO	NO
	Downloading PLC programs from an external memory device to external devices	YES	NO	NO	NO
	Uploading PLC programs from external devices to an external memory device	YES	NO	NO	NO
	Deleting files in external memory device ^{*2}	YES	NO	NO	NO
	Formatting ^{*4} external memory device ^{*3}	YES	NO	NO	NO
	Copying files to a USB1 ^{*5}	YES	YES	NO	NO
	Copying files to a USB2 ^{*5}	YES	YES	YES	NO
	Copying files to an SD memory card ^{*6}	YES	YES	NO	NO
	Copying files to a USB flash drive ^{*6}	YES	YES	YES	NO
	Switching to the System Mode	YES	NO	NO	NO
	Use Monitor Function in WindO/I-NV4 or Device Monitor	YES	YES	NO	NO
	Remotely monitoring the MICRO/I state from a web browser terminal	YES	YES	YES	NO
	Remotely operating the MICRO/I state from a web browser terminal	YES	YES	NO	NO
Displaying and operating the Custom Web page of the MICRO/I from a web browser terminal	*7	*7	*7	*7	



- You can set a dedicated password. In the **Security** dialog box, on the **Options** tab, select the **Use Password to open a Project** check box, and then set the password. The dedicated password is applicable to the following operations:
 - Opening projects
 - Reusing screens
 - Opening projects after uploading project data
- To password protect operations, the lowest level security group out of the security groups enabled with a password must be assigned to a user account. The security levels, from highest to lowest, are Administrator > Operator > Reader. Example: To password protect the operation to display Device Monitor, assign the Operator security group to a user account. If a user account assigned to the Operator security group does not exist, the operation is not password protected.
- The commands that the USB Autorun function can execute vary based on the enabled security group. For details, refer to Chapter 31 "2.4 USB Autorun Function Security" on page 31-34.

*1 Switch between **Permitted** and **Prohibited** in the **Security Settings** dialog box.

*2 USB flash drive inserted in USB1 for HG2J-7U, SD memory card for HG5G/4G/3G/2G-V, HG4G/3G and HG2G-5F, USB flash drive for HG2G-5T and HG1G/1P

*3 SD memory card for HG5G/4G/3G/2G-V, HG4G/3G and HG2G-5F, USB flash drive for HG2G-5T and HG1G/1P

*4 HG5G/4G/3G/2G-V, HG4G/3G, HG2G-5F/-5T, HG1G/1P only

*5 HG2J-7U only

*6 HG5G/4G/3G/2G-V, HG4G/3G, HG2G-5F only

*7 It depends on the settings in Security Settings dialog box. For details, refer to "Web Page Tab" on page 23-42.

1.3 Protecting Displays and Operations

● Displays and Operations that can be Protected with the Security Function

Security groups can be assigned to users to protect MICRO/I displays and operations. These groups are capable of the following actions.

- Protecting the display of screens

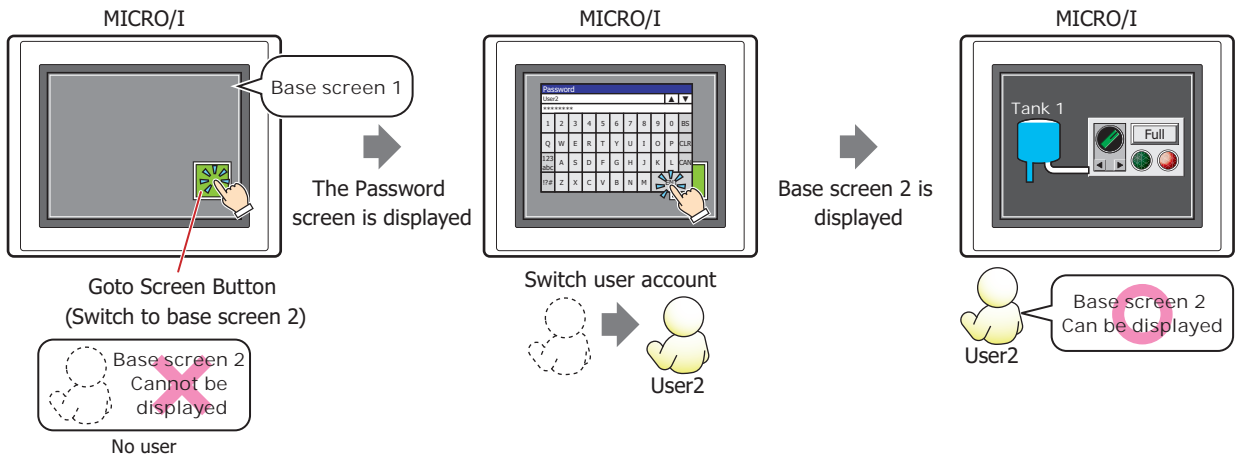

- Protecting the display of parts

Line Chart that can only be displayed with User2

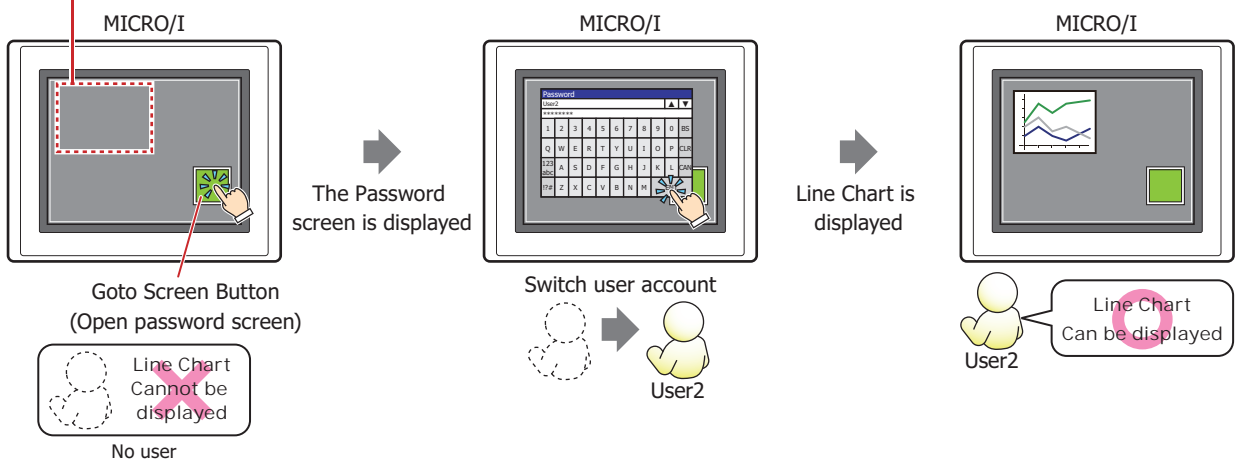

- Protecting the operation of parts

Numerical Input that can only be operated by User2

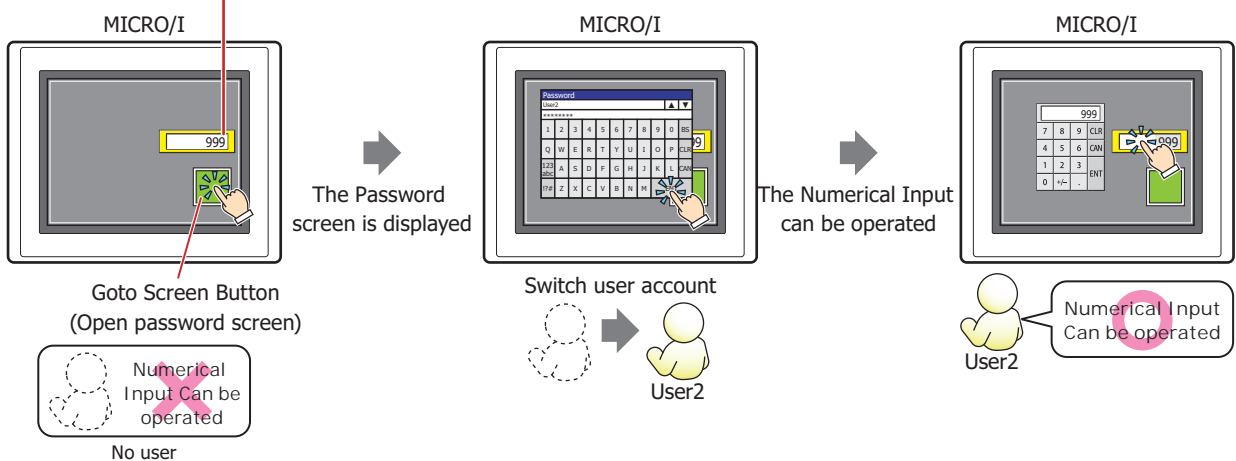



● Protect MICRO/I Displays and Operations

The user accounts that can display and operation screens and parts are only those assigned to the same security group as the security group to which **Permitted** privileges have been set for the display and operation of screens and parts.

Privileges to display and operation screens and parts are configured on the **Security** tab in the properties dialog box of those screens and parts.

Usage privileges can be configured only for parts with an input function.

Example: If the user and security group for the part are set as follows:

User Name	 User2	 User3	 User4
Security Group	GroupA	Administrator, GroupA	Administrator

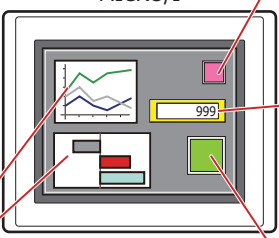

Default user: None

Goto Screen Button (Open password screen)

No.	Group Name	Display	Input
1	Administrator	Permitted	Permitted
2	Operator	Permitted	Permitted
3	Reader	Permitted	Permitted
4	GroupA	Permitted	Permitted

Numerical Input

No.	Group Name	Display	Input
1	Administrator	Permitted	Permitted
2	Operator	Permitted	Permitted
3	Reader	Permitted	Permitted
4	GroupA	Permitted	Prohibited

Line Chart and Bar Chart

No.	Group Name	Display
1	Administrator	Prohibited
2	Operator	Permitted
3	Reader	Permitted
4	GroupA	Permitted

Button

No.	Group Name	Display	Input
1	Administrator	Prohibited	Permitted
2	Operator	Permitted	Permitted
3	Reader	Permitted	Permitted
4	GroupA	Permitted	Prohibited

If no user account has been selected, the parts that can be displayed and used are only those for which all security groups have been set to **Permitted**.

If the password screen is opened and the user switches to User2 in GroupA, the parts for which **Display** has been set to **Permitted** for GroupA are displayed. The parts for which **Input** has been set to **Prohibited** for GroupA cannot be used.

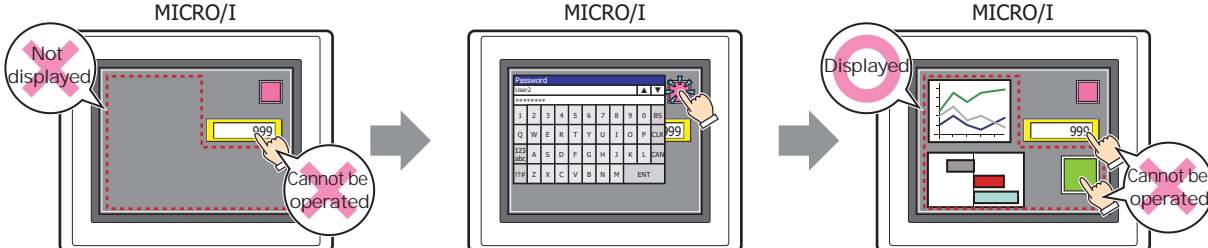

Stage 1: If no user is selected, only parts for which Display has been set to Permitted for all security groups are displayed and only parts for which Input has been set to Permitted for all security groups can be used.

Stage 2: Open the password screen with the Goto Screen Button, enter the password, and switch to User2.

Stage 3: For User2, parts for which Display has been set to Permitted for GroupA are displayed, but parts for which Input has been set to Prohibited for GroupA cannot be used.

If the password screen is opened and the user switches to User3 in Administrator and GroupA, the parts for which Display has been set to Permitted for GroupA will be displayed, and the parts for which Input has been set to Permitted for Administrator can be used.

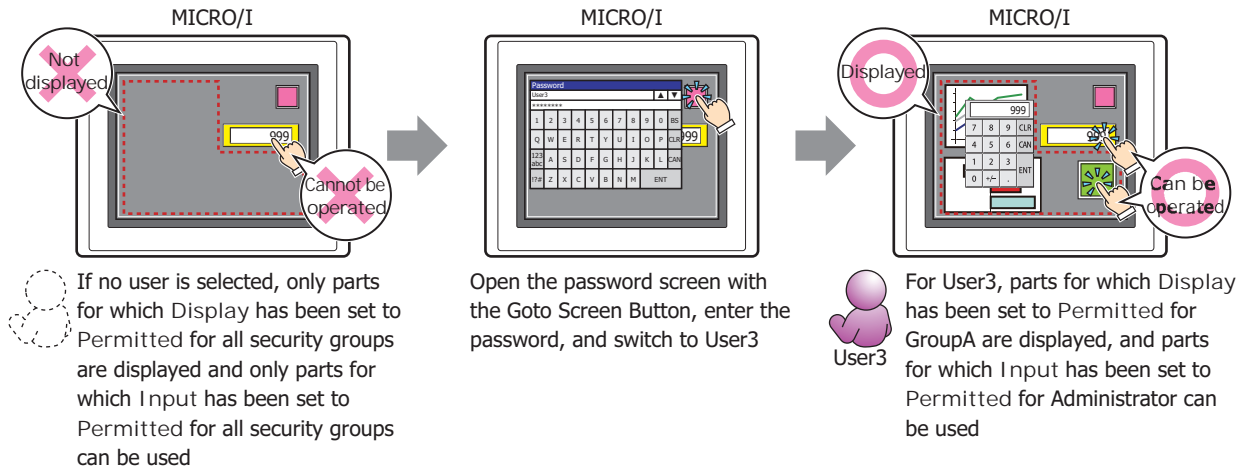

Parts that are not displayed on the screen cannot be operated regardless of the input security group.

If the password screen is opened and the user switches to User4 in Administrator, the displayed parts for which **Input** has been set to **Permitted** for Administrator can be used. Parts for which **Display** has been set to **Prohibited** for Administrator are not displayed.

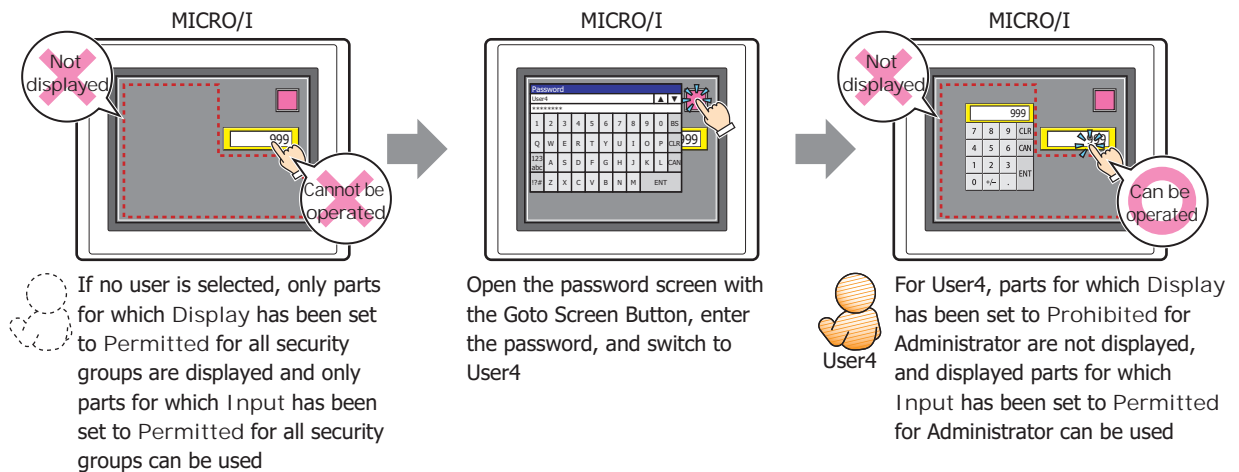

GroupA is not configured for User4, so the button in the lower right of the screen is not displayed. Parts that are not displayed on the screen cannot be used, even by users in a security group for which **Input** has been set to **Permitted**.

2 Security Function Configuration Procedure

HG2J-7U HG5G-V HG4G-V HG4G HG3G-V HG3G HG2G-V HG2G-5F HG2G-5T HG1G HG1P

This section describes the configuration procedure for the Security function.

2.1 Creating and Editing User Accounts

● Creating a User Account

- 1 On the **Configuration** tab, in the **Protect** group, click **User Accounts**.

The **Security** dialog box is displayed.

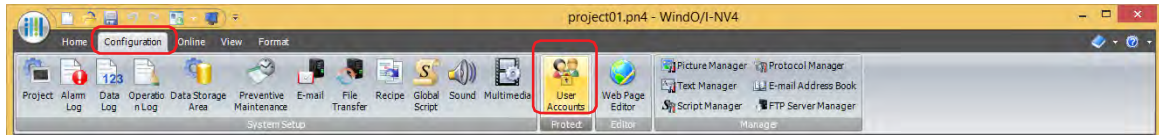

- 2 Select the **Use Security functions** check box.

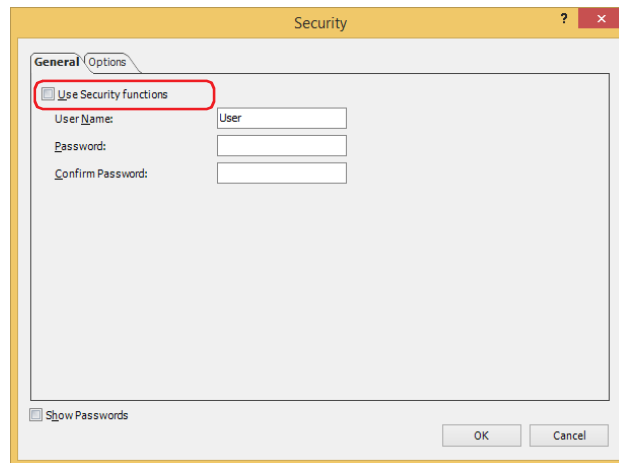

The settings related to user accounts are displayed.

The user account already provided with WindO/I-NV4 is as follows.

No.:	1
User Name:	User
Password:	(blank)
Security Group:	Administrator, Operator, Reader

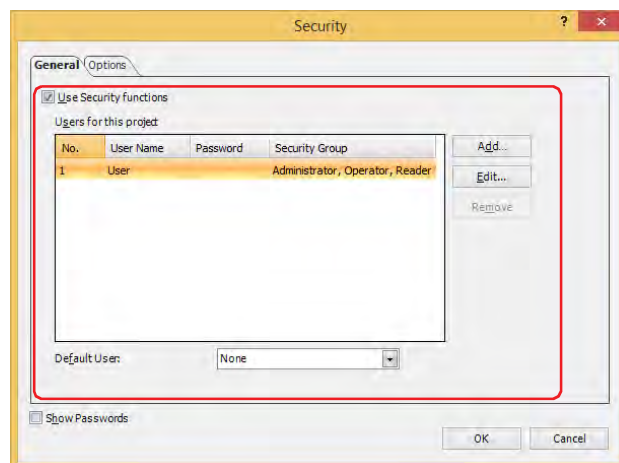

- 3 Click **Add**.
The **New User Account** dialog box is displayed.

4 Specify the user number (1 to 15) in **Number**

This number is used when switching the user account via the value of device address.

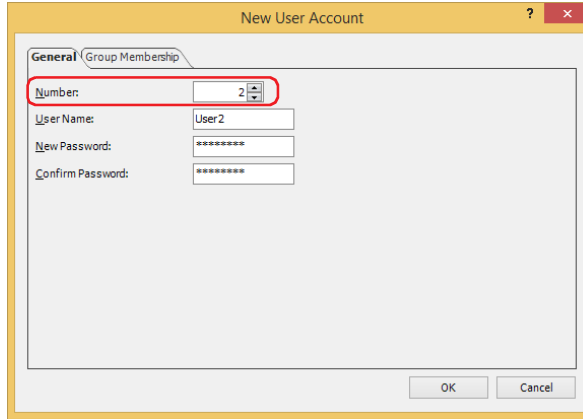

5 Enter the name for the new user in **User Name**.

The maximum number for the user name is 16 characters. Only alphanumeric characters and symbols can be used.



- You cannot use the following characters in the user name.
" * . / : < > ? \ |
- For the HG2J-7U, do not set # at the beginning of the user name. User names start with # will prevent access to the MICRO/I FTP server.

6 Enter the password in **New Password**.

The number for the password is 4 to 15. Only alphanumeric characters and symbols can be used.



Write down the password so you do not forget it and save that note in a safe place.



To display the content of the password for **New Password** and **Confirm Password**, select the **Show Passwords** check box in the **Security** dialog box.

7 Enter the password in **Confirm Password** that was entered in step 6.

8 Click the **Group Membership** tab.

Assign the security groups to the user being created.

Administrator, **Operator**, and **Reader** have already been provided in **Security Group**.

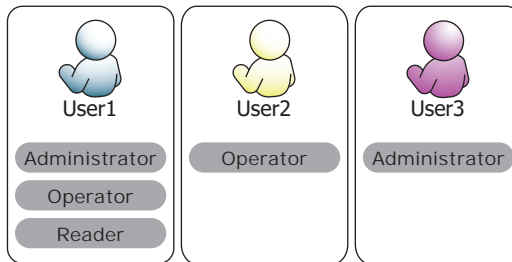

If you will not add a new security group, proceed to step 17.

If you will not assign a security group, proceed to step 18.

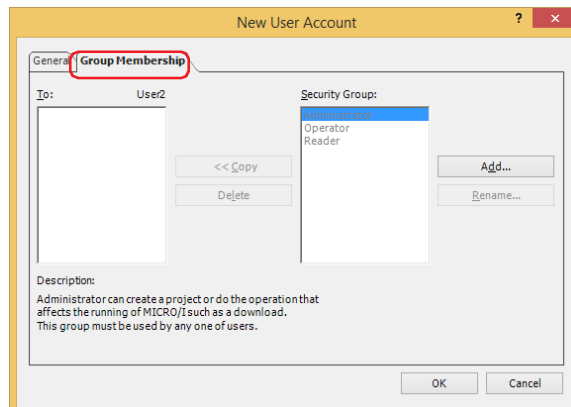

9 Click **Add**.

The **Security Settings** dialog box is displayed.

10 Click **Add**.

The **New Security Group** dialog box is displayed.

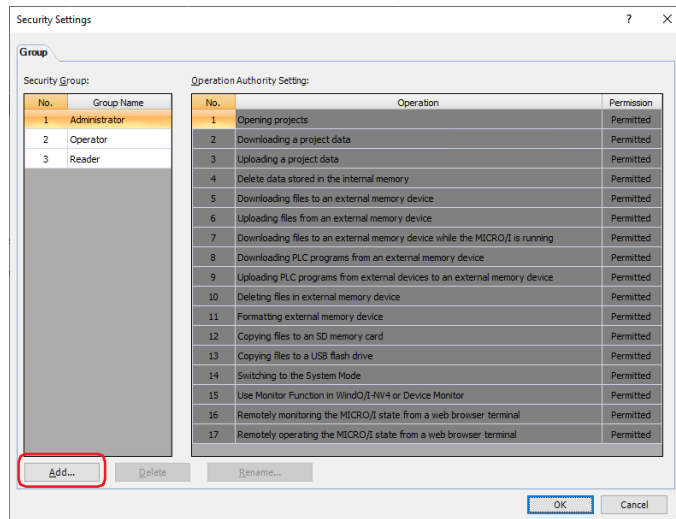
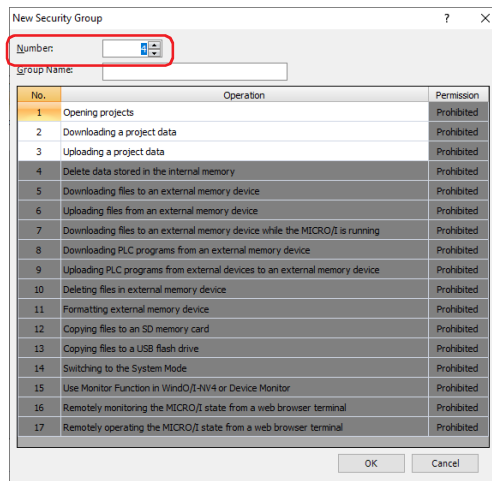
11 Specify the Security Group number (4 to 15) in **Number**.12 Enter the name for the new group in **Group Name**.

The maximum number for the group name is 15 characters.



“なし” (Japanese), “None” (English), and “无” (Chinese) cannot be used for the group name.

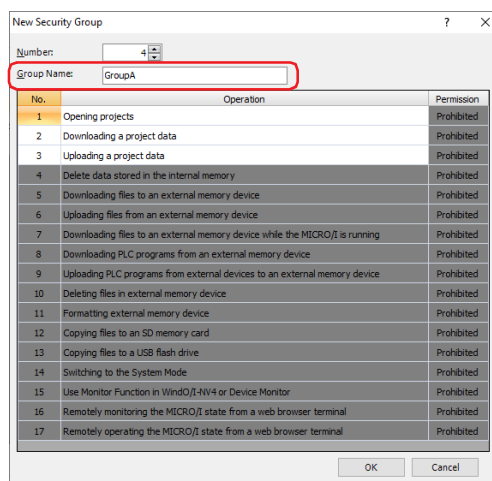

- 13 Under **Permission**, set whether or not to permit the operations subject to password protection in No. 1 to 3. Double clicking the **Permission** cells switches between **Permitted** and **Prohibited**.



Permitted and **Prohibited** cannot be changed for the operations subject to password protection in No. 4 to 15.

No.	Operation	Permission
1	Opening projects	Permitted
2	Downloading a project data	Prohibited
3	Uploading a project data	Prohibited
4	Delete data stored in the internal memory	Prohibited
5	Downloading files to an external memory device	Prohibited
6	Uploading files from an external memory device	Prohibited
7	Downloading files to an external memory device while the MICRO/I is running	Prohibited
8	Downloading PLC programs from an external memory device	Prohibited
9	Uploading PLC programs from external devices to an external memory device	Prohibited
10	Deleting files in external memory device	Prohibited
11	Formatting external memory device	Prohibited
12	Copying files to an SD memory card	Prohibited
13	Copying files to a USB flash drive	Prohibited
14	Switching to the System Mode	Prohibited
15	Use Monitor Function in WindO/I-NV4 or Device Monitor	Prohibited
16	Remotely monitoring the MICRO/I state from a web browser terminal	Prohibited
17	Remotely operating the MICRO/I state from a web browser terminal	Prohibited

- 14 Click **OK**.
The group added is displayed in **Security Group**.

No.	Group Name	No.	Operation	Permission
1	Administrator	1	Opening projects	Permitted
2	Operator	2	Downloading a project data	Prohibited
3	Reader	3	Uploading a project data	Prohibited
4	GroupA	4	Delete data stored in the internal memory	Prohibited
		5	Downloading files to an external memory device	Prohibited
		6	Uploading files from an external memory device	Prohibited
		7	Downloading files to an external memory device while the MICRO/I is running	Prohibited
		8	Downloading PLC programs from an external memory device	Prohibited
		9	Uploading PLC programs from external devices to an external memory device	Prohibited
		10	Deleting files in external memory device	Prohibited
		11	Formatting external memory device	Prohibited
		12	Copying files to an SD memory card	Prohibited
		13	Copying files to a USB flash drive	Prohibited
		14	Switching to the System Mode	Prohibited
		15	Use Monitor Function in WindO/I-NV4 or Device Monitor	Prohibited
		16	Remotely monitoring the MICRO/I state from a web browser terminal	Prohibited
		17	Remotely operating the MICRO/I state from a web browser terminal	Prohibited

- 15 Repeat steps 10 to 14 and create all of the necessary user accounts.
16 Click **OK**.
The group added is displayed in **Security Group**.

To: User2

Security Group:
Administrator
Operator
Reader
GroupA

Description:
GroupA is a group added by user.

- 17 Select the security groups in **Security Group** on the **New User Account** dialog box to assign to the user being created, and then click **<< Copy**.

The security groups are copied to **To**.

The security groups that you create can be used in multiple user accounts.

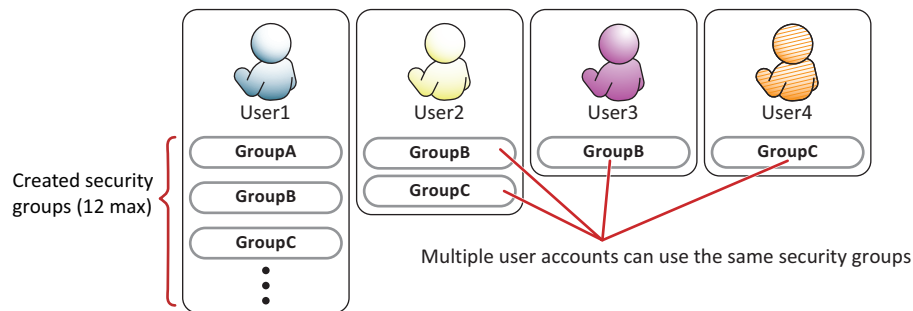

To delete the security groups assigned to the user, select the security groups to delete in **To**, and then click **Delete**.



- To select multiple security groups, press and hold SHIFT or CTRL while you click the specific items.
- Select the security groups in **Security Group** and click **Delete** to delete the security groups. However, security groups configured for user accounts, screens, and parts cannot be deleted.

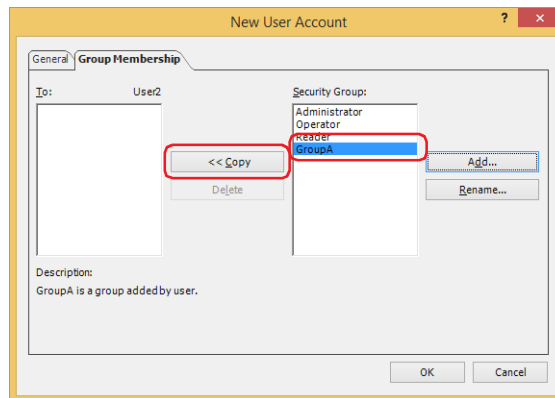

- 18 Click **OK**.

If you will not continue creating a user account, proceed to step 20.

- 19 Repeat steps 3 to 18 and create all of the necessary user accounts.



You can configure a user account to be enabled when the MICRO/I power is turned on and when switching the operation mode in **Default User**.

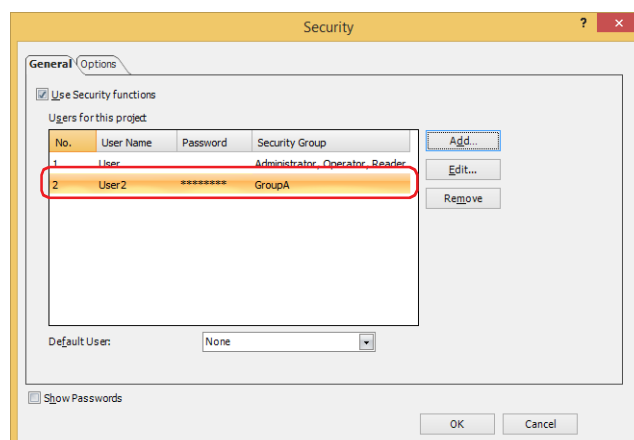

- 20 Click **OK**.

The **Security** dialog box closes.

This concludes creating a user account.

● Editing a User Account

1 On the **Configuration** tab, in the **Protect** group, click **User Accounts**.

The **Security** dialog box is displayed.

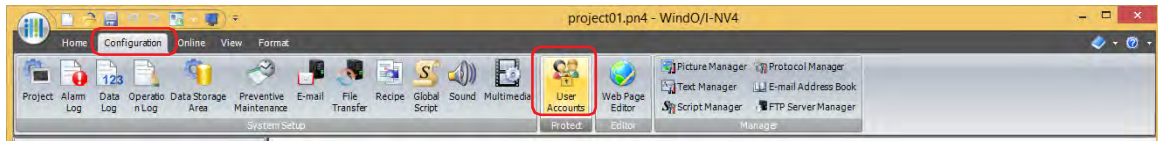

2 Select the user account to edit and click **Edit**.

The **Change User Account** dialog box is displayed.

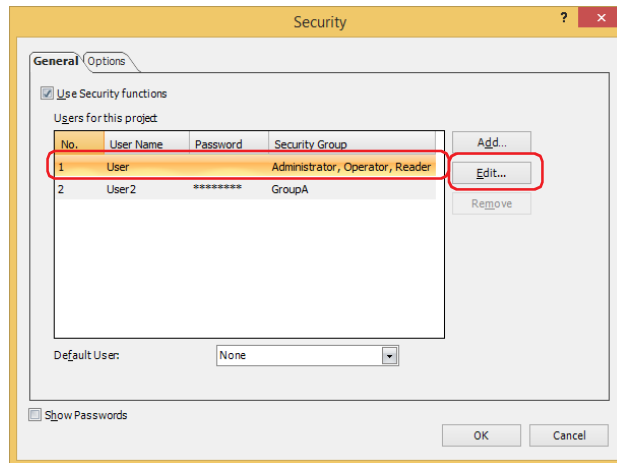

3 On the **General** tab, change **User Name** and **New Password**.

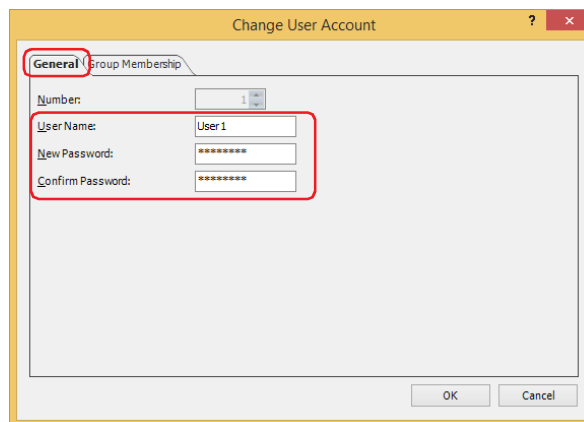

To display the content of the password for **New Password** and **Confirm Password**, select the **Show Passwords** check box in the **Security** dialog box.

4 Enter the password in **Confirm Password** that was entered in step 3.

5 Click the **Group Membership** tab.

Change the security groups assigned to the user.

If you will not assign a security group or you will not delete a security group, proceed to step 7.

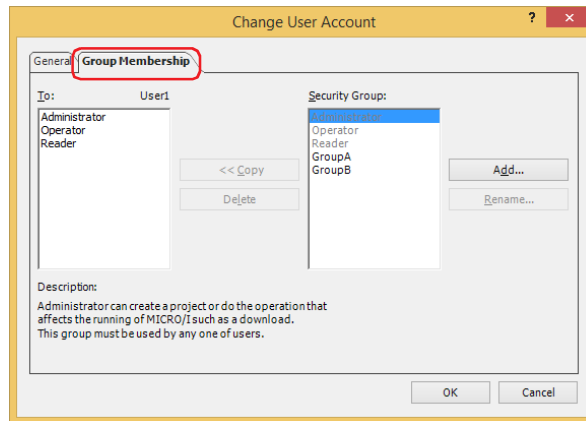

6 Select the security groups in **Security Group** to assign to the user being edited and click **<< Copy**.

The security groups are copied to **To**.

If you will not delete a security group, proceed to step 8.



To select multiple security groups, press and hold SHIFT or CTRL while you click the specific items.

7 Select the security groups assigned to the user to delete in **To** and click **Delete**.

The security groups are deleted from **To**.



- To select multiple security groups, press and hold SHIFT or CTRL while you click the specific items.
- Select the security groups in **Security Group** and click **Delete** to delete the security groups. However, security groups configured for user accounts, screens, and parts cannot be deleted.

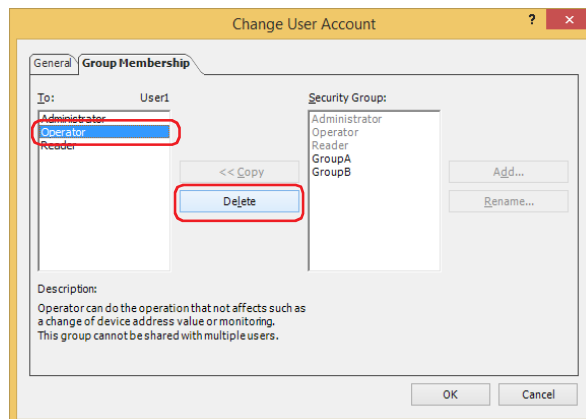

- 8 Click **OK**.

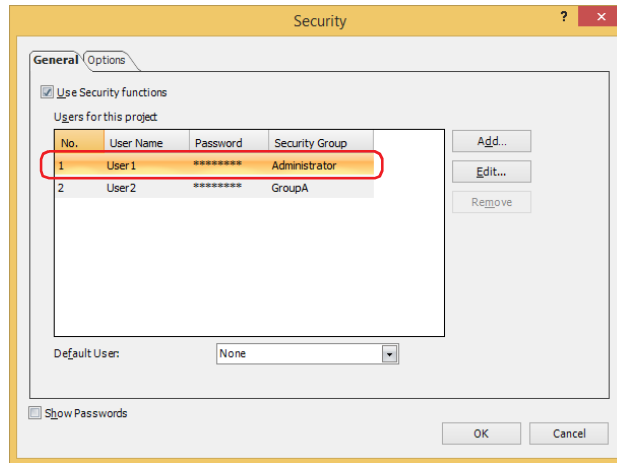

- 9 Click **OK** to close the **Security** dialog box.
This concludes editing a user account.

● Deleting a User Account

- 1 On the **Configuration** tab, in the **Protect** group, click **User Accounts**.
The **Security** dialog box is displayed.

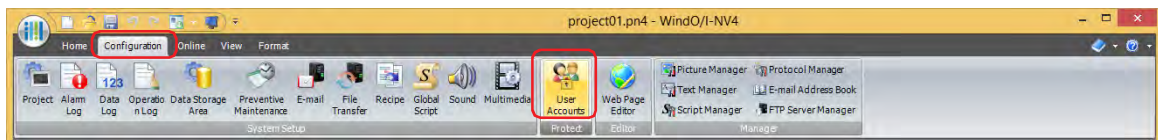

- 2 Select the user account to delete and click **Remove**.
The user account is deleted.

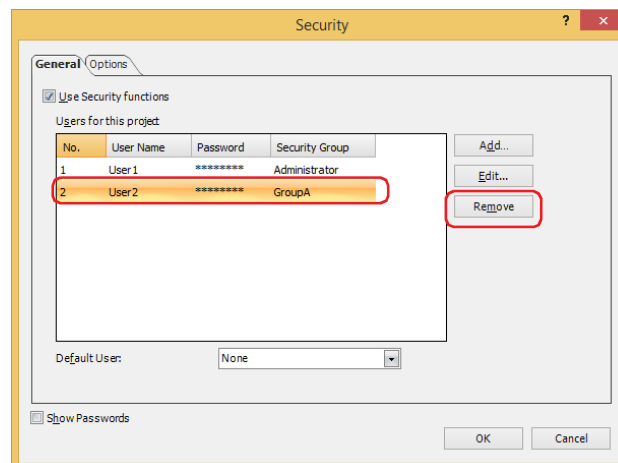

- 3 Click **OK**.
The **Security** dialog box closes.
This concludes deleting a user account.

2.2 Adding and Editing Security Groups

● Adding a Security Group

- 1 On the **Project** window, double click **Security Settings**.

The **Security Settings** dialog box is displayed.

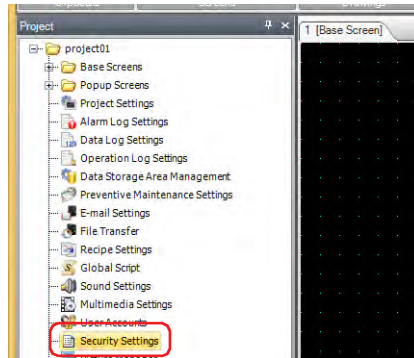

- 2 Click **Add**.

The **New Security Group** dialog box is displayed.

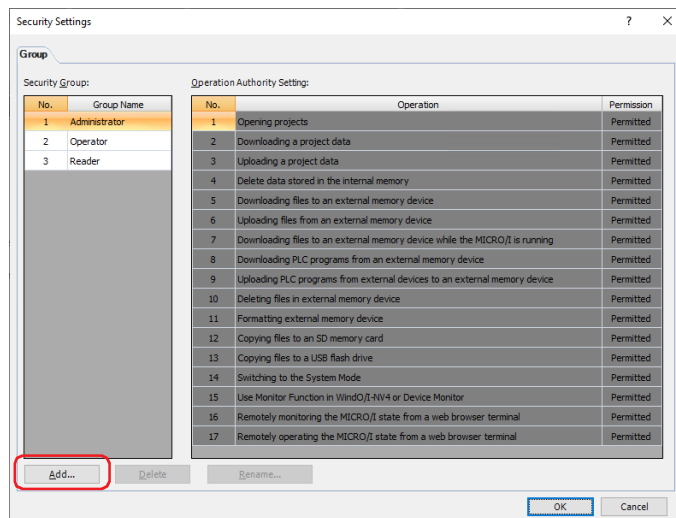

- 3 Specify the Security Group number (4 to 15) in **Number**.

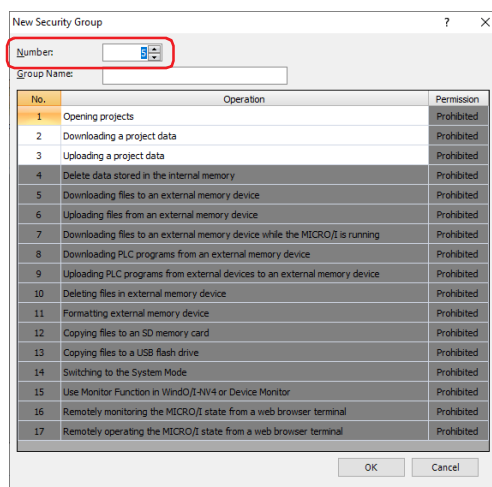

4 Enter the name for the new group in **Group Name**.

The maximum number for the group name is 15 characters.



“なし” (Japanese), “None” (English), and “无” (Chinese) cannot be used for the group name.

No.	Operation	Permission
1	Opening projects	Prohibited
2	Downloading a project data	Prohibited
3	Uploading a project data	Prohibited
4	Delete data stored in the internal memory	Prohibited
5	Downloading files to an external memory device	Prohibited
6	Uploading files from an external memory device	Prohibited
7	Downloading files to an external memory device while the MICRO/I is running	Prohibited
8	Downloading PLC programs from an external memory device	Prohibited
9	Uploading PLC programs from external devices to an external memory device	Prohibited
10	Deleting files in external memory device	Prohibited
11	Formatting external memory device	Prohibited
12	Copying files to an SD memory card	Prohibited
13	Copying files to a USB flash drive	Prohibited
14	Switching to the System Mode	Prohibited
15	User Monitor Function in WindO/I-NV4 or Device Monitor	Prohibited
16	Remotely monitoring the MICRO/I state from a web browser terminal	Prohibited
17	Remotely operating the MICRO/I state from a web browser terminal	Prohibited

5 Under **Permission**, set whether or not to permit the operations subject to password protection in No. 1 to 3.

Double clicking the **Permission** cells switches between **Permitted** and **Prohibited**.



Permitted and **Prohibited** cannot be changed for the operations subject to password protection in No. 4 to 15.

No.	Operation	Permission
1	Opening projects	Permitted
2	Downloading a project data	Permitted
3	Uploading a project data	Permitted
4	Delete data stored in the internal memory	Prohibited
5	Downloading files to an external memory device	Prohibited
6	Uploading files from an external memory device	Prohibited
7	Downloading files to an external memory device while the MICRO/I is running	Prohibited
8	Downloading PLC programs from an external memory device	Prohibited
9	Uploading PLC programs from external devices to an external memory device	Prohibited
10	Deleting files in external memory device	Prohibited
11	Formatting external memory device	Prohibited
12	Copying files to an SD memory card	Prohibited
13	Copying files to a USB flash drive	Prohibited
14	Switching to the System Mode	Prohibited
15	User Monitor Function in WindO/I-NV4 or Device Monitor	Prohibited
16	Remotely monitoring the MICRO/I state from a web browser terminal	Prohibited
17	Remotely operating the MICRO/I state from a web browser terminal	Prohibited

6 Click **OK**.

The group added is displayed in **Security Group**.

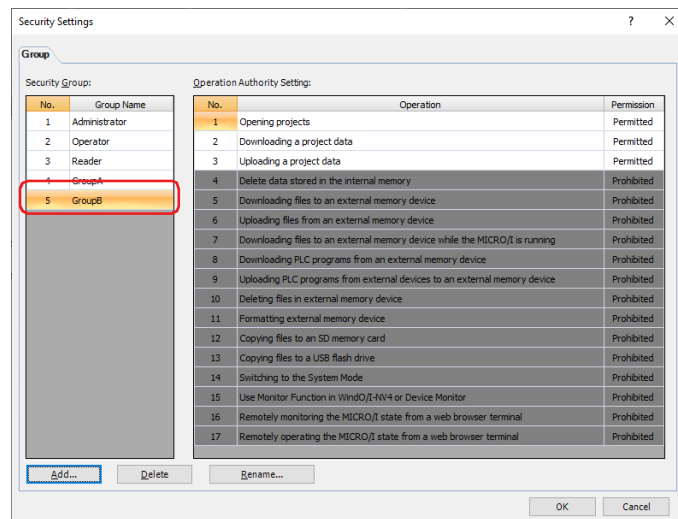
7 Click **OK**.

The **Security Settings** dialog box closes.

This concludes adding a security group.

● Changing the Name of a Security Group

- 1 On the **Project** window, double click **Security Settings**.

The **Security Settings** dialog box is displayed.

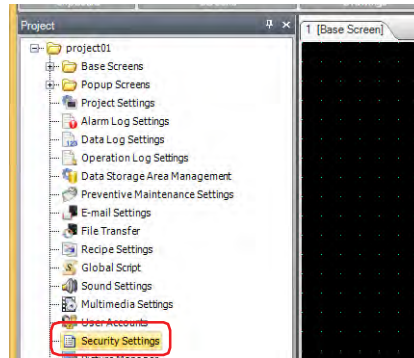

- 2 Select the security group in **Security Group** to change the name of and click **Rename**.
The **Change Security Group Name** dialog box is displayed.



The group name for Administrator, Operator, and Reader cannot be changed.

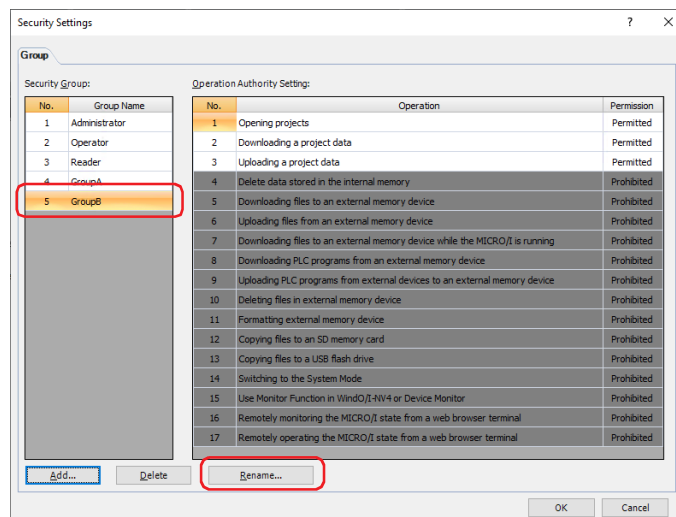

- 3 Change the name of the security group to the new group name in **New Name**.
The maximum number for the group name is 15 characters.



“なし” (Japanese), “None” (English), and “无” (Chinese) cannot be used for the group name.

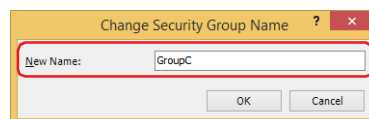

- 4 Click **OK**.
The **Change Security Group Name** dialog box closes.
- 5 Click **OK**.
The **Security Settings** dialog box closes.
This concludes changing the name of a security group.

● Changing the Operation Privileges of a Security Group

1 On the **Project** window, double click **Security Settings**.

The **Security Settings** dialog box is displayed.

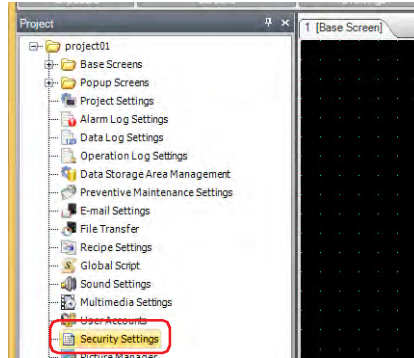

2 Under **Security Group**, select the security group for which the operation privileges will be changed, and under **Permission**, set whether or not to permit the operations subject to password protection in No. 1 to 3.

Double clicking the **Permission** cells switches between **Permitted** and **Prohibited**.



Permitted and **Prohibited** cannot be changed for the operations subject to password protection in No. 4 to 15.

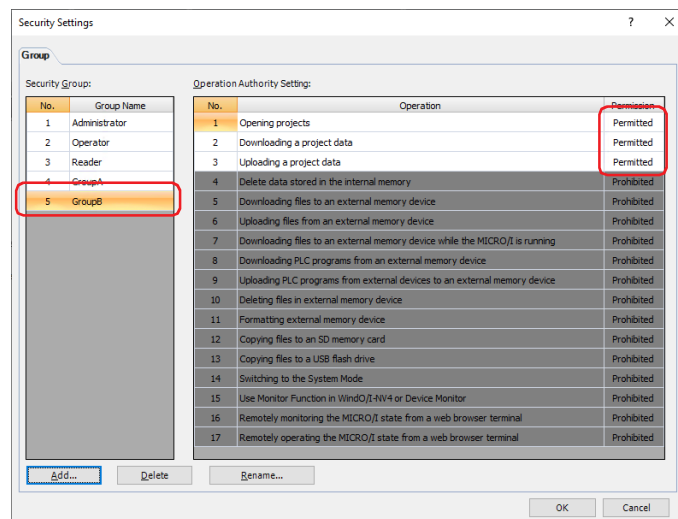

3 Click **OK**.

The **Security Settings** dialog box closes.

This concludes creating a user account.

● Deleting a Security Group

1 On the **Project** window, double click **Security Settings**.

The **Security Settings** dialog box is displayed.

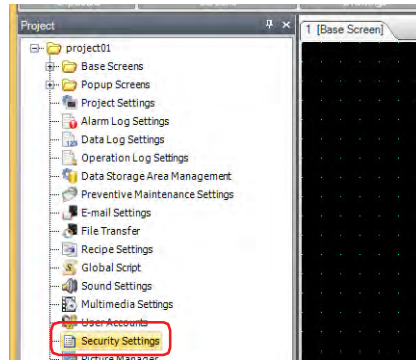

2 Select the security group in **Security Group** to delete and click **Delete**.

The security group is deleted.



To select multiple security groups, press and hold SHIFT or CTRL while you click the specific items.

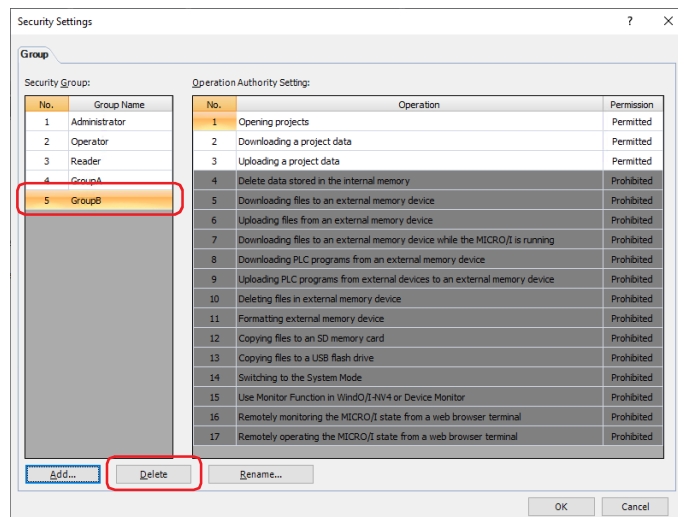

- Security groups configured for user accounts, screens, and parts cannot be deleted.
- Administrator, Operator, and Reader cannot be deleted.

3 Click **OK**.

The **Security Settings** dialog box closes.

This concludes deleting a security group.

2.3 Protecting the Display and Operation of Screens and Parts

● Protecting the Display of Screens

Here you will configure the security group for a screen to protect the display of that screen.

This section describes an example where the display of base screen 2 is protected when switching to base screen 2 by pressing the Goto Screen Button.

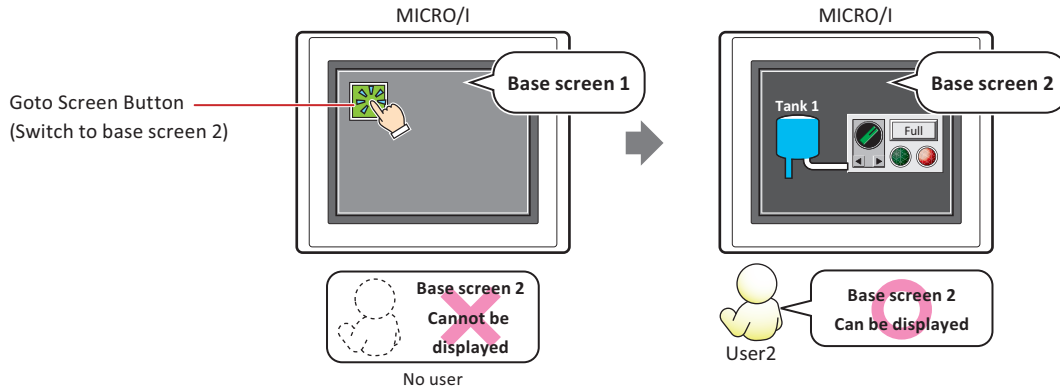

To change the user account, a button or command is required to open the Password screen.

Configuration Procedure

- Following the procedure in "Creating a User Account" on page 23-11, create the following user account.

User Name	 User2
Security Group	GroupA

To automatically display the Password screen when the user attempts to switch to a base screen they cannot access with the current user account using the Goto Screen button, select the **Change Screen** check box and the **Change Screen automatically after entering Password** check box in **Open Password Screen automatically by the following operations** on the **Options** tab of the **Security** dialog box. For displaying the Password screen, refer to "4.1 Entering the Password on the MICRO/I" on page 23-47.

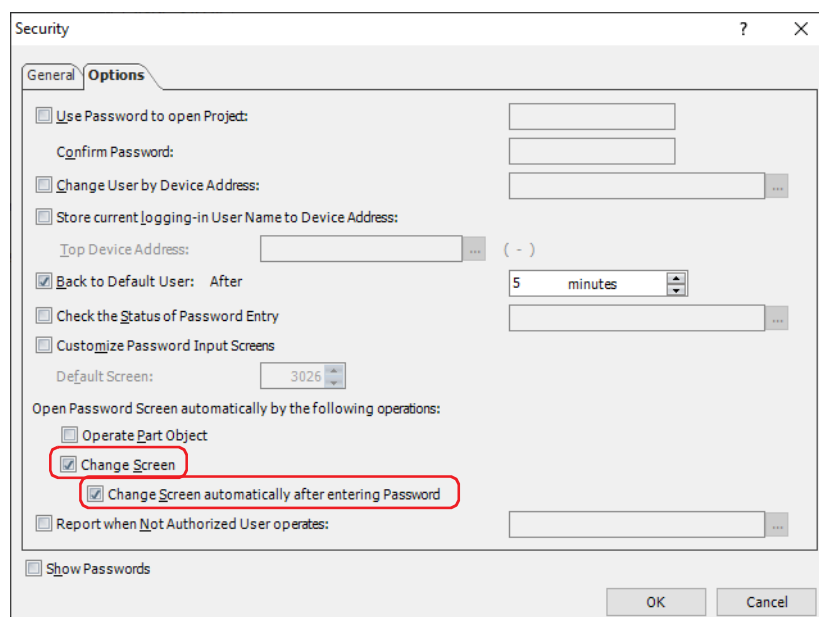

- 2 Place a Goto Screen Button on base screen 1.
On the **Home** tab, in the **Parts** group, click **Buttons**, and then click **Goto Screen Button**.

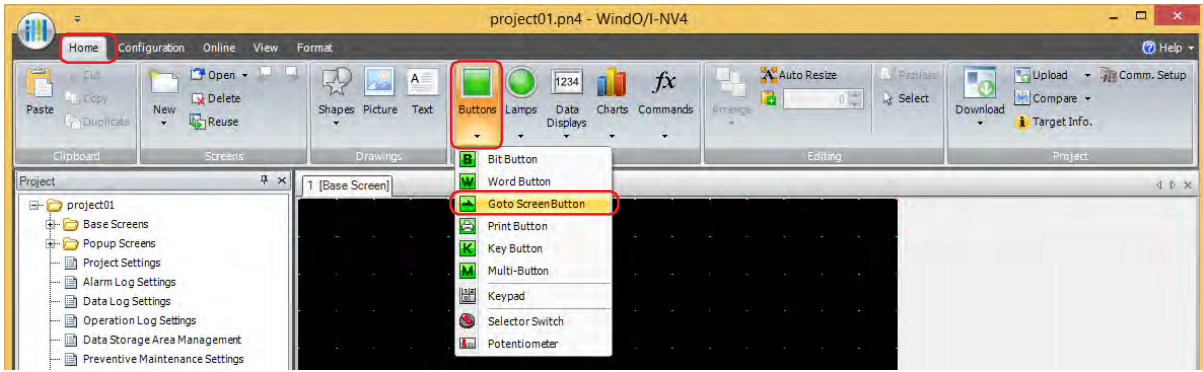

- 3 Click a point on the edit screen where you wish to place the Goto Screen Button.
- 4 Double-click the placed Goto Screen Button and the Properties dialog box is displayed.

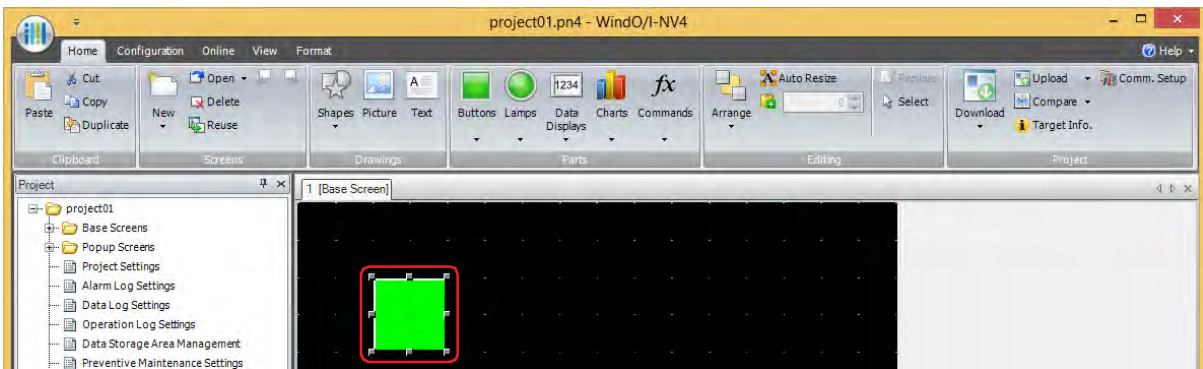

- 5 Select **Switch to Base Screen** for **Action Mode**.

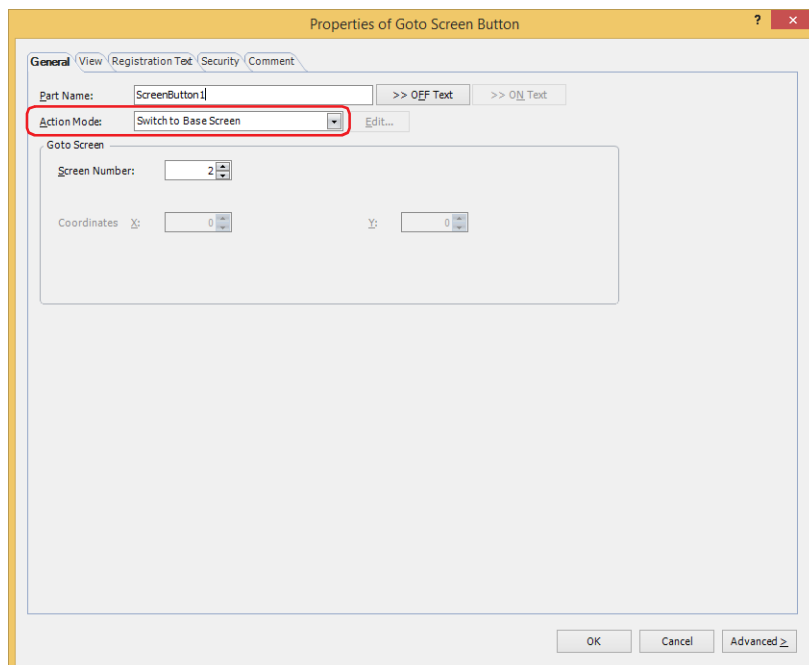

- 6 Specify the screen number of the base screen to switch to with **Screen Number** under **Goto Screen**.
2 is specified here.
- 7 Click **OK**.
Close the Properties of Goto Screen Button dialog box.

- 8 Create the base screen to switch to and configure the security group.
On the **Home** tab, in the **Screens** group, click the arrow under **New**, and then click **Base Screen**.
The Screen Properties dialog box is displayed.

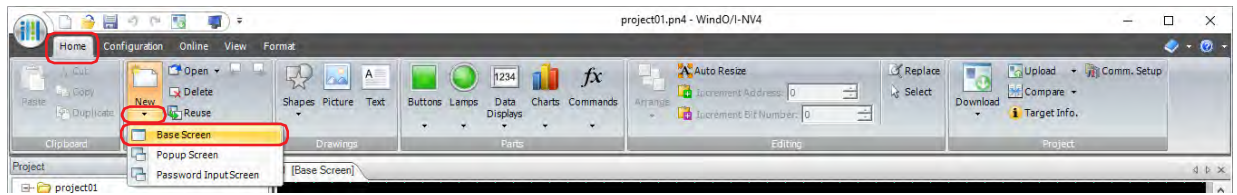

- 9 Specify the screen number of the base screen to switch to with **Number** on the **General** tab.
This is the same screen number as the screen number specified in step 6. 2 is specified here.

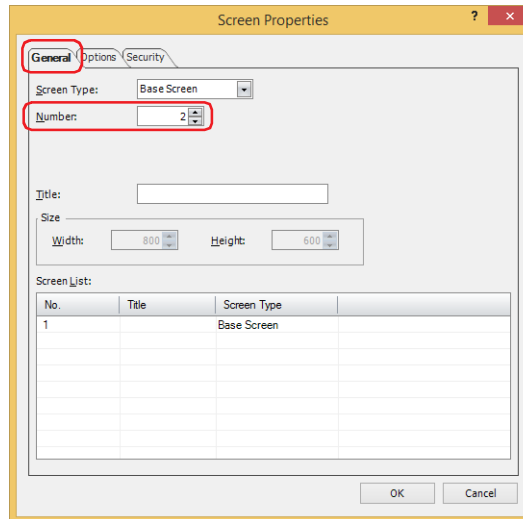

- 10 Click the **Security** tab.

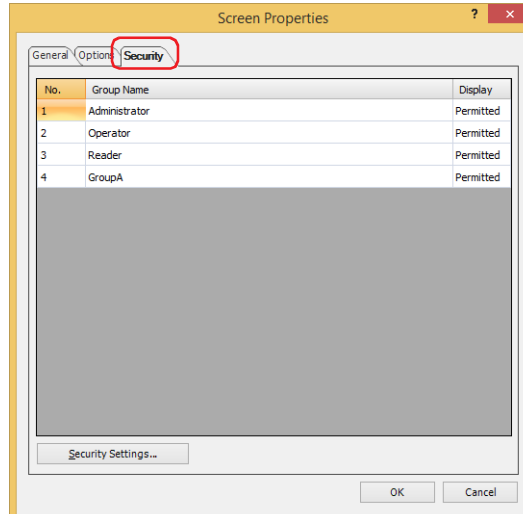

- 11 Change **Display** to **Permitted** for the security group that will be permitted to display the base screen.
Set **Display** to **Permitted** for GroupA.
- 12 Configure the settings on each tab as necessary and click **OK**.
The Screen Properties dialog box closes.
This concludes configuring the project to protect the display of screens.

Operating Procedure

This section describes an example when the current user account has no default user.

- 1 Press the Goto Screen Button configured with **Switch to Base Screen**.

The Password screen is displayed.

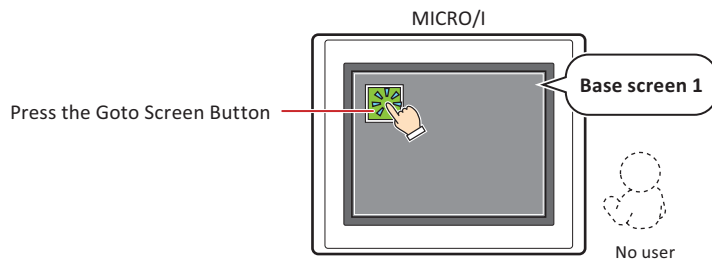

- 2 Press ▼ and select **User2**.

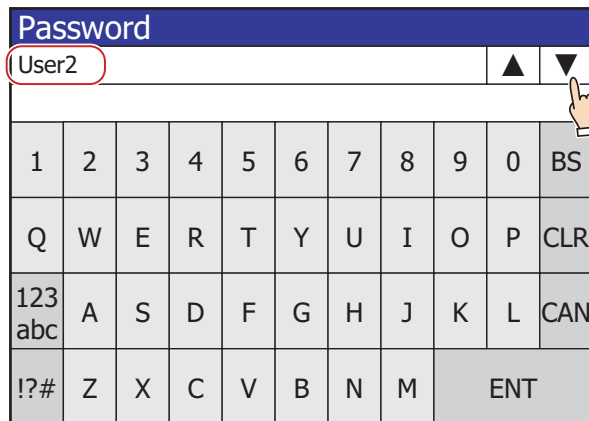

▲ and ▼ buttons are displayed only after you select the **Use Security functions** check box in the Security dialog box.

- 3 Enter the password and press **ENT**.

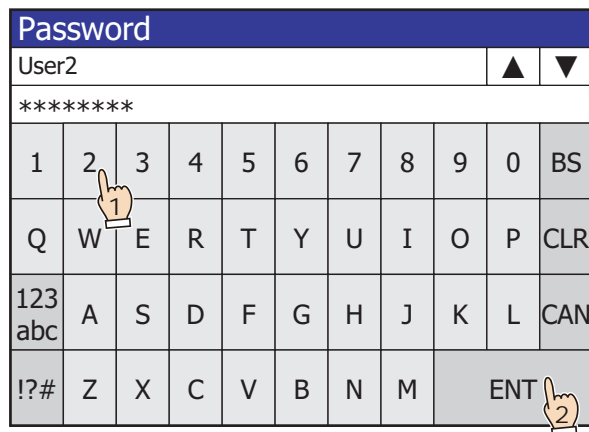

If the correct password is entered, the user account changes to **User2** and the Password screen closes. Base screen 2 is displayed.

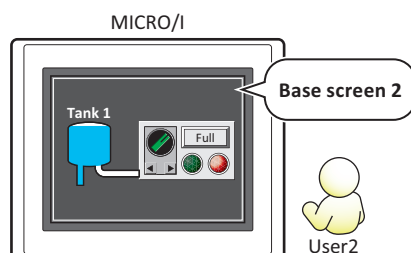

● Protecting the Display of Parts

Here you will configure the security group for a part to protect the display of that part. This section describes an example where the display of the Line Chart is protected.

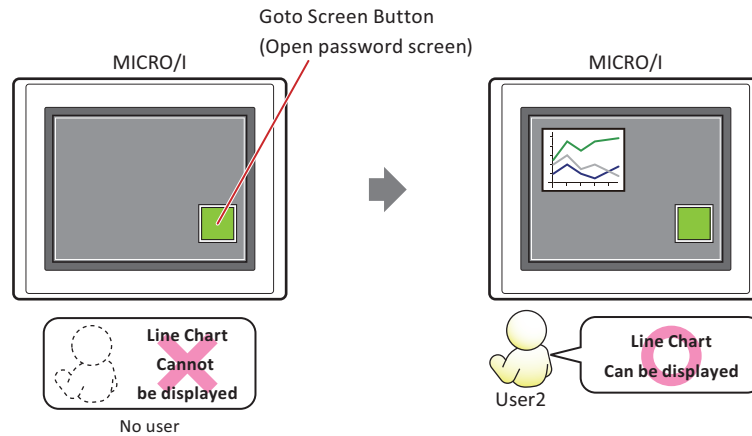

To change the user account, a button or command is required to open the Password screen.

Configuration Procedure

- 1 Following the procedure in "Creating a User Account" on page 23-11, create the following user account.

User Name	 User2
Security Group	GroupA

- 2 Create a Line Chart and configure the display security group. On the **Home** tab, in the **Parts** group, click **Charts**, and then click **Line Chart**.

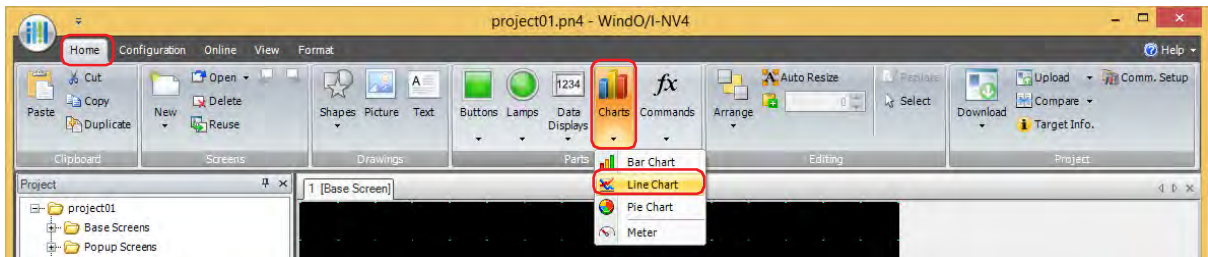

- 3 Click a point on the edit screen where you wish to place the Line Chart.
- 4 Double-click the placed Line Chart and the Properties dialog box is displayed.

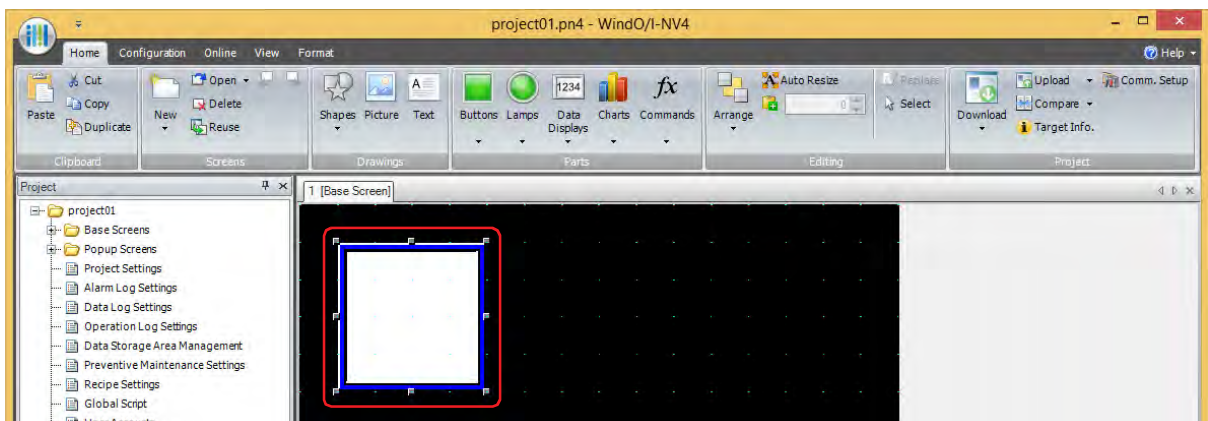

5 Click the **Security** tab.

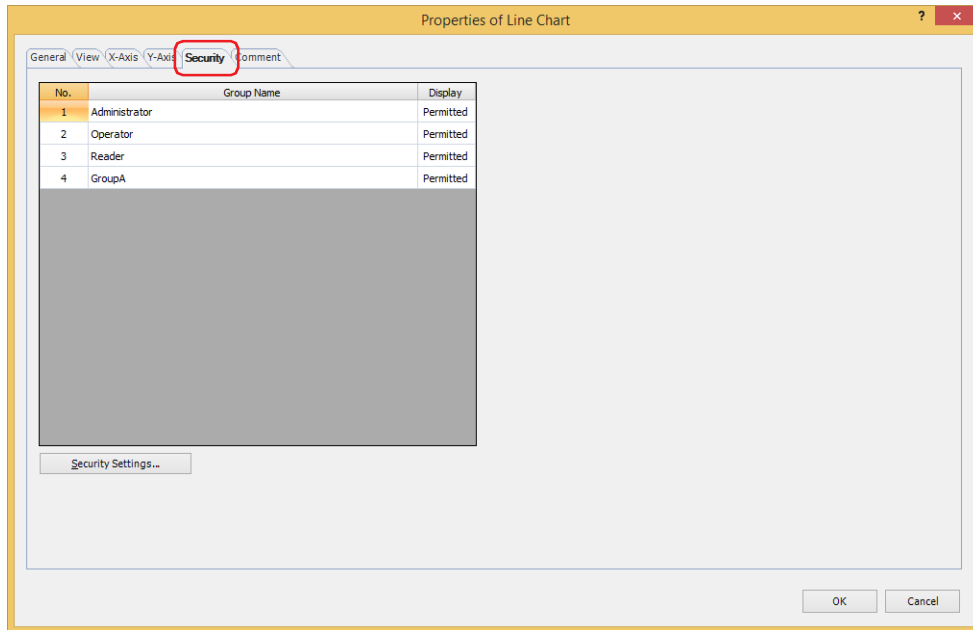

6 Change **Display** to **Permitted** for the security group that will be permitted to display the Line Chart.
Set **Display** to **Permitted** for GroupA.

7 Configure the settings on each tab as necessary and click **OK**.
The Properties of Line Chart dialog box closes.

8 Place a Goto Screen Button to display the password screen on the base screen.
On the **Home** tab, in the **Parts** group, click **Buttons**, and then click **Goto Screen Button**.

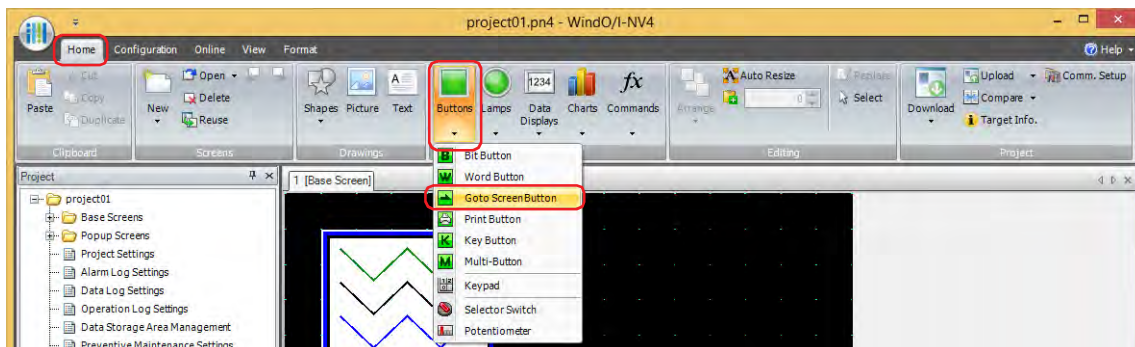

9 Click a point on the edit screen where you wish to place the Goto Screen Button.

- 10 Double-click the placed Goto Screen Button and the Properties dialog box is displayed.

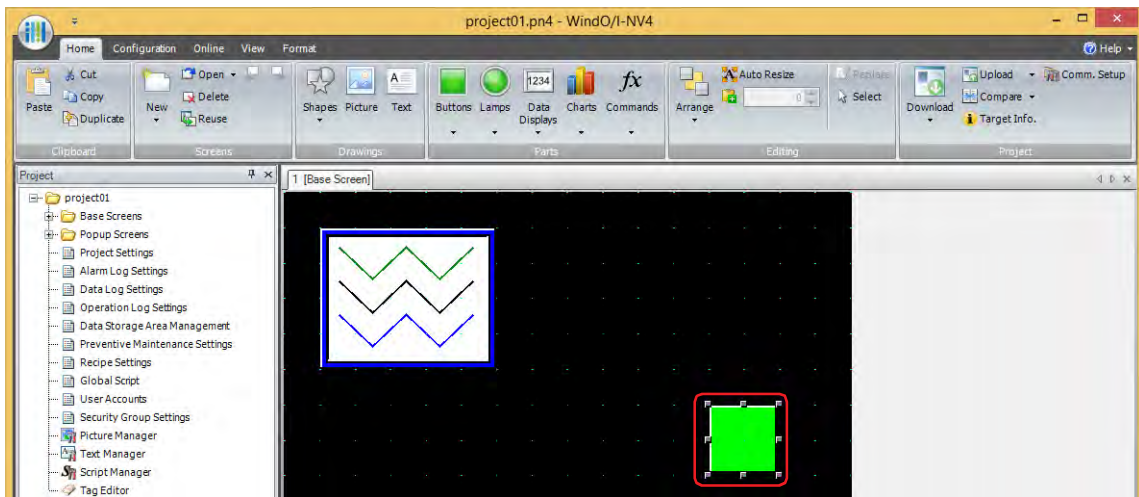

- 11 Select **Open Password Screen** for Action Mode.

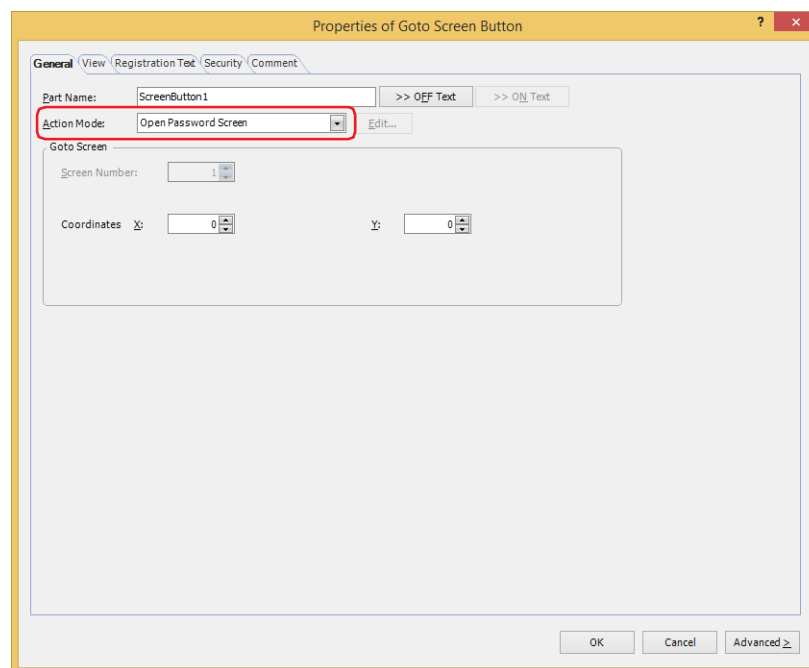

- 12 Specify the display location in coordinates for the password screen to open above the base screen with **Coordinates X, Y**.

With the upper-left corner of the screen as the origin, the upper-left corner of the window is the X and Y coordinates.

X: 0 to (base screen horizontal size - 1)

Y: 0 to (base screen vertical size - 1)

- 13 Click **OK**.

The Properties of Goto Screen Button dialog box closes.

This concludes configuring the project to protect the display of a part.

Operating Procedure

This section describes an example when the current user account has no default user.

- 1 Press the Goto Screen Button configured with **Open Password Screen**.

The Password screen is displayed.

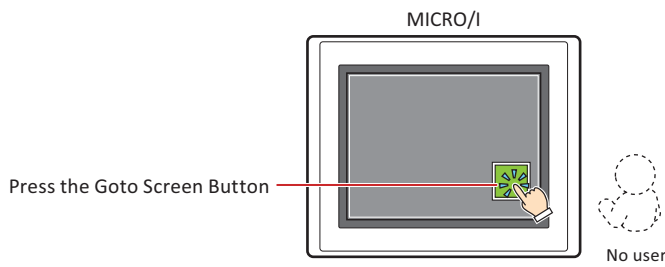

- 2 Press ▼ and select **User2**.

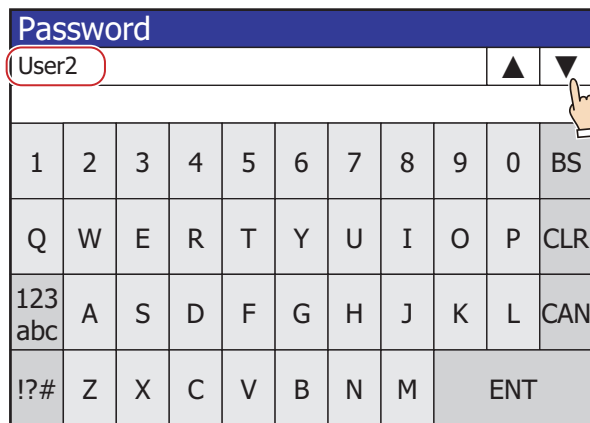

▲ and ▼ buttons are displayed only after you select the **Use Security functions** check box in the Security dialog box.

- 3 Enter the password and press **ENT**.

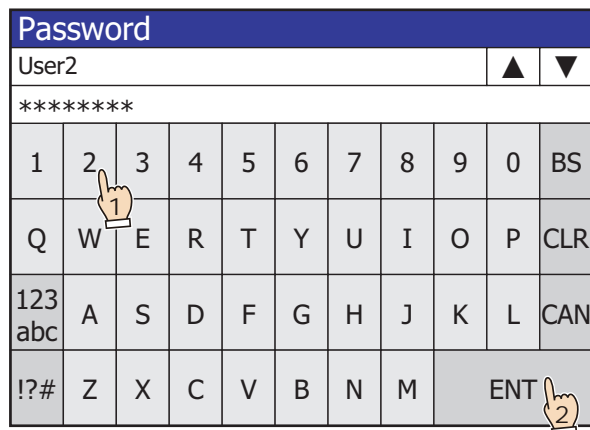

If the correct password is entered, the user account changes to **User2** from no default user and the Password screen closes.

The Line Chart is displayed.

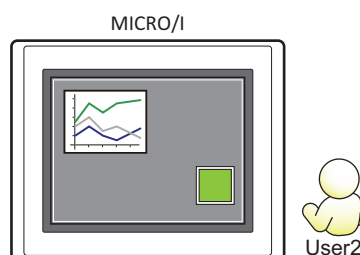

● Protecting the Operation of Parts

Here you will configure the security group for a part to protect the operation of that part. This section describes an example where the operation of the Numerical Input is protected.

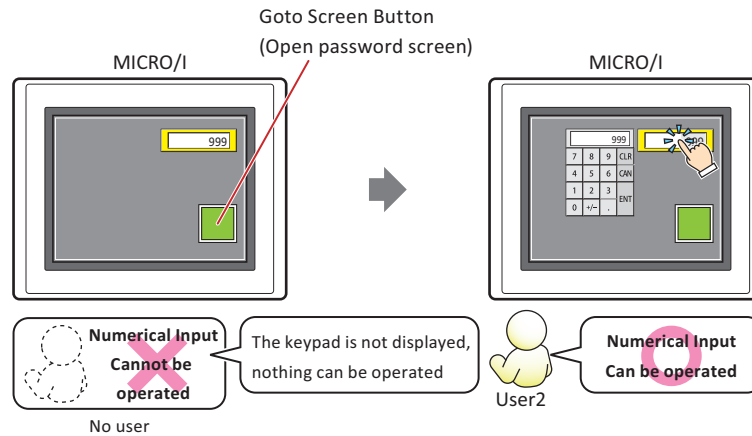

To change the user account, a button or command is required to open the Password screen.

Configuration Procedure

- 1 Following the procedure in "Creating a User Account" on page 23-11, create the following user account.

User Name	 User2
Security Group	GroupA

- 2 Create a Numerical Input and configure the input security group. On the **Home** tab, in the **Parts** group, click **Data Displays**, and then click **Numerical Input**.

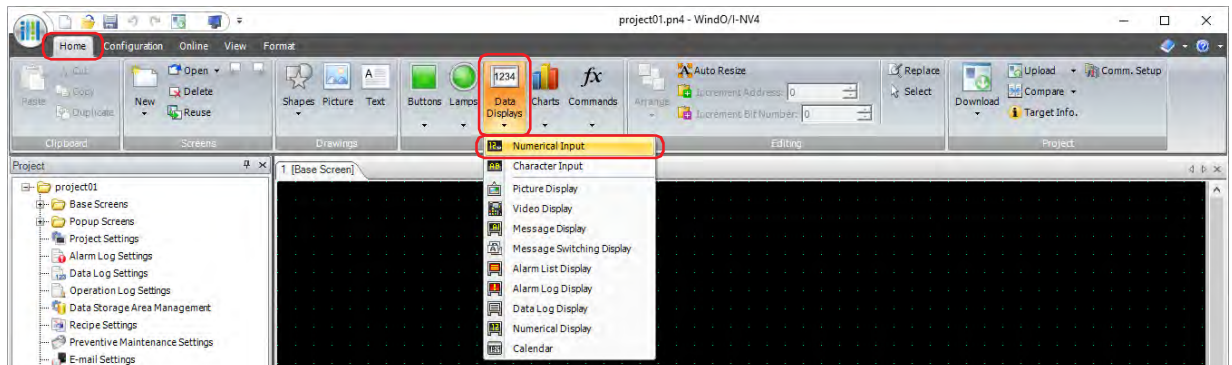

- 3 Click a point on the edit screen where you wish to place the Numerical Input.
- 4 Double-click the placed Numerical Input and the Properties dialog box is displayed.

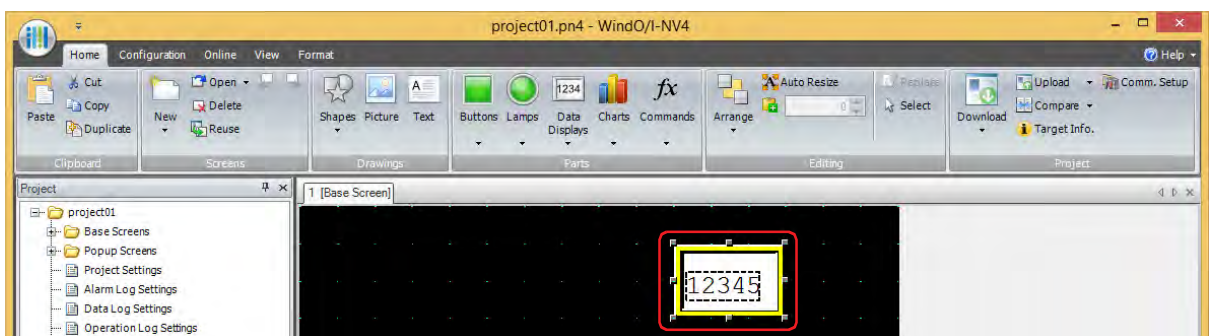

- 5 Click the **Security** tab.

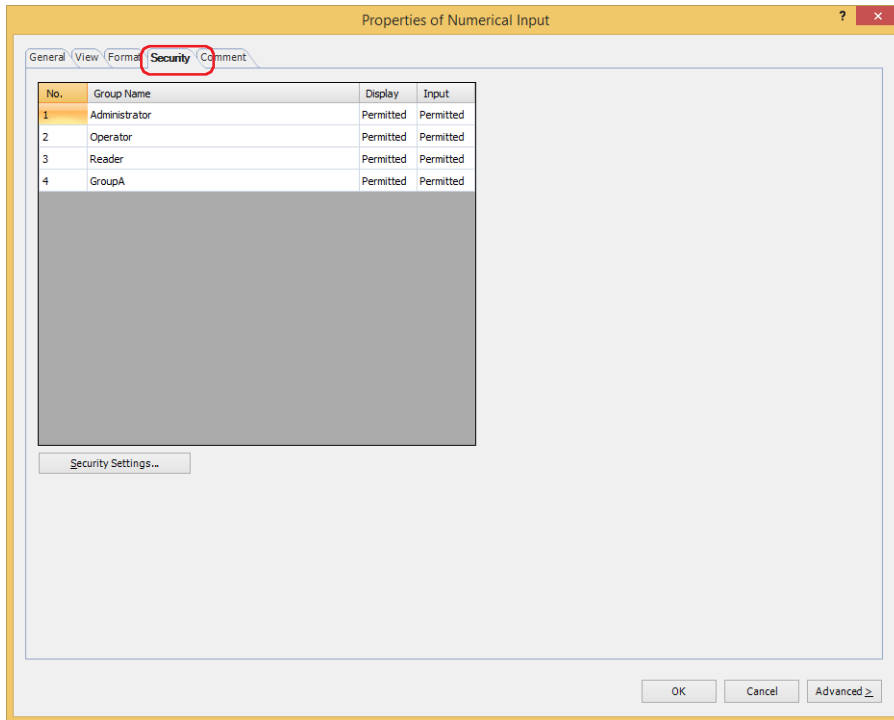

- 6 Change **Input** to **Permitted** for the security group that will be permitted to use the Numerical Input. Set **Input** to **Permitted** for GroupA.
- 7 Configure the settings on each tab as necessary and click **OK**.
The Properties of Numerical Input dialog box closes.
- 8 Place a Goto Screen Button to display the password screen on the base screen. On the **Home** tab, in the **Parts** group, click **Buttons**, and then click **Goto Screen Button**.

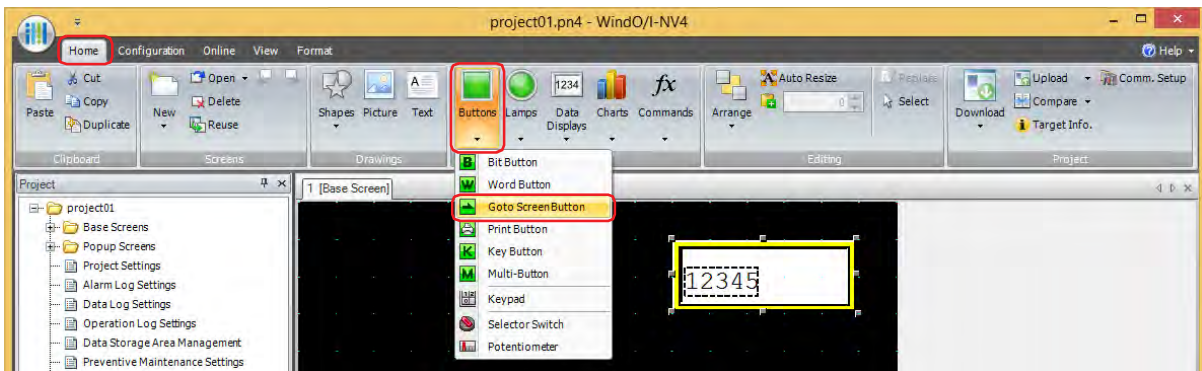

- 9 Click a point on the edit screen where you wish to place the Goto Screen Button.

- 10 Double-click the placed Goto Screen Button and the Properties dialog box is displayed.

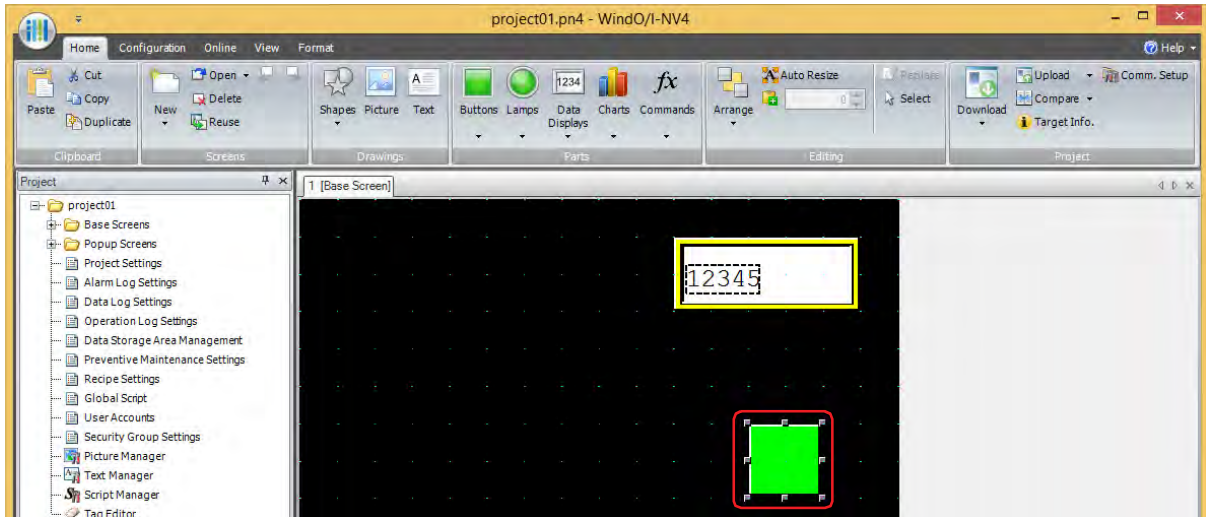

- 11 Select **Open Password Screen** for **Action Mode**.

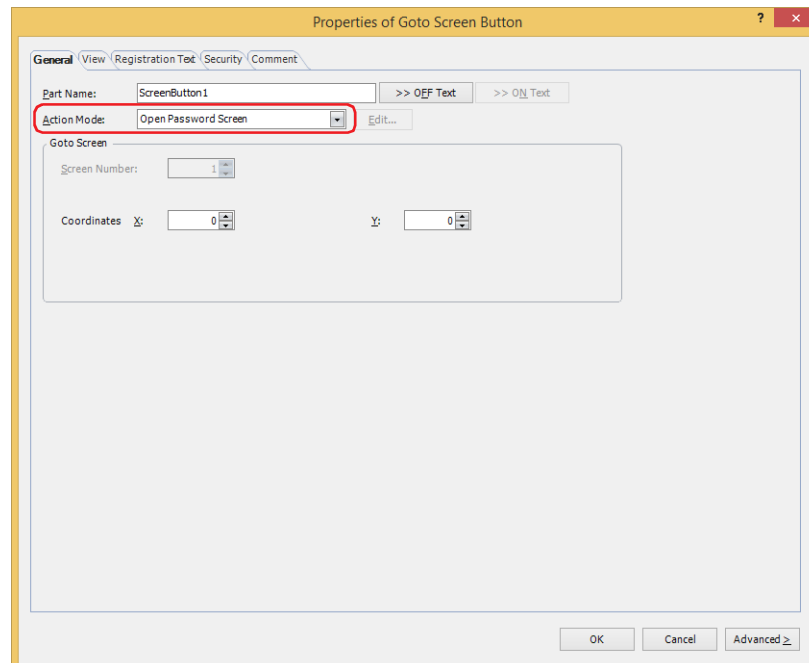

- 12 Specify the display location in coordinates for the password screen to open above the base screen with **Coordinates X, Y**.

With the upper-left corner of the screen as the origin, the upper-left corner of the window is the X and Y coordinates.

X: 0 to (base screen horizontal size - 1)

Y: 0 to (base screen vertical size - 1)

- 13 Click **OK**.

The Properties of Goto Screen Button dialog box closes.

This concludes configuring the project to protect the operation of a part.

Operating Procedure

This section describes an example when the current user account has no default user.

- 1 Press the Goto Screen Button configured with **Open Password Screen**.
The Password screen is displayed.

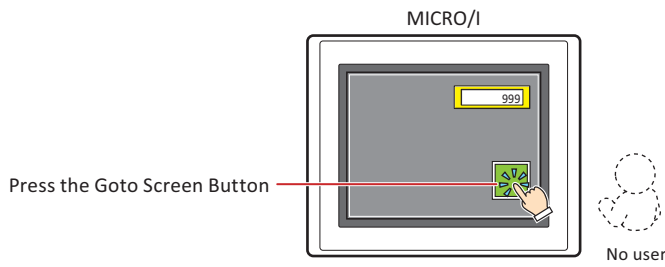

- 2 Press ▼ and select **User2**.

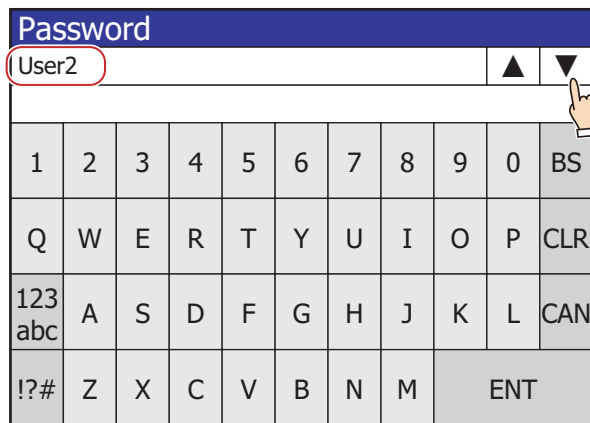

▲ and ▼ buttons are displayed only after you select the **Use Security functions** check box in the Security dialog box.

- 3 Enter the password and press **ENT**.

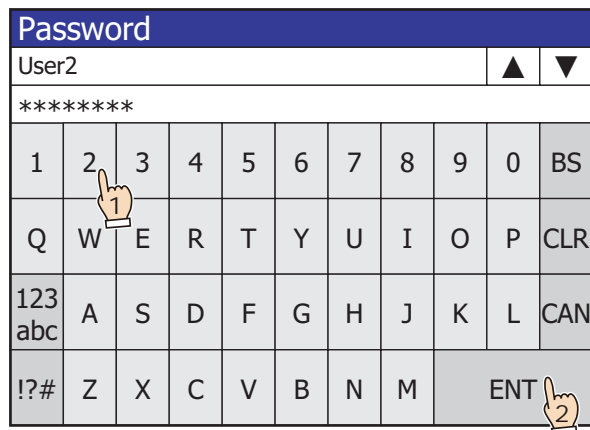

If the correct password is entered, the user account changes to **User2** from no default user and the Password screen closes.

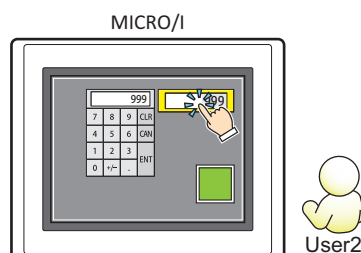

3 Security Dialog Box

HG2J-7U HG5G-V HG4G-V HG4G HG3G-V HG3G HG2G-V HG2G-5F HG2G-5T HG1G HG1P

This section describes items and buttons on the **Security** dialog box.

3.1 Security Dialog Box

The passwords and security groups assigned to user accounts are collectively managed in the **Security** dialog box.

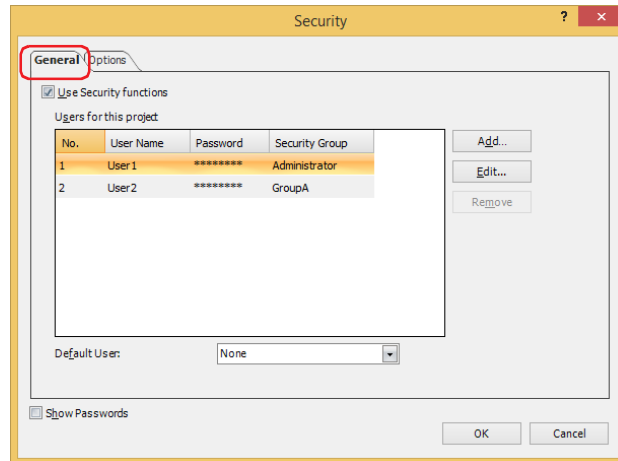

■ Show Passwords

Select this check box to display the characters entered in **Password** under **Users for this project**. When this check box is cleared, the passwords are displayed with * (asterisk).

● General Tab

■ Use Security functions

Select this check box to protect access to data and to protect MICRO/I displays and operations by accounts. The settings related to user accounts are displayed.

When this check box is cleared, the switching to the System Mode, monitor display, or downloading or uploading data are protected by a single password. Note, the MICRO/I is not password protected if **Password** is left blank.



User Name: Enter the name for the user account.

The maximum number for the user name is 16 characters. Only alphanumeric characters and symbols can be used.



- You cannot use the following characters in the user name.
" * . / : < > ? \ |
- For the HG2J-7U, do not set # at the beginning of the user name. User names start with # will prevent access to the MICRO/I FTP server.

Password: Enter the password.

The number of characters for the password is 4 to 15. Only uppercase alphabetic characters and numbers can be used.



Write down the password so you do not forget it and save that note in a safe place.

Confirm Password: Re-enter the same password.
This option is only displayed when the **Show Passwords** check box is cleared.

■ Users for this project

No.: Displays the number (1 to 15) used when switching the user account via the value of device address. Double clicking the cell displays the **Change User Account** dialog box. For details, refer to "New User Account Dialog Box and Change User Account Dialog Box" on page 23-39.

User Name: Displays the name for the user account. Double clicking the cell displays the **Change User Account** dialog box. For details, refer to "New User Account Dialog Box and Change User Account Dialog Box" on page 23-39.

Password: Displays the password of the user account with *(asterisk). Double clicking the cell displays the **Change User Account** dialog box. For details, refer to "New User Account Dialog Box and Change User Account Dialog Box" on page 23-39.
To display the password characters, select the **Show Passwords** check box.

Security Group: Displays all of the security groups for user accounts. Double clicking the cell displays the **Change User Account** dialog box. For details, refer to "New User Account Dialog Box and Change User Account Dialog Box" on page 23-39.

■ Add

This button adds a user account. You can create a maximum of 15. Click this button to display the **New User Account** dialog box. In the **New User Account** dialog box, the user name, password, and security groups are assigned to the user account. For details, refer to "New User Account Dialog Box and Change User Account Dialog Box" on page 23-39.

■ Edit

Select a number in **Users for this project** and click this button to display the **Change User Account** dialog box. In the **Change User Account** dialog box, the user name, password, and security groups are changed. For details, refer to "New User Account Dialog Box and Change User Account Dialog Box" on page 23-39.

■ Remove

This button deletes the user account with the selected number. Select a number and click this button.

■ Default User

Select the user account to be enabled when the MICRO/I power is turned on and when switching the operation mode. If **None** is selected, no user account is selected when the MICRO/I power is turned on and when the operation mode is changed. Screens and parts cannot be displayed or operated that are protected by a security group.

New User Account Dialog Box and **Change User Account** Dialog Box

In the **New User Account** dialog box, the user name, password, and security groups are assigned to an account and that user account is added.

In the **Change User Account** dialog box, the user name, password, and security groups for the selected user account are changed.

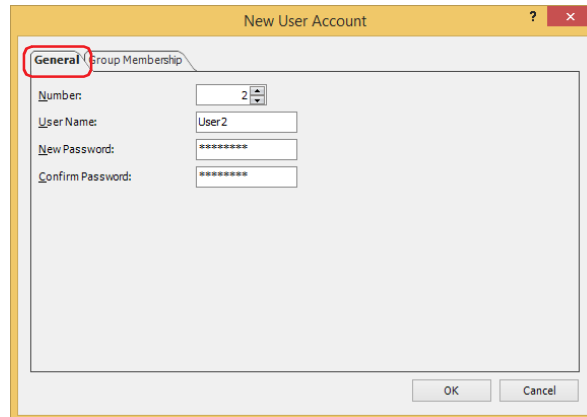
General Tab

■ Number

In the **New User Account** dialog box, this setting specifies the number (1 to 15) when switching the account via the value of device address.

When **Edit** was clicked and the **Change User Account** dialog box was displayed, this item displays the selected user account number.

■ User Name

Enter the name for the user account.

The maximum number is 16 characters. Only alphanumeric characters and symbols can be used.



- You cannot use the following characters in the user name.
" * . / : < > ? \ |
- For the HG2J-7U, do not set # at the beginning of the user name. User names start with # will prevent access to the MICRO/I FTP server.

■ New Password

Enter the password.

The number of characters for the password is 4 to 15. Only alphanumeric characters and symbols can be used.



Write down the password so you do not forget it and save that note in a safe place.



To display the content of the password for **New Password** and **Confirm Password**, select the **Show Passwords** check box in the **Security** dialog box.

■ Confirm Password

Re-enter the same password.

Group Membership Tab

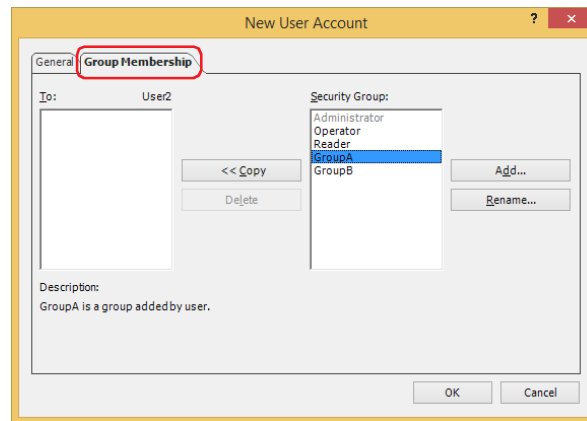

- **To: (user name being configured)**
 Displays the user name and the list of security groups assigned to the user.
- **<< Copy**
 This button assigns the security groups to the user displayed in **To**.
 Select the security groups in **Security Group** and click this button to add them to **To**.
- **Delete**
 This button deletes the security groups assigned to the user.
 Select the security groups in **To** and click this button.
- **Security Group**
 This item displays a list of all the security groups. The provided security groups (Administrator, Operator, and Reader) are grayed out if assigned to another user account.
- **Add**
 This button adds a security group. You can create a maximum of 12.
 Click this button to display the **Security Settings** dialog box. New security groups are added in the **Security Settings** dialog box. For details, refer to "Adding a Security Group" on page 23-19.
- **Rename**
 Select a security group in **Security Group** and click this button to display the **Change Security Group Name** dialog box. Change the name of the security group in the **Change Security Group Name** dialog box. For details, refer to "Changing the Name of a Security Group" on page 23-22.

Security Settings Dialog Box

On the **Group** tab in the **Security Settings** dialog box, the security group can be managed collectively including configuring for the parts and adding or deleting security groups. Access permission for Custom Web Page can be set for each Security Group in the **Web Page** tab.

Group Tab

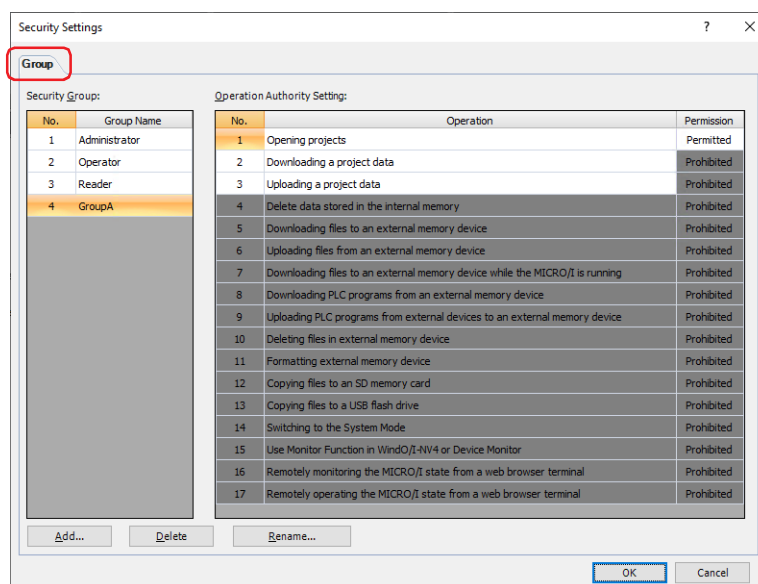

■ Security Group

Displays the list of security groups used on the MICRO/I.

Number: Displays the number (1 to 15) of the Security Group.

Security Group Name: Displays the name of the security group.

■ Operation Authority Setting

Displays a list of privilege settings for operations subject to password protection in the security group selected under **Security Group**.

No.: Displays the number of the operations subject to password protection (1 to 17).

Operation: Displays details about the operations subject to password protection.

Permission: Displays whether or not there is permission to use the operation. Only operations set to **Permitted** can be used with the selected security group.

Only operation privilege settings (1 to 3) can be changed for user-created security groups (4 to 15). Double clicking the cell switches between **Permitted** and **Prohibited**.



You can also switch between **Permitted** and **Prohibited** by right-clicking on a **Permission** cell.

■ Add

This button adds a security group. You can create a maximum of 12.

Click this button to display the **New Security Group** dialog box. Set the details of the security group in the **New Security Group** dialog box. For details, refer to "Adding a Security Group" on page 23-19.

■ Delete

Deletes the security groups selected for **Security Group**. For details, refer to "Deleting a Security Group" on page 23-24.

■ Rename

Select a security group in **Security Group** and click this button to display the **Change Security Group Name** dialog box. Change the name of the security group in the **Change Security Group Name** dialog box. For details, refer to "Changing the Name of a Security Group" on page 23-22.

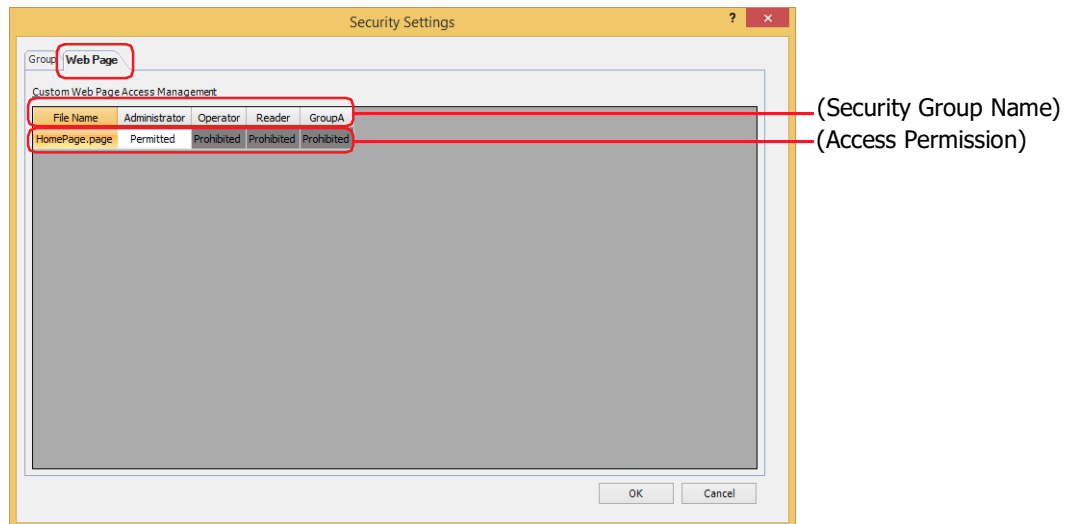
Web Page Tab

■ **Custom Web Page Access Management**

Permissions for display and operation of Custom Web Page are set for each Security Group.

- File Name: Displays the file name of the Custom Web Page created by the Web Page Editor. For details about the Web Page Editor, refer to Chapter 28 “Web Page Editor” on page 28-12.
- Security Group Name: Displays the name of the security group.
- Access Permission: Displays whether or not to permit the display and operation of the Custom Web Page of the MICRO/I from the web browser. Double clicking the cell switches between **Permitted** and **Prohibited**.

New Security Group Dialog Box

No.	Operation	Permission
1	Opening projects	Permitted
2	Downloading a project data	Permitted
3	Uploading a project data	Permitted
4	Delete data stored in the internal memory	Prohibited
5	Downloading files to an external memory device	Prohibited
6	Uploading files from an external memory device	Prohibited
7	Downloading files to an external memory device while the MICRO/I is running	Prohibited
8	Downloading PLC programs from an external memory device	Prohibited
9	Uploading PLC programs from external devices to an external memory device	Prohibited
10	Deleting files in external memory device	Prohibited
11	Formatting external memory device	Prohibited
12	Copying files to an SD memory card	Prohibited
13	Copying files to a USB flash drive	Prohibited
14	Switching to the System Mode	Prohibited
15	Use Monitor Function in WindO/I-NV4 or Device Monitor	Prohibited
16	Remotely monitoring the MICRO/I state from a web browser terminal	Prohibited
17	Remotely operating the MICRO/I state from a web browser terminal	Prohibited

■ Number

Specify the number (4 to 15) for the Security Group.

■ Group Name

Enter the name of the new group. The maximum number for the group name is 15 characters.



“なし” (Japanese), “None” (English), and “无” (Chinese) cannot be used for the group name.

■ (Operation Authority Setting)

Displays a list of privilege settings for operations subject to password protection in the security group selected under **Security Group**.

- No.: Displays the number of the operations subject to password protection (1 to 17).
- Operation: Displays details about the operations subject to password protection.
- Permission: Displays whether or not there is permission to use the operation. Only operations set to **Permitted** can be used.
- Only operation privilege settings (1 to 3) can be changed. Double clicking the cell switches between **Permitted** and **Prohibited**.



You can also switch between **Permitted** and **Prohibited** by right-clicking on a **Permission** cell.

● Options Tab

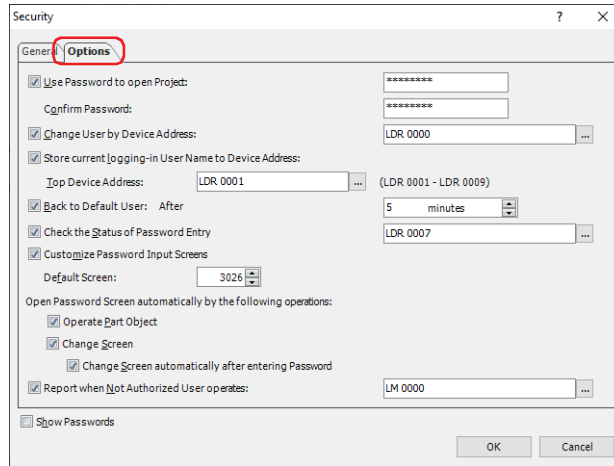

■ Use Password to open a Project

Select this check box and enter a password to protect the project with a dedicated password when opening it. The number for the password is 4 to 15 characters. Only alphanumeric characters and symbols can be used. The operations subject to password protection are as follows.

- Opening projects
- Reusing screens
- Opening projects after uploading project data

Confirm Password: Re-enter the password that was entered in **Use Password to open Project**.



Write down the password so you do not forget it and save that note in a safe place.

■ Change User by Device Address

Select this check box to switch the user account according to the value of device address. The user account is specified by using the number on the **General** tab.

(Trigger Device Address): Specifies the word device to write the number.

Click to display the Tag Editor. For the device address configuration procedure, refer to Chapter 2 "5.1 Device Address Settings" on page 2-70.

Example: When the trigger device address is D0 and the default user is selected as User1

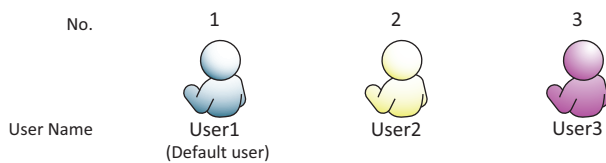

The user account switches according to the value of device address.

Trigger device address D0 value	1	2	3	4	0
User account	 User1	 User2	 User3	 User3	 User1
Action	Switch to user account no. 1	Switch to user account no. 2	Switch to user account no. 3	None	Switch to default user account

The user account is not switched when the value of device address is a number not configured to a user account or an invalid number.

If the value of device address is 0, the user is switched to the default user.

■ Store current logging-in User Name to Device Address

Select this check box to store the user name to Device Address currently logged in to the MICRO/I.

(Top Device Address): Specify the word device to use. This option uses 9 words of address numbers starting from the address number of the specified device address. You can only specify an internal device.

Click  to display the Tag Editor. For the device address configuration procedure, refer to Chapter 2 "5.1 Device Address Settings" on page 2-70.

■ Back to Default User

Select this check box to automatically switch to the default user when the MICRO/I is unused for an extended period of time.

After: Specify the time (0 to 60 minutes) to switch to the default user after the MICRO/I is last used.

If 0 is set, the MICRO/I switches back to the default user immediately, even if the user account was changed.

■ Check the Status of Password Entry

Select this check box to check the entry status of the password on the Password screen.

(Destination Device Address): Specifies a word device to write the password entry status.

Click  to display the Tag Editor. For the device address configuration procedure, refer to Chapter 2 "5.1 Device Address Settings" on page 2-70.

The following bits change to 1 depending on the password input status. These bits become 0 when the Password screen opens or when a button other than **ENT** or **CAN** is pressed on the Password screen.

Bit number	Function	Status
0	This bit stores the information when the correct password was entered on the Password screen and ENT was pressed.	0: Password being entered 1: Correct password entered
1	This bit stores the information when an incorrect password was entered on the Password screen and ENT was pressed.	0: Password being entered 1: Incorrect password entered
2	This bit stores the information when CAN was pressed on the Password screen.	0: Password being entered 1: Password entry canceled
3 to 7	Reserved	-

■ Customize Password Input Screens

Select this check box to customize the Password Input Screens.

When this check box is selected, the Password Input Screen folder gets displayed in the Project window and the Standard Password Input Screen gets created automatically in screen numbers 3026 to 3028.

This option can only be set when the **Use Security functions** on the General tab is selected.

Default Screen: Specifies the screen number (3026 to 3033) to display first when the Password Input Screen opens.

■ Open Password Screen automatically by the following operations

Operate Part Object: Select this check box to automatically display the Password screen when an unauthorized user presses the password protected object.

Change Screen: Select this check box to automatically display the Password screen when an unauthorized user attempts to change a screen that is password protected.

Change Screen automatically after entering Password: Select this check box to close the **Password** screen and automatically change the screen when the entered password is correct.

■ **Report when Not Authorized User operates**

Select this check box to write 1 in the Report Device Address when one of the following actions is performed.

- Switching to a base screen that the current user account is not allowed to display.
- Opening a popup that the current user account is not allowed to display.
- Manipulating a part set to a security group that the current user account is not allowed to manipulate.

(Report Device Address): Specifies the report device address.

Click to display the Tag Editor. For the device address configuration procedure, refer to Chapter 2 "5.1 Device Address Settings" on page 2-70.

4 Password Input

HG2J-7U HG5G-V HG4G-V HG4G HG3G-V HG3G HG2G-V HG2G-5F HG2G-5T HG1G HG1P

When a password is configured for a user account, the user is prompted to enter their password with the following operations.

- Accessing password protected data
- Executing password protected displays and operations

4.1 Entering the Password on the MICRO/I

To execute password protected operations, the user must open the Password screen and switch the user account. The Password screen is opened with a Goto Screen Button or Goto Screen Command configured with Password Screen. The Password screen is also automatically displayed on the MICRO/I when the following operations are executed.

- When the **Change Screen** check box is selected under **Open Password Screen automatically by the following operations** on the **Options** tab in the **Security** dialog box
- Switching to the System Mode or displaying the Device Monitor with the Maintenance screen, Goto Screen Button, Multi-Button, Goto Screen Command, or Multi-Command
- Downloading or uploading project data or PLC programs with a Key Button, Multi-Button, or Multi-Command
- Executing the USB Autorun function



- Operations where the Password screen is not displayed are as follows.
 - Switching the base screen using the System Area
 - Displaying the alarm screen for the alarm log
 - Opening the keypad with the Numerical Input or Character Input
 - Opening the Ref. screen with the Alarm Log Display
 - For screens that are already open when the user account was switched by opening the Password screen with the Goto Screen Button or Goto Screen Command
- When the user account is switched, the displayed base screen is reset. When the current screen is reset, the displayed Popup Screen is closed and the internal devices restart as if the Base Screen is switched. The behavior of the internal devices varies based on the internal devices. For details, refer to Chapter 33 "Internal Devices" on page 33-1.
- Enter the password for projects created with WindO/I-NV4 Ver. 1.11.4 or earlier using only 4 to 15 uppercase letters and numbers.

● Password Input Screens provided by the MICRO/I Configuration

Keypad for Upper Case and Number Input

Password											
User Name	User									▲	▼
Password	*****										
1	2	3	4	5	6	7	8	9	0	BS	
Q	W	E	R	T	Y	U	I	O	P	CLR	
¹²³ abc	A	S	D	F	G	H	J	K	L	CAN	
!/?#	Z	X	C	V	B	N	M	ENT			

Keypad for Lower Case and Number Input

Password											
User	User									▲	▼
Password	*****										
1	2	3	4	5	6	7	8	9	0	BS	
q	w	e	r	t	y	u	i	o	p	CLR	
¹²³ ABC	a	s	d	f	g	h	j	k	l	CAN	
!/?#	z	x	c	v	b	n	m	ENT			

Keypad for Sign Input

Password											
User	User									▲	▼
Password	*****										
@	#	\$	_	&	-	+	()	/	BS	
*	"	`	:	;	!	?	,	.	~	CLR	
¹²³ ABC	`		^	=	{	}	\	<	>	CAN	
¹²³ abc	%	[]	ENT							

■ **User Name**

Displays the selected user name.

■ **,**

Switches the user name. This option is displayed only when the **Use Security functions** is selected.

■ **Password**

The password entered gets displayed as *(asterisks).

■ **A to Z, a to z, 0 to 9, @ to]**

Enters alphanumeric characters and symbols in **Password**.

■ ¹²³***1**, ¹²³***1**, ¹²³**!/?#*1**, ¹²³**1A*2**, ¹²³**1a*2**, ¹²³**?#*2**

Switches to the Keypad for Upper Case and Number Input, the Keypad for Lower Case and Number Input or the Keypad for Sign Input.

■ **CAN**

Clears the entered password and cancels input. The Password screen closes.

■ **CLR**

Clears the entered password and continues input.

■ **ENT**

Confirms the entered password and starts verifying the user name and password.

If the entered password is correct, the Password screen closes.

If the entered password was incorrect, the password entered on the Password screen is deleted and the screen returns to input mode.

*1 HG2J-7U, HG5G/4G/3G/2G-V, HG4G/3G, HG2G-5F only

*2 HG2G-5T, HG1G/1P only

4.2 Entering the Password in WindO/I-NV4

When a user account assigned with Administrator is configured with a password, or when a dedicated password for opening the project has been set, the **Enter Password** dialog box is displayed in WindO/I-NV4 as required and the user is prompted to enter their password.



Enter the password for projects created with WindO/I-NV4 Ver. 1.11.4 or earlier using only 4 to 15 uppercase letters and numbers.

The operations that display the **Enter Password** dialog box are as follows.

- Opening projects
- Reusing screens
- Downloading a project data
- Downloading data to an external memory device^{*1}
- Downloading data to an external memory device^{*1} while the MICRO/I is running
- Uploading a project data
- Uploading data from an external memory device^{*1}
- Delete data stored in the internal memory
- Deleting data in external memory device^{*1}
- Formatting^{*2} external memory device^{*3}

● Enter Password Dialog Box

If Administrator or Other Operation password is required, the following dialog box appears.

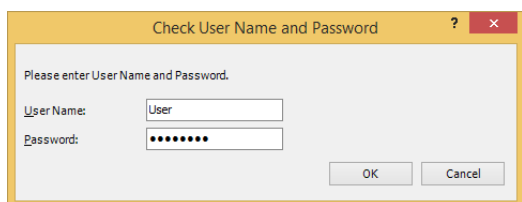

If dedicated password for opening project is required, the following dialog box appears.

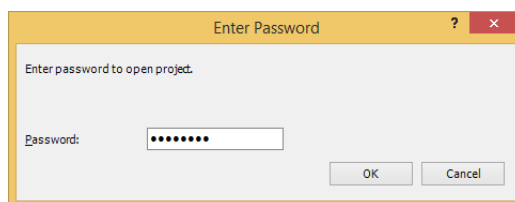

■ User Name

Selects the user name. This item can only be selected when multiple user accounts are registered.

■ Password

Enter the password. The password entered gets displayed as *(asterisks).

*1 USB flash drive inserted in USB1 for HG2J-7U, SD memory card for HG5G/4G/3G/2G-V, HG4G/3G and HG2G-5F, USB flash drive for HG2G-5T and HG1G/1P

*2 HG5G/4G/3G/2G-V, HG4G/3G, HG2G-5F/-5T, HG1G/1P only

*3 SD memory card for HG5G/4G/3G/2G-V, HG4G/3G and HG2G-5F, USB flash drive for HG2G-5T and HG1G/1P

5 Editing User Accounts on the MICRO/I

HG2J-7U HG5G-V HG4G-V HG4G HG3G-V HG3G HG2G-V HG2G-5F HG2G-5T HG1G HG1P

On the MICRO/I, you can open the **User Account Setting Screen**. Use this screen to edit, add, and delete user accounts.

5.1 Opening the User Account Setting Screen

To open the User Account Setting Screen, use the Goto Screen Button, Multi-Button, Goto Screen Command, or Multi-Command that has been set to **Open User Account Setting Screen**.

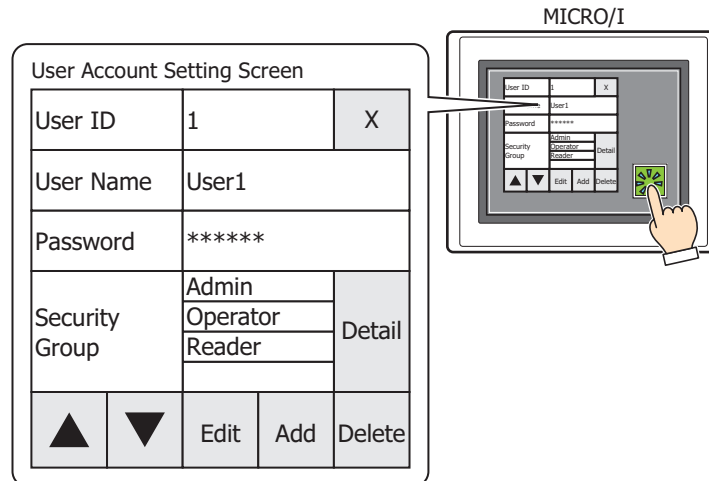

- Set a Key Button, Multi-Button, or Multi-Command configured with the **Open User Account Setting Screen** on the screen.
 - ☞ For details, refer to Chapter 8 "3 Goto Screen Button" on page 8-39.
 - ☞ For details, refer to Chapter 8 "6 Multi-Button" on page 8-110.
 - ☞ For details, refer to Chapter 12 "3 Goto Screen Command" on page 12-18.
 - ☞ For details, refer to Chapter 12 "6 Multi-Command" on page 12-38.
- An **Administrator** user account is required to open the **User Account Setting Screen**.
- When opening the **User Account Setting Screen**, all other Popup Screens are closed.

5.2 Editing a User Account

● Checking User Account Information

You can load user accounts configured in the project data and edit their information.

- 1 Press the Goto Screen Button or Multi-Button that has been set to **Open User Account Setting Screen** or execute the Goto Screen Command or Multi-Command.

The **User Account Setting Screen** will be displayed.

- 2 Press ▲ or ▼ to change the user number of the user account to edit.

User ID	1	X
User Name	User1	
Password	*****	
Security Group	Admin	Detail
	Operator	
	Reader	
▲ ▼	Edit	Add Delete

- 3 Press **Edit**.

User ID	2	X
User Name	User2	
Password	*****	
Security Group	GroupA	Detail
▲ ▼	Edit	Add Delete

- 4 Change the user name.

If you will not change the user name, proceed to step 5.

1. Press the **User Name** input frame.

User ID	2	X
User Name	User2	
Password	*****	
Security Group	GroupA	Change
Edit User.	OK	CANCEL

2. Enter the user name and press **ENT**.

Test02_											
0	1	2	3	4	5	6	7	8	9	BS	
!	"	#	\$	%	&	'	()	*	CLR	
+	,	-	.	/	:	;	<	=	>	CAN	
?	@	[\]	^	_	`	{		ENT	
}	~	Alpha bet	SP				<Cur.	Cur.>			

5 Changes the password.

If you will not change the password, proceed to step 6.

1. Press the **Password** input frame.

User ID	2	X
User Name	Test02	
Password	*****	
Security Group	GroupA	Change
Edit User.	OK	CANCEL

2. Enter the password and press **ENT**.

Password02_										Hide
1	2	3	4	5	6	7	8	9	0	BS
q	w	e	r	t	y	u	i	o	p	CLR
123 ABC	a	s	d	f	g	h	j	k	l	CAN
!/?#	z	x	c	v	b	n	m	ENT		



Press **Hide** to display the password with *(asterisks). Press **Show** to display the password with characters.

6 Change the security group assignments.

If you will not change the security group assignments, proceed to step 7.

1. Press **Change**.

User ID	2	X
User Name	Test02	
Password	Password02	
Security Group	GroupA	Change
Edit User.	OK	CANCEL

2. Select security groups to assign and clear security groups to remove.

- Security groups are selected and cleared each time the names are pressed.
- Press **Gr. 1~5**, **Gr. 6~10**, and **Gr. 11~15** to switch between the different sets of five security groups.

Gr. 1~5	Gr. 6~10	Gr. 11~15	Close
Gr. 1	Administrator		
Gr. 2	Operator		
Gr. 3	Reader		
Gr. 4	GroupA		
Gr. 5	GroupB		

3. Press **Close**.

Gr. 1~5	Gr. 6~10	Gr. 11~15	Close
Gr. 1	Administrator		
Gr. 2	Operator		
Gr. 3	Reader		
Gr. 4	GroupA		
Gr. 5	GroupB		

7 Press **OK**.

User ID	2	X
User Name	Test02	
Password	Password02	
Security Group	Admin	Change
	GroupA	
Edit User.	OK	CANCEL



8 Press **OK**.

User ID	2	X
User Name	Test02	
Password	Password02	
Succeed		
OK		



The user name, password, and security group assignments will be changed.

User ID	2	X		
User Name	Test02			
Password	*****			
Security Group	Admin	Detail		
	GroupA			
▲	▼	Edit	Add	Delete

This concludes editing a user account.

● Adding a user accounts
Adding a user accounts.

1 Press the Goto Screen Button or Multi-Button that has been set to **Open User Account Setting Screen** or execute the Goto Screen Command or Multi-Command.
The **User Account Setting Screen** will be displayed.

2 Press **Add**.

User ID	1	X
User Name	User1	
Password	*****	
Security Group	Admin	Detail
	Operator	
	Reader	
▲	▼	Edit Add Delete

3 Enter the **User Name**.

1. Press the **User Name** input frame.

User ID	5	X
User Name		
Password		
Security Group		Change
Add User.	OK	CANCEL



User ID displays the lowest user number (1 to 15) of all free numbers.

2. Enter the user name and press **ENT**.

User5_										
0	1	2	3	4	5	6	7	8	9	BS
!	"	#	\$	%	&	'	()	*	CLR
+	,	-	.	/	:	;	<	=	>	CAN
?	@	[\]	^	_	`	{		ENT
}	~	Alpha bet	SP				<Cur.	Cur.>		

4 Enter the password.

1. Press the **Password** input frame.

User ID	5	X
User Name	User5	
Password		
Security Group		Change
Add User.	OK	CANCEL

2. Enter the password and press **ENT**.

Pass05											Hide
1	2	3	4	5	6	7	8	9	0	BS	
q	w	e	r	t	y	u	i	o	p	CLR	
123 ABC	a	s	d	f	g	h	j	k	l	CAN	
!/?#	z	x	c	v	b	n	m	ENT			



Press **Hide** to display the password with *(asterisks). Press **Show** to display the password with characters.

5 Assign the security groups.

1. Press **Change**.

User ID	5	X
User Name	User5	
Password	Pass05	
Security Group		Change
Add User.	OK	CANCEL

- 2. Select security groups to assign and clear security groups to remove.
 - Security groups are selected and cleared each time the names are pressed.
 - Press **Gr. 1~5**, **Gr. 6~10**, and **Gr. 11~15** to switch between the different sets of five security groups.

Gr. 1~5	Gr. 6~10	Gr. 11~15	Close
Gr. 1	Administrator		
Gr. 2	Operator		
Gr. 3	Reader		
Gr. 4	GroupA		
Gr. 5	GroupB 		

3. Press **Close**.

Gr. 1~5	Gr. 6~10	Gr. 11~15	Close
Gr. 1	Administrator		
Gr. 2	Operator		
Gr. 3	Reader		
Gr. 4	GroupA		
Gr. 5	GroupB		

6 Press **OK**.

User ID	5	X
User Name	User5	
Password	Pass05	
Security Group	GroupB	Change
Add User.	OK 	CANCEL

7 Press **OK**.

User ID	5	X
User Name	User5	
Password	Pass05	
Succeed		
OK 		

The user account will be added.

User ID	5	X
User Name	User5	
Password	*****	
Security Group	GroupB	Detail
▲	▼	Edit Add Delete

This concludes adding the User Account.

● **Deleting a User Account**

The loaded user account can be deleted.

- 1 Press the Goto Screen Button or Multi-Button that has been set to **Open User Account Setting Screen** or execute the Goto Screen Command or Multi-Command.
The **User Account Setting Screen** will be displayed.
- 2 Press ▲ or ▼ to change the user number of the user account to delete.

User ID	1	X
User Name	User1	
Password	*****	
Security Group	Admin	Detail
	Operator	
	Reader	
▲	▼	Edit Add Delete



- 3 Press **Delete**.

User ID	5	X
User Name	User5	
Password	*****	
Security Group	GroupB	Detail
▲	▼	Edit Add Delete



4 Press **OK**.

User ID	5	X
User Name	User5	
Password	*****	
Security Group	GroupB	Change
Delete User.	OK	CANCEL



5 Press **OK**.

User ID	5	X
User Name		
Password		
Succeed		
OK		



The user account will be deleted.

User ID	5	X
User Name		
Password		
Security Group		Detail
▲	▼	Edit Add Delete

This concludes deleting the User Account.

5.3 User Account Setting Screen Configuration

User ID	1	X
User Name	User1	
Password	*****	
Security Group	Admin	Detail
	Operator	
	Reader	
▲	▼	Edit Add Delete

■ User ID

Displays the user number of the user account configured in the running project.

■ User Name

Displays the user name of the user account configured in the running project.

When editing or adding a user account, press the user name input field, and then enter the user name with the displayed keyboard.

■ Password

Displays the password of the displayed user account with * (asterisk).

When editing or adding a user account, press the password input field, and then enter the password with the displayed keyboard.



You can hide or show password in the Password Input Screen. Press **Hide** to display the password with *(asterisks).

■ Security Group

Displays the security group assigned to the displayed user account.

■ Detail / Change

Detail is displayed when the user account is loaded. Press **Detail** to display the **security group details screen** where you can check details about the assigned security groups.

Change is displayed when the user account is edited or added. Press **Change** to display the **change security groups screen**. You can change the security group assignments.

■ ▲, ▼

Changes the user number and loads the corresponding user account.

■ Edit

Used to change the user name, password, and security group assignments of the displayed user account.

■ Add

Adds a user account.

■ Delete

Deletes a displayed user account.

■ X

Closes User Account Setting Screen.

Chapter 24 Online Function

This chapter describes in detail on how to setup the online function and the operation of the MICRO/I.

1 Communicating with the MICRO/I

HG2J-7U HG5G-V HG4G-V HG4G HG3G-V HG3G HG2G-V HG2G-5F HG2G-5T HG1G HG1P

1.1 How the Online Function is Used

The online function enables communication with the MICRO/I in WindO/I-NV4. This communication between WindO/I-NV4 and the MICRO/I, implemented using an exclusive protocol called maintenance communication. The online function enables the following.

- Write a project data into the MICRO/I.

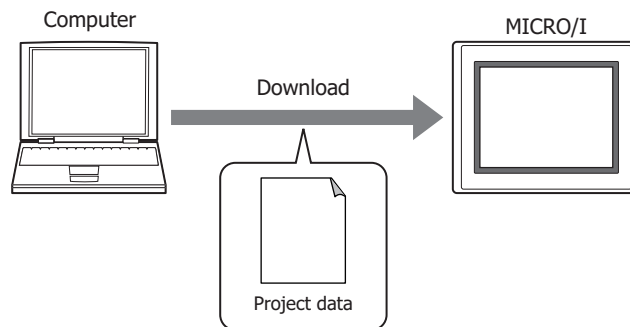

- The following functions can be executed with downloading of project data.
 - Force download the system software and the operating system^{*1} to the MICRO/I.
 - Download optional fonts and Kanji dictionary data.^{*2}
 - Download the system software to the expansion modules.^{*3}
 - Download recipe files, picture files, sound files^{*4} and Custom Web Page files to the External Memory Device folder in the external memory device inserted into the MICRO/I.
 - Clear the HMI Keep Register (LKR) and HMI Keep Relay (LK) after download.
 - Clear the HMI Keep Register (LKR), HMI Keep Relay (LK), Alarm Log Data, Data Log Data and Operation Log Data after download.
- For details on writing project data to an external memory device inserted in the computer, refer to Chapter 31 "Downloading" on page 31-8.



When downloading the operating system^{*1}, it cannot be downloaded to the external memory device.

*1 HG2J-7U only

*2 HG5G/4G/3G/2G-V, HG4G/3G, HG2G-5F/-5T, HG1G/1P only

*3 HG5G/4G/3G/2G-V only

*4 This is applicable for HG2J-7U and models with an audio interface only.

- Write files to an external memory device*5 inserted in the MICRO/I.

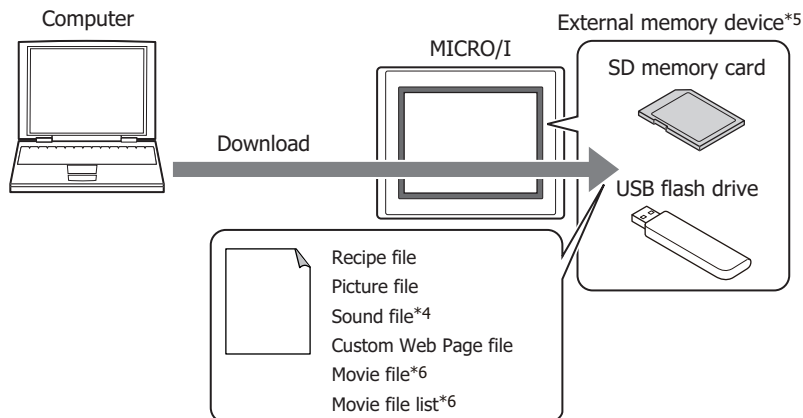

- Read the project data downloaded to the MICRO/I and then save it to a computer.

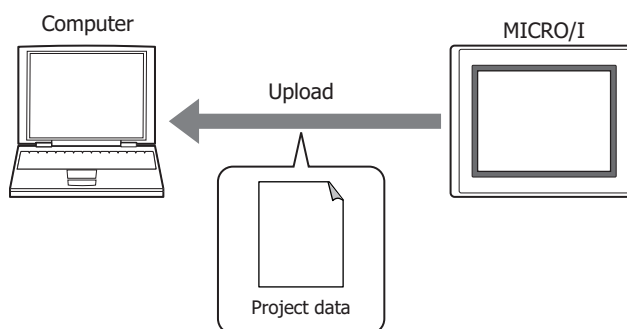

- It is possible to upload recipe files, picture files, sound files*4 and Custom Web Page files from the External Memory Device folder in the external memory device inserted in the MICRO/I, together with uploading of project data.
- For details on reading project data saved on an external memory device using WindO/I-NV4, refer to Chapter 31 "Uploading" on page 31-9.

- Delete the data stored in the internal memory or the external memory device*5 inserted in the MICRO/I. Format the external memory device in the MICRO/I.

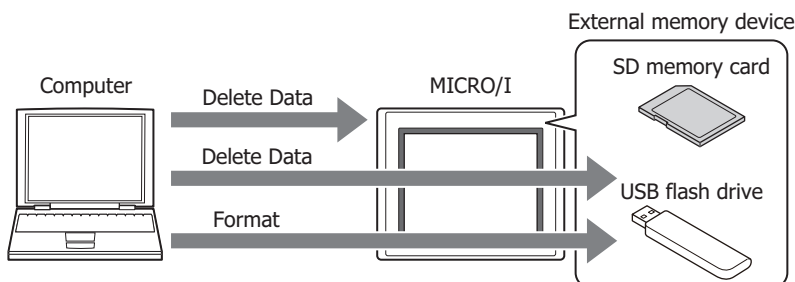

*4 This is applicable for HG2J-7U and models with an audio interface only.

*5 USB flash drive inserted in USB1 for HG2J-7U, SD memory card for HG5G/4G/3G/2G-V, HG4G/3G and HG2G-5F, USB flash drive for HG2G-5T and HG1G/1P

*6 This is applicable for models with a video interface only.

- Display the information about the system software and project data of the MICRO/I.

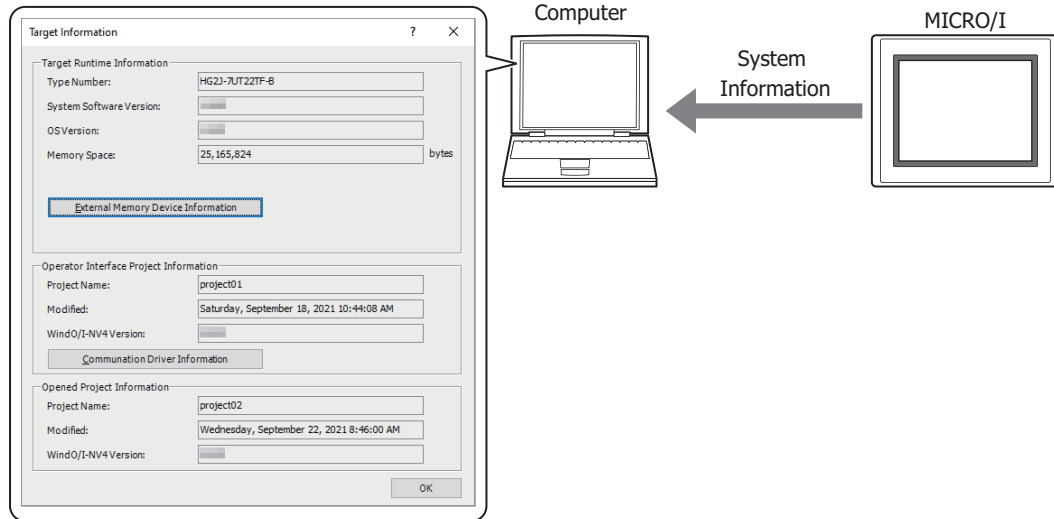

- Edit a project data in WindO/I-NV4 while checking MICRO/I operation by displaying and changing values of device addresses and switching screens using the monitor function.

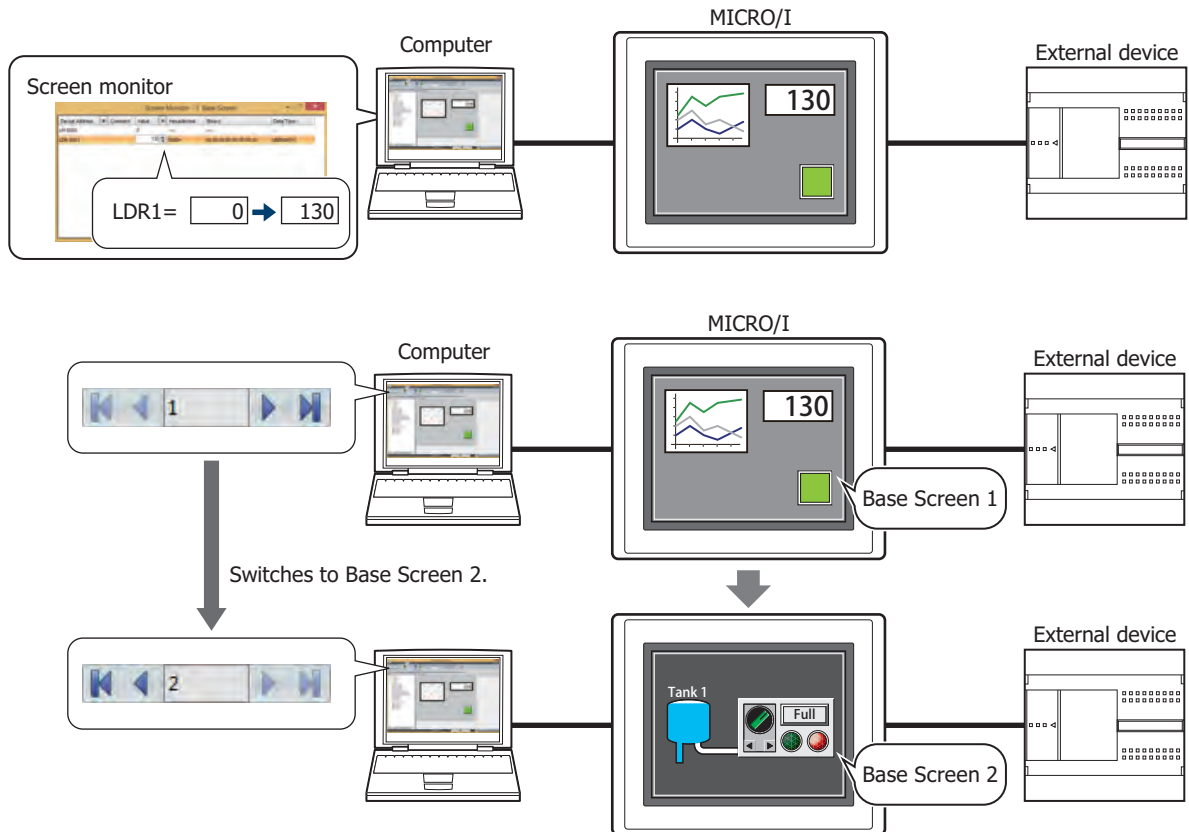

For details about monitor function, refer to Chapter 25 "1 Monitoring with WindO/I-NV4" on page 25-1.

1.2 Connect MICRO/I to a Computer

Connection type varies based on the interface between the MICRO/I and computer.

● USB cable connection

HG2J-7U HG5G-V HG4G-V HG4G HG3G-V HG3G HG2G-V HG2G-5F HG2G-5T HG1G HG1P

The computer must be running Windows 10/8/7 (64-bit and 32-bit versions), and must have a USB2.0/1.1 port.

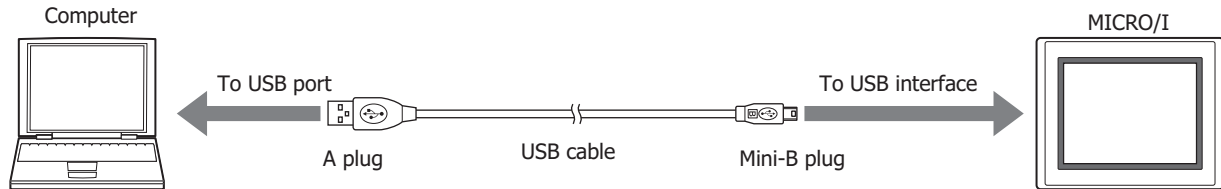

A USB driver must be installed when connecting the MICRO/I to a computer with a USB cable. Install the USB driver when making the connection for the first time. For details, refer to "How to install USB driver". On the upper right corner, click on ▼ to the right of ? icon, and then click on the How to install USB driver to display the "How to install USB driver".

The USB driver does not have to be installed for subsequent connections. Note, the connection must use the same USB port that was connected to when installing the USB driver. The computer will not recognize the MICRO/I immediately if the USB cable is connected to a different USB port.



- Multiple MICRO/I connections using different USB ports on the same computer are not supported.
- The computer cannot be connected to the MICRO/I via a USB hub.

● Ethernet cable connection

HG2J-7U HG5G-V HG4G-V HG4G HG3G-V HG3G HG2G-V HG2G-5F HG2G-5T HG1G HG1P

The computer must be equipped with an Ethernet port.

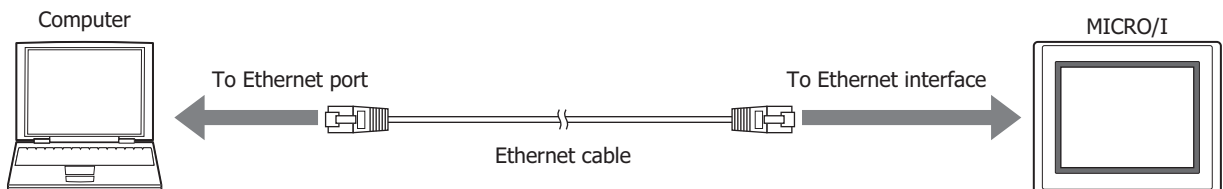

It is necessary to configure the MICRO/I according to the local network that is used.

On the **Communication Interface** tab in the Project Settings dialog box, specify the IP address, subnet mask, and default gateway, and clear the **Forbid Maintenance Communication** check box. For details, refer to Chapter 4 "3.2 Communication Interface Tab" on page 4-35.

1.3 Change Communication Settings

To communicate with the MICRO/I in WindO/I-NV4, configure the settings such as communication speed and port used to match the connection method for the MICRO/I.

- 1 On the **Home** tab, in the **Project** group, click **Comm.Setup**.

The Communication Settings dialog box is displayed.

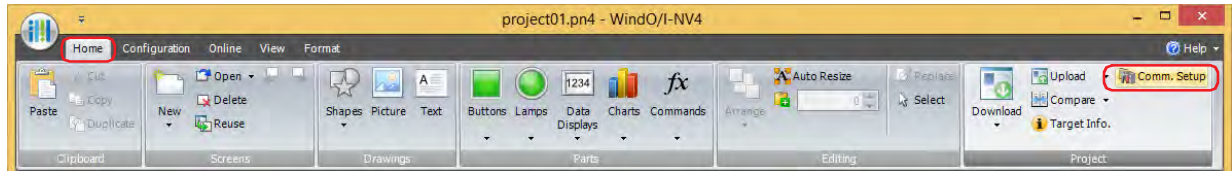

- 2 Change the settings on each tab as necessary and then click **OK**.

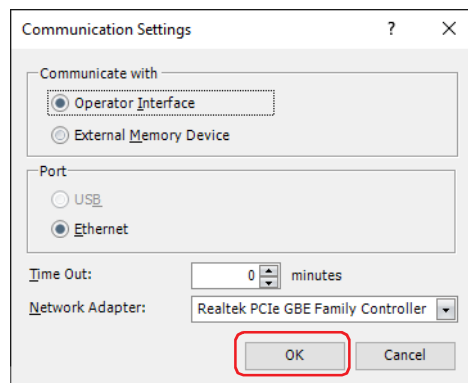

■ Communicate with

Select the device to communicate with from the following items.

Operator Interface: Communicate with the MICRO/I connected to the computer.
For details, refer to "Using the online function for Ethernet communication" on page 24-7.

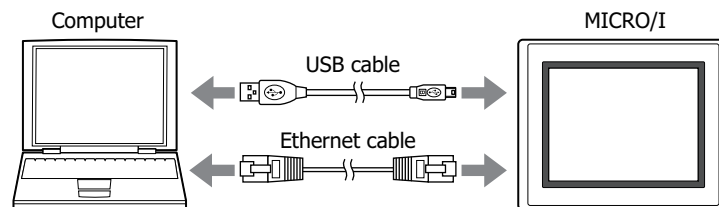

External Memory Device: Read or write data to the external memory device inserted in the computer.
For details, refer to Chapter 31 "1.5 Reading/Writing Data" on page 31-4.

■ **Port**

Select the communication port on the computer from the following items.

USB^{*1}: Connect the USB port on the computer to the USB interface on the MICRO/I.

Ethernet: Connect the Ethernet port on the computer to the Ethernet interface on the MICRO/I.



- The port number is 2537 when connecting from WindO/I-NV4 to the MICRO/I via Ethernet.
- The default network settings configured on the MICRO/I are as follows.

IP Address:	192.168.1.150 ^{*2} or 192.168.0.1 ^{*1}
Subnet Mask:	255.255.255.0

■ **Time Out (min)**

Specify the time to wait for a response from the MICRO/I (0 minute to 20 minutes).

■ **Network Adapter**

Select the network adapter to use with your computer. Only network adapters that are enabled on your computer are displayed.

The network adapter can only be set when **Communicate with** is set to **Operator Interface** and **Port** to **Ethernet**.

*1 HG5G/4G/3G/2G-V, HG4G/3G, HG2G-5F/-5T, HG1G/1P only

*2 HG2J-7U only

- Using the online function for Ethernet communication

Select **Ethernet** under **Port** on the Communication Settings dialog box.



It is necessary to configure the MICRO/I according to the local network that is used.

On the **Communication Interface** tab in the Project Settings dialog box, configure the IP address, subnet mask, default gateway, and port number, and clear the **Forbid Maintenance Communication** check box. For details, refer to Chapter 4 "3.2 Communication Interface Tab" on page 4-35.

To download project data

Click **Edit** in the **Communication Settings***¹ or click **Download***² on the **Download** dialog box to display the **Target List** dialog box.

Specify the Ethernet settings (IP address, subnet mask, default gateway, and port number) for the MICRO/I.

Select the MICRO/I IP addresses and you can batch download project data to multiple MICRO/I.

It is also possible to change the Ethernet settings (IP address, subnet mask, default gateway, and port number) for the MICRO/I to which you are downloading after project data is downloaded.

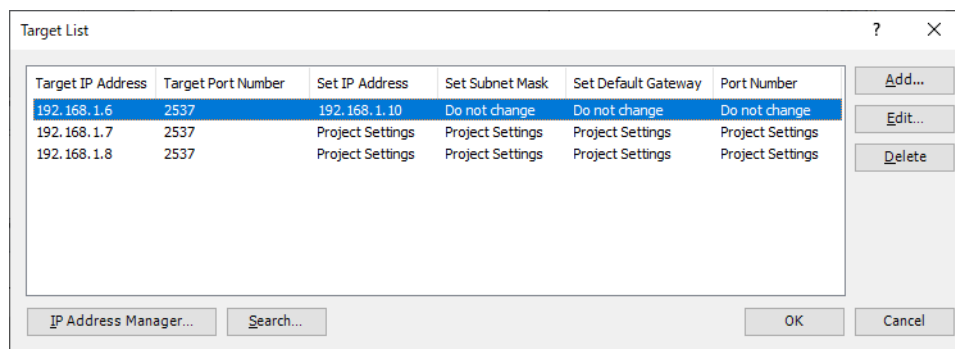

- **Target List**

Target IP Address: Displays the current IP address for the MICRO/I to download the project data to.

Target Port Number: Displays the current port number for the MICRO/I to download the project data to.

Set IP Address: Displays the IP address for the MICRO/I after downloading the project data.

Set Subnet Mask: Displays the subnet mask for the MICRO/I after downloading the project data.

Set Default Gateway: Displays the default gateway for the MICRO/I after downloading the project data.

Port Number: Displays the port number for the MICRO/I after downloading the project data.

- **Add**

Adds a download destination for project data to the **Target List**. Click this button to open the Target IP Address dialog box. Using the Target IP Address dialog box, specify the Ethernet settings for the MICRO/I to which you are downloading.

- **Edit**

Changes the settings of the **Target List**.

Select a download destination from the **Target List**, and then click this button to open the Target IP Address dialog box. Using the Target IP Address dialog box, change the Ethernet settings for the MICRO/I to which you are downloading.



Even if the Ethernet settings of the MICRO/I are changed by using the Target IP Address dialog box when downloading a project, the Ethernet settings in the editing project data are not changed.

- **Delete**

Deletes download destinations from the **Target List**.

- **IP Address Manager**

Open IP Address Manager. Specify the IP address for the target MICRO/I with IP Address Manager. For details, refer to "IP Address Manager" on page 24-11.

*1 HG2J-7U only

*2 HG5G/4G/3G/2G-V, HG4G/3G, HG2G-5F/-5T, HG1G/1P only

■ Search

Search for MICRO/I on the same network that can be connected to a computer via maintenance communication. Click this button to display the **Search MICRO/I** dialog box. For details, refer to "Search MICRO/I dialog box" on page 24-9.

Target IP Address Settings dialog box

Specifies the IP address of the MICRO/I used for communication.

■ Target IP Address

Specify the IP address for the target MICRO/I to execute this function.

■ Target Port Number

Specify the port number for the target MICRO/I to execute this function.

■ After downloading, change the settings of Target

Change the IP settings of the target MICRO/I after project data is downloaded. Select from the following setting methods.

Use the IP Settings in "Communication Interface" tab on "Project Settings" dialog box:

Use the network settings configured in the **Communication Interface** tab on the **Project Settings** dialog box. For details, refer to Chapter 4 "When Ethernet is selected under Interface Configuration" on page 4-41.

Use the following settings:

Use the following IP settings. Select the check boxes to change items. Settings for which the check box is clear are not changed.

IP Address: Enter the IP address to register in the project data.

Subnet Mask: Enter the subnet mask to register in the project data.

Default Gateway: Enter the default gateway to register in the project data.

Port Number: Enter the port number to register in the project data.



Regarding TCP port number of MICRO/I, note the following points.

The numbers that cannot be used:

- 2539: Maintenance communication (Data Transfer)
- 2538: For pass-through
- 2101: For FC4A Series MicroSmart direct connection pass-through

Duplicate numbers cannot be configured in the following functions:

- Maintenance communication (☞ refer to Chapter 4 "Port Number" on page 4-41)
- Web server function (☞ refer to Chapter 4 "Port Number" on page 4-67)
- FTP server function (☞ refer to Chapter 4 "Port Number" on page 4-68)
- **TCP Server** is selected for the User Communication (☞ refer to Chapter 4 "Port No." on page 4-43)
- **Modbus as Manufacture** and **Modbus TCP Server as Communication Driver** are selected on the **Communication Driver** tab (☞ refer to the WindO/I-NV4 External Device Setup Manual)
- **YASKAWA Electric as Manufacture** and **MP2000(Ethernet)** as **Communication Driver** are selected on the **Communication Driver** tab (☞ refer to the WindO/I-NV4 External Device Setup Manual)



After downloading the OS, the settings of the target will be the IP settings in the **Communication Interface** tab on the **Project Settings** dialog box.

Search MICRO/I dialog box

The result of the search performed by clicking **Search** in the **Target List** dialog box is displayed.

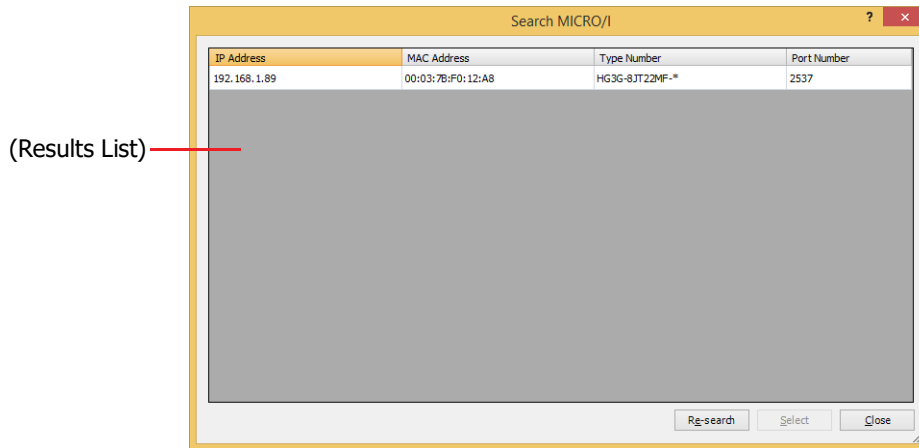

■ (Results List)

Displays the information of MICRO/I as search results. Selects the MICRO/I to register in the **Target List** on the **Target List** dialog box.

IP Address:	Displays the IP address of the MICRO/I.
MAC Address:	Displays the MAC address of the MICRO/I.
Type Number:	Displays the part number of the MICRO/I.
Port Number:	Displays the port number of the MICRO/I.

■ Re-search

Search again for MICRO/I on the same network that can be connected to a computer via maintenance communication.

■ Select

Closes the **Search MICRO/I** dialog box, and then registers the MICRO/I selected from the (Results List).



If there is a MICRO/I of the IP address already registered in the **Target List** on the **Target List** dialog box, an overwrite confirmation message is displayed.

- Click **Yes** to overwrite and save the MICRO/I of the IP address displayed in the confirmation message.
- Click **Yes To All** to overwrite and save the MICRO/Is of all IP addresses.
- Click **No** to display the next confirmation message without overwriting the MICRO/I of the IP address displayed in the confirmation message.
- Click **Cancel** to stop importing the MICRO/I of the IP address.

■ Close

Closes the **Search MICRO/I** dialog box.

To execute a function other than the project data download

The Target IP Address dialog box will be displayed when any of the following functions are executed.

- Upload a project data.
- Upload data from an external memory device inserted in the MICRO/I.
- Delete data stored in the internal memory.
- Delete data from or formatting an external memory device inserted in the MICRO/I.
- Display information about system software and project data.
- Monitor the MICRO/I.

The dialog box allows you to specify the IP address of the target MICRO/I.

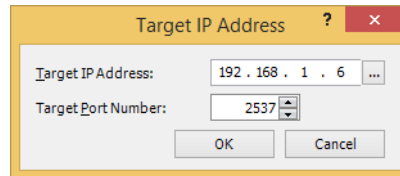

■ **Target IP Address**

Specify the IP address for the target MICRO/I to execute this function.

Click  to display the **Target List** dialog box. Specify the IP address for the target MICRO/I.

■ **Target Port Number**

Specify the port number for the target MICRO/I to execute this function.

● IP Address Manager

You can register target Ethernet settings for performing online function via Ethernet communication to the project data.

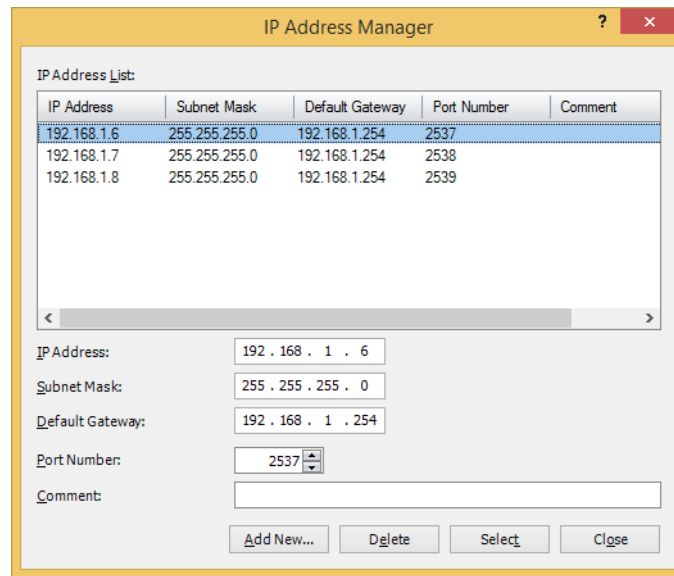

■ IP Address List

Ethernet settings registered in the project data are displayed in this list.

- IP Address: Displays the IP address.
- Subnet Mask: Displays the subnet mask.
- Default Gateway: Displays the default gateway.
- Port Number: Displays the port number.
- Comment: Displays comment.

■ IP Address

Enter the IP address to register in the project data.

■ Subnet Mask

Enter the subnet mask to register in the project data.

■ Default Gateway

Enter the default gateway to register in the project data.

■ Port Number

Enter the port number to register in the project data.

■ Comment

Enter comment to register in the project data.

■ Add New

Adds **IP Address**, **Subnet Mask**, **Default Gateway**, **Port Number**, and **Comment** to the list.

■ Delete

Deletes the selected IP address from the list.

■ Select

Closes IP Address Manager, and apply the Ethernet settings selected from the list.

2 Downloading

HG2J-7U HG5G-V HG4G-V HG4G HG3G-V HG3G HG2G-V HG2G-5F HG2G-5T HG1G HG1P

2.1 Downloading Project Data to the MICRO/I

- 1 Change communication settings according to the connection method between the computer and the MICRO/I.

In the **Communication Settings** dialog box, select **Operator Interface** from **Communicate with**. For details, refer to "1.3 Change Communication Settings" on page 24-5.

For the HG2J-7U, select the check box of the target in **(Target list)**.

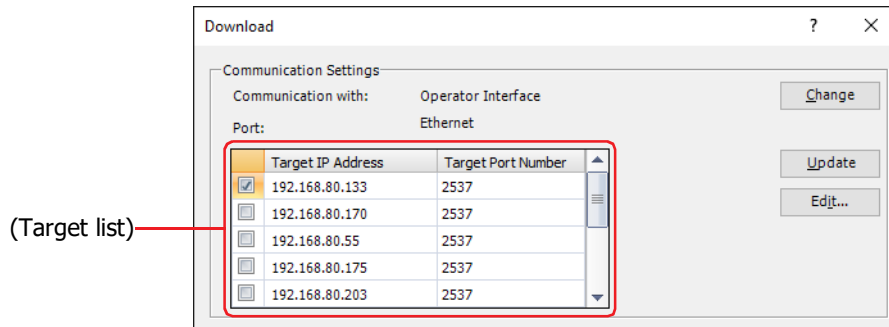

- 2 Open a project to download.



To download a project without opening it, on the **Home** tab, in the **Project** group, click the **Download** icon. The Open dialog box is displayed. Select a file then click **Open**. The Download dialog box is displayed. Proceed to Step 4.



When project data is downloaded to the MICRO/I, the MICRO/I screen data is overwritten.

- 3 On the **Home** tab, in the **Project** group, click the **Download** icon.

The Download dialog box is displayed.

For the HG2J-7U, proceed to step 5.

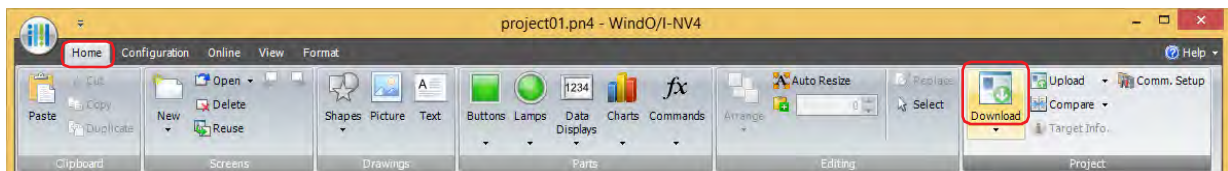

If the project data was changed, a confirmation message to save the project data is displayed.

- Click **OK** to save the project data and display the Download dialog box.
- Click **Cancel** to return to the editing screen without saving the project data.

4 Select data for download under **Download Data**.

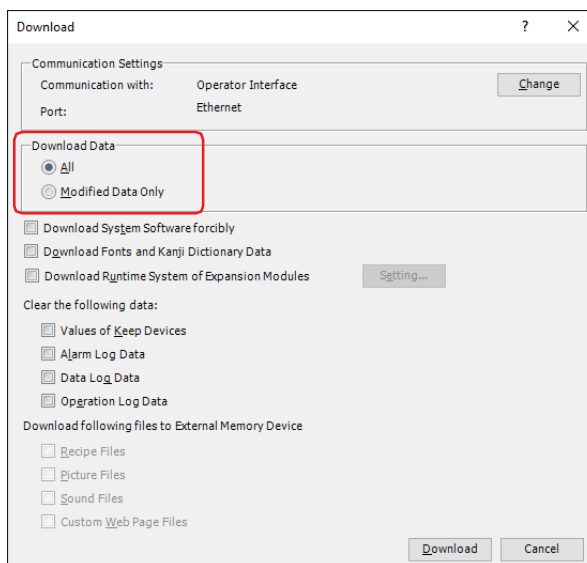

■ **All**

Download the entire project data.

■ **Modified Data Only**

Downloads files modified since the previous download.

If download fails, select **All** to download.

5 Click **Download**.

The project data starts downloading.

However, for HG5G/4G/3G/2G-V, HG4G/3G, HG2G-5F/-5T, HG1G/1P, when **Communicate with** is set to **Operator Interface** and **Port** to **Ethernet**, the Target List dialog box is displayed. Specify the IP address of the MICRO/I, and then click **OK** to start the download. For details, refer to "To download project data" on page 24-7.



If security is enabled in the MICRO/I project, the Enter Password dialog box is displayed. Enter the password. For details, refer to Chapter 23 "User Accounts and the Security Function" on page 23-1.

6 Click **Yes**.

The Download Project dialog box is displayed and downloads the project.

When finished downloading, a completion message is displayed.

7 Click **OK**.

8 Click **Close** on the Download Project dialog box.

This concludes downloading project data.



- Do not turn off the MICRO/I while project data is downloading.
- Turn the power of the MICRO/I off and on and download the project data once again if the following conditions occur:
 - The project data downloading failed, then WindO/I-NV4 cannot communicate with the MICRO/I.
 - The cable was disconnected or the power was turned off while WindO/I-NV4 and the MICRO/I were communicating, and MICRO/I no longer responds



Downloading project data repeatedly with the **Modified Data Only** option consumes the free space in MICRO/I's internal memory.

If there is not enough memory to download the project data with the **Modified Data Only** option, a confirmation message will be displayed.



For details on writing project data to an external memory device inserted in the computer, refer to Chapter 31 "Downloading" on page 31-8.

2.2 Download Dialog Box

This section describes items and buttons of the Download dialog box.

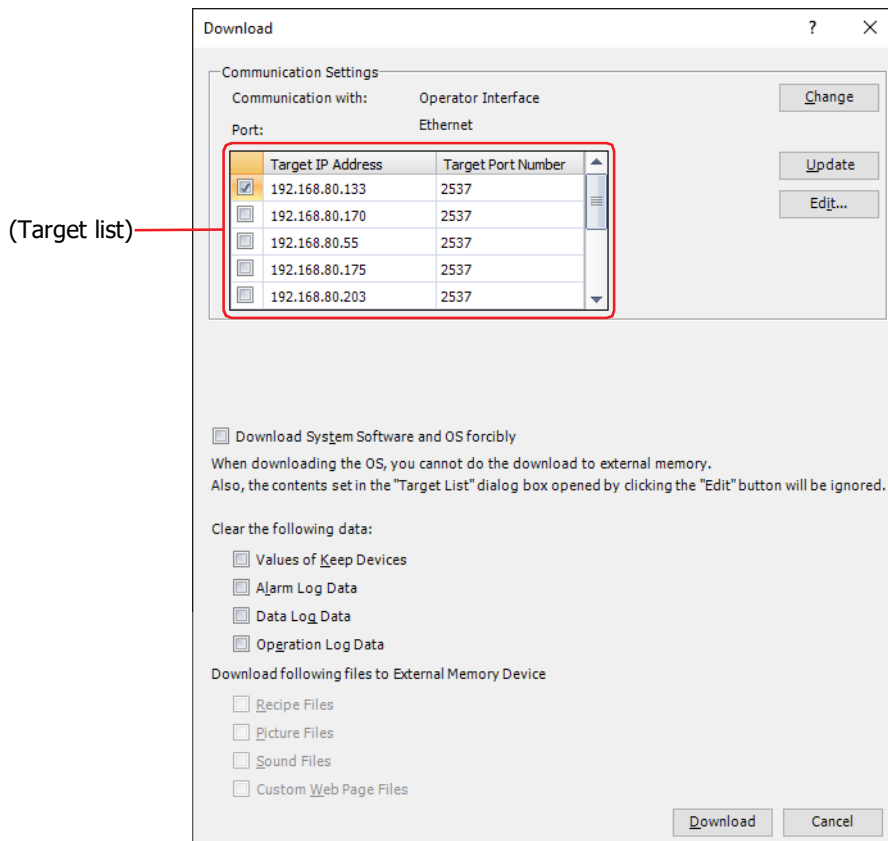

■ Communication Settings

Communicate with: Computer's target device is displayed.

Port: Communication port that is used by computer is displayed.

Change: Changes communication settings. Click this button to display the Communication Settings dialog box. For details, refer to "1.3 Change Communication Settings" on page 24-5.

(Target list)^{*1}: Select the check box of the target to download the project data to.

Can only be set when **Communicate with** is set to **Operator Interface**.

Target IP Address: Displays the current IP address for the MICRO/I to download the project data to.

Target Port Number: Displays the current port number for the MICRO/I to download the project data to.

Update: Updates the (Target list). Click this button to add **Target IP Address** and **Target Port Number** only for the MICRO/I that responded.

Edit: Change the settings of the (Target list). Click this button to open the Target List dialog box.

Specify the Ethernet settings (IP address, subnet mask, default gateway, and port number) for the target MICRO/I. For details, refer to "To download project data" on page 24-7.

*1 HG2J-7U only

■ Download Data*2

Selects data to be downloaded.

All: All project data is downloaded.

Modified Data Only: Only files that were updated since the previous download are downloaded.

If an upload fails, select **All** to download.



Downloading project data repeatedly with the **Modified Data Only** option consumes the free space in MICRO/I's internal memory.

If there is not enough memory to download the project data with the **Modified Data Only** option, a confirmation message will be displayed.

■ Download System Software and OS forcibly*1

Select this check box to forcibly download system software and operating system, regardless of whatever the versions that are downloaded to the MICRO/I, when downloading project data. Normally this option should not be used.



When downloading the operating system, it cannot be downloaded to the external memory device.

Also, the settings configured with the **Target List** dialog box displayed by clicking **Edit** are ignored.

■ Download System Software forcibly*2

Select this check box to force download system software, irrespective of the system software version of the MICRO/I, when downloading project data. Normally this option should not be used.

■ Download Fonts and Kanji Dictionary Data*2

Select this check box to download the following fonts and the dictionary data to the MICRO/I, when downloading project data.

- Standard Fonts
- optional fonts are selected on the **Font/Kanji Dictionary Data** tab in the **Project Settings** dialog box
- Kanji Dictionary Data



When the **Use Kanji dictionary data** check box on the **Font/Kanji Dictionary Data** tab in the **Project Settings** dialog box is not selected, the Kanji dictionary data is not downloaded even if this check box is selected. When this check box is cleared and a project download is executed, deletes the Kanji dictionary data stored in the download destination.

For details, refer to Chapter 4 "3.16 Font/Kanji Dictionary Data Tab" on page 4-76.

■ Download Runtime System of Expansion Modules*3

Select this check box to download the system software of the expansion modules attached to the MICRO/I.

Settings: Specifies the type of expansion module to download the system software. Click this button to display the Runtime System of Expansion Modules dialog box. For details, refer to "Runtime System of Expansion Modules Dialog Box" on page 24-17.

*1 HG2J-7U only

*2 HG5G/4G/3G/2G-V, HG4G/3G, HG2G-5F/-5T, HG1G/1P only

*3 HG5G/4G/3G/2G-V only

■ Clear the following data

Select the values and data to clear after you download project data from the following.

Values of Keep Devices, Alarm Log Data, Data Log Data, Operation Log Data



- When project data that changes the settings of the data storage area or the system software is downloaded, all of the values of Keep Devices and log data are cleared.
- When project data that changes the settings of the Alarm Log Settings, the Data Log Settings or the Operation Log Settings is downloaded, all of the log data are deleted.

■ Download following files to External Memory Device

Recipe Files:

Select this check box to create a **RECIPE** folder or recipe files in the External Memory Device folder on an external memory device inserted in the MICRO/I when downloading projects. Only on channels for which **Save to** in the Recipe Settings dialog box is set to **External Memory Device**, and **Recipe Function** is set to **Use**.

- When **Download Data** is set to **All**, recipe files are created for all channels for which recipe data is set.
- When **Download Data** is set to **Modified Data Only**, only recipe files on channels where recipe data has changed are created.

Picture Files:

Select this check box to create the **PICTURE** folder under the External Memory Device folder on the external memory device inserted in the MICRO/I and to save the picture files when downloading project. Out of the pictures registered in Picture Manager, the picture files that are saved are those picture files that have been selected with the check box on the picture list.

Sound Files^{*4}:

Select this check box to create the **SOUND** folder under the External Memory Device folder on the external memory device inserted in the MICRO/I and to save the sound files when downloading project. The sound files that are saved are those with **Save To** set to **External Memory Device** under settings in the Sound Settings dialog box.

Custom Web Page Files: Select this check box to create the **WEBPAGE** folder under the External Memory Device folder on the external memory device inserted in the MICRO/I and to save the Custom Web Page files when downloading project. The Custom Web Page files that are displayed in the **Web Page Editor** on the **Project** window.

■ Download

The project data starts downloading.

However, for HG5G/4G/3G/2G-V, HG4G/3G, HG2G-5F/-5T, HG1G/1P, when **Communicate with** is set to **Operator Interface** and **Port** to **Ethernet**, the Target List dialog box is displayed. Specify the IP address of the MICRO/I, and then click **OK** to start the download. For details, refer to "To download project data" on page 24-7.

When **Communicate with** is set to **External Memory Device**, the **Select Drive** dialog box is displayed. Select the external memory device drive, then click **OK** to start the download. For details, refer to "2.3 Downloading Files to an External Memory Device Inserted in the MICRO/I" on page 24-18.



Do not turn off the MICRO/I while project data is downloading.



If project data downloading fails and communication is not possible, turn the MICRO/I off and on then download the data once again.

*4 This is applicable for HG2J-7U and models with an audio interface only.

Runtime System of Expansion Modules Dialog Box

HG2J-7U HG5G-V HG4G-V HG4G HG3G-V HG3G HG2G-V HG2G-5F HG2G-5T HG1G HG1P

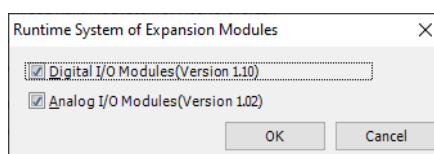

- **Digital I/O module (Version Number)**

Select this check box to download the latest version of the system software to all the digital I/O modules attached to the MICRO/I.

- **Analog I/O module (Version Number)**

Select this check box to download the latest version of the system software to all the analog I/O modules attached to the MICRO/I.

2.3 Downloading Files to an External Memory Device Inserted in the MICRO/I

HG2J-7U HG5G-V HG4G-V HG4G HG3G-V HG3G HG2G-V HG2G-5F HG2G-5T HG1G HG1P

Specified files can be downloaded to an external memory device*¹ inserted in the MICRO/I. The files are downloaded to External Memory Device folder specified in the Project Settings dialog box for the current project.

- 1 Insert the external memory device into the MICRO/I.

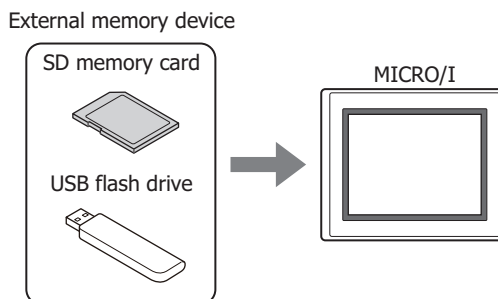

- 2 Change communication settings according to the connection method between the computer and the MICRO/I.
In the **Communication Settings** dialog box, select **Operator Interface** from **Communicate with**. For details, refer to "1.3 Change Communication Settings" on page 24-5.
- 3 On the **Home** tab, in the **Project** group, click the arrow under **Download**.



While editing project data, even if you click the arrow under **Download** in the **Transfer** group on the **Online** tab, the download menu will be displayed.

- 4 Select the method for downloading the file to the external memory device.
The Open dialog box is displayed.

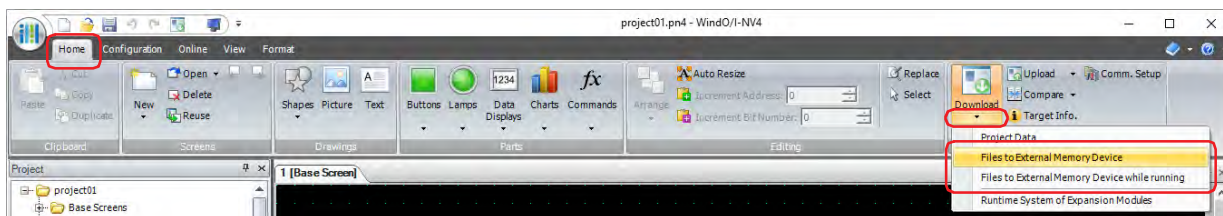

■ Files to External Memory Device

Stops operation of the MICRO/I and downloads the file to the external memory device inserted in the MICRO/I. When the file download is complete, operation resumes.

■ Files to External Memory Device while running

Downloads the file to the external memory device inserted in the MICRO/I without stopping operation of the MICRO/I.

*1 USB flash drive inserted in USB1 for HG2J-7U, SD memory card for HG5G/4G/3G/2G-V, HG4G/3G and HG2G-5F, USB flash drive for HG2G-5T and HG1G/1P

5 Select the file, and then click **Open**.

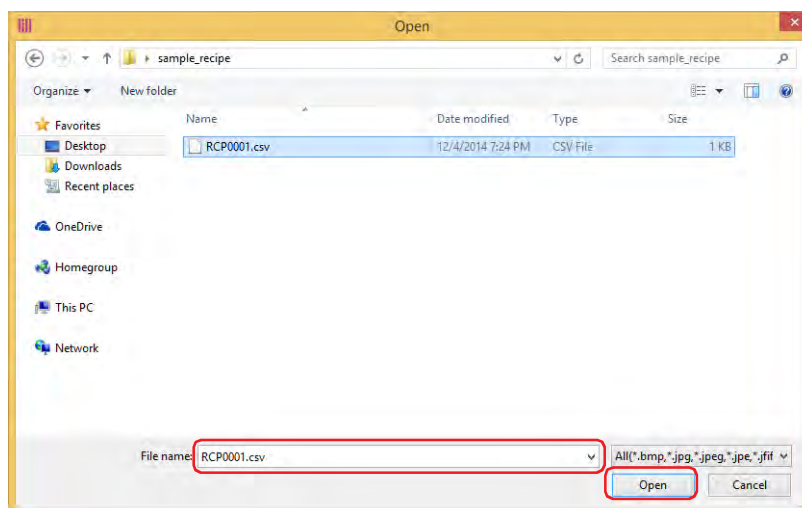

- When **Communicate with** is set to **Operator Interface** and **Port** is set to **USB**^{*2}, the file starts downloading.
- When **Communicate with** is set to **Operator Interface** and **Port** is set to **Ethernet**, the Target IP Address dialog box is displayed. Specify the IP address of the MICRO/I, and then click **OK** to start the download. For details, refer to "To execute a function other than the project data download" on page 24-10.



- If security is enabled in the MICRO/I project, the Password Screen is displayed. Select the user name and enter the password. For details, refer to Chapter 23 "User Accounts and the Security Function" on page 23-1.
- WindO/I-NV4 only allows file with alphanumeric characters and symbols used for its file name. However, the file name with the following characters cannot be downloaded to the external memory device.
 HG2J-7U: " # \$ & ' () * / : ; < > ? \ ` | ~
 Two consecutive periods
 HG5G/4G/3G/2G-V, HG4G/3G, HG2G-5F/-5T, HG1G/1P: " * / : < > ? \ |

6 Click **Yes**.

The **Download** dialog box is displayed and downloads the file.
When finished downloading, a completion message is displayed.

7 Click **OK**.

8 Click **Close** in the **External Memory Device Maintenance** dialog box.



To create a recipe file on an external memory device inserted in the computer, use **Save Recipe Files in External Memory Device** in the **Recipe Settings** dialog box. For details, refer to Chapter 18 "Creating Recipe Files in the Recipe Settings Dialog Box" on page 18-17.

*2 HG5G/4G/3G/2G-V, HG4G/3G, HG2G-5F/-5T, HG1G/1P only

2.4 Downloading the System Software of Expansion Modules

HG2J-7U HG5G-V HG4G-V HG4G HG3G-V HG3G HG2G-V HG2G-5F HG2G-5T HG1G HG1P

Downloads the latest version of the system software to expansion modules attached to the MICRO/I.

- 1 Change communication settings according to the connection method between the computer and the MICRO/I.

In the **Communication Settings** dialog box, select **Operator Interface** from **Communicate with**. For details, refer to "1.3 Change Communication Settings" on page 24-5.

- 2 On the **Home** tab, in the **Project** group, click the arrow under **Download**.



While editing project data, even if you click the arrow under **Download** in the **Transfer** group on the **Online** tab, the download menu will be displayed.

- 3 Click the **Runtime System of Expansion Modules**.

The Runtime System of Expansion Modules dialog box is displayed.

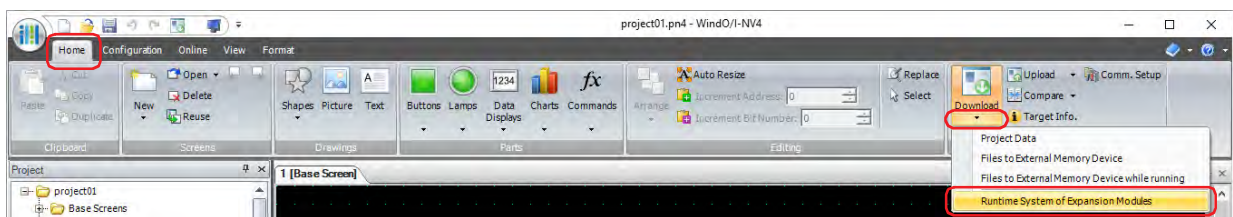

- 4 Selects the check box for the expansion module that downloads the latest version of the system software, and then click the **OK**.

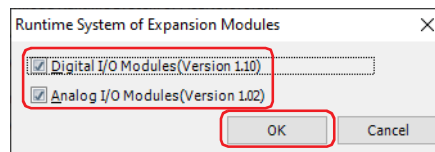

■ Digital I/O module (Version Number)

Select this check box to download the latest version of the system software to all the digital I/O modules attached to the MICRO/I.

■ Analog I/O module (Version Number)

Select this check box to download the latest version of the system software to all the analog I/O modules attached to the MICRO/I.

- When **Communicate with** is set to **Operator Interface** and **Port** to **USB**, the Runtime System of Expansion Modules starts downloading.
- When **Communicate with** is set to **Operator Interface** and **Port** to **Ethernet**, the Target IP Address dialog box is displayed. Specify the IP address of the MICRO/I, and then click **OK** to start the download. For details, refer to "To execute a function other than the project data download" on page 24-10.



If security is enabled in the MICRO/I project, the Password Screen is displayed. Select the user name and enter the password. For details, refer to Chapter 23 "User Accounts and the Security Function" on page 23-1.

- 5 Click **Yes**.

The Runtime System of Expansion Modules dialog box is displayed and downloads the system software. When finished downloading, a completion message is displayed.

- 6 Click **OK**.

- 7 Click **Close** in the Runtime System of Expansion Modules dialog box.

3 Uploading

HG2J-7U HG5G-V HG4G-V HG4G HG3G-V HG3G HG2G-V HG2G-5F HG2G-5T HG1G HG1P

Project data in the MICRO/I or in an external memory device inserted in a computer can be read using WindO/I-NV2 and saved to the computer.

3.1 Upload Project Data from the MICRO/I

- 1 Change communication settings according to the connection method between the computer and the MICRO/I.
In the **Communication Settings** dialog box, select **Operator Interface** from **Communicate with**. For details, refer to "1.3 Change Communication Settings" on page 24-5.
- 2 On the **Home** tab, in the **Project** group, click the **Upload** icon.



While editing project data, project data can be uploaded from the MICRO/I even by clicking the **Upload** icon in the **Transfer** group on the **Online** tab.

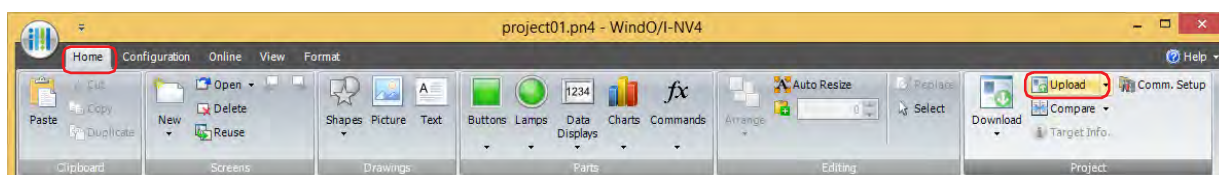

If project data is being edited, project data will be closed. If the project data was changed, a confirmation message to save the project data is displayed.

- Click **Yes** to save the project data and display a dialog box corresponding to the communication settings.
- Click **No** to close the project data without saving changes and display a dialog box corresponding to the communication settings.
- Click **Cancel** to stop uploading and return to the editing screen without saving the project data.

- When **Communicate with** is set to **Operator Interface** and **Port** is set to **USB**^{*1}, the Upload dialog box is displayed.
- When **Communicate with** is set to **Operator Interface** and **Port** is set to **Ethernet**, the Target IP Address dialog box is displayed. Specify the IP address of the MICRO/I, and then click **OK** to start the upload. For details, refer to "To execute a function other than the project data download" on page 24-10.



If security is enabled in the MICRO/I project, the Password Screen is displayed. Enter the password.
For details, refer to Chapter 23 "User Accounts and the Security Function" on page 23-1.

*1 HG5G/4G/3G/2G-V, HG4G/3G, HG2G-5F/-5T, HG1G/1P only

3 Check the project data details, and then click **Upload**.

If there is a project file with the same file name in the upload folder, an overwrite confirmation message is displayed.

- Click **Yes** to start uploading the project data.
- Click **Cancel** to stop uploading the project data.

When finished uploading, a completion message is displayed.

■ **Project Name**

The project is saved with the currently displayed name. To change the project name, enter a new name for the file. The maximum number is 50 characters.



You cannot use the following characters in the project name.

" * / : < > ? \ |

■ **Location**

The uploaded project file is saved to the currently displayed location. To change the location of the saved file, click **...**. The **Browse folders** dialog box is displayed. Select a location, and then click **OK**.

4 Click **OK**.

5 Click **Close** on the Upload dialog box.

A confirmation message to open the project is displayed.

6 Click **OK**.

The uploaded project opens.

This concludes uploading of project data.



If a password has been configured for the project data, the Enter Password screen will be displayed. Enter the password for projects created with WindO/I-NV4 Ver. 1.11.4 or earlier using only 4 to 15 uppercase letters and numbers.

The password to enter varies based on the check box setting of the **Use Password to open a Project** found under the **Options** tab in the **Security** dialog box.

When this check box is selected, enter the password for **Use Password to open a Project**.

When this check box is cleared, enter the password for the user account assigned to the Administrator security group.

For details, refer to Chapter 23 "User Accounts and the Security Function" on page 23-1.



For details on reading project data saved on an external memory device using WindO/I-NV4, refer to Chapter 31 "Uploading" on page 31-9.

3.2 Upload Dialog Box

This section describes the settings and buttons of the Upload dialog box.

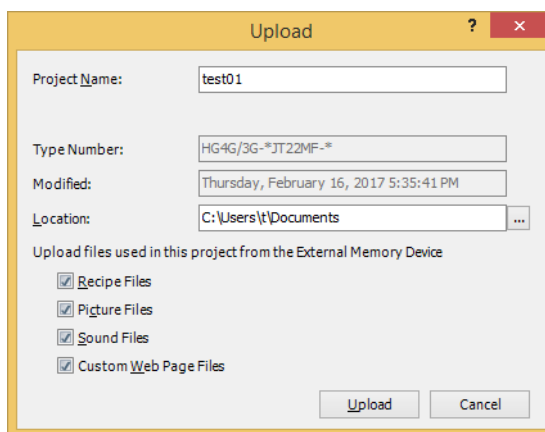

■ Project Name

The project is saved with the currently displayed name. To change the project name, enter a new name for the file. The maximum number is 50 characters.



You cannot use the following characters in the project name.

" * / : < > ? \ |

■ Type Number

Displays the type number selected in project data downloaded to the MICRO/I.

■ Modified

Displays the time that project data downloaded to the MICRO/I was last saved in WindO/I-NV4.

■ Location

Specifies the location for saving uploaded project files.

Click  to display the **Browse folders** dialog box. Select the location for saving, then click **OK**.

■ Upload files used in this project from the External Memory Device

To upload files located on an external memory device inserted in the MICRO/I that are used by the project together with project data, select the file to be uploaded from the following.

Recipe Files, Picture Files, Sound Files^{*1}, Custom Web Page Files

■ Upload

Starts uploading of project data.

■ Cancel

Stops uploading of project data.

*1 This is applicable for HG2J-7U and models with an audio interface only.

3.3 Uploading Files from an External Memory Device Inserted in the MICRO/I

Specified data can be uploaded from the External Memory Device folder on the external memory device for the currently running project.

- 1 Insert the external memory device into the MICRO/I.

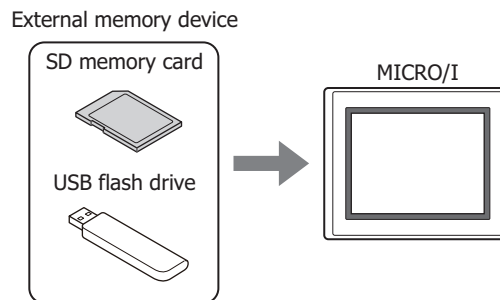

- 2 Change communication settings according to the connection method between the computer and the MICRO/I.

In the **Communication Settings** dialog box, select **Operator Interface** from **Communicate with**. For details, refer to "1.3 Change Communication Settings" on page 24-5.

- 3 On the **Home** tab, in the **Project** group, click the arrow next to **Upload**.



Even if you click the arrow under **Upload** in the **Transfer** group on the **Online** tab, the upload menu will be displayed.

- 4 Click **Stored Data in External Memory Device**.

The **Upload from External Memory Device** dialog box appears.



- 5 Select the items to be uploaded, and then specify the destination folder in the **Location** box.

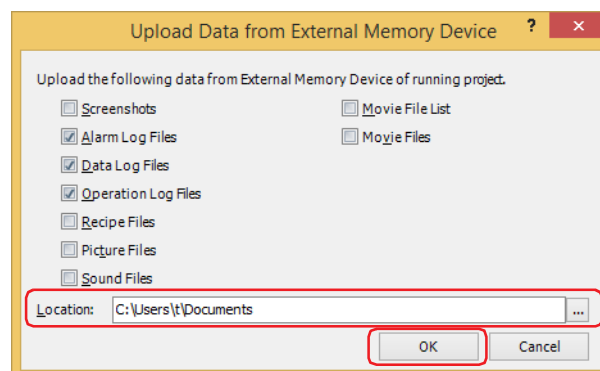

Uploadable data is as follows.

- Screenshots
- Alarm Log Files
- Data Log Files
- Operation Log Files
- Recipe Files
- Picture Files
- Sound Files*¹
- Movie File List*²
- Movie Files*²



If security is enabled for the project on MICRO/I, a dialog appears for you to enter a user name and password. For details, refer to Chapter 23 "User Accounts and the Security Function" on page 23-1.



- Click  to call up the Select a Folder dialog box and specify the destination folder for uploading.
- After starting WindO/I-NV4, screen shots, alarm log data, data log data, and recipe files can be uploaded from an External Memory Device folder without opening project data.

6 Click **OK**.

The External Memory Device Maintenance dialog box appears and the data upload begins.

A message box appears when the data upload is complete.

7 Click **OK**.

8 Click **Close** on the **External Memory Device Maintenance** dialog box.

*1 This is applicable for HG2J-7U and models with an audio interface only.

*2 This is applicable for models with a video interface only.

4 Clear

HG2J-7U HG5G-V HG4G-V HG4G HG3G-V HG3G HG2G-V HG2G-5F HG2G-5T HG1G HG1P

Deletes data from the MICRO/I or from an external memory device^{*1} inserted in the MICRO/I.

4.1 Clear Data from the MICRO/I

- 1 Change communication settings according to the connection method between the computer and the MICRO/I. In the **Communication Settings** dialog box, select **Operator Interface** from **Communicate with**. For details, refer to "1.3 Change Communication Settings" on page 24-5.
- 2 Open project data.
- 3 On the **Online** tab, in the **MICRO/I** group, click **Clear**, then click the data to be deleted.

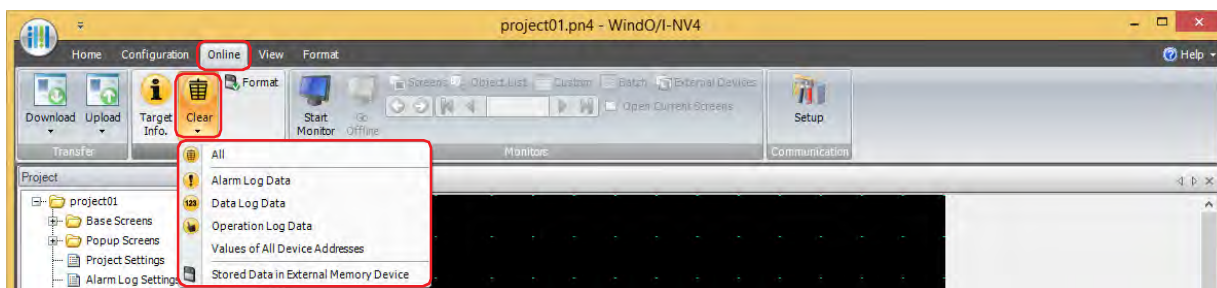

- **All**
Deletes project data, Alarm Log data, Data Log data, and Operation Log data. It also clears the values from all device addresses.
- **Alarm Log Data**
Deletes the data collected by the Alarm Log function.
- **Data Log Data**
Deletes the data collected by the Data Log function.
- **Operation Log Data**
Deletes the data collected by the Operation Log function.
- **Values of All Device Addresses**
Clears the values of all device addresses.
- **Stored Data in External Memory Device**
After stopping operation, deletes data saved to the External Memory Device folder on an external memory device. Click this to display the Clear Data dialog box. For details, refer to "4.2 Deleting Data from an External Memory Device Inserted in the MICRO/I" on page 24-27.
 - When **Communicate with** is set to **Operator Interface** and **Port** to **USB**^{*2}, deletion of the data starts.
 - When **Communicate with** is set to **Operator Interface** and **Port** is set to **Ethernet**, the Target IP Address dialog box is displayed. Specify the IP address of the MICRO/I, and then click **OK** to start deletion of the data. For details, refer to "To execute a function other than the project data download" on page 24-10.



If security is enabled in the MICRO/I project, the Password Screen is displayed. Enter the password. For details, refer to Chapter 23 "User Accounts and the Security Function" on page 23-1.

- 4 Click **Yes**.
- 5 Click **Close**.
This concludes clearing data.

*1 USB flash drive inserted in USB1 for HG2J-7U, SD memory card for HG5G/4G/3G/2G-V, HG4G/3G and HG2G-5F, USB flash drive for HG2G-5T and HG1G/1P

*2 HG5G/4G/3G/2G-V, HG4G/3G, HG2G-5F/-5T, HG1G/1P only

4.2 Deleting Data from an External Memory Device Inserted in the MICRO/I

HG2J-7U HG5G-V HG4G-V HG4G HG3G-V HG3G HG2G-V HG2G-5F HG2G-5T HG1G HG1P

- 1 Change communication settings according to the connection method between the computer and the MICRO/I.
In the Communication Settings dialog box, select **Operator Interface** from **Communicate with**. For details, refer to "1.3 Change Communication Settings" on page 24-5.
- 2 Open project data.
- 3 On the **Online** tab, in the **MICRO/I** group, click **Clear**, then click **Stored Data in External Memory Device**.
The Clear Data dialog box is displayed.

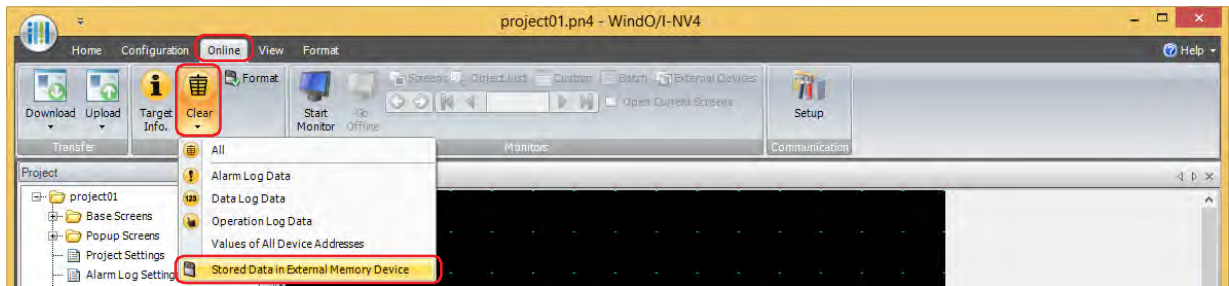

- 4 Select the check box for the data items to be deleted from the External Memory Device folder.
Screenshot, Alarm Log files, Data Log files, Operation Log files, and Recipe Files

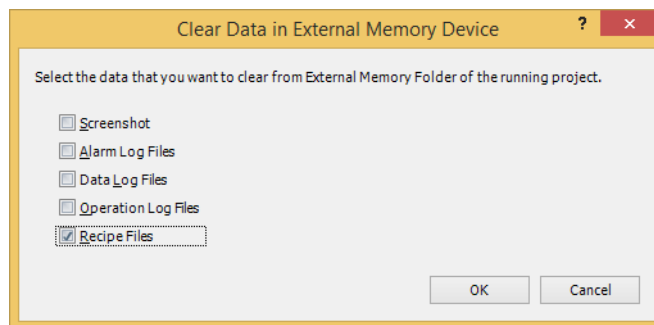

- 5 Click **OK**.
 - When **Communicate with** is set to **Operator Interface** and **Port** to **USB**^{*1}, deletion of the data starts.
 - When **Communicate with** is set to **Operator Interface** and **Port** is set to **Ethernet**, the Target IP Address dialog box is displayed. Specify the IP address of the MICRO/I, and then click **OK** to start deletion of the data. For details, refer to "To execute a function other than the project data download" on page 24-10.



If security is enabled in the MICRO/I project, the Password Screen is displayed. Enter the password. For details, refer to Chapter 23 "User Accounts and the Security Function" on page 23-1.

- 6 Click **Yes**.
- 7 Click **Close**.
This concludes clearing data on the external memory device.

*1 HG5G/4G/3G/2G-V, HG4G/3G, HG2G-5F/-5T, HG1G/1P only

5 Formatting

HG2J-7U HG5G-V HG4G-V HG4G HG3G-V HG3G HG2G-V HG2G-5F HG2G-5T HG1G HG1P

Stops operation of the MICRO/I and formats an external memory device^{*1} inserted in the MICRO/I.

5.1 Formatting an External Memory Device Inserted in the MICRO/I

- 1 Change communication settings according to the connection method between the computer and the MICRO/I.
If communicating with a MICRO/I inserted in a computer, in the Communication Settings dialog box, select **Operator Interface** from **Communicate with**. For details, refer to "1.3 Change Communication Settings" on page 24-5.
- 2 Open project data.
- 3 On the **Online** tab, in the **MICRO/I** group, click **Format**.

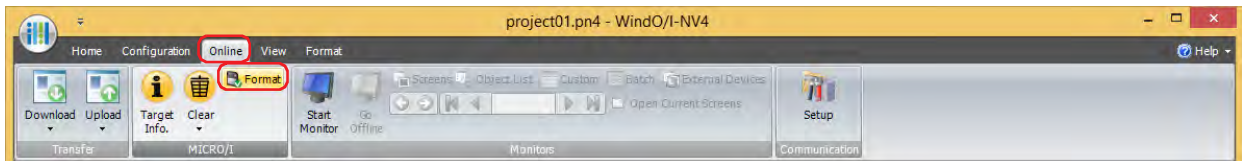

- When **Communicate with** is set to **Operator Interface** and **Port** is set to **USB**, a formatting confirmation message is displayed.
- When **Communicate with** is set to **Operator Interface** and **Port** is set to **Ethernet**, the Target IP Address dialog box is displayed. Specify the IP address of the MICRO/I, and then click **OK** to display the formatting confirmation message. For details, refer to "To execute a function other than the project data download" on page 24-10.



If security is enabled in the MICRO/I project, the Password Screen is displayed. Enter the password. For details, refer to Chapter 23 "User Accounts and the Security Function" on page 23-1.

- 4 Click **Yes**.
- 5 Click **Close**.

This concludes formatting the external memory device.

*1 SD memory card for HG5G/4G/3G/2G-V, HG4G/3G and HG2G-5F, USB flash drive for HG2G-5T and HG1G/1P

6 System Information

HG2J-7U HG5G-V HG4G-V HG4G HG3G-V HG3G HG2G-V HG2G-5F HG2G-5T HG1G HG1P

Displays information about the system software and downloaded project data of the MICRO/I.

This function can be used to show information about project data during editing and to simultaneously check details of project data downloaded to the MICRO/I.

6.1 Displaying System Information

- 1 Change communication settings according to the connection method between the computer and the MICRO/I.
If communicating with a MICRO/I inserted in a computer, in the Communication Settings dialog box, select **Operator Interface** from **Communicate with**. For details, refer to "1.3 Change Communication Settings" on page 24-5.
- 2 On the **Home** tab, in the **Project** group, click **Target Info.**

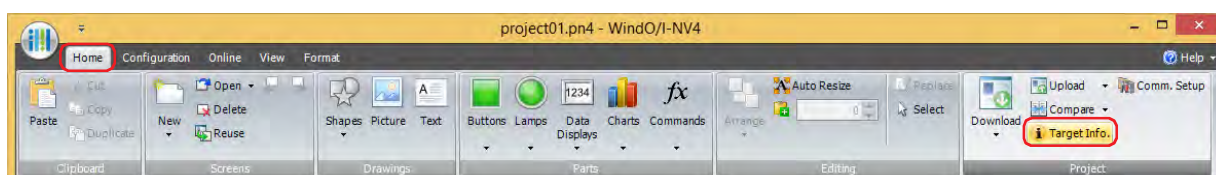

While editing project data, information about system software and project data can be displayed even by clicking **Target Info.** in the **MICRO/I** group on the **Online** tab.

- When **Communicate with** is set to **Operator Interface** and **Port** is set to **USB**^{*1}, the System Information dialog box is displayed.
- When **Communicate with** is set to **Operator Interface** and **Port** is set to **Ethernet**, the Target IP Address dialog box is displayed. Specify the IP address of the MICRO/I, and then click **OK** to display the System Information dialog box. For details, refer to "To execute a function other than the project data download" on page 24-10.

*1 HG5G/4G/3G/2G-V, HG4G/3G, HG2G-5F/-5T, HG1G/1P only

3 Check information about the system software and project data.

The screenshot shows a 'Target Information' dialog box with the following fields and buttons:

- Target Runtime Information:**
 - Type Number: HG2J-7JT22TF-B
 - System Software Version: [Empty]
 - OS Version: [Empty]
 - Memory Space: 25,165,824 bytes
 - External Memory Device Information: [Button]
- Operator Interface Project Information:**
 - Project Name: project01
 - Modified: Saturday, September 18, 2021 10:44:08 AM
 - WindO/I-NV4 Version: [Empty]
 - Communication Driver Information: [Button]
- Opened Project Information:**
 - Project Name: project02
 - Modified: Wednesday, September 22, 2021 8:46:00 AM
 - WindO/I-NV4 Version: [Empty]

An 'OK' button is located at the bottom right of the dialog.



- To check the optional fonts installed on the MICRO/I and the Kanji dictionary data, click **Font/Kanji Dictionary Data Information** to display the Font Information dialog box. The Font Information dialog box is displayed. For details, refer to "Font/Kanji Dictionary Data Information Dialog Box" on page 24-32.
- To check information about the external memory device inserted in the MICRO/I, click **External Memory Device Information** to display the External Memory Device Information dialog box. For details, refer to "External Memory Device Information Dialog Box" on page 24-33.
- To check information about the expansion modules attached to the MICRO/I, click **Expansion Module Information** to display the Expansion Module Information dialog box. For details, refer to "External Memory Device Information Dialog Box" on page 24-33.
- To check the communication driver set for the project that is downloaded to the MICRO/I, click **Communication Driver Information** to display the Communication Driver Information dialog box. For details, refer to "Communication Driver Information Dialog Box" on page 24-34.

4 When you have finished checking the information, click **OK**.

5 Click **Close**.

This concludes checking system information.

6.2 Target Information Dialog Box

This section describes the settings and buttons of the Target Information dialog box.

■ Target Runtime Information

- | | |
|--|--|
| Type Number: | Displays the type number of MICRO/I |
| System Software Version: | Displays the system software version of the MICRO/I. |
| OS Version ^{*1} : | Displays the operating system version of the MICRO/I. |
| Memory Space: | Displays the maximum amount of project data (bytes) that can be downloaded to the MICRO/I. |
| Font/Kanji Dictionary Data Information ^{*2} : | Checks the optional fonts and the Kanji dictionary data currently installed on the MICRO/I. Click this button to display the Font Information dialog box. For details, refer to "Font/Kanji Dictionary Data Information Dialog Box" on page 24-32. |
| External Memory Device Information: | Checks the state of an external memory device inserted in the MICRO/I, its total capacity, available capacity, and used capacity. Click this button to display the External Memory Device Information dialog box. For details, refer to "External Memory Device Information Dialog Box" on page 24-33. |
| Expansion Module Information ^{*3} : | Check the part number, the type and the system software version of the expansion modules attached to the MICRO/I. Click this button to display the Expansion Module Information dialog box. For details, refer to "Expansion Module Information Dialog Box" on page 24-33. |

*1 HG2J-7U only

*2 HG5G/4G/3G/2G-V, HG4G/3G, HG2G-5F/-5T, HG1G/1P only

*3 HG5G/4G/3G/2G-V only

■ Operator Interface Project Information

Project Name:	Displays the project name of projects downloaded to the MICRO/I.
Modified:	Displays the time that project data downloaded to the MICRO/I was last saved in WindO/I-NV4.
WindO/I-NV4 Version:	Displays the version of WindO/I-NV4 used to create the project data downloaded to the MICRO/I.
Communication Driver Information:	Checks the communication driver configured in the project downloaded to the MICRO/I. Click this button to display the Target Communication Driver Information dialog box. For details, refer to "Communication Driver Information Dialog Box" on page 24-34.

■ Opened Project Information

Project Name:	Displays the project name of the project being edited.
Modified:	Displays the time that the project being edited was last saved in WindO/I-NV4.
WindO/I-NV4 Version:	Displays the version of WindO/I-NV4 used to create the project being edited.



This function can be used to show information about a project that is being edited and simultaneously check information about project data downloaded to the MICRO/I.

Font/Kanji Dictionary Data Information Dialog Box

HG2J-7U HG5G-V HG4G-V HG4G HG3G-V HG3G HG2G-V HG2G-5F HG2G-5T HG1G HG1P

This dialog box is used to check the state of installed optional fonts and the Kanji dictionary data.

Optional Font:	Installation Status
High-quality Japanese Font (First standard):	Not Installed
High-quality Japanese Font (Second standard):	Not Installed
Simplified Chinese:	Installed
Traditional Chinese:	Not Installed
Hangul:	Not Installed
High-quality Western Font:	Installed
Central European:	Not Installed
Baltic:	Not Installed
Cyrillic:	Not Installed
Kanji Dictionary Data:	Not Installed

The installation status of each optional font and the Kanji dictionary data are shown to the right of the font. The following additional fonts can be installed.

- Japanese Large Font (First standard)
- Japanese Large Font (Second standard)
- Simplified Chinese
- Traditional Chinese
- Hangul
- European Large Font
- Central European
- Baltic
- Cyrillic

External Memory Device Information Dialog Box

HG2J-7U HG5G-V HG4G-V HG4G HG3G-V HG3G HG2G-V HG2G-5F HG2G-5T HG1G HG1P

Checks the state of an external memory device*¹ inserted in the MICRO/I, its total capacity, used capacity, and available capacity.

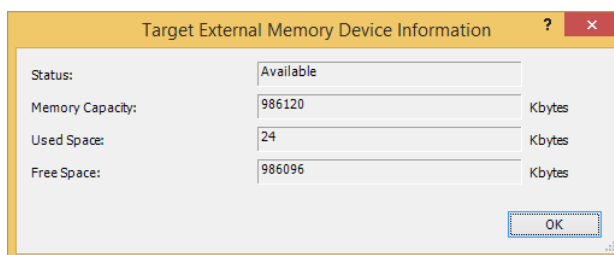

- Status:** Displays the state of the external memory device inserted in the MICRO/I.
- Memory Capacity:** Displays the total capacity of the external memory device inserted in the MICRO/I.
- Used Space:** Displays how much of the capacity of the external memory device inserted in the MICRO/I is currently in use.
- Free Space:** Displays how much of the capacity of the external memory device inserted in the MICRO/I is currently available for use.

Expansion Module Information Dialog Box

HG2J-7U HG5G-V HG4G-V HG4G HG3G-V HG3G HG2G-V HG2G-5F HG2G-5T HG1G HG1P

Check the part number, the type and the system software version of the expansion modules attached to the MICRO/I.



■ **Slot 1 to 4**

Display the **In Use** when the expansion module is attached to the expansion module interface of the MICRO/I, the **Not in use** when the expansion module is not attached.

The **In Use** displays the **Part Number**, the **Type** and the **Version**.

Part Number: Displays the part number of the expansion module attached to the MICRO/I.

Type: Displays the type of the expansion module attached to the MICRO/I.

Version: Displays the system software version of the expansion module attached to the MICRO/I.

*1 USB flash drive inserted in USB1 for HG2J-7U, SD memory card for HG5G/4G/3G/2G-V, HG4G/3G and HG2G-5F, USB flash drive for HG2G-5T and HG1G/1P

Communication Driver Information Dialog Box**HG2J-7U HG5G-V HG4G-V HG4G HG3G-V HG3G HG2G-V HG2G-5F HG2G-5T HG1G HG1P**

Checks the communication driver configured in the project downloaded to the MICRO/I.

External Device Communication	Manufacturer	Communication Driver	Communication Driver Version
External Device Communication 1	IDEC	OpenNet, MicroSmart, SmartAXIS Pro/Lite(RS232C/485)	49.5
External Device Communication 2	Not Use	Not Use	49.5
External Device Communication 3	Not Use	Not Use	49.5
External Device Communication 4	Not Use	Not Use	49.5

■ External Device Communication 1 to 4

- Manufacturer: Displays the manufacturer of the external device.
- Communication Driver: Displays the communication driver.
- Communication Driver Version: Displays the communication driver version.

Chapter 25 Monitor Function

This chapter describes the monitor function that checks operation of the created project data.

Monitor function enables the values of internal devices and the values of the external device addresses to be checked and changed. This can be done in two ways: using WindO/I-NV4 on a computer connected to the MICRO/I, or directly on the screen of the MICRO/I.

1 Monitoring with WindO/I-NV4

HG2J-7U HG5G-V HG4G-V HG4G HG3G-V HG3G HG2G-V HG2G-5F HG2G-5T HG1G HG1P

1.1 How the Monitor Function in WindO/I-NV4 is Used

Monitor function in WindO/I-NV4 can be performed as follows.

- Checking values of device addresses used on the screen of the MICRO/I

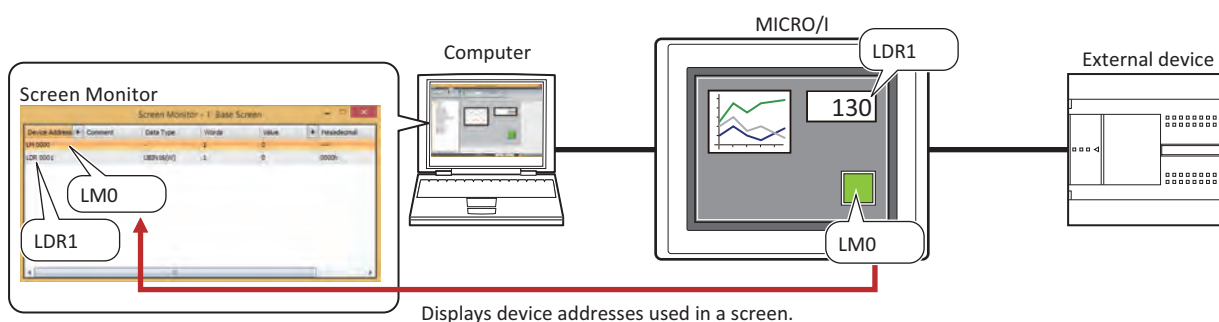

- Checking values of specified device addresses

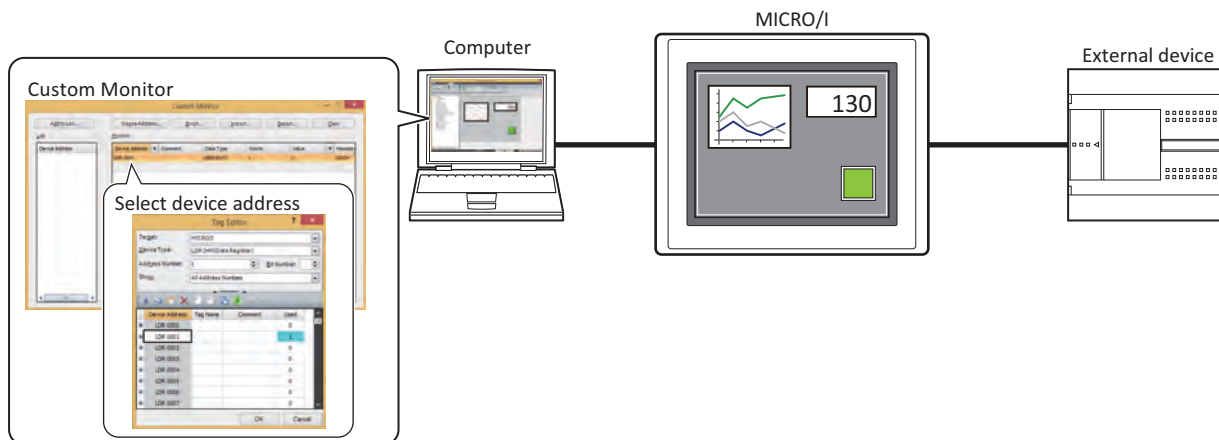

- Checking values of device addresses of sequential address numbers

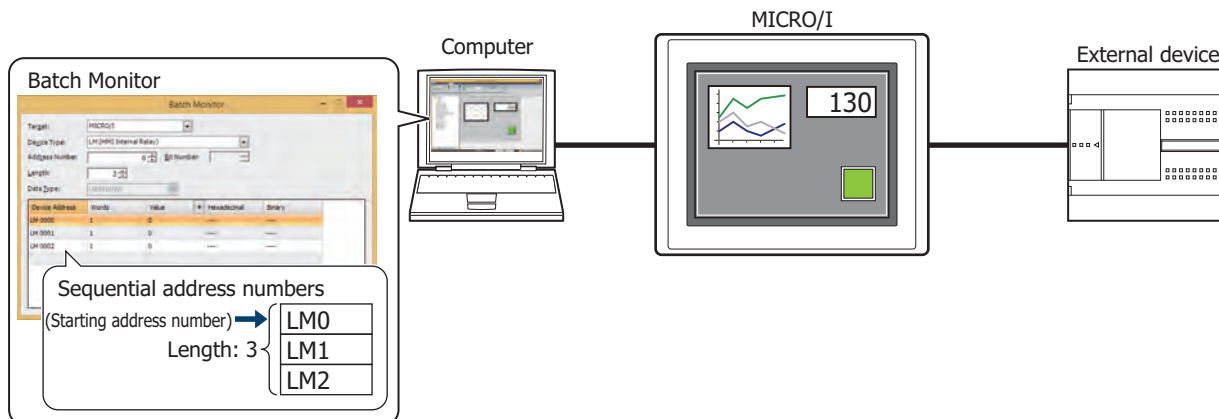

- Checking the state of external devices connected to the MICRO/I

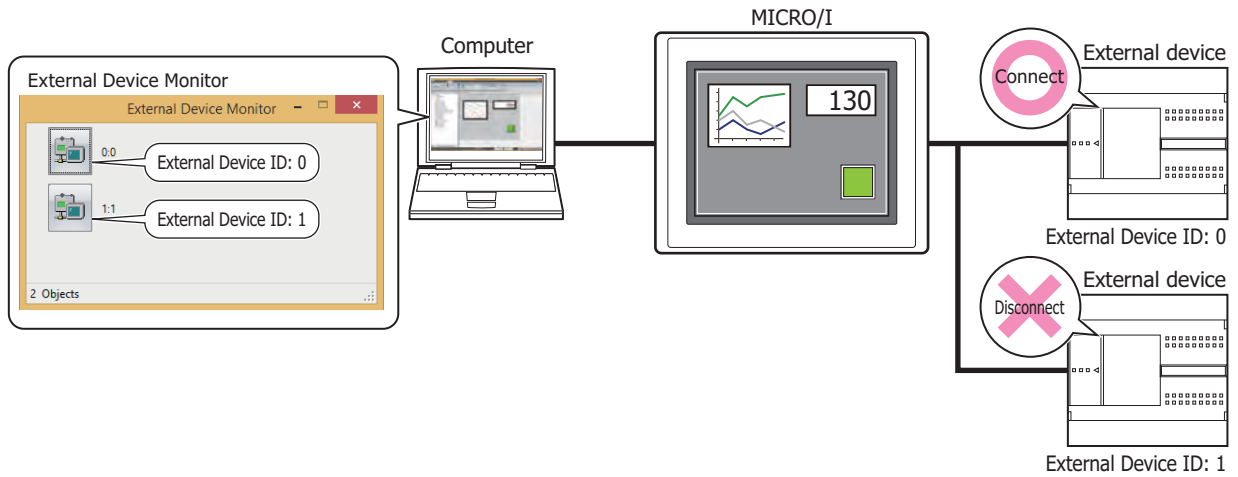

- Displaying the value of device address in a popup

Object List window

No.	Name	Type	Device Address	Trigger Type
1	BitButton1	Bit Button	LDR 0000-00	6:While satisfying the con
2	BitButton2	Bit Button	LM 0000	3:Always Enabled

LM 0000=0
Popup

Script Editor

```

Script ID: 1
Script Name: Script01
Script:
if([LDR 0100] == 10)
{
[LDR 0101] = [LDR 0101] + 1;
}
                    
```

0(0000h)
Popup

- Highlighting objects while satisfying conditions

X
 Not satisfied
 Condition

No.	Name	Type	Device Address	Trigger Type	Trigger Condition	Trigger Type (Visible Condition)	Trigger Condition (Visible Condition)
1	BitButton1	Bit Button	LDR 0000-00	6:While satisfying the condition	[LM 0000] == 1	3:Always Visible	3:Always Visible
2	BitButton2	Bit Button	LM 0000	3:Always Enabled		3:Always Visible	3:Always Visible

Trigger Condition
While satisfying the condition: LM0==1

↓

S
 Satisfied
 Condition

No.	Name	Type	Device Address	Trigger Type	Trigger Condition	Trigger Type (Visible Condition)	Trigger Condition (Visible Condition)
1	BitButton1	Bit Button	LDR 0000-00	6:While satisfying the condition	[LM 0000] == 1	3:Always Visible	3:Always Visible
2	BitButton2	Bit Button	LM 0000	3:Always Enabled		3:Always Visible	3:Always Visible

Highlighted

Screen Monitor - 1 Base Screen

Device Address	Comment	Data Type	Words	Value
LDR 0000-00			1	0
LM 0000			1	1

LM0 = 0 → 1

- Switching to the screen of the MICRO/I

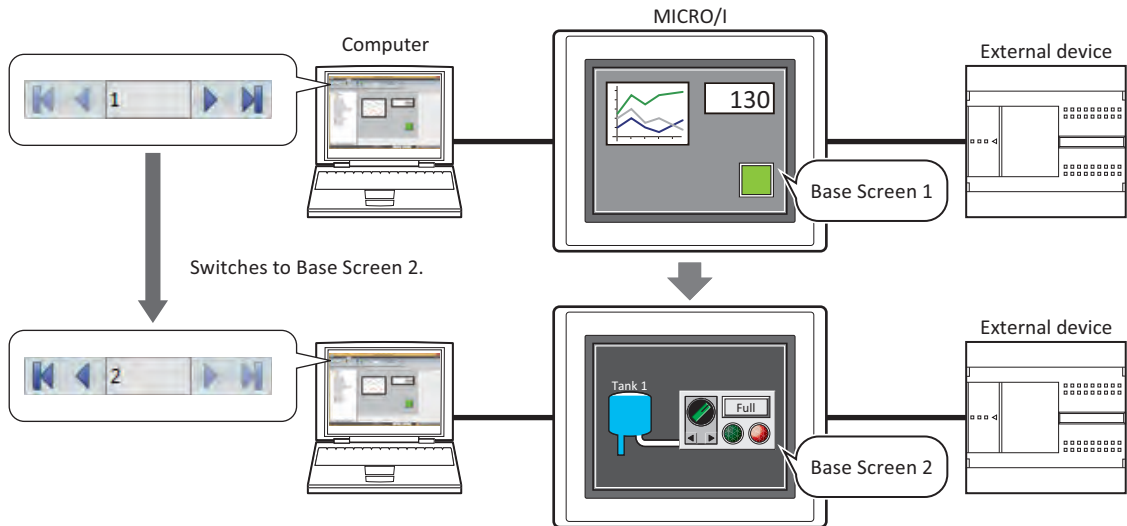

- Opening current screen

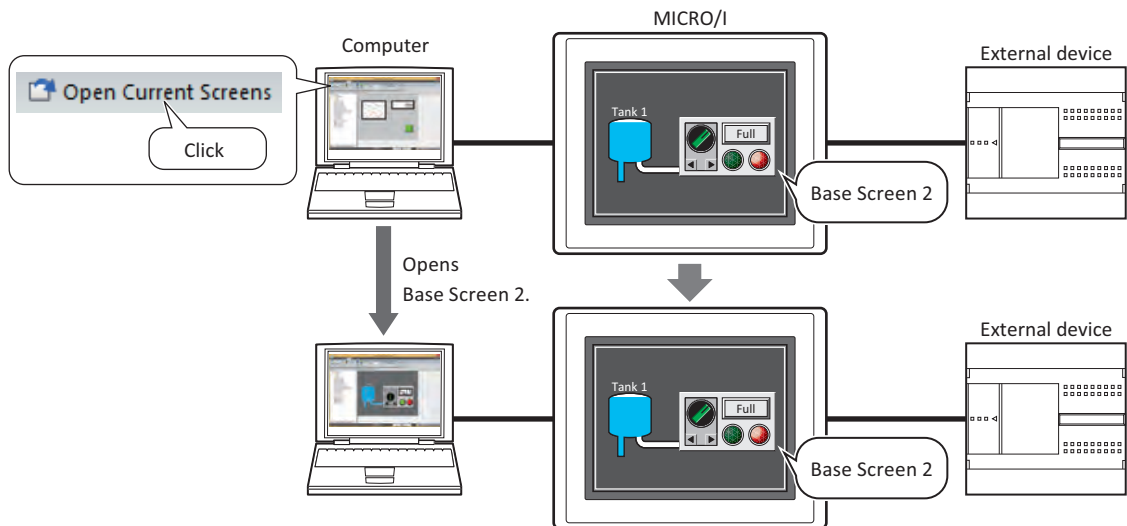

- Change values of device addresses and check the operation of project data offline

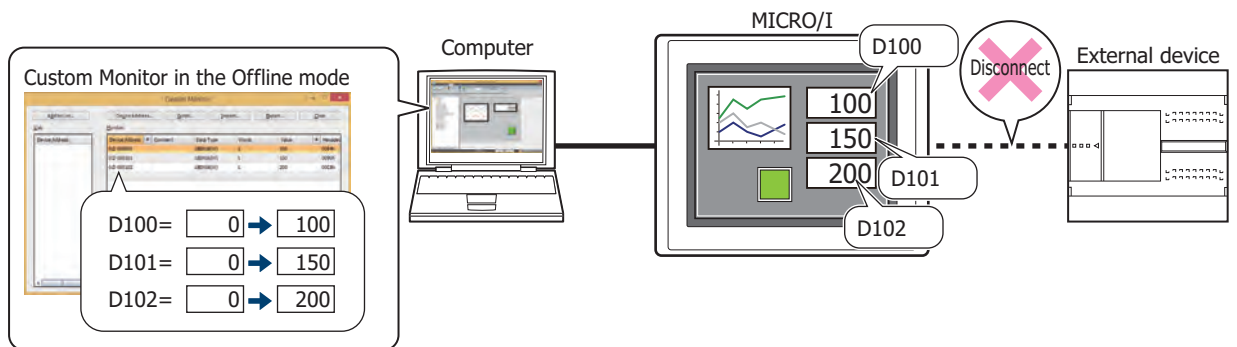

1.2 Debugging in WindO/I-NV4

This section describes the procedure for monitoring values of device addresses and debugging in WindO/I-NV4.

- 1 Change the communication setting to match the connection method between computer and MICRO/I.

For details, refer to Chapter 24 "1.3 Change Communication Settings" on page 24-5.

- 2 On the **Online** tab, in the **Monitors** group, click **Start Monitor**.

The MICRO/I switches to monitor mode and **Monitor Mode** is displayed at the bottom left of the screen.

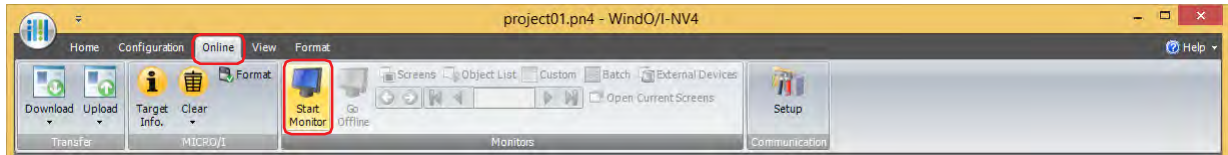

If a password has been configured for the project data, the Enter Password screen will be displayed. Enter the password. For details, refer to Chapter 23 "User Accounts and the Security Function" on page 23-1.







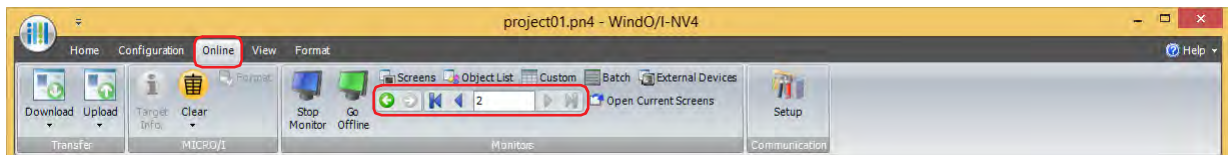

To change values of device addresses and check the operation of project data offline, first switch to monitor mode, and then on the **Online** tab, in the **Monitors** group, click **Go Offline**.

The MICRO/I switches to offline mode and **Offline mode** is displayed at the bottom left of the screen.

- 3 On the **Online** tab, in the **Monitors** group, click the following button or enter the number to the text box to switch the screen displayed on the MICRO/I to the Monitor screen.



-  **(Back)**
You are returned to the Base Screen that was displayed immediately before the screen was switched.
-  **(Forward)**
Advances to the Base Screen that was displayed immediately before the screen was switched using  **(Back)**.
-  **(First Screen)**
Switches to the Base Screen of the lowest screen number in the project data.
-  **(Previous Screen)**
Switches to the Base Screen of screen number one lower than the Base Screen currently displayed. If the screen numbers are not sequential, switches to the screen of next lowest number.
- **(Specified Screen)**
Switches to the Base Screen with the specified number.
-  **(Next Screen)**
Switches to the screen with screen number one higher than the Base Screen currently displayed. If the screen numbers are not consecutive, switches to the screen of next highest number.
-  **(Last Screen)**
Switches to the Base Screen of highest screen number in the project data.

- 4 On the **Online** tab, in the **Monitors** group, click **Open Current Screens**.

The screen displayed on MICRO/I opens in the editing window.

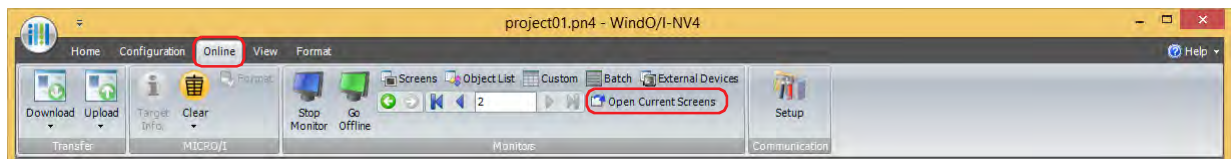

- 5 On the **Online** tab, in the **Monitors** group, select the monitor being used.

When monitoring starts, the screen monitor is displayed.

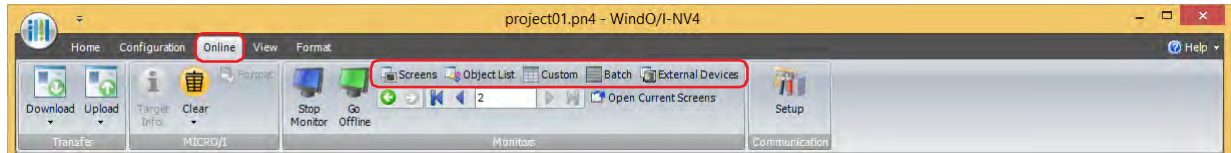

■ Screens

Automatically checks device addresses used on the screen displayed on the MICRO/I. For details, refer to "Screen Monitor" on page 25-6.

■ Object List

Displays values of device addresses in a popup on the **Object List** window. It also highlights objects while satisfying conditions. For details, refer to "1.3 Display the Value of Device Address in Popup" on page 25-18, and "1.4 Highlighting Objects While Satisfying Conditions" on page 25-18.

■ Custom

Registers monitored device addresses individually and displays the value of device addresses. For details, refer to "Custom Monitor" on page 25-7.

■ Batch

Registers monitored device address as a batch for sequential address numbers and displays the value of device addresses. For details, refer to "Batch Monitor" on page 25-15.

■ External Devices

Displays the state of external devices connected to the MICRO/I. For details, refer to "External Device Monitor" on page 25-17.

- 6 Check operation of project data by monitoring and changing values of device addresses, and edit project data if there is an error.

If the monitored screen is switches, repeat steps 3 through 4.

- 7 Download the edited project data to the MICRO/I.



To reflect edits made during debugging, it is necessary to perform a download.

- 8 On the **Online** tab, in the **Monitors** group, click **Stop Monitor**.

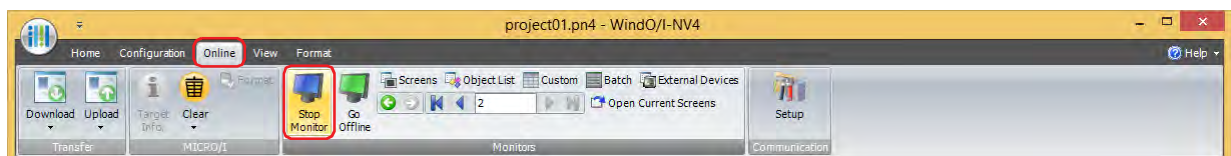

To switch from offline mode to monitor mode, on the **Online** tab, in the **Monitors** group, click **Go Online**.

● Screen Monitor

Automatically displays device addresses used on the screen displayed on the MICRO/I. Enables values of device addresses to be monitored and changed.

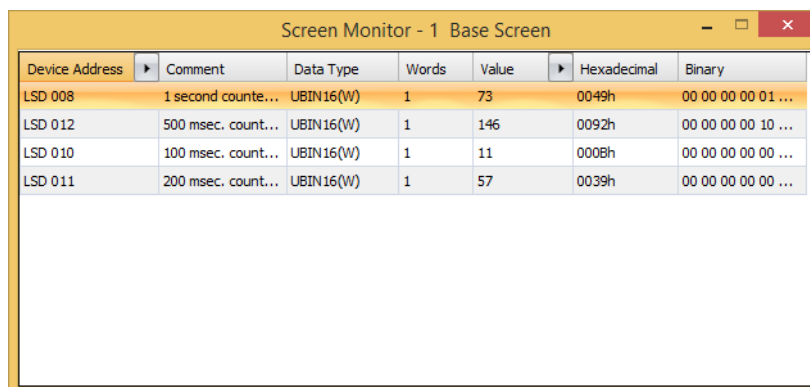

Device Address	Comment	Data Type	Words	Value	Hexadecimal	Binary
LSD 008	1 second counte...	UBIN16(W)	1	73	0049h	00 00 00 00 01 ...
LSD 012	500 msec. count...	UBIN16(W)	1	146	0092h	00 00 00 00 10 ...
LSD 010	100 msec. count...	UBIN16(W)	1	11	000Bh	00 00 00 00 00 ...
LSD 011	200 msec. count...	UBIN16(W)	1	57	0039h	00 00 00 00 00 ...

■ Device Address

Displays the device addresses used on the screen displayed on the MICRO/I.

▶ next to **Comment** toggles between showing and hiding comments. When comments are displayed, click ▶ to display a popup menu, then click **Comment** and select the check box.

■ Comment

Displays comments on device addresses saved in Tag Editor. Comments are displayed only after you click ▶ next to **Device Address** to display a popup menu, then click **Comment** and select the check box.

■ Data Type

Selects the data format of the displayed value. For details, refer to Chapter 2 "1.1 Available Data" on page 2-1.

■ Words

Specify the number of word devices (1 to 16) stored the display value. 2 single-byte characters can be displayed by 1 word.

This option can only be configured **String(Western)**, **String(Japanese)**, **String(Simplified Chinese)**, **String(Traditional Chinese)**, **String(Hangul)**, **String(Central European)**, **String(Baltic)**, **String(Cyrillic)** is selected as Data Type.

The storage order for word device address data is set according to **Storage Method of String Data** on the **System** tab in the **Project Settings**. For details, refer to Chapter 4 "Storage Method of String Data" on page 4-29.

■ Value

Enables values of device addresses to be display and changed. The value range depends on the data type. For details, refer to Chapter 2 "1.1 Available Data" on page 2-1.

UBIN16(W), BIN16(I), UBIN32(D), BIN32(L), BCD4(B), BCD8(EB), Float32(F):

Displays the current value of device address in decimal format. To change a value, double-click a cell and then enter a value.

The value range depends on the data type. For details, refer to Chapter 2 "1.1 Available Data" on page 2-1.

Click ▶ to toggle display of **HEX** and **BIN** format. To display **HEX** and **BIN** values, click ▶ to display a popup menu, then click **HEX and BIN** and select the check box.

String(Western), String(Japanese), String(Simplified Chinese), String(Traditional Chinese), String(Hangul), String(Central European), String(Baltic), String(Cyrillic):

Displays the current value of device address in string. To change a value, double-click a cell and then enter the messages in the language selected.

■ Hexadecimal, Binary

Displays the current value of device address in hexadecimal and binary format. To change a value, double-click a cell and then specify a value.

The value range depends on the data type. For details, refer to Chapter 2 "1.1 Available Data" on page 2-1.

Comments are displayed only after you click ▶ next to **Value** to display a popup menu and then select the **HEX** and **BIN** check box.

● Custom Monitor

Enables the values of registered device addresses to be monitored and changed.

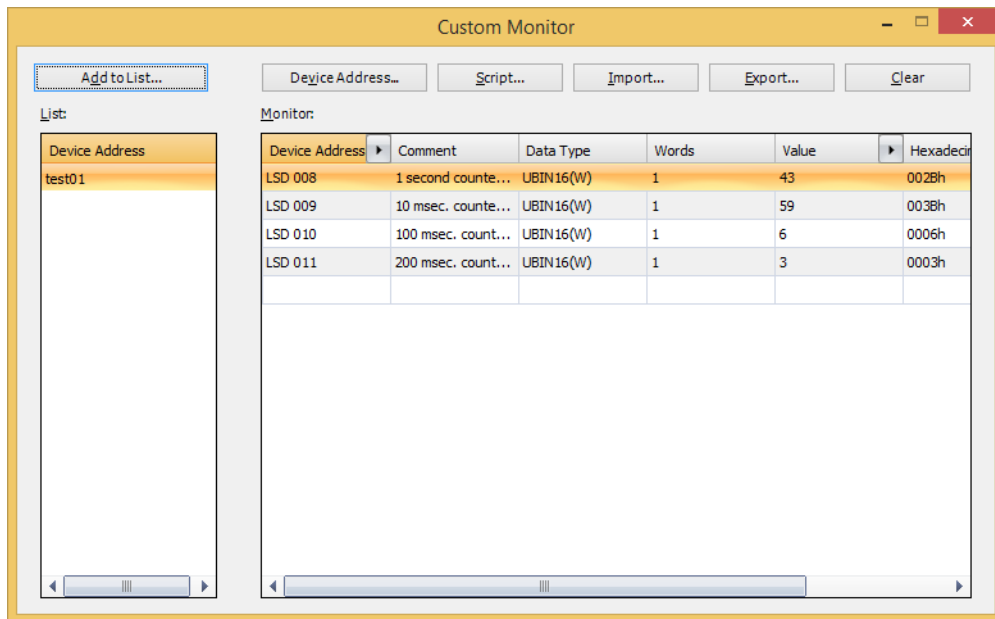

■ Add to List

Saves device addresses registered in **Monitor** to project data as a device address list. A saved lists can be monitored by selecting it from the List.

Click this button to display the Device Address List Name Setting dialog box. For details, refer to "Saving Registered Device Addresses to Project Data as a Device Address List" on page 25-11.

■ Device Address

Registers the device addresses to monitor individually.

Click this button to display the Tag Editor. For details, refer to "Registering the device addresses to monitor individually" on page 25-9.

■ Script

Batch saves all device addresses used in a script.

Click this button to display Script Manager. For details, refer to "Batch Saving Device Addresses Used in Scripts" on page 25-9.

■ Import

Imports the device addresses from a device address list saved as a CSV text file.

Click this button to display the Device Address List dialog box. For details, refer to "Importing Device Addresses from a Device Address List" on page 25-13.

■ Export

Saves the device addresses displayed in **Monitor** as a CSV text file. This file is called a Device Address List.

Click this button to display the Save As dialog box. For details, refer to "Saving a Device Address List as a CSV File" on page 25-12.

The saved device address list can be imported using **Import**.

■ Clear

Deletes all the device addresses displayed in **Monitor**.

■ List

Displays a device address list saved with the project data.

Select a list to clear the device addresses shown in **Monitor** and display the device addresses in the list.

Double-click a cell to display the Device Address List Name Setting dialog box. The name of the device address list can be edited.

Select a list and press DELETE to delete it from the List.

■ Monitor

The registered device addresses are displayed in a list.

Select the device address list from the List to show the device addresses registered in the list.

- Device Address:** The registered device addresses are displayed.
 Double-click a cell to register or change a device address. Click  to display the Tag Editor. For details on how to configure device address settings, refer to Chapter 2 "5.1 Device Address Settings" on page 2-70.
 toggles between showing and hiding comments. When comments are displayed, click to display a popup menu, then click **Comment** and select the check box.
- Comment:** Displays comments on device addresses saved in Tag Editor. Comments are displayed only after you click next to **Device Address** to display a popup menu, then click **Comment** and select the check box.
- Data Type:** Selects the data format of the displayed value. For details, refer to Chapter 2 "1.1 Available Data" on page 2-1.
- Words:** Specify the number of word devices (1 to 16) stored the display value. 2 single-byte characters can be displayed by 1 word.
 This option can only be configured **String(Western), String(Japanese), String(Simplified Chinese), String(Traditional Chinese), String(Hangul), String(Central European), String(Baltic), String(Cyrillic)** is selected as Data Type.
 The storage order for word device address data is set according to **Storage Method of String Data** on the **System** tab in the **Project Settings**. For details, refer to Chapter 4 "Storage Method of String Data" on page 4-29.
- Value:** Enables values of device addresses to be display and changed. The value range depends on the data type. For details, refer to Chapter 2 "1.1 Available Data" on page 2-1.
UBIN16(W), BIN16(I), UBIN32(D), BIN32(L), BCD4(B), BCD8(EB), Float32(F):
 Displays the current value of device address in decimal format. To change a value, double-click a cell and then enter a value.
 The value range depends on the data type. For details, refer to Chapter 2 "1.1 Available Data" on page 2-1.
 Click to toggle display of **HEX** and **BIN** format. To display **HEX** and **BIN** values, click to display a popup menu, then click **HEX and BIN** and select the check box.
String(Western), String(Japanese), String(Simplified Chinese), String(Traditional Chinese), String(Hangul), String(Central European), String(Baltic), String(Cyrillic):
 Displays the current value of device address in string. To change a value, double-click a cell and then enter the messages in the language selected.
- Hexadecimal, Binary:** Displays the current value of device address in hexadecimal and binary format. To change a value, double-click a cell and then specify a value.
 The value range depends on the data type. For details, refer to Chapter 2 "1.1 Available Data" on page 2-1.
 Comments are displayed only after you click next to **Value** to display a popup menu and then select the **HEX** and **BIN** check box.

Registering the device addresses to monitor**Registering the device addresses to monitor individually**

Click **Device Address**. Or, double-click a cell under **Device Address** in **Monitor**, and then click **...**.

The Tag Editor is displayed. For details on configuring device address settings, refer to Chapter 2 "5.1 Device Address Settings" on page 2-70.

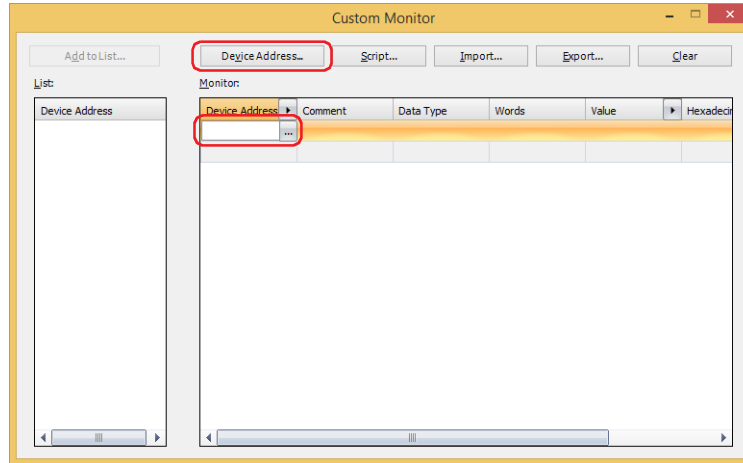
**Batch Saving Device Addresses Used in Scripts**

- 1 Click **Script**.

Script Manager is displayed.

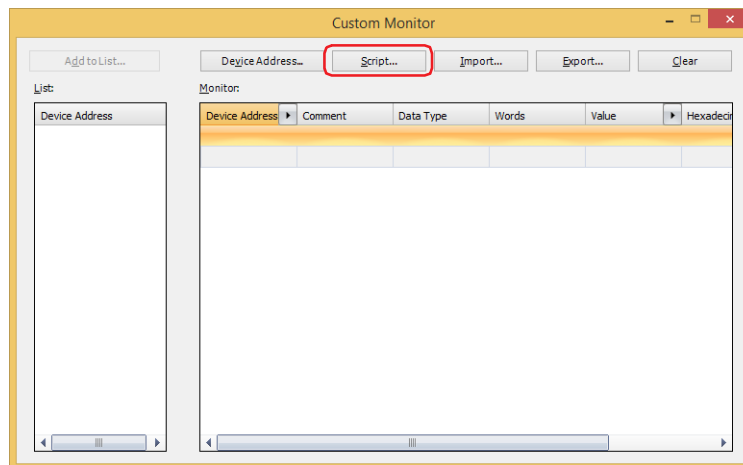

- 2 Select the script ID of the script for the device address to be batch-saved, and then click **Select**.

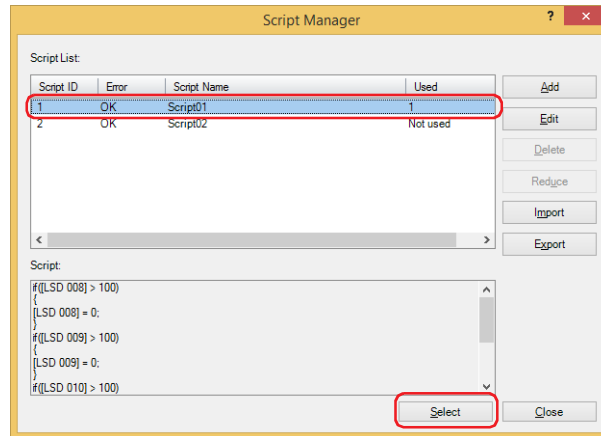

All the device addresses used by the script are registered.

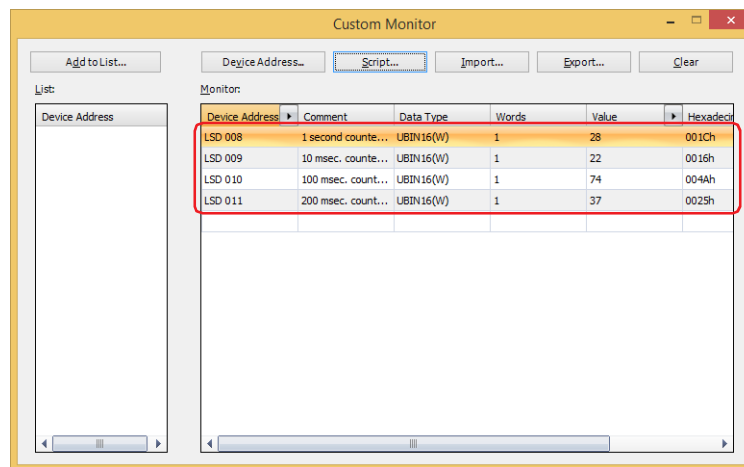

Saving Registered Device Addresses to Project Data as a Device Address List

If registered device addresses are saved with project data as a list, then even when the project data is later reopened, the device addresses can be called from the List to be reutilized.

1 Click **Add to List**.

The Device Address List Name Setting dialog box is displayed.

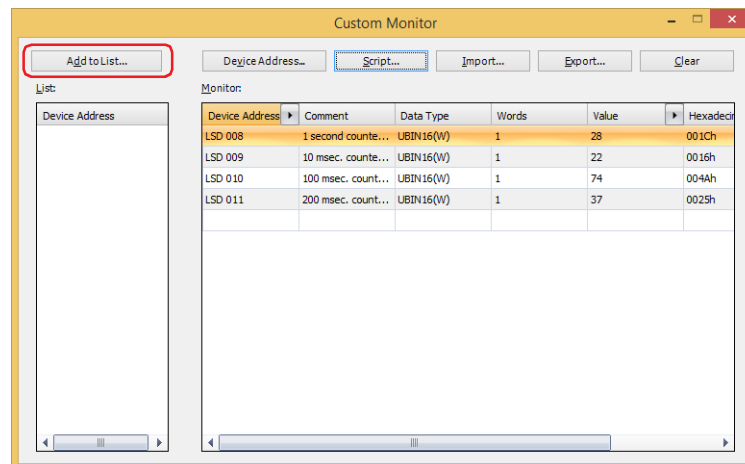

2 Enter a name for the device address list.

The maximum number is 40 characters.



The following characters cannot be used for names of device address list.

" * , / : ; < > ? \ |

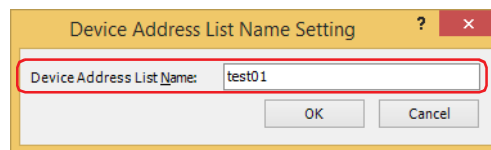

3 Click **OK**.

The device address list is added to the **List**.

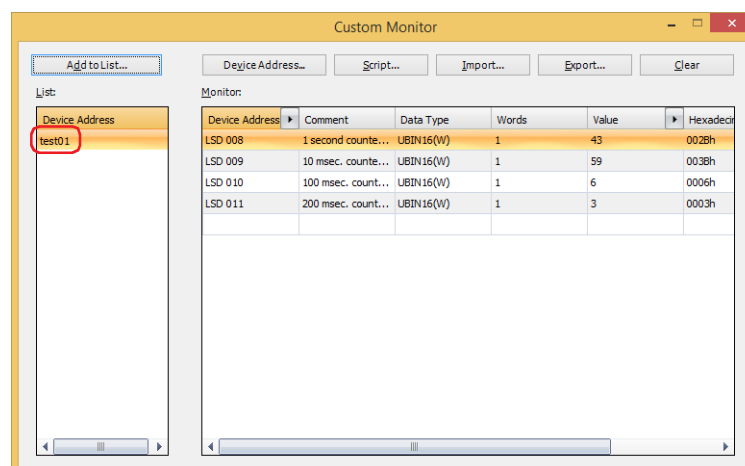

4 Saving project data.



If a project file is closed without saving, device address lists will not be saved with the project data.

Saving a Device Address List as a CSV File

To use a device address list (registered device addresses list) in another project, save it as a CSV text file. This file is called a Device Address List.

1 Click **Export**.

The Save As dialog box is displayed.

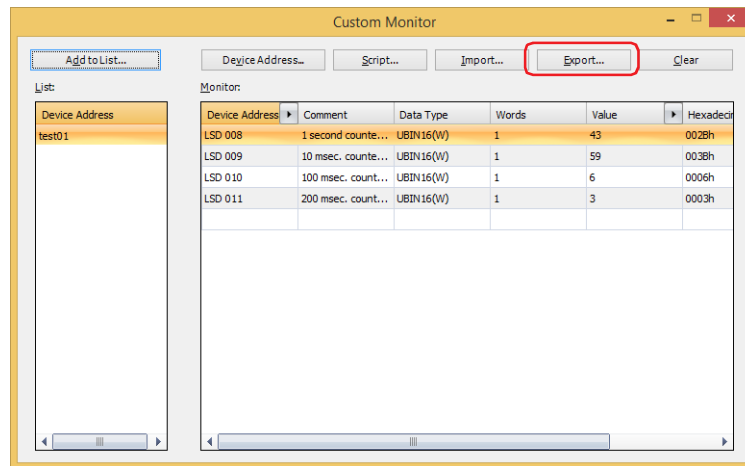

2 Select the save location, enter a **File name**, and then click **Save**.

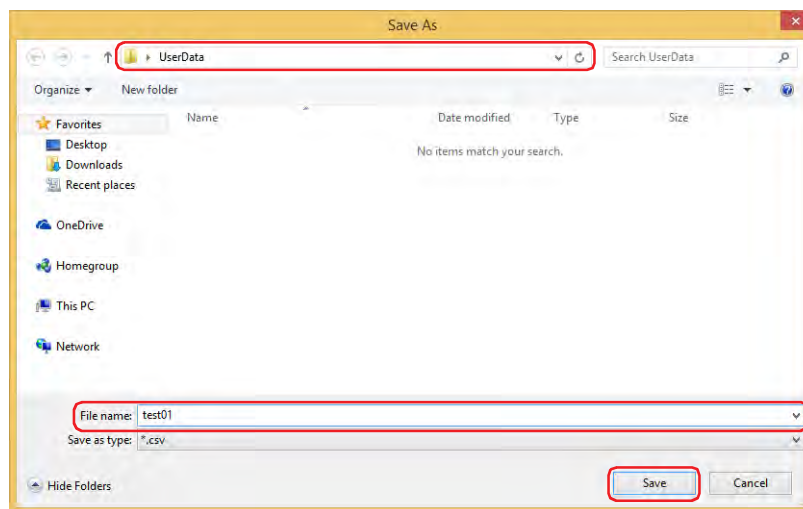

This concludes saving device address list.

Importing Device Addresses from a Device Address List

Imports the device addresses from a device address list saved as a CSV text file into custom monitor.

1 Click **Import**.

The Device Address List dialog box is displayed.

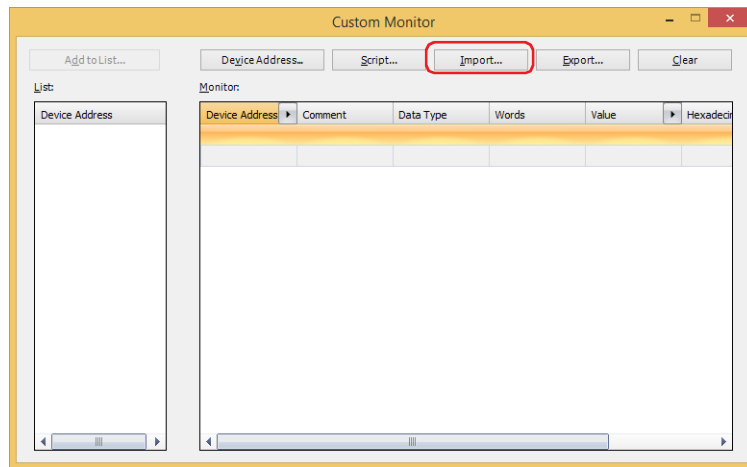

2 Click .

The Open dialog box is displayed.

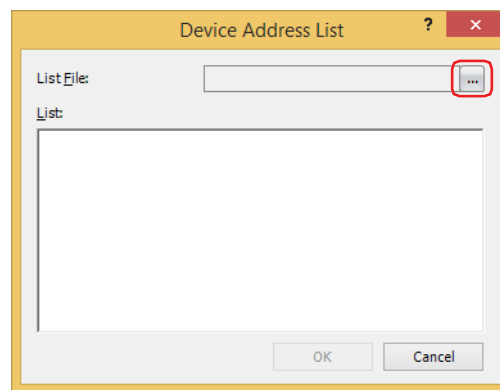

3 Select a saved device address list, and then click **Open**.

The device addresses are listed.

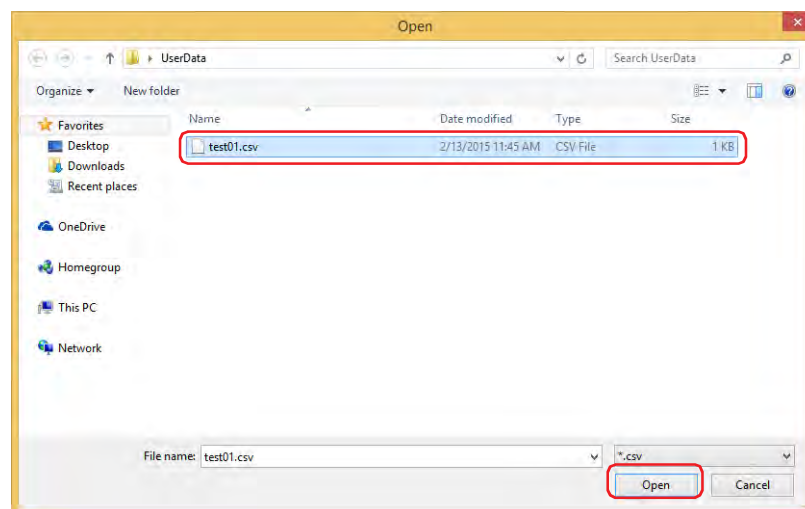

4 Click the device address to import.

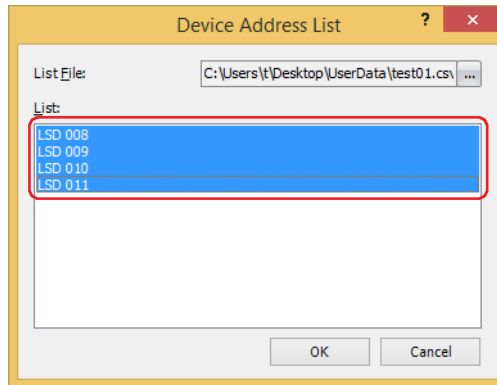

To select multiple items of text, press and hold SHIFT or CTRL while you click the specific items.

5 Click **OK**.

If there is an already registered device address on the Custom Monitor, an overwrite confirmation message is displayed.

- Click **Yes** to overwrite the device address displayed in the confirmation message.
- Click **Yes To All** to overwrite all the device addresses.
- Click **No** to display the next confirmation message without overwriting the device address displayed in the confirmation message.
- Click **Cancel** to stop importing device addresses.

The device address is added to **Monitor**.

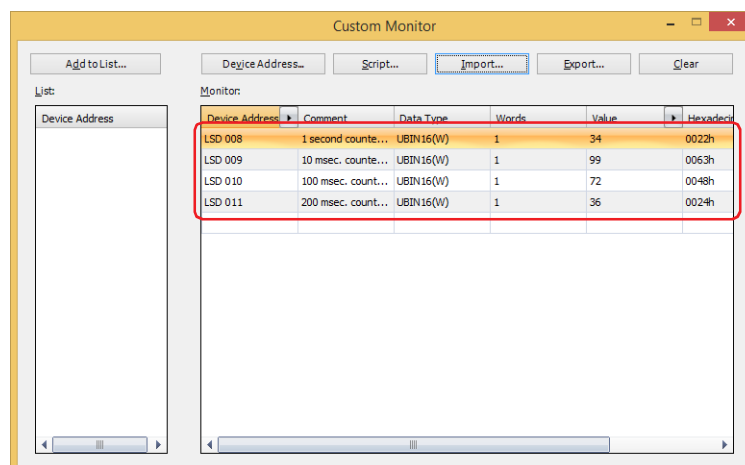

● Batch Monitor

Displays sequential addresses as a batch.

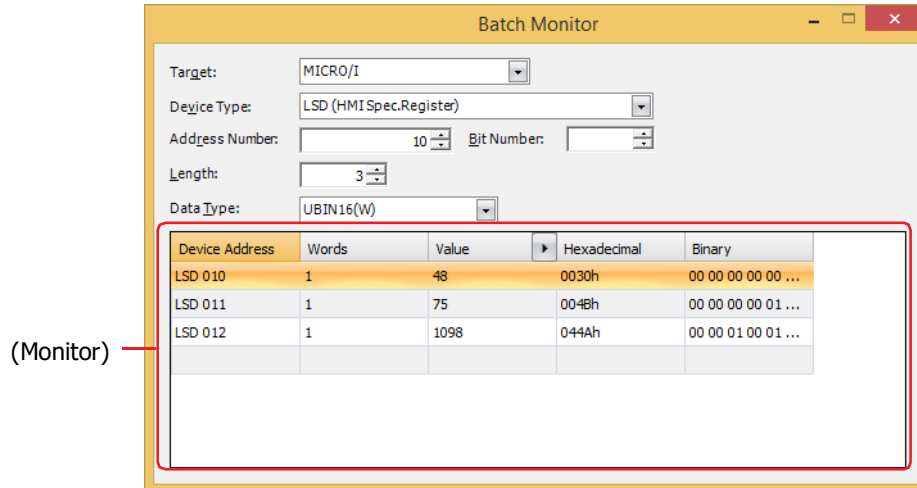

■ Target

Select the device that includes the device address that will be set from **MICRO/I** or **External Device (External Device ID): (External Device Name)**.

You can configure the External Device ID and the external device name in the **Communications Driver Network** tab on the Project Settings dialog box. For details, refer to Chapter 4 "3.4 Communication Driver Network Tab" on page 4-52.

■ Device Type

Selects the device type.
The list only shows device types that can be used.

■ Address Number

Specify the address. The range that can be set varies based on the device type selected.

■ Bit Number

Specify the bit (0 to 15) of the word device when a word device is selected in **Device**.

■ Length

Specifies the number of device addresses displayed in the list (Bit number of the word device: 1 to 16, Bit Device or Word Device: 1 to 1000).

■ Data Type

Selects the data format of the displayed value. For details, refer to Chapter 2 "1.1 Available Data" on page 2-1.

■ (Monitor)

Automatically displays the selected device addresses, in the number specified under **Length**, from top to bottom, consecutively.

Device Address: The specified device addresses are displayed.

Words: Specify the number of word devices (1 to 16) stored the display value. 2 single-byte characters can be displayed by 1 word.

This option can only be configured **String(Western)**, **String(Japanese)**, **String(Simplified Chinese)**, **String(Traditional Chinese)**, **String(Hangul)**, **String(Central European)**, **String(Baltic)**, **String(Cyrillic)** is selected as Data Type.

The storage order for word device address data is set according to **Storage Method of String Data** on the **System** tab in the **Project Settings**. For details, refer to Chapter 4 "Storage Method of String Data" on page 4-29.

Value: Enables values of device addresses to be display and changed. The value range depends on the data type. For details, refer to Chapter 2 "1.1 Available Data" on page 2-1.

UBIN16(W), **BIN16(I)**, **UBIN32(D)**, **BIN32(L)**, **BCD4(B)**, **BCD8(EB)**, **Float32(F)**:

Displays the current value of device address in decimal format. To change a value, double-click a cell and then enter a value.

The value range depends on the data type. For details, refer to Chapter 2 "1.1 Available Data" on page 2-1.

Click  to toggle display of **HEX** and **BIN** format. To display **HEX** and **BIN** values, click  to display a popup menu, then click **HEX and BIN** and select the check box.

String(Western), **String(Japanese)**, **String(Simplified Chinese)**, **String(Traditional Chinese)**, **String(Hangul)**, **String(Central European)**, **String(Baltic)**, **String(Cyrillic)**:

Displays the current value of device address in string. To change a value, double-click a cell and then enter the messages in the language selected.

Hexadecimal, Binary: Displays the current value of device address in hexadecimal and binary format. To change a value, double-click a cell and then specify a value.
The value range depends on the data type. For details, refer to Chapter 2 "1.1 Available Data" on page 2-1.

Comments are displayed only after you click  next to **Value** to display a popup menu and then select the **HEX** and **BIN** check box.

- External Device Monitor

Displays the state of external devices connected to the MICRO/I.

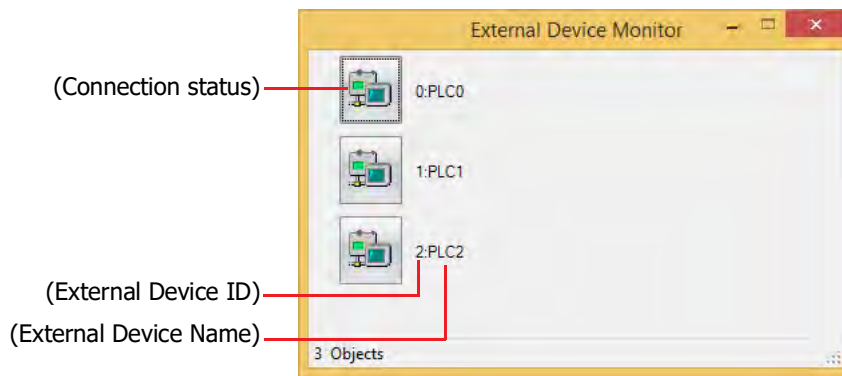

- **(Connection status)**

Displays the state of external devices connected to the MICRO/I. If a red cross appears over the icon of an external device, communication is stopped.

Clicking the External Device icon enables switching between connection and disconnection.

- **(External Device ID)**

Displays the External Device ID of all external device addresses used in the project.

- **(External Device Name)**

Displays the name of external devices used in the project.

1.3 Display the Value of Device Address in Popup

During monitoring, mousing over device addresses displayed in the **Object List** window or device addresses in a script opened in Script Editor displays the current value in a popup window.

- **Object List** window

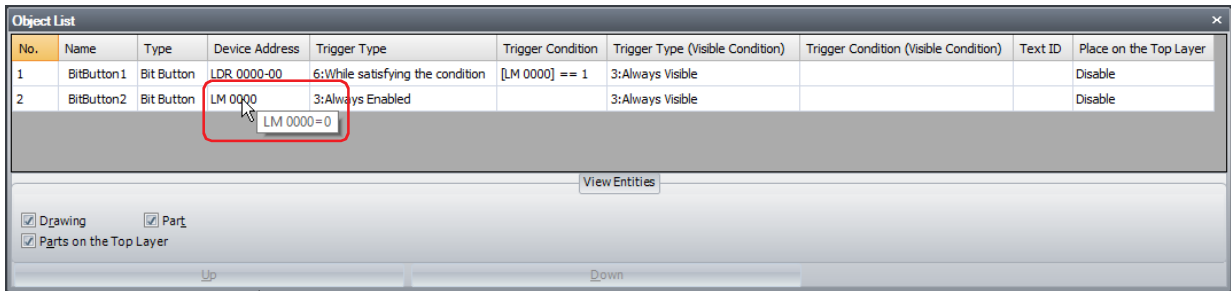

- Script Editor

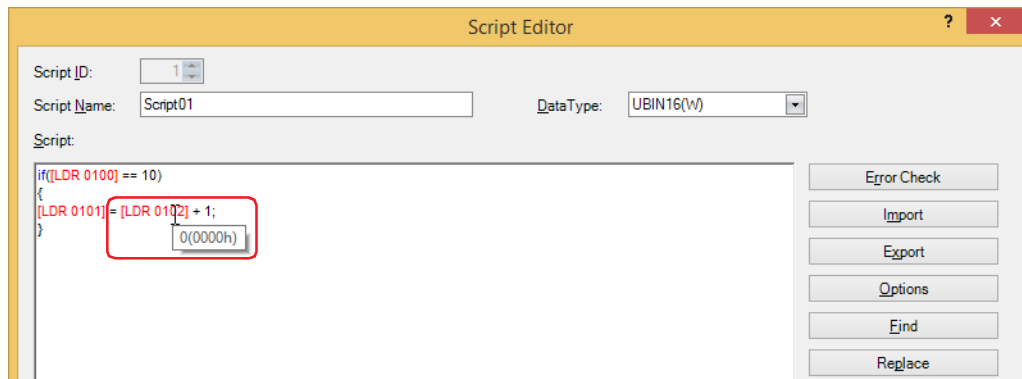

- Popup viewing of values of device addresses in the **Object List** window works only if the screen displayed in the **Object List** window matches the screen displayed on the MICRO/I.
- Popup viewing of values of device addresses in Script Editor works only if the script during editing is being used by a global script command or a script command on the screen displayed on the MICRO/I.
- The maximum number for popup window is 80 characters. Any characters entered after the 80th will not be displayed.
- If 65 or more device addresses are displayed in the **Object List** window, monitor refreshing and popup message will slow down.

1.4 Highlighting Objects While Satisfying Conditions



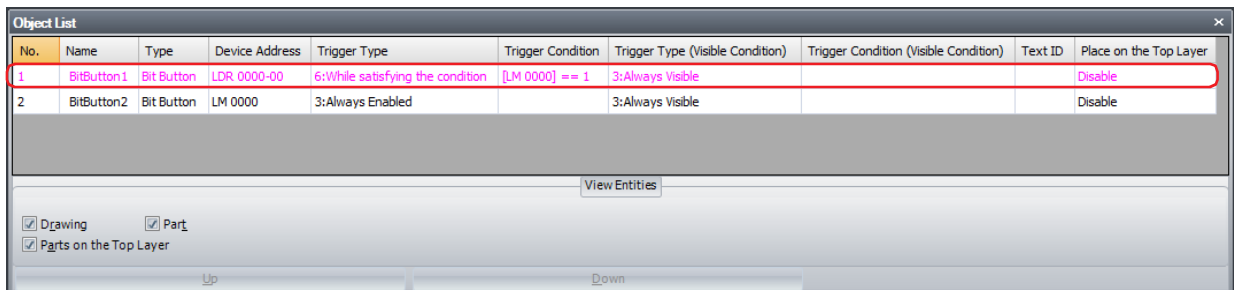



When the Trigger Condition is satisfied during monitoring, the objects for which conditions are being satisfied are highlighted in the **Object List** window.

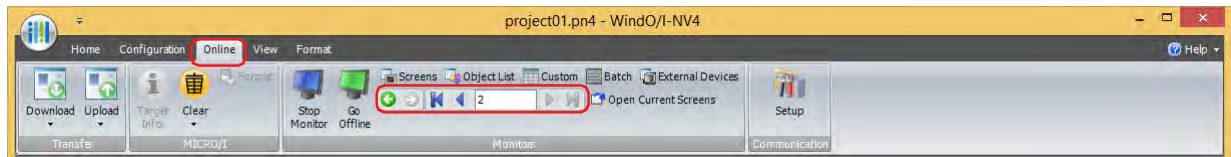

1.5 Switching the Screen of the MICRO/I

During monitoring, it is possible to switch to the screen displayed on the MICRO/I using a WindO/I-NV4 command.



-  **(Back)**
You are returned to the Base Screen that was displayed immediately before the screen was switched.
-  **(Forward)**
Advances to the Base Screen that was displayed immediately before the screen was switched using the  **(Back)**.
-  **(First Screen)**
Switches to the Base Screen with the lowest screen number in the project data.
-  **(Previous Screen)**
Switches to the Base Screen of screen number one lower than the Base Screen currently displayed. If the screen numbers are not consecutive numbers, this command switches to the closest number.
- **(Specified Screen)**
Switches to the Base Screen of a specified number.
-  **(Next Screen)**
Switches to the Base Screen of screen number one higher than the Base Screen currently displayed. If the screen numbers are not consecutive numbers, switches to the closest number.
-  **(Last Screen)**
Switches to the Base Screen of highest screen number in the project data.

1.6 Open Current Screens

The screen displayed on MICRO/I opens in the editing window.

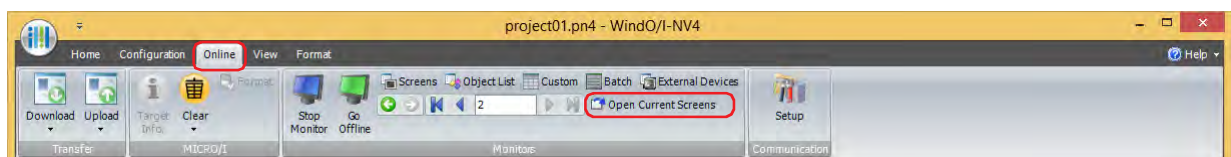

1.7 Change Values of Device Addresses and Check the Operation of Project Data Offline

To change values of device addresses and check the operation of project data on the MICRO/I unit, first switch to monitor mode, and then click **Go Offline**.

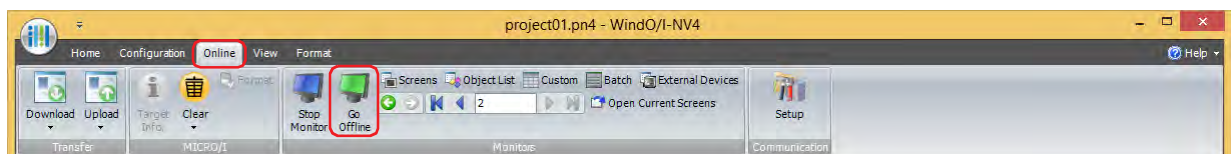

The MICRO/I switches to offline mode and "Offline Mode" flashes at the bottom left of the screen.

2 Monitoring on the MICRO/I

HG2J-7U HG5G-V HG4G-V HG4G HG3G-V HG3G HG2G-V HG2G-5F HG2G-5T HG1G HG1P

It is possible to change values of device addresses and check the operation on the MICRO/I.

2.1 How the Monitoring Function is Used

Monitoring in the MICRO/I can perform the following functions.

- Checking and changing the value of specified device address

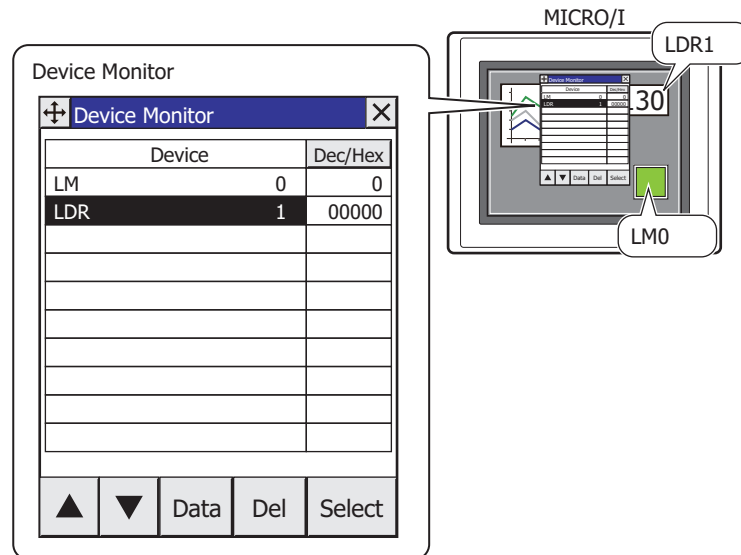

Device Monitor can be used in offline mode. The values of the external device addresses can be checked and changed with the MICRO/I alone.

2.2 Device Monitor

By registering device addresses in Run Mode, both data monitoring and changing can be conducted. Registered device addresses are listed in Device Monitor in ascending order (A to Z, 0 to 9). Registered device addresses are saved until power to the MICRO/I is turned OFF, or the mode is changed.



- Available device address range depends on types and settings of external devices. Selecting unavailable device address, "Communication error" happens and it can not be back in without reboot. For details, refer to Chapter 36 "1.1 Errors Displayed on the Screen" on page 36-1.
- If three Popup Screens are displayed on the screen (or if two Popup Screens are displayed in the Alarm Log Settings), in order to use Device Monitor in the same way on Popup Screens, the Device Monitor cannot be used.

● Displaying Device Monitor

- 1 Press the upper-left corner of the screen on the MICRO/I for three seconds or more.
The Maintenance Screen is displayed.

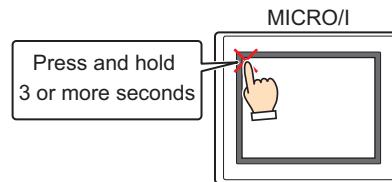

- 2 Press **Device Monitor**.

Device Monitor is displayed.

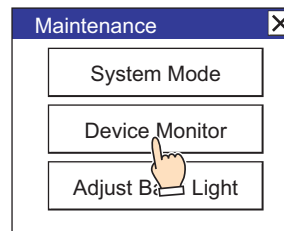

If a password has been configured for the project data, the Enter Password screen will be displayed. Select a user name and then enter a password. For details, refer to Chapter 23 "User Accounts and the Security Function" on page 23-1.

● Device Address Registration

- 1 Press **Select** on Device Monitor.

The Select Device Address screen is displayed.

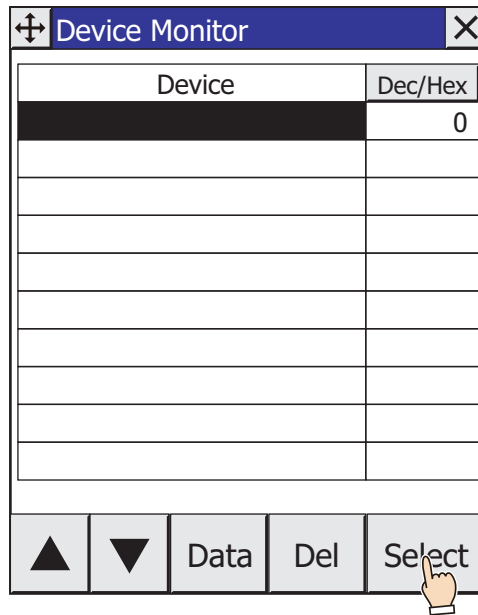

- 2 Press ▲ or ▼ to select the device type.

For Internal Device, proceed to step 4.

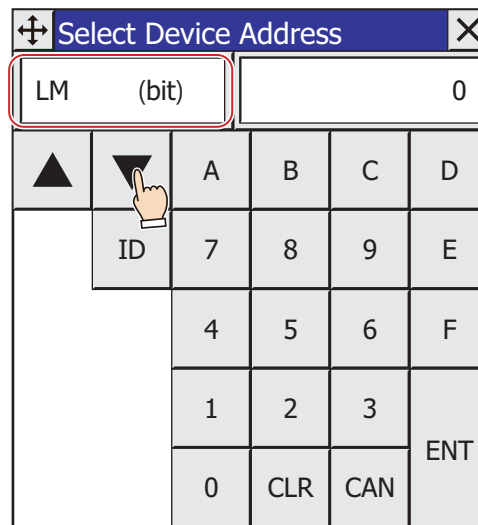

The next address of the device address entered previously is automatically displayed in the Select Device Address screen.

- 3 Enter the External Device ID as a hexadecimal value and press **ID**.

- 4 Enter the address number and then press **ENT**.
- Press **CLR** to clear all values entered for the address number.
 - Press **CAN** to stop registering device addresses.

Select Device Address					
LM	(bit)	1			
▲	▼	A	B	C	D
	ID	7	8	9	E
		4	5	6	F
		1	2	3	ENT
		0	CLR	CAN	



If a device address is invalid, pressing **ENT** will not return to Device Monitor.

The device address is registered to Device Monitor.

Device Monitor		
Device	Dec/Hex	
LM	1	0
▲	▼	Data Del Select

- 5 Repeat steps 1 through 4 to register all device addresses to be monitored.

- Changing Value of Device Address

- 1 Press ▲ or ▼ to select the device address to be changed the value.

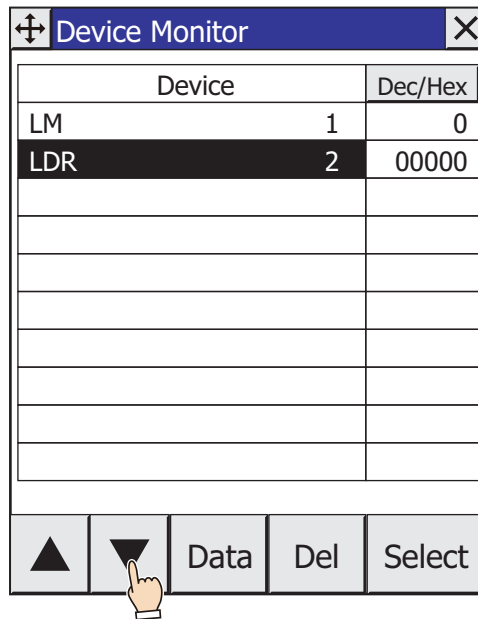

- 2 Press **Data** on Device Monitor.
The Write Data screen is displayed.

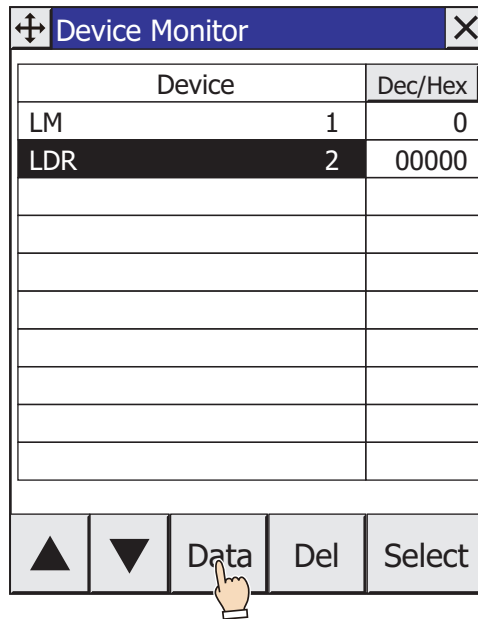

- 3 Enter the value of device address and press **ENT**.
- Press **Dec** or **Hex** to change the display type for the value to enter.
 - Press **CLR** to delete the entered value of device address.
 - Press **CAN** to stop entering the value of device address.

Write Data					
LDR		2		1	
Dec	Hex	A	B	C	D
Current (word) 0 / 0H		7	8	9	E
		4	5	6	F
		1	2	3	ENT
		0	CLR	CAN	



- If a value of device is invalid, pressing **ENT** will not return you to Device Monitor.
- If the display type is decimal, **A** to **F** cannot be used.



The value of device address is changed.

Device Monitor		
Device		Dec/Hex
LM	1	0
LDR	2	00001
▲	▼	Data Del Select

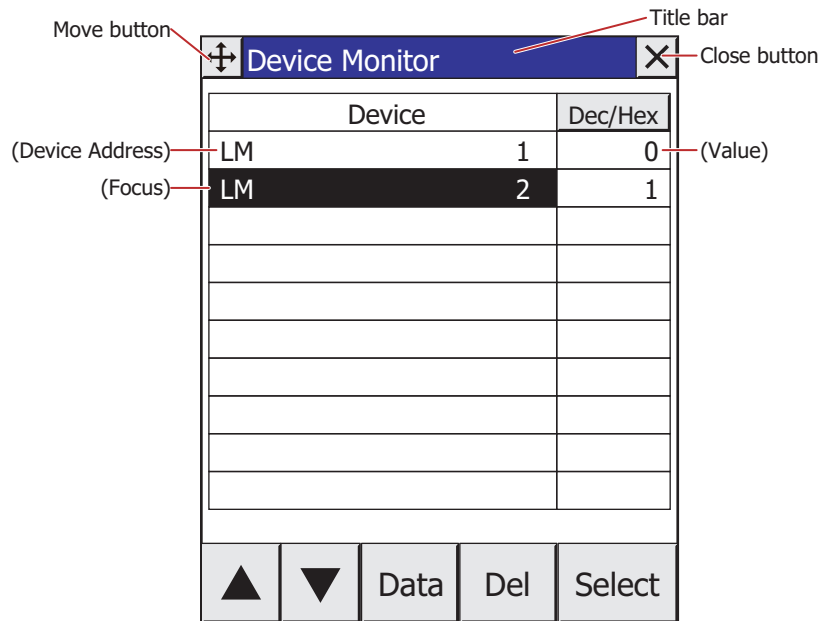
● Device Monitor Configuration



■ Title Bar

Displays the title,  (Move) button, and  (Close) button.

 (Move) button: Moves the Device Monitor.

 (Close) button: Closes the Device Monitor.

■ Dec/Hex

Switches the display type for the current value of device address. Switches between **DEC** and **HEX**.

■ (Device Address)

The registered device address is displayed.

■ (Value)

The current value of device address is displayed.

■ (Focus)

Highlights the selected device address.

■ ▲

Moves the focus up by one line.

■ ▼

Moves the focus down by one line.

■ Data

Changes the value of the selected device address. Press to display the Write Data Screen. For details, refer to "Changing Value of Device Address" on page 25-24.

■ Del

Deletes the selected device address.

■ Select

Registers a selected device address. Press to display the Select Device Address screen. For details, refer to "Device Address Registration" on page 25-22.

2.3 Change Values of Device Addresses and Check the Operation of Project Data Offline

Offline mode allows you to change values of device addresses and to check the operation of project data on the MICRO/I unit only. By possessing virtualized external device addresses inside the MICRO/I, you can efficiently debug using the Device Monitor function.

● Switching to Offline Mode

- 1 Press the upper-left corner of the screen on the MICRO/I for three seconds or more.
The Maintenance Screen is displayed.

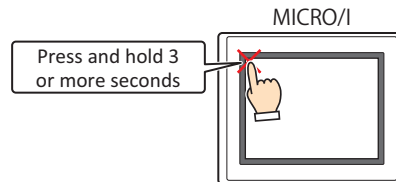

- 2 Press **System Mode**.

The MICRO/I switches to the Top Page of the System Mode.

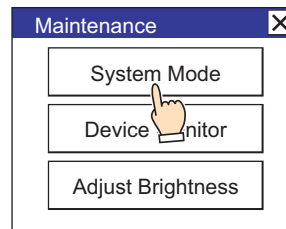

If a password has been configured for the project data, the Enter Password screen will be displayed. Select a user name and then enter a password. For details, refer to Chapter 23 "User Accounts and the Security Function" on page 23-1.

- 3 Press **Offline**.

The MICRO/I switches to offline mode and "Offline Mode" is displayed at the bottom left of the screen.

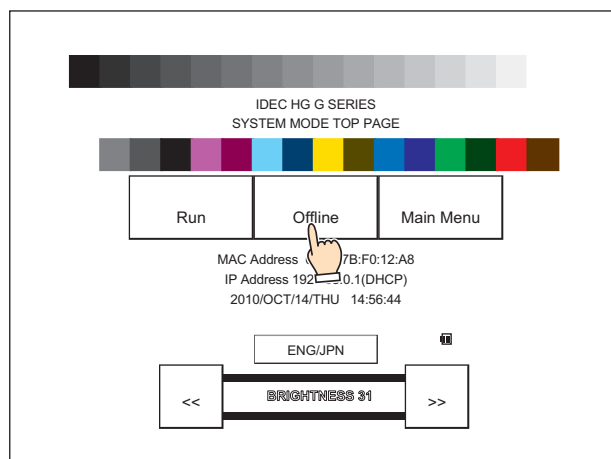

- 4 Monitor and change the values of device addresses with Device Monitor to check the operation of project data.

If there are any errors, edit the project data with WindO/I-NV4, and then download the edited project data to the MICRO/I.

To exit offline mode, switch to System Mode with the operations in steps 1 and 2, and then press **Run** on the Top Page.

Chapter 26 Simulator Function

This chapter describes the simulator function, which can be used to check operation of the project data in WindO/I-NV4 before the created project data is downloaded to a MICRO/I.

The simulator function can be used to check and change the values of internal devices and device addresses of external devices.

1 Overview

HG2J-7U HG5G-V HG4G-V HG4G HG3G-V HG3G HG2G-V HG2G-5F HG2G-5T HG1G HG1P

1.1 How the Simulator Function is Used

Simulator function in WindO/I-NV4 can be performed as follows.

- Check the operation of parts

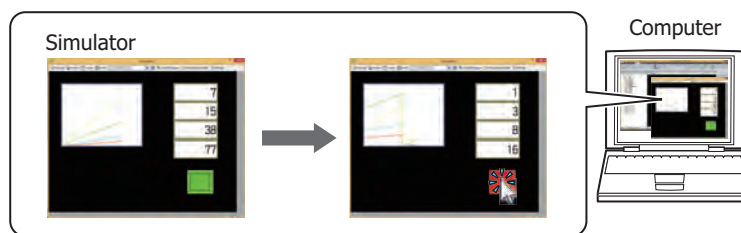

- Save the screen displayed in the simulator as an image

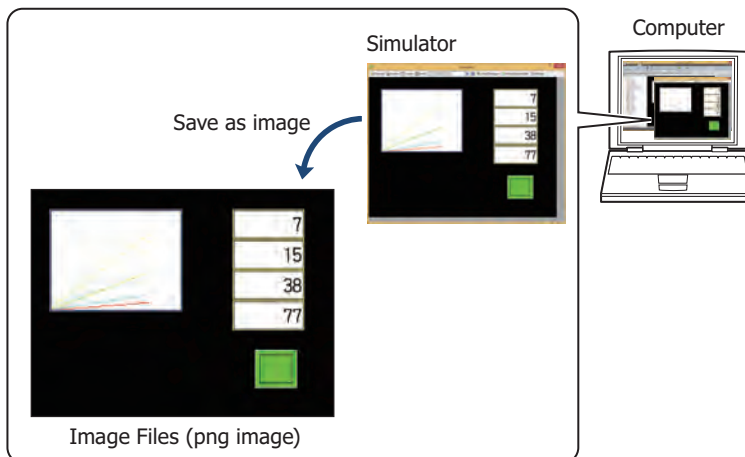

- Check the values of device addresses used on screens displayed

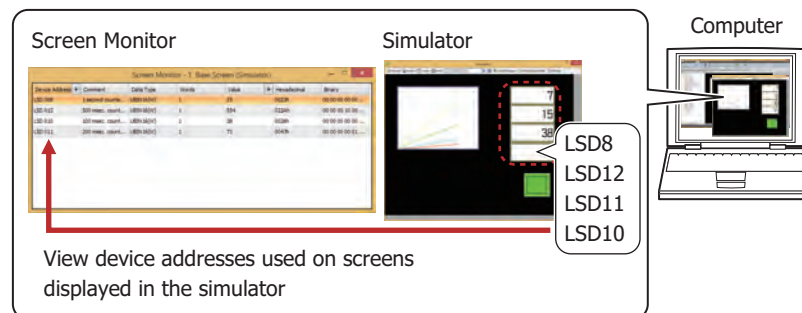

- Checking values of specified device addresses

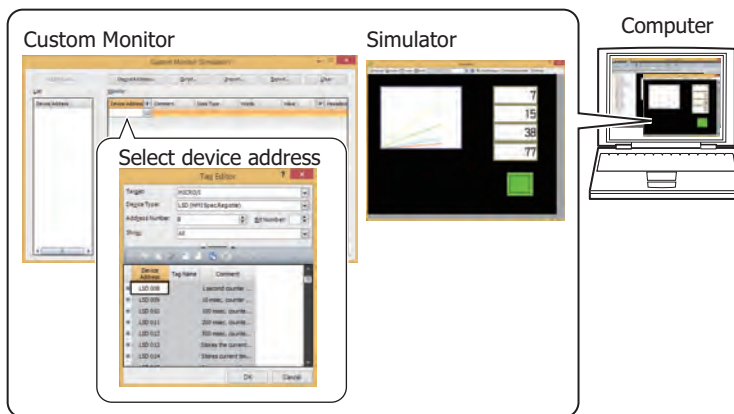

- Checking values of device addresses of sequential address numbers

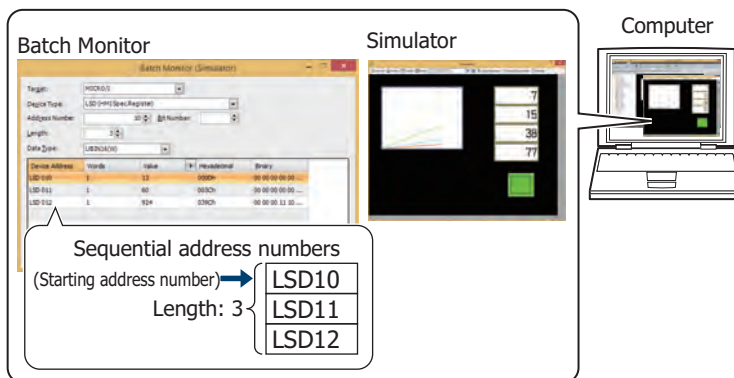

- Change the screen displayed in the simulator

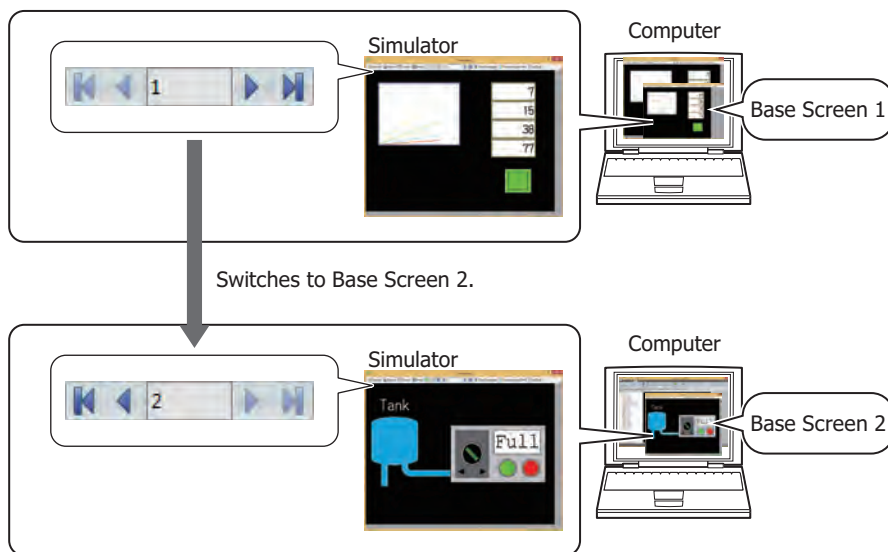

- Check the operation of Script

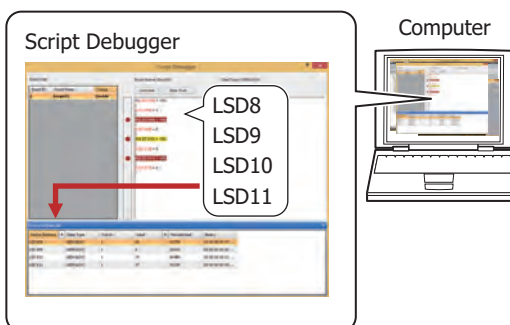

2 Using the Simulator

HG2J-7U HG5G-V HG4G-V HG4G HG3G-V HG3G HG2G-V HG2G-5F HG2G-5T HG1G HG1P

2.1 Starting the Simulator

● Starting the Simulator

- 1 Open the project data on which to perform the operation check.
- 2 On the **Online** tab, in the **Simulator** group, click the **Simulator** icon.

The project data being edited will be loaded and the simulator will start.



If the project data was changed before the simulator is started, a save confirmation message will be displayed.

- Click **OK** to save the project data and start the simulator.
- Click **Cancel** to cancel starting the simulator. You will be returned to the editing screen and the project data will not be saved.



The simulator cannot load project data that cannot be downloaded to the MICRO/I.

● Starting the Simulator by Loading or Clearing Device Addresses

If the **Save Value of Device Address (External Device, LK, LKR)** check box is selected and the simulator is terminated, the loading method of the project data can be selected when the simulator is next started.

- 1 Open the project data on which to perform the operation check.
- 2 On the **Online** tab, in the **Simulator** group, click the ▼ arrow under **Simulator**.
- 3 Select the loading method of the project data.

The project data being edited will be loaded and the simulator will start.

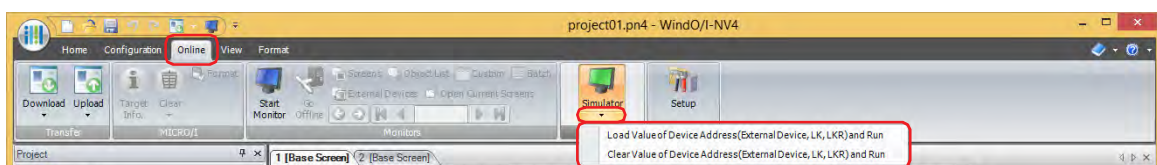

■ Load Value of Device Address (External Device, LK, LKR) and Run

The saved values of device addresses on the external device, HMI keep relays (LK), and HMI keep registers (LKR) will be loaded when the project data is loaded.

■ Clear Value of Device Address (External Device, LK, LKR) and Run

The saved values of device addresses on the external device, HMI keep relays (LK), and HMI keep registers (LKR) will be cleared when the project data is loaded.



If the project data was changed, a confirmation message to save the project data is displayed.

- Click **OK** to save the project data and start the simulator.
- Click **Cancel** to cancel starting the simulator. You will be returned to the editing screen and the project data will not be saved.









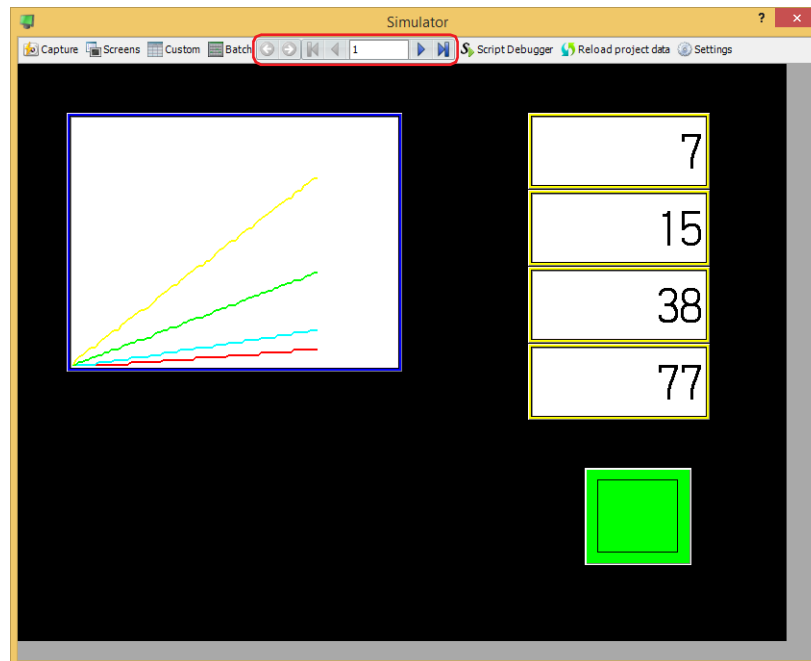

The simulator cannot load project data that cannot be downloaded to the MICRO/I.

2.2 Debugging in Simulator

This section describes the procedure for monitoring values of device addresses and debugging in Simulator.

- 1 In the simulator, use the following buttons and the text box to change the monitored screen.



-  **(Back)**
You are returned to the Base Screen that was displayed immediately before the screen was switched.
-  **(Forward)**
Advances to the Base Screen that was displayed immediately before the screen was switched using  **(Back)**.
-  **(First Screen)**
Switches to the Base Screen of the lowest screen number in the project data.
-  **(Previous Screen)**
Switches to the Base Screen of screen number one lower than the Base Screen currently displayed. If the screen numbers are not sequential, switches to the screen of next lowest number.
- **(Specified Screen)**
Switches to the Base Screen with the specified number.
-  **(Next Screen)**
Switches to the screen with screen number one higher than the Base Screen currently displayed. If the screen numbers are not consecutive, switches to the screen of next highest number.
-  **(Last Screen)**
Switches to the Base Screen of highest screen number in the project data.

2 Select the monitor being used.

When monitoring starts, the screen monitor is displayed.

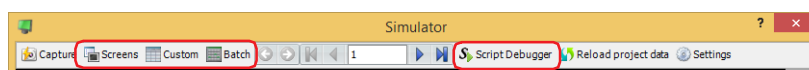

■ Screens

Automatically checks device addresses used on the screen displayed on the Simulator. For details, refer to "3.2 Screen Monitor" on page 26-10.

■ Custom

Registers monitored device addresses individually and displays the value of device addresses. For details, refer to "3.3 Custom Monitor" on page 26-11.

■ Batch

Registers monitored device address as a batch for sequential address numbers and displays the value of device addresses. For details, refer to "3.4 Batch Monitor" on page 26-13.

■ Script Debugger

Check the operation of the script used in the project. For details, refer to "3.5 Script Debugger" on page 26-15.

3 Check operation of project data by monitoring and changing values of device addresses, and edit project data if there is an error.

If the monitored screen is switches, repeat steps 1.



Click **Settings** to save the values of device addresses on the external device, HMI keep relays (LK), and HMI keep registers (LKR) that were input in the simulator.

The Simulator Settings dialog box is displayed.

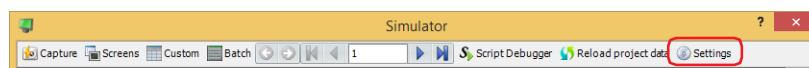

After the **Simulator Settings** dialog box is displayed, select the **Save Value of Device Address (External Device, LK, LKR)** check box, and then click **OK**.

The values of device addresses that are saved are the values when the simulator is terminated or when **Reload project data** is clicked.

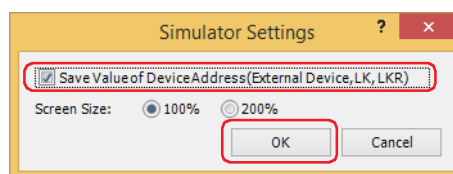

4 If you have edited the project data, click **Reload project data** to update the project displayed in the simulator. The Reload Project dialog box is displayed.

If the **Save Value of Device Address (External Device, LK, LKR)** check box is cleared, proceed to step 6.

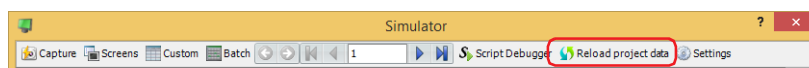

If the project data was changed, a confirmation message to save the project data is displayed.

- Click **OK** to save and load the project data.
- Click **Cancel** to return to the editing screen without saving the project data.

- 5 Select the loading method of the project data and click **OK**.

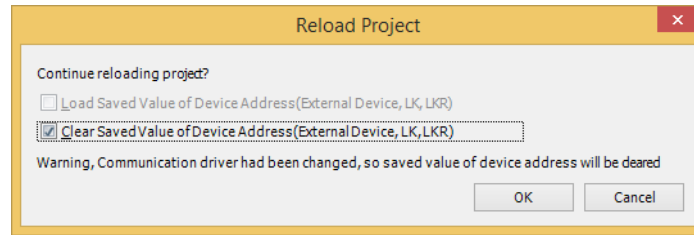

■ **Load Saved Value of Device Address (External Device, LK, LKR)**

The saved values of device addresses on the external device, HMI keep relays (LK), and HMI keep registers (LKR) will be loaded when the project data is loaded.

■ **Clear Saved Value of Device Address (External Device, LK, LKR)**

The saved values of device addresses on the external device, HMI keep relays (LK), and HMI keep registers (LKR) will be cleared when the project data is loaded.

- 6 Repeat steps 1 to 5, and click **×** when you have finished debugging.

This terminates the simulator.

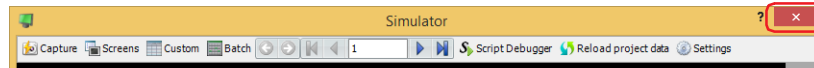

2.3 Saving the Displayed Screen as an Image

You can save the screen displayed on the simulator as an image.

- 1 Click **Capture**.

The Save As dialog box is displayed.

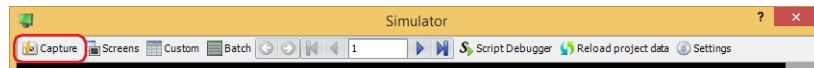

- 2 Select the save location, enter a **File name**, and then click **Save**.

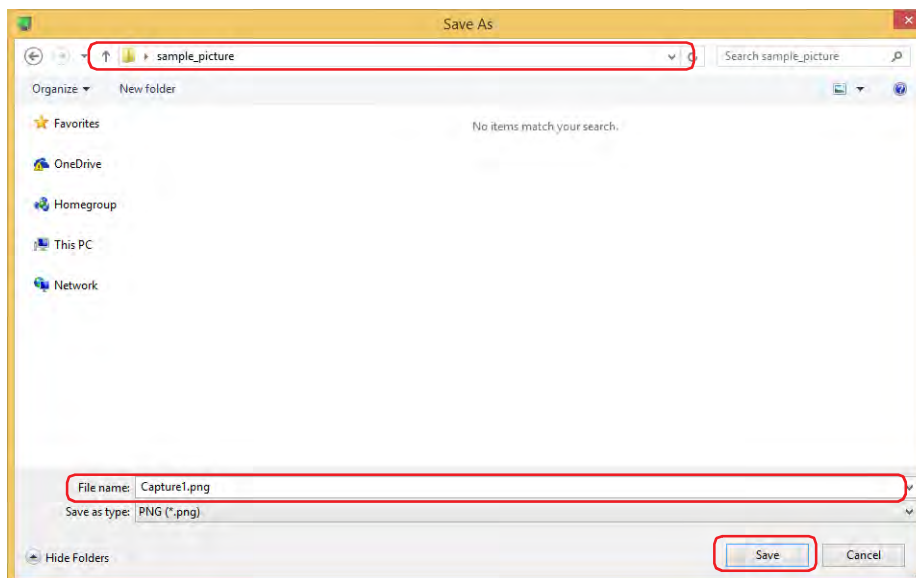

3 Simulator





HG2J-7U HG5G-V HG4G-V HG4G HG3G-V HG3G HG2G-V HG2G-5F HG2G-5T HG1G HG1P

This section describes items and buttons on the Simulator.

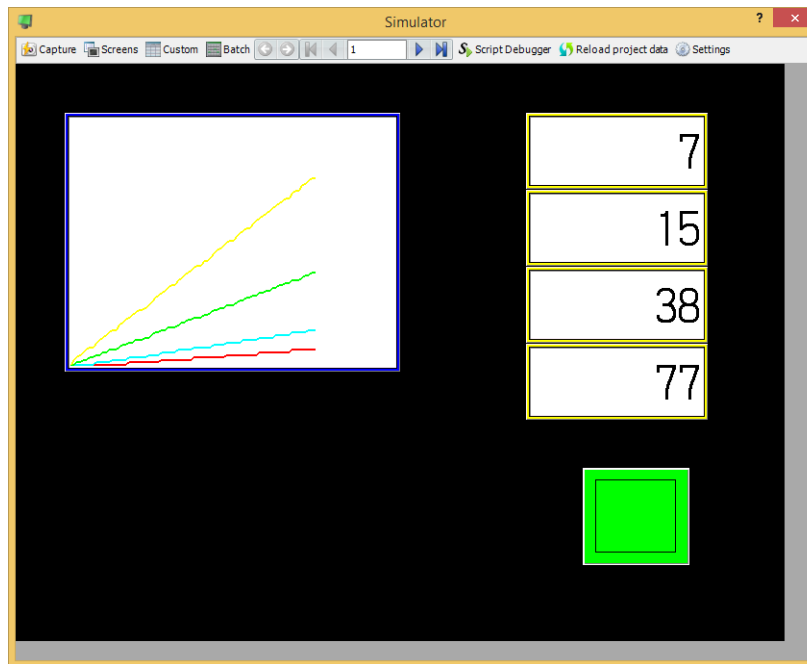
3.1 Simulator

It is possible to change values of device addresses and check the operation on the screen of Simulator.



- **Capture**
Saves the screen displayed on the simulator as an image.
Click this button to display the Save As dialog box. For details, refer to “2.3 Saving the Displayed Screen as an Image” on page 26-6.
- **Screens**
Automatically displays the device addresses used on the screen displayed in the simulator. For details, refer to “3.2 Screen Monitor” on page 26-10.
- **Custom**
Registers monitored device addresses individually and displays the value of device addresses. For details, refer to “3.3 Custom Monitor” on page 26-11.
- **Batch**
Registers monitored device address as a batch for sequential address numbers and displays the value of device addresses. For details, refer to “3.4 Batch Monitor” on page 26-13.
-  **(Back)**
You are returned to the Base Screen that was displayed immediately before the screen was switched.
-  **(Forward)**
Advances to the Base Screen that was displayed immediately before the screen was switched using  **(Back)**.
-  **(First Screen)**
Switches to the Base Screen of the lowest screen number in the project data.
-  **(Previous Screen)**
Switches to the Base Screen of screen number one lower than the Base Screen currently displayed. If the screen numbers are not sequential, switches to the screen of next lowest number.

-  **(Specified Screen)**
Switches to the Base Screen with the specified number.

-  **(Next Screen)**
Switches to the screen with screen number one higher than the Base Screen currently displayed. If the screen numbers are not consecutive, switches to the screen of next highest number.

-  **(Last Screen)**
Switches to the Base Screen of highest screen number in the project data.

- **Script Debugger**
Check the operation of the script used in the project. For details, refer to "3.5 Script Debugger" on page 26-15.

- **Reload project data**
Reloads the edited project data.

- **Settings**
Click this button to display the Simulator Settings dialog box. For details, refer to "Simulator Settings Dialog Box" on page 26-9.

- **Function key^{*1}**
Check the operation of the switches (F1 to F12) on both sides of the screen of the HG1P main unit.
Right-click the function key and select the action mode for the switch from "Momentary" or "Alternate".

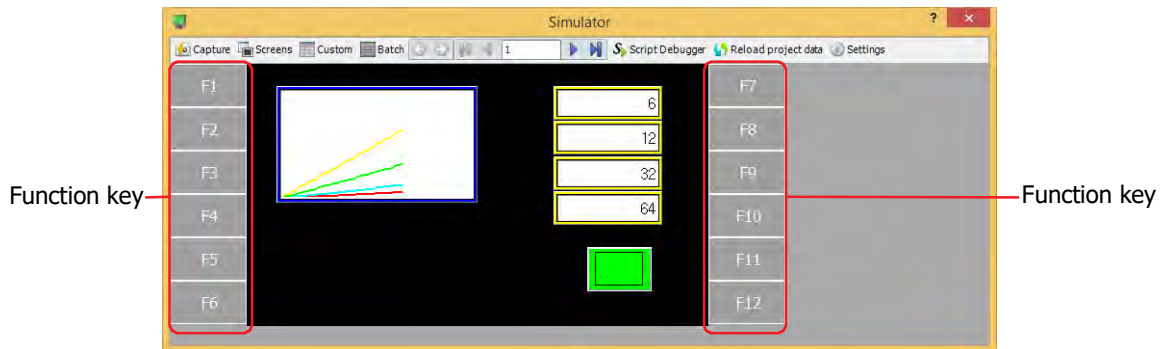

*1 HG1P only

● Simulator Settings Dialog Box

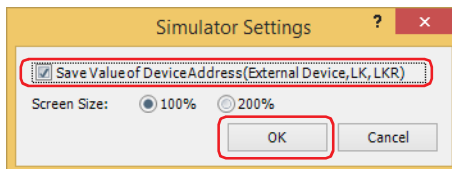

■ Save Value of Device Address (External Device, LK, LKR)

Select this check box to save the values of device addresses on the external device, HMI keep relays (LK), and HMI keep registers (LKR) that were input in the simulator. The values of device addresses will be saved in the project data. The **Reload Project** dialog box will be displayed when the simulator is next started or when the project is reloaded. For details, refer to “2.2 Debugging in Simulator” on page 26-4.

■ Screen Size

Select **100%** or **200%** for the screen size magnification in the simulator.

3.2 Screen Monitor

Automatically checks device addresses used on the screen displayed on the Simulator. Enables values of device addresses to be monitored and changed.

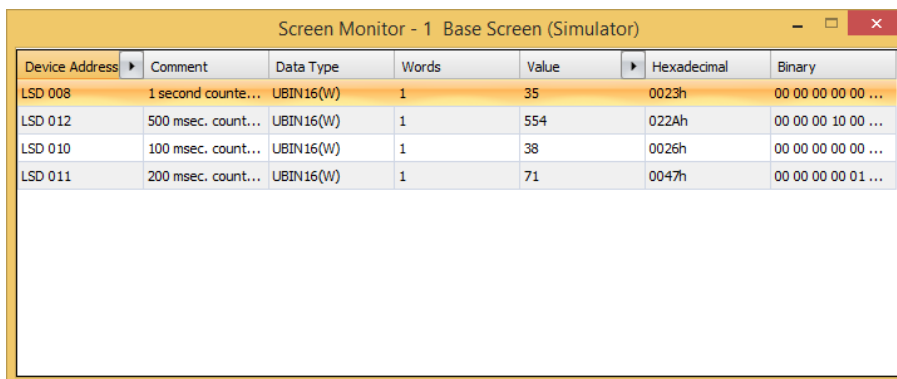

Device Address	Comment	Data Type	Words	Value	Hexadecimal	Binary
LSD 008	1 second counte...	UBIN16(W)	1	35	0023h	00 00 00 00 00 ...
LSD 012	500 msec. count...	UBIN16(W)	1	554	022Ah	00 00 00 10 00 ...
LSD 010	100 msec. count...	UBIN16(W)	1	38	0026h	00 00 00 00 00 ...
LSD 011	200 msec. count...	UBIN16(W)	1	71	0047h	00 00 00 00 01 ...

■ Device Address

Displays the device addresses used on the screen displayed on the Simulator.

▶ next to **Comment** toggles between showing and hiding comments. When comments are displayed, click ▶ to display a popup menu, then click **Comment** and select the check box.

■ Comment

Displays comments on device addresses saved in Tag Editor. Comments are displayed only after you click ▶ next to **Device Address** to display a popup menu, then click **Comment** and select the check box.

■ Data Type

Selects the data format of the displayed value. For details, refer to Chapter 2 "1.1 Available Data" on page 2-1.

■ Words

Specify the number of word devices (1 to 16) stored the display value. 2 single-byte characters can be displayed by 1 word.

This option can only be configured **String(Western)**, **String(Japanese)**, **String(Simplified Chinese)**, **String(Traditional Chinese)**, **String(Hangul)**, **String(Central European)**, **String(Baltic)**, **String(Cyrillic)** is selected as Data Type.

The storage order for word device address data is set according to **Storage Method of String Data** on the **System** tab in the **Project Settings**. For details, refer to Chapter 4 "Storage Method of String Data" on page 4-29.

■ Value

Enables values of device addresses to be display and changed. The value range depends on the data type. For details, refer to Chapter 2 "1.1 Available Data" on page 2-1.

UBIN16(W), BIN16(I), UBIN32(D), BIN32(L), BCD4(B), BCD8(EB), Float32(F):

Displays the current value of device address in decimal format. To change a value, double-click a cell and then enter a value.

The value range depends on the data type. For details, refer to Chapter 2 "1.1 Available Data" on page 2-1.

Click ▶ to toggle display of **HEX** and **BIN** format. To display **HEX** and **BIN** values, click ▶ to display a popup menu, then click **HEX and BIN** and select the check box.

String(Western), String(Japanese), String(Simplified Chinese), String(Traditional Chinese), String(Hangul), String(Central European), String(Baltic), String(Cyrillic):

Displays the current value of device address in string. To change a value, double-click a cell and then enter the messages in the language selected.

■ Hexadecimal, Binary

Displays the current value of device address in hexadecimal and binary format. To change a value, double-click a cell and then specify a value.

The value range depends on the data type. For details, refer to Chapter 2 "1.1 Available Data" on page 2-1.

Comments are displayed only after you click ▶ next to **Value** to display a popup menu and then select the **HEX** and **BIN** check box.

3.3 Custom Monitor

Enables the values of registered device addresses to be monitored and changed.

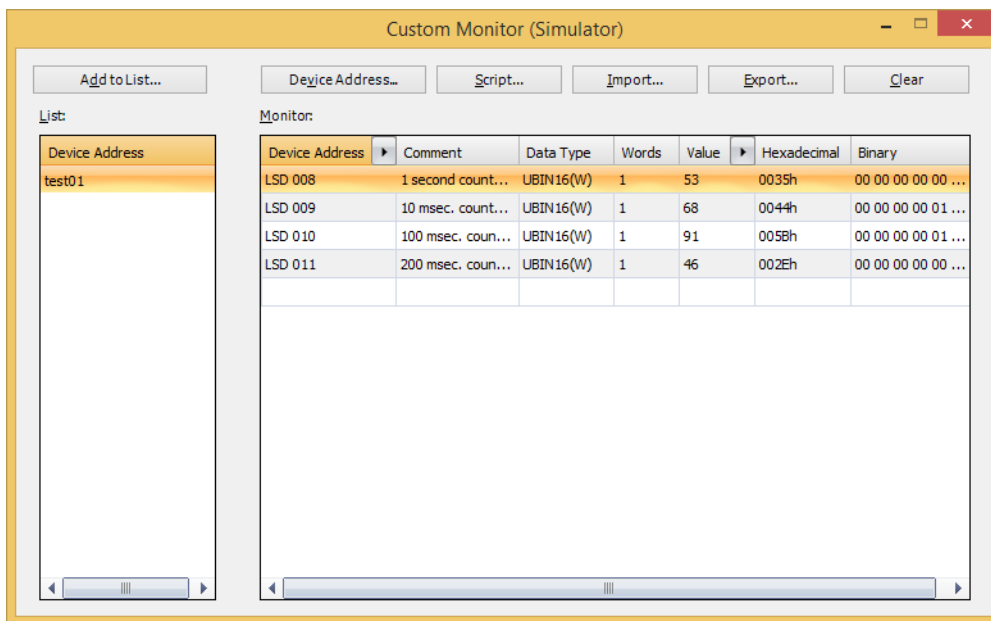

■ Add to List

Saves device addresses registered in **Monitor** to project data as a device address list. A saved lists can be monitored by selecting it from the List.

Click this button to display the Device Address List Name Setting dialog box. For details, refer to Chapter 25 "Saving Registered Device Addresses to Project Data as a Device Address List" on page 25-11.

■ Device Address

Registers the device addresses to monitor individually.

Click this button to display the Tag Editor. For details, refer to Chapter 25 "Registering the device addresses to monitor" on page 25-9.

■ Script

Batch saves all device addresses used in a script.

Click this button to display Script Manager. For details, refer to Chapter 25 "Batch Saving Device Addresses Used in Scripts" on page 25-9.

■ Import

Imports the device addresses from a device address list saved as a CSV text file.

Click this button to display the Device Address List dialog box. For details, refer to Chapter 25 "Importing Device Addresses from a Device Address List" on page 25-13.

■ Export

Saves the device addresses displayed in **Monitor** as a CSV text file. This file is called a Device Address List.

Click this button to display the Save As dialog box. For details, refer to Chapter 25 "Saving a Device Address List as a CSV File" on page 25-12.

The saved device address list can be imported using **Import**.

■ Clear

Deletes all the device addresses displayed in **Monitor**.

■ List

Displays a device address list saved with the project data.

Select a list to clear the device addresses shown in **Monitor** and display the device addresses in the list.







Double-click a cell to display the Device Address List Name Setting dialog box. The name of the device address list can be edited.

Select a list and press DELETE to delete it from the List.

■ Monitor

The registered device addresses are displayed in a list.

Select the device address list from the List to show the device addresses registered in the list.

- Device Address:** The registered device addresses are displayed.
 Double-click a cell to register or change a device address. Click  to display the Tag Editor. For details on how to configure device address settings, refer to Chapter 2 "5.1 Device Address Settings" on page 2-70.
 toggles between showing and hiding comments. When comments are displayed, click  to display a popup menu, then click **Comment** and select the check box.
- Comment:** Displays comments on device addresses saved in Tag Editor. Comments are displayed only after you click  next to **Device Address** to display a popup menu, then click **Comment** and select the check box.
- Data Type:** Selects the data format of the displayed value. For details, refer to Chapter 2 "1.1 Available Data" on page 2-1.
- Words:** Specify the number of word devices (1 to 16) stored the display value. 2 single-byte characters can be displayed by 1 word.
 This option can only be configured **String(Western), String(Japanese), String(Simplified Chinese), String(Traditional Chinese), String(Hangul), String(Central European), String(Baltic), String(Cyrillic)** is selected as Data Type.
 The storage order for word device address data is set according to **Storage Method of String Data** on the **System** tab in the **Project Settings**. For details, refer to Chapter 4 "Storage Method of String Data" on page 4-29.
- Value:** Enables values of device addresses to be display and changed. The value range depends on the data type. For details, refer to Chapter 2 "1.1 Available Data" on page 2-1.
UBIN16(W), BIN16(I), UBIN32(D), BIN32(L), BCD4(B), BCD8(EB), Float32(F):
 Displays the current value of device address in decimal format. To change a value, double-click a cell and then enter a value.
 The value range depends on the data type. For details, refer to Chapter 2 "1.1 Available Data" on page 2-1.
 Click  to toggle display of **HEX** and **BIN** format. To display **HEX** and **BIN** values, click  to display a popup menu, then click **HEX and BIN** and select the check box.
String(Western), String(Japanese), String(Simplified Chinese), String(Traditional Chinese), String(Hangul), String(Central European), String(Baltic), String(Cyrillic):
 Displays the current value of device address in string. To change a value, double-click a cell and then enter the messages in the language selected.
- Hexadecimal, Binary:** Displays the current value of device address in hexadecimal and binary format. To change a value, double-click a cell and then specify a value.
 The value range depends on the data type. For details, refer to Chapter 2 "1.1 Available Data" on page 2-1.
 Comments are displayed only after you click  next to **Value** to display a popup menu and then select the **HEX** and **BIN** check box.



For details about how to register device addresses to monitor in the Custom Monitor and how to reuse registered device addresses, refer to Chapter 25 "Custom Monitor" on page 25-7.

3.4 Batch Monitor

Displays sequential addresses as a batch.

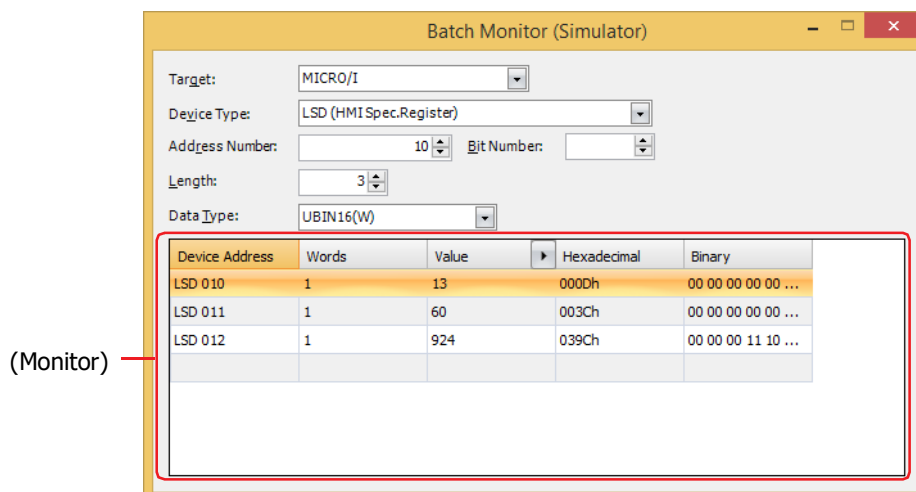

■ Target

Select the device that includes the device address that will be set from **MICRO/I** or **External Device (External Device ID): (External Device Name)**.

You can configure the External Device ID and the external device name in the **Communications Driver Network** tab on the Project Settings dialog box. For details, refer to Chapter 4 "3.4 Communication Driver Network Tab" on page 4-52.

■ Device Type

Selects the device type.
The list only shows device types that can be used.

■ Address Number

Specify the address. The range that can be set varies based on the device type selected.

■ Bit Number

Specify the bit (0 to 15) of the word device when a word device is selected in **Device**.

■ Length

Specifies the number of device addresses displayed in the list (Bit number of the word device: 1 to 16, Bit Device or Word Device: 1 to 1000).

■ Data Type

Selects the data format of the displayed value. For details, refer to Chapter 2 "1.1 Available Data" on page 2-1.

■ (Monitor)

Automatically displays the selected device addresses, in the number specified under **Length**, from top to bottom, consecutively.

Device Address: The specified device addresses are displayed.

Comment: Displays comments on device addresses saved in Tag Editor. Comments are displayed only after you click  next to **Device Address** to display a popup menu, then click **Comment** and select the check box.

Data Type: Selects the data format of the displayed value. For details, refer to Chapter 2 "1.1 Available Data" on page 2-1.

Words: Specify the number of word devices (1 to 16) stored the display value. 2 single-byte characters can be displayed by 1 word.

This option can only be configured **String(Western)**, **String(Japanese)**, **String(Simplified Chinese)**, **String(Traditional Chinese)**, **String(Hangul)**, **String(Central European)**, **String(Baltic)**, **String(Cyrillic)** is selected as Data Type.

The storage order for word device address data is set according to **Storage Method of String Data** on the **System** tab in the **Project Settings**. For details, refer to Chapter 4 "Storage Method of String Data" on page 4-29.

Value: Enables values of device addresses to be display and changed. The value range depends on the data type. For details, refer to Chapter 2 "1.1 Available Data" on page 2-1.

UBIN16(W), **BIN16(I)**, **UBIN32(D)**, **BIN32(L)**, **BCD4(B)**, **BCD8(EB)**, **Float32(F)**:

Displays the current value of device address in decimal format. To change a value, double-click a cell and then enter a value.

The value range depends on the data type. For details, refer to Chapter 2 "1.1 Available Data" on page 2-1.

Click  to toggle display of **HEX** and **BIN** format. To display **HEX** and **BIN** values, click  to display a popup menu, then click **HEX and BIN** and select the check box.

String(Western), **String(Japanese)**, **String(Simplified Chinese)**, **String(Traditional Chinese)**, **String(Hangul)**, **String(Central European)**, **String(Baltic)**, **String(Cyrillic)**:

Displays the current value of device address in string. To change a value, double-click a cell and then enter the messages in the language selected.

Hexadecimal, Binary: Displays the current value of device address in hexadecimal and binary format. To change a value, double-click a cell and then specify a value.

The value range depends on the data type. For details, refer to Chapter 2 "1.1 Available Data" on page 2-1.

Comments are displayed only after you click  next to **Value** to display a popup menu and then select the **HEX** and **BIN** check box.

3.5 Script Debugger

You can check the operation of script configured in the project.

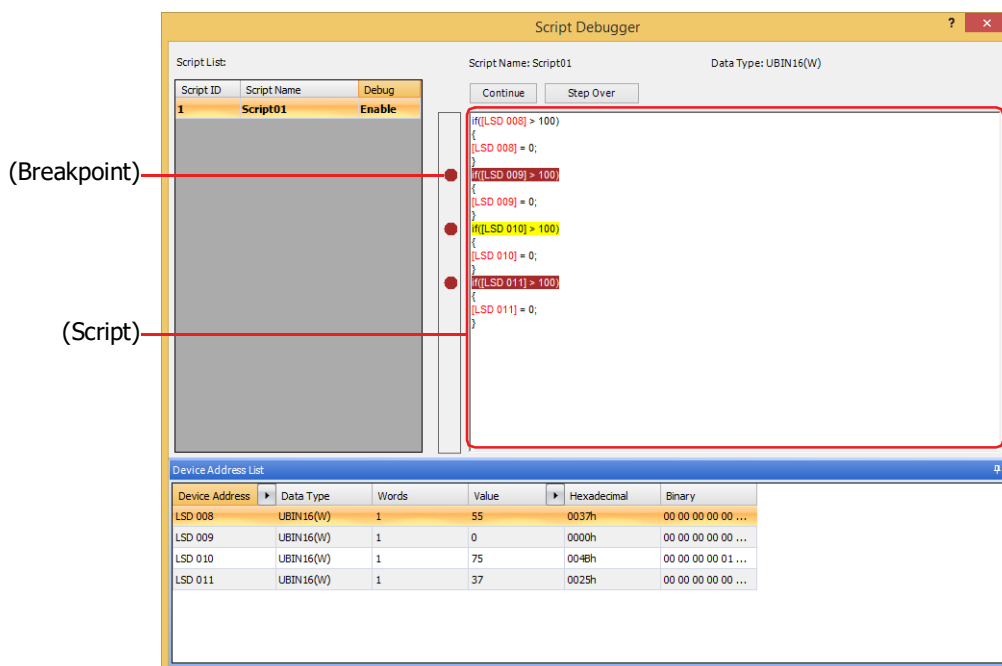

■ Script List

Displays the list of script used on the project.

Script ID: Displays the script ID (1 to 32000) of the registered scripts.

Script Name: Displays the script name of the registered scripts.

Debug: Selects whether or not to debug the script. Double clicking the cell switches between **Enable** and **Disable**. The maximum number of scripts that can be configured to **Enable** is 16.

■ Script Name

Displays the name of the script selected in the **Script List**.

■ Data Type

Displays the data type configured to the script selected in the **Script List**.

For details about the data type, refer to Chapter 20 "1.3 Data Type of the Script" on page 20-3.

■ Continue

Executes the script paused at the breakpoint up to the next breakpoint. If there is no next breakpoint, execute the script to the end and exit.



The keyboard shortcut is F5 key.

■ Step Over

Executes the script while pausing each step (one line) at a time. If there is no next step, the script execution is terminated.



The keyboard shortcut is F6 key.

■ (Breakpoint)

When the script is executed, it pauses when the processing reaches the breakpoint. You can check the value of the device address at the time of stopping on the **Device Address List**.

The maximum number of breakpoints that can be configured for one script is 20.



- The trigger condition for the script is satisfied and the script is executed, and then the processing of the script is stopped when the configured breakpoint is reached.
- When you save the project, the setting of the breakpoint is also saved. However, the project data to be downloaded does not include the setting of the breakpoint, so there is no breakpoint setting after uploading the project.

■ (Script)

Displays the contents of the script selected in **Script List**.

Click inside the frame on the left side of (Script) to configure a breakpoint. ● (red circle) is displayed, and the text on the line configured the breakpoint is highlighted.

■ Device Address List

Displays the device addresses that are used in the script suspended at breakpoint and the values of them.

Device Address:	Displays the device addresses used on the script. ▶ next to Comment toggles between showing and hiding comments. When comments are displayed, click ▶ to display a popup menu, then click Comment and select the check box.
Comment:	Displays comments on device addresses saved in Tag Editor. Comments are displayed only after you click ▶ next to Device Address to display a popup menu, then click Comment and select the check box.
Data Type:	Selects the data format of the displayed value. For details, refer to Chapter 2 "1.1 Available Data" on page 2-1.
Words:	Specify the number of word devices (1 to 16) stored the display value. 2 single-byte characters can be displayed by 1 word. This option can only be configured String(Western), String(Japanese), String(Simplified Chinese), String(Traditional Chinese), String(Hangul), String(Central European), String(Baltic), String(Cyrillic) is selected as Data Type. The storage order for word device address data is set according to Storage Method of String Data on the System tab in the Project Settings . For details, refer to Chapter 4 "Storage Method of String Data" on page 4-29.
Value:	Enables values of device addresses to be display and changed. The value range depends on the data type. For details, refer to Chapter 2 "1.1 Available Data" on page 2-1. UBIN16(W), BIN16(I), UBIN32(D), BIN32(L), BCD4(B), BCD8(EB), Float32(F): Displays the current value of device address in decimal format. To change a value, double-click a cell and then enter a value. The value range depends on the data type. For details, refer to Chapter 2 "1.1 Available Data" on page 2-1. Click ▶ to toggle display of HEX and BIN format. To display HEX and BIN values, click ▶ to display a popup menu, then click HEX and BIN and select the check box. String(Western), String(Japanese), String(Simplified Chinese), String(Traditional Chinese), String(Hangul), String(Central European), String(Baltic), String(Cyrillic): Displays the current value of device address in string. To change a value, double-click a cell and then enter the messages in the language selected.
Hexadecimal, Binary:	Displays the current value of device address in hexadecimal and binary format. To change a value, double-click a cell and then specify a value. The value range depends on the data type. For details, refer to Chapter 2 "1.1 Available Data" on page 2-1. Comments are displayed only after you click ▶ next to Value to display a popup menu and then select the HEX and BIN check box.

4 Restrictions

HG2J-7U HG5G-V HG4G-V HG4G HG3G-V HG3G HG2G-V HG2G-5F HG2G-5T HG1G HG1P

The simulator runs a MICRO/I equivalent to offline mode on the computer to simulate the operation and display of parts laid out on screens. However, the following functions can not be checked with the simulator.

- Sound Function
- Multimedia Function
- Pass-Through Function
- Web Server Function
- FTP Server Function
- FTP Client Function
- E-mail Function
- Social Media Function
- Data Transfer Function
- Printer
- External Device Communication, O/I Link Communication, User Communication, Sub Host Communication and BACnet Communication functions
- Displaying the Maintenance Screen
- Adjust Brightness Function
- Backlight Control Function
- Touch Sound and Beep Sound
- The function to save log data of the Alarm Log Function to the external memory as a CSV file
- The function to save log data of the Data Log Function to the external memory as a CSV file
- The function to save log data of the Operation Log Function to the external memory as a CSV file
- The function to save values of device addresses for the Recipe Function to the external memory as a recipe file (CSV file)
- Entering Hiragana and Kanji to the Character Input using Key Buttons or Keypad
- SNTP Server and Time Zone functions



- The clock function uses the date and time data of the computer on which the simulator is running.
- The simulator replaces the following fonts with Windows fonts and displays them.*1

Stroke: Courier New

7-seg: 7barSP

*1 HG5G/4G/3G/2G-V, HG4G/3G, HG2G-5F/-5T, HG1G/1P only

Chapter 27 Pass-Through Function

This chapter describes the overview of the Pass-through function, its configuration and other important details.

1 Overview

HG2J-7U HG5G-V HG4G-V HG4G HG3G-V HG3G HG2G-V HG2G-5F HG2G-5T HG1G HG1P

1.1 How the Pass-Through Function is Used

The Pass-through function downloads or uploads a PLC program from a computer or an external device via the MICRO/I.

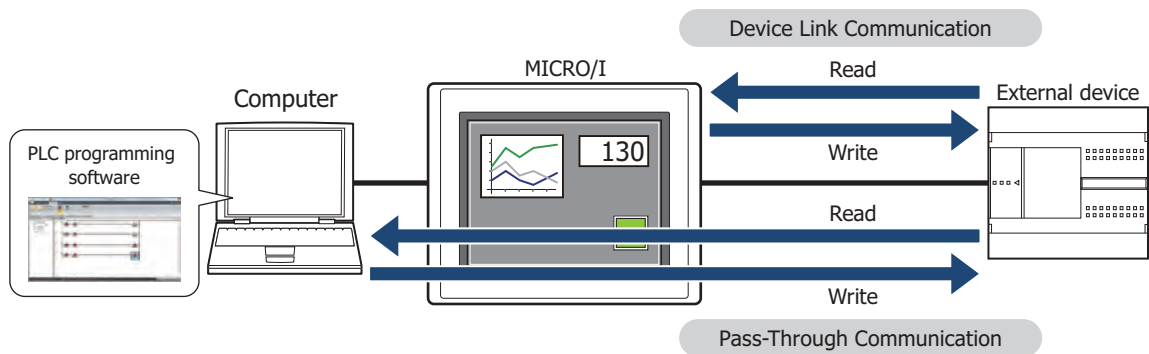

1.2 Supported External Devices

This Pass-through function can be used with the following PLCs:

Manufacturer	Series Name	Model	Communication Driver
IDEC	OpenNet Controller	FC3A	OpenNet, MICROSmart, SmartAXIS Pro/Lite(RS232C/485)
	MICROSmart	FC4A	
		FC5A	
		FC6A	MICROSmart(FC6A)(RS232C/485)
Mitsubishi*1	FX Series	FX0, FX0N, FX1, FX1S, FX2, FX2C	MELSEC-FX (CPU)
		FX2N, FX2NC, FX1N, FX1NC	MELSEC-FX2N (CPU)
		FX3U, FX3UC	MELSEC-FX3UC (CPU)
	QCPU	Q02CPU, Q02HCPU	MELSEC-Q (CPU)



The corresponding device type differs depending on the communication driver which be used.

For FC6A type, please select **MICROSmart (FC6A) (RS232C / 485)** driver.

If use **OpenNet, MICROSmart, SmartAXIS Pro / Lite (RS232C485)** driver, the device type is partially different. For details, refer to the WindO/I-NV4 External Device Setup Manual.

When the IDEC PLC is used, the supported function varies based on the port.

Series Name	Model	Serial port	Device Monitor	Download, Upload*2
OpenNet Controller	FC3A	Port 1	YES	YES
		Port 2	YES	YES
MICROSmart	FC4A	Port 1	YES	YES
		Port 2	YES	YES
	FC5A	Port 1	YES	YES
		Port 2	YES	YES
		Port 3 to 7	YES	NO
	FC6A (FC6A-C*****E/-C*****EJ only)	Port 1 (Internal)	YES	YES
		Port 2 to 9	YES	YES*3
	FC6A (FC6A-D****CEE only)	Port 1 to 33	YES	YES*3
SmartAXIS Pro/Lite	FT1A	Port 2	YES	NO
		Port 3	YES	NO

*1 We tested by GX Developer Version 8

*2 User program only

*3 Use WindLDR Ver. 8.6.1 or higher

1.3 How to Connect when Using the Pass-Through Function

Connect the computer and MICRO/I with an Ethernet cable or a USB cable, and connect the MICRO/I and external device with a serial cable.

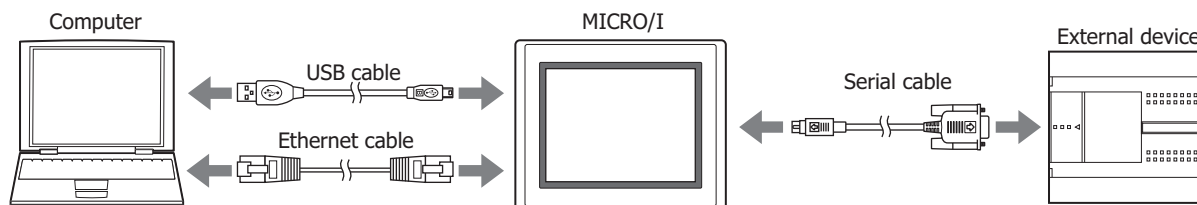

1.4 Use the Pass-Through Function

The Pass-through function operates under the following conditions:

- The MICRO/I is in the Run mode or Monitor mode.
- A communication driver that supports the Pass-through operation.
- In the Project Settings dialog box, on the **Communication Driver** tab, the **Enable Pass-Through** check box is selected.



Use the Pass-through Tool if you have the following:

- A competitor's PLC.
- Currently using WindLDR Ver. 5.0* - 6.0*.

For details about Pass-through Tool, refer to the Pass-through Tool Manual.

2 Pass-Through Function Settings Procedure

HG2J-7U HG5G-V HG4G-V HG4G HG3G-V HG3G HG2G-V HG2G-5F HG2G-5T HG1G HG1P

This section describes the settings procedure for the Pass-through function. The Pass-through function can be configured with WindO/I-NV4 or in System Mode.

2.1 How to Enable the Pass-Through Function in WindO/I-NV4

- 1 On the **Configuration** tab, in the **System Setup** group, click **Project**.

The Project Settings dialog box is displayed.

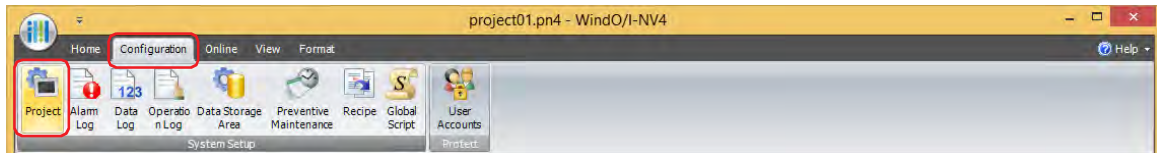

- 2 Click the **Communication Driver** tab.

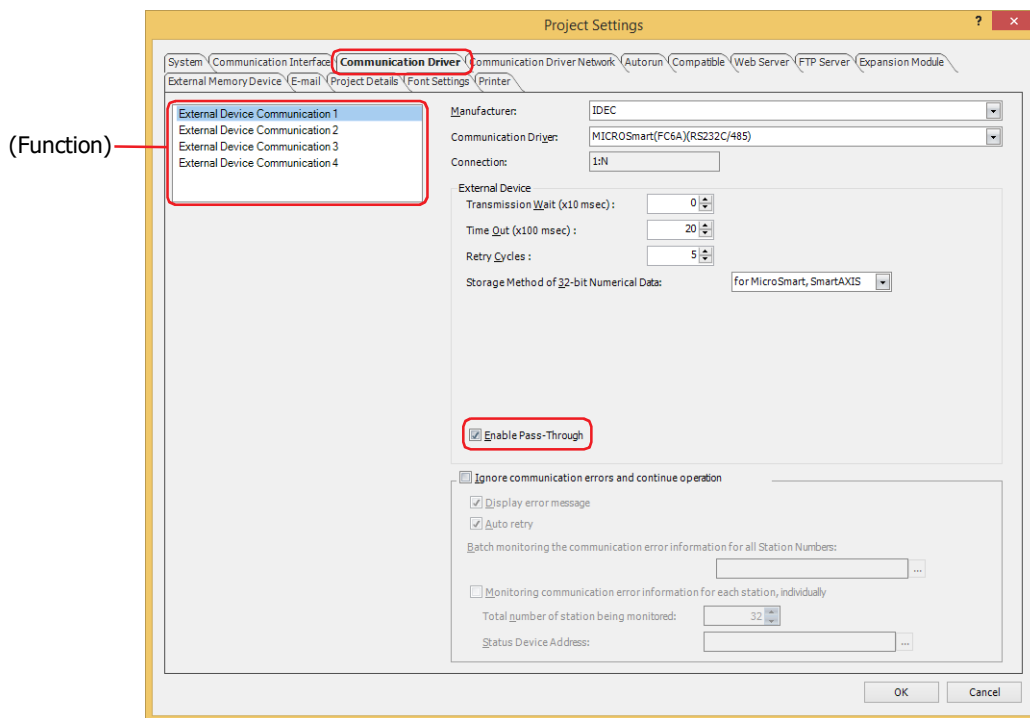

- 3 Select the external device communication from the (Function) to make the Pass-through function is enabled.

- 4 Under **External Device**, select the **Enable Pass-Through** check box.

This option is accessible if the **Communication Driver** is supported. For details, refer to "1.2 Supported External Devices" on page 27-2.

- 5 Click **OK**.

This concludes the configuration to enable the Pass-through function.

2.2 How to Enable the Pass-Through Function in MICRO/I System Mode

- 1 Press the upper-left corner of the MICRO/I screen for three or more seconds.
The Maintenance Screen is displayed.

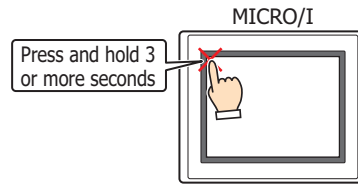

- 2 Press **System Mode**.

The screen changes to the Top Page in the System Mode.

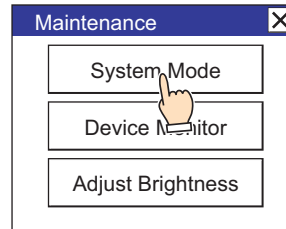

If a password has been configured for the project data, the Password Screen is displayed. Select user name and enter password. For details, refer to Chapter 23 "User Accounts and the Security Function" on page 23-1.

- 3 Press **Main Menu**.

The Main Menu screen is displayed.

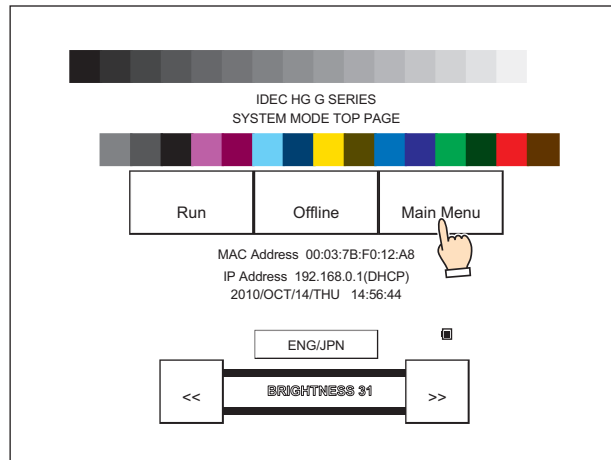

4 Press **Initial Setting**.

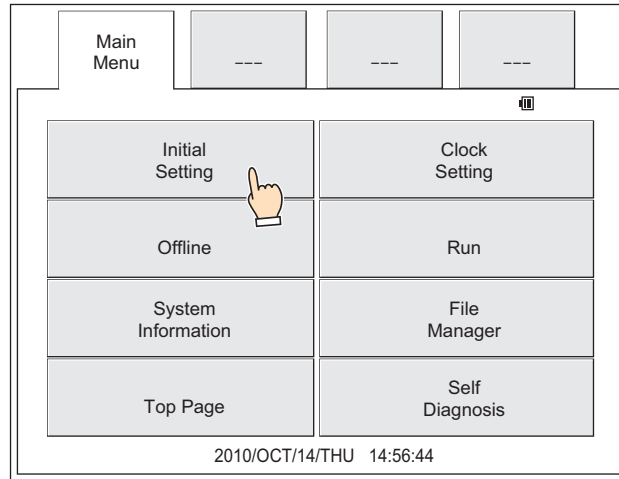

5 Press **External Device Communication** (HG5G/4G/3G/2G-V, HG4G/3G, HG2G-5F) or press **Ext. Device** (HG2G-5T, HG1G/1P).

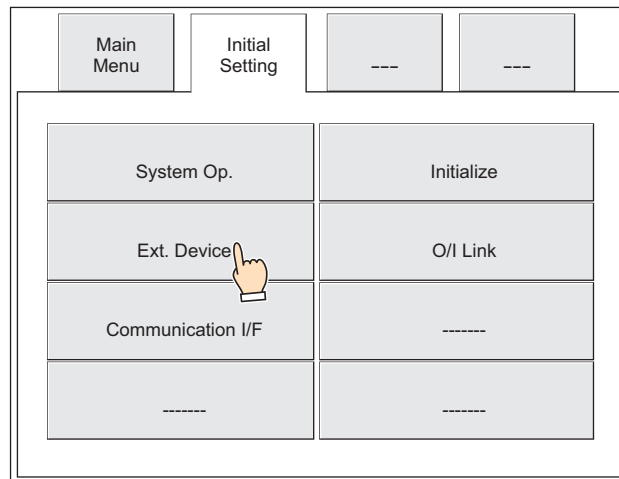

6 Press **External Device Communication 1** to **External Device Communication 4** (HG5G/4G/3G/2G-V, HG4G/3G, HG2G-5F) or press **Ext. Device 1** to **Ext. Device 4** (HG2G-5T, HG1G/1P).

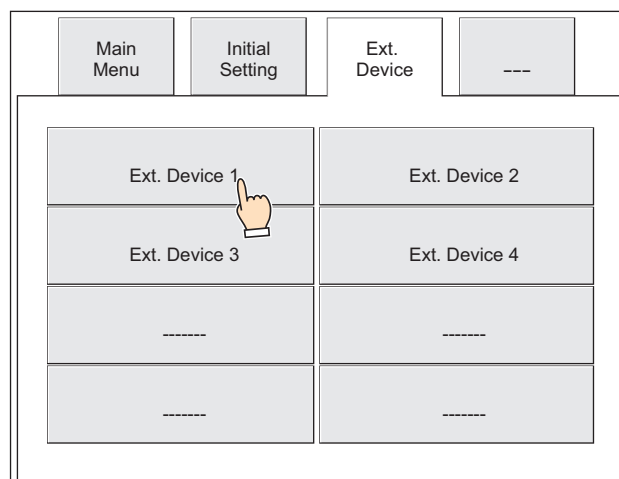

- 7 Press **Pass-Through Setting** (HG5G/4G/3G/2G-V, HG4G/3G, HG2G-5F) or press **Pass Through** (HG2G-5T, HG1G/1P).

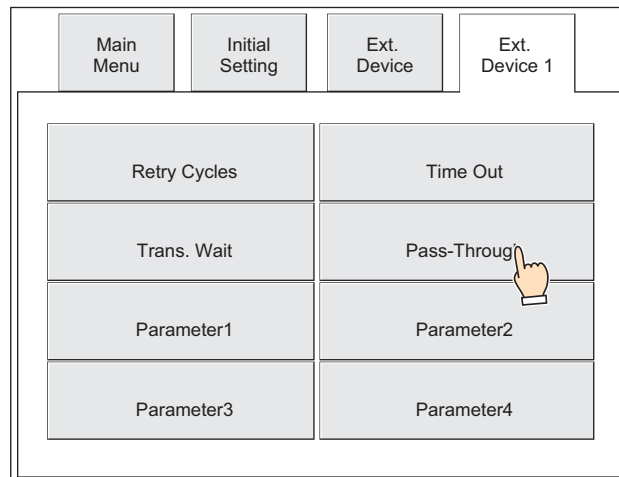

- 8 Select the **Enable PassThrough** check box and press **Save** (HG5G/4G/3G/2G-V, HG4G/3G, HG2G-5F) or **SAVE** (HG2G-5T, HG1G/1P).

When the setting is saved, "The value was updated." is displayed.

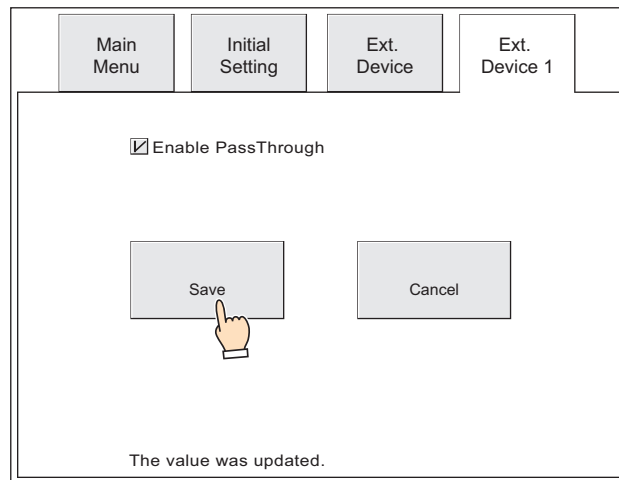

This concludes the configuration to enable the Pass-through function.

3 Important Notes

HG2J-7U HG5G-V HG4G-V HG4G HG3G-V HG3G HG2G-V HG2G-5F HG2G-5T HG1G HG1P

- When sending and receiving data with an external device from PLC programming software using the Pass-through function, MICRO/I Device Link Communication and Pass-through function communication are performed at the same time, so the data transfer speed of each will slow down.
In the case above, if Device Link Communication between the MICRO/I and the external device is stopped by the Pass-through Tool, the data transfer speed of downloading or uploading the PLC program via MICRO/I will be improved. However, "Communication Error" will be displayed on the MICRO/I screen.
- Please do not use communication with WindO/I-NV4 and Programming software at the same time.
- If the communication via Pass-through fails, change the settings such as Baud Rate, Timeout, Transfer Mode etc on PLC programming software.

Example: WindLDR
Transfer Mode: ASCII
Baud Rate: 9600 bps
Timeout: 5000 msec.

- If one of the following problems occurs while using the Pass-through function and a communication error is displayed, then reset the power of MICRO/I.
 - The communication cable between the computer and MICRO/I was disconnected after stopping communication of the MICRO/I and the external device using the Pass-through Tool.
 - The computer was forcibly shut down due to a power loss or other problem
- The Pass-through function can only use one of "External Device Communication 1" through "External Device Communication 4".

Chapter 28 Maintenance

This chapter describes the web server function and the FTP server function used during maintenance and Downloader.

1 Web Server Function

HG2J-7U HG5G-V HG4G-V HG4G HG3G-V HG3G HG2G-V HG2G-5F HG2G-5T HG1G HG1P

1.1 Web Server Function Overview

The web server function remotely performs the MICRO/I maintenance using a web browser terminal such as a computer or smartphone.

- Monitoring
- Remote Control
- Remote Monitoring
- Displaying Custom Web Page



Custom web pages are downloaded to external memory^{*1}. The external memory^{*1} must be inserted before downloading.

1.2 System Composition

An example system configuration for using the web server function is shown below. Configure the MICRO/I Ethernet settings (IP address, subnet mask, default gateway) and connect to a local network.

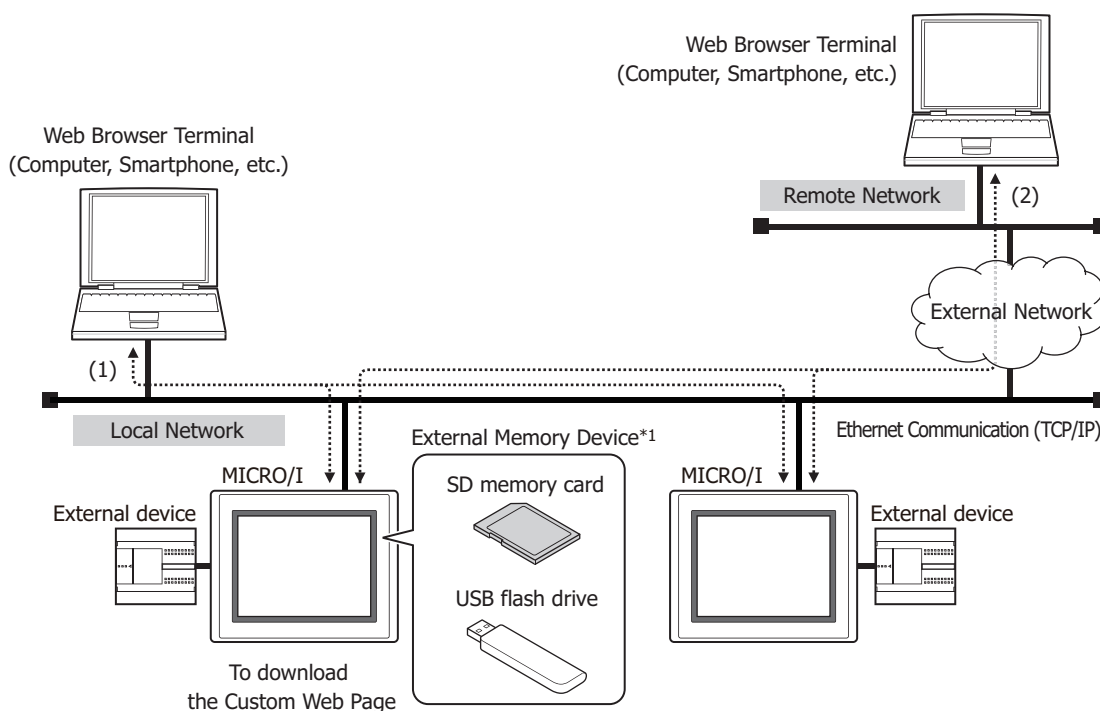

- (1) Access the MICRO/I from a web browser connected to the local network to use the web server function.
- (2) When the local network is connected to an external network, configure the web browser connected to the remote network with the local network's gateway, router, and other settings. Access the MICRO/I from the remote web browser to use the web server function.



For gateway, router, and other settings, contact the administrator of the network which the MICRO/I is connected to.

*1 USB flash drive inserted in USB1 for HG2J-7U, SD memory card for HG5G/4G/3G/2G-V, HG4G/3G and HG2G-5F, USB flash drive for HG2G-5T and HG1G/1P

1.3 Minimum System Requirements

Use of the following web browsers is recommended with the web server function.

OS of the computer or smartphone	Recommended Web Browsers
Windows 10/8/7	Google Chrome 47 or higher Mozilla Firefox 42 or higher Microsoft Internet Explorer 11
Android	Google Chrome 47 or higher
iOS	Safari 8 or higher



Web browsers other than those recommended can use the web server function, but problems may occur with features such as automatic updates and displaying images.

1.4 Settings and Connection Method

Follow the procedure below to display the MICRO/I web page on a web browser.

- 1 Connect the MICRO/I to a local network.

Connect the MICRO/I's Ethernet interface to the Ethernet port of the local network's router or hub with a LAN cable.

- 2 Configure the MICRO/I.

- Ethernet settings
☞ Refer to Chapter 4 "When Ethernet is selected under Interface Configuration" on page 4-41.
- User account settings
☞ Refer to Chapter 23 "3 Security Dialog Box" on page 23-37.
- Remote operation & monitoring function settings
☞ Refer to "Web Server Function Configuration Procedure" on page 28-4.

- 3 Connect the MICRO/I.

Start the web browser on the web browser terminal and connect the following URL.

`http://(MICRO/I IP address)/`

Example 1: When the MICRO/I's IP address is 192.168.0.1
`http://192.168.0.1/`

Example 2: When the MICRO/I's IP address is 192.168.0.1 and the web server's port number is 8080
`http://192.168.0.1:8080/`

In the example above, the web page configured by **Default Showing Page** on **Web Server** tab in Project Settings dialog box is displayed.

To open other pages, go to the following URL.

Name	Recommended Web Browsers
System Information page	http://MICRO/I IP address:Port number/top.html Example: The MICRO/I's IP address is 192.168.0.1. http://192.168.0.1/top.html
Remote Monitor page	http://MICRO/I IP address:Port number/remote_monitor.html Example: The MICRO/I's IP address is 192.168.0.1. http://192.168.0.1/remote_monitor.html
Remote Control page	http://MICRO/I IP address:Port number/remote_control.html Example: The MICRO/I's IP address is 192.168.0.1. http://192.168.0.1/remote_control.html
Custom Web Page	http://MICRO/I IP address:Port number/viewer/view.htm?pagepath= File name Example: The MICRO/I's IP address is 192.168.0.1 and the Page1.page is displayed. http://192.168.0.1/viewer/view.htm?pagepath=Page1.page

4 Enter the user name and password configured in the running project.

Enter the user name and password for a user in the "Administrator", "Operator", or "Reader" security group.

User name: The user name configured in the running project. (Default: User)

Password: The alphanumeric password of 4 to 15 characters long configured in the running project. If a password is not set, leave the password blank.



- An "Administrator" or "Operator" user account is required to open the remote operation page.
- If you do not access the MICRO/I for 5 minutes or more after accessing it, you will be required to reenter your user name and password.
Some web browsers will remember the user name and password you entered and automatically reenter them when required until the browser is closed. With this kind of web browser, you are not required to reenter your user name and password after 5 minutes or more have elapsed since accessing the MICRO/I.
- The MICRO/I can be accessed simultaneously from multiple web browser terminals. However, the maximum number of web browsers that can simultaneously access it is five.

When the user name and password are successfully verified, the MICRO/I web page is displayed.

● Web Server Function Configuration Procedure

- 1 On the **Configuration** tab, in the **System Setup** group, click **Project**.
The Project Settings dialog box is displayed.

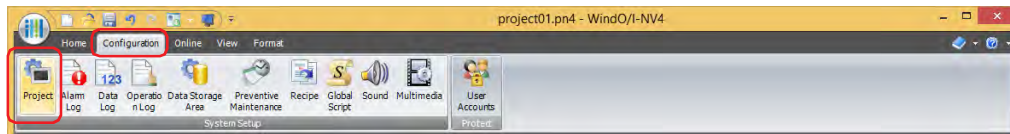

- 2 Configure the items on the **Web Server** tab.

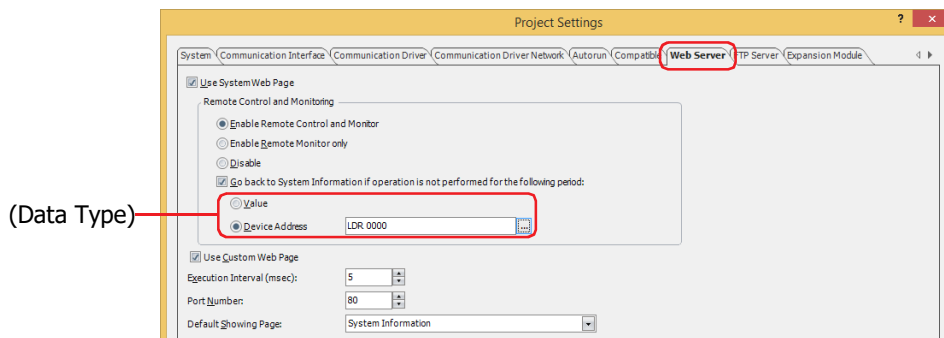

■ **Use System Web Page**

The Remote Control page, Remote Monitor page or System Detailed Information page of MICRO/I can be accessed from a web browser terminal.

Remote Control and Monitoring: Select the functions that are allowed when MICRO/I is accessed from a web browser terminal.

When the remote control or remote monitoring function is enabled, you can have the screen automatically change to the System Information page if no operations are performed in the Remote Control page or Remote Monitor page for the specified time. Refer to Chapter 4 "Remote Control and Monitoring" on page 4-66.



If **Device Address** is selected for (Data Type), note the following points:

- If the value of device address is set to 61 or higher, it will be treated as 60 minutes.
- Once a network connection is established between the web browser and the MICRO/I, the timeout period cannot be changed. The timeout period needs to be set in Device Address before a web browser access to the MICRO/I.

■ **Use Custom Web Page**

The Custom Web Page saved in the external memory device of MICRO/I can be accessed from a web browser terminal. Refer to "1.6 Custom Web Page" on page 28-12.

■ **Execution Interval (msec)**

Specifies the interval (0 to 5000 msec) for the MICRO/I to return data.

When the remote control function and the remote monitoring function place a load on MICRO/I operation, that load can be reduced by increasing this value.

However, the display update speed in the web browser will become slower. Change this value if the display speed of custom web pages is slow.

■ **Port Number**

Specifies the port number to use for the web server function.

■ **Default Showing Page**

Select the web page to display first when accessing the MICRO/I from a web browser terminal.

- 3 Click the **OK** button.

1.5 System Web Page

The System Web Page is the provided web pages that can display the system information and support the remote functions. Accesses the MICRO/I from a web browser terminal to browse it.

- Page configuration

The MICRO/I web pages have the following page configuration.

There are links to each page from the homepage ([http://\(IP address of MICRO/I\)/](http://(IP address of MICRO/I)/)).

System Detailed Information Page	http://MICRO/I IP address:Port number/top.html
Remote Functions Page	
Remote Monitoring Page	
Remote Operation Page	

● Screen configuration

Each page can be displayed in either English or Japanese. When the web browser's preferred language is set to Japanese, the pages are displayed in Japanese. When the web browser's preferred language is set to a language other than Japanese, the pages are displayed in English.

All pages are displayed in a right-left two frame configuration on web browsers that support frames. See example below.



■ Left frame

Links to each page are shown in this menu frame.

■ Right frame

Shows the function page.

Except for the full screen remote monitoring screen and remote operation screen, all of the pages shown in the right frame have a **Maximize** link, **Menu** link, and **Home** link.

[Maximize]: Disables the frame display and shows the page in the full web browser screen.

Menu: Shows the menu page.

The content of the menu page is the same as the left frame (menu frame) when showing the frame.

Home: Goes to the System Detailed Information Page.



When using a web browser that does not support frames, the display position of items changes, but the content is the same.

● System Detailed Information Page

Click the **System Detailed Information** link in the left frame or the **Home** link in the right frame to show the system detailed information page.

See example below.

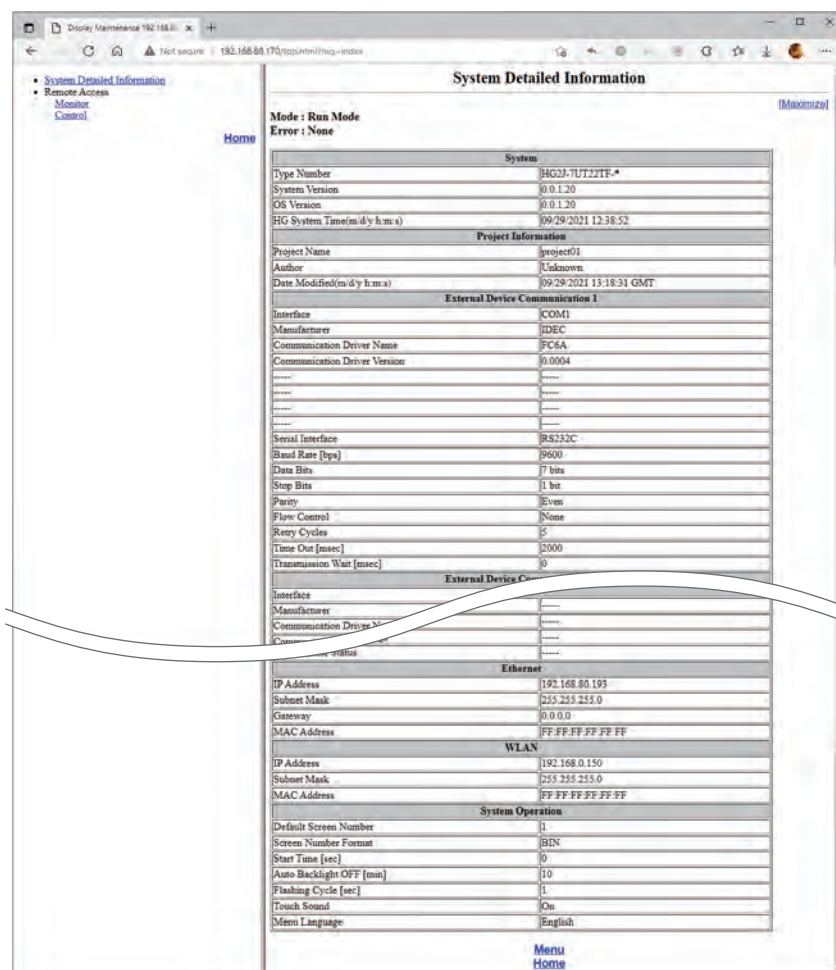

The MICRO/I information shown on the system detailed information page is listed below.

Display item		Description
Mode		Shows the system's current mode. <ul style="list-style-type: none"> • Run Mode • System Mode • Monitor Mode • Offline Mode • Data Transfer Mode
	Error	Shows the following errors. <ul style="list-style-type: none"> • Communication Error • No Screen Data • Waiting for Default Screen No. • Processing Error • Backup Data Lost • Network Off Line • Device Range Error • Script Error
System	Type Number	Shows the MICRO/I type model number.
	System Version	Shows the MICRO/I system software version.
	OS Version ^{*1}	Shows the MICRO/I operating system software version.
	System Time (m/d/y h:m:s)	Shows the date and time of the MICRO/I's internal clock when the page was acquired.

*1 HG2J-7U only

Display item		Description
Project Information	Project Name	Shows the project name. (When characters other than alphanumeric characters are included on the English page, the project name is shown as "-Wrong Strings-".)
	Author	Shows the project author.
	Date Modified (m/d/y h:m:s)	Shows the project's last modified date/time. The displayed date/time is Greenwich Mean Time (GMT).
	Installed Font*2	Shows the extension fonts installed in the MICRO/I.
External Device Communication 1 to 4	Interface	Shows the communication interface.
	Manufacturer	Shows the external device manufacturer name.
	Communication Driver Name	Shows the communication driver name.
	Communication Driver Version	Shows the communication driver version.
	(Parameter unique to driver - 1)	The four items below the driver version show each driver's unique settings. The item names differ according to the drivers.
	(Parameter unique to driver - 2)	
	(Parameter unique to driver - 3)	
	(Parameter unique to driver - 4)	
	Serial Interface	Shows the serial interface used as the External Device Communication 1 to 4.
	Baud Rate [bps]	Shows the speed of the External Device Communication 1 to 4.
	Data Bits	Shows the data length of the External Device Communication 1 to 4.
	Stop Bits	Shows the stop bits of the External Device Communication 1 to 4.
	Parity	Shows the parity of the External Device Communication 1 to 4.
	Flow Control	Shows the flow control method of the External Device Communication 1 to 4.
Retry Cycles	Shows the number of times to retry communication before displaying a communication error of the External Device Communication 1 to 4.	
Time Out [msec]	Shows the response waiting time from the External Device Communication 1 to 4.	
Transmission Wait [msec]	Shows the transmission interval for a communication command of the External Device Communication 1 to 4.	
O/I Link	Baud Rate [bps]	Shows the O/I link communication speed.
	O/I Link Station	Shows the O/I link master station or slave station number.
	Slave Registration Settings	Shows the slave registration setting register for the O/I link communication master.
	Slave Online Status	Shows the slave online information register for the O/I link communication master.
Ethernet	IP Address	Shows the IP address.
	Subnet Mask	Shows the subnet mask.
	Gateway	Shows the default gateway address.
	MAC Address	Shows the Ethernet MAC address.
Wireless LAN*1	IP Address	Shows the IP address of the wireless LAN.
	Subnet Mask	Shows the subnet mask of the wireless LAN.
	MAC Address	Shows the Ethernet MAC address of the wireless LAN.
System Operation	Default Screen Number	Shows the screen number displayed when MICRO/I starts running.
	Screen Number Format	Shows the depiction method for the displayed screen number.
	Start Time [sec]	Shows the time until starting communication with the external device.
	Auto Backlight OFF [min]	Shows the time for the backlight to turn off automatically.
	Flashing Cycle [sec]	Shows the flashing speed for parts and draw objects with the blinking attribute.
	Touch Sound	Shows On or Off for the touch panel confirmation sound.
	Menu Language	Shows the system screen's display language.



- The contents of the display items on the system detailed information page are the values set on the **Project Settings** dialog box displayed by clicking Project under System Setup on the Configuration tab in WindO/I-NV4.
- For details on the item of the External Device Communication 1 to 4, refer to the WindO/I-NV4 External Device Setup Manual.

*1 HG2J-7U only

*2 HG5G/4G/3G/2G-V, HG4G/3G, HG2G-5F/-5T, HG1G/1P only

● Remote monitoring page

You can remotely monitor the MICRO/I from a web browser. When the left frame is displayed, click the **Monitor** link in the left frame to display the remote monitoring page.

A screen image of the screen displayed on the MICRO/I is shown.

See example below.

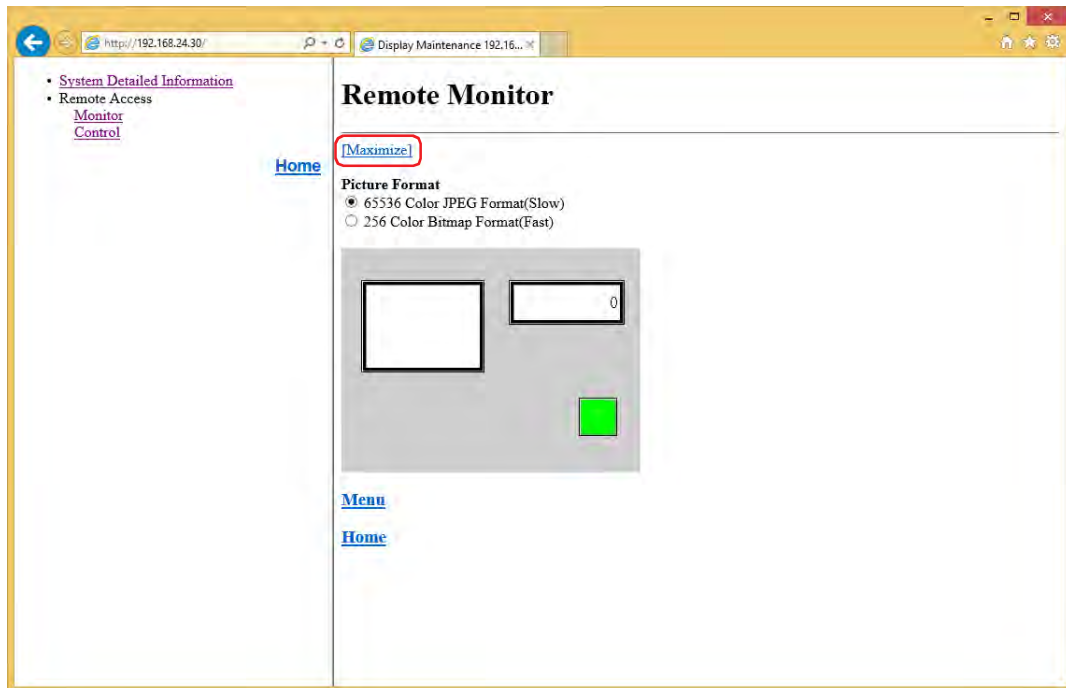

- On the remote monitoring page, the MICRO/I cannot be controlled even when the screen image displayed in the web browser is clicked. To control the MICRO/I, please open the remote control page.
- For the HG5G/4G/3G/2G-V, HG4G/3G and the HG2G-5F, when the MICRO/I display is off by the backlight auto off function or the System Area 1 screen display (address number+1, bit 7), the screen image is not displayed in a web browser.
- If JavaScript is prohibited in the web browser settings, the web page will not operate correctly. Please enable JavaScript.
- The screen image cannot be displayed on web browsers that do not support the bitmap or JPEG format.
- The display may not be updated depending on the web browser's cache settings.
- While displaying the remote monitoring page, the MICRO/I scan time becomes longer.

The following items can be specified on the remote monitoring page.

■ Picture Format

Specify the image format to use in remote monitoring.

- | | |
|---------------------------------|---|
| 65536 Color JPEG Format (Slow): | Capable of showing the screen image displayed on the MICRO/I in the web browser without degradation. However, the update speed of the web browser display is slower than 256 Color Bitmap Format (Fast) and the MICRO/I screen update speed also slows down. |
| 256 Color Bitmap Format (Fast): | Shows the screen image displayed on the MICRO/I reduced to 256 colors. The screen image displayed on the MICRO/I is somewhat degraded, but the update speed of the display on the web browser speeds up and the impact on the MICRO/I screen update speed is reduced. (The screen update speed of the 256 color bitmap format tends to be faster than the 65536 color JPEG format, but it may be slower depending on the screen's displayed content.) |

■ **[Maximize] link**

Hides the left frame, page title, and screen format settings, and shows only the MICRO/I screen image. The screen format settings are the same as before clicking the **[Maximize]** link.

These screens are examples.

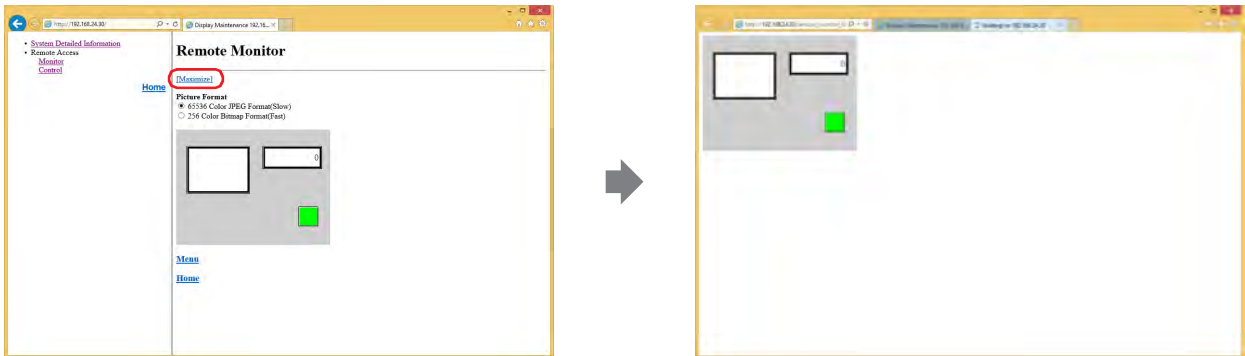

● Remote control page

You can remotely control the MICRO/I from a web browser. When the left frame is displayed, click the **Control** link in the left frame to display the remote control page.

An image of the screen displayed on the MICRO/I is shown. You can also control the MICRO/I by clicking on the displayed screen image.

This screen is an example.

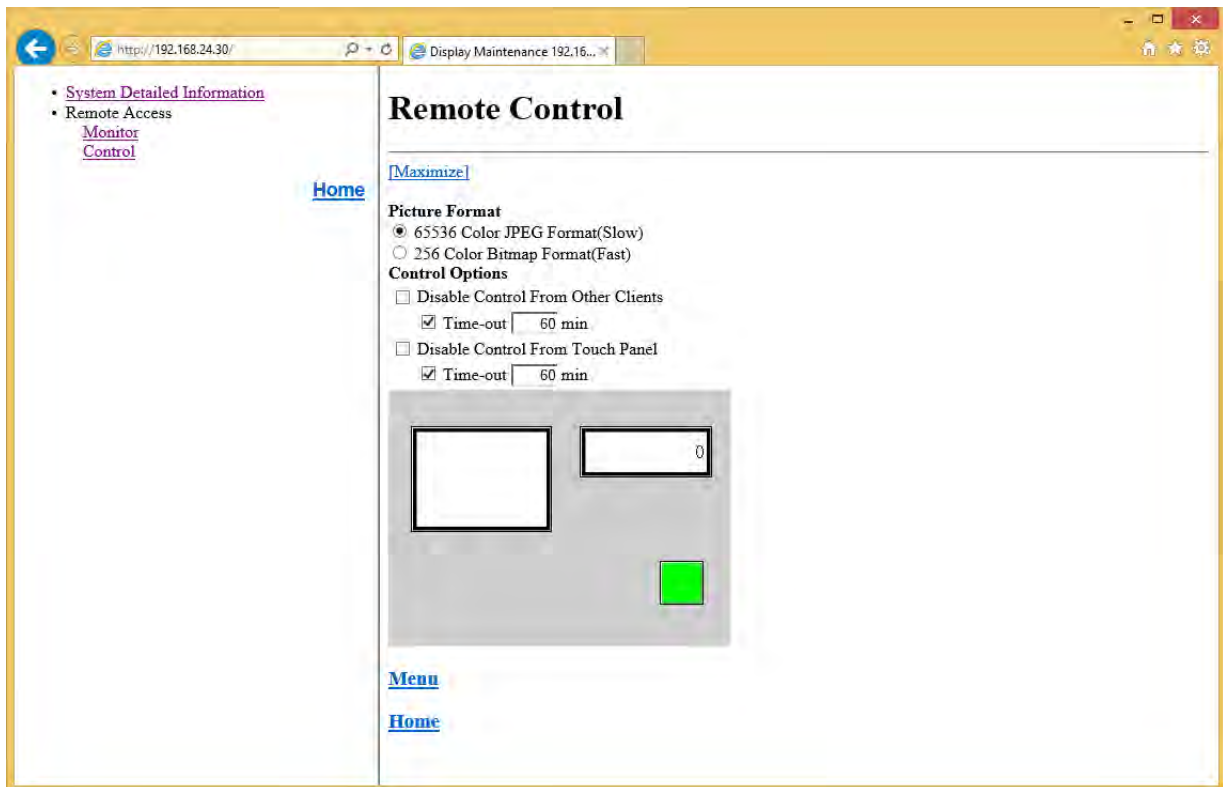

- ❗ If JavaScript is prohibited in the web browser settings, the web page will not operate correctly. Please enable JavaScript.
- The screen image cannot be displayed on web browsers that do not support the bitmap or JPEG format.
- The display may not be updated depending on the web browser's cache settings.
- While displaying the remote control page, the MICRO/I scan time becomes longer.

The following items can be specified on the remote operation page.

■ **Picture Format**

Specify the image format to use in remote operation.

65536 Color JPEG Format (Slow): Capable of showing the screen image displayed on the MICRO/I in the web browser without degradation. However, the update speed of the web browser display is slower than **256 Color Bitmap Format (Fast)** and the MICRO/I screen update speed also slows down.

256 Color Bitmap Format (Fast): Shows the screen image displayed on the MICRO/I reduced to 256 colors. The screen image displayed on the MICRO/I is somewhat degraded, but the update speed of the display on the web browser speeds up and the impact on the MICRO/I screen update speed is reduced. (The screen update speed of the 256 color bitmap format tends to be faster than the 65536 color JPEG format, but it may be slower depending on the screen's displayed content.)

■ **Control Options**

Operation restrictions prohibit operation from other computers or the touch panel of the MICRO/I while the MICRO/I is being remotely controlled.

Disable Control From Other Clients: Check to prohibit remote control from other computers. When this function is enabled, if a web browser is already accessing the MICRO/I, the message **Remote Control is disabled by other client** will be displayed on the other browser and access is denied. When disabled, the MICRO/I can be accessed from multiple web browsers.

Disable Control From Touch Panel: Check to prohibit control with the MICRO/I touch panel. When this function is enabled, if a web browser is already accessing the MICRO/I, the message **Touch panel is disabled by Remote Control Function** will be displayed on MICRO/I and operation by the MICRO/I touch panel is not possible. When disabled, control by the MICRO/I touch panel is possible.

■ **[Maximize]**

Hides the left frame, page title, and screen format settings, and shows only the MICRO/I screen image. The screen format settings are the same as before clicking the **[Maximize]** link.

1.6 Custom Web Page

The Custom Web Page is the web page which you create by the Web Page Editor. Downloads the created web page file to the external memory device inserted in the MICRO/I, and accesses the MICRO/I from a web browser terminal to browse it.



Custom web pages are downloaded to external memory^{*1}. The external memory^{*1} must be inserted before downloading.



To browse the Custom Web Page on the web terminal, select the **Use Custom Web Page** check box under the **Web Server** tab of the **Project Settings** dialog box. If the display speed of custom web pages is slow, change the value of **Execute Interval** on the **Web Server** tab in the **Project Settings** dialog box.

● Web Page Editor

Use the Web Page Editor to create a Custom Web Page.

Works on the Web Page Editor

The Web Page Editor works on an web browser. The recommended web browser is as follows:

- Google Chrome 47 or later
- Mozilla Firefox 42 or later
- Microsoft Internet Explorer 11



- The recommended web browser must be set for default web browser before using the Web Page Editor.
- We confirm that up to 100 pages of the Custom Web Page can be created by using the Web Page Editor.

● Creating Custom Web Page

This example describes the case of pressing the Switch 1 turns on the Lamp 1. In this case, the HMI Internal Relay LM0 have been used in the current project.

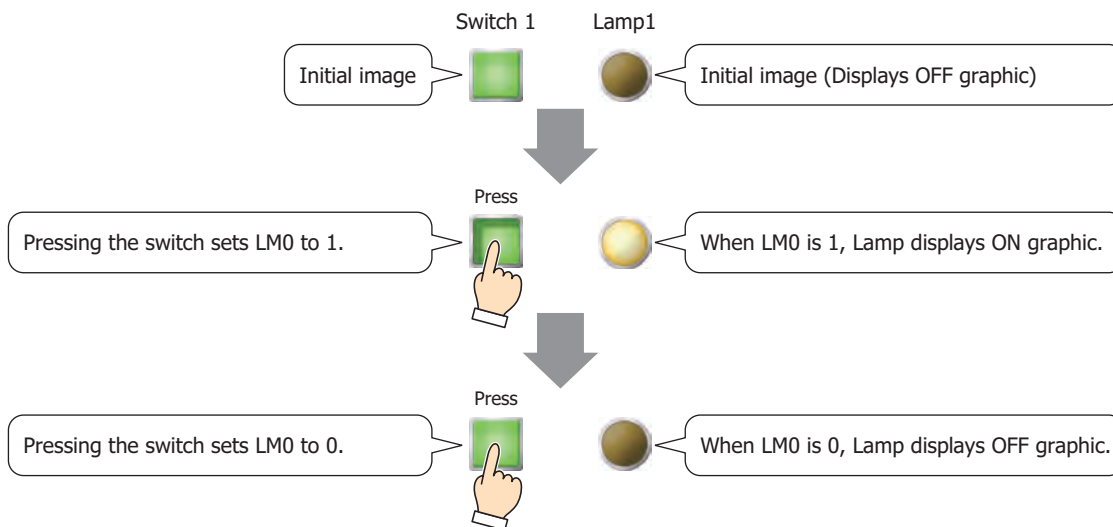

*1 USB flash drive inserted in USB1 for HG2J-7U, SD memory card for HG5G/4G/3G/2G-V, HG4G/3G and HG2G-5F, USB flash drive for HG2G-5T and HG1G/1P

- 1 On the **Configuration** tab, in the **Editor** group, click **Web Page Editor**.

Web Page Editor starts.



If the **Windows Security Alert** dialog box is displayed, click **Allow access**.



- 2 Configures a Switch 1.

Select **Input, Switch** in the **Components** list, and drag and drop it on the editing area.

The switch will be placed on the area with the predefined size.



To place a switch on the area with the desired size, click **Switch** in the **Components** list, and then drag the cross hair cursor on the editing area.

- 3 Click the switch placed on the work area and on the **Property** tab, for **Link Box**, click .

The **Device Tree** dialog box is displayed.

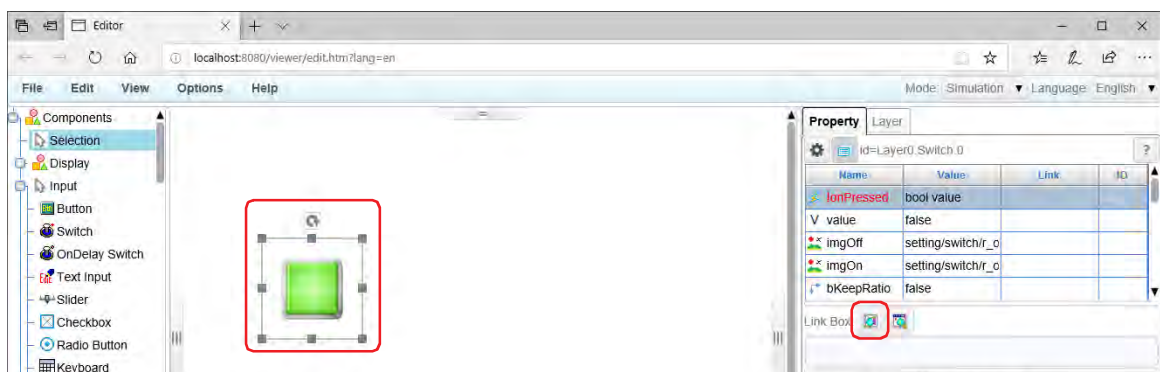

- Click the device address to configure for the Switch 1 and click **OK**.

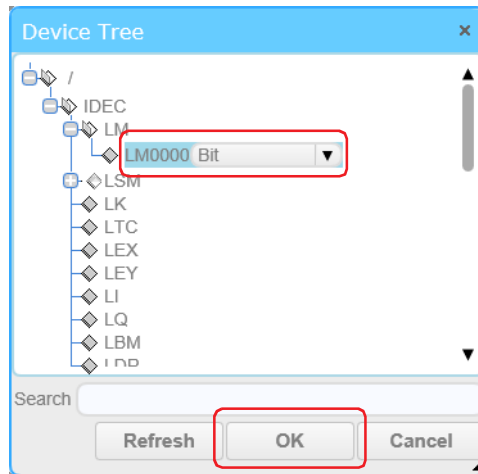

The internal devices of the MICRO/I are displayed in the **Device Tree** dialog box.

To display an address number, it needs to be configured in the project being edited before Web Page Editor opens.

For device addresses not displayed in the **Device Tree** dialog box, input them directly into the text box below **Link Box** of the **Property** tab.

The format of the device address to edit directly in text box is as follows:

IDECD: [Device type].[Device Address].[Data Type]

Example: Device Type is LDR(HMI Data Register), Address Number is 100, and Data Type is UBIN16(W)

IDECD:LDR:LDR0100.UBIN16(W)

This configures LM0 for the Switch 1.

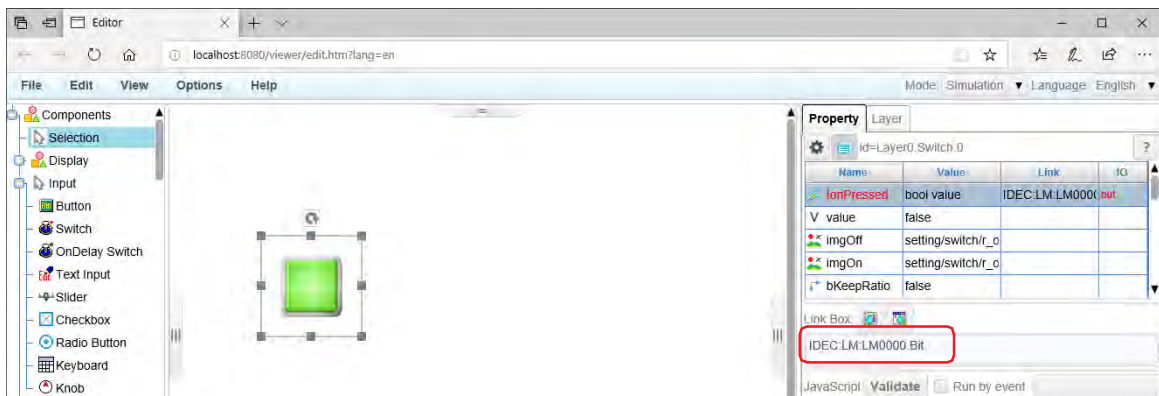

- Repeat step 2 through 4 to configure the Lamp 1 in the same procedure with the Switch 1.

- Click **File** on the menu bar and click **Save page as**.

The **Save Page** dialog box is displayed.



- 7 Enter the file name in **Save Name**, and click **OK**.

A confirmation message is displayed.

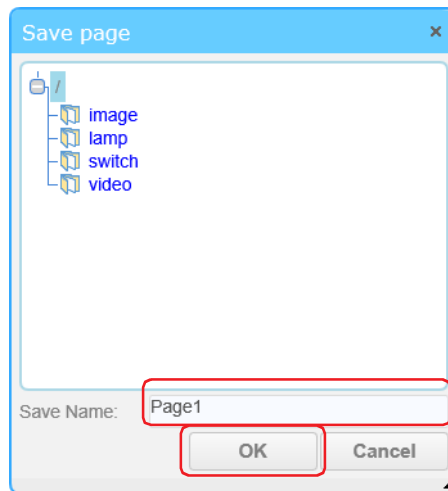

The saved file name is displayed in Web Page Editor on the **Project** window.

- 8 Click **OK**.

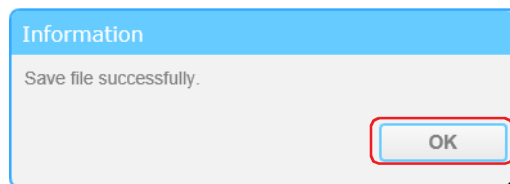

This concludes creating the Custom Web Page.



- For details on Web Page Editor, refer to the Web Page Editor help that is displayed by clicking **Help** of **Help** on the menu bar.
- The image files and movie files that have been added with the Web Page Editor are displayed in Web Page Editor on the **Project** window.
- To edit the Custom Web Page, double-clicking a file name displayed in Web Page Editor on the **Project** window.

2 FTP Server Function

HG2J-7U HG5G-V HG4G-V HG4G HG3G-V HG3G HG2G-V HG2G-5F HG2G-5T HG1G HG1P

2.1 What Can Be Done with the FTP Server Function

The FTP server function enables communication from MICRO/I (FTP server) to a computer (FTP client). From the FTP client, the followings are enabled.

- Reading files from the external memory device inserted in the MICRO/I
- Writing files to the external memory device inserted in the MICRO/I

2.2 System Composition

An example system configuration for using the FTP server function is shown below.

Configure the MICRO/I Ethernet settings (IP address, subnet mask, default gateway) and connect to a local network.

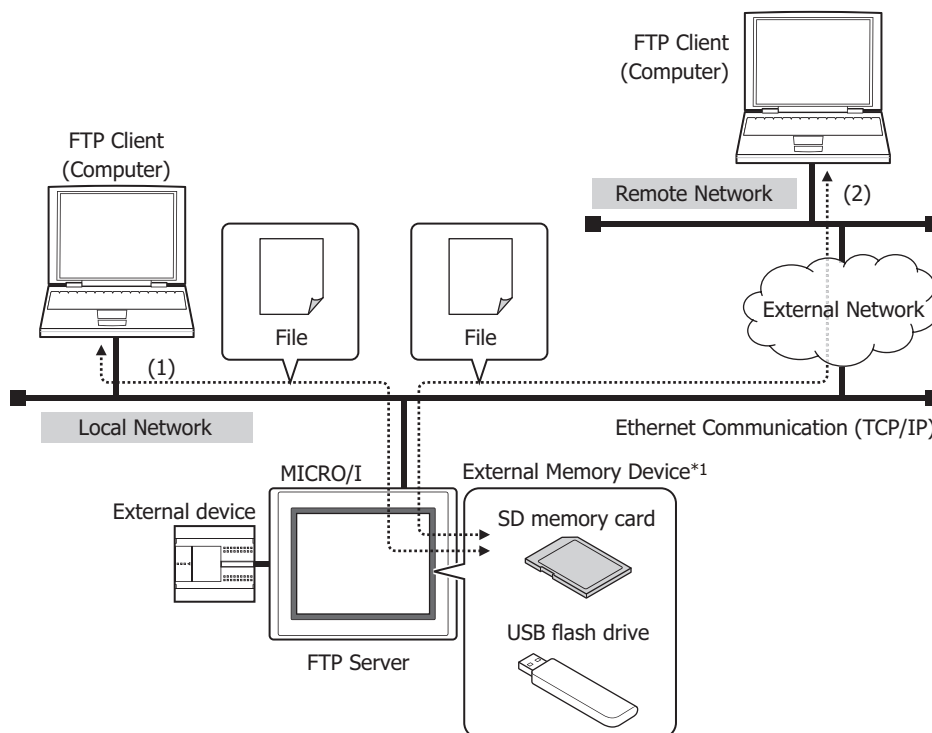

- (1) Access the MICRO/I from a FTP client connected to the local network to use the FTP server function, and read or write the file contained in the external memory device inserted in the MICRO/I.
- (2) When the local network is connected to an external network, configure the FTP client connected to the remote network with the local network's gateway, router, and other settings. Access the MICRO/I from the remote FTP client to read or write the files contained in the external memory device inserted in the MICRO/I.



For gateway, router, and other settings, contact the administrator of the network which the MICRO/I is connected to.

*1 Only USB flash drive for HG2J-7U, HG2G-5T and HG1G/1P

2.3 Hierarchy of the FTP Server

The hierarchy of the FTP server is as follows:

Example:

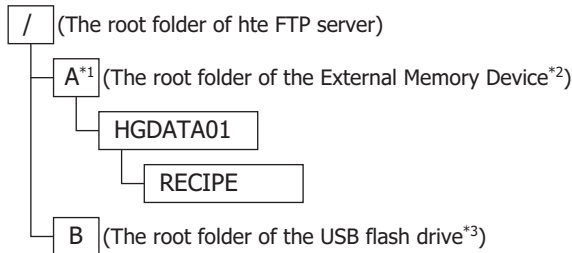

When no external memory device is inserted in the MICRO/I or when no folder is specified to Target, the root folder of the FTP server is displayed.

2.4 Supported Commands and Transfer modes

- Commands defined by RFC959
- Active mode and Passive mode



SFTP and FTPS are not supported.

2.5 Verified FTP Client

With the FTP server function, the operation has been checked by using the following FTP client.*4

- FFFTP
- FileZilla
- Core FTP Lite
- MICRO/I (FTP client function)
- IDEC PLC (FTP client function)



To use FileZilla, select the **Limit number of simultaneous connections** check box on **Transfer Settings** tab in **Site Manager** and set **Maximum number of connections** to "1" in advance.



- For the settings and how to use the FTP client software, please check the help and manual of each software.
- Depending on the FTP client software, including subfolders may not be able to write in batch. In this case, please write data each one level.

*1 HG2J-7U, HG5G/4G/3G/2G-V, HG4G/3G, HG2G-5F only

*2 USB flash drive inserted in USB1 for HG2J-7U, SD memory card for HG5G/4G/3G/2G-V, HG4G/3G and HG2G-5F

*3 USB flash drive inserted in USB2 for HG2J-7U

*4 HG2J-7U as of December 2021, HG5G/4G/3G/2G-V, HG4G/3G, HG2G-5F/-5T, HG1G/1P type as of January 2019

2.6 Settings and Connection Method

Follow the procedure below to access the external memory device inserted in the MICRO/I from the FTP client. Here describes an example where a web browser is used as a FTP client software.

1 Connect the MICRO/I to a local network.

Connect the MICRO/I's Ethernet interface to the Ethernet port of the local network's router or hub with a LAN cable.

2 Configure the MICRO/I.

- Ethernet settings

 Refer to Chapter 4 "When Ethernet is selected under Interface Configuration" on page 4-41.

- User account settings

 Refer to Chapter 23 "3 Security Dialog Box" on page 23-37.



An "Administrator" or "Operator" user account is required to login the MICRO/I.

- FTP server settings

 Refer to "FTP Server Function Configuration Procedure" on page 28-19.

3 Login to the MICRO/I.

Start the web browser and go to the following URL. After the user name and password are successfully verified, the folder of external memory device inserted in the MICRO/I is displayed.

`ftp://(User Name):(Password)@(MICRO/I IP address)/`

Example 1: The MICRO/I's IP address is 192.168.0.1, the User Name is User1 and the Password is 1234.

`ftp://User1:1234@192.168.0.1/`

Example 2: The MICRO/I's IP address is 192.168.0.1, the User Name is User2 and the Password is not set.

`ftp://User2@192.168.0.1/`



- Connection from anonymous user is not accepted.
- The MICRO/I can be accessed simultaneously from one FTP client only.
- For the available file paths and file names, follow the specification of the external memory device. For details, refer to Chapter 31 "1.3 Specifications of External Memory Devices" on page 31-2.

4 Read or write the file.

● FTP Server Function Configuration Procedure

1 On the **Configuration** tab, in the **System Setup** group, click **Project**.

The Project Settings dialog box is displayed.

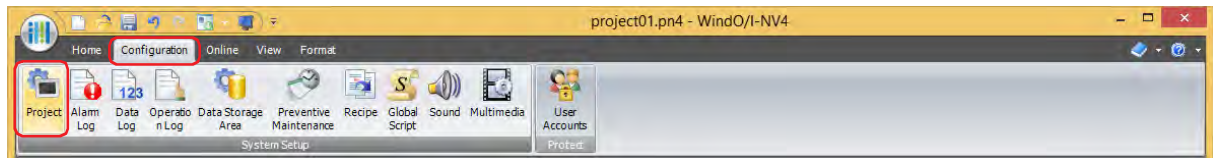

2 Configure the items on the **FTP Server** tab.

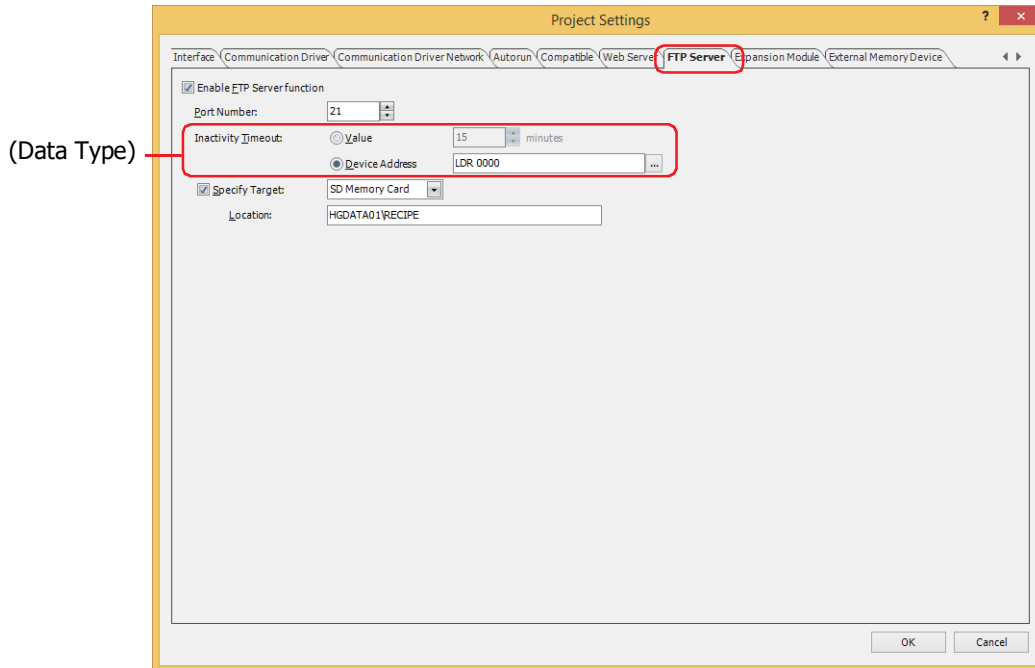

■ Enable FTP Server function

When the **Enable FTP Server function** check box is not selected, you cannot access the folder of the external memory device inserted in the MICRO/I even when the connection from the FTP client to the IP address of the MICRO/I has been established. (Default: Off)

■ Port Number

Specifies the port number to use for the FTP server function (0 to 65535). (Default: 21)

■ Connection Timeout

Set the timeout period. After you login MICRO/I, MICRO/I will keep monitoring for its traffic. If there is no traffic at all for a specified period of time, the MICRO/I will disconnect the FTP client. (Default: 15 minutes)



- The timeout period to login the MICRO/I is 1 minute.
- If **Device Address** is selected for (Data Type), note the following points:
 - When the value of device address is 0, the Connection Timeout is 1 minute, and when the value of device address is 61 or more, the Connection Timeout is regarded as 60 minutes.
 - Once a network connection is established between the FTP client and the MICRO/I, the timeout period cannot be changed. The timeout period needs to be set in Device Address before connecting the FTP client to the MICRO/I.

■ Specify Target

Specify the folder and the external memory device inserted in the MICRO/I to be accessed from the FTP client. When the Target is specified, you cannot access the level higher than the specified folder.

3 Click the **OK** button.



When you access a file during its reading or writing operation, the reading or writing operation for the file accessed is performed after the first processing is completed.

3 FTP Client Function

HG2J-7U HG5G-V HG4G-V HG4G HG3G-V HG3G HG2G-V HG2G-5F HG2G-5T HG1G HG1P

3.1 What Can Be Done with the FTP Client Function

The FTP client function enables copy or move files between FTP servers with external memory device inserted in MICRO/I (FTP client). The host name of the FTP server can also be specified.

When MICRO/I operates as the FTP client, the followings are enabled.

- Copying or moving files from the external memory device inserted in the MICRO/I to the FTP server
- Copying files from the FTP server to the external memory device inserted in the MICRO/I

3.2 System Composition

An example system configuration for using the FTP client function is shown below.

Configure the MICRO/I Ethernet settings (IP address, subnet mask, default gateway) and connect to a local network.

Configures the target FTP server to the MICRO/I.

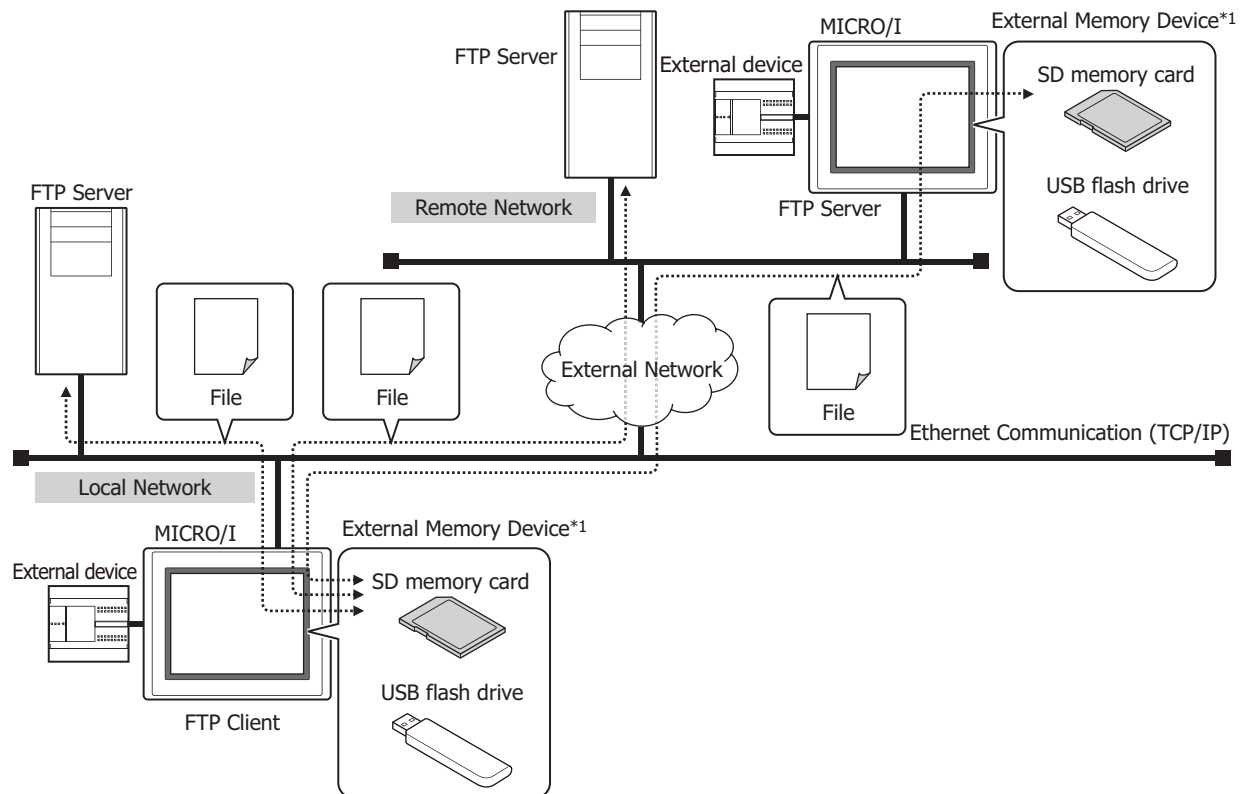

When the trigger condition for the FTP client function (File Transfer Settings) is satisfied, the following process is executed.

- Copying or moving files from the external memory device inserted in the MICRO/I to the FTP server
- Copying files from the FTP server to the external memory device inserted in the MICRO/I



For gateway, router, and other settings, contact the administrator of the network which the MICRO/I is connected to.

*1 Only USB flash drive for HG2J-7U, HG2G-5T and HG1G/1P

3.3 Supported Commands and Transfer modes

- Commands defined by RFC959
- Active mode and Passive mode



SFTP and FTPS are not supported.

3.4 Verified FTP Server

With the FTP client function, the operation has been checked by using the following FTP server. *1

- Microsoft Internet Information Services
- FileZilla
- Very Secure FTP Daemon
- MICRO/I (FTP server function)
- IDEC PLC (FTP server function)



To use FileZilla, select the **Limit number of simultaneous connections** check box on **Transfer Settings** tab in **Site Manager** and set **Maximum number of connections** to "1" in advance.

3.5 FTP Client Function Configuration Procedure

This section describes the configuration procedure for the FTP server and the FTP client function.

- **Configure the FTP Server**
Configures the target FTP server.

1 On the **Configuration** tab, in the **Manager** group, click **FTP Server Manager**.

The FTP Server Manager is displayed.

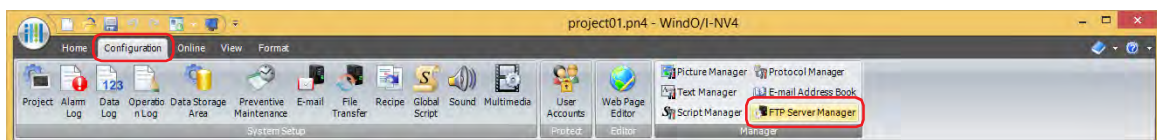

2 Select the number to configure the FTP server in (**FTP Server List**), then click **Edit**.

The Individual Settings dialog box for the selected number is displayed.

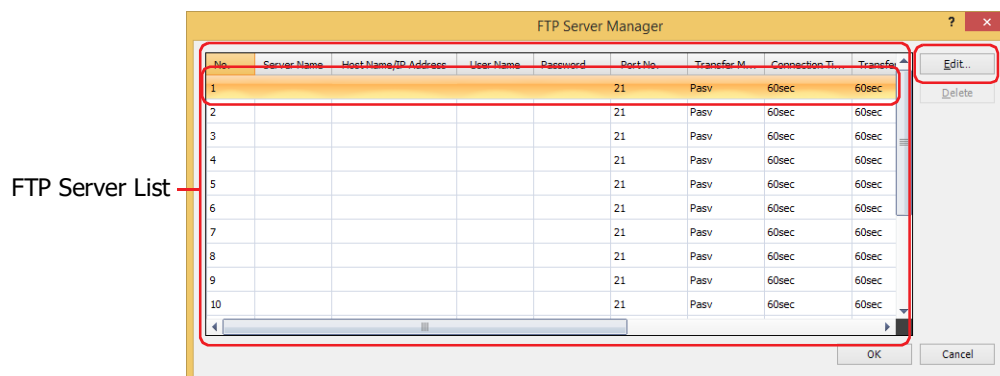

*1 HG2J-7U as of December 2021, HG5G/4G/3G/2G-V, HG4G/3G, HG2G-5F/-5T, HG1G/1P type as of May 2018

3 Configure each items of the FTP server.

■ FTP server settings

- Server Name:** Enter a name of the FTP server. The maximum number is 40 characters. The default is "FTPServer*n*". (*n*: The number in the FTP Server Manager)
- Host Name:** Select this option and enter the host name when specifying the FTP server with a host name. The maximum number is 40 characters. Only alphanumeric characters and symbols can be used.
- IP Address:** Select this option and enter the IP address when specifying the FTP server with an IP address. The format is "xxx.xxx.xxx.xxx". "xxx" stands for a numeric value from 0 to 255.
- User Name:** Enter the name of the user account for the FTP server. The maximum number for the user name is 40 characters. Only alphanumeric characters and symbols can be used.
- Password:** Enter the password for the FTP server. The maximum number for the user name is 40 characters. Only alphanumeric characters and symbols can be used.
- Port Number:** Specifies the port number for the FTP server (0 to 65535).
- Transfer Mode:** Selects the transfer mode of the FTP server.
- Pasv: Uses passive mode for the data connection.
- Active: Uses active mode for the data connection.
- Connection Timeout**^{*1}: Specifies the timeout period (10 to 300 seconds) until the connection to server is automatically aborted. After the **Trigger Condition** in the **File Transfer Settings** is satisfied, if there is no response from the FTP server which is tried to connect, the MICRO/I will automatically cancel to connect.



The **Connection Timeout** for HG2J-7U is 10 seconds.

- Transfer Timeout:** Specifies the timeout period until the process of transferring files is automatically canceled. After the **Trigger Condition** in the **File Transfer Settings** is satisfied and the data connection is available, if there is no response from the FTP server, the MICRO/I will automatically cancel to transfer files.

HG2J-7U: 1 to 60 minutes
HG5G/4G/3G/2G-V, HG4G/3G, HG2G-5F/-5T, HG1G/1P: 10 to 300 seconds

■ Advanced Setting

Specifies the FTP server settings by the values of the device addresses. The settings for the **FTP server settings** can be used as initial values. For details, refer to "Individual Settings Dialog Box" on page 28-28.

- 4 Click **OK** to close the Individual Settings dialog box.
You are returned to the FTP Server Manager.
- 5 Repeat steps 2 through 4 to configure the necessary FTP server.
- 6 Click **OK**.
This concludes the FTP server configuration.

*1 HG5G/4G/3G/2G-V, HG4G/3G, HG2G-5F/-5T, HG1G/1P only

- Configuring the Files to copy or move and the Trigger Condition

- 1 On the **Configuration** tab, in the **System Setup** group, click **File Transfer**.

The File Transfer Settings dialog box is displayed.

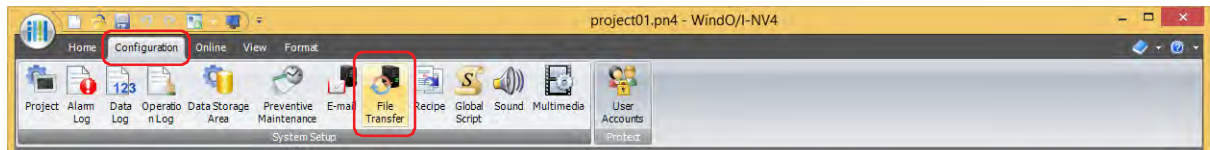

- 2 Select the number to configure the File Transfer Settings in (**Settings**), then click **Edit**.

The Individual Settings dialog box for the selected number is displayed.

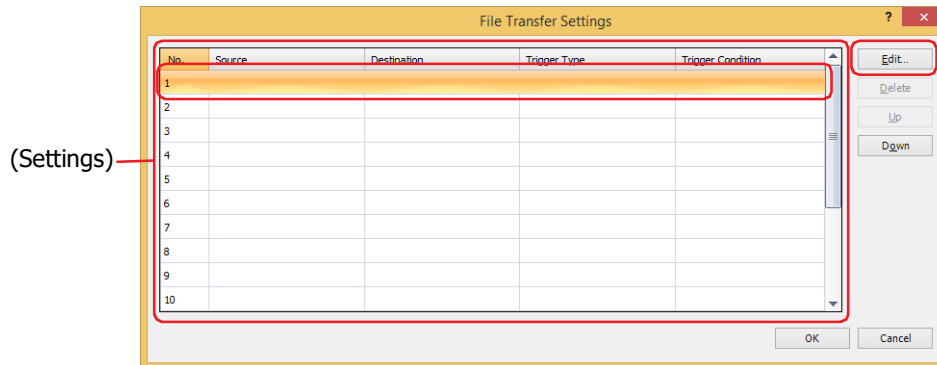

- 3 Configure the items on the **General** tab.

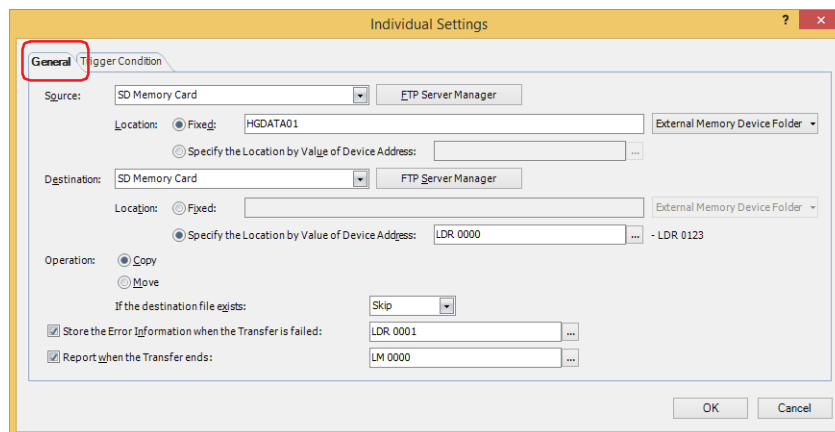

■ **Source**

Select the source external memory device or the FTP server where the files to be copied or moved are stored from the following items.

SD Memory Card^{*1}, **USB Flash Drive**^{*2}, **USB1**^{*3}, **USB2**^{*3}, **(FTP server)**

The **No.**+(period)+**Server Name** of the FTP server specified in the FTP Server Manager is displayed.

Example: **No.** is 1 and **Server Name** is TestServer1
1.TestServer1

Location: Selects the method to specify the save location of source files to copy or move.

Fixed: Specify the save location of the target folder or file path as a string. The maximum number is 247 characters. Only alphanumeric characters and symbols can be used. Path delimiters vary based on the model.

Example: Copy or move files to the "ALARMLOG" folder under "HGDATA01" folder on the external memory device

HG2J-7U: HGDATA01/ALARMLOG

HG5G/4G/3G/2G-V, HG4G/3G, HG2G-5F/-5T, HG1G/1P: HGDATA01\ALARMLOG

Click on the **External Memory Device Folder** button or click on ▼ to the right on it, and then select the item on the list.

Specify the Location by Value of Device Address:

Specifies a word device to specify a folder or file path of the files to copy or move. The path is set by reading the values sequentially from the starting device specified and handling those values as character data up to the character before NULL (0x00). The maximum number of device addresses is 124 (2 characters per word device, maximum of 247 singlebyte characters).

Click  to display the Tag Editor. For the device address configuration procedure, refer to Chapter 2 "5.1 Device Address Settings" on page 2-70.



- Files cannot be copied or moved from the FTP server to the FTP server.
- When transferring files from external memory to external memory and HMI special internal relay LSM67 is 0, subfolders can be copied and moved up to five folders deep. When HMI special internal relay LSM67 is changed from 0 to 1, subfolders cannot be copied or moved.
- Path delimiters and characters in the folder or file path configured by **Fixed** or **Specify the Location by Value of Device Address** that cannot be used vary based on the model.

Model	Delimiter	Characters that cannot be used
HG2J-7U	/	" # \$ & ' () * ; < > ? \ ` ~
HG5G/4G/3G/2G-V, HG4G/3G, HG2G-5F/-5T, HG1G/1P	\	" * ; < > ?

- Folder or File path that exceed the limits in **Specify the Location by Value of Device Address** and folder or file path configured with characters that cannot be used are as follows.
 - When the text of the folder or file path exceeds the maximum number of device addresses (no NULL), the text stored in device addresses up to the maximum number of device addresses from the start is configured.
 - When a character that cannot be used is set, the text is up to that character.
- If the transfer source is a MICRO/I configured as an FTP server, "A + delimiter" or "B + delimiter" must be specified at the beginning of the path for each type of external memory. Path delimiters vary based on the model.

Example 1: If the transfer source is the "ALARMLOG" folder in the "HGDATA01" folder on the USB flash drive inserted in USB2 for HG2J-7U:

B/HGDATA01/ALARMLOG

Example 2: For HG5G-V, if the transfer source is the "ALARMLOG" folder in the "HGDATA01" folder on the SD memory card:

A\HGDATA01\ALARMLOG

*1 HG5G/4G/3G/2G-V, HG4G/3G, HG2G-5F only

*2 HG5G/4G/3G/2G-V, HG4G/3G, HG2G-5F/-5T, HG1G/1P only

*3 HG2J-7U only

■ Destination

Select the target external memory device or the FTP server where the files to be copied or moved are stored from the following items.

SD Memory Card^{*1}, USB Flash Drive^{*2}, USB1^{*3}, USB2^{*3}, (FTP server)

The **No.**+(period)+**Server Name** of the FTP server specified in the FTP Server Manager is displayed.

Example: **No.** is 1 and **Server Name** is TestServer1

1.TestServer1

Location: Selects the method to specify the target save location of files to copy or move.

Fixed: Specify the save location of the target folder path as a string. The maximum number is 247 characters. Only alphanumeric characters and symbols can be used. Path delimiters vary based on the model.

Example: Save the copied or moved files to the "ALARMLOG" folder under "HGDATA01" folder on the external memory device

HG2J-7U: HGDATA01/ALARMLOG

HG5G/4G/3G/2G-V, HG4G/3G, HG2G-5F/-5T, HG1G/1P: HGDATA01\ALARMLOG

Click on the **External Memory Device Folder** button or click on ▼ to the right on it, and then select the item on the list.

Specify the Location by Value of Device Address:

Specifies a word device to specify a folder path of the copied or moved files. The path is set by reading the values sequentially from the starting device specified and handling those values as character data up to the character before NULL (0x00). The maximum number of device addresses is 124 (2 characters per word device, maximum of 247 singlebyte characters). Click

⋮ to display the Tag Editor. For the device address configuration procedure, refer to Chapter 2 "5.1 Device Address Settings" on page 2-70.



- Files cannot be copied or moved from the FTP server to the FTP server.
- When transferring files from external memory to external memory and HMI special internal relay LSM67 is 0, subfolders can be copied and moved up to five folders deep. When HMI special internal relay LSM67 is changed from 0 to 1, subfolders cannot be copied or moved.
- Path delimiters and characters in the folder path configured by **Fixed** or **Specify the Location by Value of Device Address** that cannot be used vary based on the model.

Model	Delimiter	Characters that cannot be used
HG2J-7U	/	" # \$ & ' () * : ; < > ? \ ` ~
HG5G/4G/3G/2G-V, HG4G/3G, HG2G-5F/-5T, HG1G/1P	\	" * : ; < > ?

- Folder path that exceed the limits in **Specify the Location by Value of Device Address** and folder or file path configured with characters that cannot be used are as follows.
 - When the text of the folder or file path exceeds the maximum number of device addresses (no NULL), the text stored in device addresses up to the maximum number of device addresses from the start is configured.
 - When a character that cannot be used is set, the text is up to that character.
- If the transfer destination is a MICRO/I configured as an FTP server, "A + delimiter" or "B + delimiter" must be specified at the beginning of the path for each type of external memory. Path delimiters vary based on the model.

Example 1: If the transfer destination is the "ALARMLOG" folder in the "HGDATA01" folder on the USB flash drive inserted in USB2 for HG2J-7U:

B/HGDATA01/ALARMLOG

Example 2: For HG5G-V, if the transfer destination is the "ALARMLOG" folder in the "HGDATA01" folder on the SD memory card:

A\HGDATA01\ALARMLOG

■ Operation

Selects **Copy** or **Move** for the procedure to transfer the files. Can only be set **Copy** when **Source** is set to (**FTP server**).

If the destination file exists: Selects **Skip** or **Overwrite** for the processing method when there is the same file name in the destination.

*1 HG5G/4G/3G/2G-V, HG4G/3G, HG2G-5F only

*2 HG5G/4G/3G/2G-V, HG4G/3G, HG2G-5F/-5T, HG1G/1P only

*3 HG2J-7U only

- **Store the Error Information when the Transfer is failed**

Select this check box to store the error information in device addresses when an error occurs during file copying or moving and specifies the word device to write the error information to.

Click to display the Tag Editor. For the device address configuration procedure, refer to Chapter 2 "5.1 Device Address Settings" on page 2-70.

- **Report when the Transfer ends**

Select this check box to report when files have been copied or moved and specifies the destination bit device or the bit number in the destination word device.

Click to display the Tag Editor. For the device address configuration procedure, refer to Chapter 2 "5.1 Device Address Settings" on page 2-70.

4 Configures the trigger condition on the **Trigger Condition** tab.

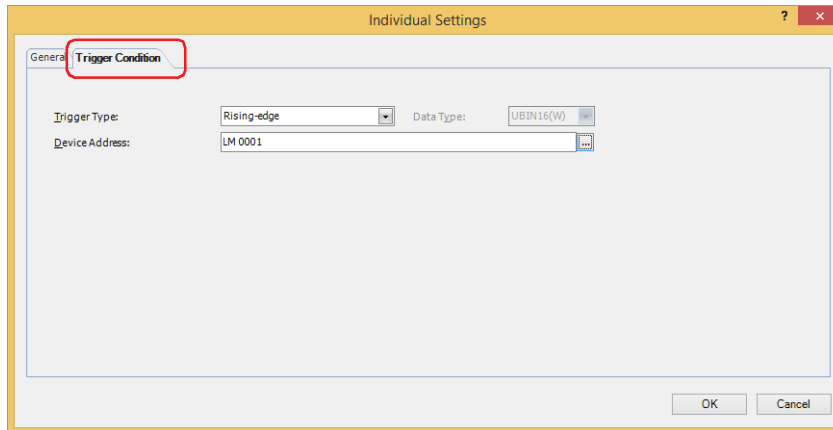

- **Trigger Type**

Selects the condition to copy or move the files from the following.

Rising-edge: Copy or move the files when a value of device address changes from 0 to 1.

Falling-edge: Copy or move the files when a value of device address changes from 1 to 0.

Satisfy the condition: Copy or move the files when condition changes from not satisfied to satisfied.

- **Data Type**

Select the data type handled by the conditional expression.

Can only be set if **While satisfying the condition** is selected as **Trigger Type**. For details, refer to Chapter 2 "1.1 Available Data" on page 2-1.

- **Device Address**

Specifies the bit device or the bit number of the word device to serve as condition.

Can only be set if **While ON** or **While OFF** is selected as **Trigger Type**. Click to display the Tag Editor. For the device address configuration procedure, refer to Chapter 2 "5.1 Device Address Settings" on page 2-70.

- **Condition**

Sets the condition formula.

Can only be set if **While satisfying the condition** is selected as **Trigger Type**. Click to display the Trigger Condition Settings dialog box. For the conditional expressions configuration procedure, refer to Chapter 2 "5.2 Setting Conditional Expressions" on page 2-73.

5 Click **OK** to close the Individual Settings dialog box.

You are returned to the File Transfer Settings dialog box.

6 Repeat steps 2 through 5 to configure the necessary File Transfer settings.

7 Click **OK**.

This concludes configuring the files to copy or move and the trigger condition.

3.6 FTP Server Manager

This section describes items and buttons on the FTP Server Manager.

● FTP Server Manager

The FTP server settings are collectively managed in FTP Server Manager.

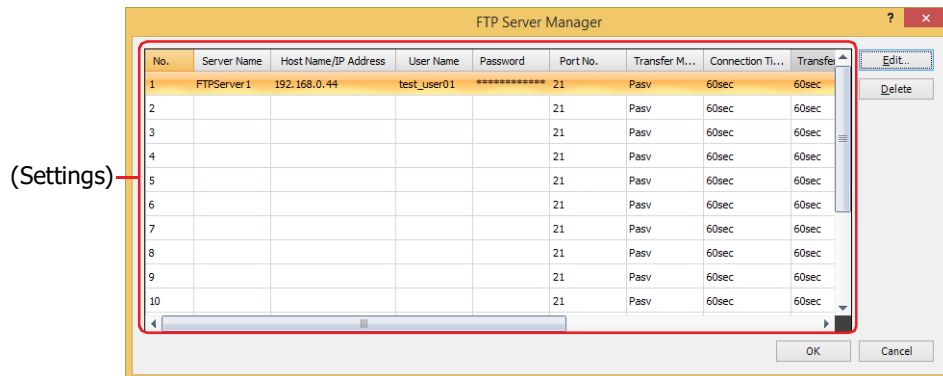

■ (Settings)

Displays a list of the FTP server settings for each number. Double clicking the cell displays the Individual Settings dialog box where you can edit the settings. For details, refer to "Individual Settings Dialog Box" on page 28-28.

No.: Displays the number (1 to 16) for managing the FTP server settings.

Server Name: Displays the name of the FTP server.

Host Name/IP Address: Displays the Host Name or IP address of the FTP server.

User Name: Displays the user name of the FTP server.

Password: Displays the password of the FTP server with * (asterisks).

Port Number: Displays the port number of the FTP server.

Transfer Mode: Displays the transfer mode of the FTP server.

Connection Timeout^{*1}: Displays the timeout period until the connection to server is automatically aborted. After the **Trigger Condition** in the **File Transfer Settings** is satisfied, if there is no response from the FTP server which is tried to connect, the MICRO/I will automatically cancel to connect.



The **Connection Timeout** for HG2J-7U is 10 seconds.

Transfer Timeout: Displays the timeout period until the process of transferring files is automatically canceled. After the Trigger Condition in the **File Transfer Settings** is satisfied and the data connection is available, if there is no response from the FTP server, the MICRO/I will automatically cancel to transfer files.

Top Device Address: Displays the top device address when the settings of FTP servers are specified with the value of the device address.

Copy the settings as default value to Device Address:

Displays the bit device or the bit number of the word device that triggers the copy of the settings for FTP servers to device addresses as default.

■ Edit

Registers or changes the settings for the selected number.

Select a number from the **(Settings)** and click this button to display the Individual Settings dialog box. The configured content for the selected number is reflected in the Individual Settings dialog box.

For details, refer to "Individual Settings Dialog Box" on page 28-28.

■ Delete

Deletes the settings for the selected number from the **(Settings)**.

■ Select^{*2}

Returned to the File Transfer Settings dialog box, and then configures the selected FTP server from the **(Settings)**

*1 HG5G/4G/3G/2G-V, HG4G/3G, HG2G-5F/-5T, HG1G/1P only

*2 Select is only displayed when this dialog box is opened from File Transfer Settings dialog box

● Individual Settings Dialog Box

Use the Individual Settings dialog box to register or edit the FTP server settings for the selected number.

■ FTP Server Settings

- Server Name:** Enter a name of the FTP server. The maximum number is 40 characters. The default is "FTPServer*n*". (*n*: The number in the FTP Server Manager)
- Host Name:** Select this option and enter the host name when specifying the FTP server with a host name. The maximum number is 40 characters. Only alphanumeric characters and symbols can be used.
- IP Address:** Select this option and enter the IP address when specifying the FTP server with an IP address. The format is "xxx.xxx.xxx.xxx". "xxx" stands for a numeric value from 0 to 255.



If Host Name is selected, the IP address of the FTP server is looked up and obtained from the host name using the DNS server. In order to access a DNS server from the MICRO/I, the IP address of the DNS server must be specified. For details, refer to "When Ethernet is selected under Interface Configuration" on page 4-41.

- User Name:** Enter the name of the user account for the FTP server. The maximum number for the user name is 40 characters. Only alphanumeric characters and symbols can be used.
- Password:** Enter the password for the FTP server. The maximum number for the user name is 40 characters. Only alphanumeric characters and symbols can be used.
- Port Number:** Specifies the port number for the FTP server (0 to 65535).
- Transfer Mode:** Selects the transfer mode of the FTP server.
 Pasv: Uses passive mode for the data connection.
 Active: Uses active mode for the data connection.
- Connection Timeout^{*1}:** Specifies the timeout period (10 to 300 seconds) until the connection to server is automatically aborted. After the **Trigger Condition** in the **File Transfer Settings** is satisfied, if there is no response from the FTP server which is tried to connect, the MICRO/I will automatically cancel to connect.



The **Connection Timeout** for HG2J-7U is 10 seconds.

- Transfer Timeout:** Specifies the timeout period until the process of transferring files is automatically canceled. After the **Trigger Condition** in the **File Transfer Settings** is satisfied and the data connection is available, if there is no response from the FTP server, the MICRO/I will automatically cancel to transfer files.
- HG2J-7U: 1 to 60 minutes
 HG5G/4G/3G/2G-V, HG4G/3G, HG2G-5F/-5T, HG1G/1P: 10 to 300 seconds

*1 HG5G/4G/3G/2G-V, HG4G/3G, HG2G-5F/-5T, HG1G/1P only

■ Advanced Setting

Specify FTP Server Settings by Value of Device Address: Select this check box to set the **FTP Server Settings** using the value of the specified device address.

Top Device Address: Specify the word device to use. It allocates the settings of the **FTP Server Settings** starting at the configured device address. You can only specify an internal device.

Click  to display the Tag Editor. For the device address configuration procedure, refer to Chapter 2 "5.1 Device Address Settings" on page 2-70.

Copy the settings as default value to Device Address: Select this check box to copy the settings in the **FTP Server Settings** to device addresses as default.

(Device Address): Specifies the bit device or the bit number of the word device that triggers the copy of the settings.

When the value of device address changes from 0 to 1, the values configured in the **FTP Server Settings** are written, beginning from the device address set by the **Top Device Address**.

Click  to display the Tag Editor. For the device address configuration procedure, refer to Chapter 2 "5.1 Device Address Settings" on page 2-70.

Allocation of Address Number when the FTP Server Settings are specified by Value of Device Address

When the **Specify FTP Server Settings by Value of Device Address** check box is selected, it allocates the settings of the **FTP Server Settings** starting at the device address set in the **Top Device Address**. The details are shown below.

Settings	Address Number	Words	Data Format
FTP Server	+0 to +20	21 ^{*1,*2}	Host Name is selected: String IP Address is selected: Decimal
User Name	+21 to +41	21 ^{*2,*3}	String
Password	+42 to +62	21 ^{*2,*3}	String
Port Number	+63	1	Decimal
Transfer Mode	+64	1	Decimal
Connection Timeout (second units)	+65	1	Decimal
Transfer Timeout (second units)	+66	1	Decimal



String data is stored in the upper byte and lower byte according to the **Storage Method of String Data** setting. For details, refer to Chapter 4 "Storage Method of String Data" on page 4-29.

*1 When IP address is selected, use only four words from the beginning, and the remaining seventeen words are left as a reserved area.

*2 The twenty-first word is recognized as a NULL terminating character (0x00) regardless of the value of device address.

*3 Add a NULL terminating character (0x00) as the end of the string data when the string length is less than twenty words.

Example: The **FTP Server Settings** are set as follows:

Settings	Preset Value
Outgoing FTP Server, IP Address is selected.	192.168.0.44
User Name	test_user001
Password	test password
Port Number	587
Transfer Mode (0: Pasv, 1: Active)	Pasv
Connection Timeout	30
Transfer Timeout	60
Top Device Address	LKR 100
Storage Method of String Data	from Upper byte

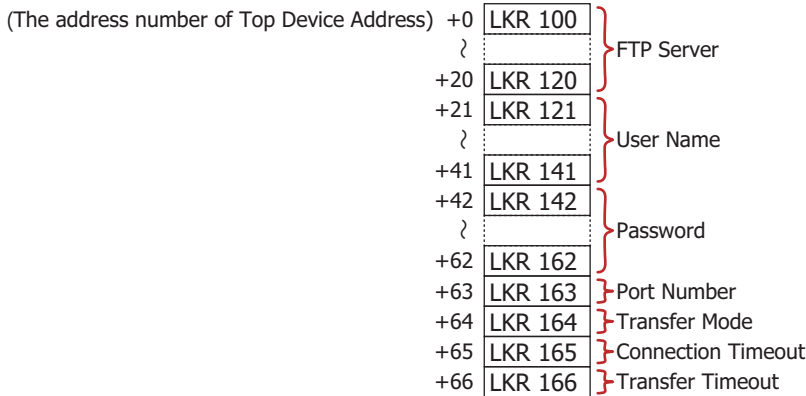

The value of each device address is listed below.

Settings	Preset Value									
	Device Address	LKR 100	LKR 101	LKR 102	LKR 103	LKR 104 to LKR 120				
FTP Server	Value (Decimal)	192	168	0	44	Reserved				
	Device Address	LKR 122	LKR 123	LKR 124	LKR 125	LKR 126	LKR 127	LKR 128	LKR 129 to LKR 141	
User Name	String (ASCII)	't^e'	's^t'	'_^u'	's^e'	'r^0'	'0^1'	'¥0^¥0'	'\0^\0'	
	Value (Hexadecimal)	7465h	7374h	5F75h	7365h	7230h	3031h	0000h	0000h	
Password	Device Address	LKR 142	LKR 143	LKR 144	LKR 145	LKR 146	LKR 147	LKR 148	LKR 149 to LKR162	
	String (ASCII)	't^e'	's^t'	'_^p'	'a^s'	's^w'	'o^r'	'd^l0'	'\0^\0'	
Port Number	Value (Hexadecimal)	7465h	7374h	5F70h	6173h	7377h	6F72h	6400h	0000h	
	Device Address	LKR 163								
Transfer Mode	Value (Decimal)	587								
	Device Address	LKR 164								
Connection Timeout	Value (Decimal)	0								
	Device Address	LKR 165								
Transfer Timeout	Value (Decimal)	30								
	Device Address	LKR 166								
Transfer Timeout	Value (Decimal)	60								

3.7 File Transfer Settings Dialog Box

This section describes the items and buttons on the File Transfer Settings dialog box.

● File Transfer Settings Dialog Box

Use the File Transfer Settings dialog box to collectively manage the trigger condition for copying or moving files between the FTP server and an external memory device inserted in the MICRO/I.

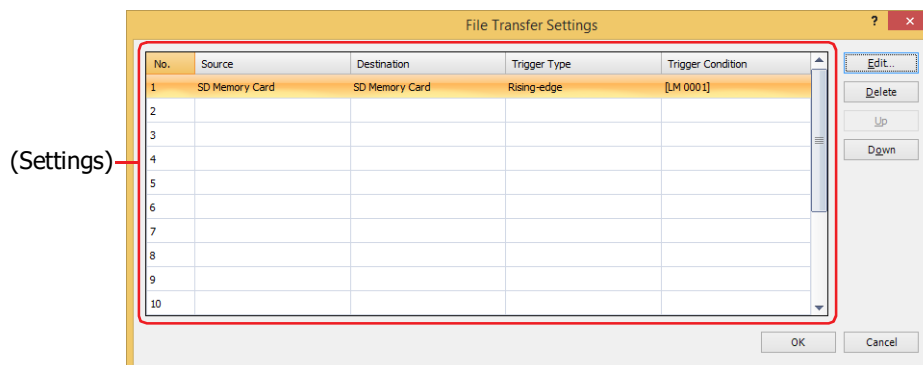

■ (Settings)

Displays a list of the settings of the File Transfer function. Double clicking the cell displays the Individual Settings dialog box where you can edit the settings. For details, refer to "Individual Settings Dialog Box" on page 28-32.

No.: Displays the number for managing File Transfer Settings.

Source: Displays the source external memory device or the FTP server where the files to be copied or moved are stored.

Destination: Displays the target external memory device or the FTP server where the files to be copied or moved are stored.

Trigger Type: Displays the trigger type for copying or moving files.

Trigger Condition: Displays the trigger condition of trigger type for copying or moving files. The displayed content varies based on **Trigger Type**.

Rising-edge, Falling-edge: Displays the bit device or the bit number of the word device to serve as condition.

Satisfy the condition: Displays the conditional expression.

■ Edit

Registers or changes the settings for the selected number.

Select a number from the **(Settings)** and click this button to display the Individual Settings dialog box. The configured content for the selected number is reflected in the Individual Settings dialog box.

For details, refer to "Individual Settings Dialog Box" on page 28-32.

■ Delete

Deletes the settings for the selected number from the (Settings).

■ Up

Shifts the selected settings upward in the list.

■ Down

Shifts the selected settings downward in the list.

● Individual Settings Dialog Box

Registers or changes the settings for the selected number.

General Tab

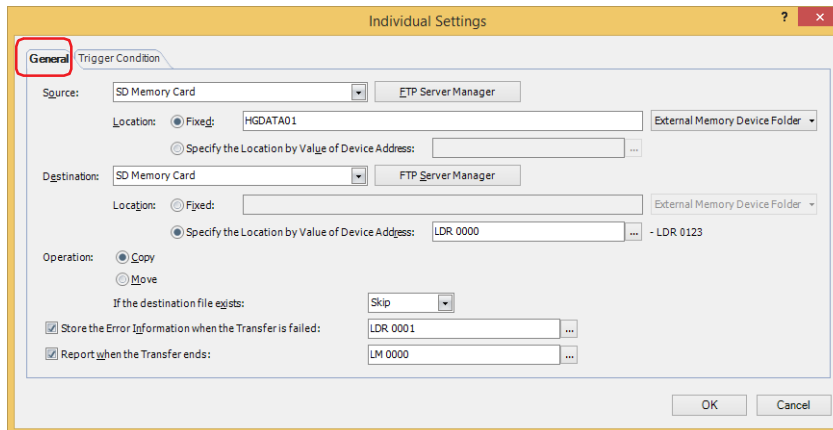

■ Source

Select the source external memory device or the FTP server where the files to be copied or moved are stored from the following items.

SD Memory Card^{*1}, USB Flash Drive^{*2}, USB1^{*3}, USB2^{*3}, (FTP server)

The **No.+(period)+Server Name** of the FTP server specified in the FTP Server Manager is displayed.

Example: **No.** is 1 and **Server Name** is TestServer1

1.TestServer1

FTP Server Manager: The settings of FTP server can be added or changed. Click this button to display the FTP Server Manager. For details, refer to "FTP Server Manager" on page 28-27.

Location: Selects the method to specify the save location of source files to copy or move.

Fixed: Specify the save location of the target folder or file path as a string. The maximum number is 247 characters. Only alphanumeric characters and symbols can be used. Path delimiters vary based on the model.

Example: Copy or move files to the "ALARMLOG" folder under "HGDATA01" folder on the external memory device

HG2J-7U: HGDATA01/ALARMLOG

HG5G/4G/3G/2G-V, HG4G/3G, HG2G-5F/-5T, HG1G/1P: HGDATA01\ALARMLOG

External Memory Device Folder: Click this button to enter the configured content of the **External Memory Device Folder** in the **External Memory Device** tab on the Project Settings dialog box.

Click on ▼ to the right on the **External Memory Device Folder** button, and then select the item on the list to enter the subfolder.

*1 HG5G/4G/3G/2G-V, HG4G/3G, HG2G-5F only

*2 HG5G/4G/3G/2G-V, HG4G/3G, HG2G-5F/-5T, HG1G/1P only

*3 HG2J-7U only

Example: For HG5G-V, the **External Memory Device Folder** in the **External Memory Device tab** on the Project Settings dialog box is "HGDATA01"

Selection	Entered Text
Alarm Log Files	HGDATA01\ALARMLOG
Data Log Files	HGDATA01\DATALOG
Operation Log Files	HGDATA01\OPERATIONLOG
Screenshots	HGDATA01\CAPTURE
Recipe Files	HGDATA01\RECIPE
Picture Files used by MICRO/I	HGDATA01\PICTURE
Sound Files used by MICRO/I	HGDATA01\SOUND
ZNV Project Files	HGDATA01\NVDATA
ZLD Project Files	HGDATA01\LDRDATA
Movie Files	HGDATA01\MOVIE
Recorded Movie Files	HGDATA01\RECORD

Specify the Location by Value of Device Address:

Specifies a word device to specify a folder or file path of the files to copy or move. The path is set by reading the values sequentially from the starting device specified and handling those values as character data up to the character before NULL (0x00). The maximum number of device addresses is 124 (2 characters per word device, maximum of 247 singlebyte characters). Click  to display the Tag Editor. For the device address configuration procedure, refer to Chapter 2 "5.1 Device Address Settings" on page 2-70.



- Files cannot be copied or moved from the FTP server to the FTP server.
- When transferring files from external memory to external memory and HMI special internal relay LSM67 is 0, subfolders can be copied and moved up to five folders deep. When HMI special internal relay LSM67 is changed from 0 to 1, subfolders cannot be copied or moved.
- Path delimiters and characters in the folder or file path configured by **Fixed** or **Specify the Location by Value of Device Address** that cannot be used vary based on the model.

Model	Delimiter	Characters that cannot be used
HG2J-7U	/	" # \$ & ' () * : ; < > ? \ ` ~
HG5G/4G/3G/2G-V, HG4G/3G, HG2G-5F/-5T, HG1G/1P	\	" * : ; < > ?

- Folder or File path that exceed the limits in **Specify the Location by Value of Device Address** and folder or file path configured with characters that cannot be used are as follows.
 - When the text of the folder or file path exceeds the maximum number of device addresses (no NULL), the text stored in device addresses up to the maximum number of device addresses from the start is configured.
 - When a character that cannot be used is set, the text is up to that character.
- If the transfer source is a MICRO/I configured as an FTP server, "A + delimiter" or "B + delimiter" must be specified at the beginning of the path for each type of external memory. Path delimiters vary based on the model.
 - Example 1: If the transfer source is the "ALARMLOG" folder in the "HGDATA01" folder on the USB flash drive inserted in USB2 for HG2J-7U:
B/HGDATA01/ALARMLOG
 - Example 2: For HG5G-V, if the transfer source is the "ALARMLOG" folder in the "HGDATA01" folder on the SD memory card:
A\HGDATA01\ALARMLOG

■ Destination

Select the target external memory device or the FTP server where the files to be copied or moved are stored from the following items.

SD Memory Card^{*1}, **USB Flash Drive**^{*2}, **USB1**^{*3}, **USB2**^{*3}, **(FTP server)**

The **No.**+(period)+**Server Name** of the FTP server specified in the FTP Server Manager is displayed.

Example: **No.** is 1 and **Server Name** is TestServer1
1.TestServer1

FTP Server Manager: The settings of FTP server can be added or changed. Click this button to display the FTP Server Manager. For details, refer to "FTP Server Manager" on page 28-27.

Location: Selects the method to specify the target save location of files to copy or move.

Fixed: Specify the save location of the target folder path as a string. The maximum number is 247 characters. Only alphanumeric characters and symbols can be used. Path delimiters vary based on the model.

Example: Save the copied or moved files to the "ALARMLOG" folder under "20170123" folder on the FTP server

HG2J-7U: 20170123/ALARMLOG

HG5G/4G/3G/2G-V, HG4G/3G, HG2G-5F/-5T, HG1G/1P: 20170123\ALARMLOG

External Memory Device Folder: Click this button to enter the configured content of the **External Memory Device Folder** in the **External Memory Device** tab on the Project Settings dialog box.

Click on ▼ to the right on the **External Memory Device Folder** button, and then select the item on the list to enter the subfolder.

Example: For HG5G-V, the **External Memory Device Folder** in the **External Memory Device** tab on the Project Settings dialog box is "HGDATA01"

Selection	Entered Text
Alarm Log Files	HGDATA01\ALARMLOG
Data Log Files	HGDATA01\DATALOG
Operation Log Files	HGDATA01\OPERATIONLOG
Screenshots	HGDATA01\CAPTURE
Recipe Files	HGDATA01\RECIPE
Picture Files used by MICRO/I	HGDATA01\PICTURE
Sound Files used by MICRO/I	HGDATA01\SOUND
ZNV Project Files	HGDATA01\INVDATA
ZLD Project Files	HGDATA01\LDRDATA
Movie Files	HGDATA01\MOVIE
Recorded Movie Files	HGDATA01\RECORD

Specify the Location by Value of Device Address:

Specifies a word device to specify a folder path of the copied or moved files. The path is set by reading the values sequentially from the starting device specified and handling those values as character data up to the character before NULL (0x00). The maximum number of device addresses is 124 (2 characters per word device, maximum of 247 singlebyte characters). Click to display the Tag Editor. For the device address configuration procedure, refer to Chapter 2 "5.1 Device Address Settings" on page 2-70.

*1 HG5G/4G/3G/2G-V, HG4G/3G, HG2G-5F only

*2 HG5G/4G/3G/2G-V, HG4G/3G, HG2G-5F/-5T, HG1G/1P only

*3 HG2J-7U only



- Files cannot be copied or moved from the FTP server to the FTP server.
- When transferring files from external memory to external memory and HMI special internal relay LSM67 is 0, subfolders can be copied and moved up to five folders deep. When HMI special internal relay LSM67 is changed from 0 to 1, subfolders cannot be copied or moved.
- Path delimiters and characters in the folder path configured by **Fixed** or **Specify the Location by Value of Device Address** that cannot be used vary based on the model.

Model	Delimiter	Characters that cannot be used
HG2J-7U	/	" # \$ & ' () * : ; < > ? \ ` ~
HG5G/4G/3G/2G-V, HG4G/3G, HG2G-5F/-5T, HG1G/1P	\	" * : ; < > ?

- Folder path that exceed the limits in **Specify the Location by Value of Device Address** and folder or file path configured with characters that cannot be used are as follows.
 - When the text of the folder or file path exceeds the maximum number of device addresses (no NULL), the text stored in device addresses up to the maximum number of device addresses from the start is configured.
 - When a character that cannot be used is set, the text is up to that character.
- If the transfer destination is a MICRO/I configured as an FTP server, "A + delimiter" or "B + delimiter" must be specified at the beginning of the path for each type of external memory. Path delimiters vary based on the model.
 - Example 1: If the transfer destination is the "ALARMLOG" folder in the "HGDATA01" folder on the USB flash drive inserted in USB2 for HG2J-7U:
B/HGDATA01/ALARMLOG
 - Example 2: For HG5G-V, if the transfer destination is the "ALARMLOG" folder in the "HGDATA01" folder on the SD memory card:
A\HGDATA01\ALARMLOG

■ Operation

Selects **Copy** or **Move** for the procedure to transfer the files. Can only be set **Copy** when **Source** is set to (**FTP server**).

If the destination file exists: Selects **Skip** or **Overwrite** for the processing method when there is the same file name in the destination.

■ Store the Error Information when the Transfer is failed

Select this check box to store the error information in device addresses when an error occurs during file copying or moving and specifies the word device to write the error information to.

Click to display the Tag Editor. For the device address configuration procedure, refer to Chapter 2 "5.1 Device Address Settings" on page 2-70.

0 is written to the device address when the copy or move process starts, 1 is written to the corresponding bit when an error occurs.

Bit number	Function	Cause	Solution
0	External Memory Device Access Error	<ul style="list-style-type: none"> No external memory device specified as the source or the destination is inserted. The external memory device specified as the source or the destination cannot be accessed. 	<ul style="list-style-type: none"> Insert an accessible external memory device. Mount the external memory device.
1	External Memory Device Reading or Writing Error	<ul style="list-style-type: none"> The folders and files in the external memory device specified as the source or the destination cannot be read. Creating folders, writing to files and deleting files in the external memory device specified as the source or the destination cannot be executed. 	<ul style="list-style-type: none"> Insert an external memory device read or write. Insert an external memory device which has sufficient space.
2	FTP Server Connection Error	<ul style="list-style-type: none"> The FTP server specified as the source or the destination cannot be accessed when the interval specified in Connection Timeout elapses. When Host Name is selected with the radio button in the FTP server settings, the Preferred DNS Server or Alternate DNS Server setting is incorrect. The host name of the FTP server could not be resolved. 	<ul style="list-style-type: none"> Connect a LAN cable. Change the network settings configured on the MICRO/I. Change the IP address or the port number of the FTP server. Change the Preferred DNS Server, Alternate DNS Server settings. Change the Host Name of the FTP server.
3	FTP Server Authentication Error	The user name or the password is incorrect.	Change the user name or the password.
4	FTP Server Command Error	An error for the command transmitted to the FTP server was returned.	Contact the administrator of the FTP server.
5	FTP Server Transfer Error	The FTP server does not return a response when the interval specified in Transfer Timeout elapses.	Contact the administrator of the FTP server.
6	FTP Server Force Terminate	The process of the file transfer stopped by using the HMI Special Relay LSM65.	-
7 to 15	Reserved	-	-

■ Report when the Transfer ends

Select this check box to report when files have been copied or moved and specifies the destination bit device or the bit number in the destination word device.

Click to display the Tag Editor. For the device address configuration procedure, refer to Chapter 2 "5.1 Device Address Settings" on page 2-70.

Trigger Condition Tab

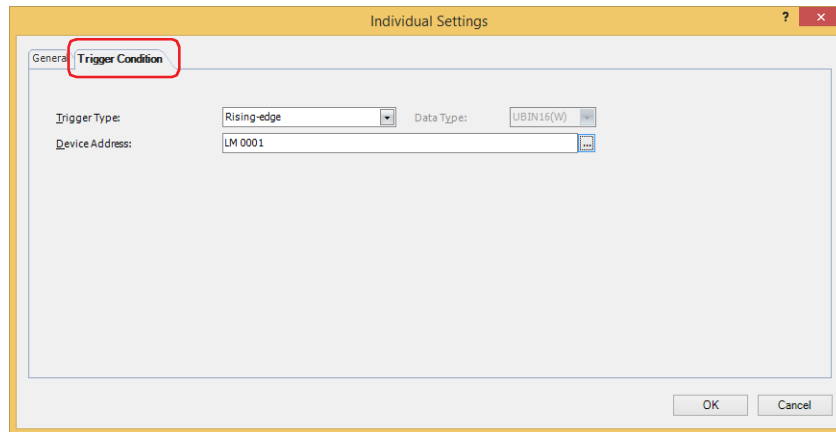

■ Trigger Type

Selects the condition to copy or move the files from the following.

Rising-edge:

Copy or move the files when a value of device address changes from 0 to 1.

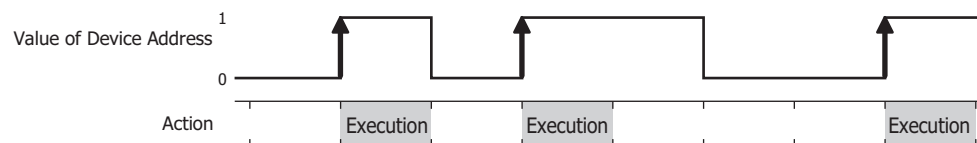

Falling-edge:

Copy or move the files when a value of device address changes from 1 to 0.

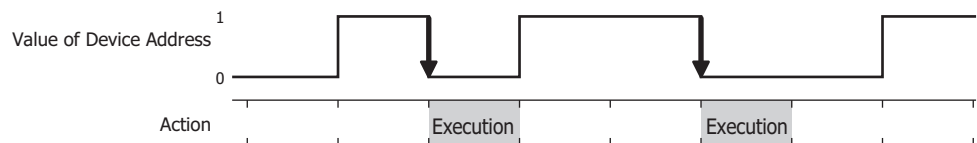

Satisfy the condition: Copy or move the files when condition changes from not satisfied to satisfied.

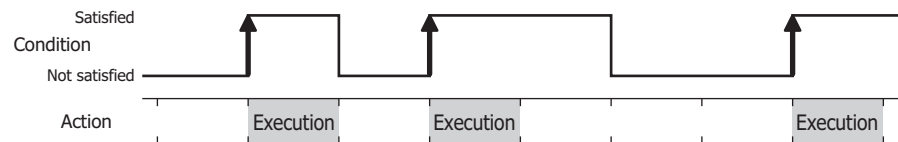

■ Data Type

Select the data type handled by the conditional expression.

Can only be set if **While satisfying the condition** is selected as **Trigger Type**. For details, refer to Chapter 2 "1.1 Available Data" on page 2-1.

■ Device Address

Specifies the bit device or the bit number of the word device to serve as condition. You can only specify the internal device.

Can only be set if **While ON** or **While OFF** is selected as **Trigger Type**. Click to display the Tag Editor. For the device address configuration procedure, refer to Chapter 2 "5.1 Device Address Settings" on page 2-70.

■ Condition

Sets the condition formula.

Can only be set if **While satisfying the condition** is selected as **Trigger Type**. Click to display the Trigger Condition Settings dialog box. For the conditional expressions configuration procedure, refer to Chapter 2 "5.2 Setting Conditional Expressions" on page 2-73.

4 E-mail Function

HG2J-7U HG5G-V HG4G-V HG4G HG3G-V HG3G HG2G-V HG2G-5F HG2G-5T HG1G HG1P

4.1 What Can Be Done with the E-mail Function

The E-mail function enables sending e-mail from the MICRO/I to smartphone, mobile device, computer, etc when a specified trigger condition is satisfied. The host name of the outgoing mail server (SMTP) can also be specified.

4.2 System Composition

An example system configuration for using the E-mail function is shown below.

Configure the MICRO/I Ethernet settings (IP address, subnet mask, default gateway) and connect to a local network. Configure the MICRO/I with the outgoing mail server (SMTP).

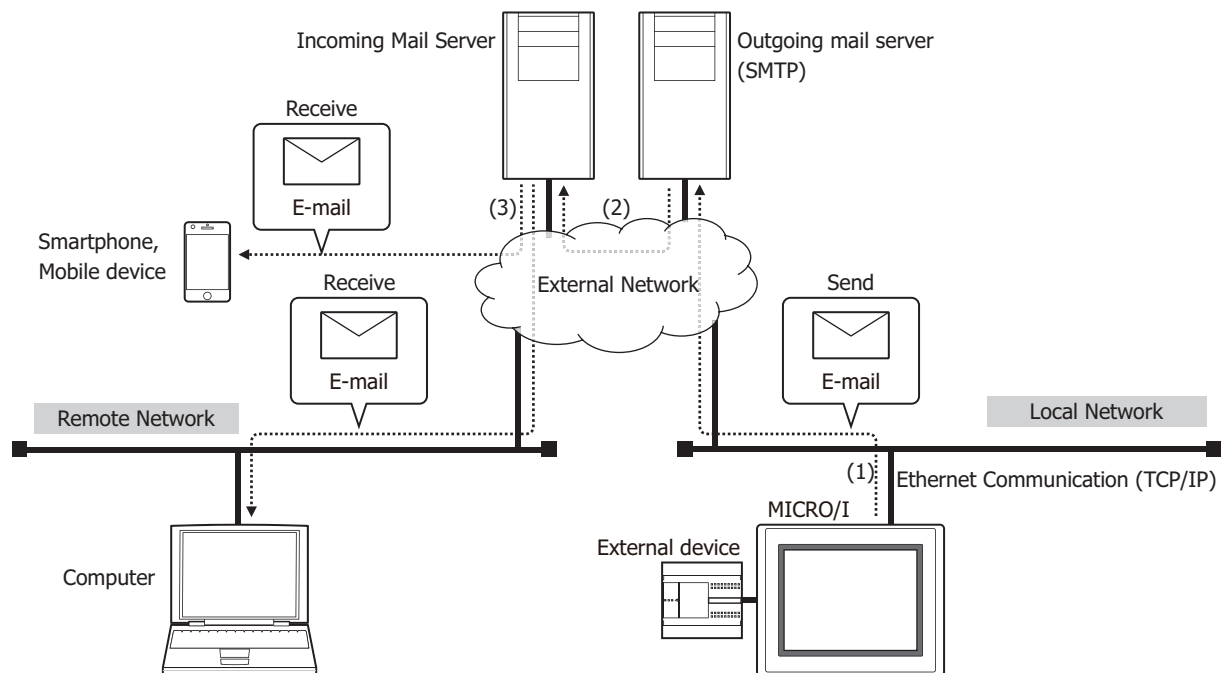

- (1) When the trigger condition for the E-mail function is satisfied, MICRO/I connected to the local network sends the e-mail to the outgoing mail server (SMTP).
- (2) The outgoing mail server (SMTP) sends the e-mail received from MICRO/I to the incoming mail server of the destination address.
- (3) The e-mail is received by a smartphone, mobile device and computer etc.



For the outgoing mail server (SMTP) and the local network settings, contact the administrator of the network which the MICRO/I is connected to.

4.3 Supported Protocols and Authentication methods

- Protocols defined by RFC2821 and RFC2822
- LOGIN for the SMTP Authentication
- SMTPs (SSL communications)

4.4 Verified SMTP Servers

The e-mail function has been verified to work with the following SMTP servers. (As of October 2017)

Mail Server	Host Name
Gmail	smtp.gmail.com
Yahoo mail (USA)	plus.smtp.mail.yahoo.com
Yahoo mail (JAPAN)	smtp.mail.yahoo.co.jp

4.5 E-mail Sending Operation

The e-mail will be sent when a specified trigger condition is satisfied. For details, refer to "Trigger Condition" on page 28-54.

The MICRO/I cannot simultaneously send multiple e-mails. Accordingly, when there are multiple e-mail sending events, such as multiple trigger conditions to send an e-mail are the same or multiple trigger conditions are satisfied at the same time, the e-mails are sent in the order described below.

■ Multiple trigger conditions to send an e-mail are the same or the different trigger conditions are satisfied at the same time

When multiple trigger conditions to send an e-mail are the same or when the different trigger conditions are satisfied at the same time (the values of multiple trigger device addresses change to 1 at the same time), e-mails are sent in the order of smaller number. Triggered e-mails will be in "Waiting" status while sending another e-mail is in progress. For example, if the trigger conditions for e-mail number 1 and e-mail number 2 are the same, once the trigger conditions are satisfied, e-mail number 1 starts to be sent, and e-mail number 2 is in "Waiting" status. After the e-mail number 1 has been sent, the e-mail number 2 starts to be sent.

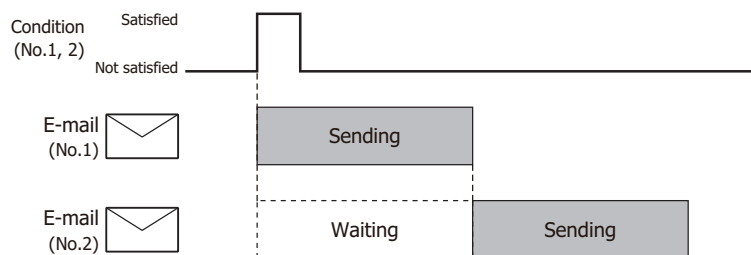

■ When the trigger condition is satisfied during the other e-mail is being sent

When sending an e-mail is in progress and the trigger condition to send another e-mail is satisfied, triggered e-mail will be in "Waiting" status. Such e-mail is sent after all the e-mails in sending or waiting status have been sent. For example, if the trigger condition for the e-mail number 2 is satisfied during the e-mail number 1 is sending, number 2 is in "Waiting" status. After the e-mail number 1 has been sent, the e-mail number 2 starts to be sent.

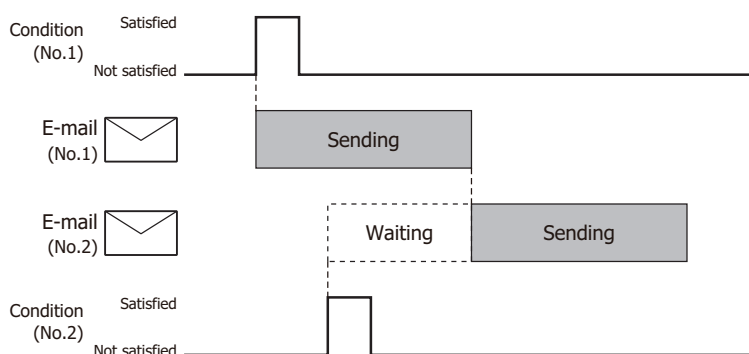

■ When the trigger condition is satisfied again during the e-mail is being sent

While sending an e-mail is in progress or an e-mail is in "Waiting" status, if the trigger condition to send such e-mail is satisfied, such trigger condition is disregarded.

For example, if the trigger condition for the e-mail number 1 is satisfied again during which it is being sent, the e-mail will be not "Waiting" status so the same e-mail is not going to be sent twice.

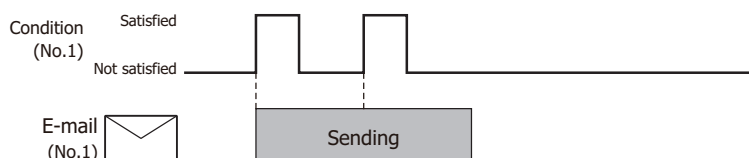

4.6 Operating E-mail function and checking sending status

● Operating E-mail function

Enables to cancel or pause the e-mail sending by the HMI Special Internal Relay.

■ LSM55: Cancelling the e-mail sending

When a value of this bit changes from 0 to 1, the MICRO/I cancels sending of all the e-mails in "Waiting" status. If sending an e-mail is in progress, the send process will be cancelled after such e-mail has been sent.

■ LSM56: Pausing the e-mail sending

While a value of this bit is 1, the MICRO/I pauses sending of all the e-mails in "Waiting" status. If sending an e-mail is in progress, the send process will be paused after such e-mail has been sent.

● Checking the e-mail sending state

You can check the e-mail sending state through the values of the HMI Special Data Register.

■ LSD221: Number of e-mail in "Waiting" status

The number of e-mail that are waiting to be sent is stored.

■ LSD222: Result of e-mail sending

The sending result of the e-mail last sent is stored.

Status	Cause
0: Successfully Completed	-
1: Parameter error	<ul style="list-style-type: none"> • The value of the device address allocated to the following setting is 0 <ul style="list-style-type: none"> - IP address of the Outgoing mail server (SMTP) - Sender E-mail Address - Sender Name - Account Name and Password (When the Required authentication (LOGIN) to send E-mail check box is selected) • The preferred DNS server and alternate DNS server settings remain the default settings.
2: Timeout error	<p>There is no response from the outgoing mail server even after the timeout period (30 seconds) due to the following causes.</p> <ul style="list-style-type: none"> • An Ethernet cable is disconnected. • Host Name of the Outgoing mail server (SMTP) is incorrect. • IP address of the Outgoing mail server (SMTP) is incorrect. • Port number of the Outgoing mail server (SMTP) is incorrect. • A connection cannot be made to the preferred DNS server and alternate DNS server.
3: Authentication error	<ul style="list-style-type: none"> • The authenticating account name is incorrect. • The authenticating account password is incorrect.
4: Other error	The connection is disconnected from the outgoing mail server (SMTP).



After the value of the device address specified in the **Report when E-mail has been sent** on the **E-mail Settings** dialog box changes to 1, the result of the e-mail sending is stored in LSD222.

■ LSD223: E-mail Number which has been sent

The e-mail number which has been sent is stored. Only the latest e-mail number is stored.



Even when an error occurs during sending, the MICRO/I handles the send process is completed and the e-mail number is stored in LSD223.

4.7 Restrictions of each E-mail

■ Number of destination addresses

The total number of To, Cc and Bcc data is 100 maximum.



- When an E-mail Group is set, the number of e-mail addresses in the E-mail Group is counted.
- If the same e-mail address is used in multiple destination, the number of destination addresses will be counted for each destination.

■ Data size *1

Subject: 256 bytes

Body: 4,096 bytes

■ Attachment

The maximum number of attachments is 23 total for Screenshot, Alarm Log files, Data Log files, and Operation Log files.

However, the number of files that can be attached varies based on the file.

Screenshot: 1 max.

Alarm Log file: 1 max.

Data Log file: 20 max.

Operation Log file: 1 max.



- If a period of time or the maximum number of items are not set in the Attach Files dialog box, the entire history data stored in the internal memory will be attached.
- The attachment size limit varies based on the mail server. For details, contact the administrator of the mail server that is used.

*1 Data size before encoding by Base64

4.8 E-mail Function Configuration Procedure

This section describes the configuration procedure for the outgoing mail server (SMTP) and the e-mail.

● Outgoing Mail Server (SMTP) Settings

- 1 On the **Configuration** tab, in the **System Setup** group, click **Project**.

The Project Settings dialog box is displayed.

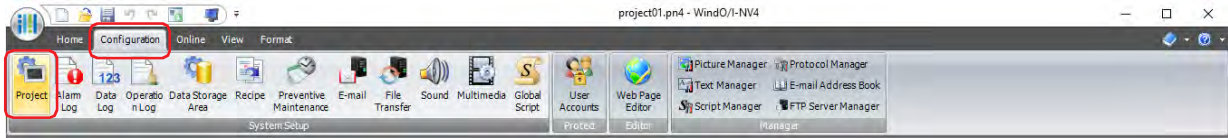

- 2 Configure the items on the **E-mail** tab.

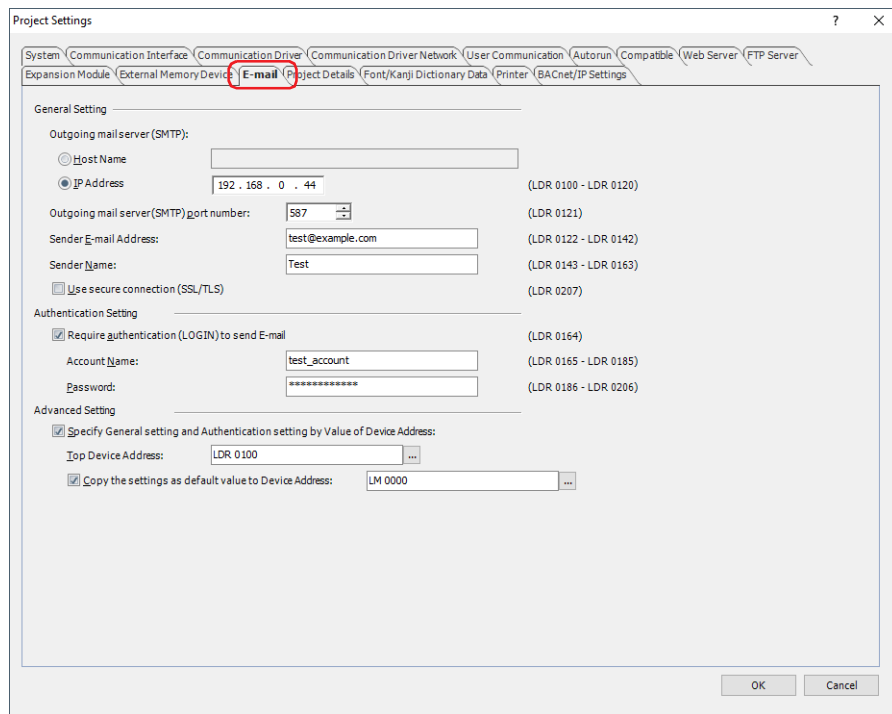

■ General Setting

Outgoing mail server (SMTP):

Selects the Outgoing mail server (SMTP) setting method.

Host Name: Specifies the Host Name of the outgoing mail server (SMTP).

The maximum number is 40 characters. Only alphanumeric characters and symbols can be used.

IP Address: Specifies the IP address of the outgoing mail server (SMTP).

The format is "xxx.xxx.xxx.xxx". "xxx" stands for a numeric value from 0 to 255.

Outgoing mail server (SMTP) port number:

Specifies the port number for the outgoing mail server (SMTP) (0 to 65535).

Sender E-mail Address:

Enter an e-mail address of the sender. The maximum number is 40 characters. Only alphanumeric characters and symbols can be used.

Sender Name:

Enter a name of the sender. The maximum number is 40 characters. Only alphanumeric characters and symbols can be used.

Use secure connection (SSL/TLS):

Select this check box to use SSL/TLS communications with the outgoing mail server.

■ Authentication Setting

When the outgoing mail server (SMTP) is protected by the account authentication, enter the account information. For details, refer to Chapter 4 "Authentication Setting" on page 4-71.

■ Advanced Setting

Specifies the **General Setting** and the **Authentication Setting** by the values of the device addresses. The settings for both the **General Setting** and the **Authentication Setting** can be used as initial values. For details, refer to Chapter 4 "Advanced Setting" on page 4-71.

3 Click **OK**.

This concludes configuring the outgoing mail server (SMTP).

● Configuring the E-mail

- 1 On the **Configuration** tab, in the **System Setup** group, click **E-mail**.

The E-mail Settings dialog box is displayed.

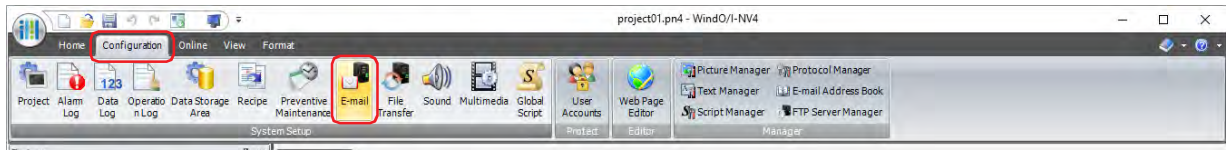

- 2 Select the number to use the E-mail function in (**Settings**).

The settings for the selected number are displayed in to the right of the list.

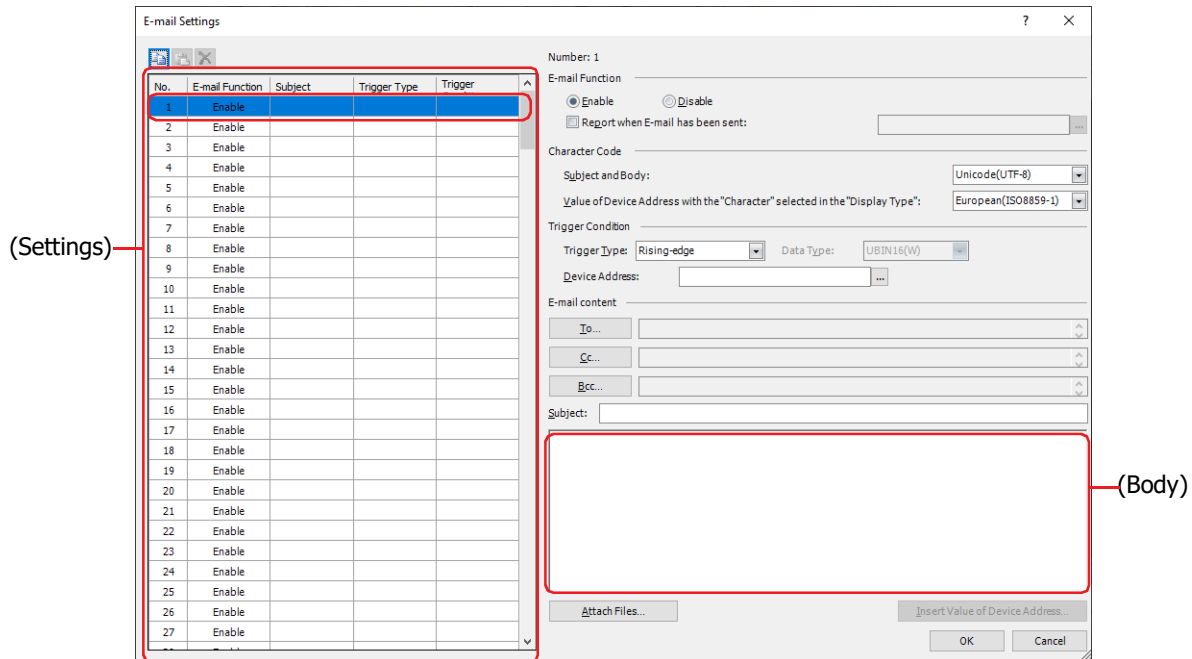

- 3 Selects the character code to use with the **Subject** and the (**Body**) under the **E-mail content** as the **Subject and Body** under the **Character Code** from the following.

ASCII, Japanese(Shift-JIS), Simplified Chinese (GB2312), Western (ISO 8859-1), Unicode(UTF-8)

When **Unicode(UTF-8)** is selected, encodes the value of device address with the **Character** selected as the **Display Type** from the source character code to the UTF-8, and displays it in the body of the e-mail. Selects the source character code from the following.

ASCII, Japanese(Shift-JIS), Simplified Chinese (GB2312), Western (ISO 8859-1), Unicode(UTF-8)



Japanese(Shift-JIS), Simplified Chinese (GB2312), Western (ISO 8859-1), and Unicode(UTF-8) are encoded by Base64.

- 4 Select the condition to send an e-mail in **Trigger Type** under **Trigger Condition** from the following.

■ Rising-edge

An e-mail is sent when the value of device address changes from 0 to 1.

Specify the bit device or the bit number of the word device as the condition.

Click to display the Tag Editor. For the device address configuration procedure, refer to Chapter 2 "5.1 Device Address Settings" on page 2-70.

■ Falling-edge

An e-mail is sent when the value of device address changes from 1 to 0.

Specify the bit device or the bit number of the word device as the condition.

Click to display the Tag Editor. For the device address configuration procedure, refer to Chapter 2 "5.1 Device Address Settings" on page 2-70.

■ Satisfy the condition

An e-mail is sent when the condition changes from not satisfied to satisfied.

Specify the conditional expression in **Condition** and select the data type handled by the conditional expression in **Data Type**.

Click  to display the Trigger Condition Settings dialog box. For the conditional expressions configuration procedure, refer to Chapter 2 "5.2 Setting Conditional Expressions" on page 2-73.

For details on data types, refer to Chapter 2 "1.1 Available Data" on page 2-1.

5 Click **To** under the **E-mail content**.

The E-mail Address Book dialog box is displayed.

6 Configures an e-mail address. Click (New E-mail Address).

The E-mail Address dialog box is displayed.

If you will not configure an e-mail address, proceed to step **11**.

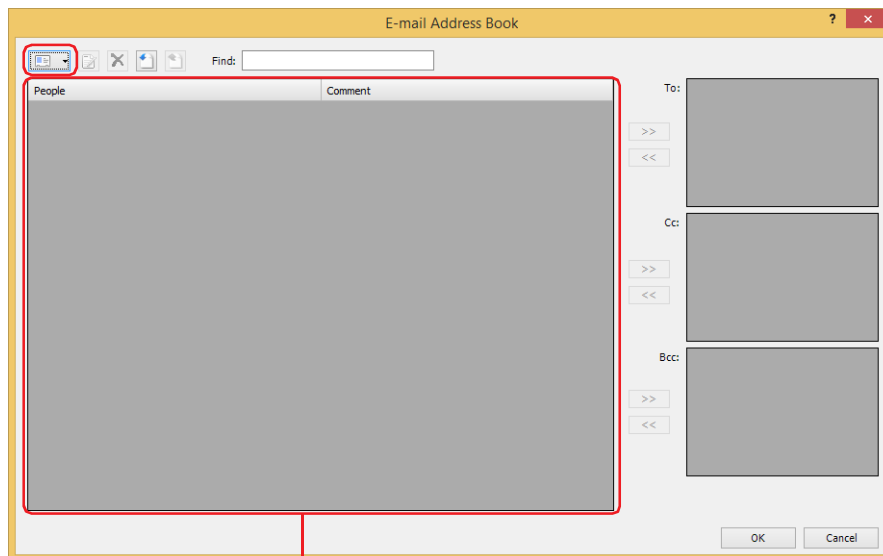

(E-mail Address List)

7 Enter an e-mail address in the **E-mail Address**.

The maximum number is 60 characters. Only alphanumeric characters and symbols can be used.

Select the **Use Reference Device Address** check box to specify the e-mail address with the value of the device address, and then specifies the word device to use it. The e-mail addresses are sequentially configured starting from the specified device address. You can only specify an internal device.

Click  to display the Tag Editor. For the device address configuration procedure, refer to Chapter 2 "5.1 Device Address Settings" on page 2-70.

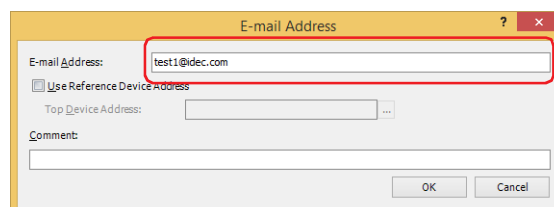

8 Enter a comment for the e-mail address in the **Comment**.

The maximum number is 80 characters.

9 Click **OK** to close the E-mail Address dialog box.

The created e-mail address is added to the (**E-mail Address List**) on the E-mail Address Book dialog box.

10 Repeat steps **6** through **9** to register the necessary e-mail addresses.



You can register multiple e-mail addresses as an E-mail Group which can be used as a contact. For details, refer to "Creating an E-mail Group" on page 28-47.

- 11 Select the e-mail address or the E-mail Group as the destination, and then click >> under the **To**. Set **Cc** and **Bcc** in the same procedure with **To** as necessary.



To select multiple e-mail addresses or E-mail Groups, press and hold SHIFT or CTRL while you click the specific items.

- 12 Click **OK** to close the E-mail Address Book dialog box. You are returned to the E-mail Settings dialog box.

- 13 Enter **Subject**.

- 14 Enter (**Body**).

- To attach the screenshots, the Alarm Log files, the Data Log files and the Operation Log files to an e-mail, configure them in the Attach Files dialog box displayed by clicking **Attach Files**. For details, refer to "Attach Files Dialog Box" on page 28-60.
- To insert the value of the device address in the body text of the e-mail, configure it in the Insert Value of Device Address dialog box displayed by clicking **Insert Value of Device Address**. For details, refer to "Insert Value of Device Address Dialog Box" on page 28-62.

- 15 Repeat steps 2 through 14 to configure the necessary e-mails.

- 16 Click **OK** to close the E-mail Settings dialog box.

This concludes configuring the e-mail.

● Creating an E-mail Group

You can register multiple e-mail addresses together into one contact as an E-mail Group.

1 On the **Configuration** tab, in the **Manager** group, click **E-mail Address Book**.

The E-mail Address Book dialog box is displayed.

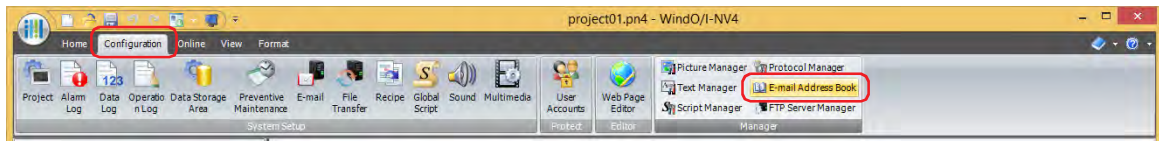

2 click the arrow to the right of (New E-mail Address), then click **New E-mail Group**.

The New E-mail Group dialog box is displayed.

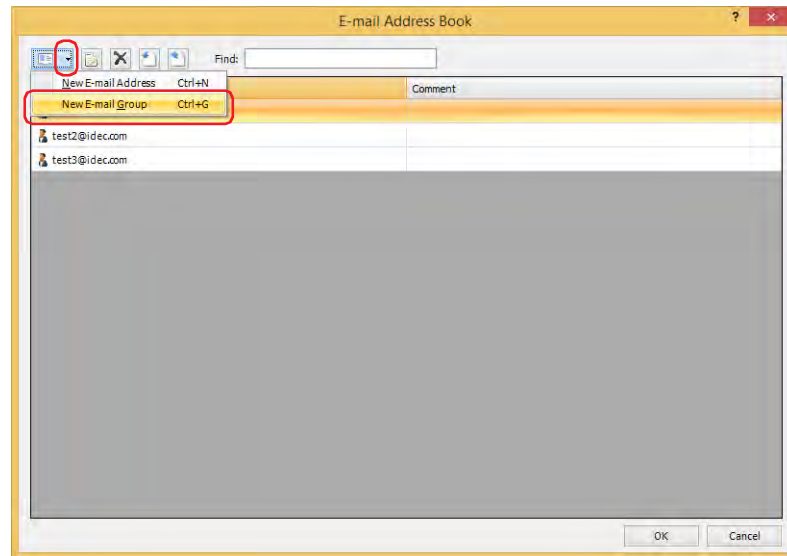

3 Enter the name for the E-mail Group in the **Group Name**.

The maximum number is 60 characters. Only alphanumeric characters and symbols can be used.

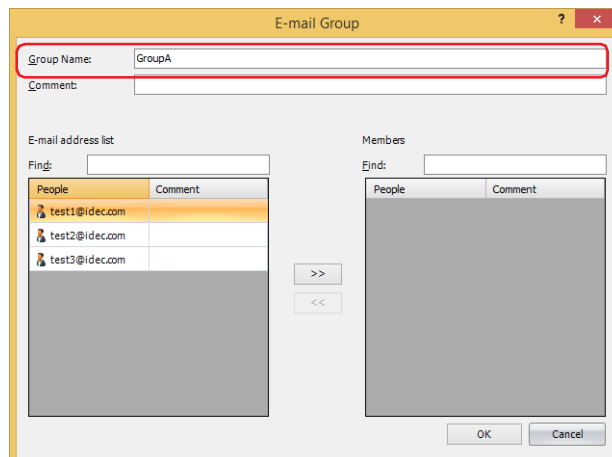

4 Enter the comment for the E-mail Group in the **Comment**.

The maximum number is 80 characters.

5 Select the e-mail address as the member from the **E-mail address list**, and then click >>.



To select multiple e-mail addresses, press and hold SHIFT or CTRL while you click the specific items.

- 6 Click **OK** to close the E-mail Group dialog box.
The created E-mail Group is added to the (**E-mail Address List**) on the E-mail Address Book dialog box.
- 7 Repeat steps 2 through 6 to create the necessary E-mail Groups.
- 8 Click **OK** to close the E-mail Address Book dialog box.

- How to use the E-mail Address Book in another project

To use the e-mail addresses and the comments registered to the E-mail Address Book in another project, save the settings of the E-mail Address Book as a file, and then import it to a project. Note, the E-mail Groups and the device addresses to specify the e-mail address are not supported.

Save the E-mail Address Book settings as a file

- 1 On the **Configuration** tab, in the **Manager** group, click **E-mail Address Book**.

The E-mail Address Book dialog box is displayed.



- 2 Click  (Export).

The Save As dialog box is displayed.

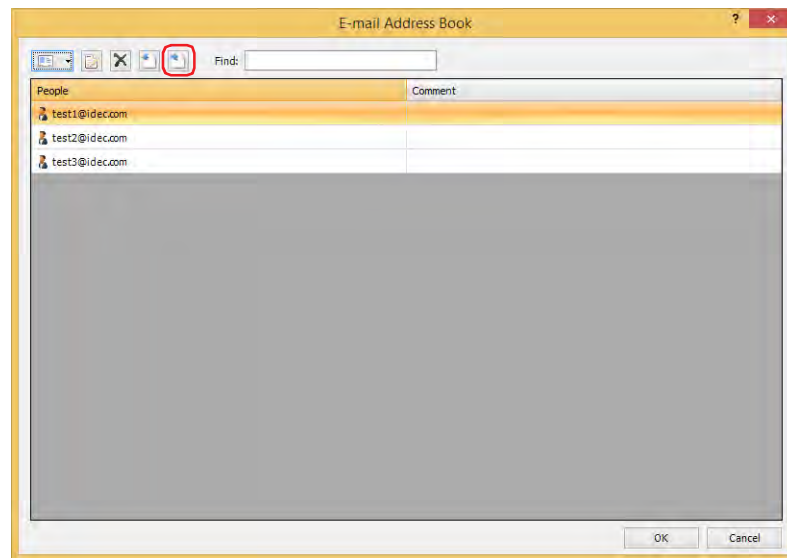

- 3 Select the save location, enter a **File name**, and then click **Save**.

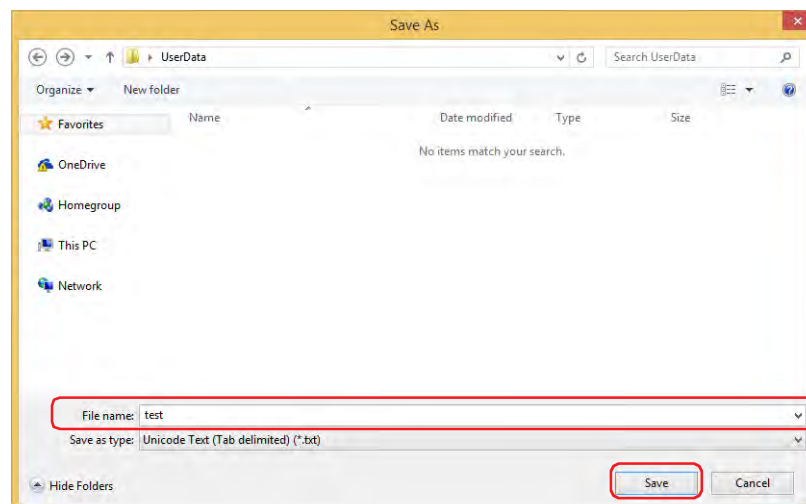

Importing the E-mail Address Book settings

- 1 On the **Configuration** tab, in the **Manager** group, click **E-mail Address Book**.

The E-mail Address Book dialog box is displayed.

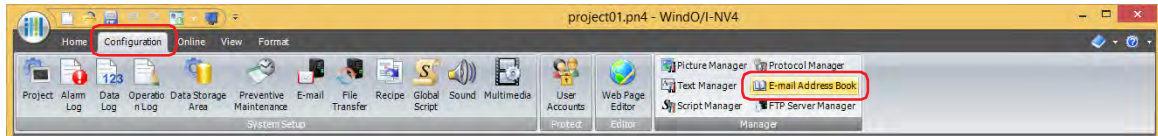

- 2 Click  (Import).

The Open dialog box is displayed.

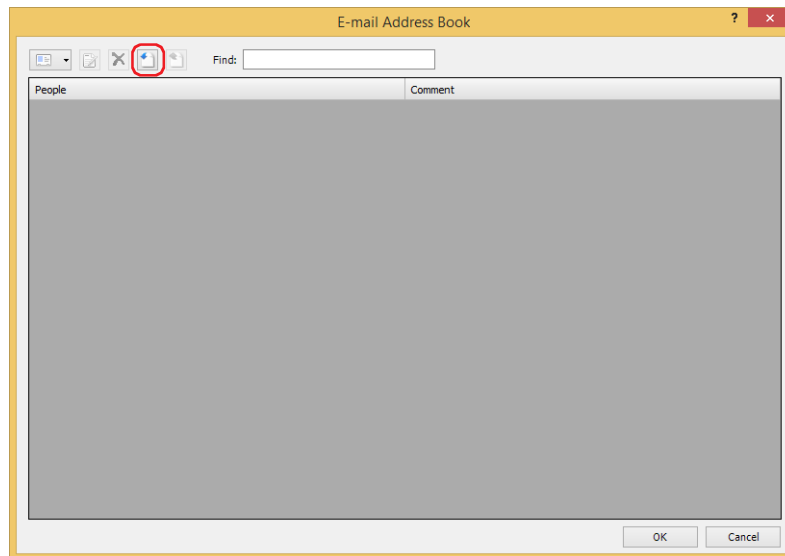

- 3 Select a file for the E-mail Address Book, and then click **Open**.

The e-mail addresses are added to the E-mail Address Book dialog box.

The e-mail address is overwritten when there is the same one.

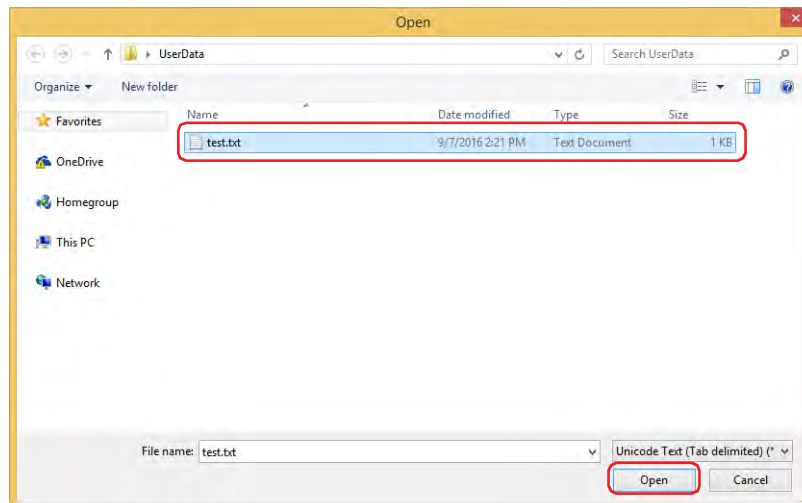

- When the e-mail address exceeds 60 characters, it is not imported.
- When the comment exceeds 80 characters, it is not imported and only the e-mail address is imported.

4.9 E-mail Settings Dialog Box

This section describes items and buttons on the E-mail Settings dialog box.

● E-mail Settings Dialog Box

The e-mail sent from MICRO/I and its trigger conditions are collectively managed in the E-mail Setting dialog box.

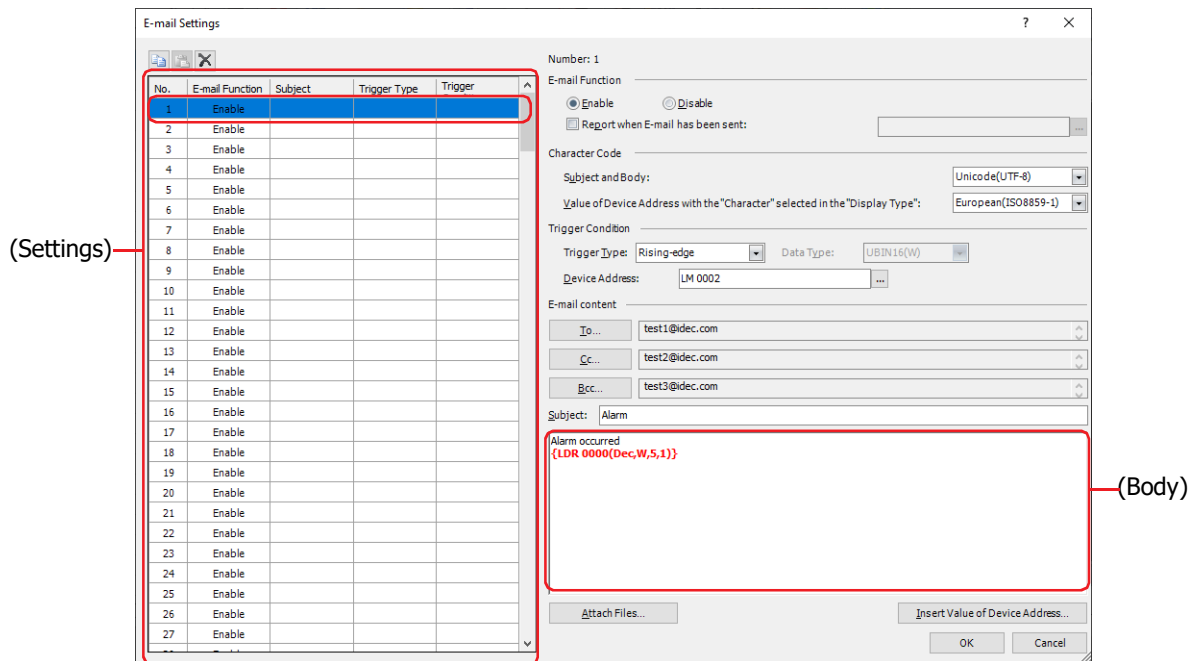

■ (Copy)

Select a number and click this button to copy the contents of that row to the clipboard.

■ (Paste)

Select a number and click this button to paste the contents of the clipboard to that row.

■ (Delete)

Select a number and click this button to delete the contents of that row.

■ (Settings)

Displays a list of the E-mail settings.

No.: Displays the number of the E-mail.

E-mail Function: Displays whether or not the e-mail function is used.

Subject: Displays the subject of the e-mail.

Trigger Type: Displays the trigger type for sending an e-mail.

Trigger Condition: Displays the trigger condition of trigger type for sending an e-mail. The displayed content varies based on **Trigger Type**.

Rising-edge, Falling-edge: Displays the bit device or the bit number of the word device to serve as condition.

Satisfy the condition: Displays the conditional expression.

■ Number

Displays the number of the e-mail selected from (Settings).

■ E-mail Function

Selects whether or not to use the e-mail function.

Enable: Sends an e-mail when the trigger condition is satisfied.

Disable: E-mail is not sent.

Report when E-mail has been sent: Select this check box to report when the e-mail has been sent.

(Report Device Address): Specifies the bit device or the bit number of the word device for reporting when the e-mail has been sent.

Click  to display the Tag Editor. For the device address configuration procedure, refer to Chapter 2 "5.1 Device Address Settings" on page 2-70.

Example: The **Number** of the e-mail is 1, **Rising-edge** is selected as **Trigger Type** in **Trigger Condition** and LM100 is set to **Device Address**, LM101 is set to (**Report Device Address**).

When the value of the device address LM100 set as the trigger condition changes to 1, the e-mail number 1 is in "Waiting" status. The value of the Report Device Address LM101 changes to 0 when the send process starts, and the value of the Report Device Address LM101 changes to 1 when the send process completes.

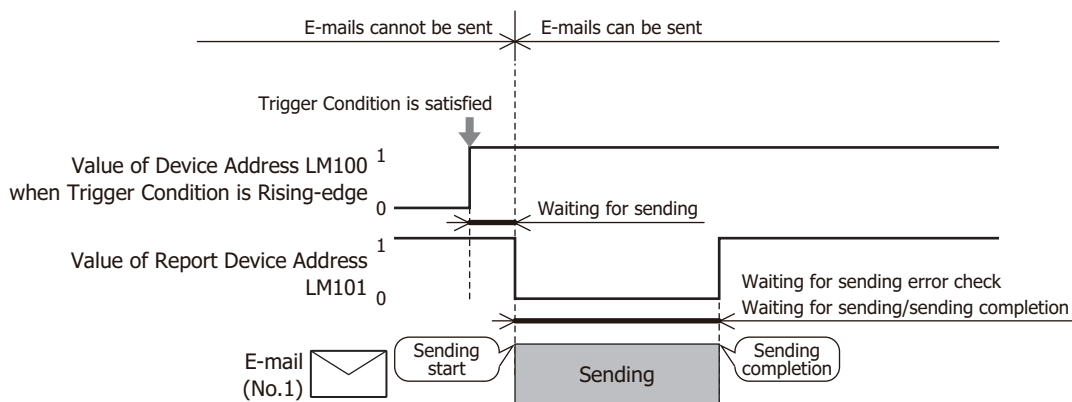

Even when an error occurs during sending, the system regards the sending is completed, and the value of the Report Device Address changes to 1.

■ Character Code

Subject and Body: Selects the character code to use with the **Subject** and the (**Body**) under the **E-mail content** from the following.

ASCII, Japanese(Shift-JIS), Simplified Chinese (GB2312), Western (ISO 8859-1), Unicode(UTF-8)



Japanese(Shift-JIS), Simplified Chinese (GB2312), Western (ISO 8859-1), and Unicode(UTF-8) are encoded by Base64.

Value of Device Address with the "Character" selected in the "Display Type":

When **Unicode(UTF-8)** is selected as the **Subject and Body**, encodes the value of device address with the **Character** selected as the **Display Type** from the source character code to the UTF-8, and displays it in the body of the e-mail. Selects the source character code from the following.

ASCII, Japanese(Shift-JIS), Simplified Chinese (GB2312), Western (ISO 8859-1), Unicode(UTF-8)

■ Trigger Condition

Set the trigger conditions for sending e-mail.

Trigger Type: A condition for sending e-mail is selected from the following.

Rising-edge: An e-mail is sent when the value of device address changes from 0 to 1.

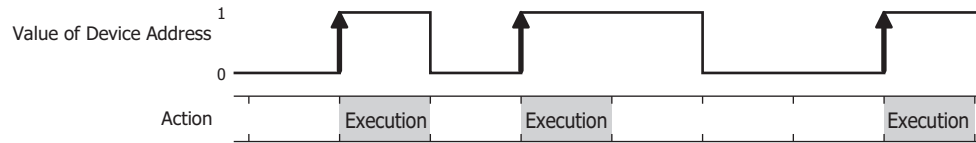

Falling-edge: An e-mail is sent when the value of device address changes from 1 to 0.

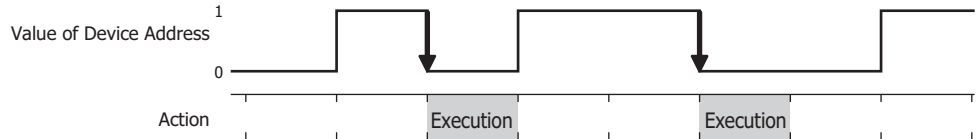

Satisfy the condition:

An e-mail is sent when the condition changes from not satisfied to satisfied.

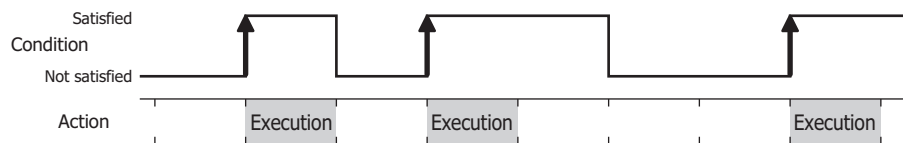

Data Type: Select the data type handled by the conditional expression.

Can only be set if **Satisfy the condition** is selected as **Trigger Type**.

For details, refer to Chapter 2 "1.1 Available Data" on page 2-1.

Device Address: Specifies the bit device or the bit number of the word device to serve as condition. You can only specify the internal device.

Can only be set if **Rising-edge** or **Falling-edge** is selected as **Trigger Type**. Click to display the Tag Editor. For the device address configuration procedure, refer to Chapter 2 "5.1 Device Address Settings" on page 2-70.

Condition: Sets the condition formula.

Can only be set if **Satisfy the condition** is selected as **Trigger Type**. Click to display the Trigger Condition Settings dialog box. For the conditional expressions configuration procedure, refer to Chapter 2 "5.2 Setting Conditional Expressions" on page 2-73.

■ E-mail content

Specify the e-mail sending destination, and enter the title and the message.

- To:** Specify the original sending destination of the e-mail. Click this button to display the E-mail Address Book dialog box. For details, refer to "E-mail Address Book Dialog Box" on page 28-56.
- (E-mail address for To): Displays the e-mail addresses and the E-mail Groups assigned to the **To** in the E-mail Address Book dialog box. When multiple e-mail addresses and E-mail Groups are allocated, they are separated by semicolons (;).
- Cc:** Specify the sending destination to which the duplication needs to be sent other than the original sending destination specified by **To**. Click this button to display the E-mail Address Book dialog box. For details, refer to "E-mail Address Book Dialog Box" on page 28-56.
- (E-mail address for Cc): Displays the e-mail addresses and the E-mail Groups assigned to the **Cc** in the E-mail Address Book dialog box. When multiple e-mail addresses and E-mail Groups are allocated, they are separated by semicolons (;).
- Bcc:** Specify the sending destination which is not to be known by the destinations specified as **To** and **Cc**. Click this button to display the E-mail Address Book dialog box. For details, refer to "E-mail Address Book Dialog Box" on page 28-56.
- (E-mail address for Bcc): Displays the e-mail addresses and the E-mail Groups assigned to the **Bcc** in the E-mail Address Book dialog box. When multiple e-mail addresses and E-mail Groups are allocated, they are separated by semicolons (;).
- Subject:** Enter a subject of an e-mail. The maximum size is 256 bytes.
- (Body):** Enter a body text of an e-mail. The maximum size is 4,096 bytes.
- Attach Files:** Attach files to an e-mail. Click this button to display the Attach Files dialog box. For details, refer to "Attach Files Dialog Box" on page 28-60.
- Insert Value of Device Address:** Insert a device address in the body text of an e-mail. Click this button to display the Insert Value of Device Address dialog box. For details, refer to "Insert Value of Device Address Dialog Box" on page 28-62.

● E-mail Address Book Dialog Box

The e-mail addresses used by the E-mail function are collectively managed in the E-mail Address Book dialog box.

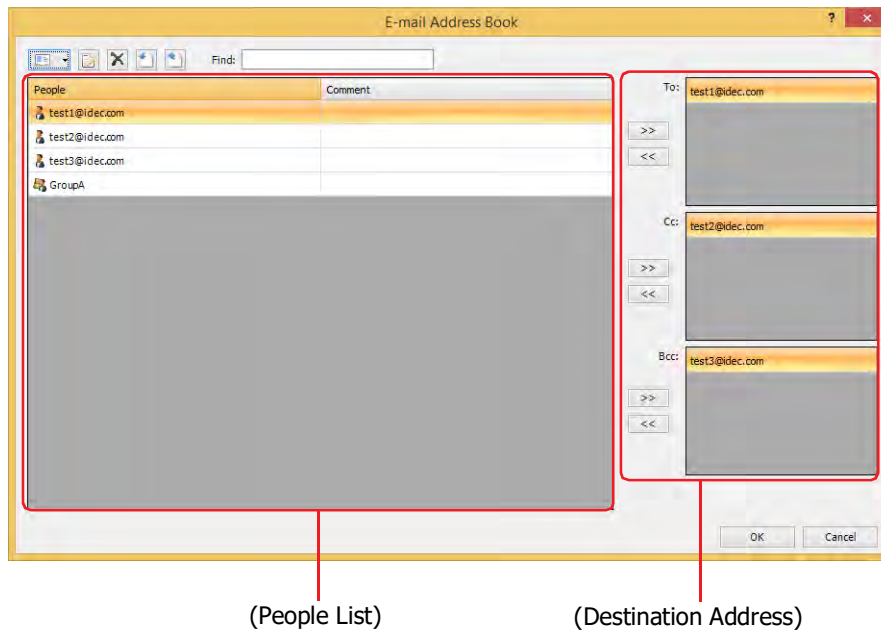

■ (New E-mail Address)

Adds an e-mail address or an E-mail Group.

Click this button to display the E-mail Address dialog box. For details, refer to "E-mail Address Dialog Box" on page 28-58.

To create an E-mail Group, click the arrow to the right of this button and then click **New E-mail Group**.

■ (Edit)

Changes the selected e-mail address or E-mail Group.

Select an e-mail address in People, and then click this button to display the E-mail Address dialog box. For details, refer to "E-mail Address Dialog Box" on page 28-58.

Select an E-mail Group in People, and then click this button to display the E-mail Group dialog box. For details, refer to "E-mail Group Dialog Box" on page 28-59.

■ (Delete)

Deletes the selected e-mail address and E-mail Group in People.

■ (Import)

Imports the file in the E-mail Address Book saved by the Unicode text format (*.txt). Click this button to display the Open dialog box. For details, refer to "Importing the E-mail Address Book settings" on page 28-50.

■ (Export)

Export and saves the E-mail Address Book settings as an Unicode Text (*.txt) file.

Click this button to display the Save As dialog box. For details, refer to "Save the E-mail Address Book settings as a file" on page 28-49.

The saved E-mail Address Book file can be imported with  (Import).

■ Find

The entered text is searched for in the **People** in the **(People List)**.

■ (People List)

The registered e-mail addresses are displayed in a list.

People: Displays the registered e-mail addresses and E-mail Groups.
 Double clicking the cell of the e-mail address displays the E-mail Address dialog box. For details, refer to "E-mail Address Dialog Box" on page 28-58.
 Double clicking the cell of the E-mail Group displays the E-mail Group dialog box. For details, refer to "E-mail Group Dialog Box" on page 28-59.



To select multiple e-mail addresses and E-mail Groups, press and hold SHIFT or CTRL while you click the specific items.

Comment: Displays the comment for the e-mail address or E-mail Group.
 Double clicking the cell of the e-mail address displays the E-mail Address dialog box. For details, refer to "E-mail Address Dialog Box" on page 28-58.
 Double clicking the cell of the E-mail Group displays the E-mail Group dialog box. For details, refer to "E-mail Group Dialog Box" on page 28-59.

■ (Destination Address)*1

Configures a destination address for an e-mail.

- >>: Assigns e-mail address and the E-mail Group displayed in the **(People List)** to the **To**, the **Cc** or the **Bcc**.
- <<: Deletes the e-mail addresses and the E-mail Groups assigned to the **To**, the **Cc** or the **Bcc**.
- To:** Displays the e-mail addresses and the E-mail Groups assigned to the **To**. Specify the original sending destination of the e-mail.
- Cc:** Displays e-mail addresses and the E-mail Groups assigned to the **Cc**. Specify the sending destination to which the duplication needs to be sent other than the original sending destination specified by **To**.
- Bcc:** Displays e-mail addresses and the E-mail Groups assigned to the **Bcc**. Specify the sending destination which is not to be known by the destinations specified as **To** and **Cc**. The sending destination specified as **Bcc** is not displayed to the destinations set as **To** and **Cc**.

*1 Destination Address is only displayed when this dialog box is opened from E-mail Setting dialog box

E-mail Address Dialog Box

Registers an e-mail address or edits an existing e-mail address.

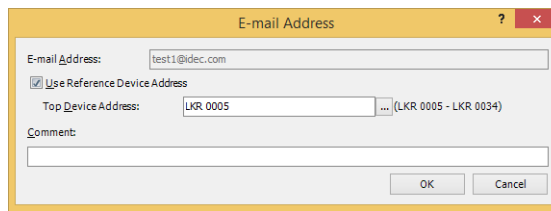

■ E-mail Address

Enter a destination e-mail address. The maximum number is 60 characters. Only alphanumeric characters and symbols can be used.

Use Reference Device Address: Select this check box to specify the e-mail address with the value of the device address.

Top Device Address: Specifies a word device to use an e-mail address. The e-mail address is set by reading the values sequentially from the starting device address specified with the **Top Device Address** and handling those values as character data up to the character before NULL (0x00). The maximum number of device addresses is 30 (maximum of 60 characters). You can only specify an internal device.

Click  to display the Tag Editor. For the device address configuration procedure, refer to Chapter 2 "5.1 Device Address Settings" on page 2-70.

■ Comment

Enter a comment for the e-mail address. The maximum number is 80 characters.

E-mail Group Dialog Box

Creates an E-mail Group or edits an existing E-mail Group.

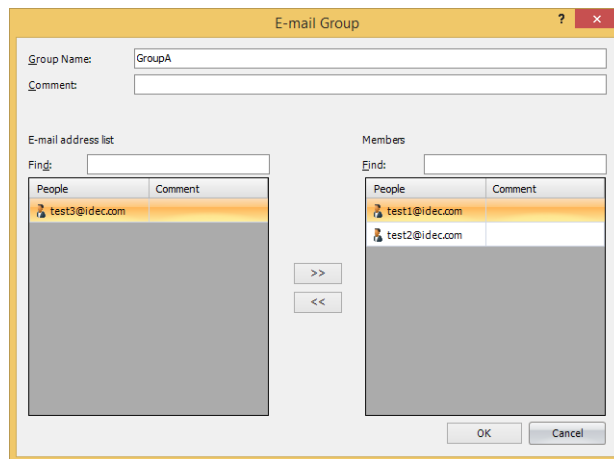

- **Group Name**

Enter a name of the E-mail Group. The maximum number is 60 characters. Only alphanumeric characters and symbols can be used.

- **Comment**

Enter a comment for the E-mail Group. The maximum number is 80 characters.

- **E-mail address list**

Find: The text entered is searched for **People** in the **E-mail address list**.

People: The e-mail addresses registered in the E-mail Address Book dialog box are displayed in this list.



To select multiple e-mail addresses, press and hold SHIFT or CTRL while you click the specific items.

Comment: Displays the comment for the e-mail address.

- **>>**

Assigns the e-mail address displayed in the **E-mail address list** to the **Members**.

- **<<**

Deletes the e-mail addresses assigned to the **Members**.

- **Members**

Find: The text entered is searched for **People** in the **Members**.

People: The e-mail addresses assigned to a member of E-mail Group are displayed in this list.



To select multiple e-mail addresses, press and hold SHIFT or CTRL while you click the specific items.

Comment: Displays the comment for the e-mail address.

● Attach Files Dialog Box

Files attached to an e-mail is configured in the Attach Files dialog box.

■ Screenshot

Select this check box to attach a screenshot of the current screen to an e-mail.

The file format is JPEG and the file name becomes "Image.JPG".

■ Alarm Log Files

Select this check box to attach a specified alarm log data to an e-mail.

The file format is CSV and the file name becomes "ALMLOG.CSV".

Specifies the output format and the range of the alarm log data.

Output Format: Specifies the items of the alarm log data attached to an e-mail.

Output Channel Number, Message, Occurrence Time, Recovery Time and Confirmation Time:

The output data is the same format as the Alarm Log function batch outputs to the external memory device. For details, refer to Chapter 13 "Batch" on page 13-38.

Output Channel Number, Message, State and Time:

The output data is the same format as the Alarm Log function outputs to the external memory device in real time. For details, refer to Chapter 13 "Real Time" on page 13-39.

Range of Blocks: Specifies the range of block numbers that will output in the collected alarm log data.

All: Outputs the data for all blocks.

Specify block number: Outputs only the data for the specified blocks.

Individual block numbers can be specified by separating the numbers with ",", continuous regions can be specified with "-".

Example: When the number of blocks is 6, enter the following.

To specify blocks 1 to 3: 1-3

To specify blocks 1, 3, 6: 1, 3, 6

To specify blocks 1, 4 to 6: 1, 4-6

Specify a period of time: Select this check box to specify the period of alarm log output data. Outputs the specified period of the alarm log data after the Trigger Condition is satisfied.

Specify the maximum number of items:

Select this check box to specify the maximum amount of alarm log output data. Outputs the specified number of the alarm log data after the Trigger Condition is satisfied.



When the **Specify a period of time** check box and the **Specify the maximum number of items** check box are selected, the output range is until either is satisfied.

■ Data Log Files

Select this check box to attach a specified data log data to an e-mail.

The file format is CSV and the file name becomes "DATALOG**.CSV (**: Channel Number)".

Specifies the range of the data log data.

Channel Number: Specifies the range of channel numbers that will output in the collected data log data.

Individual channel numbers can be specified by separating the numbers with ",", continuous regions can be specified with "-".

Example: When the channel number is 1 to 6, enter the following.

To specify channel numbers 1 to 3: 1-3

To specify channel numbers 1, 3, 6: 1, 3, 6

To specify channel numbers 1, 4 to 6: 1, 4-6

Specify a period of time: Select this check box to specify the period of data log output data. Outputs the specified period of the data log data after the Trigger Condition is satisfied.

Specify the maximum number of items: Select this check box to specify the maximum amount of data log output data. Outputs the specified number of the data log data after the Trigger Condition is satisfied.



When the **Specify a period of time** check box and the **Specify the maximum number of items** check box are selected, the output range is until either is satisfied.

■ Operation Log Files

Select this check box to attach a specified operation log data to an e-mail.

The file format is CSV and the file name becomes "OPLOG.CSV".

Specifies the range of the operation log data.

Specify a period of time: Select this check box to specify the period of operation log output data. Outputs the specified period of the operation log data after the Trigger Condition is satisfied.

Specify the maximum number of items: Select this check box to specify the maximum amount of operation log output data. Outputs the specified number of the operation log data after the Trigger Condition is satisfied.



When the **Specify a period of time** check box and the **Specify the maximum number of items** check box are selected, the output range is until either is satisfied.

● Insert Value of Device Address Dialog Box

To enter a value of device address in the body text of the e-mail, configures the settings on the Insert Value of Device Address dialog box.

■ Reference Device Address

Specify the source word device.

Click to display the Tag Editor. For the device address configuration procedure, refer to Chapter 2 "5.1 Device Address Settings" on page 2-70.

■ Display Type

Selects the display type of the value from the following.

Decimal, Hexadecimal, Character

■ Data Format

Data Type: Selects the type of data for the value.

For details, refer to Chapter 2 "1.1 Available Data" on page 2-1.

This setting can only be configured when **Decimal** or **Hexadecimal** is selected for **Display Type**.

Digits: Specifies the digits to display. The range of digits that can be set varies based on the display type and data type. The digits that can be set are as follows.

Display Type	Data Type	Digits
Decimal display	UBIN16(W), BIN16(I)	1 to 5
	UBIN32(D), BIN32(L)	1 to 10
	BCD4(B)	1 to 4
	BCD8(EB)	1 to 8
	Float32(F)	1 to 10
Hexadecimal display	UBIN16(W)	1 to 4
	UBIN32(D)	1 to 8

Display Floating Point: Select this check box to display the decimal point.

This setting can only be configured when **Decimal** is selected for **Display Type**.



When the **Display Floating Point** check box is selected and **UBIN16(W)**, **BIN16(I)**, **UBIN32(D)**, **BIN32(L)**, **BCD4(B)**, or **BCD8(EB)** is selected for **Data Type**, the source device is an integer, but the value is displayed with the decimal point added at the configured floating digits.

Floating Digits:

Specifies the number of digits for the fractional part of the decimal value out of the number of digits specified by **Digits**.

This option can only be configured when the **Display Floating Point** check box is selected. The range of digits that can be set for the fractional part varies based on the display type and data type. The range of digits that can be set is as follows.

Display Type	Data Type	Floating Digits
Decimal display	UBIN16(W), BIN16(I)	1 to Digits
	UBIN32(D), BIN32(L)	1 to Digits
	BCD4(B)	1 to Digits
	BCD8(EB)	1 to Digits
	Float32(F)	1 to Digits or 8
Hexadecimal display	UBIN16(W)	--
	UBIN32(D)	--

- **Words**

Specify the number of source word devices (1 to 64).

This setting can only be configured when **Character** is selected for **Display Type**.

5 Social Media Function

HG2J-7U HG5G-V HG4G-V HG4G HG3G-V HG3G HG2G-V HG2G-5F HG2G-5T HG1G HG1P

5.1 What Can Be Done with the Social Media Function

The social media function enables sending social media message such as text, screenshots of MICRO/I, etc. (tweets), from the MICRO/I to the specified account (Twitter account) when a specified trigger condition is satisfied.



Twitter API v1.1 is used to send social media messages, and it may not work due to changes in the specifications of Twitter.

For Twitter API restrictions and how to use Twitter, please check the Twitter website. (December 2021)

5.2 System Composition

An example system configuration for using the social media function is shown below.

Configure the MICRO/I Ethernet settings (IP address, subnet mask, default gateway) and connect to a local network.

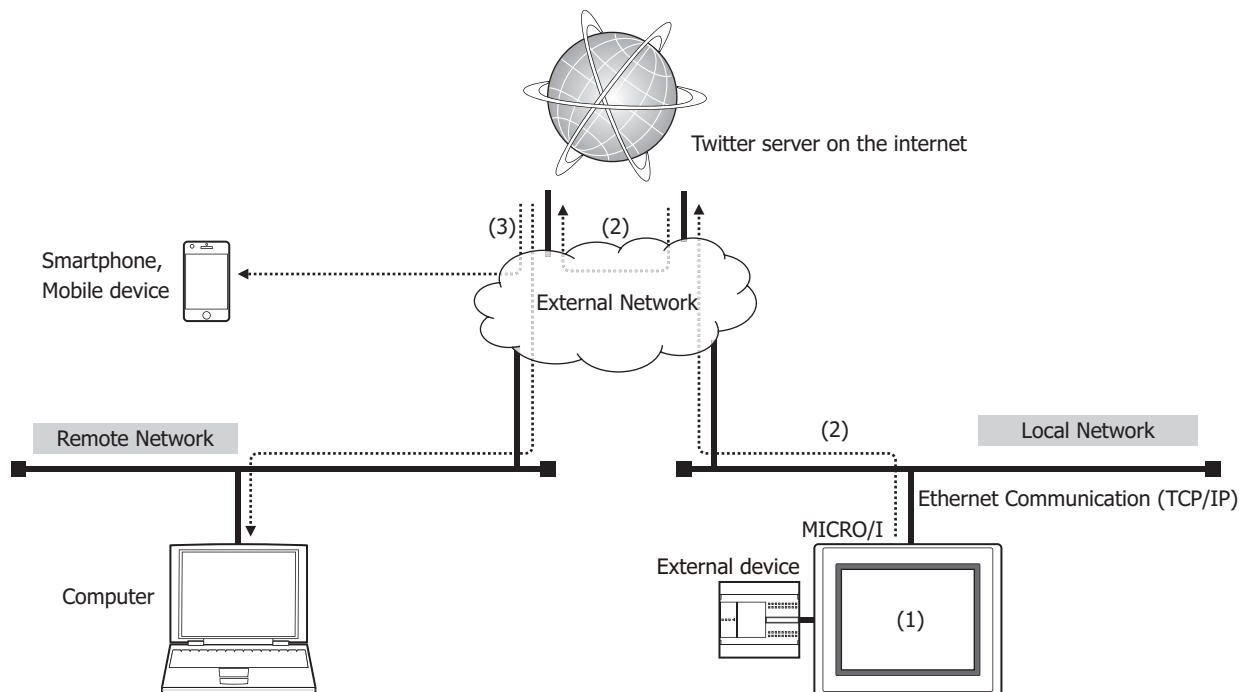

- (1) Configure the MICRO/I with the social media information (Twitter account, social media message, sending conditions, etc.).
- (2) When the trigger condition for the social media function is satisfied, MICRO/I connected to the local network sends the social media message to the Twitter server.
- (3) Twitter tweets are received by a smartphone and computer etc. (If you install the Twitter client in advance, you can receive push notifications.)



For the local network settings, contact the administrator of the network which the MICRO/I is connected to.

5.3 Social media message Sending Operation

Social media messages will be sent when a specified trigger condition is satisfied. For details, refer to "Trigger Condition" on page 28-72.

The MICRO/I cannot simultaneously send multiple social media messages. Accordingly, when there are multiple social media message sending events, such as multiple trigger conditions to send an social media message are the same or multiple trigger conditions are satisfied at the same time, the social media messages are sent in the order described below.

■ Multiple trigger conditions to send a social media message are the same or the different trigger conditions are satisfied at the same time

When multiple trigger conditions to send a social media message are the same or when the different trigger conditions are satisfied at the same time (the values of multiple trigger device addresses change to 1 at the same time), social media messages are sent in the order of smaller number. Triggered social media messages will be in "Waiting" status while sending another social media message is in progress.

For example, if the trigger conditions for social media message number 1 and social media message number 2 are the same, once the trigger conditions are satisfied, social media message number 1 starts to be sent, and social media message number 2 is in "Waiting" status. After the social media message number 1 has been sent, the social media message number 2 starts to be sent.

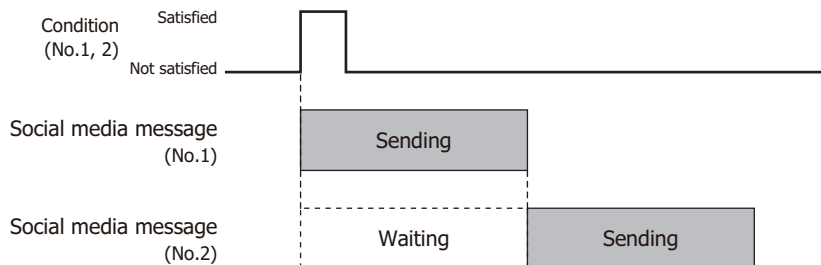

■ When the trigger condition is satisfied during the other social media message is being sent

When sending a social media message is in progress and the trigger condition to send another social media message is satisfied, triggered social media message will be in "Waiting" status. Such social media message is sent after all the social media messages in sending or waiting status have been sent.

For example, if the trigger condition for the social media message number 2 is satisfied during the social media message number 1 is sending, number 2 is in "Waiting" status. After the social media message number 1 has been sent, the social media message number 2 starts to be sent.

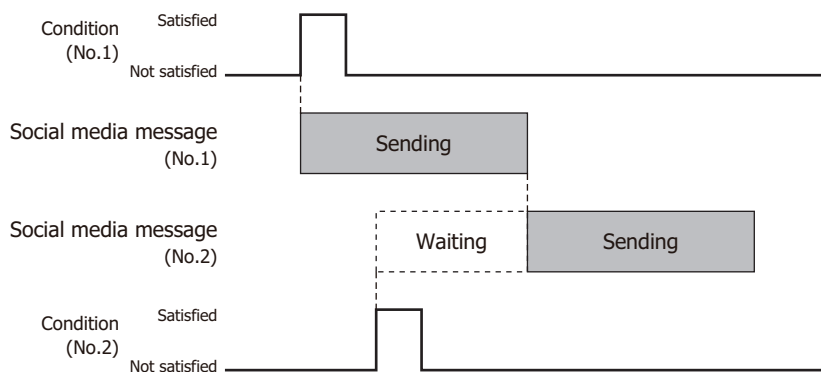

■ When the trigger condition is satisfied again during the social media message is being sent

While sending a social media message is in progress or a social media message is in "Waiting" status, if the trigger condition to send such social media message is satisfied, such trigger condition is disregarded.

For example, if the trigger condition for the social media message number 1 is satisfied again during which it is being sent, the social media message will be not "Waiting" status so the same social media message is not going to be sent twice.

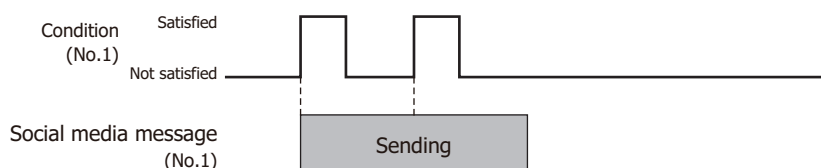

5.4 Operating Social media function and checking sending status

● Operating Social media function

Enables to cancel or pause the social media message sending by the HMI Special Internal Relay.

■ LSM75: Cancelling the social media message sending

When a value of this bit changes from 0 to 1, the MICRO/I cancels sending of all the social media messages in "Waiting" status. If sending a social media message is in progress, the send process will be cancelled after such social media message has been sent. Even if the value of LSM76 is 1, this function can be executed.

■ LSM76: Pausing the social media message sending

While a value of this bit is 1, the MICRO/I pauses sending of all the social media messages in "Waiting" status. If sending a social media message is in progress, the send process will be paused after such social media message has been sent.

● Checking the social media message sending state

You can check the social media message sending state through the values of the HMI Special Data Register.

■ LSD368: Number of social media message in "Waiting" status

The number of social media message that are waiting to be sent is stored.

■ LSD369: Result of social media message sending

The sending result of the social media message last sent is stored.

Status	Cause
0: Successfully Completed	-
1: Parameter error	The character code set in the message cannot be used.
2: Timeout error	<ul style="list-style-type: none"> An Ethernet cable is disconnected. Network is not configured correctly (IP address, DNS settings).
3: Authentication error	<ul style="list-style-type: none"> MICRO/I time is not set correctly. Twitter account does not exist.
4: User error	<ul style="list-style-type: none"> The same message has been sent. The maximum number of transmissions has been reached. Twitter account is suspended and cannot be used.
5: Other error	Cannot connect to the Twitter server due to a failure etc.



After the value of the device address specified in the **Report when sending has been done** on the **Social Media Settings** dialog box changes to 1, the result of the social media message sending is stored in LSD369.

■ LSD370: Social media message Number which has been sent

The social media message number which has been sent is stored. Only the latest social media message number is stored.



Even when an error occurs during sending, the MICRO/I handles the send process is completed and the social media message number is stored in LSD370.

5.5 Restrictions of each Tweet

■ Message

The maximum number is 140 characters.



Please note that due to Twitter restrictions, you cannot tweet virtually the same content.

■ Screenshot

The maximum number of screenshots that can be attached is one, and the file format is JPEG.

5.6 Social Media Function Configuration Procedure

This section describes the configuration procedure for the Twitter account and the social media message.

- 1 On the **Configuration** tab, in the **System Setup** group, click **Social Media**.

The Social Media Settings dialog box is displayed.

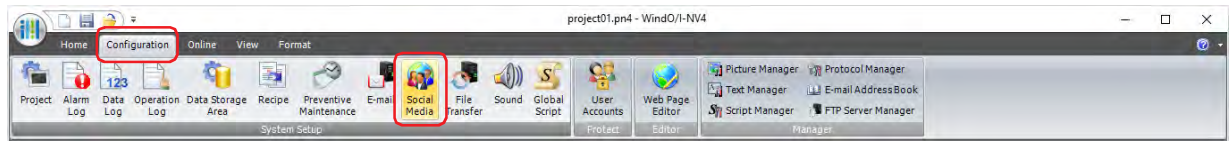

- 2 Select the number to use the Social media function in (**Settings**).

The settings for the selected number are displayed in to the right of the list.

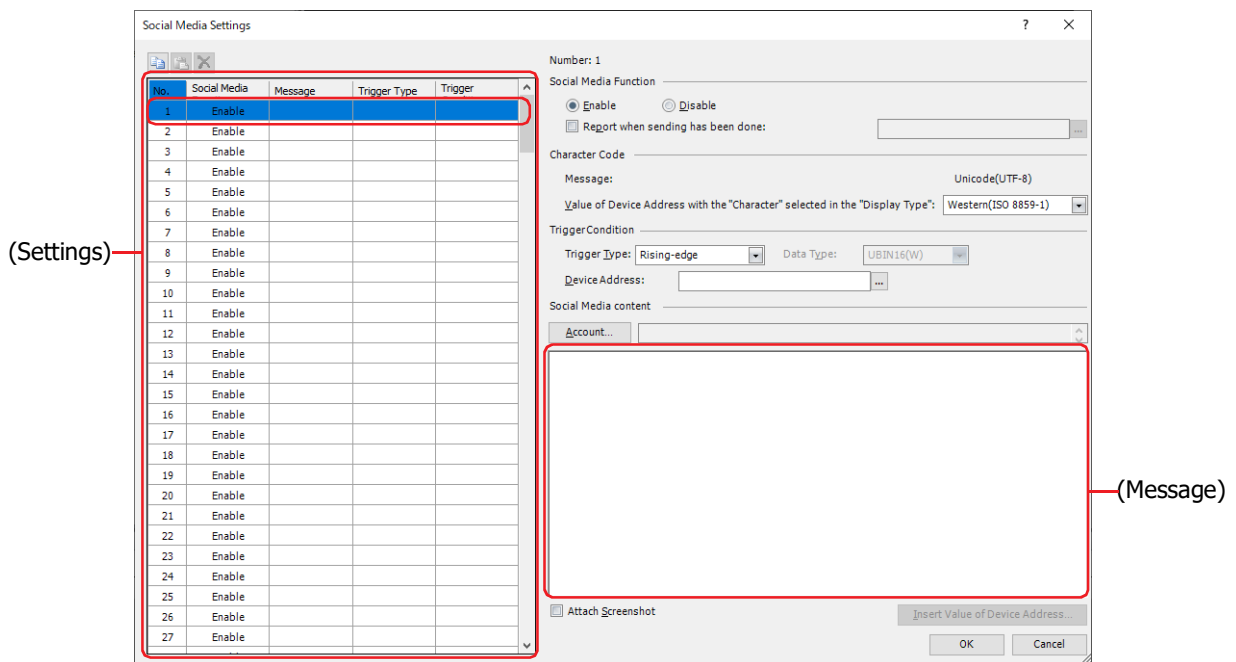

- 3 Select the condition to send a social media message in **Trigger Type** under **Trigger Condition** from the following.

■ Rising-edge

A social media message is sent when the value of device address changes from 0 to 1.

Specify the bit device or the bit number of the word device as the condition.

Click to display the Tag Editor. For the device address configuration procedure, refer to Chapter 2 "5.1 Device Address Settings" on page 2-70.

■ Falling-edge

A social media message is sent when the value of device address changes from 1 to 0.

Specify the bit device or the bit number of the word device as the condition.

Click to display the Tag Editor. For the device address configuration procedure, refer to Chapter 2 "5.1 Device Address Settings" on page 2-70.

■ Satisfy the condition

A social media message is sent when the condition changes from not satisfied to satisfied.

Specify the conditional expression in **Condition** and select the data type handled by the conditional expression in **Data Type**.

Click to display the Trigger Condition Settings dialog box. For the conditional expressions configuration procedure, refer to Chapter 2 "5.2 Setting Conditional Expressions" on page 2-73.

For details on data types, refer to Chapter 2 "1.1 Available Data" on page 2-1.

- 4 Click **Account** under the **Social Media content**.

The Social Media Account Manager is displayed.

- 5 Configures a Twitter account. Click  (New Twitter Account).

The Twitter Account dialog box is displayed.

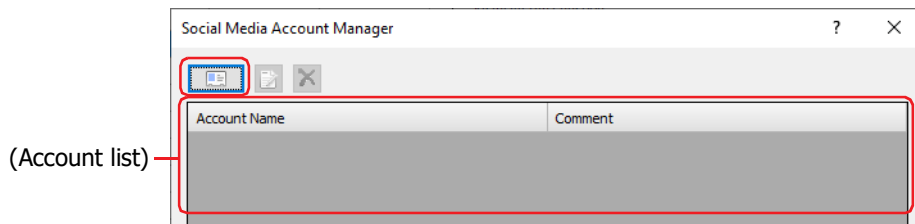

- 6 Click **Log in to the Account**.

A web browser starts and the login screen for your Twitter account is displayed.

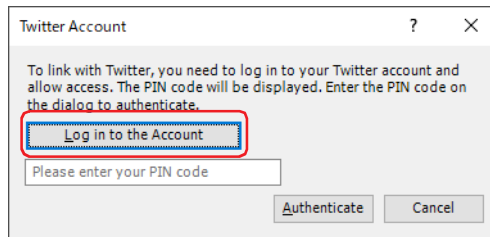

In order to display the login screen for your Twitter account, your computer must be connected to the Internet.

- 7 Log in to the Twitter account to which you want to send social media messages, and then click **Authorize app**.

The PIN code (7-digit number) used for authentication is displayed.

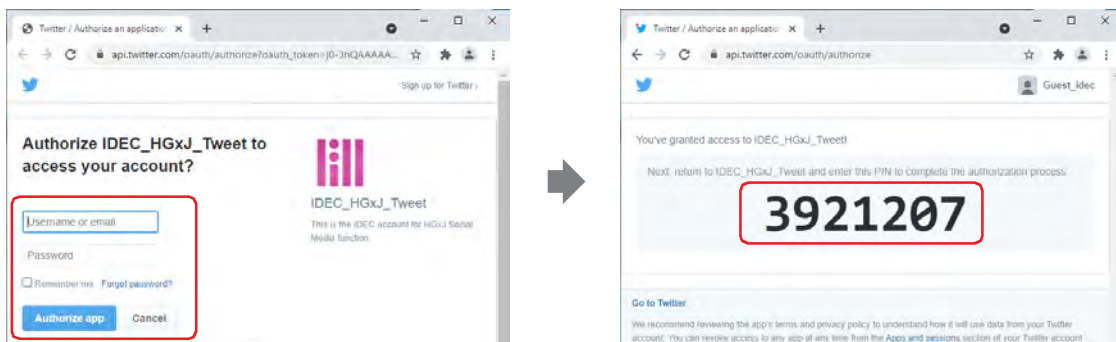

- 8 Copy the PIN code displayed on the screen, and then return to the Twitter Account dialog box.

- 9 Enter the obtained PIN code, and click **Authenticate**.

Once the PIN code is authenticated, your Twitter account and the social media function will be linked.

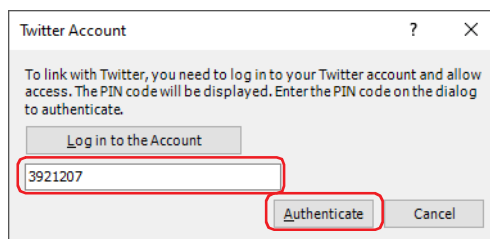

- 10 Confirm the account name and enter the comment for the Twitter account in the **Comment**.

The maximum number is 80 characters.

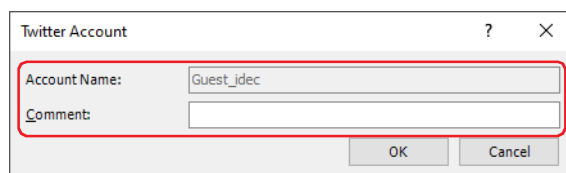

11 Click **OK**.

You are returned to the Social Media Account Manager.

12 Select the Twitter account as the destination, and then click **OK**.

You are returned to the Social Media Settings dialog box.

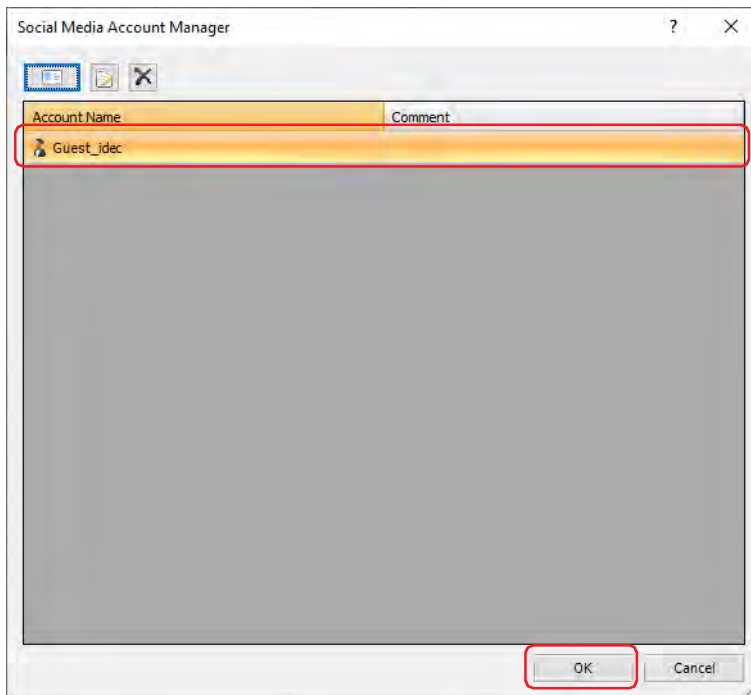

13 Enter (Message).

- Select this check box to attach a screenshot of the current screen to a social media message.
- To insert the value of the device address in the social media message, configure it in the Insert Value of Device Address dialog box displayed by clicking Insert Value of Device Address. For details, refer to "Insert Value of Device Address Dialog Box" on page 28-75.

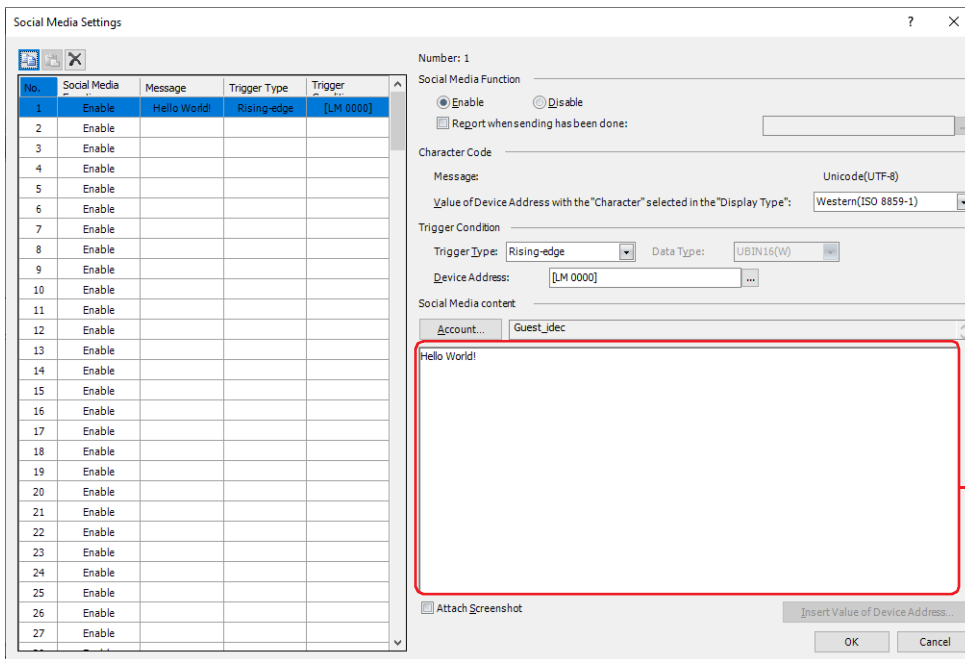

14 Repeat steps 2 through 13 to configure the necessary social media messages.

15 Click **OK** to close the Social Media Settings dialog box.

This concludes configuring the social media.

5.7 Social Media Settings Dialog Box

This section describes items and buttons on the Social Media Settings dialog box.

● Social Media Settings Dialog Box

The social media message sent from MICRO/I and its trigger conditions are collectively managed in the Social Media Settings dialog box.

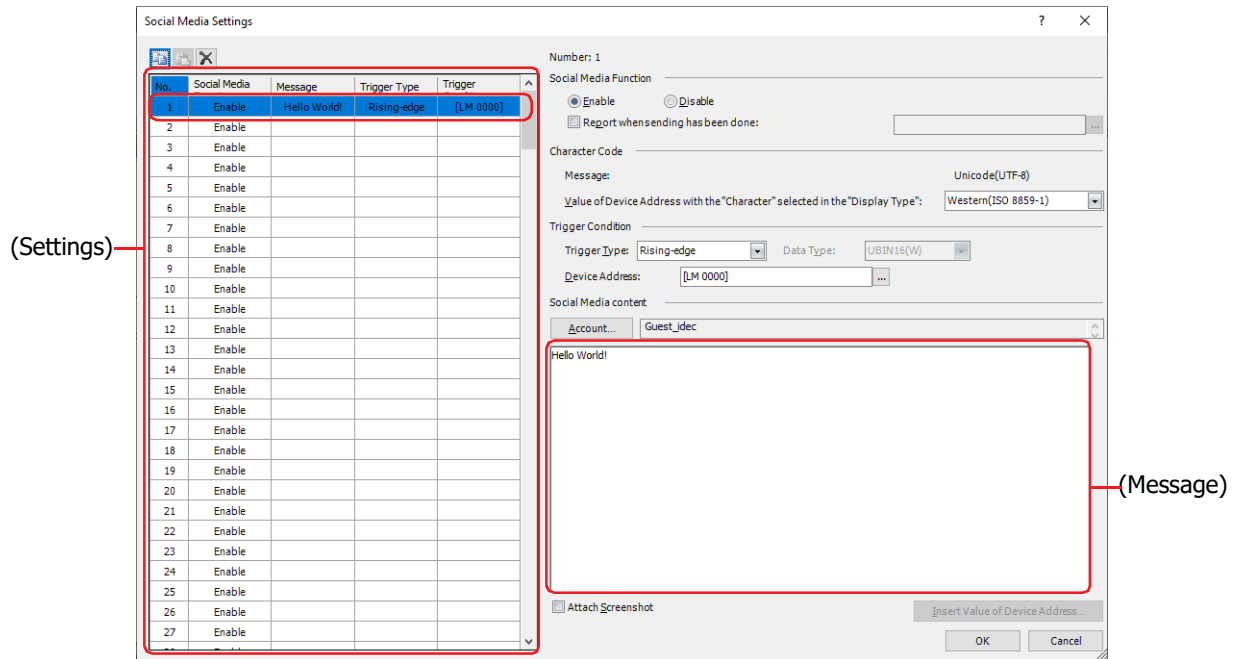

■ (Copy)

Select a number and click this button to copy the contents of that row to the clipboard.

■ (Paste)

Select a number and click this button to paste the contents of the clipboard to that row.

■ (Delete)

Select a number and click this button to delete the contents of that row.

■ (Settings)

Displays a list of the Social Media Function.

No.: Displays the number of the social media message.

Social Media Function: Displays whether or not the social media function is used.

Message: Displays the social media message.

Trigger Type: Displays the trigger type for sending a social media message.

Trigger Condition: Displays the trigger condition of trigger type for sending a social media message. The displayed content varies based on **Trigger Type**.

Rising-edge, Falling-edge: Displays the bit device or the bit number of the word device to serve as condition.

Satisfy the condition: Displays the conditional expression.

■ Number

Displays the number of the social media message selected from (Settings).

■ Social Media Function

Selects whether or not to use the social media function.

Enable: Sends a social media message when the trigger condition is satisfied.

Disable: Social media message is not sent.

Report when sending has been done: Select this check box to report when the social media message has been sent.

(Report Device Address): Specifies the bit device or the bit number of the word device for reporting when the social media message has been sent.

Click to display the Tag Editor. For the device address configuration procedure, refer to Chapter 2 "5.1 Device Address Settings" on page 2-70.

Example: The **Number** of the social media message is 1, **Rising-edge** is selected as **Trigger Type** in **Trigger Condition** and LM100 is set to **Device Address**, LM101 is set to (**Report Device Address**). When the value of the device address LM100 set as the trigger condition changes to 1, the social media message number 1 is in "Waiting" status. The value of the Report Device Address LM101 changes to 0 when the send process starts, and the value of the Report Device Address LM101 changes to 1 when the send process completes.

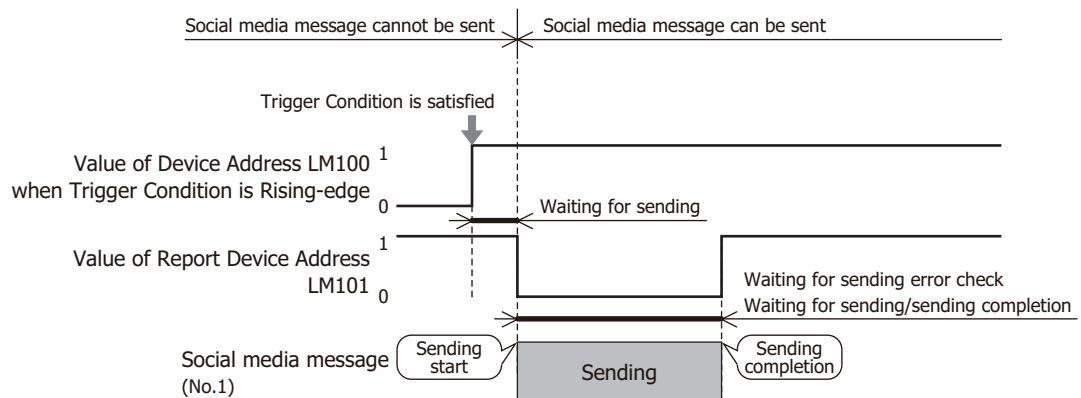

Even when an error occurs during sending, the system regards the sending is completed, and the value of the Report Device Address changes to 1.

■ Character Code

Message: The character code used in (**Message**) of **Social Media content** is fixed to **Unicode (UTF-8)**.

Value of Device Address with the "Character" selected in the "Display Type":

MICRO/I encodes the value of device address with the **Character** selected as the **Display Type** from the source character code to the UTF-8, and displays it in the body of the social media message. Selects the source character code from the following.

ASCII, Japanese(Shift-JIS), Simplified Chinese (GB2312), Western (ISO 8859-1), Unicode(UTF-8)

■ Trigger Condition

Set the trigger conditions for sending social media message.

Trigger Type: A condition for sending social media message is selected from the following.

Rising-edge: A social media message is sent when the value of device address changes from 0 to 1.

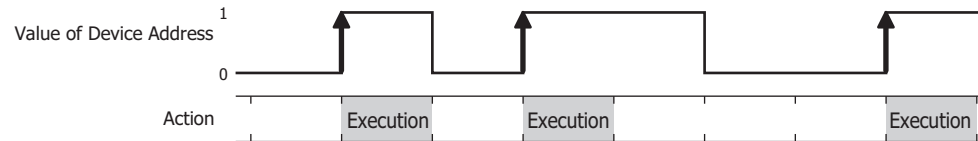

Falling-edge: A social media message is sent when the value of device address changes from 1 to 0.

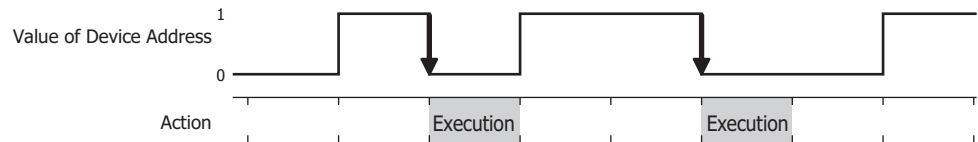

Satisfy the condition:

A social media message is sent when the condition changes from not satisfied to satisfied.

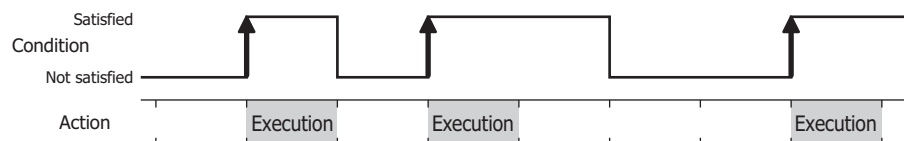

Data Type: Select the data type handled by the conditional expression.

Can only be set if **Satisfy the condition** is selected as **Trigger Type**.

For details, refer to Chapter 2 "1.1 Available Data" on page 2-1.

Device Address: Specifies the bit device or the bit number of the word device to serve as condition. You can only specify the internal device.

Can only be set if **Rising-edge** or **Falling-edge** is selected as **Trigger Type**. Click to display the Tag Editor. For the device address configuration procedure, refer to Chapter 2 "5.1 Device Address Settings" on page 2-70.

Condition: Sets the condition formula.

Can only be set if **Satisfy the condition** is selected as **Trigger Type**. Click to display the Trigger Condition Settings dialog box. For the conditional expressions configuration procedure, refer to Chapter 2 "5.2 Setting Conditional Expressions" on page 2-73.

■ Social Media content

Specify the Twitter account sending destination, and enter the social media message.

Account: Specify the Twitter account sending destination of the social media message. Click this button to display the Social Media Account Manager. For details, refer to "Social Media Account Manager" on page 28-73.

(Twitter account): Displays the Twitter account assigned to the Account in the Social Media Account Manager.

(Message): Enter a social media message. The maximum number is 140 characters.

Attach Screenshot: Select this check box to attach a screenshot of the current screen to a social media message.

Insert Value of Device Address: Insert a device address in the body text of a social media message. Click this button to display the Insert Value of Device Address dialog box. For details, refer to "Insert Value of Device Address Dialog Box" on page 28-75.

● Social Media Account Manager

The Twitter account used by the social media function are collectively managed in the Social Media Account Manager.

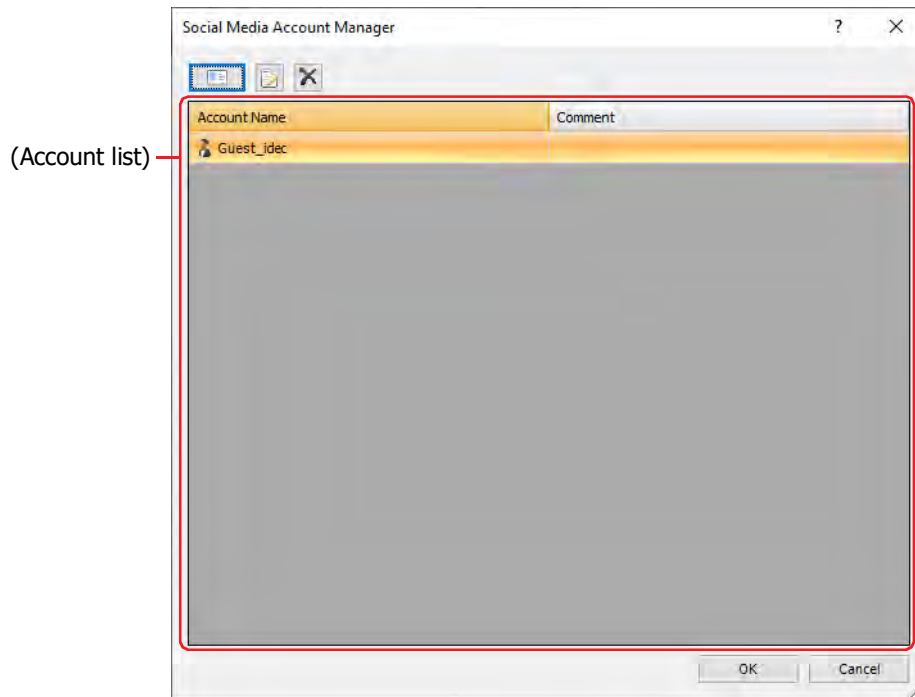

■ (New Twitter Account)

Adds a Twitter account. The maximum number of Twitter accounts that can be registered is 16.

Click this button to display the Twitter Account dialog box. For details, refer to "Twitter Account Dialog Box (New)" on page 28-74.

■ (Edit)

Changes the comment of the selected Twitter account.

Select a Twitter account in **Account**, and then click this button to display the **Twitter Account** dialog box. For details, refer to "Twitter Account Dialog Box (Edit)" on page 28-74.

■ (Delete)

Deletes the selected Twitter account in **Account**.

■ (Account List)

The registered Twitter accounts are displayed in a list.

Account: Displays the registered Twitter accounts.

Double clicking the cell of the Twitter account displays the Account dialog box. For details, refer to "Twitter Account Dialog Box (New)" on page 28-74.

Comment: Displays the comment for the Twitter account.

Double clicking the cell of the Twitter account displays the Account dialog box. For details, refer to "Twitter Account Dialog Box (Edit)" on page 28-74.

Twitter Account Dialog Box (New)

To register a Twitter account, click  (New) in Social Media Account Manager. In the displayed Twitter Account dialog box, authenticate your Twitter account and link it with the social media function.

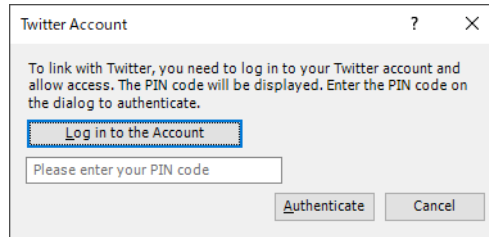

- **Log in to the Account**

Click this button to start a web browser and display the login screen for your Twitter account.

When you log in to the Twitter account to which you want to send social media messages, the PIN code (7-digit number) used for authentication is displayed.

- **(Please enter your PIN code)**

Enter the PIN code that you obtained by logging in to your Twitter account.

- **Authenticate**

Authenticate your Twitter account and PIN code. Once authenticated, your Twitter account and the social media function will be linked and you can send social media messages.

Twitter Account Dialog Box (Edit)

To change the comments of a registered Twitter account, click  (Edit) in Social Media Account Manager or double-click a cell of the account.

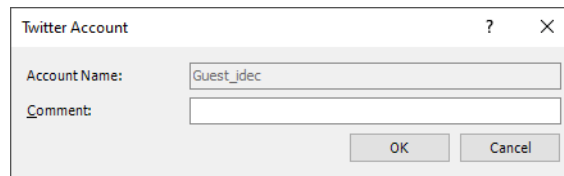

- **Account Name**

Displays the comment for the linked Twitter account name.

- **Comment**

Enter a comment for the Twitter account. The maximum number is 80 characters.

● Insert Value of Device Address Dialog Box

To enter a value of device address in the body text of the social media message, configures the settings on the Insert Value of Device Address dialog box.

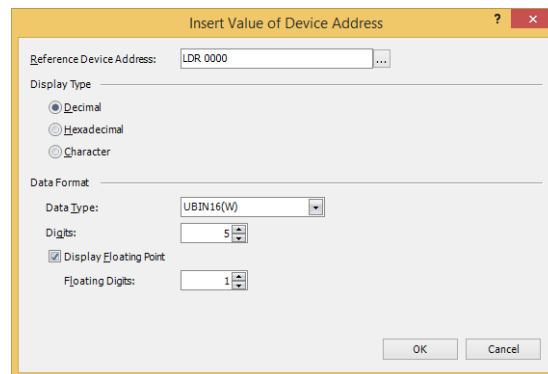

■ Reference Device Address

Specify the source word device.

Click  to display the Tag Editor. For the device address configuration procedure, refer to Chapter 2 "5.1 Device Address Settings" on page 2-70.

■ Display Type

Selects the display type of the value from the following.

Decimal, Hexadecimal, Character

■ Data Format

Data Type:

Selects the type of data for the value.

For details, refer to Chapter 2 "1.1 Available Data" on page 2-1.

This setting can only be configured when **Decimal** or **Hexadecimal** is selected for **Display Type**.

Digits:

Specifies the digits to display. The range of digits that can be set varies based on the display type and data type. The digits that can be set are as follows.

Display Type	Data Type	Digits
Decimal display	UBIN16(W), BIN16(I)	1 to 5
	UBIN32(D), BIN32(L)	1 to 10
	BCD4(B)	1 to 4
	BCD8(EB)	1 to 8
	Float32(F)	1 to 10
Hexadecimal display	UBIN16(W)	1 to 4
	UBIN32(D)	1 to 8

Display Floating Point:

Select this check box to display the decimal point.

This setting can only be configured when **Decimal** is selected for **Display Type**.



When the **Display Floating Point** check box is selected and **UBIN16(W)**, **BIN16(I)**, **UBIN32(D)**, **BIN32(L)**, **BCD4(B)**, or **BCD8(EB)** is selected for **Data Type**, the source device is an integer, but the value is displayed with the decimal point added at the configured floating digits.

Floating Digits:

Specifies the number of digits for the fractional part of the decimal value out of the number of digits specified by **Digits**.

This option can only be configured when the **Display Floating Point** check box is selected. The range of digits that can be set for the fractional part varies based on the display type and data type. The range of digits that can be set is as follows.

Display Type	Data Type	Floating Digits
Decimal display	UBIN16(W), BIN16(I)	1 to Digits
	UBIN32(D), BIN32(L)	1 to Digits
	BCD4(B)	1 to Digits
	BCD8(EB)	1 to Digits
	Float32(F)	1 to Digits or 8
Hexadecimal display	UBIN16(W)	--
	UBIN32(D)	--

- **Words**

Specify the number of source word devices (1 to 64).

This setting can only be configured when **Character** is selected for **Display Type**.

Chapter 29 Data Transfer Function

This chapter describes the project transfer function to upload and download project data to the MICRO/I, to upload and download PLC program to a PLC connected to the MICRO/I using an external memory device, as well as the function to copy files between external memories*¹.

These three functions for exchanging data using an external memory device are collectively called data transfer functions.

1 Project Transfer Function

HG2J-7U HG5G-V HG4G-V HG4G HG3G-V HG3G HG2G-V HG2G-5F HG2G-5T HG1G HG1P

1.1 What Can Be Done with the Project Transfer Function

The project transfer function uploads or downloads project (ZNV Project File) between the MICRO/I and an external memory device inserted in the MICRO/I.



The Project Transfer function supports the project which name is used alphanumeric characters only.

● Downloading the project (ZNV Project File)

Create a project (ZNV Project File) for project transfer and save it on an external memory device*². And then, download the ZNV Project File saved on the external memory device to the MICRO/I.

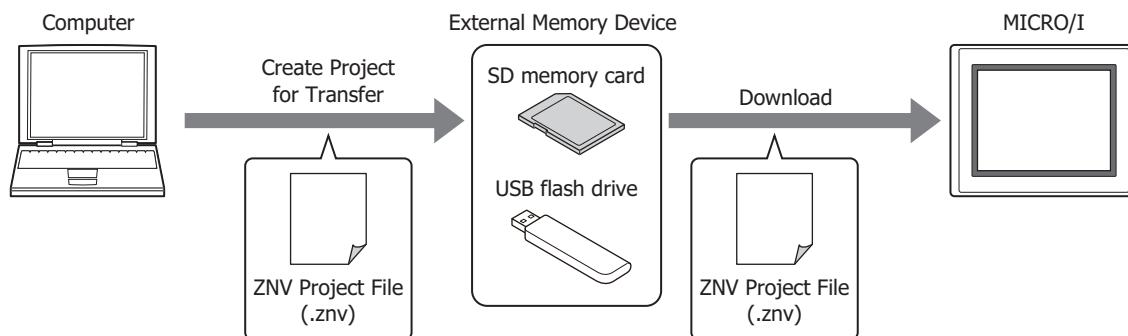

● Uploading a project

Uploads the project used to operate the MICRO/I and saves it to an external memory device*².

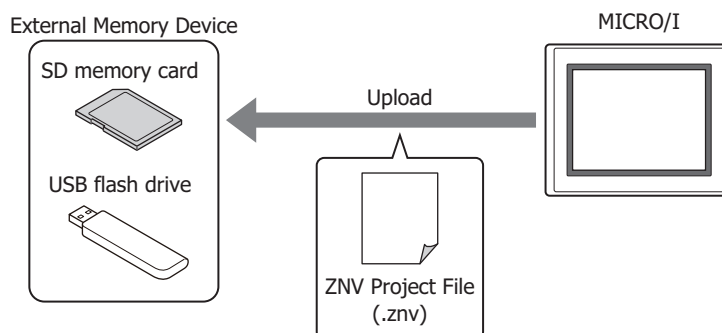

When using the project transfer function and a project is uploaded, the project name varies based on the model.

HG2J-7U: project.znv

HG5G/4G/3G/2G-V, HG4G/3G, HG2G-5F/-5T, HG1G/1P: "project name + file extension (.znv)".

*1 For HG2J-7U, between USB flash drives and in USB flash drive, for HG5G/4G/3G/2G-V, HG4G/3G and HG2G-5F, between SD memory card and USB memory, in SD memory card, in USB memory

*2 Only USB flash drive for HG2J-7U, HG2G-5T and HG1G/1P

1.2 Project Transfer Procedures

The following methods can be used to upload or download project between the MICRO/I and an external memory device inserted in the MICRO/I.

- Using the USB Autorun function

 For details, refer to Chapter 31 "2 USB Autorun Function" on page 31-19.

- Using Key Buttons, Multi-Buttons, or Multi-Commands

 For details, refer to "1.4 Using Key Buttons, Multi-Buttons, or Multi-Commands to Transfer Project Data" on page 29-6.

- Using the File Manager in the System Mode on the MICRO/I^{*1}

 For details, refer to "1.5 Using File Manager on the MICRO/I to Transfer Project Data" on page 29-7.

*1 HG5G/4G/3G/2G-V, HG4G/3G, HG2G-5F only

1.3 Converting Project for Transfer

Project must be converted to dedicated data for transfer in order to download project to the MICRO/I using the project transfer function.

Use the following procedure to create project data for transfer using an external memory device*1.



The Project Transfer function supports the project which name is used alphanumeric characters only.

- 1 Insert an external memory device*1 in the computer.

Insert an external memory device*1 into the USB port or memory card slot of your computer, or via a docking station, etc.

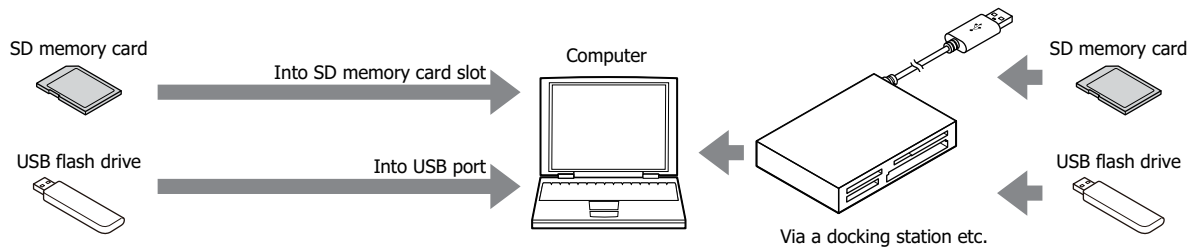

- 2 Open the project to transfer using WindO/I-NV4.



To use the Project Transfer function, select the project which name is used alphanumeric characters only.

- 3 On the **Home** tab, in the **Project** group, click the **Download** icon. The Download dialog box is displayed.

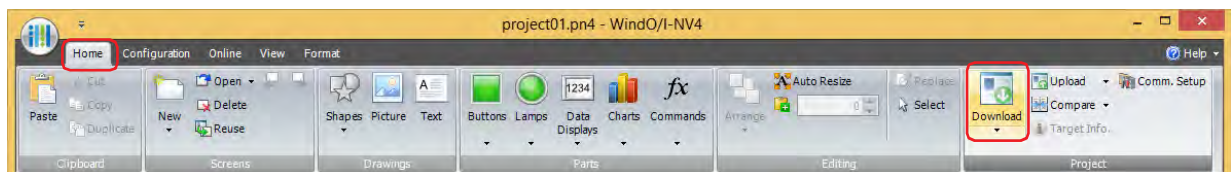

When the project has not been saved after it was opened, a save confirmation message is displayed. Click the **OK** button to save the project and display the Download dialog box. Click on the **Cancel** button to return to the editing screen without saving the project.

*1 Only USB flash drive for HG2J-7U, HG2G-5T and HG1G/1P

- 4 Check that **Communication Settings** is **External Memory Device**, and then click the **Download** button. The **Select Drive** dialog box is displayed.

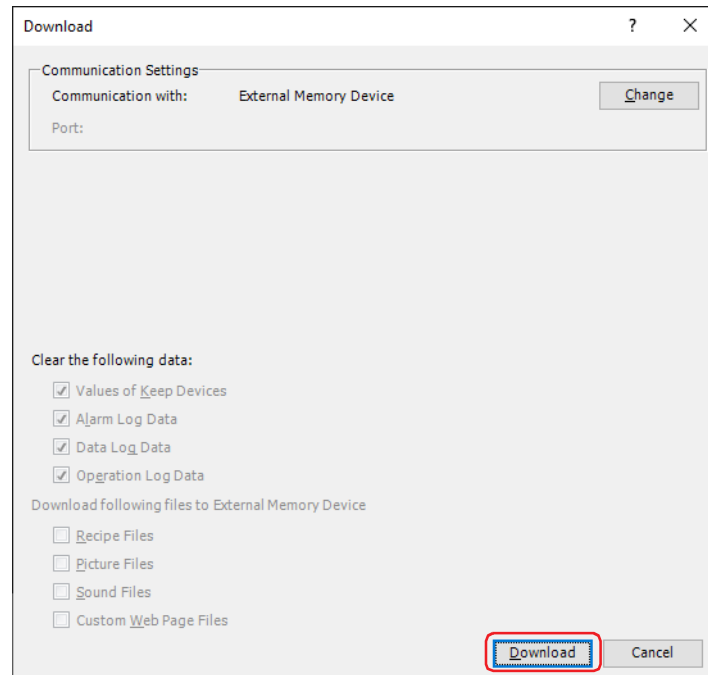

1. If **Communication Settings** is not **External Memory Device**, click the **Change** button. The Communication Settings dialog box is displayed.
2. Select **External Memory Device** for **Communicate with**, and then click the **OK** button.

- 5 Specify the drive for the external memory device and click the **OK** button. A confirmation message is displayed.

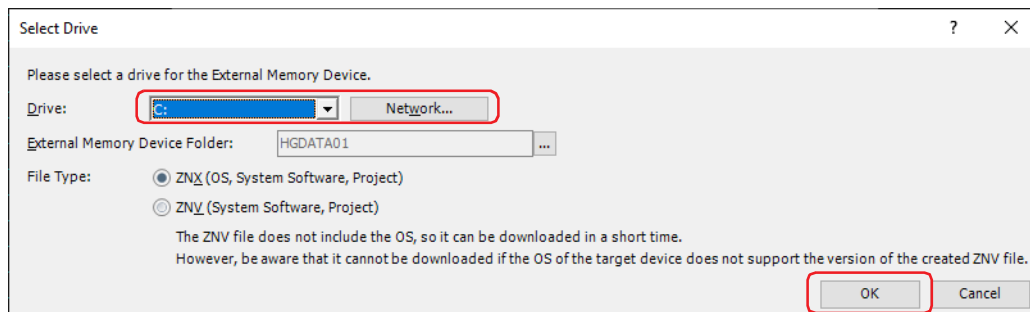

■ Drive

Specify the drive of the computer assigned to the external memory device.

■ Network

Displays the Network Drive Assignment dialog box. You can specify a drive on the network.

■ External Memory Device Folder

Specify the folder where the project data is to be downloaded.

Click the **...** button to display the Project Settings dialog box. You can specify an External Memory Device folder as the download destination.

■ File Type^{*1}

Specify the file format of the project data for transfer to be created.

ZNX (OS, System Software, Project): A file that contains the operating system, system software, and project data.

ZNV (System Software, Project): A file that contains the system software and project data.

*1 HG2J-7U only

6 Click the **Yes** button.

A Download dialog box is displayed and the project data is now being saved.
When this process is complete, a message is displayed.

7 Click the **OK** button.

8 Click the **Close** button in the Download dialog box.

The project data for transfer is created in the External Memory Device folder on an external memory device.



For details about the created data folder and file structure, refer to Chapter 31 "External Memory Devices" on page 31-1.



If the folder or file structure on the External Memory Device folder is modified, the MICRO/I and WindO/I-NV4 will not be usable.

1.4 Using Key Buttons, Multi-Buttons, or Multi-Commands to Transfer Project Data



Allocate a Key Button, Multi-Button, or Multi-Command configured with the project transfer function to the MICRO/I.

☞ For details, refer to Chapter 8 "5 Key Button" on page 8-72.

☞ For details, refer to Chapter 8 "6 Multi-Button" on page 8-110.

☞ For details, refer to Chapter 12 "6 Multi-Command" on page 12-38.

● Download

- 1 Create a project (ZNV Project File) for project transfer and save it on an external memory device*1.
For details, refer to "1.3 Converting Project for Transfer" on page 29-3.
- 2 Insert an external memory device*1 in the MICRO/I.

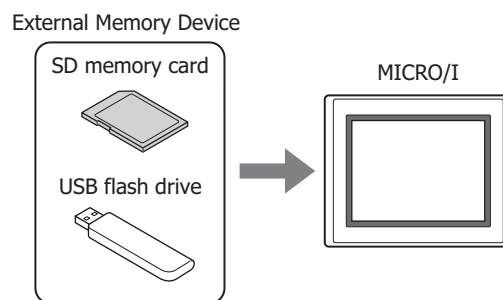

- 3 Press the Key Button or Multi-Button or execute the Multi-Command configured with **Download Project** under **Data Transfer** on the Key Browser.

● Upload

- 1 Insert an external memory device*1 in the MICRO/I.

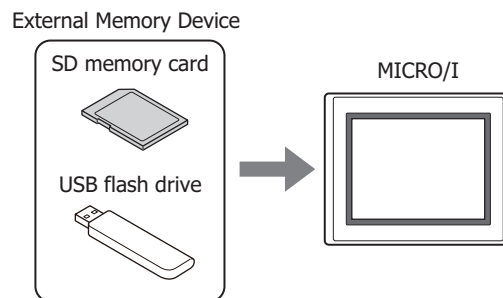

- 2 Press the Key Button or Multi-Button or execute the Multi-Command configured with **Upload Project** under **Data Transfer** on the Key Browser.

*1 Only USB flash drive for HG2J-7U, HG2G-5T and HG1G/1P

1.5 Using File Manager on the MICRO/I to Transfer Project Data

HG2J-7U HG5G-V HG4G-V HG4G HG3G-V HG3G HG2G-V HG2G-5F HG2G-5T HG1G HG1P

● Download

- 1 Create a project (ZNV Project File) for project transfer and save it on an external memory device.
For details, refer to "1.3 Converting Project for Transfer" on page 29-3.
- 2 Insert an external memory device in the MICRO/I.

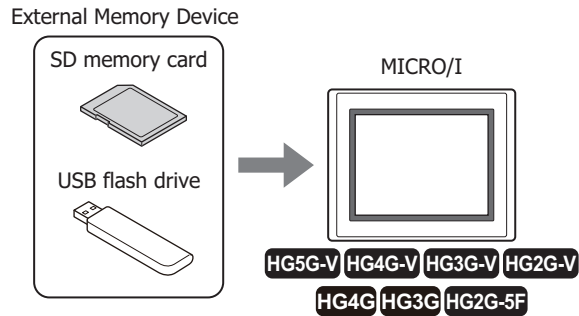

- 3 Press the upper-left edge of the MICRO/I screen for three seconds or more.
The maintenance screen is now displayed.

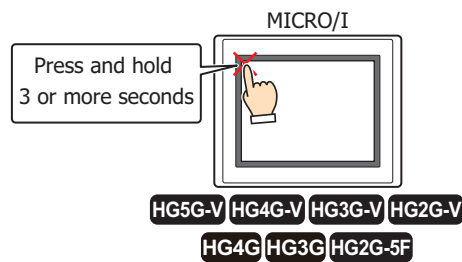

- 4 Press **System Mode**.
MICRO/I displays the Top Page in the System Mode.

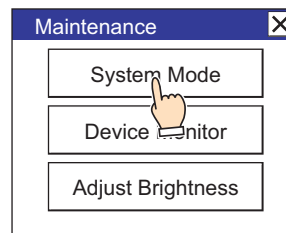

When downloading a project configured with security to the MICRO/I, the password screen is displayed. Select a user name and enter its password. For details, refer to Chapter 23 "User Accounts and the Security Function" on page 23-1.

5 Press Main Menu.

The main menu is displayed.

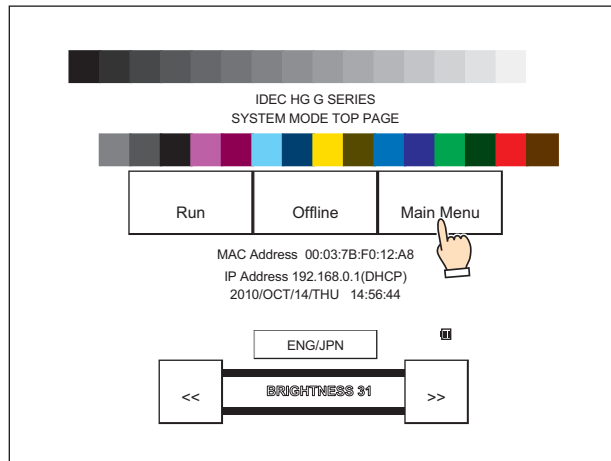

6 Press File Manager.

The file manager is displayed.

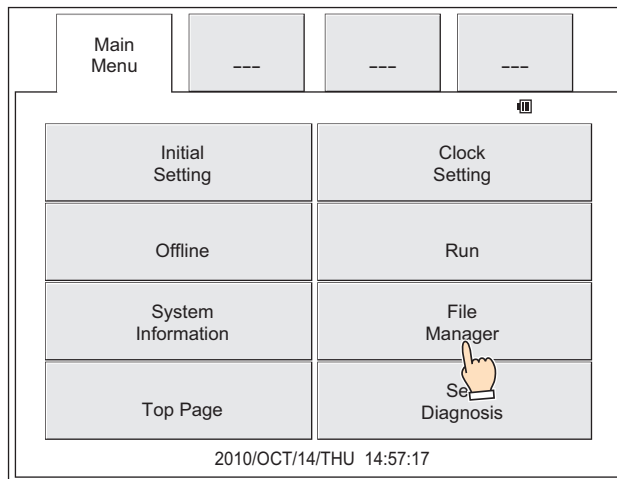

7 Press DRIVE: for the transfer source and select the external memory device inserted in the MICRO/I.

This example screen shows when an SD memory card is selected.

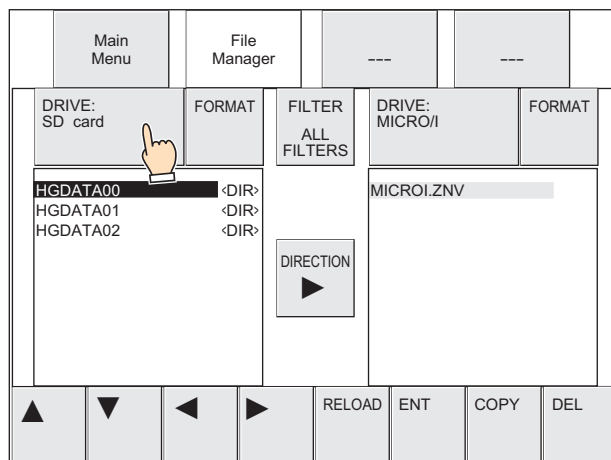

8 Select the ZNV Project File to download.

This example screen shows when the ZNV Project File is "HG3G_DEMO_1.ZNV" that has been saved in the External Memory Device folder "HGDATA01".

1. Press ▼ to select **HGDATA01** and then press **ENT**.

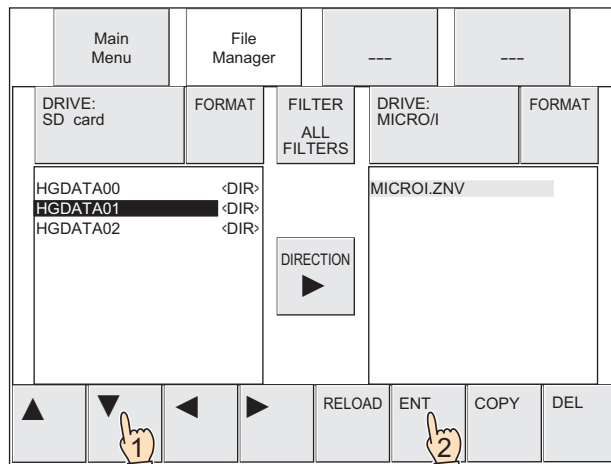

2. Press ▼ to select **NVDATA** and then press **ENT**.

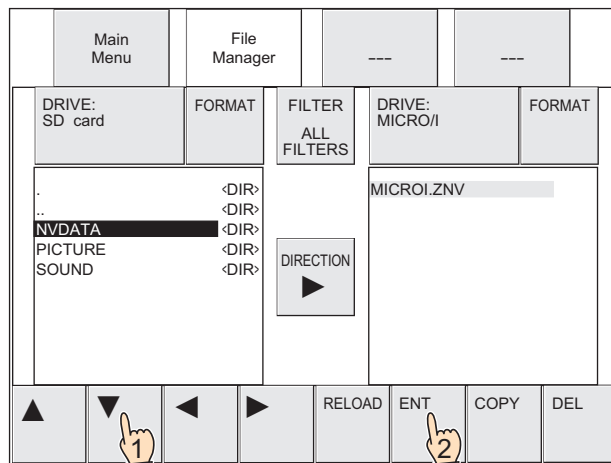

The **NVDATA** folder is automatically created when the External Memory Device folder is created. For details, refer to Chapter 31 "1.4 File structure" on page 31-3.

3. Press ▼ to select **HG3G_DEMO_1.ZNV**.

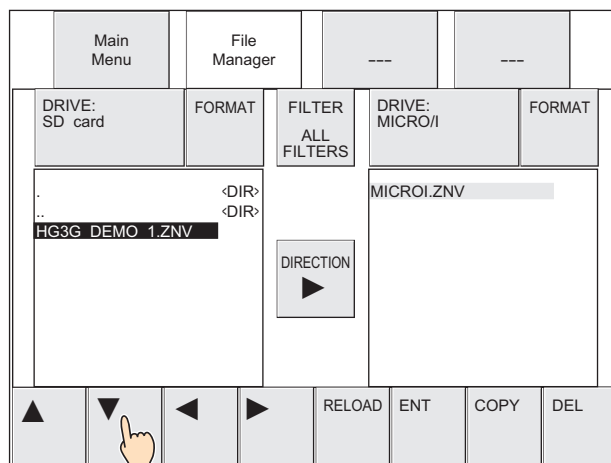

9 Press **DRIVE:** for the transfer destination and select **MICRO/I**.

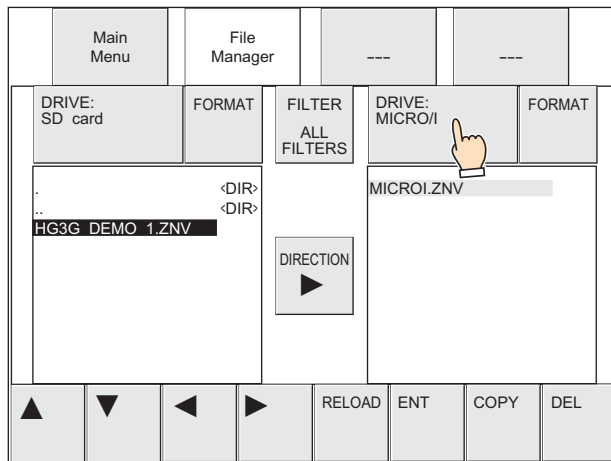

When **MICRO/I** is selected with **DRIVE:** in the file manager, **MICROI.ZNV** is always displayed. This is not the project name downloaded to the MICRO/I.

10 Press **COPY**.
A process confirmation message is displayed.

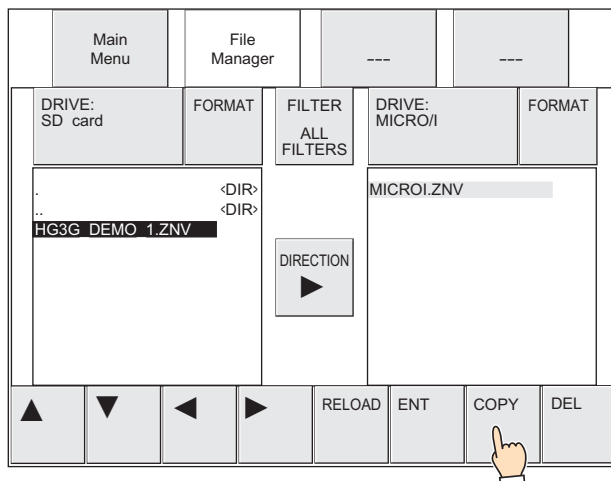

11 Press **YES**.
ZNV Project File(.znv) download starts.
When the download finishes, the results are displayed.

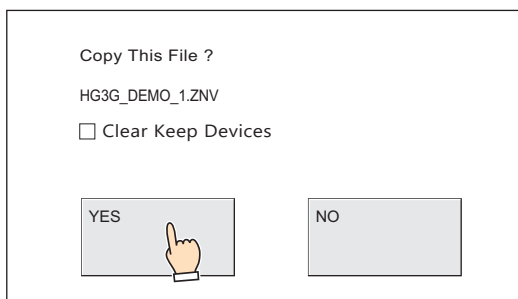

Select the **Clear Keep Devices** check box to clear keep devices after the project data is downloaded. However, when project data that changes the system software or settings of the data storage area is downloaded, the keep devices are always cleared.



If you download the project data, Alarm Log data, Operation Log data, and Data Log data is erased regardless of the **Clear Keep Devices** check box.



When the ZNV Project File to download is configured with security, the password screen is displayed. Select a user name and enter its password. For details, refer to Chapter 23 "User Accounts and the Security Function" on page 23-1.

- 12 Press **Ack** to close the results screen.
You are returned to the Top Page of System Mode.

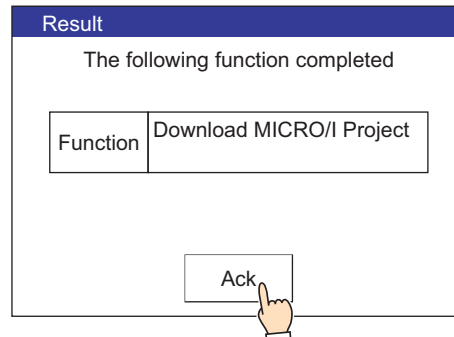

● Upload

- 1 Insert the external memory device in the MICRO/I.

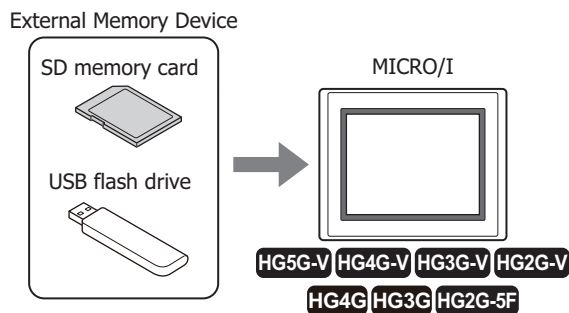

- 2 Press the upper-left edge and the upper-right edge of the MICRO/I screen simultaneously.
The maintenance screen is displayed.

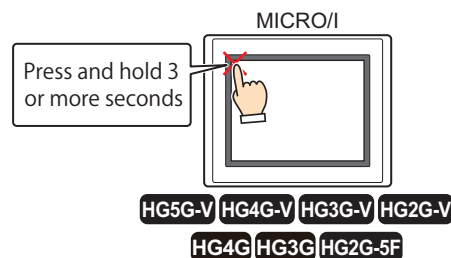

- 3 Press **System Mode**.
MICRO/I displays the Top Page in the System Mode.

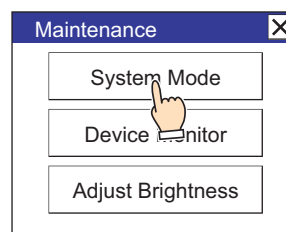

When downloading a project configured with security to the MICRO/I, the password screen is displayed. Select a user name and enter its password. For details, refer to Chapter 23 "User Accounts and the Security Function" on page 23-1.

4 Press **Main Menu**.

The main menu is displayed.

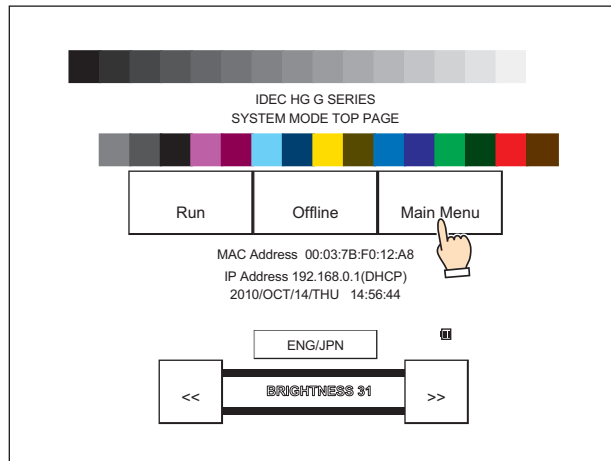

5 Press **File Manager**.

The file manager is displayed.

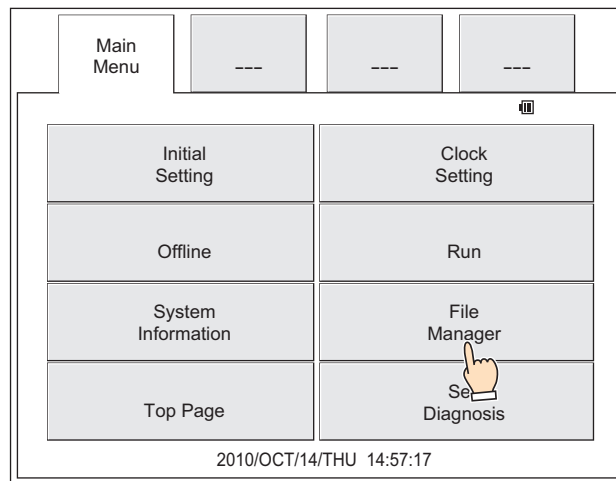

6 Press **DRIVE:** for the transfer source and select **MICRO/I**.

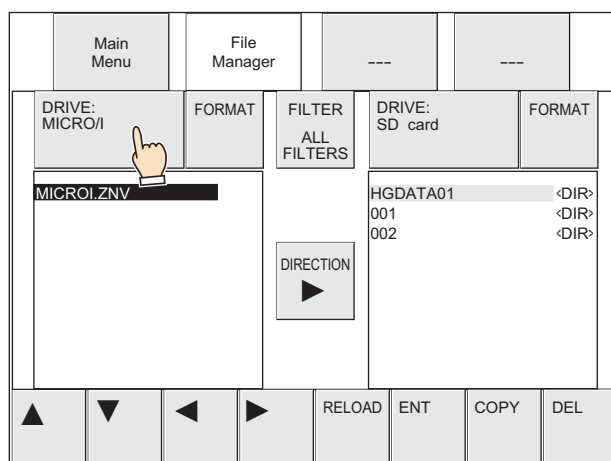

When **MICRO/I** is selected with **DRIVE:** in the file manager, **MICROI.ZNV** is always displayed. This is not the project name downloaded to the MICRO/I.

- 7 Press **DRIVE:** for the transfer destination and select the external memory device inserted in the MICRO/I.
This example screen shows when an SD memory card is selected.

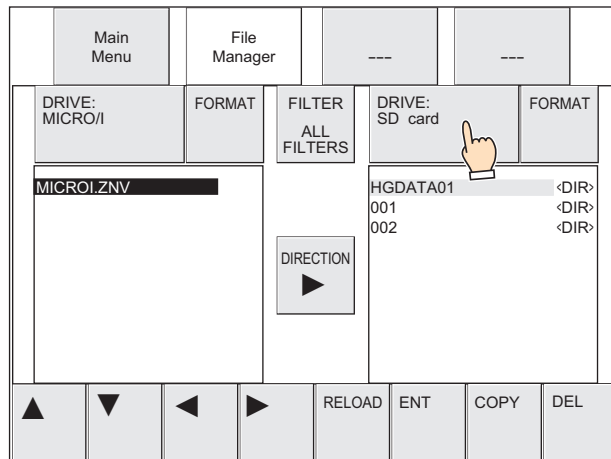

- 8 Select the save destination for the project to upload.
Folder (001) is selected in this example.

1. Press ► to move the cursor to the transfer destination on the SD memory card.

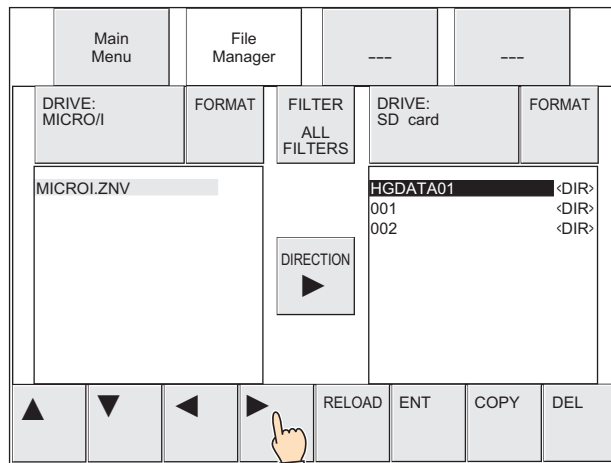

2. Press ▼ to select **001** and then press **ENT**.

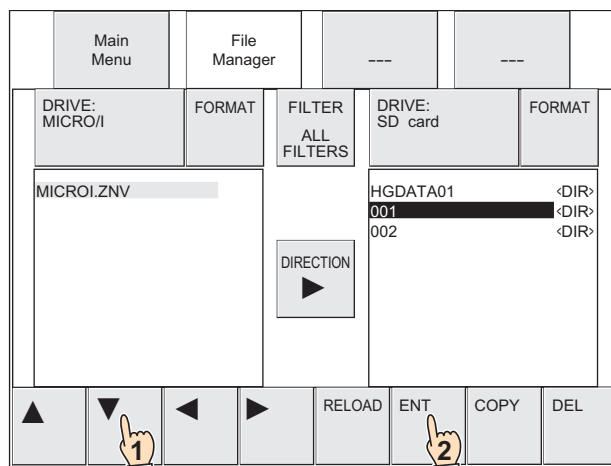

9 Press **COPY**.

A process confirmation message is displayed.

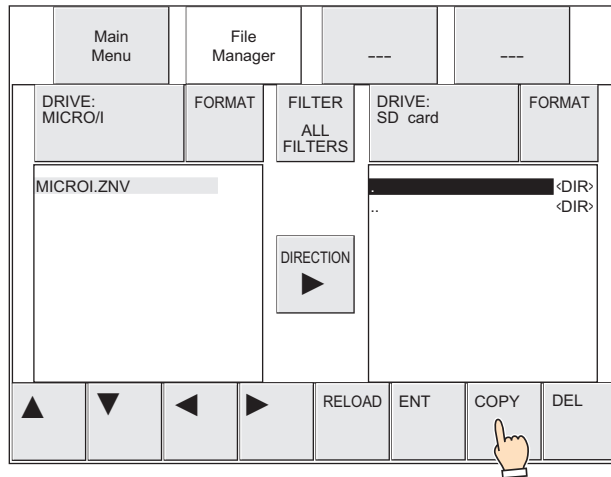

10 Press **YES**.

The project upload starts.

When the upload finishes, the results are displayed.

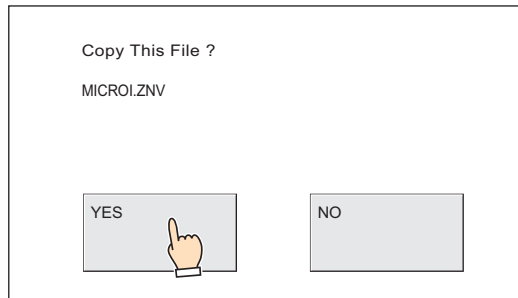

MICROI.ZNV is shown on the confirmation message, but the project file name after uploading is "Project name + Extension (.znv)".

11 Press **Ack** to close the results screen.

You are returned to the Top Page of System Mode.

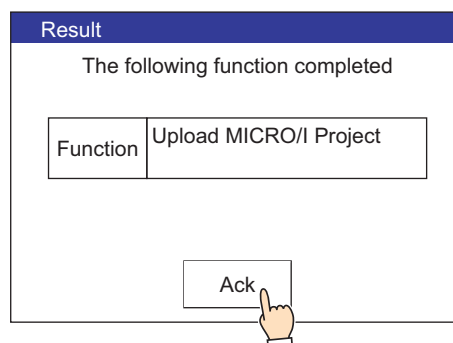

1.6 Precautions

- An error message is displayed if the project upload or download fails.
For details, refer to Chapter 36 "1.1 Errors Displayed on the Screen" on page 36-1.
- While the project transfer function is running, the MICRO/I stops processing other functions.
- If a file exists with the same name in the save destination when uploading a project, the file is overwritten with the uploaded file without displaying an overwrite confirmation message.
- When using the project transfer function, make the project name alphanumeric characters. Note, the file name must not contain the following characters:
" * / : < > ? \ |
- While running the project transfer function using a Key Button, Multi-Button, or Multi-Command, if a data transfer function (project transfer, PLC program transfer, or file copy) is initiated, the only function that will work is the currently running function. If two or more data transfer functions are configured to a Multi-Button or Multi-Command, only the data transfer function displayed at the top of the function list on the parts property dialog box will run.
- When running the project transfer function, the external memory device must have enough free space equivalent to the size of the ZNV Project File(.znv). Check that there is sufficient free space on the external memory device that will be used with the project transfer function. If the device does not have sufficient free space, the project upload or download may fail.

2 PLC Program Transfer Function

HG2J-7U HG5G-V HG4G-V HG4G HG3G-V HG3G HG2G-V HG2G-5F HG2G-5T HG1G HG1P

2.1 Supported PLCs

PLCs that support the PLC program transfer function are listed below.

Manufacturer	Series name	Supported system (CPU unit)	Communication driver
IDEC	OpenNet Controller	FC3A	<ul style="list-style-type: none"> Serial Interface: OpenNet, MICROSmart, SmartAXIS Pro/Lite (RS232C/485) Ethernet Interface: OpenNet, MICROSmart, SmartAXIS Pro/Lite (Ethernet)
		FC4A	
	MICROSmart	FC5A	<ul style="list-style-type: none"> Serial Interface: MICROSmart(FC6A)(RS232C/485) Ethernet Interface: MICROSmart(FC6A)(Ethernet)
		FC6A (FC6A-C****E/-C****EJ only)	
		FC6A (FC6A-D****CEE only)	
	SmartAXIS Pro/Lite	FT1A	OpenNet, MICROSmart, SmartAXIS Pro/Lite (Ethernet)



The corresponding device type differs depending on the communication driver which be used.

For FC6A type, please select **MICROSmart (FC6A) (RS232C / 485)**, **MICROSmart (FC6A) (Ethernet)** driver.

If use **OpenNet, MICROSmart, SmartAXIS Pro / Lite (RS232C485)**, **OpenNet, MICROSmart, SmartAXIS Pro / Lite (Ethernet)** driver, the device type is partially different. For details, refer to the WindO/I-NV4 External Device Setup Manual.

The ports and functions supported are as follows.

Series Name	Model	Serial port	Download, Upload*1
OpenNet Controller	FC3A	Serial port 1	YES
		Serial port 2	YES
MICROSmart	FC4A	Serial port 1	YES
		Serial port 2	YES
	FC5A	Ethernet port	YES
		Serial port 1	YES
		Serial port 2	YES
	FC6A (FC6A-C****E/-C****EJ only)	Serial port 3 to 7	NO
		Ethernet port 1	YES
		FC6A-PH1 (HMI-Ethernet port)	YES
		Serial port 1	YES
	FC6A (FC6A-D****CEE only)	Serial port 2 to 9	NO
		Ethernet port 1	YES
		Ethernet port 2	YES
FC6A-PH1 (HMI-Ethernet port)		YES	
SmartAXIS Pro/Lite	FT1A	Serial port 1 to 33	NO
		Ethernet port	YES
		Serial port 2	NO
		Serial port 3	NO

*1 User program only

2.2 What Can Be Done using the PLC Program Transfer Function

The PLC program transfer function is used to upload or download PLC program (ZLD Project File) between a PLC connected to the MICRO/I and an external memory device inserted in the MICRO/I.

● Downloading a PLC program

Download a PLC program (ZLD Project File) saved on an external memory device^{*1} to a PLC connected to the MICRO/I. You must create a ZLD Project File(.zld) for transfer.

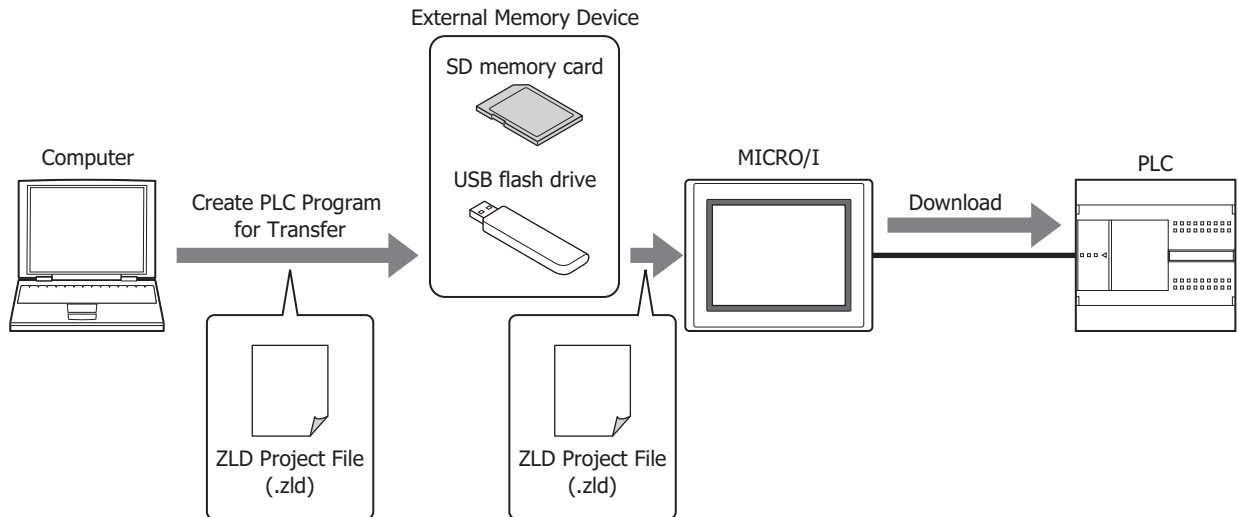

● Uploading a PLC program

Upload a PLC program from the PLC connected to the MICRO/I and save the ZLD Project File(.zld) to an external memory device^{*1}.

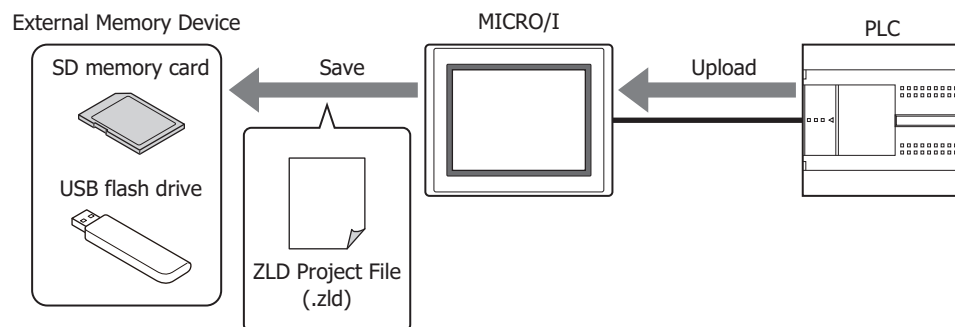

When a PLC program is uploaded using the PLC program transfer function, the file name is "Model name_Port number_Station number_Year month day hours minutes seconds + File extension (.zld)". The port number varies based on the interface used to upload with HG2G-5T, HG1G/1P. The displayed item is as follows:

SERIAL1(RS232C): C1

SERIAL1(RS422/485): C2

Ethernet: ET

2.3 PLC Program Transfer Procedures

The following methods can be used to upload or download a PLC program between a PLC connected to the MICRO/I and an external memory device inserted in the MICRO/I.

- Using the USB Autorun function

☞ For details, refer to Chapter 31 "2 USB Autorun Function" on page 31-19.

- Using Key Buttons, Multi-Buttons, or Multi-Commands

☞ For details, refer to "2.5 Using Key Buttons, Multi-Buttons, or Multi-Commands to Transfer PLC Programs" on page 29-19.

- Using the File Manager in the System Mode on the MICRO/I^{*2}

☞ For details, refer to "2.6 Using File Manager on the MICRO/I to Transfer PLC Programs" on page 29-21.

*1 Only USB flash drive for HG2J-7U, HG2G-5T and HG1G/1P

*2 HG5G/4G/3G/2G-V, HG4G/3G, HG2G-5F only

2.4 Creating ZLD Project File

Before transferring a PLC program, using the PLC Program Transfer Function, it must be converted to a ZLD Project File(.zld).

- 1 Open the PLC program to to be transferred using WindLDR.
- 2 Click ► to the right of **Save As** on the application menu and click **PLC Program**.
The Save As dialog box is displayed.

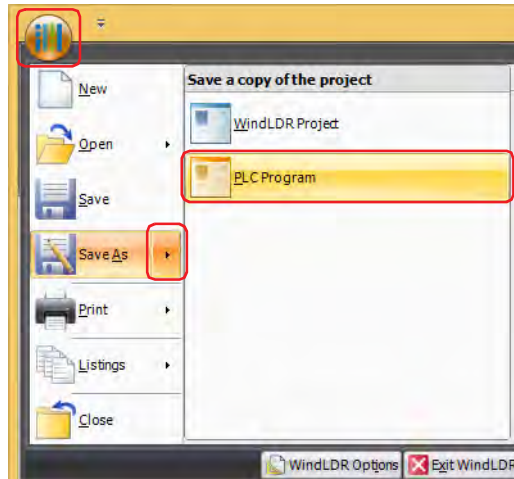

- 3 Enter a file name and click **Save**.

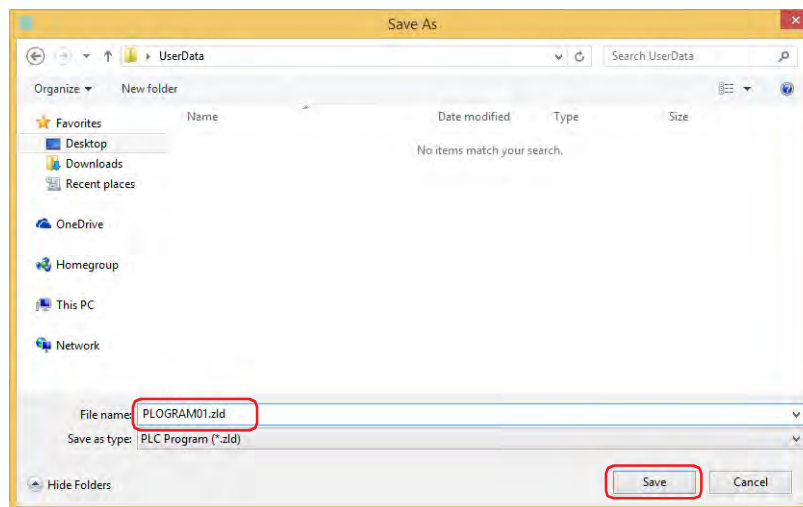

When using a PLC program with the PLC program transfer function, always enter the file name as alphanumeric characters.

2.5 Using Key Buttons, Multi-Buttons, or Multi-Commands to Transfer PLC Programs



Allocate a Key Button, Multi-Button, or Multi-Command configured with the PLC program transfer function to the MICRO/I.

- ☞ For details, refer to Chapter 8 "5 Key Button" on page 8-72.
- ☞ For details, refer to Chapter 8 "6 Multi-Button" on page 8-110.
- ☞ For details, refer to Chapter 12 "6 Multi-Command" on page 12-38.

● Download

- 1 Convert a PLC program file for PLC program transfer.
For details, refer to "2.4 Creating ZLD Project File" on page 29-18.
- 2 Save it to an external memory device*1.

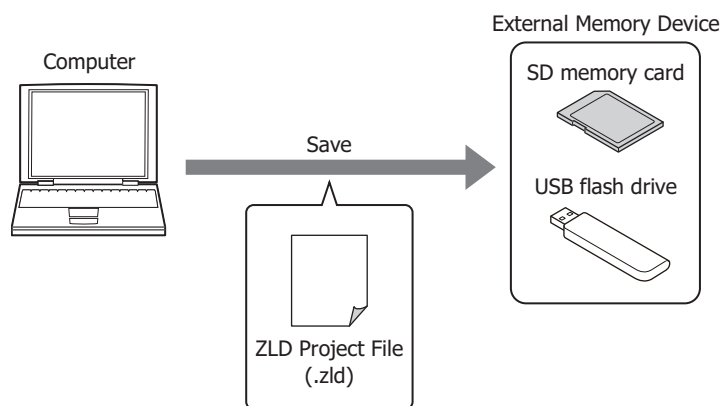

- 3 Insert an external memory device*1 in the MICRO/I.

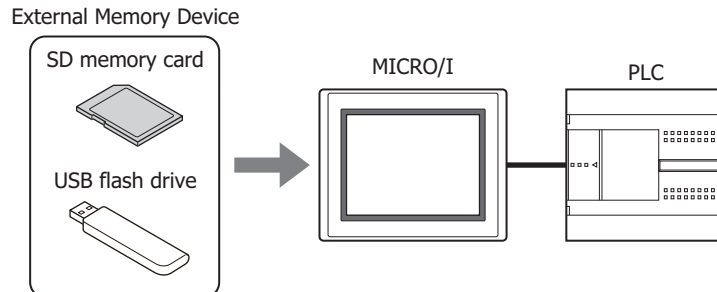

- 4 Press the Key Button or Multi-Button or execute the Multi-Command configured with **Download PLC Program** under **Data Transfer** on the Key Browser.

*1 Only USB flash drive for HG2J-7U, HG2G-5T and HG1G/1P

● Upload

- 1 Insert an external memory device*1 in the MICRO/I.

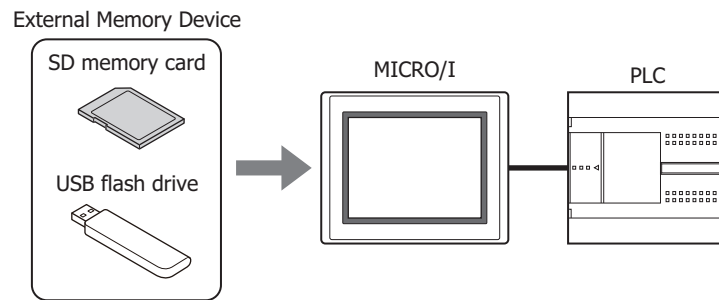

- 2 Press the Key Button or Multi-Button or execute the Multi-Command configured with **Upload PLC Program** under **Data Transfer** on the Key Browser.

*1 Only USB flash drive for HG2J-7U, HG2G-5T and HG1G/1P

2.6 Using File Manager on the MICRO/I to Transfer PLC Programs

HG2J-7U HG5G-V HG4G-V HG4G HG3G-V HG3G HG2G-V HG2G-5F HG2G-5T HG1G HG1P

● Download

- 1 Convert a PLC program file for PLC program transfer.
For details, refer to "2.4 Creating ZLD Project File" on page 29-18.
- 2 Save it to an external memory device.

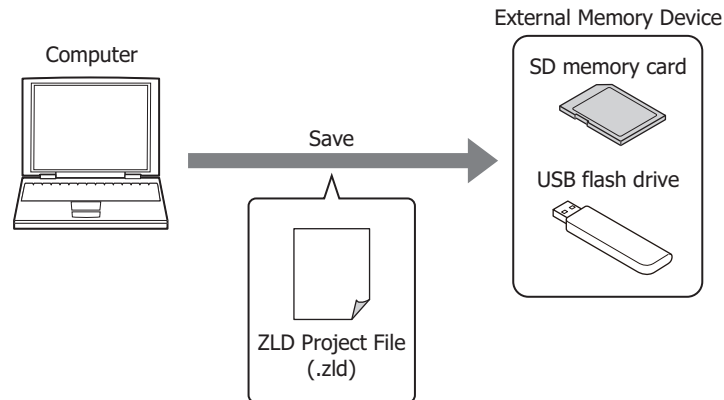

- 3 Insert an external memory device in the MICRO/I.

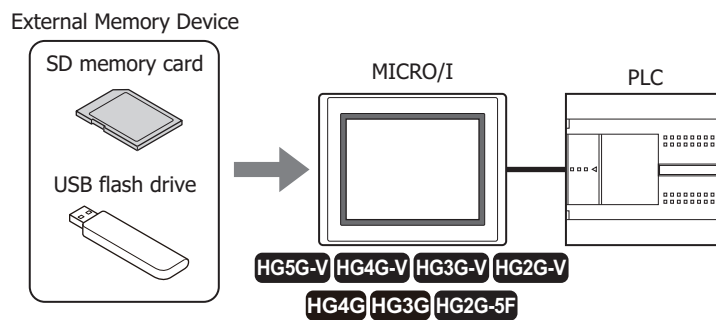

- 4 Press the upper-left edge of the MICRO/I screen for three seconds or more.
The maintenance screen is displayed.

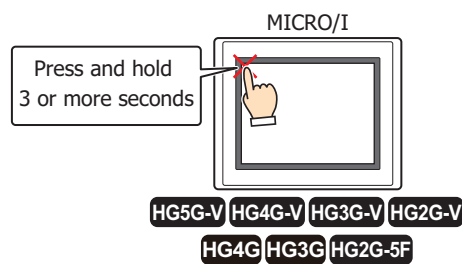

5 Press System Mode.

MICRO/I displays the Top Page in the System Mode.

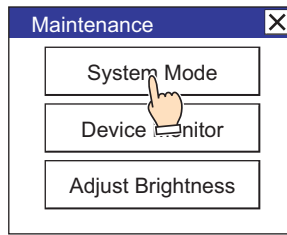

When downloading a project configured with security to the MICRO/I, the password screen is displayed. Select a user name and enter its password. For details, refer to Chapter 23 "User Accounts and the Security Function" on page 23-1.

6 Press Main Menu.

The main menu is displayed.

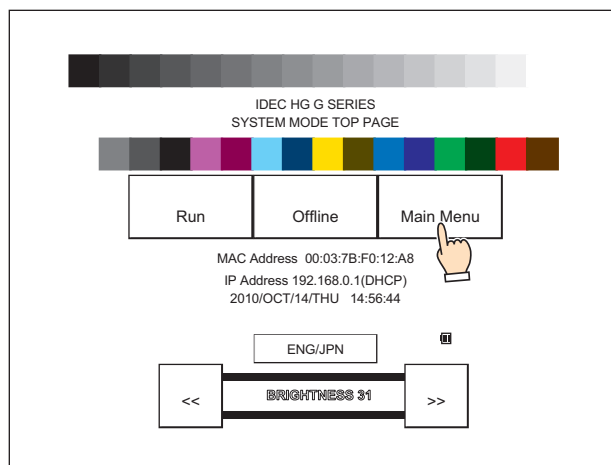

7 Press File Manager.

The file manager is displayed.

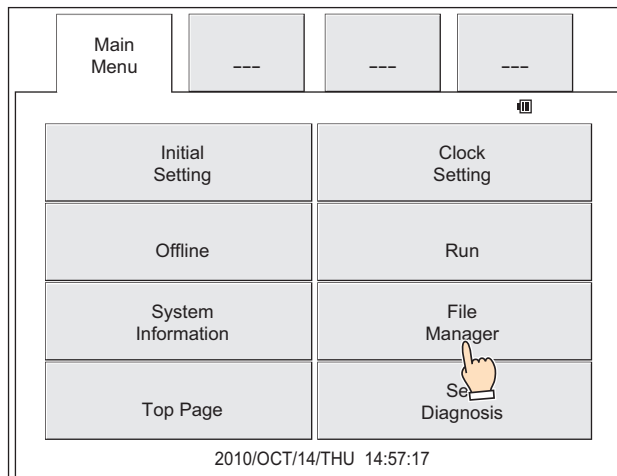

- 8 Press **DRIVE:** for the transfer source and select the external memory device inserted in the MICRO/I.

This example screen shows when an SD memory card is selected.

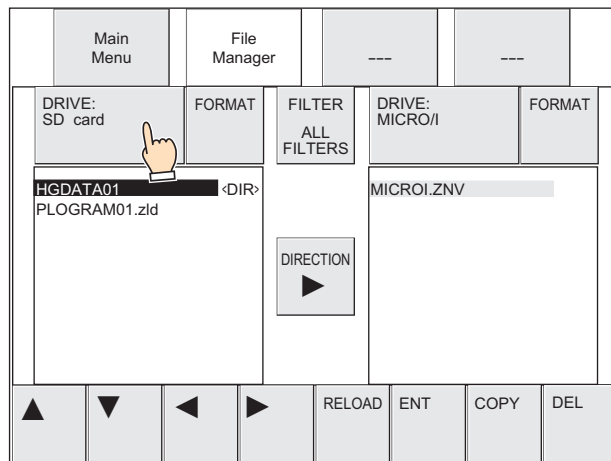

- 9 Select the ZLD Project File to download.

This example screen shows when the ZLD Project File is "PLOGRAM01.ZLD".

Press ▼ to select "PLOGRAM01.ZLD".

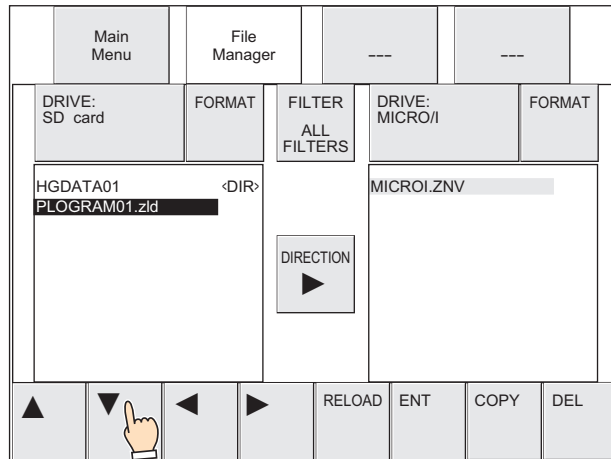

- 10 Press **DRIVE:** for the transfer destination and select **PLC**.

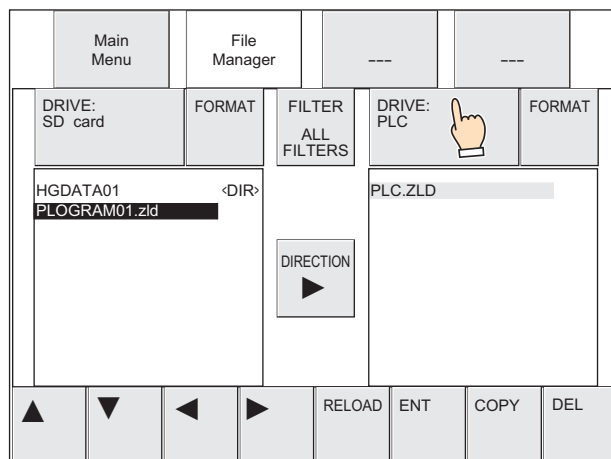

When **PLC** is selected with **DRIVE:** in the file manager, "PLC.ZLD" is always displayed. This is not the program file name for the PLC connected to the MICRO/I.

11 Press **COPY**.

A process confirmation message is displayed.

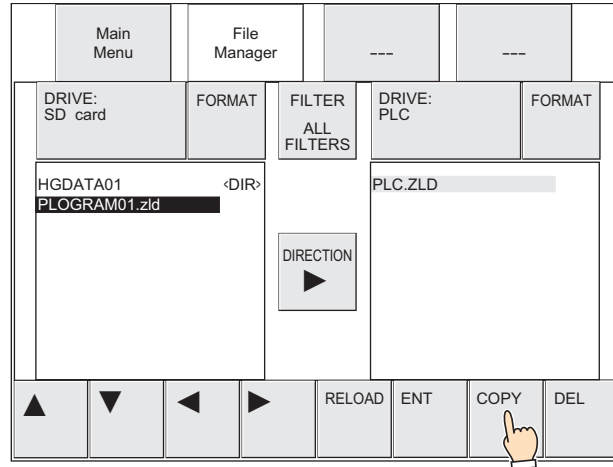

12 Specify the MICRO/I communication port and the slave number or the External Device ID, and then press **YES**. Specify the Slave Number when selecting serial interface as the MICRO/I communication port, and specify the External Device ID when selecting Ethernet interface. The ZLD Project File download starts.

When the download finishes, the results are displayed.

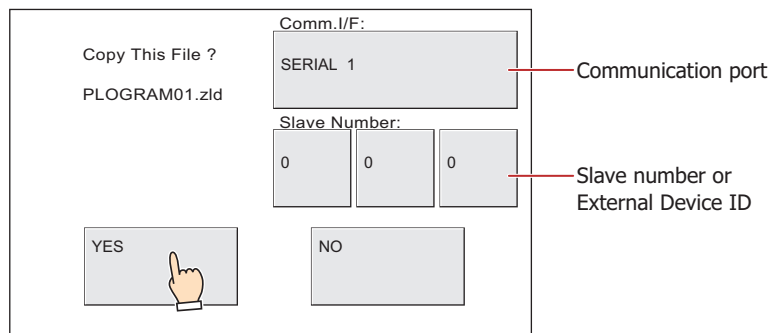

When downloading a ZLD Project File to a PLC configured with a password, the PLC password screen is displayed. Enter the password.

13 Press **Ack** to close the results screen.

You are returned to the Top Page of System Mode.

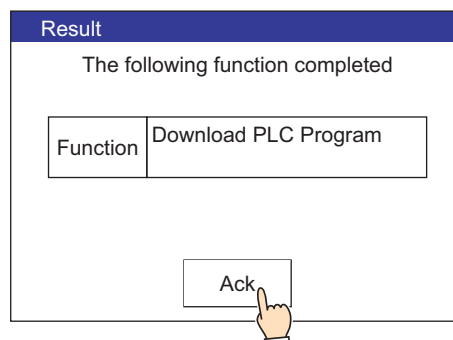

● Upload

- 1 Insert an external memory device in the MICRO/I.

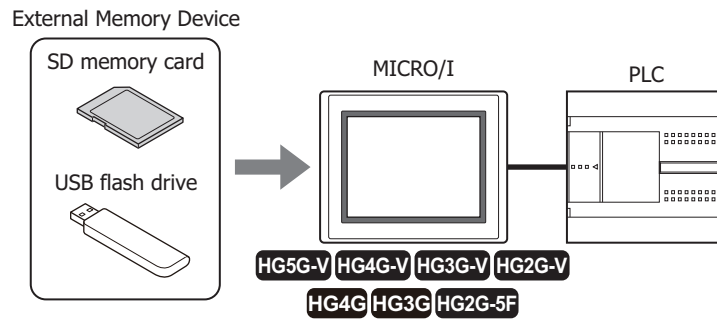

- 2 Press the upper-left edge of the MICRO/I screen for three seconds or more.
The maintenance screen is displayed.

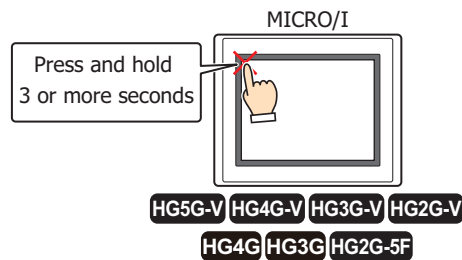

- 3 Press **System Mode**.

MICRO/I displays the Top Page in the System Mode.

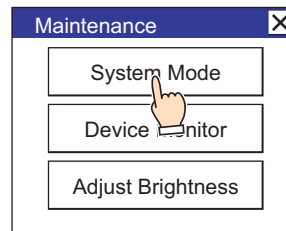

When downloading a project configured with security to the MICRO/I, the password screen is displayed. Select a user name and enter its password. For details, refer to Chapter 23 "User Accounts and the Security Function" on page 23-1.

- 4 Press **Main Menu**.

The main menu is displayed.

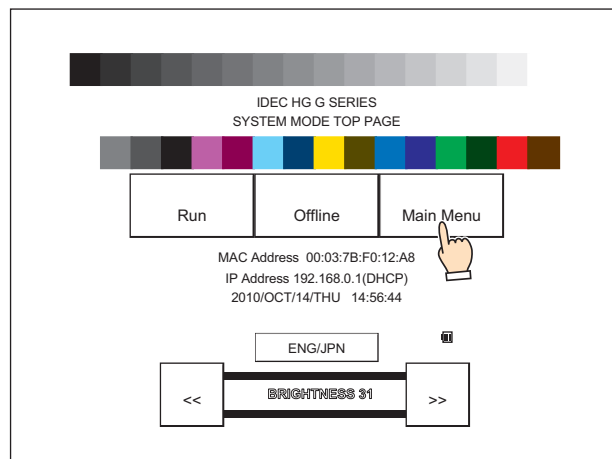

5 Press File Manager.

The file manager is displayed.

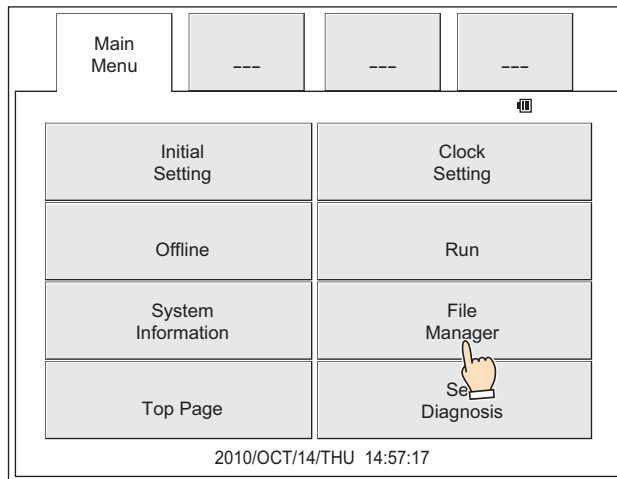

6 Press DRIVE: for the transfer source and select PLC.

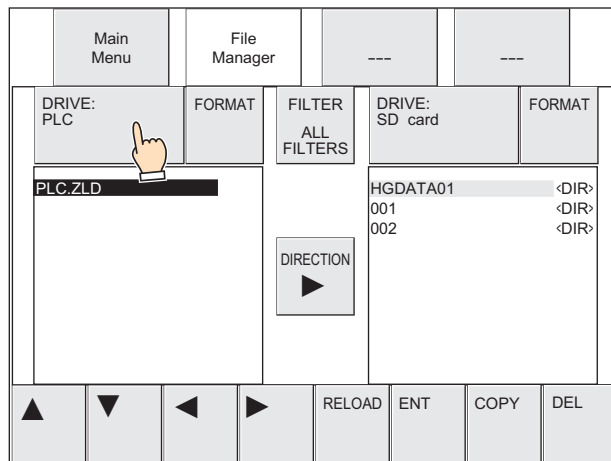

When **PLC** is selected with **DRIVE:** in the file manager, "PLC.ZLD" is always displayed. This is not the program file name for the PLC connected to the MICRO/I.

7 Press DRIVE: for the transfer destination and select the external memory device inserted in the MICRO/I.

This example screen shows when an SD memory card is selected.

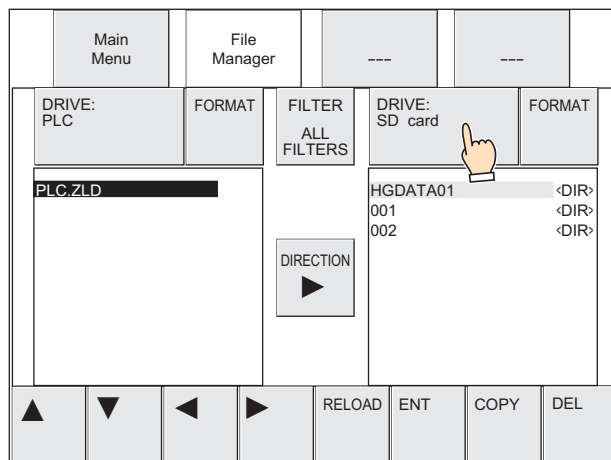

8 Select the save destination for the PLC program to upload.

Folder (001) is selected in this example.

1. Press **▶** to move the cursor to the transfer destination on the SD memory card.

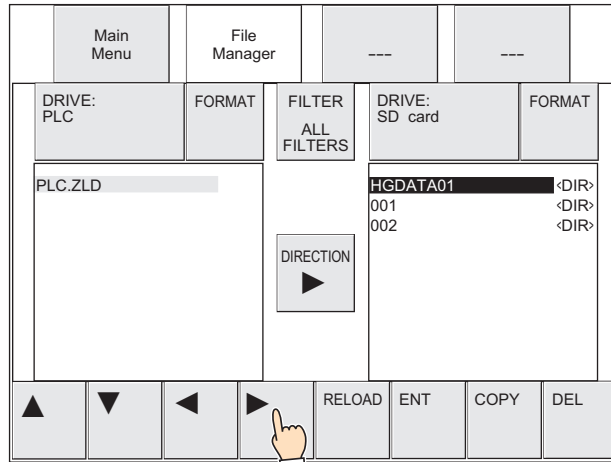

2. Press **▼** to select "001" and then press **ENT**.

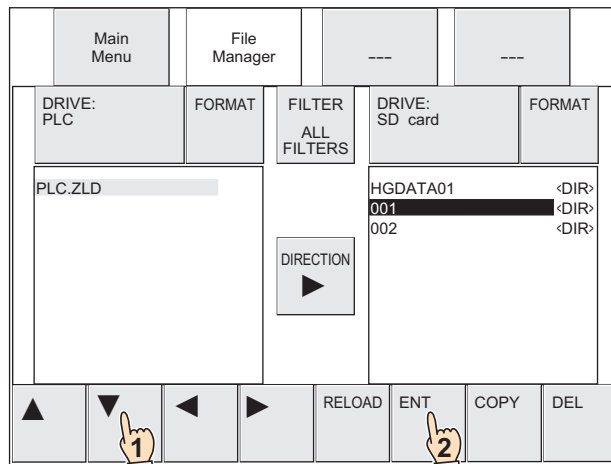

9 Press **COPY**.

A process confirmation message is displayed.

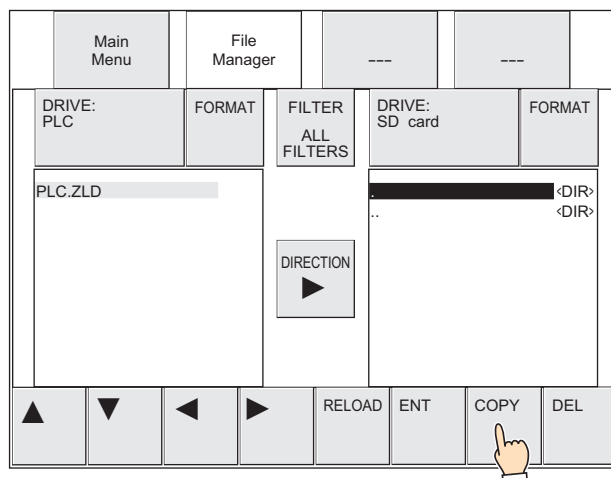

- 10 Specify the MICRO/I communication port and the slave number or the External Device ID, and then press **YES**. Specify the Slave Number when selecting serial interface as the MICRO/I communication port, and specify the External Device ID when selecting Ethernet interface. The PLC program upload starts. When the upload finishes, the results are displayed.

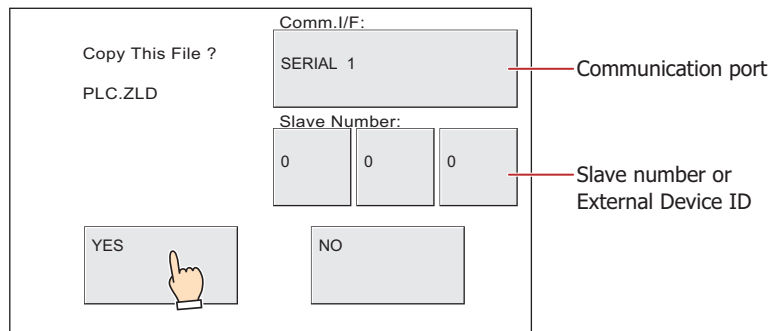

- "PLC.ZLD" is displayed in the confirmation message, but the ZLD Project File name after uploading is "Model name_Port number_Station number_Year month day hours minutes seconds + File extension (.zld)".
- When downloading a ZLD Project File to a PLC configured with a password, the PLC password screen is displayed. Enter the password.

- 11 Press **Ack** to close the screen. You are returned to the Top Page of System Mode.

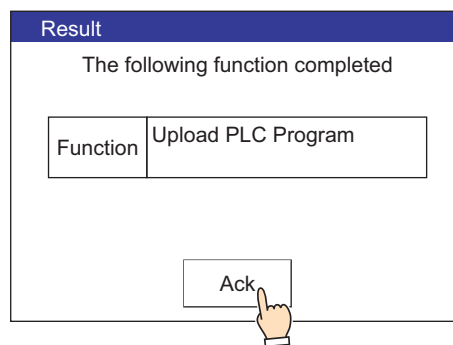

2.7 Precautions

- An error message is displayed if the PLC program upload or download fails. For details, refer to Chapter 36 "1.1 Errors Displayed on the Screen" on page 36-1.
- To create a ZLD Project File, the following version of WindLDR is required.

Manufacturer	Series name	Supported system (CPU unit)	WindLDR version
IDEC	OpenNet Controller	FC3A	Ver.6.30 or later
		FC4A	
	MICROSmart	FC5A	
		FC6A (FC6A-C*****E/-C*****EJ only)	
		FC6A (FC6A-D****CEE only)	Ver.8.6.0 or later
	SmartAXIS Pro/Lite	FT1A	Ver.8.0.0 or later

- MICRO/I operation and PLC operation stops while the PLC program transfer function is running. After the PLC program upload or download is completed, the MICRO/I returns to the mode immediately before running the PLC program transfer function and the PLC automatically starts running.
- The PLC program transfer function cannot be run when the MICRO/I is in Offline Mode. Switch to Run Mode, Monitor Mode, or System Mode before running the PLC program transfer function.
- If a file exists with the same name in the save destination when uploading a PLC program, the file is overwritten with the uploaded file without displaying an overwrite confirmation message.
- While running the PLC program transfer function using a Key Button, Multi-Button, or Multi-Command, if a data transfer function (project transfer, PLC program transfer, or file copy) is initiated, the only function that will work is the currently running function. If two or more data transfer functions are configured to a Multi-Button or Multi-Command, only the data transfer function displayed at the top of the function list on the parts property dialog box is run.

3 File Copy Function

HG2J-7U HG5G-V HG4G-V HG4G HG3G-V HG3G HG2G-V HG2G-5F HG2G-5T HG1G HG1P

3.1 What Can Be Done with the File Copy Function

The file copy function is used to copy files between or within the external memory devices inserted in the MICRO/I.

Copying from SD memory card to USB flash drive*¹, from USB flash drive to SD memory card*¹, or from USB flash drive to USB flash drive*²

Copy files between an SD memory card and a USB flash drive*¹, or between USB flash drives*² inserted in the MICRO/I.

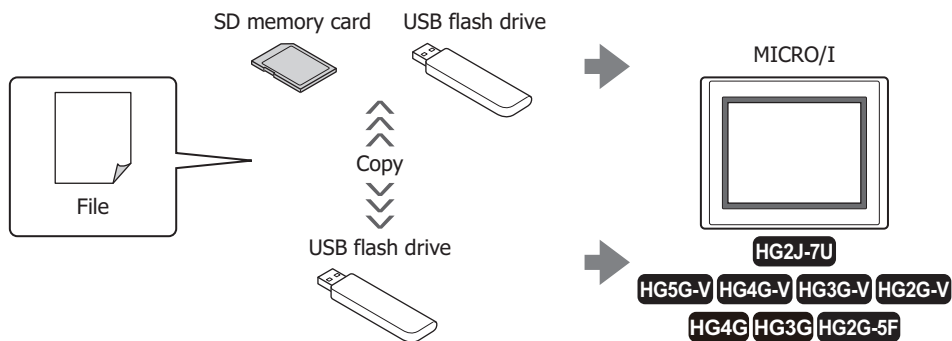

Internally copy files on an SD memory card*¹

Internally copy files on an SD memory card inserted in the MICRO/I.

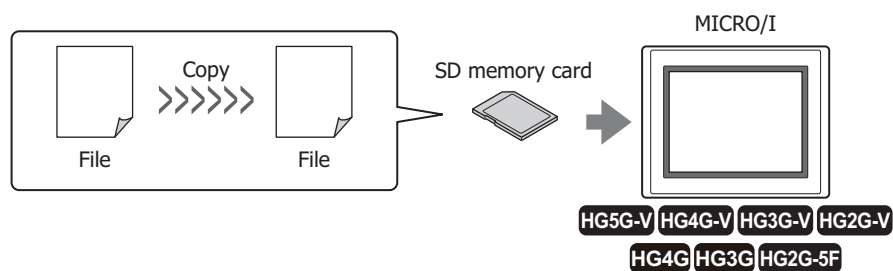

Internally copy files on a USB flash drive

Internally copy files on a USB flash drive inserted in the MICRO/I.

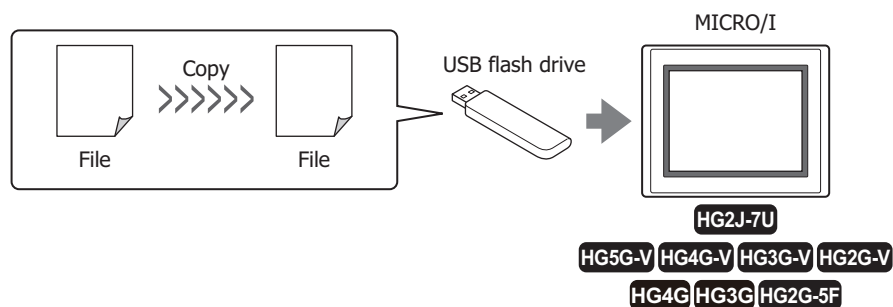

When the MICRO/I is under the Run Mode, HMI Special Internal Relay LSM23 is 1 while the File Copy function is executed.

*1 HG5G/4G/3G/2G-V, HG4G/3G, HG2G-5F only

*2 HG2J-7U only

3.2 File Copy Operating Procedures

The following methods can be used to copy files between or within the external memory devices (between an SD memory card and a USB flash drive^{*1}, between USB flash drives^{*2}, and within an SD memory card^{*1} or a USB flash drive) inserted in the MICRO/I.

- Using the USB Autorun function

 For details, refer to Chapter 31 "2 USB Autorun Function" on page 31-19.

- Using Key Buttons, Multi-Buttons, or Multi-Commands

 For details, refer to "3.3 Using Key Buttons, Multi-Buttons, or Multi-Commands to Copy Files" on page 29-32.

- Using the File Manager in the System Mode on the MICRO/I^{*1}

 For details, refer to "3.4 Using File Manager on the MICRO/I to Transfer Project Data" on page 29-33.

*1 HG5G/4G/3G/2G-V, HG4G/3G, HG2G-5F only

*2 HG2J-7U only

3.3 Using Key Buttons, Multi-Buttons, or Multi-Commands to Copy Files

HG2J-7U HG5G-V HG4G-V HG4G HG3G-V HG3G HG2G-V HG2G-5F HG2G-5T HG1G HG1P



Allocate a Key Button, Multi-Button, or Multi-Command configured with the file copy function to the MICRO/I.

☞ For details, refer to Chapter 8 "5 Key Button" on page 8-72.

☞ For details, refer to Chapter 8 "6 Multi-Button" on page 8-110.

☞ For details, refer to Chapter 12 "6 Multi-Command" on page 12-38.

- 1 Insert an external memory device in the MICRO/I.

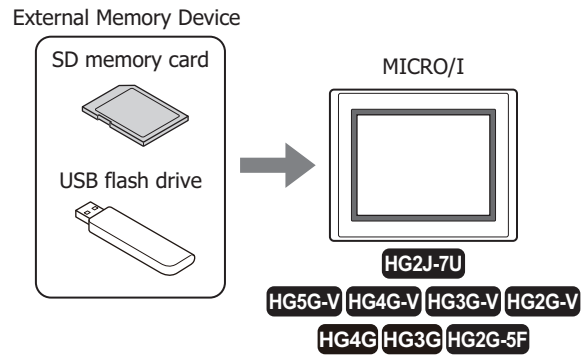

- 2 Press the Key Button or Multi-Button or execute the Multi-Command configured with **File Copy** under **Data Transfer** in the Key Browser.

3.4 Using File Manager on the MICRO/I to Transfer Project Data

HG2J-7U HG5G-V HG4G-V HG4G HG3G-V HG3G HG2G-V HG2G-5F HG2G-5T HG1G HG1P

- 1 Insert an external memory device in the MICRO/I.

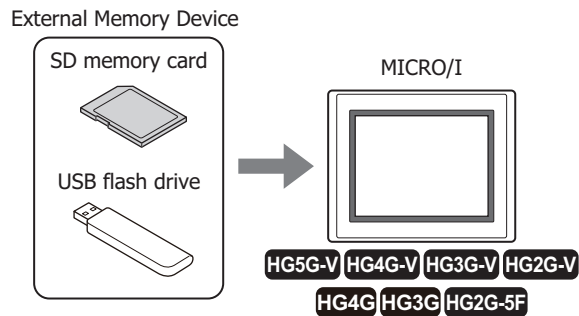

- 2 Press the upper-left edge of the MICRO/I screen for three seconds or more.
The maintenance screen is displayed.

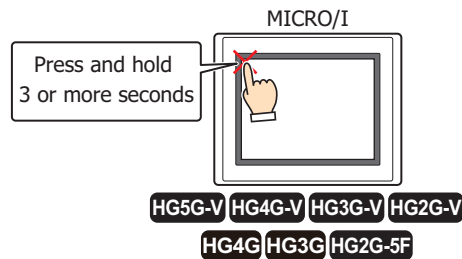

- 3 Press **System Mode**.

MICRO/I displays the Top Page in the System Mode.

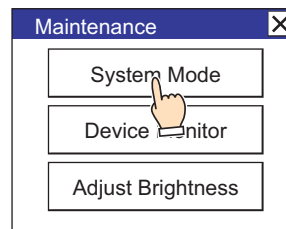

When downloading a project configured with security to the MICRO/I, the password screen is displayed. Select a user name and enter its password. For details, refer to Chapter 23 "User Accounts and the Security Function" on page 23-1.

4 Press **Main Menu**.

The main menu is displayed.

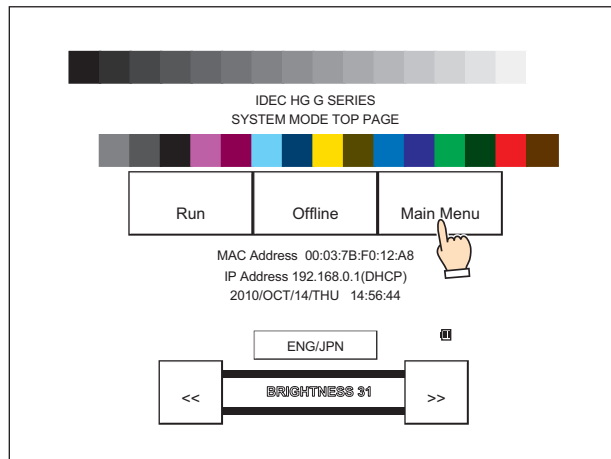

5 Press **File Manager**.

The file manager is displayed.

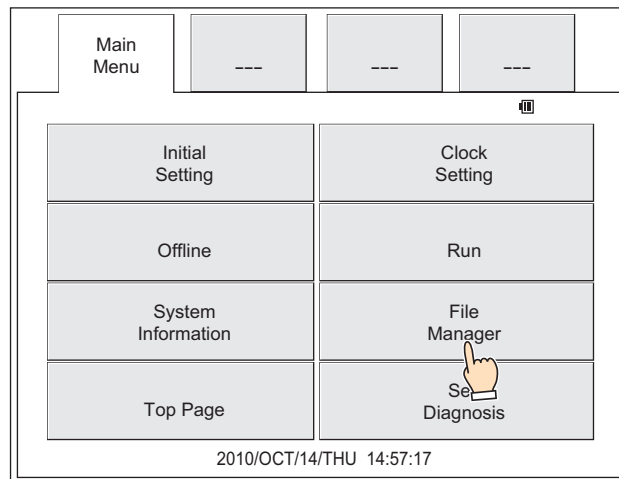

6 Press **DRIVE:** for the copy source and select the external memory device inserted in the MICRO/I.

This example screen shows when an SD memory card is selected.

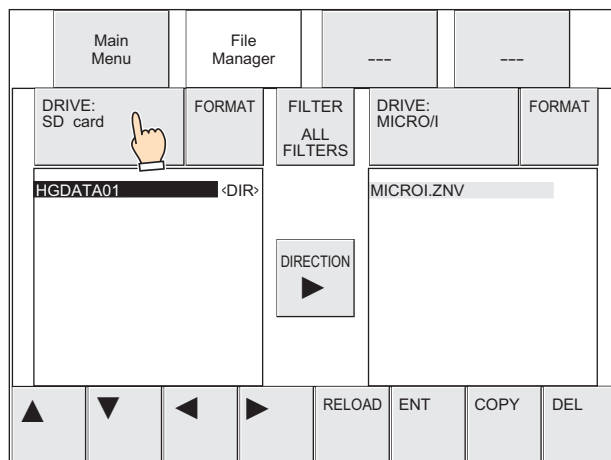

7 Select the file to copy.

In this example, the sound file (AUDIO1.WAV) saved in the External Memory Device folder (HGDATA01) is selected.

1. Press ▼ to select "HGDATA01" and then press **ENT**.

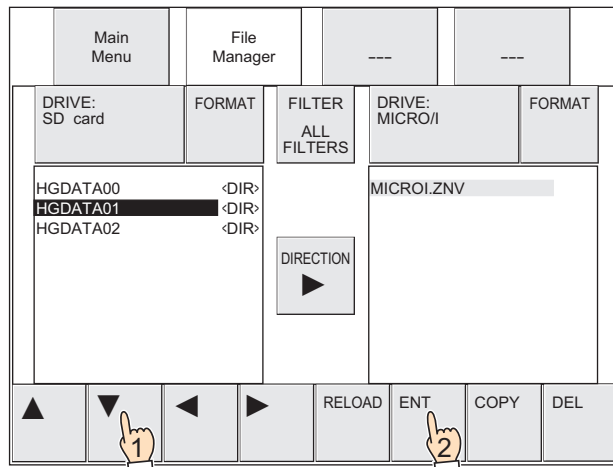

2. Press ▼ to select "SOUND" and then press **ENT**.

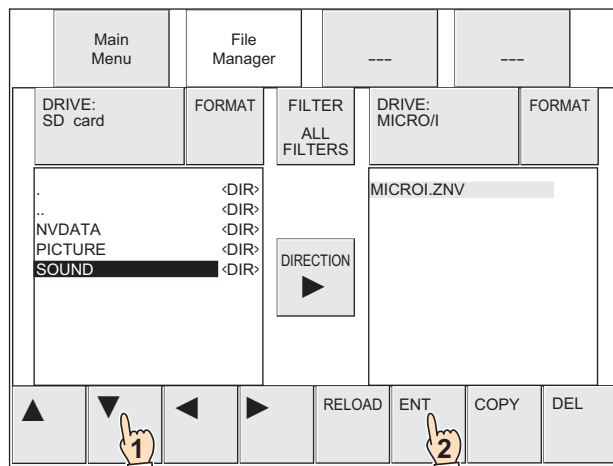

3. Press ▼ to select "AUDIO1.WAV".

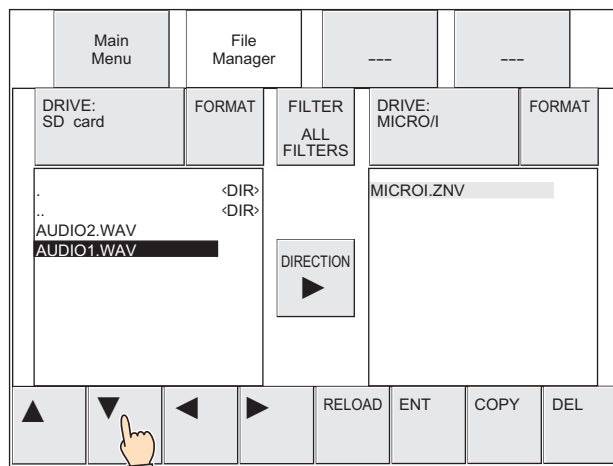

- 8 Press **DRIVE:** for the transfer destination and select the external memory device inserted in the MICRO/I.
This example screen shows when a USB flash drive is selected.

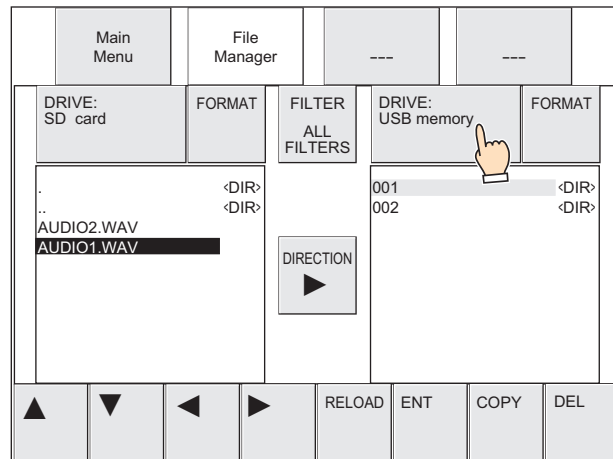

- 9 Select the save destination for the file to copy.
Folder (002) is selected in this example.

1. Press **▶** to move the cursor to the copy destination on the USB flash drive.

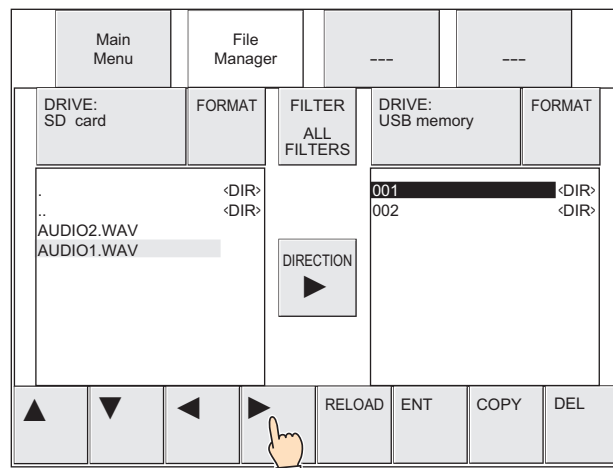

2. Press **▼** to select "002" and then press **ENT**.

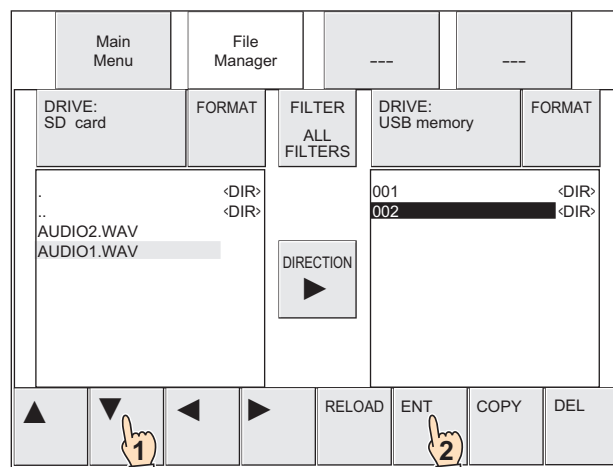

- 10 Press **COPY**.
A process confirmation message is displayed.

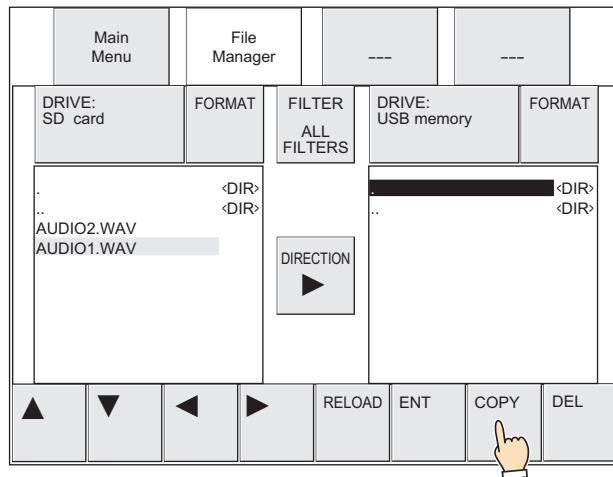

- 11 Press **YES**.
The file is being copied.

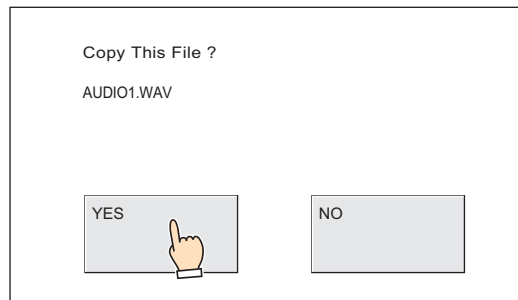

When complete, the file is shown in the save destination.

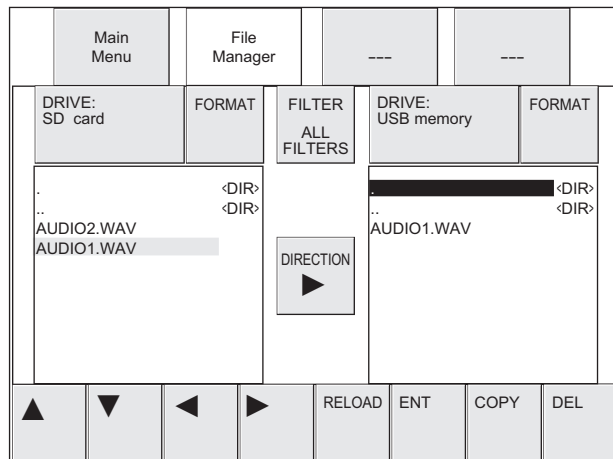

3.5 Precautions

- When the MICRO/I is under the Run Mode, the maximum size per single file that can be read or written with the File Copy function is 256 MB.
- Access to the file being copied is not allowed while the file copy function is running. Therefore, data may be missing when copying files used by the running project such as log data. When copying a file used by the running project, use **File Manager** on the MICRO/I under the System Mode.
- While running the file copy function using a Key Button, Multi-Button, or Multi-Command, if a data transfer function (project transfer, PLC program transfer, or file copy) is initiated, the only function that will work is the currently running function. If two or more data transfer functions are configured to a Multi-Button or Multi-Command, only the data transfer function displayed at the top of the function list on the parts property dialog box is run.

Chapter 30 Expansion Modules

This chapter describes how to use or operate the expansion modules, how to write a Cyclic Script and the basic operations of the Module Configuration dialog box.

1 Overview

HG2J-7U HG5G-V HG4G-V HG4G HG3G-V HG3G HG2G-V HG2G-5F HG2G-5T HG1G HG1P

1.1 Overview of Expansion Modules

The MICRO/I has an expansion interface which allows you to add input and output functionality by adding expansion modules.

For the HG5G/4G/3G-V, HG4G/3G, up to four IDEC MICROSmart PLC expansion I/O modules may be installed. For the HG2G-V, HG2G-5F, up to two IDEC MICROSmart PLC expansion I/O modules may be installed.

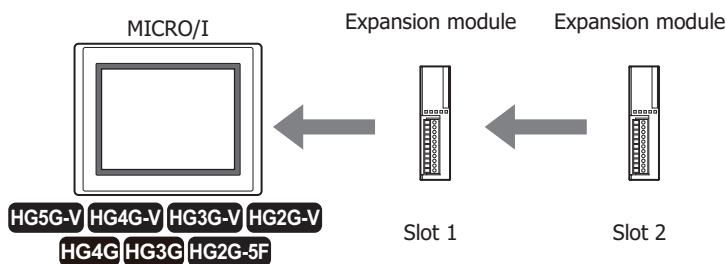

Expansion I/O modules can be used to configure a display and I/O control system for small equipment with only a few I/O, or for applications with simple I/O control requirements.



Attached expansion modules are referred to as Slot 1 and Slot 2 in order from the module closest to the MICRO/I.

1.2 Applicable Expansion Modules

● Digital I/O Module

HG2J-7U HG5G-V HG4G-V HG4G HG3G-V HG3G HG2G-V HG2G-5F HG2G-5T HG1G HG1P

IDEC MicroSmart PLC Digital I/O module that can be attached as expansion modules are shown below.

■ Digital Input Modules

Type	Model No.	Terminal	Dimensions (L x W x H (mm))	Consumption Current (mA)		HG5G/ 4G/3G/ 2G-V	HG4G/ 3G	HG2G- 5F
				5 V	24 V			
8 points/AC Input	FC4A-N08A11	Removable	90.0×23.5×70.0	25	0	NO	YES	YES
8 points/DC Input	FC4A-N08B1	Screw terminal block	90.0×23.5×70.0	25	0	NO	YES	YES
16 points/DC Input	FC4A-N16B1		90.0×23.5×70.0	40	0	NO	YES	YES
16 points/DC Input	FC4A-N16B3	MIL Connector	90.0×17.6×70.0	35	0	NO	YES	YES
32 points/DC Input	FC4A-N32B3		90.0×29.7×70.0	65	0	NO	YES	YES
8 points/AC Input	FC6A-N08A11	Removable	90.0×23.6×73.0	40	0	YES	YES	YES
8 points/DC Input	FC6A-N08B1	Screw terminal block	90.0×23.6×73.0	30	0	YES	YES	YES
16 points/DC Input	FC6A-N16B1		90.0×23.6×73.0	40	0	YES	YES	YES
16 points/DC Input	FC6A-N16B3	MIL Connector	90.0×17.6×73.0	40	0	YES	YES	YES
32 points/DC Input	FC6A-N32B3		90.0×30.2×73.0	65	0	YES	YES	YES
8 points/AC Input	FC6A-N08A14	Removable	90.0×30.2×73.0	40	0	YES	YES	YES
8 points/DC Input	FC4A-N08B4	Push-in terminal block	90.0×30.2×73.0	30	0	YES	YES	YES
16 points/DC Input	FC4A-N16B4		90.0×30.2×73.0	40	0	YES	YES	YES

■ Digital Output Modules

Type	Model No.	Terminal	Dimensions (L x W x H (mm))	Consumption Current (mA)		HG5G- V	HG4G/ 3G/2G -V	HG4G/ 3G	HG2G- 5F
				5 V	24 V				
8 points/Relay Output	FC4A-R081	Removable	90.0×23.5×70.0	30	40	NO	NO	YES	YES
16 points/Relay Output	FC4A-R161	Screw terminal block	90.0×23.5×70.0	45	75	NO	NO	YES	YES
8 points/Transistor Sink Output	FC4A-T08K1		90.0×23.5×70.0	10	20	NO	NO	YES	YES
8 points/Transistor Source Output	FC4A-T08S1		90.0×23.5×70.0	10	20	NO	NO	YES	YES
16 points/Transistor Sink Output	FC4A-T16K3		90.0×17.6×70.0	10	40	NO	NO	YES	YES
16 points/Transistor Source Output	FC4A-T16S3	MIL Connector	90.0×17.6×70.0	10	40	NO	NO	YES	YES
32 points/Transistor Sink Output	FC4A-T32K3		90.0×29.7×70.0	20	70	NO	NO	YES	YES
32 points/Transistor Source Output	FC4A-T32S3		90.0×29.7×70.0	20	70	NO	NO	YES	YES
8 points/Relay Output	FC6A-R081		90.0×23.6×73.0	35	50	YES	YES	YES	YES
16 points/Relay Output	FC6A-R161	Removable Screw terminal block	90.0×23.6×73.0	50	100	NO	YES	YES	YES
8 points/Transistor Sink Output	FC6A-T08K1		90.0×23.6×73.0	25	15	YES	YES	YES	YES
8 points/Transistor Source Output	FC6A-T08S1		90.0×23.6×73.0	25	15	YES	YES	YES	YES
16 points/Transistor Sink Output	FC6A-T16K1		90.0×23.6×73.0	30	25	YES	YES	YES	YES
16 points/Transistor Source Output	FC6A-P16K1		90.0×23.6×73.0	30	25	YES	YES	YES	YES
16 points/Transistor Sink Output	FC6A-T16K3		90.0×17.6×73.0	30	25	YES	YES	YES	YES
16 points/Transistor Source Output	FC6A-P16S3	MIL Connector	90.0×17.6×73.0	30	25	YES	YES	YES	YES
32 points/Transistor Sink Output	FC6A-T32K3		90.0×30.2×73.0	45	50	YES	YES	YES	YES
32 points/Transistor Source Output	FC6A-P32S3		90.0×30.2×73.0	45	50	YES	YES	YES	YES
8 points/Relay Output	FC6A-R084	Removable Push-in terminal block	90.0×23.6×73.0	35	50	YES	YES	YES	YES
16 points/Relay Output	FC6A-R164		90.0×23.6×73.0	50	100	NO	YES	YES	YES
8 points/Transistor Sink Output	FC6A-T08K4		90.0×23.6×73.0	25	15	YES	YES	YES	YES
8 points/Transistor Source Output	FC6A-T08P4		90.0×23.6×73.0	25	15	YES	YES	YES	YES
16 points/Transistor Sink Output	FC6A-T16K4		90.0×23.6×73.0	30	25	YES	YES	YES	YES
16 points/Transistor Source Output	FC6A-T16P4		90.0×23.6×73.0	30	25	YES	YES	YES	YES

■ Digital Combination I/O Modules

Type	Model No.	Terminal	Dimensions (L x W x H (mm))	Consumption Current (mA)		HG5G/ 4G/3G/ 2G-V	HG4G /3G	HG2G -5F
				5 V	24 V			
4 points/DC Input, 4 points/Relay Output	FC4A-M08BR1	Removable Screw terminal block	90.0×23.5×70.0	25	20	NO	YES	YES
16 points/DC Input, 8 points/Relay Output	FC4A-M24BR2	Non-removable Terminal Block	90.0×39.1×70.0	65	45	NO	YES	YES
4 points/DC Input, 4 points/Relay Output	FC6A-M08BR1	Removable Screw terminal block	90.0×23.6×73.0	30	25	YES	YES	YES
16 points/DC Input, 8 points/Relay Output	FC6A-M24BR1		90.0×39.2×73.0	55	50	YES	YES	YES
4 points/DC Input, 4 points/Relay Output	FC6A-M08BR4	Removable Push-in terminal block	90.0×23.6×73.0	30	25	YES	YES	YES
16 points/DC Input, 8 points/Relay Output	FC6A-M24BR4		90.0×39.2×73.0	55	50	YES	YES	YES

● Analog I/O Module

HG2J-7U HG5G-V HG4G-V HG4G HG3G-V HG3G HG2G-V HG2G-5F HG2G-5T HG1G HG1P

IDEC MicroSmart PLC Analog I/O modules that can be attached as expansion modules are shown below.

■ Analog Input Module

Type	Model No.	Input Type				
		Voltage	Current	Thermocouple	Resistance Thermometer	Thermistor
2 points Input	FC6A-J2C1 FC6A-J2C4	0 to 10 V/ -10 to +10 V	0 to 20 mA/ 4 to 20 mA	—	—	—
4 points Input	FC6A-J4A1 FC6A-J4A4	0 to 10 V/ -10 to +10 V	0 to 20 mA/ 4 to 20 mA	—	—	—
8 points Input	FC6A-J8A1 FC6A-J8A4	0 to 10 V/ -10 to +10 V	0 to 20 mA/ 4 to 20 mA	—	—	—
4 points Input	FC6A-J4CN1 FC6A-J4CN4	0 to 10 V/ -10 to +10 V	0 to 20 mA/ 4 to 20 mA	K/ J/ R/ S/ B/ E/ T/ N/ C	Pt100/Pt1000/ Ni100/Ni1000	—
4 points Input	FC6A-J4CH1Y FC6A-J4CH4Y	—	—	K/ J/ R/ S/ B/ E/ T/ N/ C	—	—
8 points Input	FC6A-J8CU1 FC6A-J8CU4	—	—	K/ J/ R/ S/ B/ E/ T/ N/ C	—	NTC/PTC

■ Analog Output Module

Type	Model No.	Output Type	
		Voltage	Current
2 points Output	FC6A-K2A1 FC6A-K2A4	0 to 10V/-10 to +10V	0 to 20mA/4 to 20mA
4 points Output	FC6A-K4A1 FC6A-K4A4	0 to 10 V/-10 to +10 V	0 to 20 mA/4 to 20 mA

■ Mixed Analog I/O Module

Type	Model No.	Input Type				Output Type	
		Voltage	Current	Thermocouple	Resistance Thermometer	Voltage	Current
4 points Input, 2 points Output	FC6A-L06A1 FC6A-L06A4	0 to 10 V/ -10 to +10 V	0 to 20 mA/ 4 to 20 mA	—	—	—	—
		—	—	—	—	0 to 10 V/ -10 to +10 V	0 to 20 mA/ 4 to 20 mA
2 points Input, 1 points Output	FC6A-L03CN1 FC6A-L03CN4	0 to 10 V/ -10 to +10 V	0 to 20 mA/ 4 to 20 mA	K/ J/ R/ S/ B/ E/ T/ N/ C	Pt100/Pt1000/ Ni100/Ni1000	—	—
		—	—	—	—	0 to 10 V/ -10 to +10 V	0 to 20 mA/ 4 to 20 mA

Checking the Hardware Version Number

The analog I/O module hardware version number is printed on the side of the analog I/O module. The performance and functionality of the analog I/O module will differ by its version, so check the version number before use.

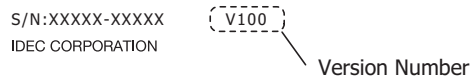

● Restrictions when connecting the expansion modules

HG2J-7U **HG5G-V** **HG4G-V** **HG4G** **HG3G-V** **HG3G** **HG2G-V** **HG2G-5F** **HG2G-5T** **HG1G** **HG1P**

- The expansion module for FC6A and the expansion module for FC4A cannot be used together.
- Always turn the MICRO/I and the expansion module off before attaching or detaching an expansion module.
- Use the expansion module clamp (sold separately) when using expansion modules.
Order the module clamp by referring to the width of the module shown in the dimensions of each module.
- When connecting more than 2 expansion modules, note the limits shown below.

Type No.	Quantity of Applicable Analog I/O Modules	Total width when connecting more than 2 expansion modules	Current flow rate at 5V	Current flow rate at 24V
HG5G-V	4	93.0 mm max.	130 mA max.	50 mA max.
HG4G/3G-V, HG4G/3G	4	93.0 mm max.	130 mA max.	150 mA max.
HG2G-V, HG2G-5F	2	70.0 mm max.	130 mA max.	150 mA max.

● Expansion Module Slot Information

HG2J-7U HG5G-V HG4G-V HG4G HG3G-V HG3G HG2G-V HG2G-5F HG2G-5T HG1G HG1P



The model number, type, and system software version of the expansion modules installed in MICRO/I can be checked on the Expansion Module Information dialog box. For details, refer to Chapter 24 "Expansion Module Information Dialog Box" on page 24-33.

Expansion module type information is written to HMI Special Data Registers (LSD270 to 277). The details are shown below.

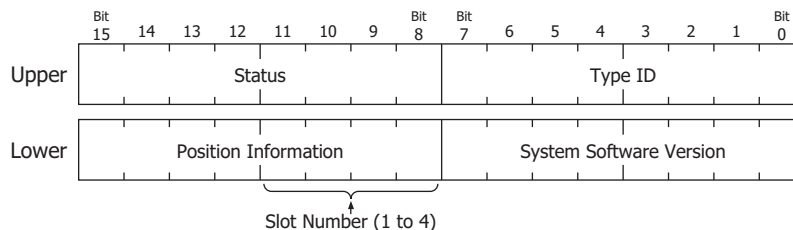

Upper	Lower	Description
LSD270	LSD271	Expansion Module Slot 1 Information
LSD272	LSD273	Expansion Module Slot 2 Information
LSD274	LSD275	Expansion Module Slot 3 Information
LSD276	LSD277	Expansion Module Slot 4 Information

■ Status

Status		Description
Hexadecimal	Binary	
0x00	0000 0000	Normal
0x81	1000 0001	Communication error (An error has occurred in the communication between MICRO/I and an expansion module.)
0x82	1000 0010	Unknown device detected
0x83	1000 0011	Device setting error (No device is connected or the connected device is different from the setting of the project.)
0x84	1000 0100	Device writing error (Failed to set the operation of the device.)

■ Type ID

Type ID		Type No.
Hexadecimal	Binary	
0x00	0000 0000	FC6A-N16B1, FC6A-N16B4, FC6A-N16B3
0x01	0000 0001	FC6A-R161, FC6A-R164, FC6A-T16K1, FC6A-T16K4, FC6A-T16P1, FC6A-T16P4, FC6A-T16K3, FC6A-T16P3
0x02	0000 0010	FC6A-N32B3
0x03	0000 0011	FC6A-T32K3, FC6A-T32P3
0x04	0000 0100	FC6A-N08B1, FC6A-N08B4, FC6A-N08A11, FC6A-N08A14
0x05	0000 0101	FC6A-R081, FC6A-R084, FC6A-T08K1, FC6A-T08K4, FC6A-T08P1, FC6A-T08P4
0x06	0000 0110	FC6A-M08BR1, FC6A-M08BR4
0x07	0000 0111	FC6A-M24BR1, FC6A-M24BR4
0x20	0010 0000	FC6A-J2C1, FC6A-J2C4
0x21	0010 0001	FC6A-J4A1, FC6A-J4A4
0x22	0010 0010	FC6A-J8A1, FC6A-J8A4
0x23	0010 0011	FC6A-K2A1, FC6A-K2A4
0x24	0010 0100	FC6A-K4A1, FC6A-K4A4
0x25	0010 0101	FC6A-L06A1, FC6A-L06A4
0x26	0010 0110	FC6A-L03CN1, FC6A-L03CN4
0x27	0010 0111	FC6A-J4CN1, FC6A-J4CN4
0x28	0010 1000	FC6A-J8CU1, FC6A-J8CU4
0x2B	0010 1011	FC6A-J4CH1Y, FC6A-J4CH4Y
0xFF	1111 1111	Disconnect

■ System Software Version

Displays the version of the system software written to the device.

1.3 The Expansion Module Operation

The Expansion modules can be controlled by switch parts, command parts and scripts. Processing priority should be determined based on the application.



When the MICRO/I is switched from operation mode to another mode, the state of the output terminal of the expansion module is as follows.

Digital I/O Module: Output OFF

Analog I/O Module: High impedance

■ Priority to display processing

In this mode, priority is given to the display and parts processing.

This mode can be used for applications where the priority is on the processing speed of screen parts operation and screen switching.

Read and write to the Input (#I, #D and LEX) and Output (#Q, #D and LEY) using the parts and the functions except the Cyclic Script such as switch parts, command parts, and scripts.

Users should understand that the processing time for drawing objects and communicating (the scan time of the screen) affects the control timing of the expansion module.

This means a time-consuming display process will slow the control time down and result in delayed input response.

■ Priority on control processing

This mode places priority on control processing speed.

It can be used for screens where parts operation is minimal but have many data processing parts.

Use the Cyclic Script to read and write to the Input (#I, #D and LEX) and Output (#Q, #D and LEY).

Refer to "4 Cyclic Script" on page 30-29 for programming information.

Use the Cyclic Script, which executes in conjunction with the expansion module, to provide I/O control at fixed intervals independent of the scan time of the screen.



Input and output processing set in the periodic script captures input at fixed intervals, and inputs other than fixed-period scripts take inputs at the end of scan. If the same device address is used, take input at each timing and update the output.

● Operation with priority on display processing

When there are external inputs

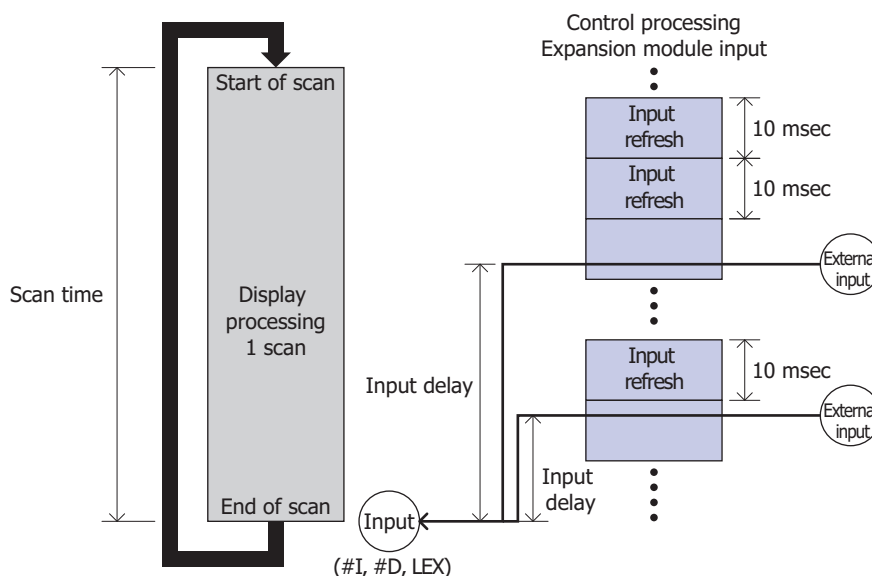

■ Display processing

Parts placed on the screen are processed in order from top to bottom. This process is done in a single scan. When processing reaches the end, it returns to the beginning and starts the next scan. The time for one scan depends on the number and type of parts used, as well as how they are configured.

■ Input refresh

Inputs are refreshed every 10 milliseconds independent of the screen scan. However, inputs from the expansion module are not reflected in the Input (#I, #D and LEX) until the screens scan ends.

■ Input delay

When there is an external input to the expansion module, the delay time until that input is reflected to the Input (#I, #D and LEX) is as follows.

Minimum: 5 milliseconds

Maximum: 15 milliseconds + the scan time (HMI Special Data Register LSD4)

The longer display processing takes, the longer the delay.



When the input refresh is executed immediately after starting the scan, the input of the expansion module is reflected at the end of the scan of the screen. This will result in a wait time of about 1 scan and the input delay is maximized.

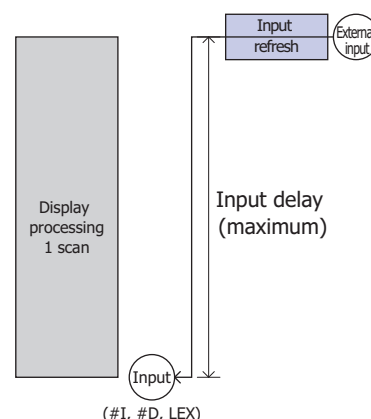

Writing to the external outputs

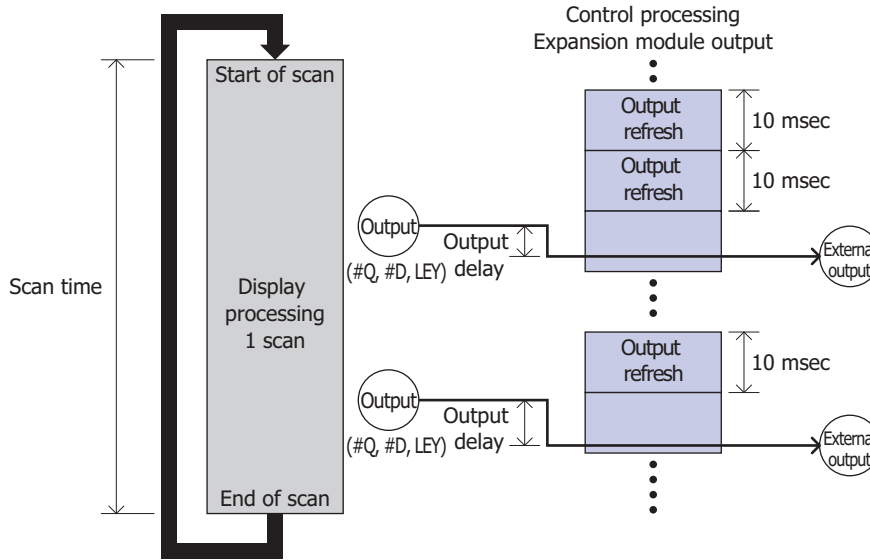

■ **Output refresh**

Outputs are refreshed every 10 milliseconds independent of the screen scan.

The Output (#Q, #D and LEY) are reflected in the expansion module.

■ **Output delay**

The delay time from output (# Q, # D, LEY) to output from the expansion module is as follows.

Minimum: 1 millisecond

Maximum: 11 milliseconds

This does not affect the display processing



The maximum output delay is 11 milliseconds, which is the operating time of the output refresh.

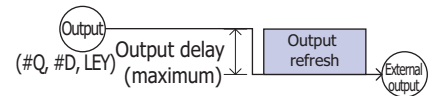

● Operation of priority on control processing

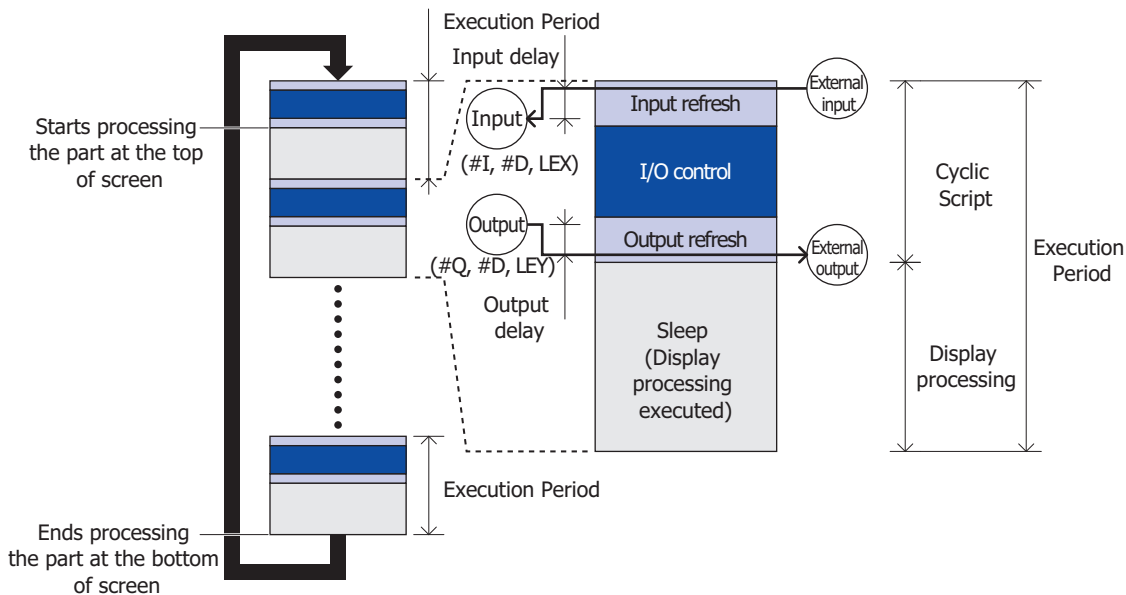

■ **Input refresh**

Inputs on the expansion module are reflected in the Input (#I, #D and LEX).



The HG5G/4G/3G/2G-V also performs output refresh when input refreshing.

■ **Input delay**

There is a delay for reflecting the expansion module input to the Input (#I, #D and LEX).

The delay time is as follows.

Minimum: 5 milliseconds

Maximum: 5 milliseconds + the execution period



There will be maximum input delay if input is made to the expansion module immediately after the input refresh ends. The processor waits for the input refresh in the next scan before reflecting the input to the Input (#I, #D and LEX).

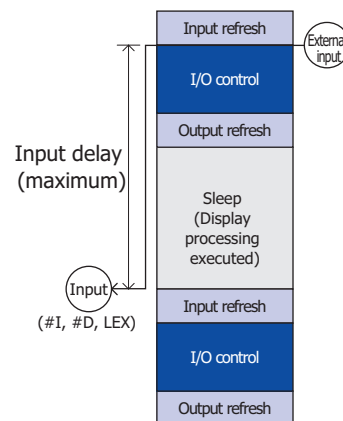

■ **I/O control**

Executes the script that is set to Cyclic Script.

■ **Output refresh**

The Outputs (#Q, #D and LEY) are outputted to the expansion module.

■ Output delay

The min-to-max delay time for the Output (#Q, #D and LEY) to fire from the expansion module is 1 millisecond to 1 millisecond + the Execution Period.



There will be maximum output delay if output is made to the expansion module immediately after the output refresh ends. The processor waits for the output refresh in the next scan before reflecting the output to the Output (#Q, #D and LEY).

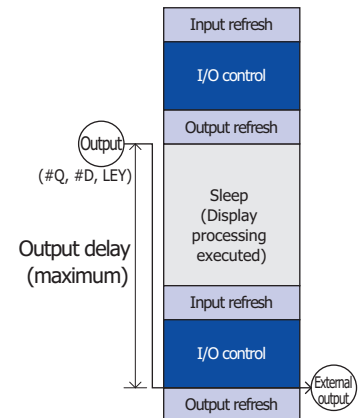

■ Cyclic Script

A Cyclic Script refers to three processes: input refresh, I/O control (the specified script), and output refresh. Refer to "4 Cyclic Script" on page 30-29 for more information.



- Only internal devices can be used in the Cyclic Script.
- The actual execution time of the Cyclic Script is stored in HMI Special Data Register LSD38 (current value x msec), LSD39 (max value x msec), and LSD40 (min value x msec).
- LINE function, RECTANGLE function, and CIRCLE function cannot be used in the Cyclic Script.

■ Sleep

Sleep refers to the time used by the Cyclic Script subtracted from the Execution Period. This is when the processor executes display processing.

■ Execution Period

The Execution Period refers to one scan of the Cyclic Script (input refresh + I/O control + output refresh) and display processing time (sleep).

The Cyclic Script is executed once every specified execution interval.



- If execution of the Cyclic Script takes more than half of the time specified for the Execution Period, the processor automatically extends the Execution Period so that the Cyclic Script completes within 1/2 of the Execution Period. In this instance, error number 7 will be stored in HMI Special Data Register LSD53.
- If the execution time of the Cyclic Script exceeds 3,000 milliseconds, it pauses to allow the output refresh to be executed. Thereafter, the script goes to sleep and the Cyclic Script executes on the next scan. In this instance, error number 6 will be stored in HMI Special Data Register LSD53.



There is a delay in the I/O control. Please take this delay time into consideration when specifying the Execution Period. For instance, if it is necessary to take in external inputs within 100 milliseconds, set the Execution Period to 80 milliseconds.

■ Display processing

Parts laid out on the screen are processed from top to bottom only when the Cyclic Script is in sleep mode.

Display processing is paused when execution of the next Cyclic Script begins, and resumes when the script goes to sleep again.

When processing reaches the bottom of the screen, processing returns to the top of the screen.

Operation Example

Where,

- Execution interval: 100 milliseconds
- Input refresh: 1 millisecond
- I/O control: 10 milliseconds
- Output refresh: 1 millisecond

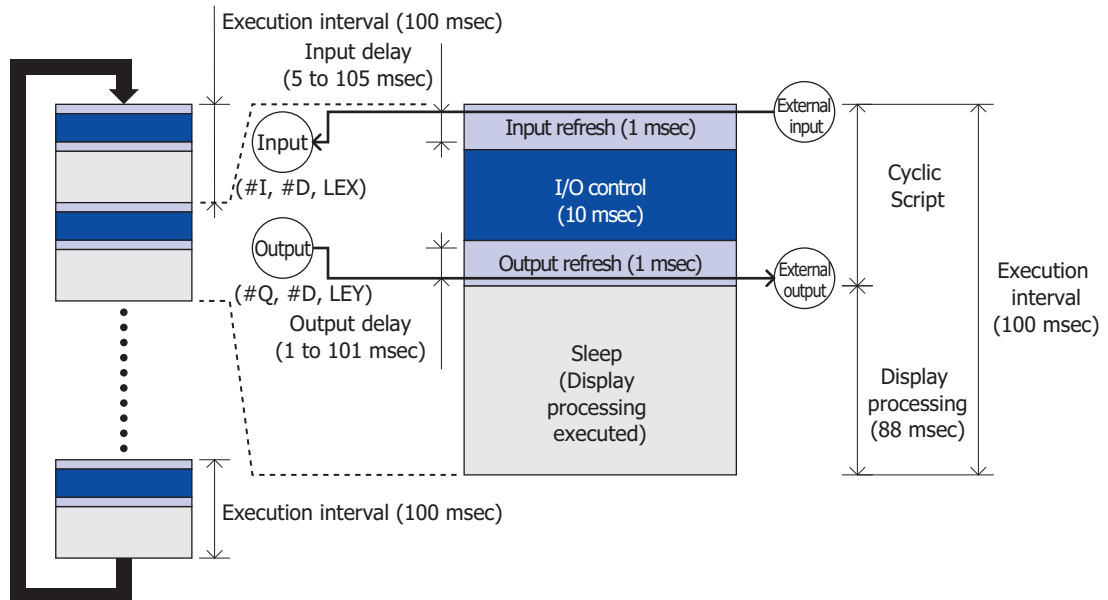

The execution time of the Cyclic Script is $1 + 10 + 1 = 12$ milliseconds, so the script executes normally.

The input delay can be from 5 to 105 milliseconds, and the output delay can be from 1 to 101 milliseconds.

Since the sleep time is $100 - 12 = 88$ milliseconds, display processing is executed every 88 milliseconds for each scan.

2 Digital I/O Modules

HG2J-7U HG5G-V HG4G-V HG4G HG3G-V HG3G HG2G-V HG2G-5F HG2G-5T HG1G HG1P

2.1 Using Digital I/O Modules

The inputs and outputs on the digital I/O modules are mapped to following device address locations within the MICRO/I. The device name and symbol vary based on the model.

Type No.	Device Name	Symbol
HG5G/4G/3G/2G-V	Expansion Inputs	#I
	Expansion Outputs	#Q
HG4G/3G, HG2G-5F	Digital Input	LEX
	Digital Output	LEY

To monitor the inputs and control the outputs, the Expansion Inputs(#I), Expansion Outputs(#Q), Digital Input(LEX) and Digital Output (LEY) are used.



When entering the control device, enter "#" before the symbol (device type). In addition, on the Device Monitor a "#" is displayed before the symbol.

Example: Setting I100 as a control device

#I100

The Expansion Inputs(#I), Expansion Outputs(#Q), Digital Input(LEX) and Digital Output(LEY) are octal-based, meaning that only numbers 0 to 7 are used in their addresses.

Address numbers are assigned in ascending order from Slot 1. However, if a unit has four input/output ports, address numbers 0 to 3 are assigned to each, and address numbers 4 to 7 cannot be used.



Inputs and outputs of Digital I/O modules can also be controlled and monitored using the word devices #WI, #WQ, WLEX and WLEY. #WI, #WQ, WLEX and WLEY are useful for batch control of inputs and outputs. For details about allocation of address number, refer to Chapter 33 "Internal Devices" on page 33-1.

3 Analog I/O Modules

HG2J-7U HG5G-V HG4G-V HG4G HG3G-V HG3G HG2G-V HG2G-5F HG2G-5T HG1G HG1P

3.1 Using Analog I/O Modules

Analog I/O modules are available that allow the MICRO/I to directly handle analog data such as voltage, current, and temperature. There are ten types of analog I/O modules that differ by the number of analog inputs and outputs and the operation mode. These analog I/O modules can be used by connecting them to the back of the MICRO/I.

Analog I/O module inputs support voltage, current, thermocouples, resistance thermometers, and thermistors. Analog I/O module outputs support voltage and current.

To use Analog I/O modules, configure the settings on the **Module Configuration** dialog box. For details on configuration methods, refer to "5 Module Configuration Dialog Box" on page 30-30. For details on the analog I/O module parameter settings, refer to "3.2 Analog I/O Module Parameter Settings" on page 30-14.

3.2 Analog I/O Module Parameter Settings

Analog I/O Module Parameter Settings are configured for each channel. The parameters to configure differ according to the analog I/O module type and I/O type. Please configure the parameter settings according to the application in the **Analog Module Configuration** dialog box.

For details on configuration methods, refer to "5 Module Configuration Dialog Box" on page 30-30

● Analog Input Type

The following parameters are for configuring the analog inputs on the analog input modules and the mixed analog I/O modules.

YES: Parameters, NO: No parameters

Parameter	FC6A-J2C1	FC6A-J4A1	FC6A-J8A1	FC6A-J4CN1	FC6A-J4CH1Y	FC6A-J8CU1	FC6A-L06A1	FC6A-L03CN1
	FC6A-J2C4	FC6A-J4A4	FC6A-J8A4	FC6A-J4CN4	FC6A-J4CH4Y	FC6A-J8CU4	FC6A-L06A4	FC6A-L03CN4
Signal Type	YES	YES	YES	YES	YES	YES	YES	YES
Data Type	YES	YES	YES	YES	YES	YES	YES	YES
Minimum and maximum values	YES	YES	YES	YES	YES	YES	YES	YES
Filter	YES	YES	YES	YES	YES	YES	YES	YES
Sample Time	YES	YES	YES	YES	YES	YES	YES	YES
Thermistor Settings	NO	NO	NO	NO	NO	YES	NO	NO
Data	YES	YES	YES	YES	YES	YES	YES	YES
Status	YES	YES	YES	YES	YES	YES	YES	YES

Dialog Title: Analog Module Configuration (Slot 1)

Type: FC6A-J8CU1

DR Allocation: #D0000 #D0000-#D0015

Channel	Filter (ms)	Sampling Time	Signal Type	Data Type	R0	T0	B	Min.	Max.	Data	Status
A10	0 104ms		Type K	Binary data				0	65535	#D0000	#D0001
A11	0 104ms		NTC Thermistor	Binary data	0	0	0	0	65535	#D0002	#D0003
A12			Unused							#D0004	#D0005
A13			Unused							#D0006	#D0007
A14			Unused							#D0008	#D0009
A15			Unused							#D0010	#D0011
A16			Unused							#D0012	#D0013
A17			Unused							#D0014	#D0015

Buttons: Device Allocation, OK, Cancel

■ Signal Type

The signal type that can be set differs according to the analog I/O module model. Select the analog I/O module that corresponds to the user application and set the signal type. The signal type is the type of analog input to measure. There are 24 signal types for the analog inputs, which are detailed as follows.

YES: Supported, NO: Not supported

Signal Type	FC6A-J2C1 FC6A-J2C4	FC6A-J4A1 FC6A-J4A4	FC6A-J8A1 FC6A-J8A4	FC6A-J4CN1 FC6A-J4CN4	FC6A-J4CH1Y FC6A-J4CH4Y	FC6A-J8CU1 FC6A-J8CU4	FC6A-L06A1 FC6A-L06A4	FC6A-L03CN1 FC6A-L03CN4
Unused*1	YES	YES	YES	YES	YES	YES	YES	YES
0 to 10V DC	YES	YES	YES	YES	NO	NO	YES	YES
-10 to +10V DC	YES	YES	YES	YES	NO	NO	YES	YES
0 to 20mA DC	YES	YES	YES	YES	NO	NO	YES	YES
4 to 20mA DC	YES	YES	YES	YES	NO	NO	YES	YES
Type K thermocouple	NO	NO	NO	YES	YES	YES	NO	YES
Type J thermocouple	NO	NO	NO	YES	YES	YES	NO	YES
Type R thermocouple	NO	NO	NO	YES	YES	YES	NO	YES
Type S thermocouple	NO	NO	NO	YES	YES	YES	NO	YES
Type B thermocouple	NO	NO	NO	YES	YES	YES	NO	YES
Type E thermocouple	NO	NO	NO	YES	YES	YES	NO	YES
Type T thermocouple	NO	NO	NO	YES	YES	YES	NO	YES
Type N thermocouple	NO	NO	NO	YES	YES	YES	NO	YES
Type C thermocouple	NO	NO	NO	YES	YES	YES	NO	YES
Pt100	NO	NO	NO	YES	NO	NO	NO	YES
Pt1000	NO	NO	NO	YES	NO	NO	NO	YES
Ni100	NO	NO	NO	YES	NO	NO	NO	YES
Ni1000	NO	NO	NO	YES	NO	NO	NO	YES
NTC Thermistor	NO	NO	NO	NO	NO	YES	NO	NO
PTC Thermistor	NO	NO	NO	NO	NO	YES	NO	NO
PTC Thermistor (threshold)*2	NO	NO	NO	NO	NO	YES	NO	NO
Ohm meter	NO	NO	NO	NO	NO	YES	NO	NO
Expansion 0 to 20mA DC	NO	NO	YES	NO	NO	NO	NO	NO
Expansion 4 to 20mA DC	NO	NO	YES	NO	NO	NO	NO	NO

*1 Channels that are set to unused are not scanned.

The circuit is setup the same as when **0 to 10V DC** is selected as **Signal Type**.

0 is always stored in the analog data storage data registers for channels that are set to unused.

*2 For details, refer to " PTC Thermistor (Threshold)" on page 30-21.

■ Data Type

The analog input value can be handled as the set data type. There are seven data types for the analog inputs.

YES: Supported, NO: Not supported

Data Type	FC6A-J2C1	FC6A-J4A1	FC6A-J8A1	FC6A-J4CN1	FC6A-J4CH1Y	FC6A-J8CU1	FC6A-L06A1	FC6A-L03CN1
	FC6A-J2C4	FC6A-J4A4	FC6A-J8A4	FC6A-J4CN4	FC6A-J4CH4Y	FC6A-J8CU4	FC6A-L06A4	FC6A-L03CN4
Binary data* ¹	YES	YES	YES	YES	YES	YES	YES	YES
Optional range* ¹	YES	YES	YES	YES	YES	YES	YES	YES
Celsius (°C)* ²	NO	NO	NO	YES	YES	YES	NO	YES
Fahrenheit (°F)* ²	NO	NO	NO	YES	YES	YES	NO	YES
Resistance (Ω)* ³	NO	NO	NO	NO	NO	YES	NO	NO
Binary data (16bit)	NO	NO	YES* ⁴	NO	NO	NO	NO	NO
Optional range (16bit)	NO	NO	YES* ⁴	NO	NO	NO	NO	NO

Optional range

Scales the analog input value to a digital value with 12-bit or 16-bit resolution in the specified minimum and maximum value range (-32,768 to 32,767) and stores it in the data register.

However, when **PTC Thermistor (threshold)** is selected as **Signal Type**, the range of the minimum and maximum value is 100 to 10,000.

Example: The digital resolution data is 12bit, the range of the input voltage value is -10 to +10V, the minimum is -1000 and the maximum is 1000.

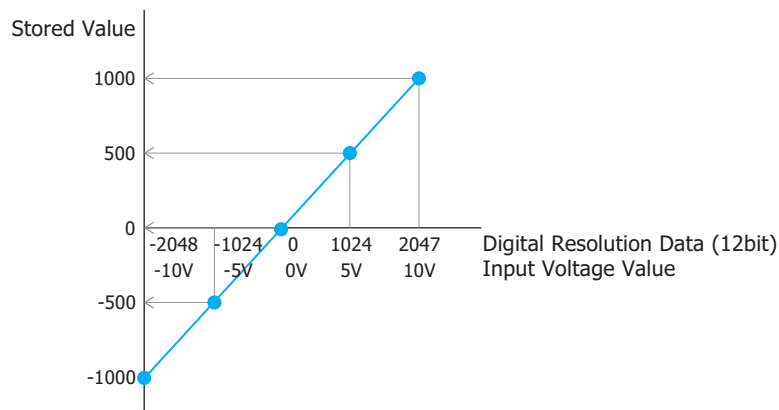

*1 **Binary data (12bit)** and **Optional range (12bit)** are displayed only for FC6A-J8A1 and FC6A-J8A4.

*2 Can only be set when **Signal Type** is thermocouples, resistance thermometers or **NTC Thermistor**.

*3 Resistance when using the FC6A-J8CU1 or FC6A-J8CU4 and **Signal Type** is set to **PTC Thermistor** or **Ohm meter**.

*4 **Binary data (16bit)** and **Optional range (16bit)** can be used with the following versions.

FC6A-J8A1, FC6A-J8A4: Hardware version 200 or later (Refer to "Checking the Hardware Version Number" on page 30-4.)
If an FC6A-J8A1 or FC6A-J8A4 that does not correspond to the above version numbers is set to **Binary data (16bit)** or **Optional range (16bit)**, an error will occur and the module will operate as **Binary data (12bit)**.

■ Minimum and maximum values

The values of **Min.** and **Max.** are determined by the set **Signal Type** and **Data Type**. The value is stored in the **Data** according to values of **Min.** and **Max.**.

The minimum and maximum values that correspond to the signal type and data types are as follows.

Signal Type	Data Type						
	Binary data *1	Optional range *1*2	Celsius (°C)	Fahrenheit (°F)	Resistance (Ω)	Binary data (16bit)	Optional range (16bit)
0 to 10V DC	0 to 65,535	-32,768 to 32,767	—	—	—	0 to 65,535	-32,768 to 32,767
-10 to +10V DC	-32,768 to 32,767	-32,768 to 32,767	—	—	—	-32,768 to 32,767	-32,768 to 32,767
0 to 20mA DC	0 to 65,535	-32,768 to 32,767	—	—	—	0 to 65,535	-32,768 to 32,767
4 to 20mA DC	0 to 65,535	-32,768 to 32,767	—	—	—	0 to 65,535	-32,768 to 32,767
Type K thermocouple	0 to 65,535	-32,768 to 32,767	-2,000 to 13,000	-3,280 to 23,720	—	—	—
Type J thermocouple	0 to 65,535	-32,768 to 32,767	-2,000 to 10,000	-3,280 to 18,320	—	—	—
Type R thermocouple	0 to 65,535	-32,768 to 32,767	0 to 17,600	320 to 32,000	—	—	—
Type S thermocouple	0 to 65,535	-32,768 to 32,767	0 to 17,600	320 to 32,000	—	—	—
Type B thermocouple	0 to 65,535	-32,768 to 32,767	0 to 18,200	320 to 33,080	—	—	—
Type E thermocouple	0 to 65,535	-32,768 to 32,767	-2,000 to 8,000	-3,280 to 14,720	—	—	—
Type T thermocouple	0 to 65,535	-32,768 to 32,767	-2,000 to 4,000	-3,280 to 7,520	—	—	—
Type N thermocouple	0 to 65,535	-32,768 to 32,767	-2,000 to 13,000	-3,280 to 23,720	—	—	—
Type C thermocouple	0 to 65,535	-32,768 to 32,767	0 to 23,150	320 to 41,990	—	—	—
Pt100	0 to 65,535	-32,768 to 32,767	-2,000 to 8,500	-3,280 to 15,620	—	—	—
Pt1000	0 to 65,535	-32,768 to 32,767	-2,000 to 6,000	-3,280 to 11,120	—	—	—
Ni100	0 to 65,535	-32,768 to 32,767	-600 to 1,800	-760 to 3,560	—	—	—
Ni1000	0 to 65,535	-32,768 to 32,767	-600 to 1,800	-760 to 3,560	—	—	—
NTC Thermistor	0 to 65,535	-32,768 to 32,767	-900 to 1,500	-1,300 to 3,020	—	—	—
PTC Thermistor	0 to 65,535	-32,768 to 32,767	—	—	100 to 10,000	—	—
PTC Thermistor (threshold)*3	1/2/4	—	—	—	—	—	—
Ohm meter	0 to 65,535	-32,768 to 32,767	—	—	100 to 32,000	—	—
Expansion 0 to 20mA DC	0 to 4,095	-32,768 to 32,767	—	—	—	0 to 65,535	-32,768 to 32,767
Expansion 4 to 20mA DC	0 to 4,095	-32,768 to 32,767	—	—	—	0 to 65,535	-32,768 to 32,767

*1 **Binary data (12bit)** and **Optional range (12bit)** are displayed only for FC6A-J8A1 and FC6A-J8A4.

*2 **Min.** and **Max.** can be configured in the range of -32,768 to 32,767 only when **Optional range** is configured to **Data Type**. However, when **PTC Thermistor (threshold)** is configured to **Signal Type**, the range of **Min.** and **Max.** is 100 to 10,000. For **Optional range**, refer to "Optional range" on page 30-16.

*3 For details, refer to "PTC Thermistor (Threshold)" on page 30-21.

■ Filter

The analog input is filtered so it reaches approximately 99% of the analog input in the set time. Rapid fluctuations in the analog input can be reduced by setting the filter, but increasing the filter slows down the tracking of fluctuations in the analog input. The filter must be set for each channel.

Input filter example

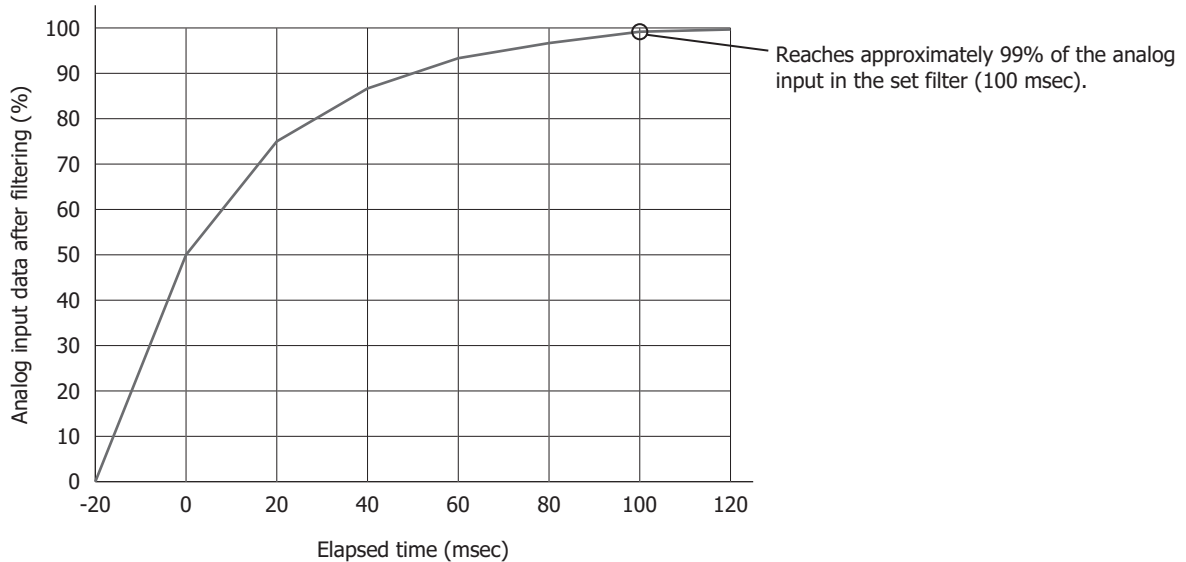

Filter	Description
0 msec	The value is not filtered.
50 to 50,000 msec	The analog input filter can be set in 50 milliseconds increments. The analog input is filtered so that approximately 99% of the analog input is reached in the specified filter.

■ Sampling Time

Analog values are converted to digital values at the interval of the sampling time. Depending on the analog I/O module, you may be able to change the sampling time setting.

Type	Signal Type	Sample Time
FC6A-J2C1 FC6A-J2C4	0 to 10V DC	1 msec
	-10 to +10V DC	1 msec
	0 to 20mA DC	1 msec
	4 to 20mA DC	1 msec
FC6A-J4A1 FC6A-J4A4	0 to 10V DC	1 msec or 10 msec
	-10 to +10V DC	1 msec or 10 msec
	0 to 20mA DC	1 msec or 10 msec
	4 to 20mA DC	1 msec or 10 msec
FC6A-J8A1 FC6A-J8A4	0 to 10V DC	1 msec or 10 msec
	-10 to +10V DC	1 msec or 10 msec
	0 to 20mA DC	1 msec or 10 msec
	4 to 20mA DC	1 msec or 10 msec
	Expansion 0 to 20mA DC	1 msec or 10 msec
	Expansion 4 to 20mA DC	1 msec or 10 msec

Type	Signal Type	Sample Time
FC6A-J4CN1 FC6A-J4CN4	0 to 10V DC	100 msec or 10 msec
	-10 to +10V DC	100 msec or 10 msec
	0 to 20mA DC	100 msec or 10 msec
	4 to 20mA DC	100 msec or 10 msec
	Thermocouple	104 msec
	Resistance thermometer	104 msec
FC6A-J4CH1Y FC6A-J4CH4Y	Thermocouple	120 msec or 30 msec* ¹
FC6A-J8CU1 FC6A-J8CU4	Thermocouple	104 msec
	NTC Thermistor, PTC Thermistor	104 msec
	PTC Thermistor (threshold)	104 msec
	Ohm meter	104 msec
FC6A-L06A1 FC6A-L06A4	0 to 10V DC	1 msec or 10 msec
	-10 to +10V DC	1 msec or 10 msec
	0 to 20mA DC	1 msec or 10 msec
	4 to 20mA DC	1 msec or 10 msec
FC6A-L03CN1 FC6A-L03CN4	0 to 10V DC	100 msec or 10 msec
	-10 to +10V DC	100 msec or 10 msec
	0 to 20mA DC	100 msec or 10 msec
	4 to 20mA DC	100 msec or 10 msec
	Thermocouple	104 msec
	Resistance thermometer	104 msec

■ Thermistor settings

When **NTC Thermistor** is selected as **Signal Type** for the FC6A-J8CU1 or FC6A-J8CU4, the following parameters must be set.

Parameter	Description	Range
R0	The thermistor resistance in "T0" °C (Ω)* ²	0 to 65,535
T0	Temperature (°C)* ²	-32,768 to 32,767
B	Thermistor B constant* ²	-32,768 to 32,767

The characteristic of NTC Thermistor is the resistance decreases as the temperature rises. The analog modules measure the resistance of the thermistor and calculate the temperature based on above three parameters.

The measurable range of the resistance of NTC Thermistor is 100 Ω to 200,000 Ω . The range of temperature that can be calculated is -90°C to 150°C. Select NTC Thermistor that functions within those ranges.

■ Data

Data refers to the input analog values converted to digital values at the interval of the sampling time.

The data is not guaranteed when the **Satus** is a value other than "0". For details on when **PTC Thermistor** (threshold) is selected as **Signal Type**, refer to "PTC Thermistor (Threshold)" on page 30-21.

*1 When the **Sampling Time** is set to 30 milliseconds, the modules may be more easily affected by commercial power supply noise (50/60 Hz noise) and fluctuations in input values may become larger. If there are large fluctuations in input values, change the **Sampling Time** to 120 milliseconds.

*2 Information are described in the instruction sheet for the thermistor to use.

■ Status

The status of the analog input **Data** is stored in data registers.

Status	Description
0	Operating normally
1	Converting data
2	Initializing
3	Parameter setting error
4	Hardware fault (external power supply error)
5	Wiring fault (out of maximum range error)
6	Wiring fault (out of minimum range error)
7	Reserved
8	When the analog input value is greater than 20 mA and less than the upper limit value ^{*1}
9	When the analog input value is greater than the lower limit value and less than 4 mA ^{*2}
10 to 65,535	Reserved

Out of range error for Analog Input Value (Status: 5, 6)

When the analog input value reaches or exceeds the following upper limit, the out of maximum range error occurs.

When the analog input value falls below the following lower limit, the out of minimum range error occurs.

Signal Type	Lower Limit Value	Upper Limit Value
0 to 10V DC	-0.2 V	10.2 V
-10 to +10V DC	-10.4 V	10.4 V
0 to 20mA DC	-0.4 mA	20.4 mA
4 to 20mA DC	3.68 mA	20.32 mA
Type K thermocouple	-200.0°C	1,300.0°C
Type J thermocouple	-200.0°C	1,000.0°C
Type R thermocouple	0.0°C	1,760.0°C
Type S thermocouple	0.0°C	1,760.0°C
Type B thermocouple	0.0°C	1,820.0°C
Type E thermocouple	-200.0°C	800.0°C
Type T thermocouple	-200.0°C	400.0°C
Type N thermocouple	-200.0°C	1,300.0°C
Type C thermocouple	0.0°C	2,315.0°C
Pt100	-200.0°C	850.0°C
Pt1000	-200.0°C	600.0°C
Ni100	-60.0°C	180.0°C
Ni1000	-60.0°C	180.0°C
NTC Thermistor	-90.0°C or 200 kΩ ^{*3}	150.0°C or 100 Ω ^{*4}
PTC Thermistor	100 Ω	10 kΩ
PTC Thermistor (threshold)	100 Ω	10 kΩ
Ohm meter	100 Ω	32 kΩ
Expansion 0 to 20mA DC	-0.4 mA	23.54 mA
Expansion 4 to 20mA DC	1.20 mA	23.17 mA

*1 **Signal Type** is only **Expansion 0 to 20mA DC** or **Expansion 4 to 20mA DC**.

*2 **Signal Type** is **Expansion 4 to 20mA DC** only.

*3 Out of minimum range error occurs when a resistance of 200 kΩ or higher is connected.

*4 Out of maximum range error occurs when a resistance of 100 Ω or lower is connected.

PTC Thermistor (Threshold)

This section describes details on PTC thermistor (threshold).

The value is stored in **Data** according to the resistance of the PTC thermistor and the values of **Min.** and **Max.**.

The relationship between the resistance of the PTC thermistor, the values of **Min.** and **Max.**, and **Data** is as follows.

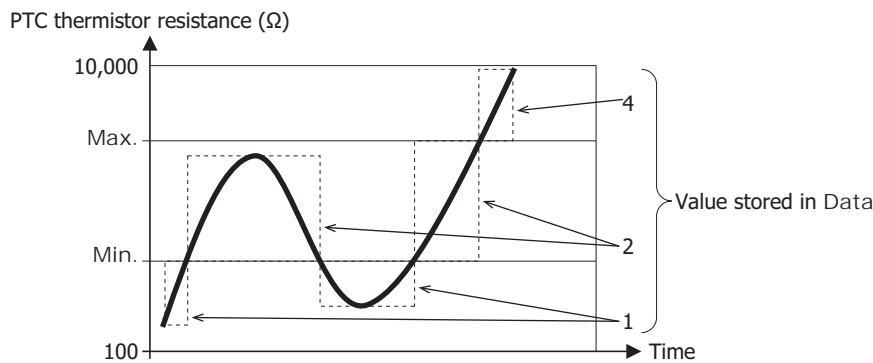

Value stored in **Data** : 1 **Min.** > PTC thermistor resistance

Value stored in **Data** : 2 **Min.** \leq PTC thermistor resistance **Max.**

Value stored in **Data** : 4 **Max.** < PTC thermistor resistance

For the operation when the resistance of the PTC thermistor matches the value of **Min.** or **Max.**, see "Hysteresis" below.

Hysteresis

The system has a hysteresis of $\pm 20 \Omega$ for **Min.** and **Max.** that are set. For example, if **Min.** is set to 1,500 and **Max.** is set to 7,000, the operation is shown as follows.

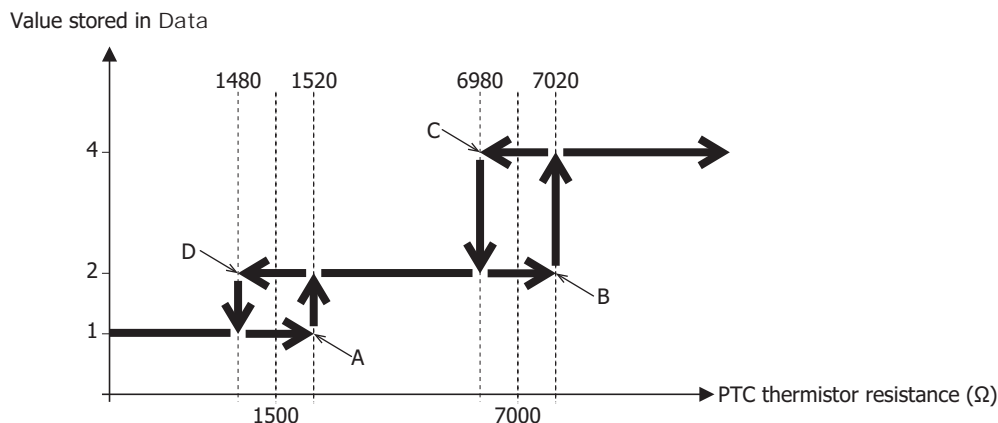

A : The value of **Data** changes from 1 to 2 when the resistance of the PTC thermistor is greater than or equal to 1,520 Ω .

B : The value of **Data** changes from 2 to 4 when the resistance of the PTC thermistor exceeds 7,020 Ω .

C : The value of **Data** changes from 4 to 2 when the resistance of the PTC thermistor is less than or equal to 6,980 Ω .

D : The value of **Data** changes from 2 to 1 when the resistance of the PTC thermistor is less than 1,480 Ω .



When setting **Min.** and **Max.**, ensure that the difference between the two values is 41 or greater. If the difference between the **Min.** and **Max.** is less than or equal to 40, Status 3 (Parameter setting error) is stored in **Status**.

Behavior of the Status

If the resistance of the PTC thermistor is out of range, the following values are stored in **Status**.

If the resistance of the PTC thermistor is less than 100 Ω , status 6 (Wiring fault (out of minimum range error)) is stored in **Status**.

If the resistance of the PTC thermistor is greater than 10,000 Ω , status 5 (Wiring fault (out of maximum range error)) is stored in **Status**.

● Analog Output Type

The following parameters are for configuring the analog outputs on the analog output modules and the mixed analog I/O modules.

YES: Supported, NO: Not supported

Parameter	FC6A-K2A1 FC6A-K2A4	FC6A-K4A1 FC6A-K4A4	FC6A-L06A1 FC6A-L06A4	FC6A-L03CN1 FC6A-L03CN4
Signal Type	YES	YES	YES	YES
Data Type	YES	YES	YES	YES
Minimum and Maximum values	YES	YES	YES	YES
Data	YES	YES	YES	YES
Status	YES	YES	YES	YES

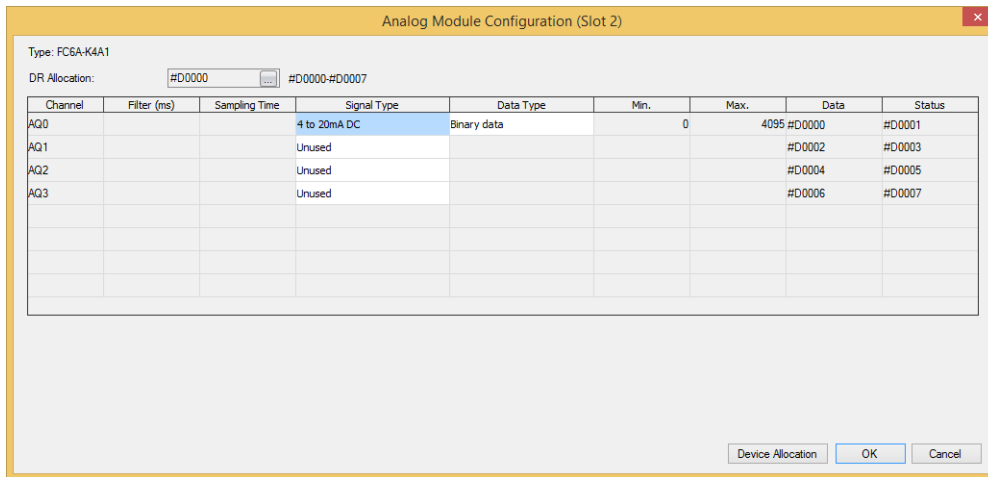

■ Signal Type

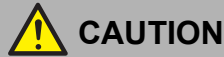

CAUTION

The device connected to the analog I/O module may be damaged if the analog output signal type is mistakenly set and used. Please use caution when setting the analog output signal type.

The signal type that can be set differs according to the analog I/O module model. Select the analog I/O module that corresponds to the user application and set the signal type. There are five types of signal types for the analog outputs, which are detailed as follows.

YES: Supported, NO: Not supported

Signal Type	FC6A-K2A1 FC6A-K2A4	FC6A-K4A1 FC6A-K4A4	FC6A-L06A1 FC6A-L06A4	FC6A-L03CN1 FC6A-L03CN4
Unused*1	YES	YES	YES	YES
0 to 10V DC	YES	YES	YES	YES
-10 to +10V DC	YES	YES	YES	YES
0 to 20mA DC	YES	YES	YES	YES
4 to 20mA DC	YES	YES	YES	YES

*1 Channels that are set to **Unused** are not scanned. A channel set to unused always outputs 0 V. The circuit is setup the same as when **0 to 10V DC** is selected as **Signal Type**.

■ Data Type

The analog output value can be handled as the set data type. There are two data types for the analog outputs.

YES: Supported, NO: Not supported

Data Type	FC6A-K2A1 FC6A-K2A4	FC6A-K4A1 FC6A-K4A4	FC6A-L06A1 FC6A-L06A4	FC6A-L03CN1 FC6A-L03CN4
Binary data	YES	YES	YES	YES
Optional range	YES	YES	YES	YES

■ Min., Max.

The value written to the data register is output from the analog output. The values of **Min.** and **Max.** that can be written are determined by the set **Signal Type** and **Data Type**. A parameter setting error occurs when a value is set that exceeds the value of **Min.** or **Max.** .

The minimum and maximum values that correspond to the signal types and data types are as follows.

Signal Type	Data Type	
	Binary data	Optional range*1
0 to 10V DC	0 to 4,095	-32,768 to 32,767
-10 to +10V DC	-2,048 to 2,047	-32,768 to 32,767
0 to 20mA DC	0 to 4,095	-32,768 to 32,767
4 to 20mA DC	0 to 4,095	-32,768 to 32,767

■ Data

The analog output data for the analog output set with the **Signal Type**, the **Data Type**, the **Min.** and the **Max.** is stored in the data registers in the END progressing of each scan. The actual analog output data is not guaranteed when the analog output **Status** is a value other than "0". However, 0V is output when **Signal Type** is set to **-10 to +10V DC**.

■ Status

The status of the analog output **Data** is stored in data registers.

Status	Description
0	Operating normally
1	Reserved
2	Initializing
3	Parameter setting error
4	Hardware fault (external power supply error)
5 to 65,535	Reserved

*1 **Min.** and **Max.** can be set only when **Data Type** is set to **Optional range**. Set the values of **Min.** and **Max.** between -32,768 and 32,767.

● Control Registers

For the **DR Allocation**, configures the data register as the device to which each parameter of the analog I/O module is written.

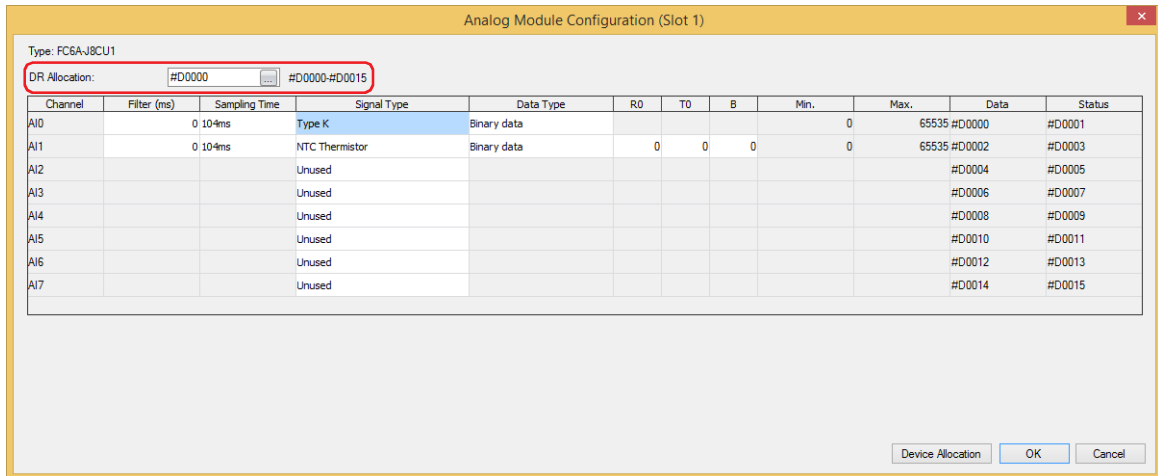

Multiple words are used starting from the configured data register. The number of words of data registers that are used varies based on the analog I/O module model.

Used Data Registers (words)					
FC6A-J2C1 FC6A-J2C4	FC6A-J4A1 FC6A-J4A4	FC6A-J8A1 FC6A-J8A4	FC6A-J4CN1 FC6A-J4CN4	FC6A-J4CH1Y FC6A-J4CH4Y	FC6A-J8CU1 FC6A-J8CU4
4	8	16	8	8	16

Used Data Registers (words)			
FC6A-K2A1 FC6A-K2A4	FC6A-K4A1 FC6A-K4A4	FC6A-L06A1 FC6A-L06A4	FC6A-L03CN1 FC6A-L03CN4
4	8	12	6

3.3 Device Allocation

● Analog Input Module

Allocation of device address for the analog input module is shown below.

For details about the parameter setting values, refer to "Analog Input Parameter Setting Values" on page 30-25.

Channel No.	Parameter	R/W	FC6A-J2C1	FC6A-J4A1	FC6A-J8A1	FC6A-J4CN1	FC6A-J4CH1Y	FC6A-J8CU1
			FC6A-J2C4	FC6A-J4A4	FC6A-J8A4	FC6A-J4CN4	FC6A-J4CH4Y	FC6A-J8CU4
			Address Number	Address Number	Address Number	Address Number	Address Number	Address Number
CH0	Analog input data	R	+0	+0	+0	+0	+0	+0
	Analog input status	R	+1	+1	+1	+1	+1	+1
CH1	Analog input data	R	+2	+2	+2	+2	+2	+2
	Analog input status	R	+3	+3	+3	+3	+3	+3
CH2	Analog input data	R	—	+4	+4	+4	+4	+4
	Analog input status	R	—	+5	+5	+5	+5	+5
CH3	Analog input data	R	—	+6	+6	+6	+6	+6
	Analog input status	R	—	+7	+7	+7	+7	+7
CH4	Analog input data	R	—	—	+8	—	—	+8
	Analog input status	R	—	—	+9	—	—	+9
CH5	Analog input data	R	—	—	+10	—	—	+10
	Analog input status	R	—	—	+11	—	—	+11
CH6	Analog input data	R	—	—	+12	—	—	+12
	Analog input status	R	—	—	+13	—	—	+13
CH7	Analog input data	R	—	—	+14	—	—	+14
	Analog input status	R	—	—	+15	—	—	+15

Analog Input Parameter Setting Values

The parameter setting values are as follows.

■ Signal Type

Setting Value	Signal Type
0	Unused
1	0 to 10V DC
2	-10 to +10V DC
3	0 to 20mA DC
4	4 to 20mA DC
5	Type K thermocouple
6	Type J thermocouple
7	Type R thermocouple
8	Type S thermocouple
9	Type B thermocouple
10	Type E thermocouple
11	Type T thermocouple
12	Type N thermocouple
13	Type C thermocouple
14	Pt100
15	Pt1000
16	Ni100

Setting Value	Signal Type
17	Ni1000
18	NTC Thermistor
19	PTC Thermistor
20	PTC Thermistor (threshold)
21	Ohm meter
22	Expansion 0 to 20mA DC
23	Expansion 4 to 20mA DC

If the setting value is outside the range, a parameter setting error will occur.

■ Data Type

Setting Value	Data Type
0	Binary data, Binary data (12bit)
1	Optional range, Optional range (12bit)
2	Celsius (°C), Resistance (Ω), Binary data (16bit)
3	Fahrenheit (°F), Optional range (16bit)

If the setting value is 4 to 65,535, a parameter setting error will occur.

■ Min., Max.

The values of **Min.** and **Max.** can be set only when **Data Type** is set to **Optional range**. Set the minimum and maximum values between -32,768 and 32,767. However, when **Signal Type** is set to **PTC Thermistor (threshold)**, set the values of **Min.** and **Max.** between 100 and 10,000.

■ Filter

Setting Value	Filter
0	0 msec
50	50 msec
100	100 msec
150	150 msec
...	...
50,000	50,000 msec

The setting value is rounded by 50.

When 50,001 to 65,535 is stored for the setting value, the filter operates as the maximum value of 50,000 milliseconds.

■ Thermistor constant

Range	Thermistor Constant
0 to 65,535	R0
-32,768 to 32,767	T0
-32,768 to 32,767	B

● Analog Output Module

Allocation of device address for the analog output module is shown below.

For details on the parameter setting values, refer to "Analog Output Parameter Setting Values" on page 30-27.

Channel No.	Parameter	R/W	FC6A-K2A1 FC6A-K2A4 Address Number	FC6A-K4A1 FC6A-K4A4 Address Number
CH0	Analog output data	R	+0	+0
	Analog output status	R	+1	+1
CH1	Analog output data	R	+2	+2
	Analog output status	R	+3	+3
CH2	Analog output data	R	—	+4
	Analog output status	R	—	+5
CH3	Analog output data	R	—	+6
	Analog output status	R	—	+7

Analog Output Parameter Setting Values

The parameter setting values are as follows.

■ Signal Type

Setting Value	Signal Type
0	Unused
1	0 to 10V DC
2	-10 to +10V DC
3	0 to 20mA DC
4	4 to 20mA DC

If the setting value is outside the range, a parameter setting error will occur.

■ Data Type

Setting Value	Data Type
0	Binary data
1	Optional range

If the setting value is 2 to 65,535, a parameter setting error will occur.

■ Min., Max.

The minimum and maximum values can be set only when **Optional range** is selected as **Data Type**. Set the minimum and maximum values between -32,768 and 32,767.

● Mixed Analog I/O Module

Allocation of device address for the mixed analog I/O module is shown below.

For details on the parameter setting values for analog inputs, refer to "Analog Input Parameter Setting Values" on page 30-25. For analog outputs, refer to "Analog Output Parameter Setting Values" on page 30-27.

Channel		Parameter	R/W	FC6A-L06A1 FC6A-L06A4		FC6A-L03CN1 FC6A-L03CN4	
No.	I/O			Address Number	I/O	Address Number	
CH0	Analog data	R	Input	+0	Input	+0	
	Analog status	R		+1		+1	
CH1	Analog data	R		+2		+2	
	Analog status	R		+3	+3		
CH2	Analog data	R		+4	Output	+4	
	Analog status	R		+5		+5	
CH3	Analog data	R		+6	—	—	
	Analog status	R	+7	—	—		
CH4	Analog data	R	Output	+8	—	—	
	Analog status	R		+9	—	—	
CH5	Analog data	R		+10	—	—	
	Analog status	R		+11	—	—	

4 Cyclic Script

HG2J-7U HG5G-V HG4G-V HG4G HG3G-V HG3G HG2G-V HG2G-5F HG2G-5T HG1G HG1P

A Cyclic Script is a script whose trigger condition can be set to a fixed interval (in increments of 10 milliseconds). Only one Cyclic Script can be assigned to the project.

When a script is specified as a Cyclic Script, it executes at the specified fixed intervals independent of the scan time of the screen (processing time for parts on the screen).

4.1 Setting Procedures for Cyclic Script

Follow these steps to program a Cyclic Script.

- 1 On the **Configuration** tab, in the **System Setup** group, click **Project**.

The Project Settings dialog box appears.

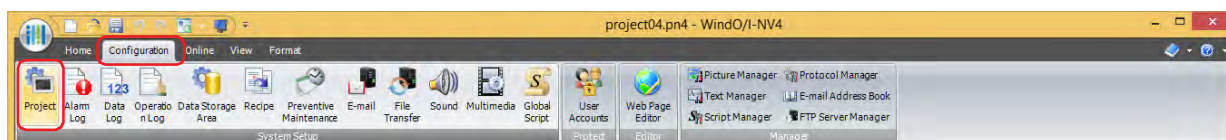

- 2 On the **Expansion Module** tab, select the **Use Cyclic Script** check box.

- 3 Specify the **Script ID** and **Execution Interval**.

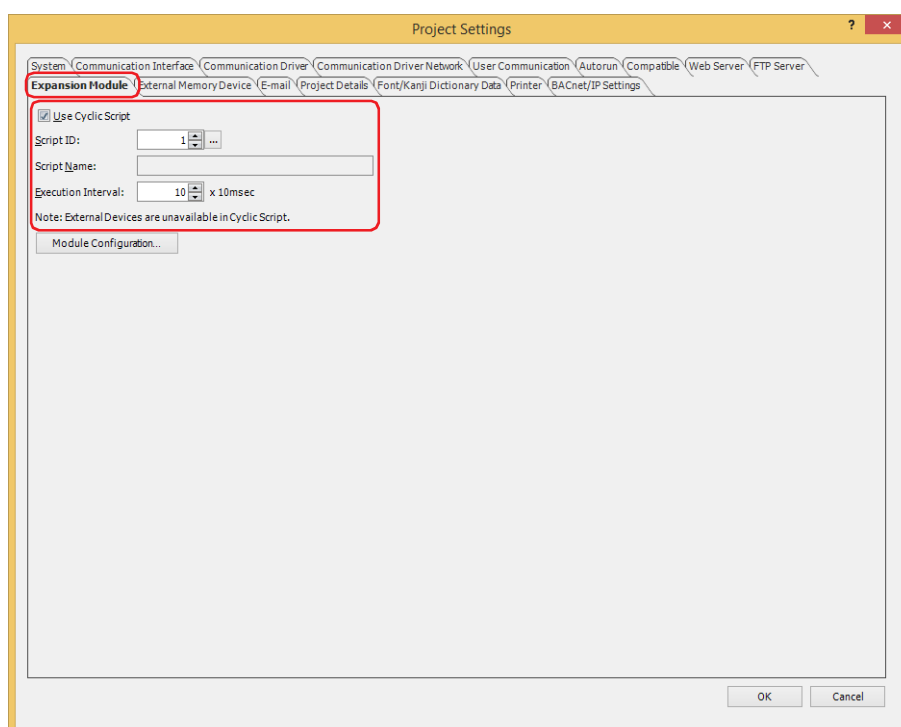

- **Script ID**

Specify the script ID to use (from 1 to 32000) as the Cyclic Script.

- **Execution Interval(x 10msec)**

Specify the interval at which the script should execute from 1 to 100 (10 milliseconds increments). The specified script will execute at the specified intervals.

- 4 Click **OK**.

5 Module Configuration Dialog Box

HG2J-7U HG5G-V HG4G-V HG4G HG3G-V HG3G HG2G-V HG2G-5F HG2G-5T HG1G HG1P

This section describes the **Module Configuration** dialog box to configure the settings for the expansion module.

5.1 Overview

The MICRO/I is capable of using the expansion modules described in “1.2 Applicable Expansion Modules” on page 30-2. To use an expansion module, insert the expansion module to be connected to MICRO/I on the **Module Configuration** dialog box.

● Module Configuration Dialog Box

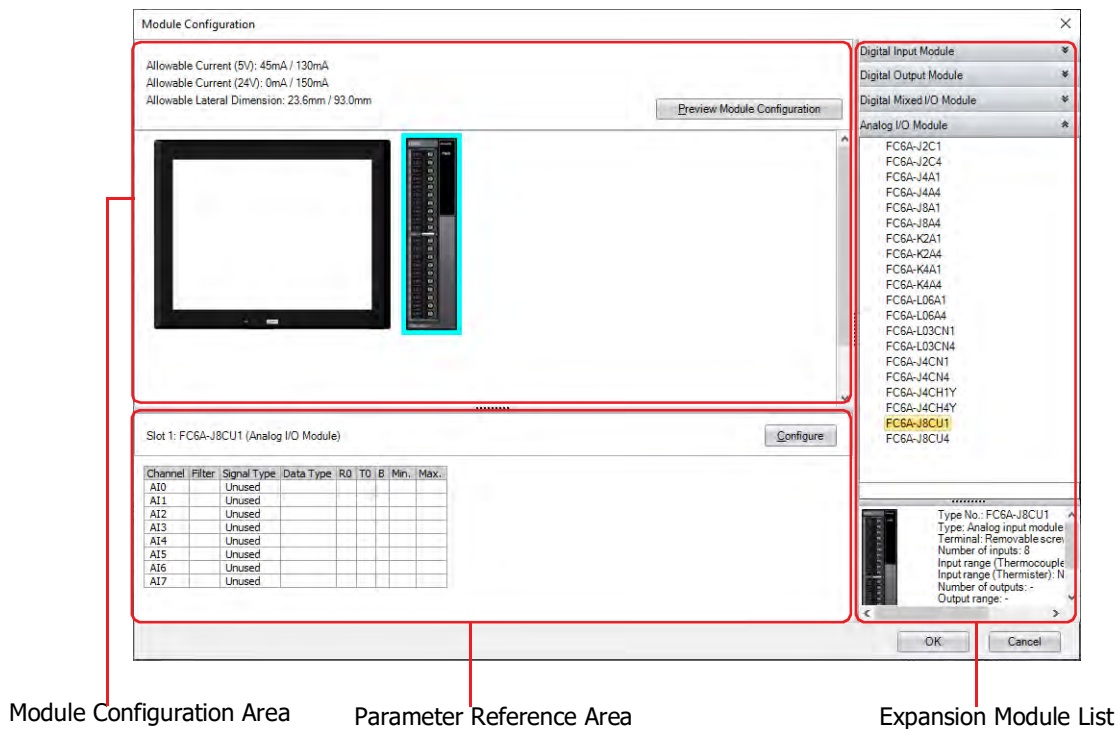

Module Configuration Area: Displays the configuration of connected expansion modules.

Preview Module Configuration: Previews the image of the CPU module and expansion module set in the module configuration area. Click this button to display the Preview Module Configuration dialog box.



You can copy the previewed image to the clipboard by clicking the **Copy to clipboard** button on the Preview Module Configuration dialog box.

Expansion Module List: Displays a list of expansion modules that can be connected to the MICRO/I.

Parameter Reference Area: Displays the parameters that are configured for the expansion modules.

Configure: Configure each parameter of the expansion module. Click this button to display the configuration dialog box that corresponds to the expansion module.

The module configuration can be created by selecting the expansion modules to use in the expansion modules list and dragging and dropping them to the module configuration area.

5.2 Basic Operations for Module Configuration Dialog Box

- Open the Module Configuration dialog box

1 On the **Configuration** tab, in the **System Setup** group, click **Project**.

The Project Settings dialog box is displayed.

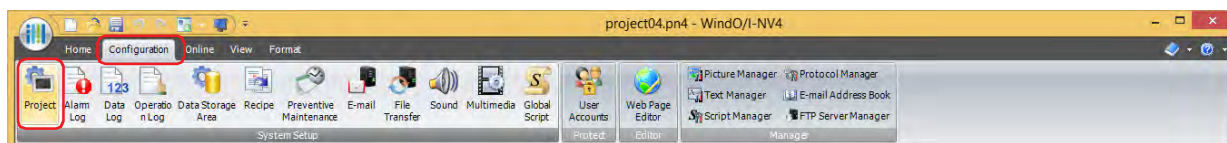

2 Click the **Expansion Module** tab in the **Project Settings** dialog box, and then click **Module Configuration**.

The Module Configuration dialog box is displayed.

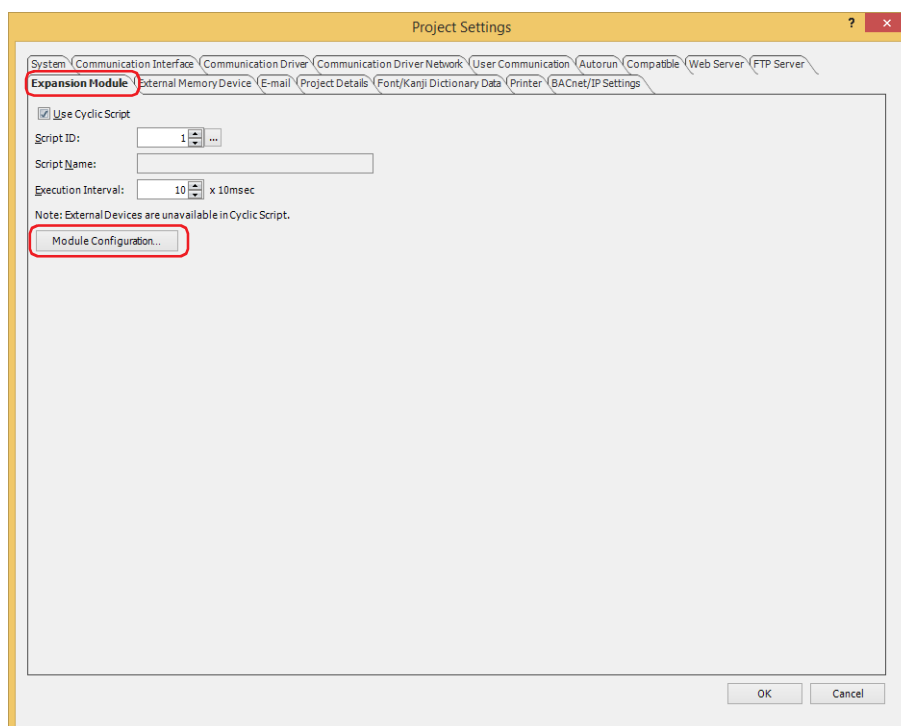

● Inserting Expansion Modules

- 1 Select the expansion module to insert in the Expansion Module List, and then drag and drop it to the Module Configuration Area.

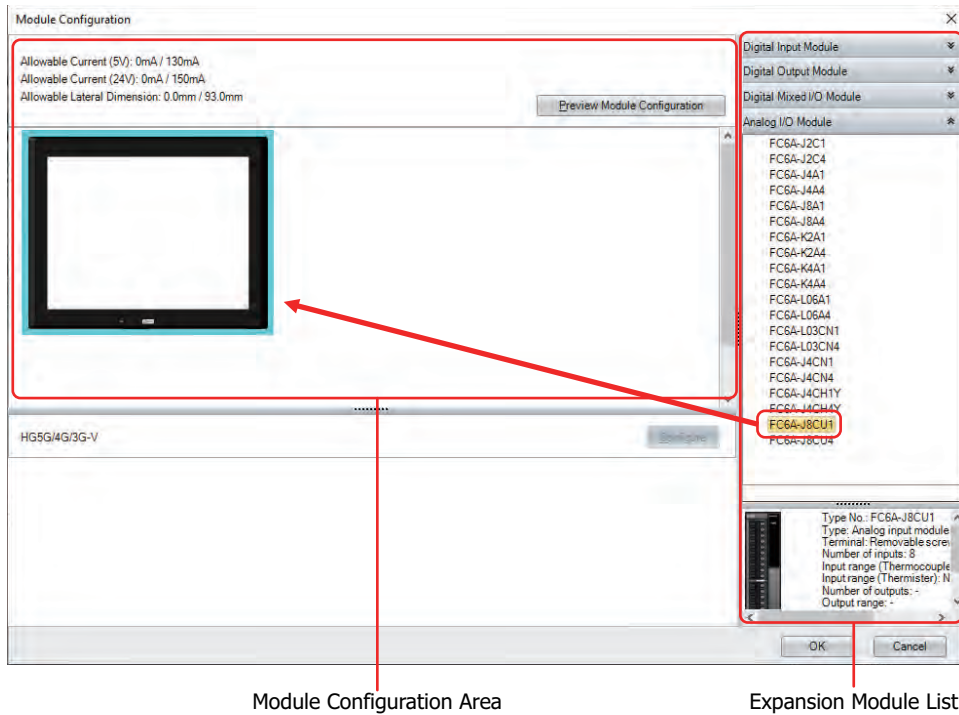

- 2 Click the inserted expansion module in the Module Configuration Area, and then click **Configure**. The configuration dialog box that corresponds to the expansion module is displayed.

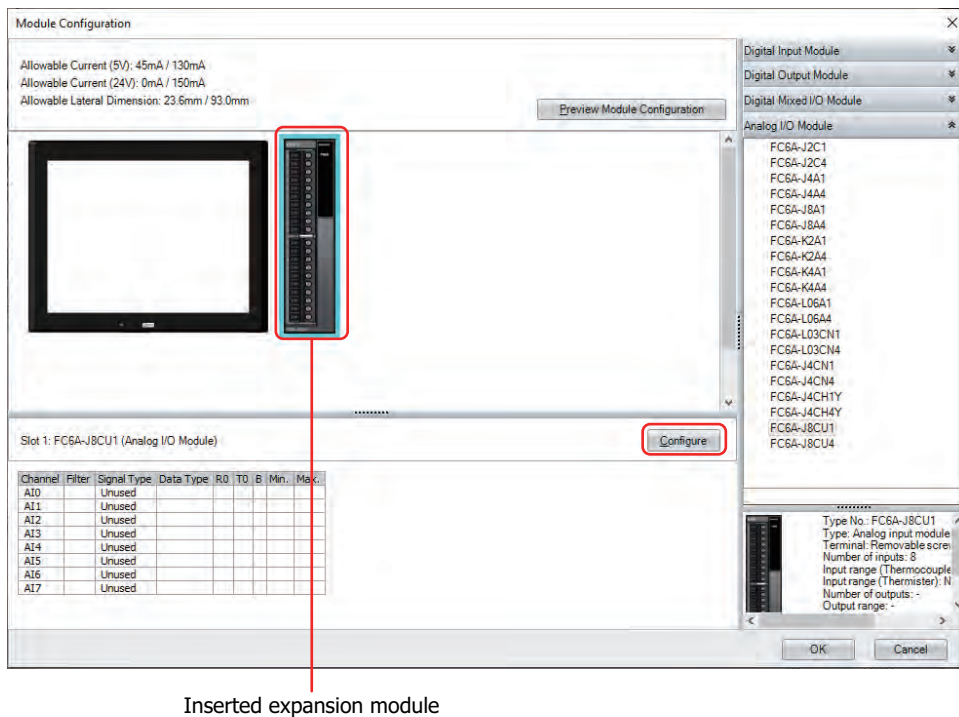

- 3 In the configuration dialog box, configure the parameters for the expansion module.

Analog Module Configuration (Slot 1)

Type: FC6A-J8CU1

DR Allocation: #D0000 #D0000-#D0015

Channel	Filter (ms)	Sampling Time	Signal Type	Data Type	R0	T0	B	Min.	Max.	Data	Status
AI0		0.104ms	Type K	Binary data				0	65535	#D0000	#D0001
AI1		0.104ms	NTC Thermistor	Binary data	0	0	0	0	65535	#D0002	#D0003
AI2			Unused							#D0004	#D0005
AI3			Unused							#D0006	#D0007
AI4			Unused							#D0008	#D0009
AI5			Unused							#D0010	#D0011
AI6			Unused							#D0012	#D0013
AI7			Unused							#D0014	#D0015

Device Allocation OK Cancel

● Deleting Expansion Module

- 1 Click the expansion module to remove in the Module Configuration Area.

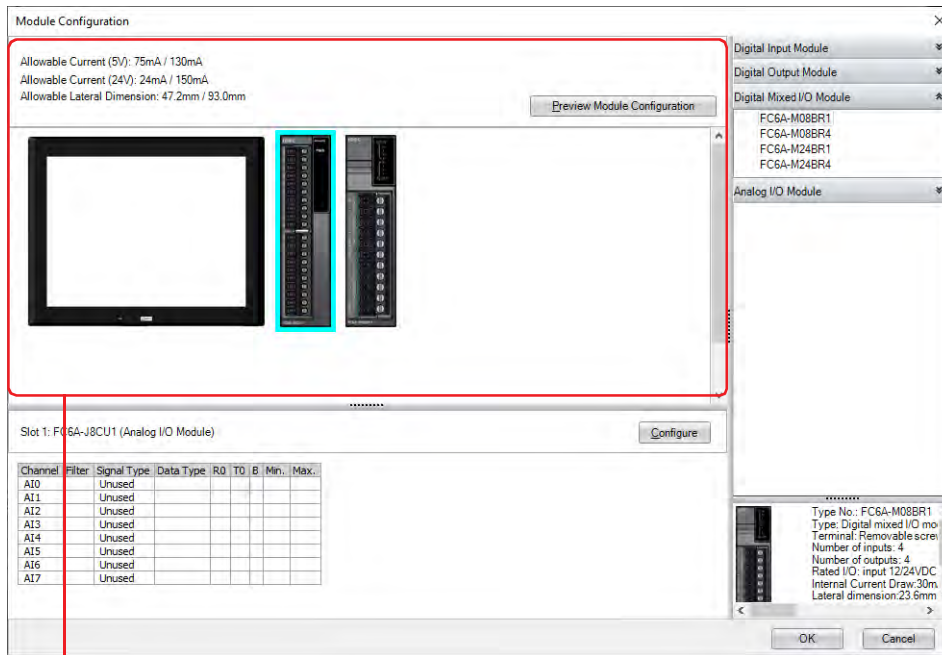

Module Configuration Area

- 2 Right-click the expansion module to delete, and then click **Remove**.

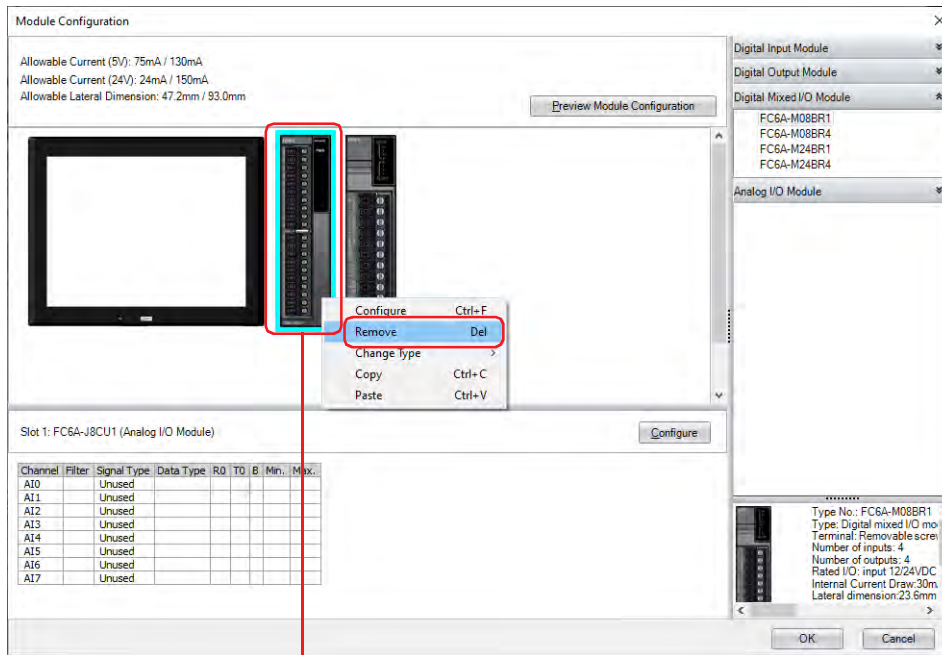

Expansion module to delete

The selected expansion module is deleted and all of the extension modules placed on the right side of the deleted extension module are automatically shifted to the left.

● Swapping Expansion Module

- 1 Select the expansion module to be moved, and then drag and drop it at the destination.

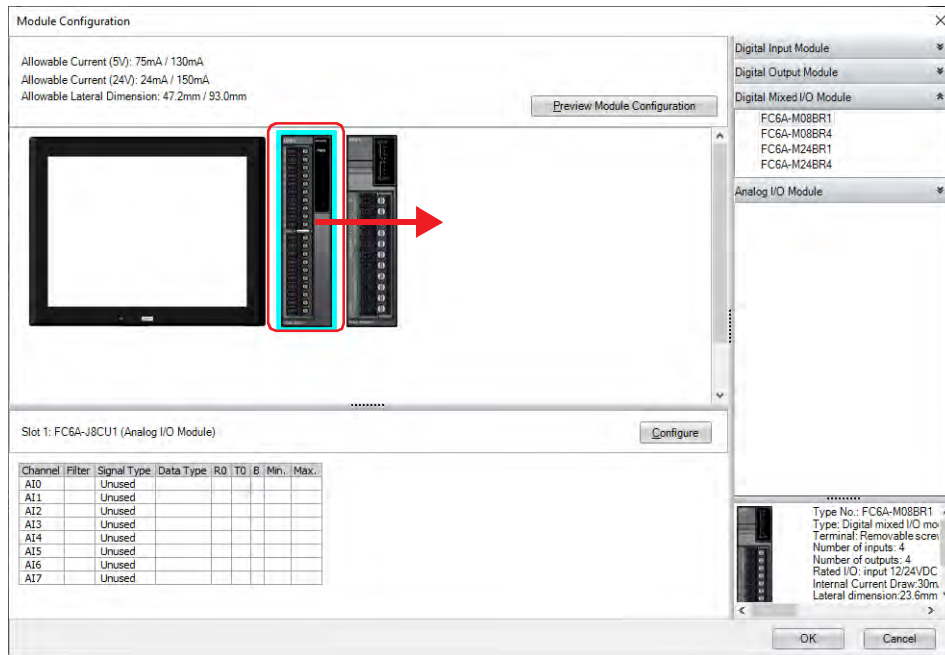

If you change the position of the digital I/O module, the device address is automatically reassigned. However, the device addresses configured in the editing project are not changed.

Example: When swapping the digital input modules, reassign the device addresses as follows.

However, the device address of the part (Pilot Lamp) configured in the project is not changed.

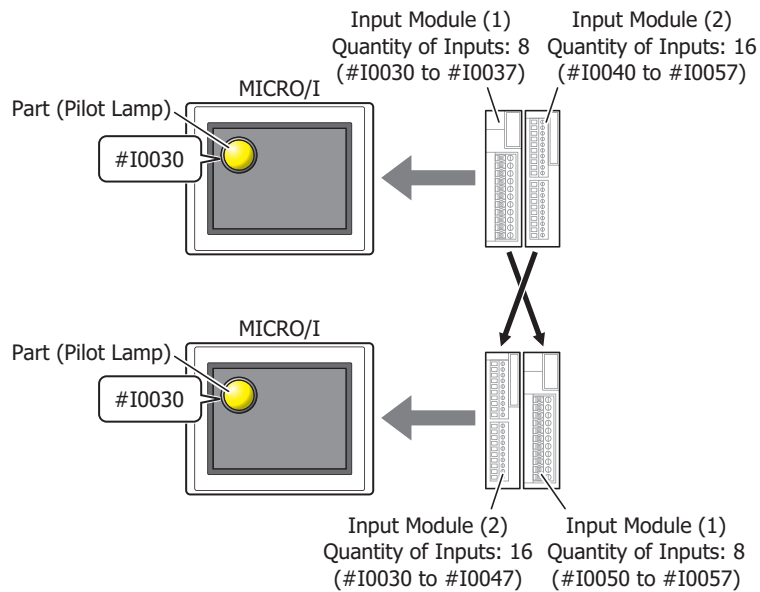

This chapter describes the specifications, functions, and notes to observe when using external memory devices with the MICRO/I.

1 External Memory Devices

HG2J-7U HG5G-V HG4G-V HG4G HG3G-V HG3G HG2G-V HG2G-5F HG2G-5T HG1G HG1P

1.1 Supported External Memory Devices

External memory device such as the SD memory card and the USB flash drive are used on the MICRO/I interface. The supported external memory device is different for each MICRO/I model.

External Memory Device	HG2J-7U, HG2G-5T, HG1G/1P	HG5G/4G/3G/2G-V, HG4G/3G, HG2G-5F
SD memory card	NO	YES
USB flash drive*1	YES	YES

1.2 What Can Be Done Using an External Memory Device

The following functions are available when an external memory device is inserted in the MICRO/I interface. (The letters in parentheses are engraved on the back of the main unit.)

Functions	HG2J-7U		HG5G/4G/3G/2G-V, HG4G/3G, HG2G-5F	HG2G-5T, HG1G/1P	Reference	
	USB flash drive (USB1)	USB flash drive (USB2)	SD memory card (SD)	USB flash drive (USB2)		
Screenshot	YES	NO	YES	NO	YES	Page 8-58 Page 12-27
Alarm Log output	YES	NO	YES	NO	YES	Page 13-20
Data Log output	YES	NO	YES	NO	YES	Page 14-18
Reading/writing recipe data	YES	NO	YES	NO	YES	Page 18-10
Displaying picture files	YES	NO	YES	NO	YES	Page 2-29
Playing sound files	YES	NO	YES*2	NO	NO	Page 21-7
Recording video camera images and microphone sounds.	NO	NO	YES*3*4	NO	NO	Page 22-1
Playing movie files	NO	NO	YES*3	NO	NO	Page 22-1
Transferring projects and PLC programs, copying files	YES	YES	YES	YES	YES*5	Page 29-1
USB Autorun function	YES*6	YES*6	NO	YES	YES	Page 31-19
USB Popup Screen function	YES*6	YES*6	NO	YES	YES	Page 31-35
Displaying Custom Web Page	YES	NO	YES	NO	YES	Page 28-12

*1 USB2.0

*2 This is applicable for models with an audio interface only.

*3 This is applicable for models with a video interface only.

*4 Recording sound function is for HG4G/3G only

*5 The File Copy function is not supported

*6 Only the port where the USB flash drive that saved the USB autorun definition file (hgauto.ini) is inserted first, either USB1 or USB2.

1.3 Specifications of External Memory Devices

● SD memory card

Models support SD memory cards with the following specifications:

- SD memory cards: max capacity 2 GB. SDHC memory cards: 2 GB to 32 GB.
- Compatible with FAT16 or FAT32 formatting.

Note, SD memory cards with less than 2 GB of capacity must be FAT16 formatted. FAT32 formatted cards cannot be recognized.

- The maximum size of files that can be read and written is 256 MB.
- File names may be up to 120 characters long. (Includes file extensions.)
- File paths may be up to 250 characters long. (Includes file extensions and drive letters.)
- Only alphanumeric characters and symbols can be used for file names and folder names. However, must not contain the following characters:

" * / : < > ? \ |



Use of IDEC, HG9Z-XMS2 SD memory card (2 GB capacity) is recommended.

Check the IDEC web site for more information about compatible SD memory cards.

● USB flash drive

Models support USB flash drives with the following specifications:

- Max capacity 32 GB.
- Compatible with FAT16 or FAT32 formatted USB flash drives.
- The maximum file size that can be read and written is 256 MB.
- File names may be up to 120 characters long. (Includes file extensions.)
- File paths may be up to 250 characters long. (Includes file extensions and drive characters.)
- Only alphanumeric characters and symbols can be used for file names and folder names. However, must not contain the following characters:

HG2J-7U: " # \$ & ' () * / : ; < > ? \ ` | ~

Two consecutive periods

HG5G/4G/3G/2G-V, HG4G/3G, HG2G-5F/-5T, HG1G/1P: " * / : < > ? \ |



Check the IDEC web site for more information about compatible USB flash drives.

1.4 File structure

When downloading or uploading data using the System Mode on the MICRO/I, or WindO/I-NV4, the following files and folders are accessible. This folder is called the External Memory Device folder. For the HG5G/4G/3G/2G-V, HG4G/3G and HG2G-5F, the External Memory Device folder is created on the SD memory card. And for the HG2J-7U, HG2G-5T and HG1G/1P, it is created on the USB flash drive^{*1}. By default, the External Memory Device folder name is "HGDATA01". For details, refer to "1.6 Setting the External Memory Device Folder" on page 31-12.

Path delimiters vary based on the model. The delimiter of HG2J-7U is slash (/), and HG5G/4G/3G/2G-V, HG4G/3G, HG2G-5F/-5T, HG1G/1P is backslash (\).

Example: HG5G-V

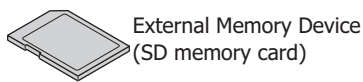

HGDATA01 (External Memory Device folder)

Folder name and File name	Description
\CAPTURE\CAP[date/time].JPG Date/time format: YYYYMMDD_hhmmss	Screenshot data (file name is assigned automatically)
\ALARMLOG\[user-defined].CSV Default file name Batch: ALMHTO.CSV, Real time: ALMHTA.CSV	Alarm Log data
\DATALOG\[user-defined].CSV Default file name Batch: LOGOn.CSV, Real time: LOGAn.CSV	Data Log data (n: Data log channel number)
\DATALOG\DATA\[user-defined].BIN Default file name: LOGAn.BIN	BIN File (n: Data log channel number)
\OPERATIONLOG\[user-defined].CSV Default file name Batch: OPLOGO.CSV, Real time: OPLOGA.CSV	Operation Log data
\RECIPE\[user-defined].CSV Default file name: RCPn.CSV	Recipe data (n: 4 digit sequential number)
\PICTURE\[user-defined].BMP, \PICTURE\[user-defined].JPG	Picture files
\SOUND* ² \[user-defined].WAV	Sound files
\WEBPAGE\	Folders and files are created according to the file structure specified in Web Page Editor.
\RECORD* ³ \[Date] \ [Time].AVI* ⁴ , \RECORD* ³ \[Date] \ [Time].MP4* ⁵ Date format: YYYYMMDD Time format: hhmmss	Movie file saved to dated folder (Folder and file name included automatically)
\MOVIE* ³ \[Custom].AVI* ⁴ , \MOVIE* ³ \[Custom].MP4* ⁵	Movie Files
MOVIE.LST* ³	Movie File List
\NVDATA* ⁶ \[Project name].ZNV	ZNV Project File
\LDRDATA* ⁶ \[Model + port + Station No. + date/time].ZLD	ZLD Project File

HGDATA02



Users can create multiple External Memory Device folders for different projects on a single external memory device. Note, the External Memory Device folder on the external memory device must reside on the root directory.



Do not alter a ZNV Project File(.znv) and a ZLD Project File(.zld). Altered files cannot be used with MICRO/I or PLCs.

- *1 USB flash drive inserted in USB1 for HG2J-7U
- *2 This is applicable for HG2J-7U and models with an audio interface only.
- *3 This is applicable for models with a video interface only.
- *4 HG5G/4G/3G-V only
- *5 HG4G/3G only
- *6 This is possible if uploaded using the File Manager

1.5 Reading/Writing Data

● Using WindO/I-NV4 to read and write to an external memory device inserted in the MICRO/I

This procedure shows how to read and write data to the External Memory Device folder*¹ specified for the project currently running on the MICRO/I.

Use either method below to make the connection.

- Connect a USB cable to the USB port on the computer and the USB interface on the MICRO/I.*²
- Connect an Ethernet cable to the Ethernet port on the computer and the Ethernet interface on the MICRO/I.

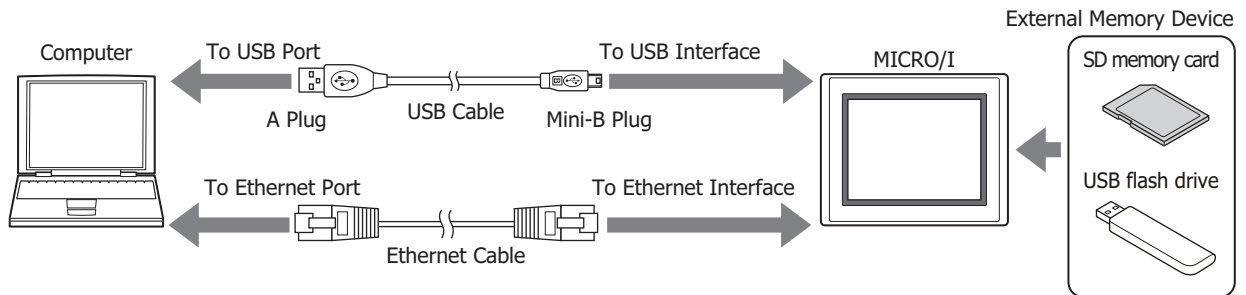

Communication settings

Follow these procedures to configure the communication device and port to allow reading and writing to the external memory device inserted in the MICRO/I.

1 On the **Home** tab, in the **Project** group, click **Comm. Setup**.

The Communication Settings dialog box appears.

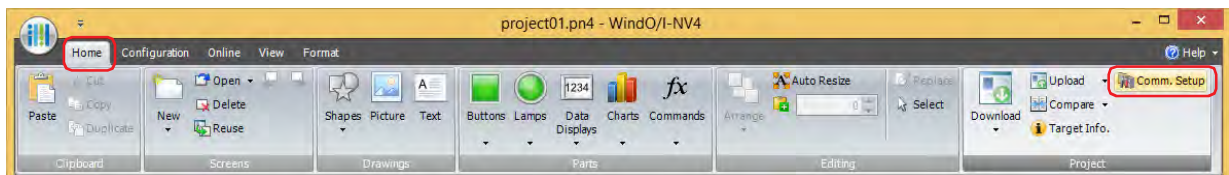

2 Select **Operator Interface** under **Communicate with**.

3 Select the type of connection under **Port**, then click **OK**.

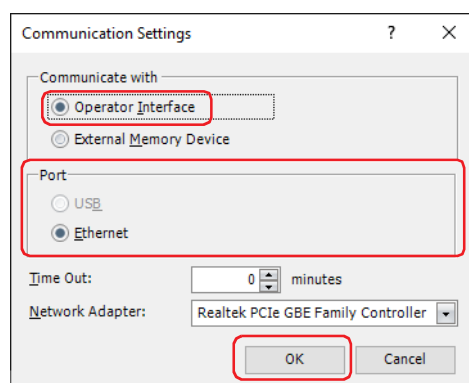

*1 USB flash drive inserted in USB1 for HG2J-7U, SD memory card for HG5G/4G/3G/2G-V, HG4G/3G and HG2G-5F, USB flash drive for HG2G-5T and HG1G/1P

*2 HG5G/4G/3G/2G-V, HG4G/3G, HG2G-5F/-5T, HG1G/1P only

Downloading

This procedure shows how to download a specified file into a folder on the external memory device for the currently running project.

- 1 On the **Home** tab, in the **Project** group, click the arrow under **Download**.
- 2 Click **Files to External Memory Device** or **Files to External Memory Device while running**.

The Open dialog box appears.

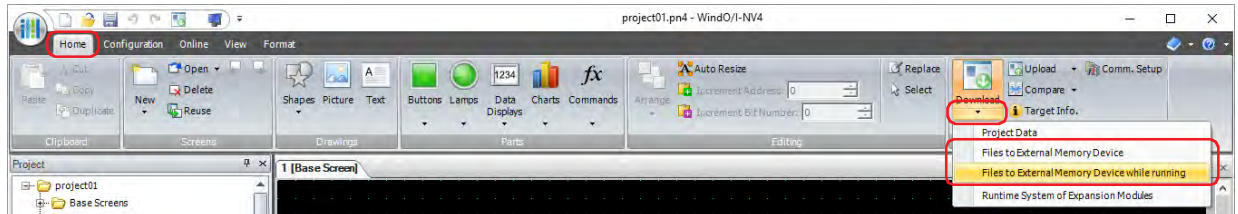

■ Files to External Memory Device

This function temporarily stops the MICRO/I and then downloads files to the external memory device inserted in the MICRO/I. MICRO/I resumes running when files have been downloaded.

■ Files to External Memory Device while running

This function downloads files to the external memory device inserted in the MICRO/I without stopping the MICRO/I.

- 3 Specify the file name and click **Open**.

A confirmation message appears.

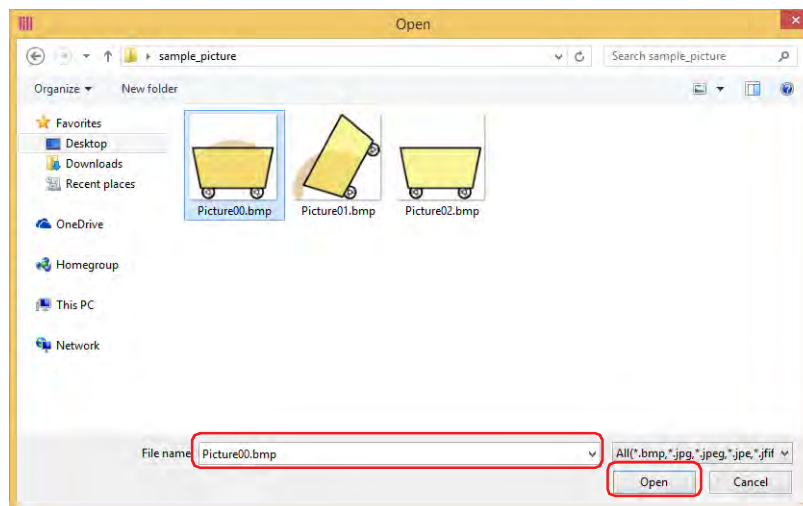

If security is enabled for the project on MICRO/I, a dialog appears for you to enter a user name and password. For details, refer to Chapter 23 "User Accounts and the Security Function" on page 23-1.

- 4 Click **Yes**.

The External Memory Device Maintenance dialog box appears and the file download begins. When the download is complete, a message box appears.

- 5 Click **OK**.

- 6 Click **Close** on the External Memory Device Maintenance dialog box.

Uploading

This procedure shows how to upload specified data from the External Memory Device folder on the external memory device for the currently running project.

- 1 On the **Home** tab, in the **Project** group, click the arrow next to **Upload**.
- 2 Click **Stored Data in External Memory Device**.

The Upload Data from External Memory Device dialog box appears.



- 3 Select the items to be uploaded, and then specify the destination folder in the **Location** box.

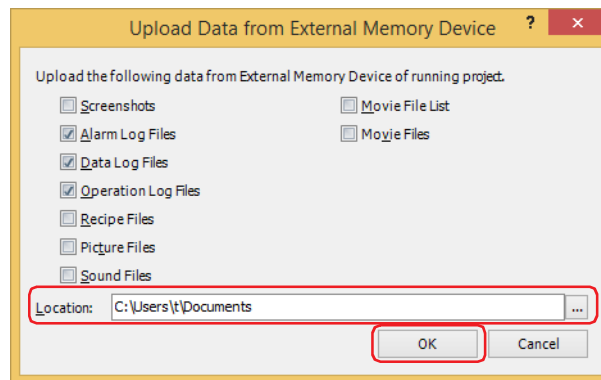

Uploadable data is as follows.

- Screenshots
- Alarm Log Files
- Data Log Files
- Operation Log Files
- Recipe Files
- Picture Files
- Sound Files^{*1}
- Movie File List^{*2}
- Movie Files^{*2}



If security is enabled for the project on MICRO/I, a dialog appears for you to enter a user name and password. For details, refer to Chapter 23 "User Accounts and the Security Function" on page 23-1.



- Click **...** to call up the Select a Folder dialog box and specify the destination folder for uploading.
- After starting WindO/I-NV4, screen shots, alarm log data, data log data, and recipe files can be uploaded from an External Memory Device folder without opening project data.

- 4 Click **OK**.

The External Memory Device Maintenance dialog box appears and the data upload begins.

A message box appears when the data upload is complete.

- 5 Click **OK**.

- 6 Click **Close** on the External Memory Device Maintenance dialog box.

*1 This is applicable for HG2J-7U and models with an audio interface only.

*2 This is applicable for models with a video interface only.

- Using WindO/I-NV4 to read and write to an external memory device inserted in the computer

Insert an external memory device*¹ into the USB port or memory card slot of your computer, or via a docking station, etc.

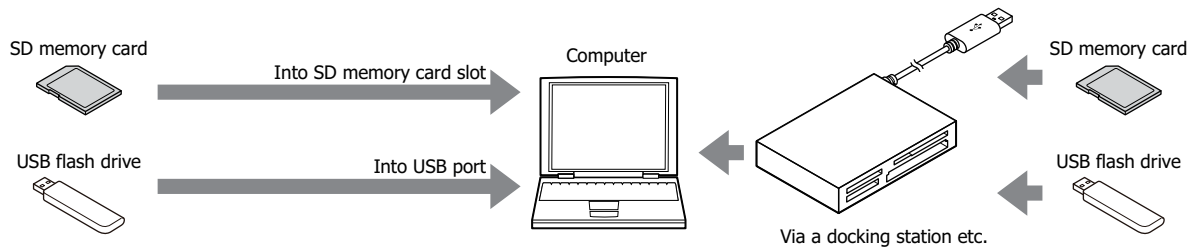

Communication settings

To read and write to the external memory device inserted in the computer using WindO/I-NV4, the external memory device must be specified as the communication device. Configure the communication settings as follows before downloading or uploading.

- 1 On the **Home** tab, in the **Project** group, click **Comm. Setup**.

The Communication Settings dialog box appears.

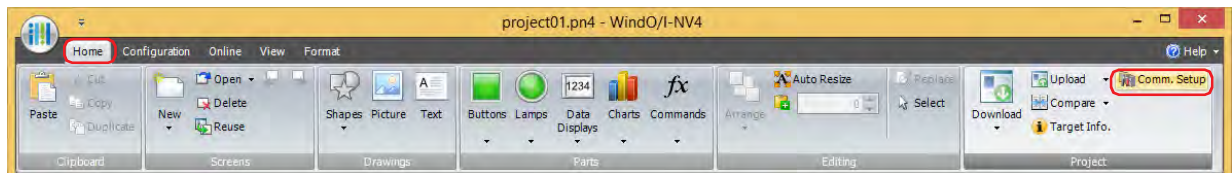

- 2 Under **Communicate with**, select **External Memory Device**, then click **OK**.

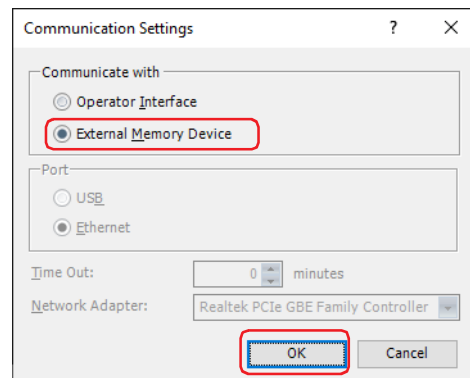

*1 USB flash drive inserted in USB1 for HG2J-7U, SD memory card for HG5G/4G/3G/2G-V, HG4G/3G and HG2G-5F, USB flash drive for HG2G-5T and HG1G/1P

Downloading

This procedure shows how to download the project data to the External Memory Device folder on the external memory device using WindO/I-NV4.

- 1 Open the project data to download using WindO/I-NV4.
- 2 On the **Home** tab, in the **Project** group, click the icon above **Download**.

The Download dialog box appears.

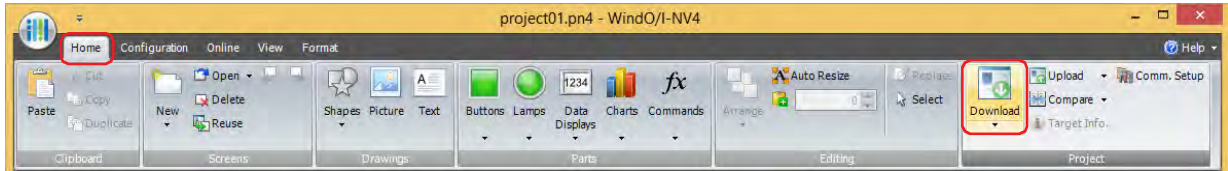

- 3 Click **Download**.

The Select Drive dialog box appears.

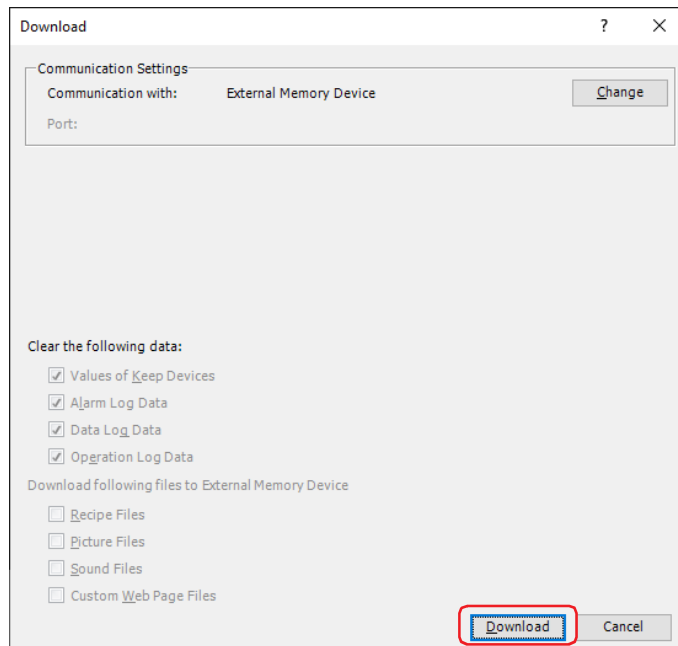

- 4 Select the external memory device drive, then click **OK**.

A confirmation message appears.

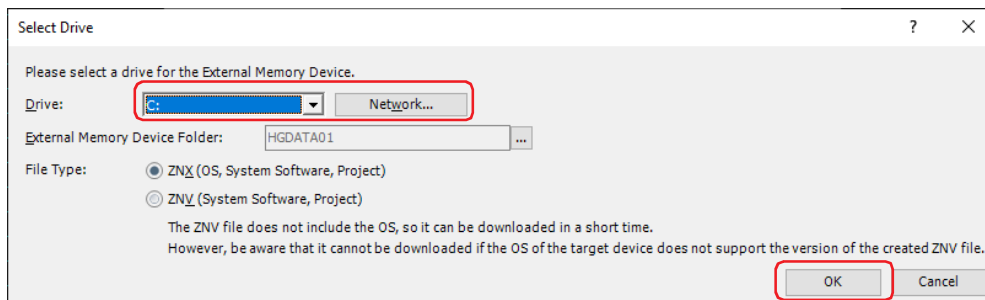

- **Drive**
Specify the computer's drive assigned as the external memory device drive.
- **Network**
Displays the Network Drive Assignment dialog box. This dialog allows you to specify a drive on the network.
- **External Memory Device Folder**
Specify the destination folder for downloading project data.

Click **...** to call up the Project Settings dialog box. This procedure allows you to change the External Memory Device folder on the external memory device where the download will be stored.

- 5 Click **Yes**.
The Download dialog box appears and the file download begins.
When the download is complete, a message box appears.
- 6 Click **OK**.
- 7 Click **Close** on the Download dialog box.

Uploading

This procedure shows how to upload the project data from the External Memory Device folder on the external memory device inserted in the computer, to the computer using WindO/I-NV4.

- 1 On the **Home** tab, in the **Project** group, click **Upload**.
The Select External Memory Device folder dialog box appears.

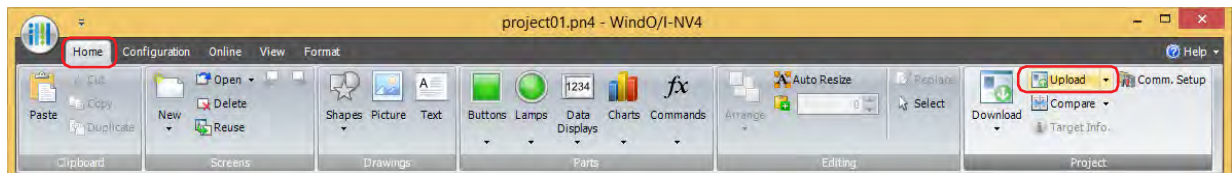

- 2 Select the external memory device drive, then click **OK**.
The Upload dialog box appears.

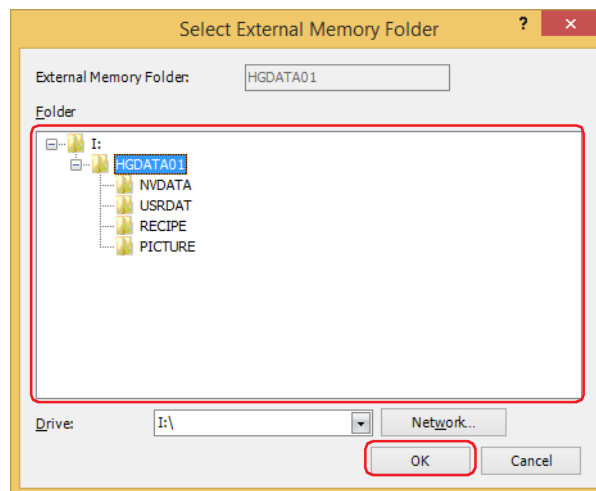

- **External Memory Device folder**
Displays the folder specified in the **Folder** tree described next.
- **Folder**
Specify the source folder for uploading the project data.
- **Drive**
Specify the computer's drive assigned as the external memory device drive.
- **Network**
Displays the Network Drive Assignment dialog box. This dialog allows you to specify a drive on the network.

- 3 Enter the location to **Location**, and then click **Upload**.

The Upload dialog box appears and the file upload begins.

When the upload is complete, a message box appears.

- 4 Click **OK**.

- 5 Click **Close** on the Upload dialog box.

A confirmation message appears indicating the project will be opened.

- 6 Click **OK**.

The uploaded project opens.



If a password has been configured for the project data, the Enter Password screen will be displayed. Enter the password for projects created with WindO/I-NV4 Ver. 1.11.4 or earlier using only 4 to 15 uppercase letters and numbers.

The password to enter varies based on the check box setting of the **Use Password to open a Project** found under the **Options** tab in the **Security** dialog box.

When this check box is selected, enter the password for **Use Password to open a Project**.

When this check box is cleared, enter the password for the user account assigned to the Administrator security group.

For details, refer to Chapter 23 "User Accounts and the Security Function" on page 23-1.

- Manipulating files using the file management functions provided with the computer OS

It is possible to use Explorer or any other program provided with the Windows OS to replace the recipe data, picture and sound files that MICRO/I uses.

Insert the external memory device into the computer and save the new file(s) using the same name as the existing files in each folder under the External Memory Device folder.

For the picture files that can be used with the MICRO/I, refer to Chapter 2 "1.4 Available Image Files" on page 2-20.

For the sound files that can be used with the MICRO/I, refer to Chapter 2 "1.5 Available Sound Files" on page 2-37.

● External memory device writing timing

If the write timing setting for Alarm Log, Data Log, and Operation Log data is set to **Real Time**, the data is stored in the file output buffer once.

The writing timing from the file output buffer to the external memory device^{*1} is as follows.

- Within 3 minutes of an output event to the external memory device^{*1}.
- The value of the HMI Special Relay LSM18^{*2} or the HMI Special Relay LSM20^{*3*4} changes to 1.
- When switching to the System Mode.
- When downloading/uploading project data.



In the following events, MICRO/I writes the data in the file output buffer to the external memory device once, and then moves on to the next process. This creates a processing delay which can cause WindO/I-NV4 to raise a communication error when downloading or uploading a project. If a communication error occurs, try downloading or uploading the project again.

- When data exists in the file output buffer
- When attempting to switch to the System Mode while reading/writing to the external memory device.
- When downloading or uploading project data.

● SD memory card access status

HG2J-7U HG5G-V HG4G-V HG4G HG3G-V HG3G HG2G-V HG2G-5F HG2G-5T HG1G HG1P

Models HG5G/4G/3G/2G-V, HG4G/3G, HG2G-5F have an SD Memory Card Access Lamp (LED).

The SD Memory Card Access Lamp (LED) indicates the access status to the SD memory card. This status can also be read by monitoring HMI Special Internal Relay LSM21.

The SD Memory Card Access Lamp states and status descriptions of the HMI Special Internal Relay LSM21 are as follows.

SD memory card access status	SD Memory Card Access Lamp state	LSM21 state	Status generation conditions	Operation
Read/write access stopped	OFF	0	No SD memory card is inserted. The inserted SD memory card is not supported. The inserted SD memory card is unformatted.	The SD memory card can be removed.
Recognizing SD memory card	Slow blink (ON/OFF every 0.5 seconds)	0	When an SD memory card is inserted. When the power is switched ON with an SD memory card inserted (slow blink -> ON).	
Read/write access standing by.		1	When HMI Special Internal Relay LSM20 changes to 1. (slow blink -> OFF)	Do not remove the SD memory card.
Read/write in progress	Rapid blink (ON/OFF every 0.2 seconds)	1	Reading/writing data to the inserted SD memory card. (Note, the LED stays lit when reading or writing to the SD memory card while using the project transfer function, or waiting for the operating mode to change.)	
Standby	ON	1	A usable SD memory card is inserted and can be read or written to.	

SD Memory Card Access Lamp states

Operation	State
At power up	OFF -> slow blink -> Lit
SD memory card is inserted.	
HMI Special Internal Relay LSM20 changed to 1.	Lit -> slow blink -> OFF
Data is read/written to the SD memory card (screenshot data, etc.)	Lit -> rapid blink -> Lit (reading/writing completed)

*1 USB flash drive inserted in USB1 for HG2J-7U, SD memory card for HG5G/4G/3G/2G-V, HG4G/3G and HG2G-5F, USB flash drive for HG2G-5T and HG1G/1P

*2 HG2G-5T, HG1G/1P only

*3 HG2J-7U, HG5G/4G/3G/2G-V, HG4G/3G, HG2G-5F only

*4 USB flash drive inserted in USB1 for HG2J-7U, SD memory card for HG5G/4G/3G/2G-V, HG4G/3G and HG2G-5F

1.6 Setting the External Memory Device Folder

The External Memory Device folder^{*1} on the external memory device can be renamed using WindO/I-NV4.

- 1 On the **Configuration** tab, in the **System Setup** group, click **Project**.

The Project Settings dialog box appears.

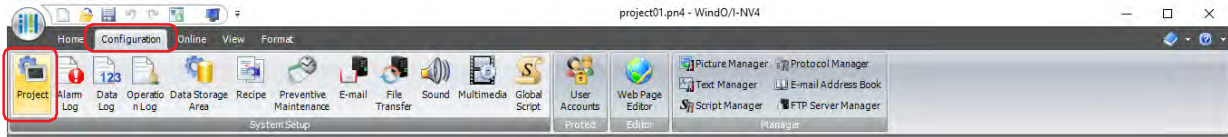

- 2 On the **External Memory Device** tab, enter the desired name in the **External Memory Device Folder** text box. Use only alphabetic characters (A to Z) and numbers (0 to 9) and the maximum is 8 characters.

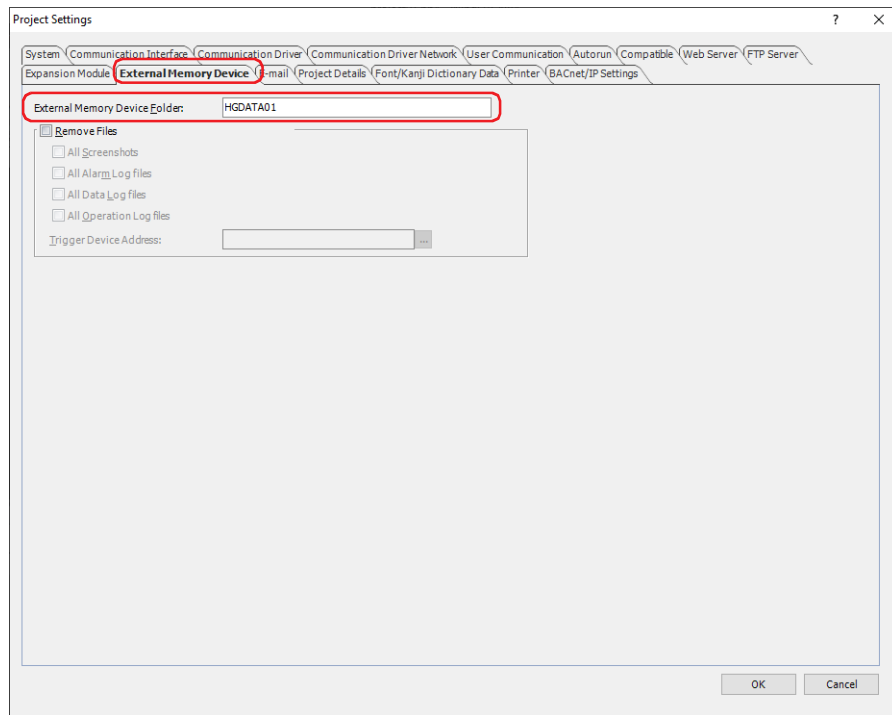

- 3 Click **OK**.



It is not possible to change folder names and file names other than the External Memory Device folder.



The External Memory Device folder is named "HGDATA01" if project data has never been downloaded to the MICRO/I.

*1 USB flash drive inserted in USB1 for HG2J-7U, SD memory card for HG5G/4G/3G/2G-V, HG4G/3G and HG2G-5F, USB flash drive for HG2G-5T and HG1G/1P

1.7 Deleting Files on the External Memory Device

Files in the External Memory Device folder of the external memory device*¹ inserted in the MICRO/I during operation can be deleted using WindO/I-NV4.

- 1 On the **Configuration** tab, in the **System Setup** group, click **Project**.
The Project Settings dialog box appears.

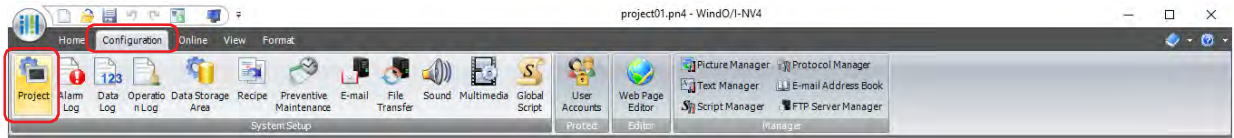

- 2 On the **External Memory Device** tab, select the **Remove Files** check box.
- 3 Specify the range of files to delete by checking the appropriate items.

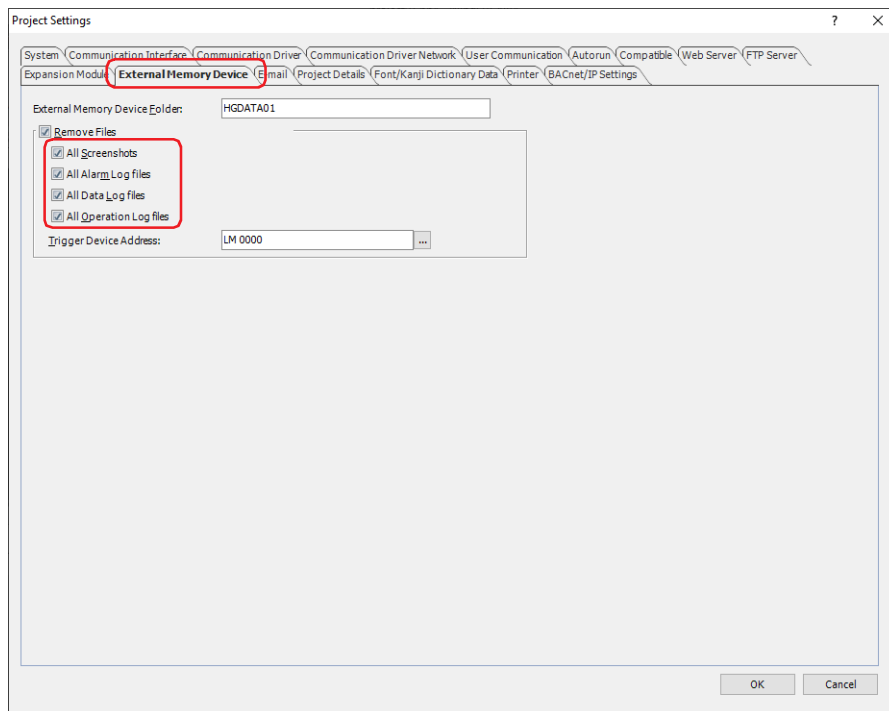

- **All Screenshots**
Deletes all files in the CAPTURE folder.
 - **All Alarm Log files**
Deletes all files in the ALARMLOG folder.
 - **All Data Log files**
Deletes all files in the DATALOG folder.
 - **All Operation Log files**
Deletes all files in the OPERATIONLOG folder.
- 4 In **Trigger Device Address**, specify the bit device or the bit number of the word device to serve as the condition for deleting files.
Click to display the Tag Editor. For the device address configuration procedure, refer to Chapter 2 "5.1 Device Address Settings" on page 2-70.
 - 5 Click **OK**.



The online function in WindO/I-NV4 can also be used to delete files on the external memory device. For details, refer to Chapter 24 "4 Clear" on page 24-26.

*1 USB flash drive inserted in USB1 for HG2J-7U, SD memory card for HG5G/4G/3G/2G-V, HG4G/3G and HG2G-5F, USB flash drive for HG2G-5T and HG1G/1P

1.8 Formatting the External Memory Device

HG2J-7U HG5G-V HG4G-V HG4G HG3G-V HG3G HG2G-V HG2G-5F HG2G-5T HG1G HG1P



Always format the external memory device before using it.

● Formatting an external memory device using the Online Function in WindO/I-NV4

The external memory device inserted in the MICRO/I can be formatted with the WindO/I-NV4 online function. Using the WindO/I-NV4, the following external memory devices are accessible.

HG5G/4G/3G/2G-V, HG4G/3G, HG2G-5F: SD memory card

HG2G-5T, HG1G/1P: USB flash drive

1 On the **Online** tab, in the **MICRO/I** group, click **Format**.

A confirmation message appears warning that existing data will be deleted.

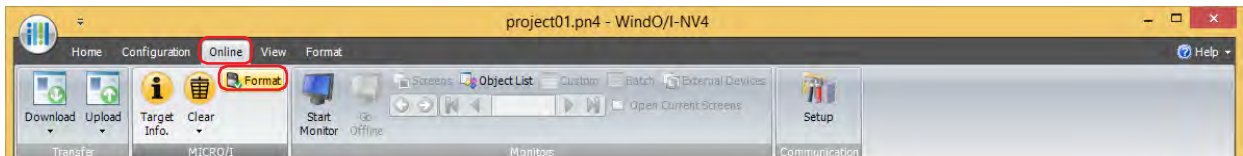

- In **Communication Settings, Communicate with** must be set to **MICRO/I** in advance, and **Port** must be set to **USB** in advance. For details on how to configure these settings, refer to “Communication settings” on page 31-4.
- If a project has been saved on the external memory device with security enabled, a dialog appears for you to enter a user name and password. For details, refer to Chapter 23 “User Accounts and the Security Function” on page 23-1.

2 Click **Yes**.

The External Memory Maintenance dialog box appears and formatting begins.

3 Click **Close**.



After completing a format of the external memory device, the External Memory Device folder is automatically created when going to the Run Mode.

- Formatting external memory device under the System Mode on the MICRO/I

External memory device inserted in MICRO/I can be formatted by using the menu in the System Mode on the MICRO/I.

- 1 Insert the external memory device into the MICRO/I.

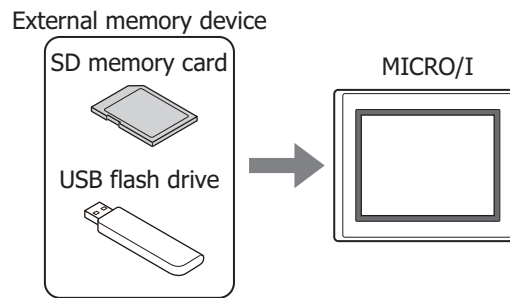

- 2 Press and hold the upper left corner of the MICRO/I screen for 3 or more seconds. The Maintenance Screen appears.

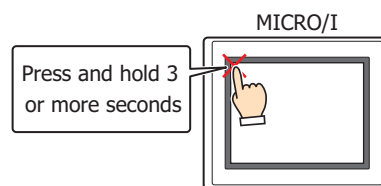

- 3 Press the **System Mode**.

MICRO/I switches to the Top Page in the System Mode.

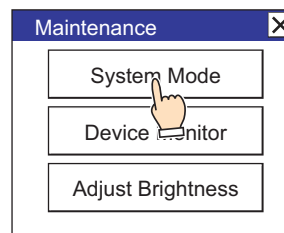

If security is enabled for the project on MICRO/I, a dialog appears for you to enter a user name and password. For details, refer to Chapter 23 "User Accounts and the Security Function" on page 23-1.

- 4 Press the **Main Menu**.

The Main Menu appears.

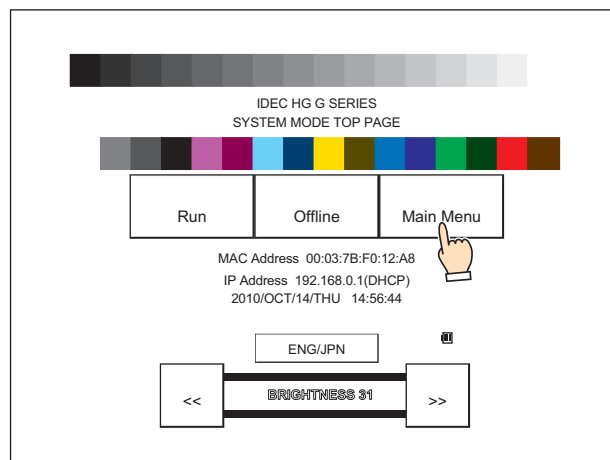

- 5 Press the **File Manager** (HG5G/4G/3G/2G-V, HG4G/3G, HG2G-5F) or **Ext.Mem.Device** (HG2G-5T, HG1G/1P).
 For the HG5G/4G/3G/2G-V, HG4G/3G and the HG2G-5F, File Manager appears.
 For the HG2G-5T, HG1G/1P, proceed to step 7.

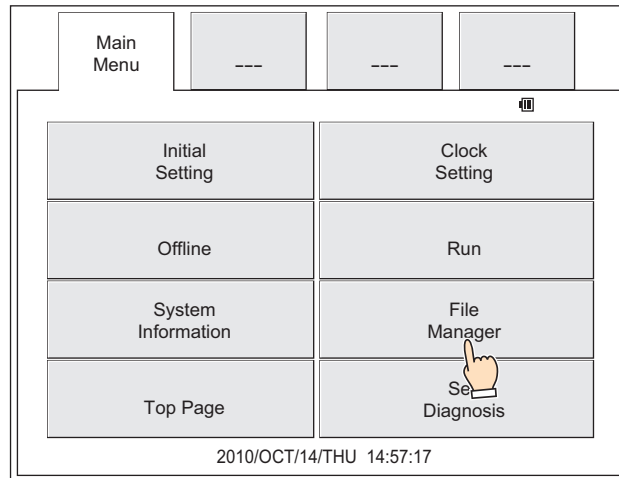

- 6 Press the source **DRIVE:** and select an external memory device.
 Select **SD Card** for an SD memory card and **USB memory** for a USB flash drive.

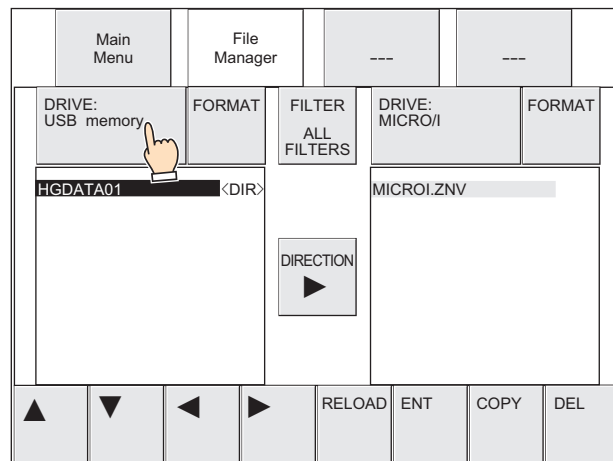

- 7 Press **FORMAT**.
 A confirmation message appears.

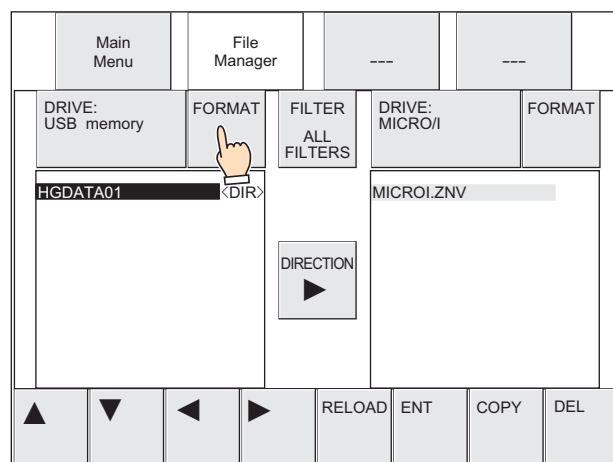

For the HG2G-5T, HG1G/1P, only **FORMAT** is displayed in the center of the screen.

8 Press **YES**.

MICRO/I starts formatting the external memory device.

When formatting is completed, "The format completed." is displayed.

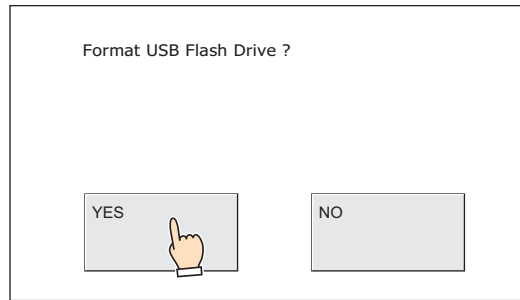

1.9 Precautions

- For projects that use external memory devices, always insert the external memory device before turning the MICRO/I on.
- The maximum number of screenshots that can be captured can be set in HMI Special Data Register LSD65.
- External memory devices have a limitation on the number of writes allowed.
Regularly backup data on the external memory device.
- Never turn the power off to the MICRO/I or remove the external memory device while reading/writing to it. Otherwise, the data on the external memory device may be destroyed. Should this occur, reformat the external memory device.
- When external memory device is inserted into the MICRO/I, first perform the following operations, and then turn off the power to the MICRO/I or remove the external memory device.

Model	External Memory Device	Operation
HG2J-7U	USB flash drive inserted in USB1	After setting the value of the HMI Special Relay LSM20 to 1, check that the value of the HMI Special Relay LSM21 is 0.
	USB flash drive inserted in USB2	After setting the value of the HMI Special Relay LSM18 to 1, check that the value of the HMI Special Relay LSM19 is 0.
HG5G/4G/3G/2G-V, HG4G/3G, HG2G-5F	SD memory card	After setting the value of the HMI Special Relay LSM20 to 1, check that the value of the HMI Special Relay LSM21 is 0.
	USB flash drive	After setting the value of the HMI Special Relay LSM18 to 1, check that the value of the HMI Special Relay LSM19 is 0.
HG2G-5F, HG1G/1P	USB flash drive	After setting the value of the HMI Special Relay LSM18 to 1, check that the value of the HMI Special Relay LSM19 is 0.

- When a read or write failure occurs with the external memory device, HMI Special Data Register LSD42 for a USB flash drive^{*1} inserted in USB1 or an SD memory card^{*2} and HMI Special Data Register LSD33 for a USB flash drive^{*3} are set with the error status. For details about the error, refer to Chapter 33 "HMI Special Data Register (LSD)" on page 33-8. Manually delete the files by using a computer or the File Manager function.
- If an unusable external memory device is inserted, the following error message appears.

SD memory card: This SD memory card not available.^{*2}

USB flash drive: This USB flash drive isn't available (USB1)^{*1}

This USB flash drive isn't available (USB2)^{*1}

This USB isn't available.

- If your computer does not have an SD memory card slot, a docking station is required to read/write to the SD memory card.
- Multiple USB flash drives cannot be used at the same time.
- Do not connect the USB flash drive to the MICRO/I through a USB hub.
- The message "Stopping external memory" appears while reading or until writing stops.
To resume reading or writing to the external memory device, re-insert it.
- Altering folders and files in the External Memory Device folder on the external memory device will make the external memory device unusable in MICRO/I and WindO/I-NV4.

*1 HG2J-7U only

*2 HG5G/4G/3G/2G-V, HG4G/3G, HG2G-5F only

*3 HG2G-5T, HG1G/1P only

2 USB Autorun Function

HG2J-7U HG5G-V HG4G-V HG4G HG3G-V HG3G HG2G-V HG2G-5F HG2G-5T HG1G HG1P

2.1 Overview of the USB Autorun Function

The USB Autorun function automatically displays a menu screen from which the user can execute predefined commands when a USB flash drive is inserted into the MICRO/I.

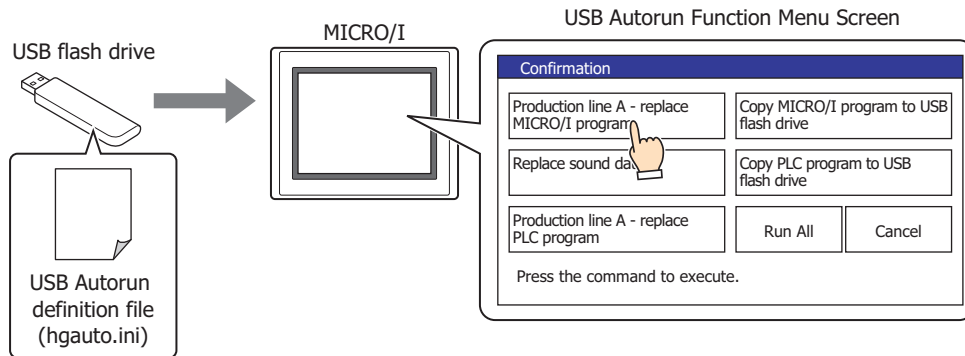

- This allows operators to change project and PLC programs without using a computer.
- These defined processes are called commands, and the file that contains the details of the command and menu screen is called the USB Autorun definition file (hgauto.ini).
- A USB Autorun definition file (hgauto.ini) must be stored on the USB flash drive to use the USB Autorun function.
- HG2J-7U operates on either USB1 or USB2 depending on whichever port that has USB flash drive inserted first with USB autorun definition file (hgauto.ini) saved inside.
- For the HG5G/4G/3G/2G-V, HG4G/3G and the HG2G-5F, an SD memory card can be used as the destination for saving ZNV Project File(.znv), ZLD Project File(.zld), and for copying files.

The commands that can be executed with the USB Autorun function are as follows.

● Downloading a project (ZNV Project File)

Downloads a ZNV Project File(.znv) saved on a USB flash drive or an SD memory card*1 to the MICRO/I.

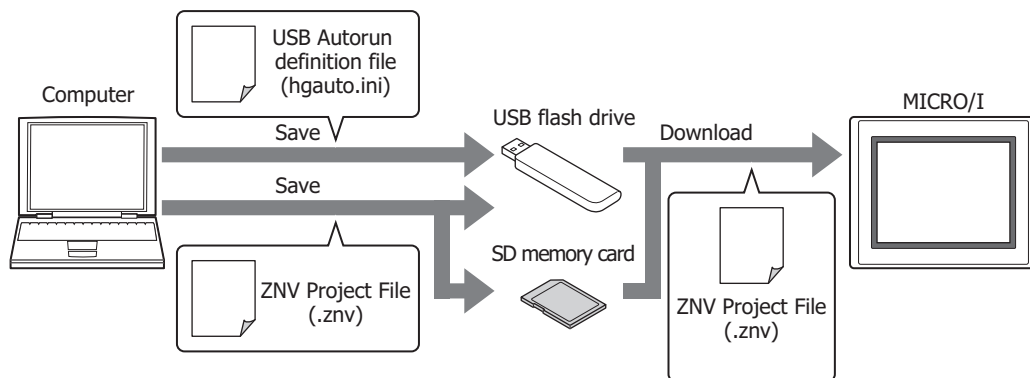

When the download is complete, the MICRO/I will reset and start running from the beginning of the project that was just downloaded.



Refer to Chapter 29 "1 Project Transfer Function" on page 29-1 for important notes and limitations.

*1 HG5G/4G/3G/2G-V, HG4G/3G, HG2G-5F only

● Uploading a project

Uploads the project used to operate the MICRO/I and saves it to a USB flash drive or an SD memory card*1.

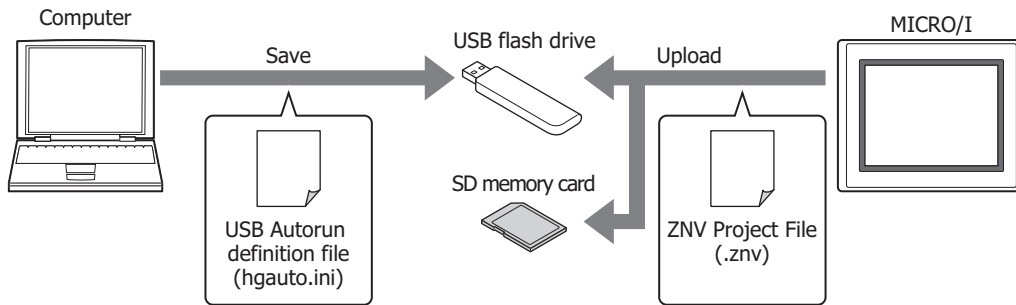

When the upload is complete, the MICRO/I will reset and start over at the beginning of the project.



Refer to Chapter 29 "1 Project Transfer Function" on page 29-1 for important notes and limitations.

● Downloading a PLC program (ZLD Project File)

Downloads a ZLD Project File(.zld) saved on a USB flash drive or an SD memory card*1 to the PLC connected to the MICRO/I.

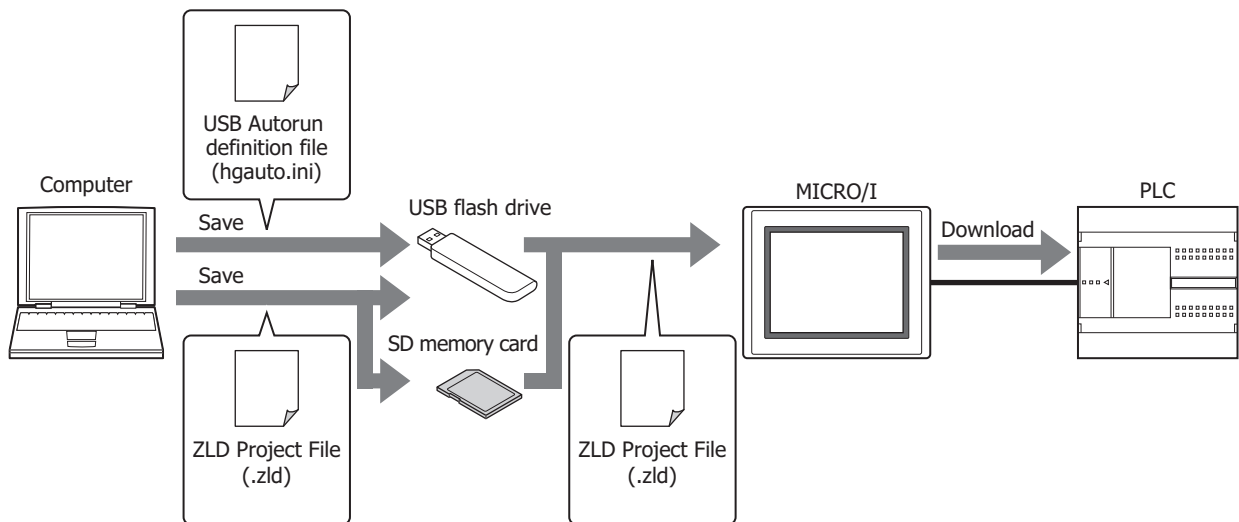

Refer to Chapter 29 "2 PLC Program Transfer Function" on page 29-16 for compatible PLCs, important notes, and limitations.

● Uploading a PLC program

Uploads the PLC program from the PLC connected to the MICRO/I and saves it as ZLD Project File(.zld) to a USB flash drive or an SD memory card*1.

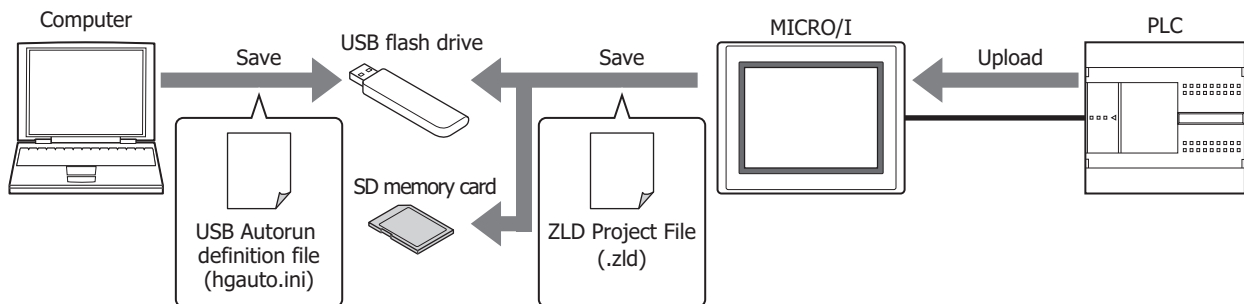

Refer to Chapter 29 "2 PLC Program Transfer Function" on page 29-16 for compatible PLCs, important notes, and limitations.

*1 HG5G/4G/3G/2G-V, HG4G/3G, HG2G-5F only

● Copy files

Files can be copied between or within the external memory device inserted in MICRO/I.

USB flash drive -> SD memory card

HG2J-7U HG5G-V HG4G-V HG4G HG3G-V HG3G HG2G-V HG2G-5F HG2G-5T HG1G HG1P

Copies files saved on the USB flash drive to the SD memory card inserted in the MICRO/I.

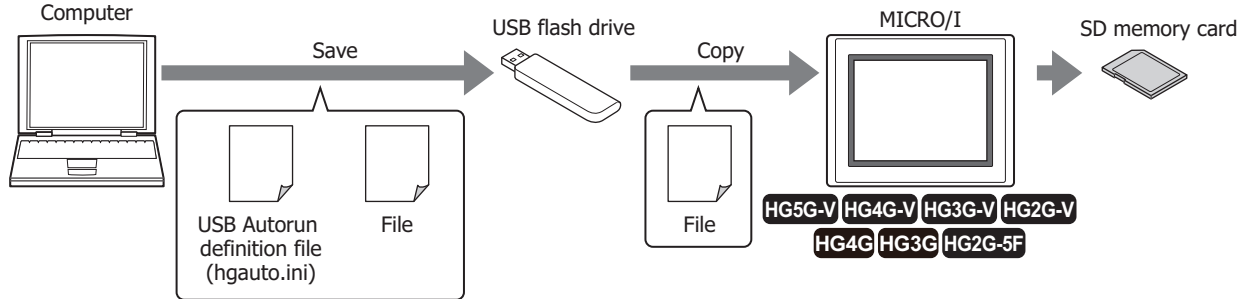

SD memory card -> USB flash drive

HG2J-7U HG5G-V HG4G-V HG4G HG3G-V HG3G HG2G-V HG2G-5F HG2G-5T HG1G HG1P

Copies files saved on the SD memory card inserted in the MICRO/I to the USB flash drive.

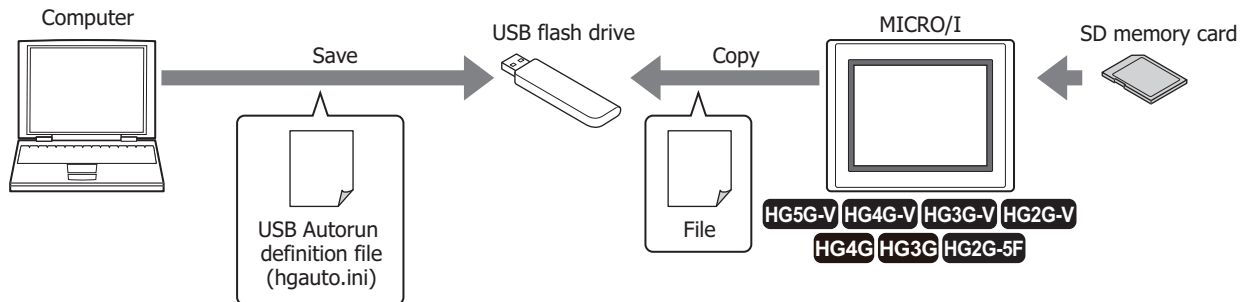

USB flash drive -> USB flash drive

HG2J-7U HG5G-V HG4G-V HG4G HG3G-V HG3G HG2G-V HG2G-5F HG2G-5T HG1G HG1P

- Copies files saved on the USB flash drive to the USB flash drive inserted in the MICRO/I.

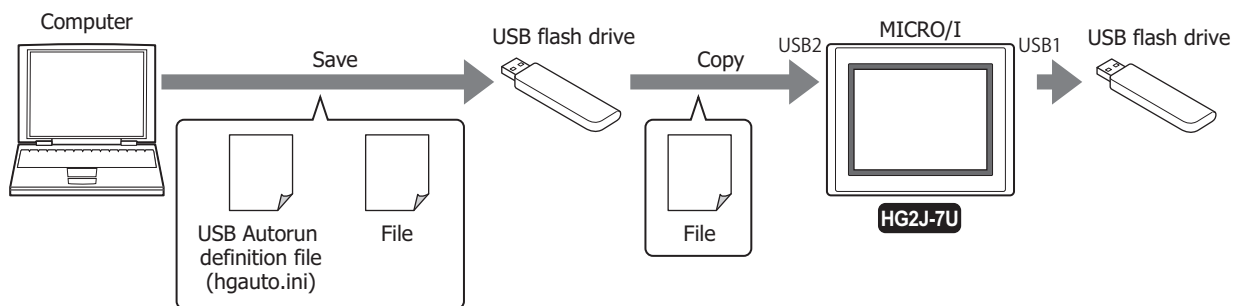

- Copies files saved on the USB flash drive inserted in the MICRO/I to the USB flash drive.

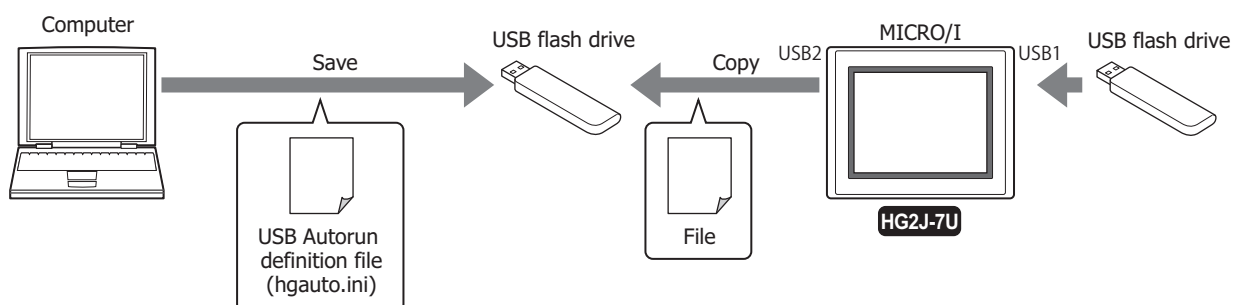

Copy in SD memory card

HG2J-7U HG5G-V HG4G-V HG4G HG3G-V HG3G HG2G-V HG2G-5F HG2G-5T HG1G HG1P

Copies files saved on the SD memory card inserted in the MICRO/I in the SD memory card.

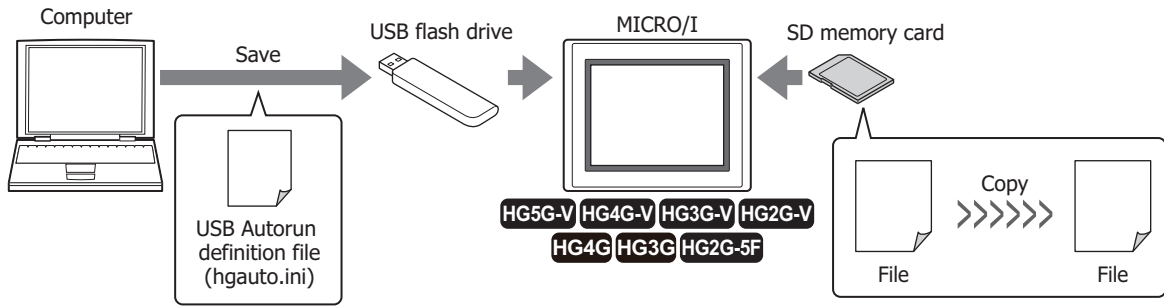

Copy in USB flash drive

HG2J-7U HG5G-V HG4G-V HG4G HG3G-V HG3G HG2G-V HG2G-5F HG2G-5T HG1G HG1P

Copies files saved on the USB flash drive inserted in the MICRO/I in the USB flash drive.

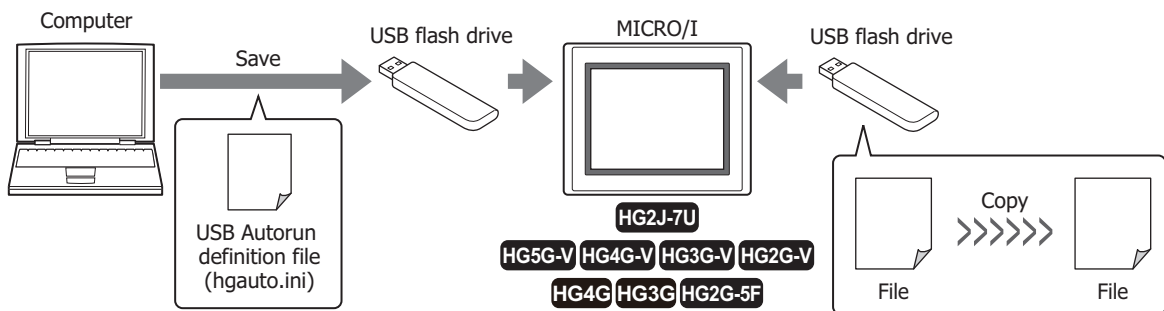

Refer to Chapter 29 "3 File Copy Function" on page 29-30 for important notes and limitations.

2.2 USB Autorun Function Configuration Procedure

- Executing commands using the USB Autorun function

Configuration Procedure

- 1 On the **Configuration** tab, in the **System Setup** group, click **Project**.

The Project Settings dialog box appears.

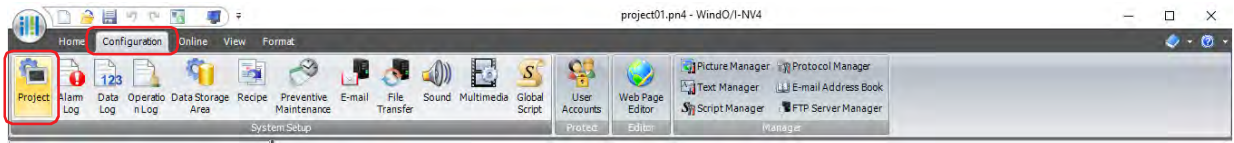

- 2 On the **Autorun** tab, select the **Enable USB Autorun** check box and click **OK**.

For details, refer to Chapter 4 "3.10 Autorun Tab" on page 4-64.

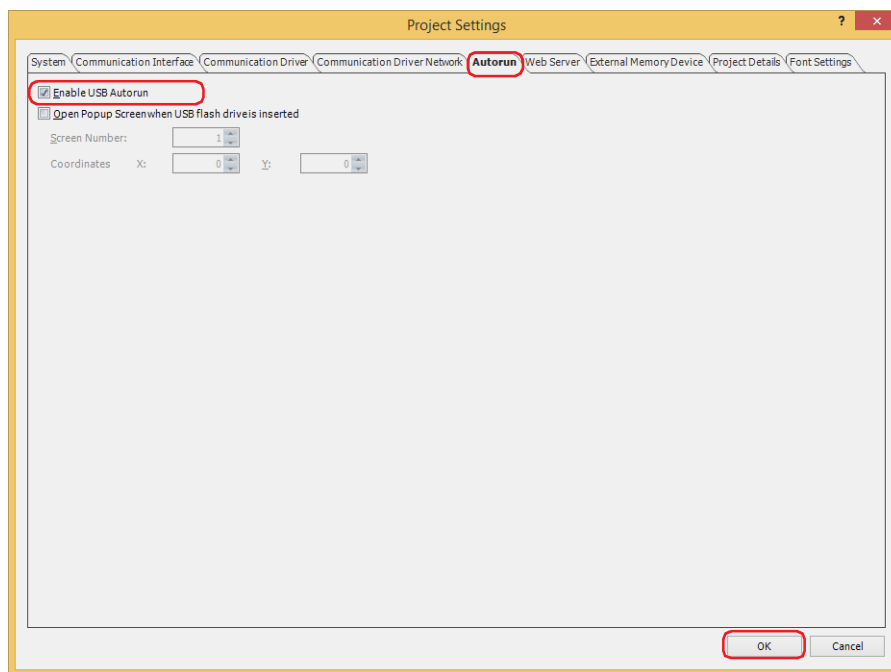

- If the USB Autorun function of the MICRO/I is not enabled, the menu screen will not be displayed, even if a USB flash drive is inserted into the MICRO/I.
- Once the USB Autorun function of the MICRO/I is enabled, the function will remain enabled until either a project with the **Enable USB Autorun** check box unchecked is downloaded, or the function is disabled via the System Mode.



When enabling the USB Autorun function using the MICRO/I, on the Top Page in the System Mode, press **Main Menu, Initial Setting, System Operation** (for HG4G/3G/2G-5F) or **System Op.** (for HG2G-5T, HG1G), and then press **Autorun**.

- 3 Create a USB Autorun definition file (hgauto.ini) and save it on the USB flash drive.

For details, refer to "2.3 Creating a USB Autorun Definition File" on page 31-26.

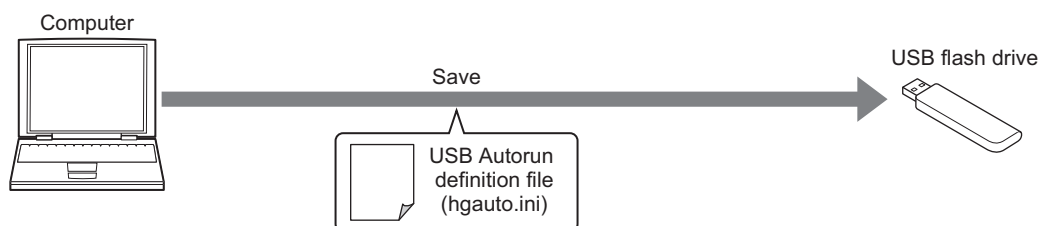

4 Prepare the necessary files and store them on the USB flash drive or SD memory card.

If the necessary files are stored on an SD memory card, make sure to insert it into the MICRO/I before using it for uploading or copying.

The necessary files are as follows.

- To download a project (ZNV Project File)
Create a ZNV Project File (.znv).
For details, refer to Chapter 29 "1.3 Converting Project for Transfer" on page 29-3.
- To download an IDEC PLC program
Create a ZLD Project File (.zld).
For details, refer to Chapter 29 "2.4 Creating ZLD Project File" on page 29-18.
- To copy files
Create the file to be copied.

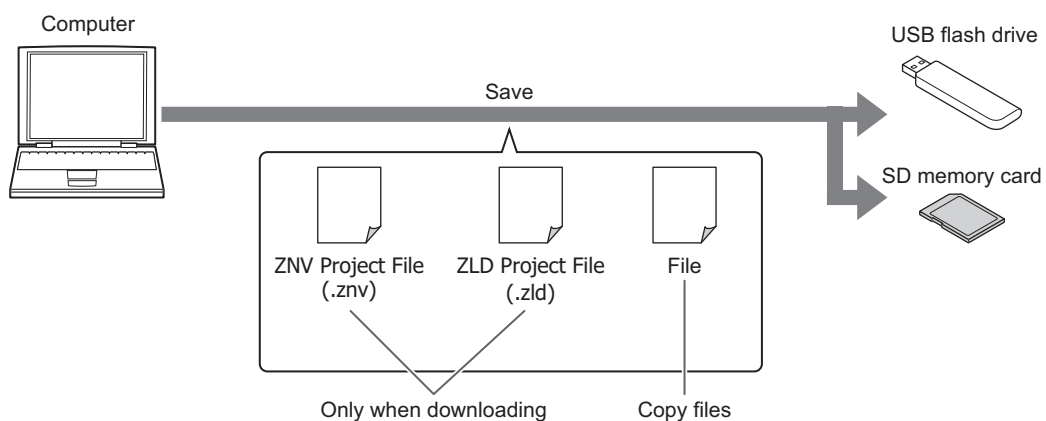

Operating Procedure

1 Insert the USB flash drive into the MICRO/I.

The menu for the USB Autorun function appears.

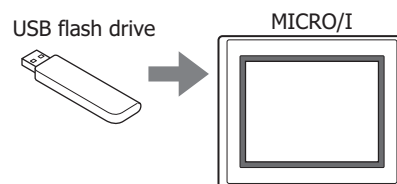

If the menu screen does not appear, follow these troubleshooting tips. Correct the problem and re-insert the USB flash drive.

Cause: USB Autorun definition file (hgauto.ini) does not exist on the USB flash drive.

Correction: Create a USB Autorun definition file and save it on the USB flash drive. For details, refer to "2.3 Creating a USB Autorun Definition File" on page 31-26.

Cause: The USB Autorun definition file (hgauto.ini) contains an error.

Correction: For details, refer to "2.3 Creating a USB Autorun Definition File" on page 31-26.

Cause: The USB Autorun function is disabled in the MICRO/I settings.

Correction: Enable the USB Autorun function by referring to Steps 1 and 2 on page 31-23.

2 Press the command to execute.

The command executes.

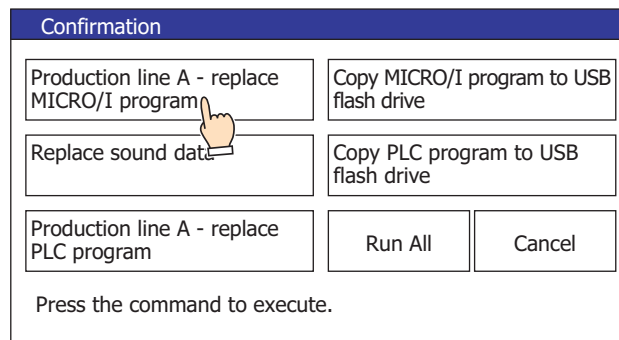

- Pressing **Run All** causes all commands defined in the USB Autorun definition file (hgauto.ini) to execute one by one.
- If security is enabled for the project on MICRO/I, a dialog appears for you to enter a user name and password. For details, refer to “2.4 USB Autorun Function Security” on page 31-34.
- When uploading or downloading IDEC PLC program to a password-protected PLC, a dialog appears for you to enter the password.



Do not remove the USB flash drive or SD memory card while command is executing.

3 When the command finishes executing, a screen appears indicating the execution result.

Press **Ack** to close the execution result screen and display the menu screen.

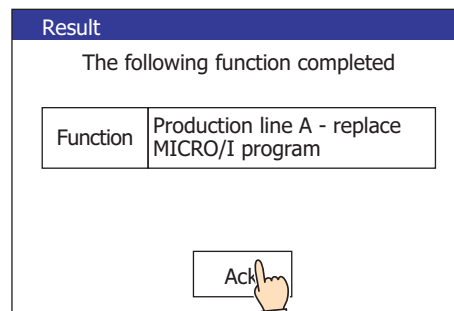

If a command executes with a button (except the **Run All**), the menu screen is displayed after pressing **Ack** on the execution result dialog.

2.3 Creating a USB Autorun Definition File

The menu screen that appears when a USB flash drive inserted in the MICRO/I is defined in the USB Autorun definition file.

The USB Autorun definition file is created using the following methods.

- Created with the USB Autorun definition file creation tool
 ☞ Refer to USB Autorun Definition File Creation Tool manual.
- Created with the text editor
 ☞ Refer to "Created using the text editor" on page 31-26.

● Created using the text editor

You create this file using Notepad or any commercially available text editor. Fill in the items in each section and save the file with the name "hgauto.ini".

The USB Autorun definition file has these 3 sections.

Enter the items and definitions for each section.

[AUTORUN] section (required)
 Specify the number of command items, enable/disable the buttons, and the display language to use.

```
[AUTORUN]
item = 5
button_command = Enable
button_runall = Enable
language = English
```

[COMMAND] section (required)
 Specify the command to execute and its parameters. Create buttons to execute the number of commands specified in the [AUTORUN]: section from [COMMAND_1] to [COMMAND_5], in that order.

```
[COMMAND_1]
command = PRO_DOWNLOAD
src_path = "B:\NV4DATA\HG_PROJECT.ZNV"
reset_keep_device = Enable
title = "Production line A - replace MICRO/I program"
:
:
:
:
[COMMAND_5]
command = LDR_UPLOAD
dst_path = "B:\Uploaded_Program"
src_port = COM1
src_net_no = 0
title = "Copy PLC program to USB flash drive"
```

[COMMENT] section
 Enter text to display, as necessary, at the bottom of the menu screen.

```
[COMMENT]
comment = "Press the command to execute."
```

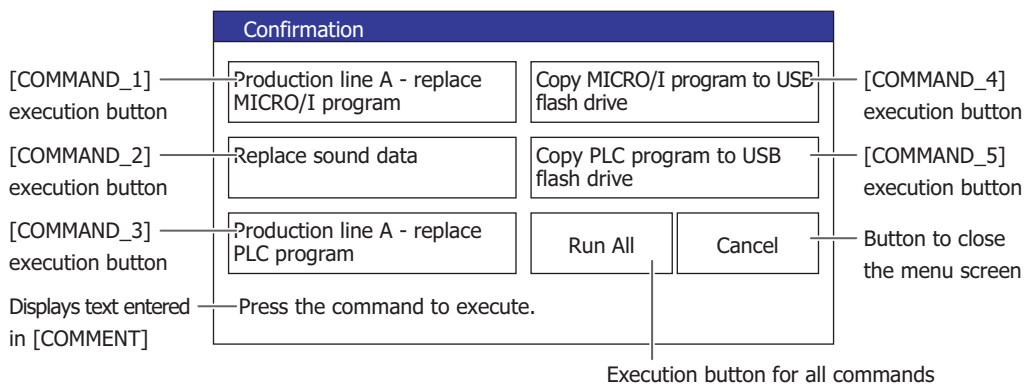

[AUTORUN] section

■ **item (required)**

Specify the number of commands used from 1 to 5. The USB Autorun function will fail to execute if a value other than 1 to 5 is specified.

■ **button_command**

Specify whether to enable/disable the execution buttons for [COMMAND_1] to [COMMAND_5].

Enable: enables the button.

Disable: disables the button.



If this item is left blank or contains an illegal value, the MICRO/I assumes "Enable".

■ **button_runall**

Specify whether to enable/disable the execution buttons for **Run All**.

Enable: enables the button.

Disable: disables the button.



If this item is left blank or contains an illegal value, the MICRO/I assumes "Enable".

■ **language**

Specify the language to use for the button labels and messages.

Japanese: Japanese (Shift-JIS)

European: Western (ISO 8859-1)

Chinese: Simplified Chinese (GB2312)

Taiwanese: Traditional Chinese (BIG5)

Korean: Hangul (KSC5601)

Central European: Central European (ANSI1250)

Baltic: Baltic (ANSI1257)

Cyrillic: Cyrillic (ANSI1251)



If this item is left blank or contains an illegal value, the MICRO/I assumes "Japanese".

[COMMAND] section



For the HG2G-5T, HG1G, only the USB flash drive is available.

■ **command (required)**

Specify the command to execute.

PRO_DOWNLOAD: Download a project (ZNV Project File)

PRO_UPLOAD: Upload a project

LDR_DOWNLOAD: Download a PLC program (ZLD Project File)

LDR_UPLOAD: Upload a PLC program

FILE_COPY: Copy a file

The items required differ for each command except for the "title" item.

command = PRO_DOWNLOAD■ **src_path (required)**

Specify the path (250 or less characters) where the project file is to be downloaded.

HG2J-7U:	Use "A:\\" for a USB flash drive inserted in USB1 and "B:\\" for a USB flash drive inserted in USB2.
HG5G/4G/3G/2G-V, HG4G/3G, HG2G-5F:	Use "A:\\" for an SD memory card and "B:\\" for a USB flash drive.
HG2G-5T, HG1G/1P:	Use "B:\\" for a USB flash drive.

■ **reset_keep_device**

Specify whether to initialize the keep devices or not when the project file is downloaded. However, when project data that changes the settings of the data storage area is downloaded, the keep devices are always initialized.

Enable:	Initializes the keep devices.
Disable:	Does not initialize the keep devices.



If you download the project data, Alarm Log data, Operation Log data, and Data Log data is erased regardless of the reset_keep_device.



If this item is left blank or contains an illegal value, the MICRO/I assumes "Enable".

command = PRO_UPLOAD■ **dst_path (required)**

Specify the path to the folder (250 or less characters) where the uploaded project will be saved.

HG2J-7U:	Use "A:\\" for a USB flash drive inserted in USB1 and "B:\\" for a USB flash drive inserted in USB2.
HG5G/4G/3G/2G-V, HG4G/3G, HG2G-5F:	Use "A:\\" for an SD memory card and "B:\\" for a USB flash drive.
HG2G-5T, HG1G/1P:	Use "B:\\" for a USB flash drive.

command = LDR_DOWNLOAD■ **src_path (required)**

Specify the path (250 or less characters) where the ZLD Project File is to be downloaded.

HG2J-7U:	Use "A:\\" for a USB flash drive inserted in USB1 and "B:\\" for a USB flash drive inserted in USB2.
HG5G/4G/3G/2G-V, HG4G/3G, HG2G-5F:	Use "A:\\" for an SD memory card and "B:\\" for a USB flash drive.
HG2G-5T, HG1G/1P:	Use "B:\\" for a USB flash drive.

■ **dst_port (required)**

Specify the name of the MICRO/I port to which the PLC to download from is connected. For details about the port name, refer to Chapter 4 "Interface Configuration" on page 4-35.

COM1:	The name of the serial interface varies based on the model.
HG2J-7U, HG1G/1P*1:	COM(RS232C)
HG5G/4G/3G/2G-V, HG4G/3G, HG2G-5F:	COM1
HG2G-5T:	SERIAL1(RS232C)
COM2:	The name of the serial interface varies based on the model.
HG2J-7U, HG1G/1P:	COM(RS422/485)
HG5G/4G/3G/2G-V:	COM2(RS232C) or COM2(RS422/485)
HG4G/3G, HG2G-5F:	COM2
HG2G-5T:	SERIAL1(RS422/485)
ETHER:	Ethernet interface (LAN)

*1 Only special product of HG1P is equipped with a serial interface (RS232C).

- **dst_net_no (required when specifying the destination as a slave number or External Device ID)**

If the communication interface that connects the PLC for downloading is the serial interface, specify the slave number. If the communication interface is the Ethernet interface, specify the External Device ID. Specify the same number set as the slave number or External Device ID for the PLC.

- **dst_plc_ip (required when specifying the destination as an IP address)**

Specify the IP address of the download destination PLC.

Example: dst_plc_ip = 192.168.0.1

- **dst_plc_port**

Specify the port number of the download destination PLC.

Example: dst_plc_port = 2101



When specifying the destination as an IP address and this item is left blank or contains an illegal value, the MICRO/I assumes that the value is "2101". This item is not required when specifying the destination as a slave number or External Device ID.

command = LDR_UPLOAD

- **dst_path (required)**

Specify the path to the folder (250 or less characters) where the uploaded PLC program will be saved.

HG2J-7U: Use "A:\\" for a USB flash drive inserted in USB1 and "B:\\" for a USB flash drive inserted in USB2.

HG5G/4G/3G/2G-V, HG4G/3G, HG2G-5F: Use "A:\\" for an SD memory card and "B:\\" for a USB flash drive.

HG2G-5T, HG1G/1P: Use "B:\\" for a USB flash drive.

- **src_port (required)**

Specify the name of the MICRO/I port to which the PLC to upload from is connected. For details about the port name, refer to Chapter 4 "Interface Configuration" on page 4-35.

COM1: The name of the serial interface varies based on the model.

HG2J-7U, HG1G/1P*1: COM(RS232C)

HG5G/4G/3G/2G-V, HG4G/3G, HG2G-5F: COM1

HG2G-5T: SERIAL1(RS232C)

COM2: The name of the serial interface varies based on the model.

HG2J-7U, HG1G/1P: COM(RS422/485)

HG5G/4G/3G/2G-V: COM2(RS232C) or COM2(RS422/485)

HG4G/3G, HG2G-5F: COM2

HG2G-5T: SERIAL1(RS422/485)

ETHER: Ethernet interface (LAN)

- **src_net_no (required when specifying the destination as a slave number or External Device ID)**

If the communication interface that connects the PLC for uploading is the serial interface, specify the slave number. If the communication interface is the Ethernet interface, specify the External Device ID. Specify the same number set as the slave number or External Device ID for the PLC.

- **src_plc_ip (required when specifying the destination as an IP address)**

Specify the IP address of the upload source PLC.

Example: src_plc_ip = 192.168.0.1

- **src_plc_port**

Specify the port number of the upload source PLC.

Example: src_plc_port = 2101



When specifying the destination as an IP address and this item is left blank or contains an illegal value, the MICRO/I assumes that the value is "2101". This item is not required when specifying the destination as a slave number or External Device ID.

*1 Only special product of HG1P is equipped with a serial interface (RS232C).

command = FILE_COPY■ **src_path (required)**

Specify the path (250 or less characters) of a source file or folder to copy.

HG2J-7U: Use "A:\\" for a USB flash drive inserted in USB1 and "B:\\" for a USB flash drive inserted in USB2.
 HG5G/4G/3G/2G-V, HG4G/3G, HG2G-5F: Use "A:\\" for an SD memory card and "B:\\" for a USB flash drive.



- If a file name is specified as the source path name, the specified file is copied.
- If a folder name is specified, all of the files and subfolders contained in the folder, and all of the files in the subfolders, are copied.
- The subfolders can be copied up to five levels.
- To prevent copying the subfolders and the files contained in the subfolders, HMI Special Internal Relay LSM30 must be set to 1 before executing the copy.
- To stop copying files during the copy operation, write 1 to HMI Special Internal Relay LSM31. However, it will continue to copy the file until it is finished then it will stop copying.

■ **dst_path (required)**

Specify the destination path in 250 or less characters.

HG2J-7U: Use "A:\\" for a USB flash drive inserted in USB1 and "B:\\" for a USB flash drive inserted in USB2.
 HG5G/4G/3G/2G-V, HG4G/3G, HG2G-5F: Use "A:\\" for an SD memory card and "B:\\" for a USB flash drive.

Common items■ **title**

Enter a title for the button label. The maximum number is as follows.

HG2J-7U, HG5G/4G/3G/2G-V, HG4G/3G, HG2G-5F: 2 lines of 26 characters (total 52 characters)
 HG2G-5T, HG1G/1P: 2 lines of 14 characters (total 28 characters)

- A line feed will automatically be added and it can be added where desired. When added in a desired location, \n will be inserted automatically and is thus calculated as 2 single-byte characters.
- When using a semicolon (;), backslash (\), or double quotations ("), an escape character (\) will be automatically inserted before those characters and will thus be calculated as 2 single-byte characters.

[COMMENT] section■ **comment**

Enter a message shown at bottom of the menu screen. The maximum number is as follows.

HG2J-7U, HG5G/4G/3G/2G-V, HG4G/3G, HG2G-5F: 6 lines of 54 characters (total 324 characters)
 HG2G-5T, HG1G/1P: 3 lines of 29 characters (total 87 characters)

- A line feed will automatically be added but can be added where desired. When added in a desired location, \n will be inserted automatically and is thus calculated as 2 single-byte characters.
- When using a semicolon (;), backslash (\), or double quotations ("), an escape character (\) will be automatically inserted before those characters and will thus be calculated as 2 single-byte characters.

Notes on comments

To add comments to the USB Autorun definition file, use a semicolon (;).

All text after the semicolon (;) and up to the line feed will be treated as a non-executable comments.

Restrictions

- The maximum number of characters per line is 512 single-byte characters including line feed codes.
 All the text on the line will be ignored if there are more than 512 single-byte characters on the line.
- Each item must be described as a single line. If a line feed occurs before the end of the description, all characters after the line feed are ignored.
- The maximum size of the USB Autorun definition file (hgauto.ini) is 512 KB. The file cannot be used if it exceeds this limit.
- Only line feed codes of the format generally supported by Windows (CR+LF) are supported. If any other format is used, the USB Autorun definition file (hgauto.ini) will fail to run properly.

Sample definition file and explanation

Sample definition

```

; sample hgauto.ini
[AUTORUN]
(1) item = 5 ; number of items
button_command = Enable ; enable individual command buttons
button_runall = Enable ; enable the "Run All" button.
language = English ; use English

[COMMAND_1]
(2) command = PRO_DOWNLOAD ; download a ZNV Project File
src_path = "B:\HG3G_DEMO_1.ZNV" ; source path
reset_keep_device = Enable ; initialize the keep devices
title = "Production line A - replace MICRO/I program" ; button label

[COMMAND_2]
(3) command = FILE_COPY ; copy a file
src_path = "B:\Error.wav" ; source path
dst_path = "A:\HGDATA01\SOUND" ; destination path
title = "Replace sound data" ; button label

[COMMAND_3]
(4) command = LDR_DOWNLOAD ; download a ZLD Project File
src_path = "B:\LDRDATA\LDR_PROGRAM.ZLD" ; source path
dst_port = COM1 ; destination port number
dst_net_no = 0 ; destination slave number
title = "Production line A - replace PLC program" ; button label

[COMMAND_4]
(5) command = PRO_UPLOAD ; upload a project
dst_path = "B:\Uploaded_Project" ; destination path
title = "Copy MICRO/I program to USB flash drive" ; button label

[COMMAND_5]
(6) command = LDR_UPLOAD ; Upload a PLC program
dst_path = "B:\Uploaded_Program" ; destination path
src_port = COM1 ; source port number
src_net_no = 0 ; source slave number
title = "Copy PLC program to USB flash drive" ; button label

[COMMENT]
(7) comment = " Press the command to execute." ; Message shown at bottom of screen.

```

Explanation

- (1) This definition file displays five command execution buttons on the menu screen displayed by the USB Autorun function. It also enables the **Run All** button. All button labels and messages are displayed in English.

[AUTORUN]	Defines the number of commands to use and details about the menu screen.
item = 5	Specifies that five commands will be used.
button_command = Enable	Enables execution buttons for each command from [COMMAND_1] to [COMMAND_5].
button_runall = Enable	Enables the Run All button.
language = English	Displays all button labels and messages in English.

- (2) Downloading a ZNV Project File from a USB flash drive to the MICRO/I.

[COMMAND_1]	Defines the command assigned to execution button [COMMAND_1]. This is the first command that executes when Run All is pressed.
command = PRO_DOWNLOAD	Executes "Download a project (ZNV Project File)".
src_path = "B:\HG3G_DEMO_1.ZNV"	Downloads the ZNV Project File "HG3G_DEMO_1.ZNV" saved on the USB flash drive (B:) to the MICRO/I.
reset_keep_device = Enable	Initializes the keep devices.
title = "Production line A - replace MICRO/I program"	Displays the text "Production line A - replace MICRO/I program" as the button label.

- (3) Copying a sound file from a USB flash drive to an SD memory card.

[COMMAND_2]	Defines the command assigned to execution button [COMMAND_2]. This is the second command that executes when Run All is pressed.
command = FILE_COPY	Executes "File Copy".
src_path = "B:\Error.wav"	Copies the sound file "Error.wav", saved on the root directory of the USB flash drive (B:), to the "SOUND" folder under "HGDATA01" on the SD memory card (A:) inserted in the MICRO/I.
dst_path = "A:\HGDATA01\SOUND"	
title = "Replace sound data"	Displays the text "Replace sound data" as the button label.

- (4) Downloading a ZLD Project File from the USB flash drive to the PLC connected to the MICRO/I.

[COMMAND_3]	Defines the command assigned to execution button [COMMAND_3]. This is the third command that executes when Run All is pressed.
command = LDR_DOWNLOAD	Executes "Download a PLC program (ZLD Project File)".
src_path = "B:\LDRDATA\LDR_PROGRAM.ZLD"	Downloads the ZLD Project File "LDR_PROGRAM.ZLD" stored in the "LDRDATA" folder of the USB flash drive (B:) to the PLC (slave number 0) connected to the MICRO/I's COM1 port.
dst_port = COM1	
dst_net_no = 0	
title = "Production line A - replace PLC program"	Displays the text "Production line A - replace PLC program" as the button label.

- (5) Uploading a project to a USB flash drive.

[COMMAND_4]	Defines the command assigned to execution button [COMMAND_4]. This is the fourth command that executes when Run All is pressed.
command = PRO_UPLOAD	Executes "Upload a project".
dst_path = "B:\Uploaded_Project"	Uploads the project used to operate the MICRO/I and saves it as the ZNV Project File in the folder "Uploaded_Project" on the USB flash drive (B:).
title = "Copy MICRO/I program to USB flash drive"	Displays the text "Copy MICRO/I program to USB flash drive" as the button label.

(6) Uploading a PLC program to a USB flash drive.

[COMMAND_5]	Defines the command assigned to execution button [COMMAND_5]. This is the fifth command that executes when Run All is pressed.
command = LDR_UPLOAD	Executes "Upload a PLC program".
dst_path = "B:\Uploaded_Program"	Uploads the PLC program running on the PLC (slave number 0) connected to the MICRO/I's COM1 port, and saves it as the ZLD Project File in the folder "Uploaded_Program" on the USB flash drive (B:).
src_port = COM1	
src_net_no = 0	
title = "Copy PLC program to USB flash drive"	Displays the text "Copy PLC program to USB flash drive" as the button label.

(7) Displays messages below the menu screen for the USB Autorun function.

[COMMENT]	Defines the number of commands to use and details about the menu screen.
comment = "Press the command to execute."	Displays the text "Press the command to execute." below the menu screen.

2.4 USB Autorun Function Security

If security has been enabled for the MICRO/I project, MICRO/I displays a password entry dialog box when the USB Autorun function runs.

Password										
Enter the appropriate password for Data Transfer Function										
User										▲ ▼

1	2	3	4	5	6	7	8	9	0	BS
Q	W	E	R	T	Y	U	I	O	P	CLR
123 abc	A	S	D	F	G	H	J	K	L	CAN
!/?#	Z	X	C	V	B	N	M	ENT		

Select the user name from the security group that has command execution permissions, enter the password, and press **ENT**.

- Execution privileges by security groups

The commands that can be executed differ depending on the security group.

Command	Security Group		
	Administrator	Operator	Reader
Downloading a project (ZNV Project File)	YES	NO	NO
Uploading a project	YES	NO	NO
Downloading a PLC program (ZLD Project File)	YES	NO	NO
Uploading a PLC program	YES	NO	NO
Copying files (USB flash drive to SD memory card)	YES	YES	NO
Copying files (SD memory card to USB flash drive)	YES	YES	YES

- **Example 1: If these two commands are used in the USB Autorun definition file (hgauto.ini).**

Downloading a project (ZNV Project File)

Copying files (SD memory card to USB flash drive)

The types of user accounts required to execute these commands is given below.

Downloading a project: Administrator

File copying (SD memory card to USB flash drive): Administrator, Operator, or Reader

Pressing the **Run All** button: Administrator



The password for the command with the highest security level listed in the USB Autorun definition file (hgauto.ini) must be entered to execute all commands by pressing the **Run All** button. In the example above, a user account from the Administrator security group is required.

- **Example 2: If the USB Autorun definition file (hgauto.ini) only contains the file copy command (SD memory card -> USB flash drive)**

A user account from the Administrator, Operator, or Reader security group is required.



If operator presses **CAN** instead of entering a password, no commands are executed and the menu screen closes. To re-execute the USB Autorun function, insert the USB flash drive again.

3 USB Popup Screen Function

HG2J-7U HG5G-V HG4G-V HG4G HG3G-V HG3G HG2G-V HG2G-5F HG2G-5T HG1G HG1P

The USB Popup Screen function displays a specific screen by simply inserting a USB flash drive in the MICRO/I. This provides an easy way to display a message when the operator inserts a USB flash drive.

3.1 Automatically Displaying a Popup Screen when a USB Flash Drive is Inserted

● Configuration Procedure

- 1 On the **Configuration** tab, in the **System Setup** group, click the **Project**.

The Project Settings dialog box appears.

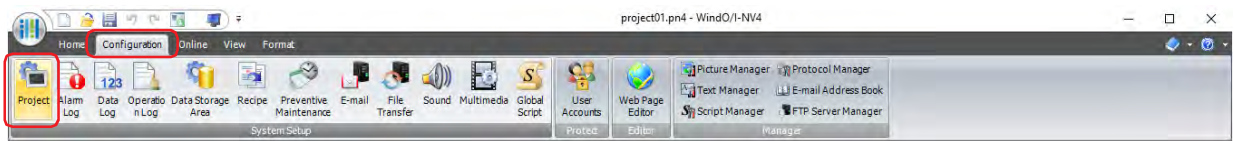

- 2 On the **Autorun** tab, select the **Open Popup Screen when USB flash drive is inserted** check box.

- 3 Specify the **Screen Number** of the Popup Screen to display, and the **Coordinates**, then click **OK**.

For details, refer to Chapter 4 "3.10 Autorun Tab" on page 4-64.

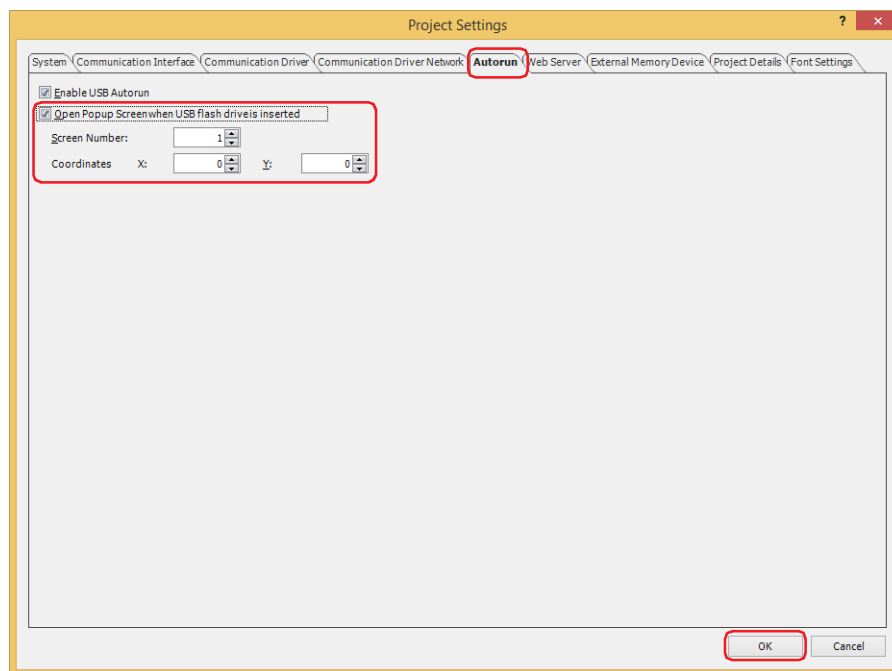

● Operating Procedure

Insert the USB flash drive into the MICRO/I.

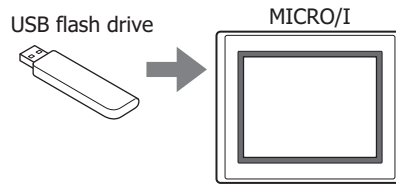

The Popup Screen appears.

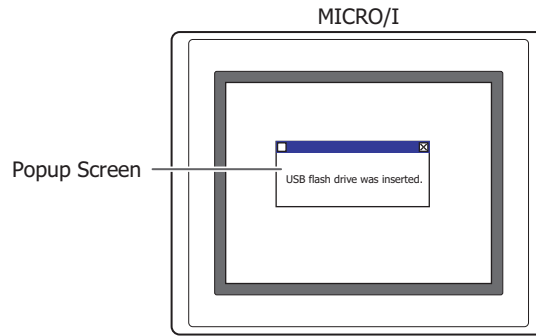

If security is enabled for the Popup Screen that is displayed by the USB Popup Screen function, a dialog appears for you to enter a user name and password. For details, refer to "2.4 USB Autorun Function Security" on page 31-34.



When the USB Popup Screen function is enabled, if the USB flash drive contains a definition file (hgauto.ini) for use with the USB Autorun function, both functions will appear on the menu screen.

Chapter 32 Printer

This chapter describes the functions of the MICRO/I when using a printer, and how to connect it.

1 Functions and Connections

HG2J-7U HG5G-V HG4G-V HG4G HG3G-V HG3G HG2G-V HG2G-5F HG2G-5T HG1G HG1P

1.1 Functions Available with the Printer

These functions are available when a printer is connected to the MICRO/I.

- Printing screenshots
☞ Refer to Chapter 8 "4 Print Button" on page 8-56, and Chapter 12 "4 Print Command" on page 12-25.
- Printing alarm logs (Batch)
☞ Refer to Chapter 13 "Alarm Log Function" on page 13-1.

1.2 Connecting a Printer to MICRO/I

Connect the USB interface (USB1) on the MICRO/I and the USB port on the printer with a USB cable.

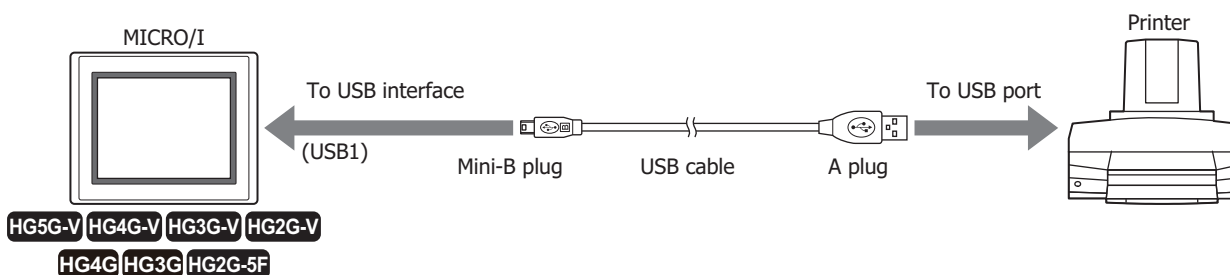

- Do not disconnect the cable between the MICRO/I and printer while printing.
- Do not use a USB hub when connecting to the printer with a USB cable.
- Printed images may appear differently depending on the printer used. Always check the image by printing an actual image.

1.3 Supported Printers

The following printers can be used.

Control codes/Manufacturer/Standard	Supported printers
PictBridge	Printers certified with the PictBridge logo



Always test any printer not listed in the above chart before using it.

2 Setting and Monitoring the Printer

HG2J-7U HG5G-V HG4G-V HG4G HG3G-V HG3G HG2G-V HG2G-5F HG2G-5T HG1G HG1P

2.1 Setting the Printer

When printing, specify printer settings such as; paper size and ink color on the **Printer** tab of the Project Settings dialog box.

For details, refer to Chapter 4 "3.8 Printer Tab" on page 4-62.



- If the printer does not support the paper size selected on the **Printer** tab in the Project Settings dialog box, printing is performed with the paper size selected in the printer's settings. When the edge of the data is not printed, enable **No Trimming** and **Bordered** in the printer's settings. The color cannot be configured. To print in monochrome, configure the print color on the printer that is used.
- When connecting the MICRO/I to a printer, an error may occur on the printer side as an unsupported device, but data is sent that satisfies the PictBridge standard when printing, so it can be printed correctly.

2.2 Monitoring the Printer

To monitor the status of the printer, use the System Area.

For details, refer to Chapter 4 "System Area 2" on page 4-32.

■ Printer busy

When the printer is printing, bit 3 at the system area address number +3 will turn ON.

■ Printer timeout error

If an error occurs while the printer is printing, bit 9 at the system area address number +2 will turn ON.

Chapter 33 Internal Devices

This chapter describes internal devices.

The MICRO/I includes an internal HMI device to control HMI functions, and control device^{*1} for control functions.

1 Bit Devices

1.1 HMI Device Addresses

HG2J-7U HG5G-V HG4G-V HG4G HG3G-V HG3G HG2G-V HG2G-5F HG2G-5T HG1G HG1P

Internal Device Name	Symbol	R/W	Address Range	Base
HMI Internal Relay	LM	R/W	0 to 4095 ^{*2} 0 to 2047 ^{*3}	10
HMI Keep Relay	LK	R/W	Variable	10
HMI Timer Relay	LTC	R	0 to 31	10
Digital Input (Bit) ^{*4}	LEX	R	0 to 77	8
Digital Output (Bit) ^{*4}	LEY	R/W	0 to 77	8
HMI Temporary Relay	LBM	R/W	0 to 255 ^{*2} 0 to 127 ^{*3}	10
HMI Expansion Input (Bit) ^{*5}	LI	R	0 to D	16
HMI Expansion Output (Bit) ^{*5}	LQ	R/W	0 to 1	16
HMI Special Internal Relay	LSM	R/W	0 to 95	10



R/W is an abbreviation of Read/Write. R/W indicate that both reading and writing are possible, while R indicates that only reading is possible.

■ HMI Internal Relay (LM)

This is a bit-unit device.

■ HMI Keep Relay (LK)

This is a bit-unit device that holds the values of device. The value of this device can be set to 0 by clearing the project data download option or online function, or it becomes 0 if the backup battery is drained. The maximum number of HMI Keep Register depends upon the number set in WindO/I-NV4. For details, refer to Chapter 16 "Minimum and Maximum Amount of Data Storage and Number of Addresses" on page 16-2.

■ HMI Timer Relay (LTC)

The HMI Timer is a bit-unit device that can be changed to 1 in value of device switched by the Timer from Parts. It can store 32 addresses.

■ Digital Input (LEX), Digital Output (LEY)

Digital input/output relay for expansion module connected to HG4G/3G and HG2G-5F.
For details, refer to Chapter 30 "2.1 Using Digital I/O Modules" on page 30-12.

■ HMI Temporary Relay (LBM)

This is a bit-unit device for temporarily storing values. The value of this device switches between screens and text groups and user accounts, and it becomes 0 if the screen is reset.

■ HMI Expansion Input (LI), HMI Expansion Output (LQ)

Input or output bit devices used with HG1P. For details, refer to Chapter 35 "Function Keys" on page 35-76. LIC to LID and LQ0 to LQ1 are reserved areas.

*1 HG5G/4G/3G/2G-V only

*2 HG2J-7U only

*3 HG5G/4G/3G/2G-V, HG4G/3G, HG2G-5F/-5T, HG1G/1P only

*4 HG4G/3G, HG2G-5F only

*5 HG1P only

■ HMI Special Relay (LSM)

A specific function is assigned for each of the 96 special internal relay (LSM0 to LSM95). The supported device addresses vary based on the model.

Yes: Supported, No: Not supported, (blank): Reserved

Device Address	Function/Part	HG2J-7U	HG5G/4G/3G/2G-V	HG4G/3G, HG2G-5F	HG2G-5T, HG1G/1P
LSM0	Always set to 1.	Yes	Yes	Yes	Yes
LSM1	When the default screen is displayed after the power turned ON or when the Base Screen switched, the value of this bit is 1 only on the second scan. It also operates when switching text group or user account, or resetting the display screen.	Yes	Yes	Yes	Yes
LSM2	When the default screen is displayed after the power turned ON or when the Base Screen switched, the value of this bit is 1 only on the first scan. It also operates when switching text group or user account, or resetting the display screen.	Yes	Yes	Yes	Yes
LSM3	When the default screen is displayed after the power turned ON or when the Base Screen switched, the value of this bit is 0 only on the first scan. It also operates when switching text group or user account, or resetting the display screen.	Yes	Yes	Yes	Yes
LSM4	Alternates between 0 and 1 with each scan.	Yes	Yes	Yes	Yes
LSM5	When Popup Screen is opened, the value of this bit is 1 only on the first scan.	Yes	Yes	Yes	Yes
LSM6	While touch panel is pressed, the value of this bit is 1.	Yes	Yes	Yes	Yes
LSM7	Alternates between 0 and 1 each time data is read (read scan) from all the external device addresses being used by External Device Communication 1.	Yes	Yes	Yes	Yes
LSM8	When the power is turned ON, the value of this bit changes to 1. When switching to another screen from the default screen or when switching text group or user account, then the value changes to 0.	Yes	Yes	Yes	Yes
LSM9	When value changes from 0 to 1, the backup data stored in flash memory is restored. When it becomes 1 value does not become 0 until the Touch is reset or 0 is written.	Yes	Yes	Yes	Yes
LSM10	When switched from 0 to 1, the current backlight setting and the data for Keep Relays and Keep Register configured in the Data Storage Area are transferred to the flash memory. Once LSM10 switches to 1, it does not change to 0 until MICRO/I recycles power or 0 is written to LSM10.	Yes	Yes	Yes	Yes
LSM11	When the default screen gets displayed after the power turned ON or when the Base Screen gets switched, the values of all external device addresses in use are read first. Then the bit changes from 0 to 1. The bit remains 1 until the screen gets switched to another screen. It also operates when switching text group or user account, or resetting the display screen.	Yes	Yes	Yes	Yes
LSM12	When Popup Screen is closed, the value of this bit is 1 only on the first scan.	Yes	Yes	Yes	Yes
LSM13	Value becomes 0 when Popup Screen is opened, and then changes from 0 to 1 after the values of all external device addresses being used by that Popup Screen are read.	Yes	Yes	Yes	Yes
LSM14 to 17	Reserved				
LSM18	When value changes from 0 to 1, access to USB flash drive ^{*6} is stopped. The access state can be checked with the value of LSM19. When it becomes 1 value does not become 0 until the MICRO/I is reset or 0 is written.	Yes	Yes	Yes	Yes
LSM19	Bit is 1 during USB flash ^{*6} access. When 0, the USB flash ^{*6} can be removed.	Yes	Yes	Yes	Yes
LSM20	Access to the external memory device ^{*7} stops when this bit is switched from 0 to 1. The access state can be checked with the value of LSM21.	Yes	Yes	Yes	No
LSM21	Bit is 1 during external memory device ^{*7} access. When 0, the external memory device ^{*7} can be removed.	Yes	Yes	Yes	No

*6 USB flash drive inserted in USB2 for HG2J-7U

*7 USB flash drive inserted in USB1 for HG2J-7U, SD memory card for HG5G/4G/3G/2G-V, HG4G/3G and HG2G-5F

Device Address	Function/Part	HG2J-7U	HG5G/4G/3G/2G-V	HG4G/3G, HG2G-5F	HG2G-5T, HG1G/1P
LSM22	This is the Operation Log function. When data in excess of the amount that can be recorded in one operation occurs, the value becomes 1. When it becomes 1 value does not become 0 until the MICRO/I is reset or 0 is written.	Yes	Yes	Yes	Yes
LSM23	This bit is 1 while file is copied.	Yes	Yes	Yes	No
LSM24	This bit is 1 while writing the data to the external memory device*7.	Yes	Yes	Yes	No
LSM25	This bit is 1 while writing the data to the USB flash drive.	No	No	No	Yes
LSM26	Reserved				
LSM27	Stops playing the sound file when this bit is turned from 0 to 1.	Yes	Yes	Yes*8	No
LSM28 to 29	Reserved				
LSM30	If the value of this bit is 0, all files (including the subfolders with files) under the source folder will be copied to the destination folder. If the value is 1, only the files (excluding the subfolders with files) under the source folder will be copied to the destination folder.	Yes	Yes	Yes	Yes
LSM31	If the value of this bit changes from 0 to 1, file copy process is terminated. If the value of this bit changes from 0 to 1 while copying the files, MICRO/I will stop the file copy function after copying the current file. If this value is 1, file copy function is not executed.	Yes	Yes	Yes	Yes
LSM32	Reserved				
LSM33	When the number of drawings or parts placed on the top layer exceeds the upper limit, then the value of this bit is 1. This bit remains at a value of 1 until the MICRO/I is reset or 0 is written, then the value is 0.	Yes	Yes	Yes	Yes
LSM34 to 41	Reserved				
LSM42	Alternates between 0 and 1 each time data is read (read scan) from all external device addresses being used by External Device Communication 2.	Yes	Yes	Yes	Yes
LSM43	Alternates between 0 and 1 each time data is read (read scan) from all external device addresses being used by External Device Communication 3.	Yes	Yes	Yes	Yes
LSM44	Alternates between 0 and 1 each time data is read (read scan) from all external device addresses being used by External Device Communication 4.	Yes	Yes	Yes	Yes
LSM45 to 47	Reserved				
LSM48	200 millisecond clock (alternates between 0 and 1 every 100 milliseconds)	Yes	Yes	Yes	Yes
LSM49	1 second clock (alternates between 0 and 1 every 500 milliseconds)	Yes	Yes	Yes	Yes
LSM50	When switched to 1, limits the External Device Communication and gives priority to the communications between the computer and PLC. (Enabled only when using the Pass-Through function.)	Yes	Yes	Yes	Yes
LSM51	Reserved				
LSM52	While in remote monitor or control, the value of this bit changes from 0 to 1 in just one scan.	Yes	Yes	Yes	Yes
LSM53	When the value changes to 1, the preset values for IP address, subnet mask, and default gateway (LSD192 to 203), and port number for maintenance communication (LSD213) are written to the MICRO/I, then it automatically resets. After the MICRO/I is reset, the value becomes 0.	Yes	Yes	Yes	Yes
LSM54	When the value changes to 1, the preset values for External Device ID, IP address and port number (LSD204 to 209) are written to the MICRO/I, then it automatically resets. After the MICRO/I is reset, value becomes 0.	Yes	Yes	Yes	Yes
LSM55	When the value of this bit changes from 0 to 1, it cancels sending of all the e-mails in "Waiting" status. Even if the value of LSM56 is 1, this function can be executed.	Yes	Yes	Yes	Yes
LSM56	While the value of this bit is 1, it pauses sending of all the e-mails in "Waiting" status. If the value changes from 0 to 1 while sending an e-mail is in progress, it will pause after such e-mail has been sent.	Yes	Yes	Yes	Yes

*7 USB flash drive inserted in USB1 for HG2J-7U, SD memory card for HG5G/4G/3G/2G-V, HG4G/3G and HG2G-5F

*8 This is applicable for models with an audio interface only.

Device Address	Function/Part	HG2J -7U	HG5G/ 4G/3G/ 2G-V	HG4G/ 3G, HG2G- 5F	HG2G -5T, HG1G /1P
LSM57	When the value of this bit changes from 0 to 1, get the current time from the SNTP server. The acquired current time is written to the MICRO/I internal clock and stored in the MICRO/I internal current time data (LSD13 to 19).	Yes	No	No	No
LSM58	Value is 1 while there is a connection with an FTP client.	Yes	Yes	Yes	Yes
LSM59	If the value of this bit changes from 0 to 1, the connections for the FTP client and the MICRO/I is forcibly disconnected. When it becomes 1 value does not become 0 until the MICRO/I is reset or 0 is written.	Yes	Yes	Yes	Yes
LSM60, 61	Reserved				
LSM62	When the value of this bit changes to 1, the POWER LED is turned off (unlit). When changes to 1, the POWER LED turns ON (lit in green). After the MICRO/I is reset, value becomes 1 when operation starts.	Yes	Yes	Yes	Yes
LSM63	Reserved				
LSM64	Value is 1 while transferring a file.	Yes	Yes	Yes	Yes
LSM65	When the value of this bit changes from 0 to 1, file transfers are prohibited. When the value of this bit changes to 1 during a file transfer, the file transfer is completed, and then file transfers are prohibited from the next transfer.	Yes	Yes	Yes	Yes
LSM66	Reserved				
LSM67	When the value of this bit changes from 0 to 1, copying and moving subfolders and files included in subfolders is prohibited when transferring files from external memory to external memory. When the value of this bit changes to 1 during a file transfer, the file transfer is completed, and then copying and moving subfolders and files included in subfolders is prohibited.	Yes	Yes	Yes	Yes
LSM68, 69	Reserved				
LSM70	When the value of this bit changes from 0 to 1, BACnet communication is enabled. When the value of this bit changes from 1 to 0, BACnet communication is prohibited. When the BACnet communication is stopped by error and restarts the BACnet communication, set 0 to the value of LSM70, and then set 1 to the value of LSM70 after the status of the BACnet communication is stopped. The status of the BACnet communication can be checked with the value of LSD260.	No	Yes	No	No
LSM71	When the value of this bit changes from 0 to 1, MICRO/I stops updating the display of the Data Log Display. When the value of this bit changes from 1 to 0, MICRO/I restarts updating the display.	Yes	Yes	Yes	Yes
LSM72 to 74	Reserved				
LSM75	When the value of this bit changes from 0 to 1, MICRO/I cancels sending all the social media messages in "Waiting" status. Even if the value of LSM76 is 1, this function can be executed.	Yes	No	No	No
LSM76	While the value of this bit is 1, MICRO/I pauses sending of all the social media messages in "Waiting" status. If the value changes from 0 to 1 while sending a social media message is in progress, MICRO/I will pause after such social media message has been sent.	Yes	No	No	No
LSM77	When the value changes from 0 to 1, the values of SSID, password, IP address, subnet mask, default gateway and port number for maintenance communication (LSD292 to 356) of the wireless LAN are written to the MICRO/I, then MICRO/I automatically resets. After the MICRO/I is reset, value becomes 0 when operation starts.	Yes	No	No	No
LSM78	When the value of this bit changes from 0 to 1, start the wireless LAN connection. When the value of this bit changes from 0 to 1, stop the wireless LAN connection. The status of the wireless LAN connection can be checked with the value of LSD366.	Yes	No	No	No
LSM79 to 95	Reserved				



- Transfer of the LSM10 Keep Relay and Keep Register to the flash memory can take an excess of one second. Writing to the Flash Memory can be repeated a maximum of 100,000 times. Keep writing to the Flash Memory to a minimum.
- When there is no remaining battery power, data transferred with LSM10 will be restored once the power to the MICRO/I has been turned on.
- LSM1, 2, 3 and 11 also operates when switches the Text Group.
- Once a value of LSM18, 20 and 22 changes from 0 to 1, it remains at a value of 1 until MICRO/I is reset or 0 is written, then the value is 0.



A scan refers to a period during which all parts placed on a screen are processed. It is not related to the period of reading values of external device addresses.

This operation of this relay is illustrated in the timing chart below.

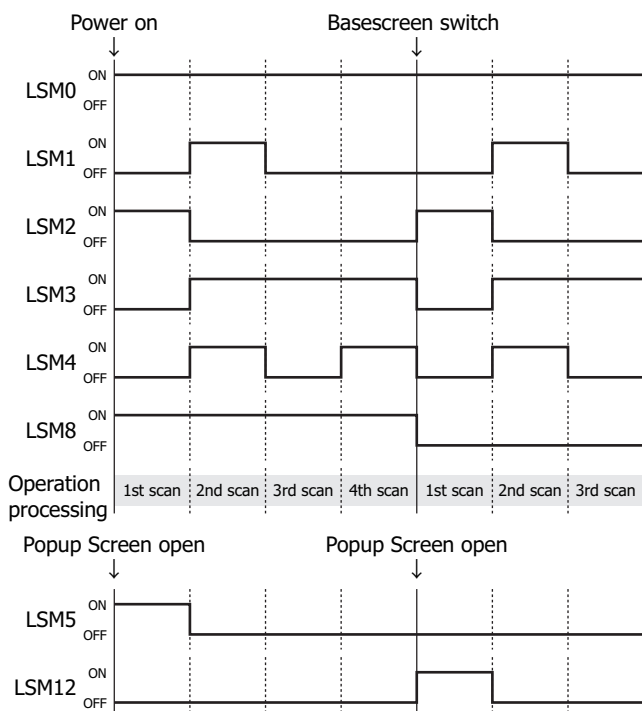

1.2 Control Device Addresses

HG2J-7U HG5G-V HG4G-V HG4G HG3G-V HG3G HG2G-V HG2G-5F HG2G-5T HG1G HG1P

Device Name	Symbol	R/W	Address Range	Base
Expansion Input (Bit)	#I	R	30 to 107	10 ^{*1}
Expansion Output (Bit)	#Q	R/W	30 to 127	10 ^{*1}
Internal Relay (Bit)	#M	R/W	0 to 797	10 ^{*1}



R/W is an abbreviation of Read/Write. R/W indicate that both reading and writing are possible, while R indicates that only reading is possible.

■ Expansion Input (#I)

Device addresses that input on/off information from external devices to the MICRO/I. Input Relay for digital I/O module connected to HG5G/4G/3G/2G-V and BACnet communication.

For details, refer to Chapter 30 "2.1 Using Digital I/O Modules" on page 30-12 and Chapter 3 "7 BACnet Communication" on page 3-94.

■ Expansion Output (#Q)

Device addresses that output on/off information from the MICRO/I to external devices. Output Relay for digital I/O module connected to HG5G/4G/3G/2G-V and BACnet communication.

For details, refer to Chapter 30 "2.1 Using Digital I/O Modules" on page 30-12 and Chapter 3 "7 BACnet Communication" on page 3-94.

■ Internal Relay (#M)

This is a bit-unit device for the BACnet communication.

For details, refer to Chapter 3 "7 BACnet Communication" on page 3-94.



All values of the control device addresses becomes 0 at the start of operation.



When entering the control device, inputs "#" before the symbol (device type). In addition, on the Device Monitor a "#" is displayed before the symbol.

Example: I100 is configured.

#I100

*1 The last digit of the address number is 0 to 7 in octal notation.

2 Word Devices

2.1 HMI Device Addresses

HG2J-7U HG5G-V HG4G-V HG4G HG3G-V HG3G HG2G-V HG2G-5F HG2G-5T HG1G HG1P

Internal Device Name	Symbol	R/W	Address Range	Base
HMI Data Register	LDR	R/W	0 to 16383 ^{*1} 0 to 8191 ^{*2}	10
HMI Keep Register	LKR	R/W	Variable	10
HMI Timer Current Value	LTD	R	0 to 31	10
Digital Input (Word) ^{*3}	WLEX	R	0, 20, 40, 60	10
Digital Output (Word) ^{*3}	WLEY	R/W	0, 20, 40, 60	10
HMI Temporary Register	LBR	R/W	0 to 255 ^{*1} 0 to 127 ^{*2}	10
HMI Link Register	LLR	R/W	0 to 63	10
HMI Expansion Input (Word) ^{*4}	WLI	R	0	16
HMI Expansion Output (Word) ^{*4}	WLQ	R/W	0	16
HMI Special Data Register	LSD	R/W	0 to 383	10



R/W is an abbreviation of Read/Write. R/W indicate that both reading and writing are possible, while R indicates that only reading is possible.

■ HMI Data Register (LDR)

This register is an internal register of MICRO/I.

■ HMI Keep Register (LKR)

The value in these registers is retained during power OFF. The maximum number of HMI Keep Register depends upon the number set in WindO/I-NV4. For details, refer to Chapter 16 "Minimum and Maximum Amount of Data Storage and Number of Addresses" on page 16-2.

■ HMI Timer Current Value (LTD)

This register stores the current value of Timer from the parts. 32 points are available.

■ Digital Input (Word) (WLEX), Digital Output Word (WLEY)

These registers handle the relays for digital inputs (words) and digital outputs (words) of expansion modules connected to the HG4G/3G and HG2G-5F in word units. For details, refer to Chapter 30 "2.1 Using Digital I/O Modules" on page 30-12.

■ HMI Temporary Register (LBR)

This register can be used to store value as temporary. This register value will be cleared to 0 when a text group or user account is changed, when a screen is reset or the screen is changed.

■ HMI Link Register (LLR)

An area that stores the data of the registered device addresses for the external device during when HG5G/4G/3G/2G-V, HG4G/3G, HG2G-5F/-5T, or HG1G/1p make Sub Host Communication.

64 points are available.

This register can also be used as an internal register like LDR when Sub Host Communication is not used.

■ HMI Expansion Input (Word) (WLI), HMI Expansion Output (Word) (WLQ)

These registers handle the expansion input or the expansion output used with HG1P in word unit. WLQ is a reserved area.

*1 HG2J-7U only

*2 HG5G/4G/3G/2G-V, HG4G/3G, HG2G-5F/-5T, HG1G/1P only

*3 HG4G/3G, HG2G-5F only

*4 HG1P only

■ HMI Special Data Register (LSD)

These registers (384 points) perform the following special operations. The supported device addresses vary based on the model.

Yes: Supported, No: Not supported, (blank): Reserved

Device Address	Function/Part	HG2J -7U	HG5G/ 4G/3G/ 2G-V	HG4G/ 3G, HG2G- 5F	HG2G -5T, HG1G /1P
LSD0 to 3	Reserved				
LSD4	Scan time Maximum value (msec.)	Yes	Yes	Yes	Yes
LSD5	Screen switch response time (msec.)	Yes	Yes	Yes	Yes
LSD6	Read scan communication time of External Device Communication 1 (msec.)	Yes	Yes	Yes	Yes
LSD7	Scan counter (incremented at each scan)	Yes	Yes	Yes	Yes
LSD8	1 second counter (incremented each second)	Yes	Yes	Yes	Yes
LSD9	10 msec. counter (increments every 10 msec.)	Yes	Yes	Yes	Yes
LSD10	100 msec. counter (incremented every 100 msec.)	Yes	Yes	Yes	Yes
LSD11	200 msec. counter (incremented every 200 msec.)	Yes	Yes	Yes	Yes
LSD12	500 msec. counter (incremented every 500 msec.)	Yes	Yes	Yes	Yes
LSD13	Stores the current Year data from the MICRO/I. "Year" (4 BCD digits)	Yes	Yes	Yes	Yes
LSD14	Stores current time data from MICRO/I. "Month" (2 BCD digits)	Yes	Yes	Yes	Yes
LSD15	Stores current time data from MICRO/I. "Day" (2 BCD digits)	Yes	Yes	Yes	Yes
LSD16	Stores current time data from MICRO/I. "Hour" (2 BCD digits)	Yes	Yes	Yes	Yes
LSD17	Stores current time data from MICRO/I. "Minute" (2 BCD digits)	Yes	Yes	Yes	Yes
LSD18	Stores current time data from MICRO/I. "Second" (2 BCD digits)	Yes	Yes	Yes	Yes
LSD19	Stores current time data from MICRO/I. "Day-of-week" (1 BCD digit) 0: Sunday, 1: Monday, 2: Tuesday, 3: Wednesday, 4: Thursday, 5: Friday, 6: Saturday	Yes	Yes	Yes	Yes
LSD20	When a value of "1" is written into this special register, the Internal clock in MICRO/I is updated according to the data stored in LSD21-26. It automatically resets to "0" after the update.	Yes	Yes	Yes	Yes
LSD21	Write a "Year" value to store in the MICRO/I internal clock. (2 BCD digits)	Yes	Yes	Yes	Yes
LSD22	Stores set value for "Month" in MICRO/I internal clock. (2 BCD digits)	Yes	Yes	Yes	Yes
LSD23	Stores set value for "Day" in MICRO/I internal clock. (2 BCD digits)	Yes	Yes	Yes	Yes
LSD24	Stores set value for "Hour" in MICRO/I internal clock. (2 BCD digits)	Yes	Yes	Yes	Yes
LSD25	Stores set value for "Minute" in MICRO/I internal clock. (2 BCD digits)	Yes	Yes	Yes	Yes
LSD26	Stores set value for "Second" in MICRO/I internal clock. (2 BCD digits)	Yes	Yes	Yes	Yes
LSD27	Scan time Current value (msec.)	Yes	Yes	Yes	Yes
LSD28	Scan time Minimum value (msec.)	Yes	Yes	Yes	Yes
LSD29	Execution result of SNTP Server 0: Successfully Completed 2: Timeout error 4: Other error	Yes	No	No	No
LSD30	Stores the elapsed time (0 to 65535 minutes) from the point when MICRO/I obtained the time from the SNTP server until now. The value resets and elapsed time starts getting stored once MICRO/I successfully obtain current time from the SNTP server. In case MICRO/I fails to obtain the current time, the elapsed time will not reset and keep on getting stored until successfully obtaining the time.	Yes	No	No	No
LSD31	Stores the currently displayed screen number.	Yes	Yes	Yes	Yes
LSD32	Set a value (in reference to a Base Screen number you want to switch to) and it will automatically switch to a specified Base Screen number. The data type is determined by the data type specified in Screen Number Format on the Project Setting dialog box.	Yes	Yes	Yes	Yes

Device Address	Function/Part	HG2J-7U	HG5G/4G/3G/2G-V	HG4G/3G, HG2G-5F	HG2G-5T, HG1G/1P
LSD33	USB flash drive error status 0: Normal 1: A write occurred when the USB flash drive was not inserted or when an incompatible USB flash drive was inserted 2: Format error 3: Access error, Insufficient memory in USB flash drive or Reading or writing failure 4: Unsuccessful read of picture data	No	No	No	Yes
LSD34	USB flash drive ^{*5} free memory capacity Lower word (Kbytes)	Yes	Yes	Yes	Yes
LSD35	USB flash drive ^{*5} free memory capacity Upper word (Kbytes)	Yes	Yes	Yes	Yes
LSD36	USB flash drive ^{*5} total memory capacity Lower word (Kbytes)	Yes	Yes	Yes	Yes
LSD37	USB flash drive ^{*5} total memory capacity Upper word (Kbytes)	Yes	Yes	Yes	Yes
LSD38 to 41	Reserved				
LSD42	External memory device ^{*6} error status 0: Normal 1: A write occurred when the USB flash drive was not inserted or when an incompatible USB flash drive was inserted 2: Format error 3: Access error, Insufficient memory in Memory card or Reading or writing failure. 4: Unsuccessful read of picture data	Yes	Yes	Yes	No
LSD43	External memory device ^{*6} free memory capacity Lower word (Kbytes)	Yes	Yes	Yes	No
LSD44	External memory device ^{*6} free memory capacity Upper word (Kbytes)	Yes	Yes	Yes	No
LSD45	External memory device ^{*6} total memory capacity Lower word (Kbytes)	Yes	Yes	Yes	No
LSD46	External memory device ^{*6} total memory capacity Upper word (Kbytes)	Yes	Yes	Yes	No
LSD47	Reserved (for Communication drivers)				
LSD48	Reserved				
LSD49	Stores the O/I Link slave station number. (Read-only)	Yes	Yes	Yes	Yes
LSD50	The sequence value of the message number (or channel number if the alarm function is being used) selected by the cursor in the Alarm List Display is stored. A value of between 1 and 1024 (allocated using ((Block No. - 1) x 16 + bit number + 1)) is stored for the number.	Yes	Yes	Yes	Yes
LSD51	Brightness level: -16 to 31 ^{*7} , 0 to 31 ^{*8}	Yes	Yes	Yes	Yes
LSD52	The ID number of the script for which the error occurred.	Yes	Yes	Yes	Yes
LSD53	Script error status 0: Normal 1: Processing error 2: Execution time over error 3: Writing count error 4: Indirect device error 5: Parameter error 6: Fixed Interval Script execution time over 7: Fixed interval execution error For details about the Script error, refer to Chapter 20 "Types and causes of script errors" on page 20-4.	Yes	Yes	Yes	Yes
LSD54	Reserved (for Script)				
LSD55	Reserved				
LSD56	The number of lines of data from the start line to the line currently selected with the cursor displayed in the Alarm List Display or Alarm Log Display is stored.	Yes	Yes	Yes	Yes
LSD57	The number of log data pieces stored in the Data Storage Area by the alarm log function is stored. (0 to 1024)	Yes	Yes	Yes	Yes

*5 USB flash drive inserted in USB2 for HG2J-7U

*6 USB flash drive inserted in USB1 for HG2J-7U, SD memory card for HG5G/4G/3G/2G-V, HG4G/3G and HG2G-5F

*7 HG2J-7U, HG5G/4G/3G/2G-V, HG4G/3G, HG2G-5F only

*8 HG2G-5T, HG1G/1P only

Device Address	Function/Part	HG2J-7U	HG5G/4G/3G/2G-V	HG4G/3G, HG2G-5F	HG2G-5T, HG1G/1P
LSD58	USB flash drive download status The following bit changes to 1 while downloading to USB flash drive by WindO/I-NV4. The bit changes to 0 after the download. Bit 2: Recipe file Bit 4: ZNV Project File Bit 5: Picture file Bit 9: ZLD Project File	No	No	No	Yes
LSD59	SD memory card download status The following bit changes to 1 while downloading to SD memory card by WindO/I-NV4. The bit changes to 0 after the download. Bit 2: Recipe file Bit 4: ZNV Project File Bit 5: Picture file Bit 8: Sound file* ⁹ Bit 9: ZLD Project File	No	Yes	Yes	No
LSD60	Reserved (for Line Chart)				
LSD61	Reserved (for Trigger Condition)				
LSD62	Reserved (for TCP/IP)				
LSD63 to 64	Reserved				
LSD65	Maximum number of screenshots that can be saved to external memory device * ¹⁰ .	Yes	Yes	Yes	Yes
LSD66	Reserved				
LSD67	Stores the connection status for TCP clients and the TCP server for the User Communication set to the Ethernet interface. Bit 0: User Communication 1 Bit 1: User Communication 2 Bit 2: User Communication 3	Yes	Yes	Yes	Yes
LSD68	When the value changes from 0 to 1, the connections for the TCP clients and the TCP server for the User Communication set to the Ethernet interface are forcibly disconnected. Bit 0: User Communication 1 Bit 1: User Communication 2 Bit 2: User Communication 3	Yes	Yes	Yes	Yes
LSD69 to 71	Reserved				
LSD72	Stores the currently played sound file number.	Yes	Yes	Yes* ⁹	No
LSD73	Stores the sound ID which could not be played by any errors.	Yes	Yes	Yes* ⁹	No
LSD74 to 78	Reserved				
LSD79	Quantity of Expansion I/O Modules	No	Yes	Yes	No
LSD80 to 96	Reserved				
LSD97	Read scan communication time of External Device Communication 2 (msec.)	Yes	Yes	Yes	Yes
LSD98	Read scan communication time of External Device Communication 3 (msec.)	Yes	Yes	Yes	Yes
LSD99	Read scan communication time of External Device Communication 4 (msec.)	Yes	Yes	Yes	Yes
LSD100	Reserved (for O/I Link Communication)				
LSD101	Polling period register for the O/I Link Slave	Yes	Yes	Yes	Yes
LSD102	Slave registration setting register for O/I Link Master	Yes	Yes	Yes	Yes
LSD103	Reserved (for O/I Link communication)				
LSD104	Slave online information register for O/I Link Master	Yes	Yes	Yes	Yes

*⁹ This is applicable for models with an audio interface only.

*¹⁰ USB flash drive inserted in USB1 for HG2J-7U, SD memory card for HG5G/4G/3G/2G-V, HG4G/3G and HG2G-5F, USB flash drive for HG2G-5T and HG1G/1P

Device Address	Function/Part	HG2J -7U	HG5G/ 4G/3G/ 2G-V	HG4G/ 3G, HG2G- 5F	HG2G -5T, HG1G /1P
LSD105	Reserved (for O/I Link communication)				
LSD106	Slave error information register for O/I Link Master	Yes	Yes	Yes	Yes
LSD107	Reserved (for O/I Link communication)				
LSD108, 109	Reserved				
LSD110, 111	Reserved (for Communication drivers)				
LSD112	Register for Communication drivers For details, refer to the WindO/I-NV4 External Device Setup Manual.	Yes	Yes	Yes	Yes
LSD113 to 119	Reserved (for Communication drivers)				
LSD120 to 123	The preset value for Preferred DNS Server. When the value of LSM53 changes from 0 to 1, the values of these device addresses are written to the MICRO/I. When the power is turned on, the set values of the project are read to these device addresses. Example: When the IP address is 192.168.0.11 LSD120=192, LSD121=168, LSD122=0, LSD123=11	Yes	Yes	Yes	Yes
LSD124 to 127	The preset value for Alternate DNS Server. When the value of LSM53 changes from 0 to 1, the values of these device addresses are written to the MICRO/I. When the power is turned on, the set values of the project are read to these device addresses. Example: When the IP address is 192.168.0.12 LSD124=192, LSD125=168, LSD126=0, LSD127=12	Yes	Yes	Yes	Yes
LSD128 to 154	Reserved				
LSD155	Event Recording Function Status Information While data is being recorded after an event occurs with the event recording function or while recorded data is being saved to the external memory device, the value of bit 0 changes to 1. It changes to 0 when the saving operation completes.	No	Yes	Yes*11	No
LSD156 to 164	Reserved				
LSD165	Multimedia Function Error Information 0: Normal 1: Specified file does not exist 2: File format is incorrect 3: Specified parameter value is out of range	No	Yes	Yes*11	No
LSD166 to 191	Reserved				
LSD192 to 195	The preset value for IP address of the MICRO/I. When the value of LSM53 changes from 0 to 1, the values of these device addresses are written to the MICRO/I. When the power is turned on, the set values of the project are read to these device addresses. Example: When the IP address is 192.168.0.1 LSD192=192, LSD193=168, LSD194=0, LSD195=1	Yes	Yes	Yes	Yes
LSD196 to 199	The preset value for subnet mask of the MICRO/I. When the value of LSM53 changes from 0 to 1, the values of these device addresses are written to the MICRO/I. When the power is turned on, the set values of the project are read to these device addresses. Example: When the subnet mask is 255.255.254.0 LSD196=255, LSD197=255, LSD198=254, LSD199=0	Yes	Yes	Yes	Yes
LSD200 to 203	The preset value for default gateway of the MICRO/I. When the value of LSM53 changes from 0 to 1, the values of these device addresses are written to the MICRO/I. When the power is turned on, the set values of the project are read to these device addresses. Example: When the default gateway is 192.168.0.24 LSD200=192, LSD201=168, LSD202=0, LSD203=24	Yes	Yes	Yes	Yes
LSD204	The External Device ID to change the IP address and the port number	Yes	Yes	Yes	Yes

*11 This is applicable for models with a video interface only.

Device Address	Function/Part	HG2J -7U	HG5G/ 4G/3G/ 2G-V	HG4G/ 3G, HG2G- 5F	HG2G -5T, HG1G /1P
LSD205 to 208	The preset value for IP address of external device. When the LSM54 changes from 0 to 1, the values of these device addresses are written to the MICRO/I. When the value of LSD204 changes, the set values of the project are read to these device addresses. Example: The IP address is 192.168.0.2 LSD205=192, LSD206=168, LSD207=0, LSD208=2	Yes	Yes	Yes	Yes
LSD209	The preset value for the port number of the external device. When the value of LSM54 is changed to 1, the value of this device address is written to the MICRO/I. When the value of LSD204 changes, the set value of the project is read to this device address.	Yes	Yes	Yes	Yes
LSD210 to 212	Reserved				
LSD213	The preset value for port number for maintenance communication of the MICRO/I. When the value of LSM53 changes from 0 to 1, the value of this device address is written to the MICRO/I. When the power is turned on, the set value of the project is read to this device address.	Yes	Yes	Yes	Yes
LSD214 to 219	Reserved				
LSD220	Ethernet port configuration error information The following bits change to 1 when allocating the port numbers used by the various Ethernet communications functions has failed. The bits are 0 when allocating the port numbers was successful or a function is not used. Bit 0: Maintenance Communication Bit 1: Pass-Through *2 Bit 2: FC4A Series MicroSmart direct connection pass-through *2 Bit 3: User Communication Bit 4: Web Server Function Bit 5: FTP Server Function Bit 6: FTP Client Function Bit 7: E-mail Function Bit 8: External Device Communication 1 Bit 9: External Device Communication 2 Bit 10: External Device Communication 3 Bit 11: External Device Communication 4 Bit 12: BACnet communication *12	Yes	Yes	Yes	Yes
LSD221	Number of e-mail in "Waiting" status	Yes	Yes	Yes	Yes
LSD222	Result of e-mail sending 0: Successfully Completed 1: Parameter error 2: Timeout error (Timeout period: 30 seconds) 3: Authentication error 4: Other error	Yes	Yes	Yes	Yes
LSD223	E-mail number which has been sent	Yes	Yes	Yes	Yes
LSD224 to 228	Reserved				
LSD229	Specifies the character encoding method used when reading and writing strings from the Custom Web Page. 0: No Conversion(UTF-8) 1: Japanese (Shift-JIS) 2: Western (ISO 8859-1) 3: Simplified Chinese (GB2312) 4: Traditional Chinese (BIG5) 5: Hangul (KSC5601) 6: Central European (ANSI1250) 7: Baltic (ANSI1257) 8: Cyrillic (ANSI1251)	Yes	Yes	Yes	Yes
LSD230	Number of the FTP server connected to using the FTP client function	Yes	Yes	Yes	Yes
LSD231	Number of file transfer successes The register is set to 0 at the start of file transfers. 1 is added to the register when a file transfer ends without any errors.	Yes	Yes	Yes	Yes

*2 HG5G/4G/3G/2G-V, HG4G/3G, HG2G-5F/-5T, HG1G/1P only

*12 HG5G/4G/3G/2G-V only

Device Address	Function/Part	HG2J -7U	HG5G/ 4G/3G/ 2G-V	HG4G/ 3G, HG2G- 5F	HG2G -5T, HG1G /1P
LSD232	Number of file transfer failures The register is set to 0 at the start of file transfers. 1 is added to the register when any error occurs in the file transfer.	Yes	Yes	Yes	Yes
LSD233 to 239	Reserved				
LSD240, 241	Version number of the system software Example: The version number of the system software is version 4.38. LSD240=0438(Hex), LSD241=0000(Hex)	Yes	Yes	Yes	Yes
LSD242, 243	Version number of WindO/I-NV4 Example: The version number of WindO/I-NV4 is version 1.2.3. LSD242=0102(Hex), LSD243=0300(Hex)	Yes	Yes	Yes	Yes
LSD244 to 247	Reserved				
LSD248	File transfer status to the USB flash drive by using the FTP server function. The following bit changes to 1 while transferring files to USB flash drive inserted into the MICRO/I from an FTP client. The bit changes to 0 after the transfer. Bit 2: Recipe file Bit 4: ZNV Project File Bit 5: Picture file Bit 8: Sound file* ⁹ Bit 9: ZLD Project File Bit 10: Movie file* ¹¹ Bit 15: Other file	No	Yes	Yes	Yes
LSD249	File transfer status to the SD memory card by using the FTP server function. The following bit changes to 1 while transferring files to SD memory card inserted into the MICRO/I from an FTP client. The bit changes to 0 after the transfer. Bit 2: Recipe file Bit 4: ZNV Project File Bit 5: Picture file Bit 8: Sound file* ⁹ Bit 9: ZLD Project File Bit 10: Movie file* ¹¹ Bit 15: Other file	No	Yes	Yes	No
LSD250 to 255	Reserved				
LSD256	Input mode of Character Input Stores the input method from the keypad for the Character Input. 0: Direct input mode 1: Kanji input mode	No	Yes	No	No
LSD257 to 259	Reserved				
LSD260	BACnet communication status Stores the status for BACnet communication. Bit 0: Stopped Bit 1: Ready Bit 2: Operating Bit 3: Stopped by error	No	Yes	No	No
LSD261	BACnet Communication Error Information Stores the last error information that has occurred in BACnet communication. Bit 0: Normal Bit 1: Invalid device ID Bit 2: Invalid IP address Bit 3: Invalid BBMD IP address Bit 4: BBDM registration failure	No	Yes	No	No
LSD262 to 269	Reserved				

*9 This is applicable for models with an audio interface only.

*11 This is applicable for models with a video interface only.

Device Address	Function/Part	HG2J -7U	HG5G/ 4G/3G/ 2G-V	HG4G/ 3G, HG2G- 5F	HG2G -5T, HG1G /1P
LSD270	Expansion Module Slot 1 Information (Type ID and Status)	No	Yes	No	No
LSD271	Expansion Module Slot 1 Information (System Software Version and Position Information)	No	Yes	No	No
LSD272	Expansion Module Slot 2 Information (Type ID and Status)	No	Yes	No	No
LSD273	Expansion Module Slot 2 Information (System Software Version and Position Information)	No	Yes	No	No
LSD274	Expansion Module Slot 3 Information (Type ID and Status)	No	Yes	No	No
LSD275	Expansion Module Slot 3 Information (System Software Version and Position Information)	No	Yes	No	No
LSD276	Expansion Module Slot 4 Information (Type ID and Status)	No	Yes	No	No
LSD277	Expansion Module Slot 4 Information (System Software Version and Position Information)	No	Yes	No	No
LSD278 to 285	Reserved				
LSD286 to 291	MAC address number Example: The MAC address number is 00:03:7B:F0:12:A8. LSD286=0000(Hex), LSD287=0003(Hex), LSD288=007B(Hex), LSD289=00F0(Hex), LSD290=0012(Hex), LSD291=00A8(Hex)	Yes	Yes	Yes	Yes
LSD292 to 308	The preset value for the SSID of the access point. When the value of LSM77 changes from 0 to 1, the values of these device addresses are written to the MICRO/I. When the power is turned on, the preset values of the project are set to these device addresses. (The seventeenth word is recognized as a NULL terminating character (0x00) regardless of the value of device address. Add a NULL terminating character (0x00) as the end of the string data when the string length is less than sixteen words.) Example: The SSID of the access point is "z1xfujisan". LSD292='z1'(0x7A, 0x31), LSD293='x_(0x78, 0x5F), LSD294='fu'(0x66, 0x75), LSD295='ji'(0x6A, 0x69), LSD296='sa'(0x73, 0x61), LSD297='n'(0x6E, 0x00), LSD298 to LSD308=''(0x00, 0x00)	Yes	No	No	No
LSD309 to 341	The preset value for the password of the access point. When the value of LSM77 changes from 0 to 1, the values of these device addresses are written to the MICRO/I. When the power is turned on, the preset values of the project are set to these device addresses. (The thirty-third word is recognized as a NULL terminating character (0x00) regardless of the value of device address. Add a NULL terminating character (0x00) as the end of the string data when the string length is less than thirty-two words.) Example: The password of the access point is "password". LSD309='pa'(0x70,0x61), LSD310='ss'(0x73,0x73), LSD311='wo'(0x77,0x6F), LSD312='rd'(0x72,0x64), LSD313 to LSD341=''(0x00,0x00)	Yes	No	No	No
LSD342, 343	Reserved				
LSD344 to 347	The preset value for IP address of the wireless LAN. When the value of LSM77 changes from 0 to 1, the values of these device addresses are written to the MICRO/I. When the power is turned on, the preset values of the project are set to these device addresses. Example: The IP address is 192.168.0.150 LSD344=192, LSD345=168, LSD346=0, LSD347=150	Yes	No	No	No
LSD348 to 351	The preset value for subnet mask of the wireless LAN. When the value of LSM77 changes from 0 to 1, the values of these device addresses are written to the MICRO/I. When the power is turned on, the preset values of the project are set to these device addresses. Example: The subnet mask is 255.255.255.0 LSD348=255, LSD349=255, LSD350=255, LSD351=0	Yes	No	No	No
LSD352 to 355	Reserved				

Device Address	Function/Part	HG2J-7U	HG5G/4G/3G/2G-V	HG4G/3G, HG2G-5F	HG2G-5T, HG1G/1P
LSD356	The preset value for port number for maintenance communication of the wireless LAN. When the value of LSM77 changes from 0 to 1, the value of this device address is written to the MICRO/I. When the power is turned on, the preset value of the project is set to this device address.	Yes	No	No	No
LSD357 to 365	Reserved				
LSD366	Wireless LAN connection status Stores the status of the wireless LAN connection. Bit 0: Stopped Bit 2: Connecting	Yes	No	No	No
LSD367	Wireless LAN signal strength Stores the signal strength of the SSID (LSD292 to 308) of the access point. If the SSID is changed, the signal strength for the SSID before the change will be obtained. When the SSID is set to stealth, the signal strength cannot be measured. 0: Stopped 1: Weak 2: Normal 3: Good	Yes	No	No	No
LSD368	Number of social media message in "Waiting" status	Yes	No	No	No
LSD369	Result of social media message sending 0: Successfully Completed 1: Parameter error 2: Timeout error 3: Authentication error 4: User error 5: Other error	Yes	No	No	No
LSD370	Social media message number which has been sent	Yes	No	No	No
LSD371 to 383	Reserved				



- LSD4 and 6 store the maximum value, and when the Base Screen is switched, they are reset.
- The values of LSD4 to 6 are included errors of +/- 10 msec.
- The values of LSD38 to 40 are included errors of +/- 10 msec.
- When registers LSD7, 8, 9, 10, 11 or 12 contain FFFF (H) and are incremented, the value becomes 0.
- When you reckon time by using LSD9, the time difference (in 10ms units) from the previous value can be calculated.
- The range for the "Year" in LSD13 is 2000 to 2099, and reverts to 2000 after 2099.
- When "1" is written to LSD20, internal clock is updated by the contents of LSD21-26. After setting the year, month, day, hour, minute, and second data in LSD21 to 26, writes a "1" to LSD20.
- The display format for LSD31 is set under "Screen No. Format" in Project Settings. (BCD, BIN)
- The data type of the value stored in LSD32 is determined by the data type specified in Screen Number Format on the Project Settings dialog box.(BCD, BIN)
If the screen number is not exist in the project, "No Screen Data" message will appear.
If 0xFFFF(Hex) is written to LSD32, MICRO/I will display the Top Page of System Mode .
In case that the current screen is changed by System Area1 and LSD32 at the same instant, the screen number of the System Area1 will be displayed.
- The data stored in LSD34 to 37, 43 to 46 are stored in kilobytes. 1 K byte is 1024 bytes. Values of less than 1 K byte are rounded up.
- By using the LSD50 value in the Message Switch Display you can display the message that corresponds to the cursor in the Alarm List Display.
- Refer to Chapter 20 "1.4 Script Error" on page 20-4 for details regarding LSD52 and LSD53.
- LSM7 and LSD6, 102 to 107 are not available for Slave units when using O/I link communication.
- The maximum number of the Screen Captures stored in the external memory device^{*10} is set in LSD65. The value in LSD65 can be anywhere from 1 to 999. (The default value is 99.)

*10 USB flash drive inserted in USB1 for HG2J-7U, SD memory card for HG5G/4G/3G/2G-V, HG4G/3G and HG2G-5F, USB flash drive for HG2G-5T and HG1G/1P

2.2 Control Device Addresses

HG2J-7U HG5G-V HG4G-V HG4G HG3G-V HG3G HG2G-V HG2G-5F HG2G-5T HG1G HG1P

Device Name	Symbol	R/W	Address Range	Base
Expansion Input (Word)	#WI	R	30, 50, 70, 90	10
Expansion Output (Word)	#WQ	R/W	30, 50, 70, 90, 110	10
Internal Relay (Word)	#WM	R/W	0 to 780* ¹	10
Data Register	#D	R/W	0 to 2999	10



R/W is an abbreviation of Read/Write. R/W indicate that both reading and writing are possible, while R indicates that only reading is possible.

■ Expansion Input (#WI)

This is a device address for handling bit device Extension Input (#I) used with digital I/O module and BACnet communication in word unit.

■ Expansion Output (#WQ)

This is a device address for handling bit device Extension Output (#Q) used with digital I/O module and BACnet communication in word unit.

■ Internal Relay (#WM)

This is a device address for handling bit device Internal Relay (#M) in word unit.

■ Data Register (#D)

This is a word device used for analog I/O module and BACnet communication.



All values of the control device addresses becomes 0 at the start of operation.



When entering the control device, inputs "#" before the symbol (device type). In addition, on the Device Monitor a "#" is displayed before the symbol.

Example: D100 is configured.

#D100

*1 Multiples of 20 only

Chapter 34 MICRO/I Setup

This chapter describes the MICRO/I setup screen and how to perform setup.

1 Maintenance Screen

HG2J-7U HG5G-V HG4G-V HG4G HG3G-V HG3G HG2G-V HG2G-5F HG2G-5T HG1G HG1P

34

MICRO/I Setup

1.1 Maintenance Screen Overview

Using the screen that is displayed when the MICRO/I is in Run Mode, you can switch from Run Mode to System Mode and load a screen to adjust device monitor and screen brightness.

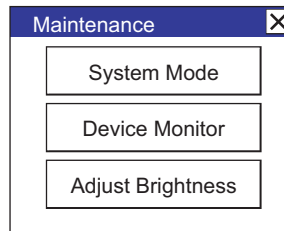

Maintenance screen functions are indicated below:

Button	Description
System Mode	Switch the MICRO/I to System Mode. In System Mode, the MICRO/I can be changed to its initial settings and data can be initialized. For details, refer to "2 System Mode Overview" on page 34-3.
Device Monitor	Shows the Device Monitor. This screen can be used to register device addresses and monitor and change values of device addresses. For details, refer to Chapter 25 "2.2 Device Monitor" on page 25-21.
Adjust Brightness	Shows the adjust brightness screen. This screen is used to adjust the brightness of the MICRO/I.



If a password has been configured for the project data and press System Mode or Device Monitor, the Enter Password screen will be displayed. Select a user name and then enter a password. For details, refer to Chapter 23 "User Accounts and the Security Function" on page 23-1.

1.2 Displaying the Maintenance Screen

Press the upper-left corner of the MICRO/I screen for three seconds or more.

If the Base Screen is switched before three seconds have elapsed, the load operation for the maintenance screen will be canceled. Please press it again.

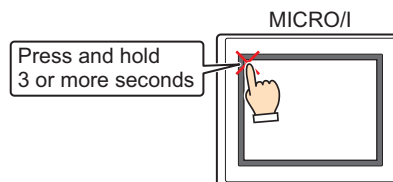

- To display the maintenance screen, select the **Enable Maintenance** check box under the **System** tab in the Project Settings dialog box.
- If a touch switch is placed in the upper-left corner of the screen, switching to the maintenance screen will not be possible.

1.3 Adjusting Screen Brightness

- 1 On the maintenance screen, press **Adjust Brightness**.

The Adjust Brightness screen is displayed.

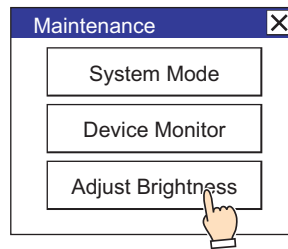

Also, press <<< or >>> to adjust to your preferred brightness.



Screen brightness can be adjusted using methods other than the ones listed above.

- <<< or >>> buttons on the Top Page in System Mode
- Changing the values for HMI Special Data Register LSD51.

2 System Mode Overview

HG2J-7U HG5G-V HG4G-V HG4G HG3G-V HG3G HG2G-V HG2G-5F HG2G-5T HG1G HG1P

The System Mode allows you to access the internal MICRO/I initial settings, self diagnosis, and clearing logged data. In this mode, the project in the MICRO/I will not be running.

2.1 System Mode Screens

In the System Mode, the Top Page appears (as shown below).

Top Page

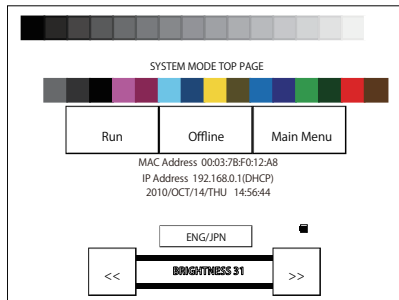

Main Menu screen

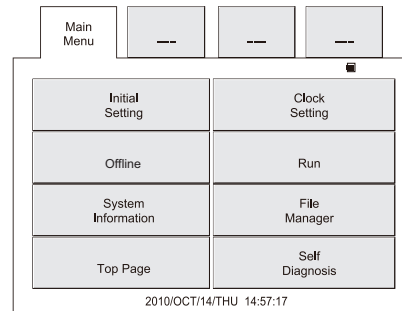

Press **Main Menu** to display the Main Menu screen shown in the right figure.



For information on accessing the MICRO/I System Mode, refer to "1.2 Displaying the Maintenance Screen" on page 34-1. Design may change slightly depending on model.

■ Battery Level Status*1

The symbol of Battery Level Status is displayed on the Top Page and the Main Menu screen.

Full ↓ Empty		Battery level is full.
		Battery level is running low. (The "Battery Level Low" message appears at the top of the screen.)
		Battery level is almost empty, or not inserted. (The "Replace Battery. Battery Level Low" message appears at the top of the screen.)



The Symbols depend on MICRO/I model.

*1 HG5G/4G/3G/2G-V, HG4G/3G, HG2G-5F/-5T, HG1G only

The Top Page and Main Menu screen have the items shown below. Pressing each button switches to the corresponding setting or operation screen.

■ Top Page

Item	Descriptions	See page
Run	Switches to Run Mode.	Page 34-11
Offline	Switches to Offline mode.	Page 34-11
Main Menu	Switches to Main Menu screen.	Page 34-4

■ Main Menu screen

Item		Descriptions	See page
HG2J-7U, HG5G/4G/3G/2G-V, HG4G/3G, HG2G-5F	HG2G-5T, HG1G/1P		
Initial Setting	Initial Setting	<ul style="list-style-type: none"> •Setup the settings relating to operation and communication parameters of the MICRO/I. •Initialize the log data. 	Page 34-7
Clock Setting	Clock Setting	Sets the internal clock of the MICRO/I.	Page 34-11
Offline	Offline	Goes to Offline mode.	Page 34-11
Run	Run	Goes to Run mode	Page 34-11
System Information	System Info.	Displays information relating to the type No., projects, as well as system software of the current MICRO/I.	Page 34-12
File Manager* ²	—	Manage the files saved in SD memory cards, USB flash drives, and the internal memory of the MICRO/I.	Page 34-13
—	Ext.Mem.Device	Format USB flash drive.	Page 34-13
Top Page	Top Page	Switches to Top Page.	Page 34-13
Self Diagnosis	Self Diag.	Executes self diagnosis of memory, the clock, the touch panel, display, communication, expansion interface and others.	Page 34-13



For the HG2J-7U, the HG5G/4G/3G/2G-V, HG4G/3G and the HG2G-5F, you can change the display language by pressing **[ENG/JPN]**. HG2G-5T and HG1G/1P can only display the screens of the System Mode in English.

*2 HG5G/4G/3G/2G-V, HG4G/3G, HG2G-5F only

2.2 Names and Layout of Setup Menus

■ HG2J-7U, HG5G/4G/3G/2G-V, HG4G/3G, HG2G-5F

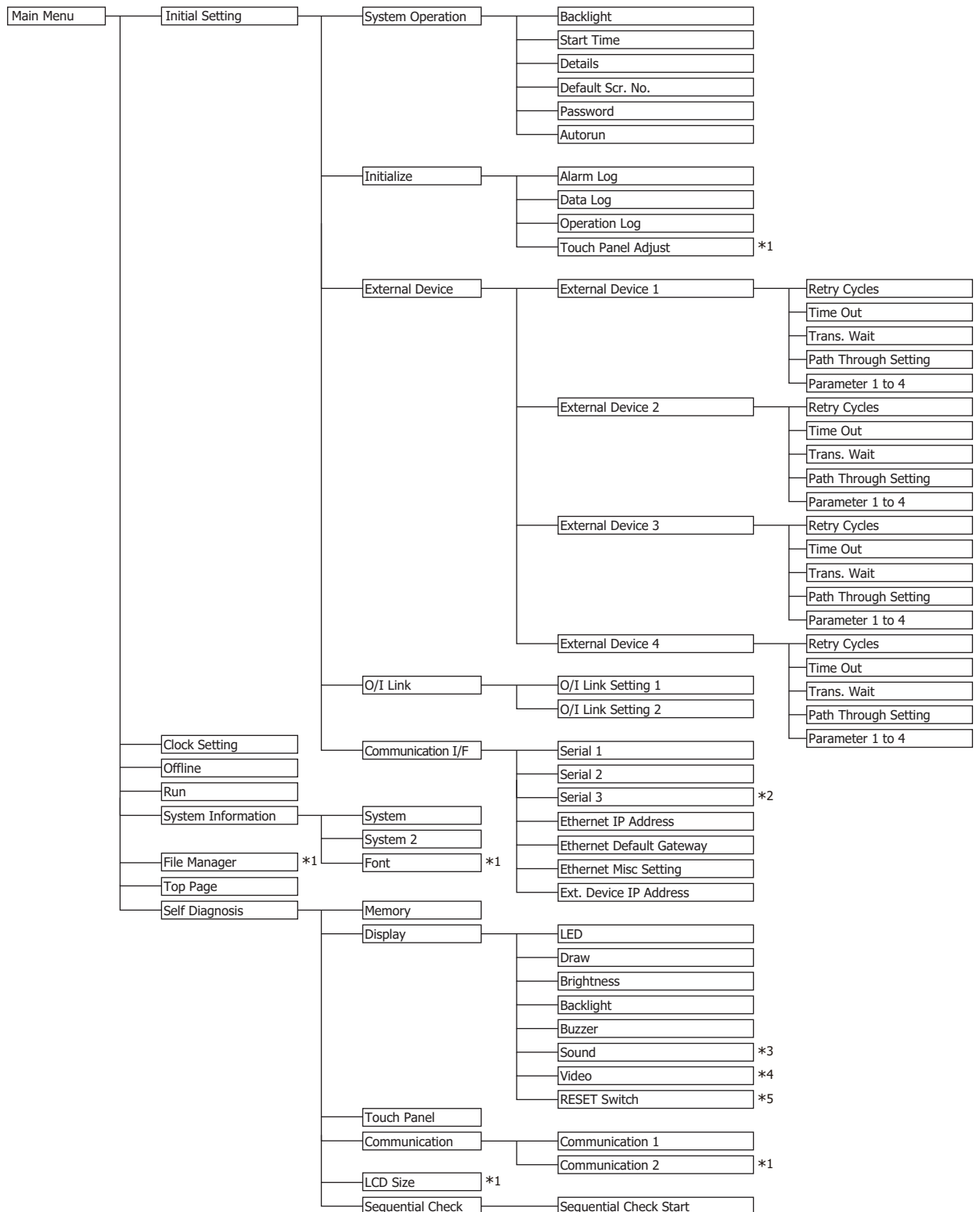

*1 HG5G/4G/3G/2G-V, HG4G/3G, HG2G-5F only

*2 HG5G/4G/3G/2G-V only

*3 This is applicable for models with an audio interface only.

*4 This is applicable for models with a video interface only.

*5 HG2J-7U only

■ HG2G-5T, HG1G/1P

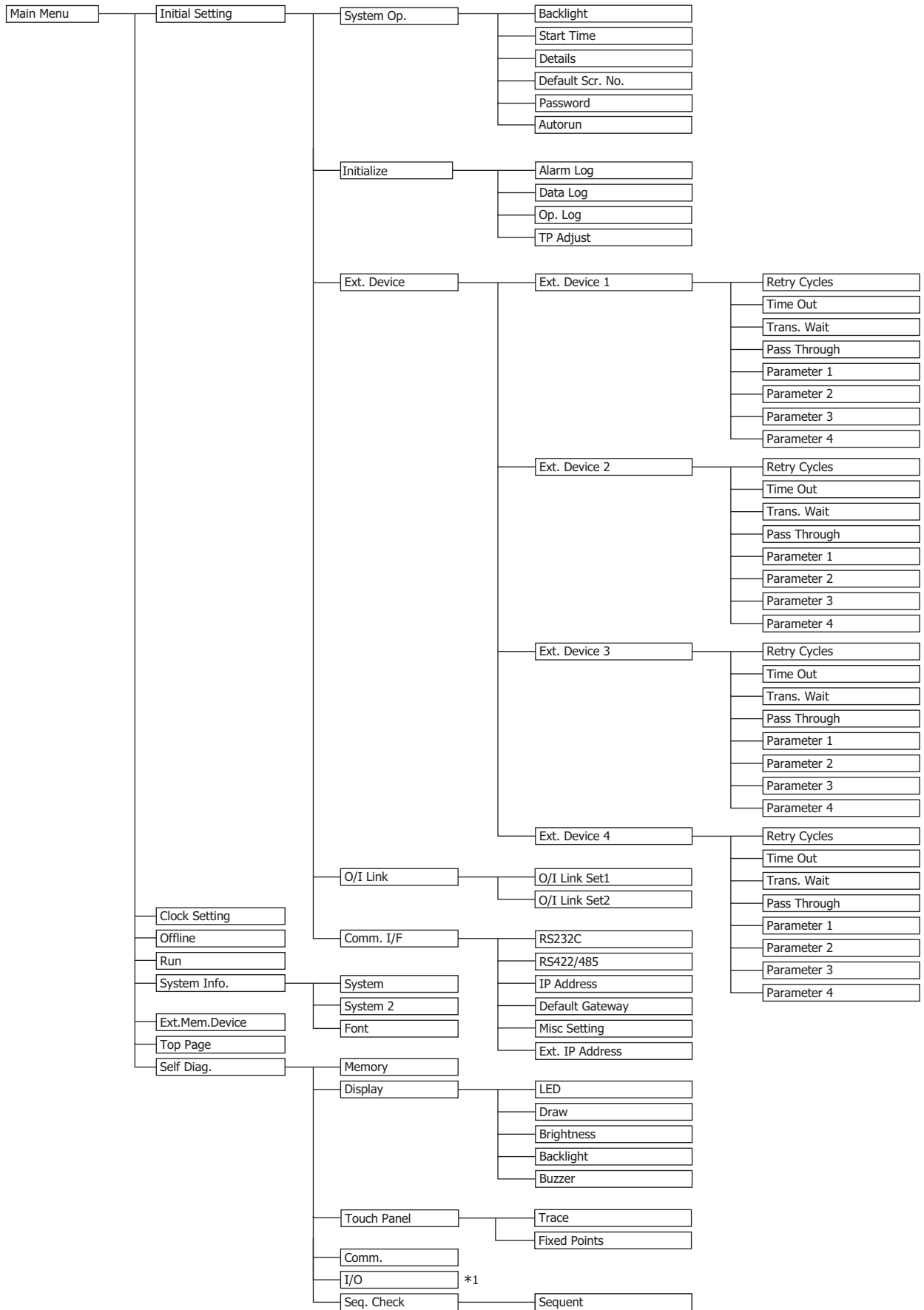

*1 HG1P only

3 Settings

HG2J-7U HG5G-V HG4G-V HG4G HG3G-V HG3G HG2G-V HG2G-5F HG2G-5T HG1G HG1P

The followings are displayed in the HG2J-7U, HG5G/4G/3G/2G-V, HG4G/3G, HG2G-5F. Description between the parentheses are displayed in the HG2G-5T, HG1G/1P.

3.1 Initial Setting (Initial Setting)

Pressing **Initial Setting** in the Main Menu screen displays the setup screen.

You can use this screen to input the settings for MICRO/I operation and communication parameters, and to clear the logs. To return to the Main Menu screen, press **Main Menu** at the top of the screen.

● System Operation (System Op.)

From the Main Menu screen, press **Initial Setting (Initial Setting)**, and then **System Operation (System Op.)** to display the system operation menu screen.

You can use this screen to set the items below. Press the button for each item to set it.



- To return to the initial settings screen, press **Init Set (Init Set)** at the top of the screen.
- To return to the system operation menu screen from any of the settings screens below, press **System Operation (System Op.)** at the top of the screen.

■ Backlight (Backlight)

Backlight Control

Set the amount of time (in minutes) until the backlight brightness is reduced automatically when the screen is not touched or switched.

Auto Backlight OFF

Set the amount of time (in minutes) until the backlight turns off automatically when the screen is not touched or switched.

Procedure

- 1 From the Main Menu screen, press **Initial Setting (Initial Setting)**, **System Operation (System Op.)**, and then **Backlight (Backlight)**.
- 2 Press the left/right buttons to select the item, and then enter the time until the backlight brightness is reduced automatically with the numeric keys.
- 3 Press the left/right buttons to select the item, and then enter the time until the backlight automatically turns off with the numeric keys.
- 4 Press **SAVE (SAVE)** button to save the settings.



- If you switch to another screen or change the value before pressing **SAVE (SAVE)**, the settings are not saved.
- Functions with the time set to 0 are disabled.

■ Start Time (Start Time)

It can be set vary based on the model.

HG2J-7U: Specifies the start time of communication with the external device (0 to 9999 seconds) after the MICRO/I power is turned on and the POWER LED (green) changes from blinking to lit.

HG5G/4G/3G/2G-V, HG4G/3G, HG2G-5F/-5T, HG1G/1P:

Specifies the start time of communication with the external device (0 to 9999 seconds) after the MICRO/I power is turned on.

This item sets the amount of time (in minutes) until communication with the external device starts after MICRO/I power ON. This can be used to synchronize boot times with the external device.

From the Main Menu screen, press **Initial Setting (Initial Setting)**, **System Operation (System Op.)**, and then **Start Time (Start Time)**.

Enter the time with the keypad.

Press **SAVE (ENT)** to apply the entered value.

Press **CAN (CAN)** to cancel the entered value and display the currently set value.







The setting is not updated if you display another screen before applying the setting.

■ Details (Details)

The following items can be set.

- Whether or not to have a sound made when a touch switch is pressed.
- Select the screen number to be displayed as a binary number or BCD (binary coded decimal).
- To set blink cycle.
- Display the error message in Japanese or English.

From the Main Menu screen, press **Initial Setting (Initial Setting)**, **System Operation (System Op.)**, and then **Details (Details)**.

Select the item to change using the  or . The selected item is highlighted. Each press of the   (CHG) button changes the property of the selected item. Repeat this procedure until the desired properties are displayed. Press **ENT (ENT)** to apply the entered value.



The setting is not updated if you display another screen before applying the setting.

■ Default Screen No. (Default Scr. No.)

This item sets the No. (as a decimal value) of the screen to display after power ON.

From the Main Menu screen, press **Initial Setting (Initial Setting)**, **System Operation (System Op.)**, and then **Default Screen No. (Default Scr. No.)**.

Use the Keypad to enter the value.

Press **SAVE (ENT)** to apply the entered value.

Press **CAN (CAN)** to cancel the entered value and display the currently set value.





- The setting is not updated if you display another screen before applying the setting.
- If the Default Screen No. is set to 0, MICRO/I will display the screen set in the external device instead of the internal initial screen. For details, refer to Chapter 4 "System Area 1" on page 4-30.

■ Password (Password)

Changes the password set for the user account.

If security function is used, you will be able to change the password for the selected user account (either as an administrator or other users registered in the security group) from the touchscreen.

From the Main Menu screen, press **Initial Setting (Initial Setting)**, **System Operation (System Op.)**, and then **Password (Password)**.

Press   (CHG) to change the user account.

Press **Change Password (Change Password)** to display the password input screen.

Use the password input keys to enter a password from 4 to 15 characters.

Pressing **ENTER (ENT)** applies the entered password and closes the password input screen.

Pressing **CLR (CLR)** clears the password input field.



- If you press **CAN (CAN)** on the Password Screen, the setting is not updated and you return to the Password Screen.
- Pressing **ENTER (ENT)** without entering a password disables the password function.



When you do not assign a password to a project data, the Password is blank.

■ Autorun (Autorun)

Enables or disables the USB Autorun function.

When this option is enabled, Autorun function will be executed when a USB flash drive is inserted to MICRO/I.

From the Main Menu screen, press **Initial Setting (Initial Setting)**, **System Operation (System Op.)**, and then **Autorun (Autorun)**.



The setting is not updated if you display another screen before applying the setting.

● Initialize (Initialize)

From the Main Menu screen, press **Initial Setting (Initial Setting)**, and then **Initialize (Initialize)** to display the initialization menu screen.

You can use this screen to set the following items. Press the button for each item to set it.



- To return to the initial settings screen, press **Init Set (Init Set)** at the top of the screen.
- To return to the initialization menu screen from any of the settings screens below, press **Init (Init)** at the top of the screen.

■ Alarm Log (Alarm Log)

Clears all the alarm log data.

From the Main Menu screen, press **Initial Setting (Initial Setting)**, **Initialize (Initialize)**, and then **Alarm Log (Alarm Log)**.

Press **Yes** to clear the Alarm Log data.

■ Data Log (Data Log)

Clears all the data logged from Data Log.

From the Main Menu screen, press **Initial Setting (Initial Setting)**, **Initialize (Initialize)**, and then **Data Log (Data Log)**.

Press **Yes** to clear the Data Log data.

■ Operation Log (Op. Log)

Clears all the operation log data.

From the Main Menu screen, press **Initial Setting (Initial Setting)**, **Initialize (Initialize)**, and then **Operation Log (Op. Log)**.

Press **Yes** to clear the Operation Log data.

■ Touch Panel Adjust (TP Adjust)

HG2J-7U HG5G-V HG4G-V HG4G HG3G-V HG3G HG2G-V HG2G-5F HG2G-5T HG1G HG1P

Adjusts the analog touch panel.

From the Main Menu screen, press **Initial Setting (Initial Setting)**, **Initialize (Initialize)**, and then **Touch Panel Adjust (TP Adjust)**. The position of the analog touch panel is properly adjusted and set.

Press **Yes** and adjust the touch panel according to the instructions on the screen.

HG5G/4G/3G/2G-V, HG4G/3G, HG2G-5F

HG2G-5T, HG1G/1P

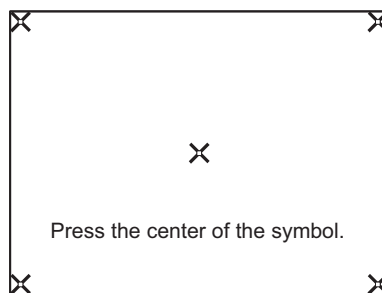
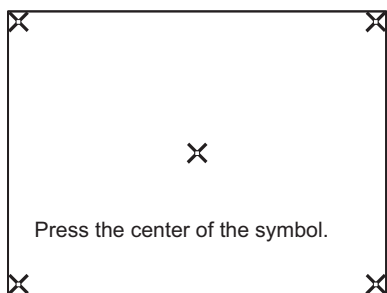

Press the center of each symbol displayed on the screen, in the following order: upper-left corner, upper-right corner, lower-right corner, lower-left corner of the MICRO/I screen.

Press the center of each symbol displayed on the screen, in the following order: lower-left corner, lower-right corner, upper-right corner, upper-left corner of the MICRO/I screen.

● External Device (Ext. Device)

From the Main Menu screen, press **Initial Setting (Initial Setting)**, **External Device (Ext.Device)**, and then **External Device 1 (Ext.Device 1)**, **External Device 2 (Ext.Device 2)**, **External Device 3 (Ext.Device 3)** or **External Device 4 (Ext.Device 4)** to display the menu screen for the external device communication.

To specify settings, press the button to select a choice. External Device Communication setting items vary based on the currently connected hardware. For details about settings, refer to the WindO/I-NV4 External Device Setup Manual. If **Not Use** are selected from the **Communication Driver**, you cannot select this option.



To return to the initial settings screen, press **Init Set** at the top of the screen.

● O/I Link (O/I Link)

From the Main Menu, press **Initial Setting (Initial Setting)**, and then **O/I Link (O/I Link)** to display the O/I link menu screen.

This screen presents information on the O/I Link.

Various settings can be made by pressing **O/I Link Setting1 (O/I Link Set1)** or **O/I Link Setting 2 (O/I Link Set2)**.



- To return to the initial settings screen, press **Init Set (Init Set)** at the top of the screen.
- For details about settings, refer to the WindO/I-NV4 External Device Setup Manual.

● Communication I/F (Comm. I/F)

From the Main Menu screen, press **Initial Setting (Initial Setting)**, and then **Communication I/F (Comm. I/F)** to display the communication interface settings menu screen.

You can use this screen to set the items below. Press the button for each item to set.



- To return to the initial settings screen, press **Init Set (Init Set)** at the top of the screen.
- Press **Comm. I/F (Comm. I/F)** at the top of the screen to return to the communication interface settings menu.

■ Serial 1

HG2J-7U HG5G-V HG4G-V HG4G HG3G-V HG3G HG2G-V HG2G-5F HG2G-5T HG1G HG1P

Allows the setting of communication parameters for the Serial Interface 1.

From the Main Menu screen, press **Initial Setting, Communication I/F**, and then **Serial 1**.

■ Serial 2

HG2J-7U HG5G-V HG4G-V HG4G HG3G-V HG3G HG2G-V HG2G-5F HG2G-5T HG1G HG1P

Allows the setting of communication parameters for the Serial Interface 2. For the HG5G/4G/3G/2G-V, RS232C and RS422/485 can be set individually.

From the Main Menu screen, press **Initial Setting, Communication I/F**, and then **Serial 2**.

■ Serial 3

HG2J-7U HG5G-V HG4G-V HG4G HG3G-V HG3G HG2G-V HG2G-5F HG2G-5T HG1G HG1P

Allows the setting of communication parameters for the Serial Interface 3.

From the Main Menu screen, press **Initial Setting, Communication I/F**, and then **Serial 3**.

■ (RS232C)

HG2J-7U HG5G-V HG4G-V HG4G HG3G-V HG3G HG2G-V HG2G-5F HG2G-5T HG1G HG1P

Allows the setting of communication parameters for the Serial Interface (SERIAL1) (RS232C).

From the Main Menu screen, press **(Initial Setting), (Comm. I/F)**, and then **(RS232C)**.

■ (RS422/485)

HG2J-7U HG5G-V HG4G-V HG4G HG3G-V HG3G HG2G-V HG2G-5F HG2G-5T HG1G HG1P

Allows the setting of communication parameters for the Serial Interface (SERIAL1) (RS422/485).

From the Main Menu screen, press **(Initial Setting), (Comm. I/F)**, and then **(RS422/485)**.

■ Ethernet IP Address (IP Address)

Use the following procedure to set the IP address and Subnet mask settings.

From the Main Menu screen, press **Initial Setting (Initial Setting), Communication I/F (Comm. I/F)**, and then **Ethernet IP Address (IP Address)**.

Press the left/right buttons to select an item, then use the Keypad to enter the IP address and subnet mask values. Press **SAVE (SAVE)** to save the settings.



The setting is not updated if you display another screen before applying the setting.

■ Ethernet Default Gateway (Default Gateway)

Specify the default gateway.

From the Main Menu screen, press **Initial Setting (Initial Setting), Communication I/F (Comm. I/F)**, and then **Ethernet Default Gateway (Default Gateway)**.

Press the left/right buttons to select an item, then use the Keypad to enter the default gateway value.

Press **SAVE (SAVE)** to save the settings.





The setting is not updated if you display another screen before applying the setting.

■ Ethernet Misc Setting (Misc Setting)

Specify whether to allow or prohibit Maintenance Communication via TCP/IP (refer to Chapter 24 "Using the online function for Ethernet communication" on page 24-7).

From the Main Menu screen, press **Initial Setting (Initial Setting)**, **Communication I/F (Comm. I/F)**, and then **Ethernet Misc Setting (Misc Setting)**.

Select the item to set using  or . The selected item is highlighted.

Each press of  or  changes the property of the selected item. Repeat this procedure until the desired properties are displayed.

Press **ENT (ENT)** to apply the entered value.



The setting is not updated if you display another screen before applying the setting.

■ Ext. Device IP Address (Ext. IP Address)

Change the IP addresses of the External Device IDs for external devices.

From the Main Menu screen, press **Initial Setting (Initial Setting)**, **Communication I/F (Comm. I/F)**, and then **Ext. Device IP Address (Ext. IP Address)**.

Procedure

- 1 Press the left/right arrow buttons to select the External Device ID, and then enter a value of the External Device ID with the numeric keys.
- 2 Press the left/right arrow buttons to select the item, and then enter the IP address with the numeric keys.
- 3 Press **SAVE (SAVE)** to save the settings.



The settings are not saved if you display another screen or change the External Device ID before pressing **SAVE (SAVE)**.

3.2 Clock Setting

Press **Clock Setting (Clock Setting)** in the Main Menu screen to display the clock settings screen.

Use this screen to set MICRO/I's internal clock.

To return to the Main Menu screen, press **Main Menu (Main Menu)** at the top of the screen.

Procedure

- 1 Press the left/right buttons to select an item, then use the Keypad to enter the date or time.
- 2 Press **SAVE (SAVE)** to save the date/time setting.



The setting is not updated if you display another screen before applying the setting.

3.3 Offline (Offline)

This mode allows you to change values of device addresses and to check the operation of project data on the MICRO/I.

To return to the Main Menu screen, press **Main Menu (Main Menu)** at the top of the screen.

Press **Offline (Offline)** in the Main Menu screen to run under the offline mode.



Under offline mode, values of the external device addresses may be cleared by zero when the Base Screen changes.



Using the Device Monitor Function in conjunction with the Monitor function is a more efficient means of debugging. For details, refer to Chapter 25 "2.2 Device Monitor" on page 25-21.

3.4 Run

Switches to run mode and executes the project.

3.5 System Information (System Info.)

From the Main Menu screen, press **System Information (System Info.)**, and then press **System (System)** or **System 2 (System 2)** to display the system information screen. This screen displays information such as the MICRO/I type No., stored system software type and version No.

To return to the Main Menu screen, press **Main Menu (Main Menu)** at the top of the screen.



Only the first 15 characters of the project name are displayed.

● System (System)

From the Main Menu screen, press **System Information (System Info.)**, and then press **System (System)**.

Displays the following settings:

- O/I Type
- MAC Address
- OS Version *¹
- Boot Version *²
- System Version

To return to the system information screen, press **System Info. (System Info.)** at the top of the screen.

● System 2

From the Main Menu screen, press **System Information (System Info.)**, and then press **System 2 (System 2)**.

Displays the following settings:

- Project name
- External Device Communication 1 to 4 and Communication Interface
 - External device manufacturer
 - Communication driver name
 - Communication driver version

To return to the system information screen, press **System Info. (System Info.)** at the top of the screen

● Font (Font)

HG2J-7U HG5G-V HG4G-V HG4G HG3G-V HG3G HG2G-V HG2G-5F HG2G-5T HG1G HG1P

From the Main Menu screen, press **System Information (System Info.)**, and then press **Font (Font)**.

Displays the font type stored in MICRO/I.

To return to the system information screen, press **System Info. (System Info.)** at the top of the screen.

*1 HG2J-7U only

*2 HG5G/4G/3G/2G-V, HG4G/3G, HG2G-5F/-5T, HG1G/1P only

3.6 File Manager

HG2J-7U HG5G-V HG4G-V HG4G HG3G-V HG3G HG2G-V HG2G-5F HG2G-5T HG1G HG1P

File Manager manages files stored on SD memory cards, USB flash drives, and MICRO/I internal memory. It can format external memory devices, copy and delete files, and run associated applications. To return to the Main Menu screen, press **Main Menu** at the top of the screen.

- **Format**
Select the drive you want to format, and then press **FORMAT**.
- **Copy**
Select the file you want to copy, and then press **COPY**.
If USB Flash Drive or SD Memory Card is selected as the source and the destination device, the selected file will be copied to the device. If the source or the destination device is MICRO/I, "Project Data Transfer" function will be executed and MICRO/I project will be downloaded or uploaded. If the source or the destination device is PLC, "PLC Program Data Transfer" function will be executed and PLC Program will be downloaded or uploaded. (Refer to Chapter 29 "1 Project Transfer Function" on page 29-1.)
- **Delete**
Select the files you want to delete, and then press **DEL**.



If the external memory device is not recognized correctly, press **RELOAD** to reload it.

3.7 Ext.Mem.Device

HG2J-7U HG5G-V HG4G-V HG4G HG3G-V HG3G HG2G-V HG2G-5F HG2G-5T HG1G HG1P

From the Main Menu screen, press (**Ext.Mem.Device**), and then (**Format**) to format the USB flash drive. To return to the Main Menu screen, press (**Main Menu**) at the top of the screen.

3.8 Top Page

Press **Top Page (Top Page)** in the Main Menu screen to return to the Top Page.

3.9 Self Diagnosis (Self Diag.)





- You need inspection jigs to run self-diagnosis.
- Self Diagnosis is a special screen for factory inspections. Please do not use it during the operation.

Chapter 35 MICRO/I Specifications

1 HG2J-7U

1.1 Packing content

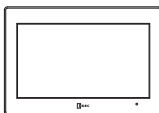
Before installing the HG2J-7U, make sure that the model you have received is what you actually ordered, and no parts are damaged to accidents during shipping.

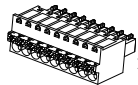
Name	HG2J-7U
HG2J-7U Unit	 ×1
Mounting clips	 ×4
Communication plug for external devices (Attached to the HG2J-7U)	 ×1

1.2 Type No.

LCD size	Bezel color	Type No.
7.0 inch wide TFT Color LCD	Black	HG2J-7UT22TF-B

1.3 Part Names

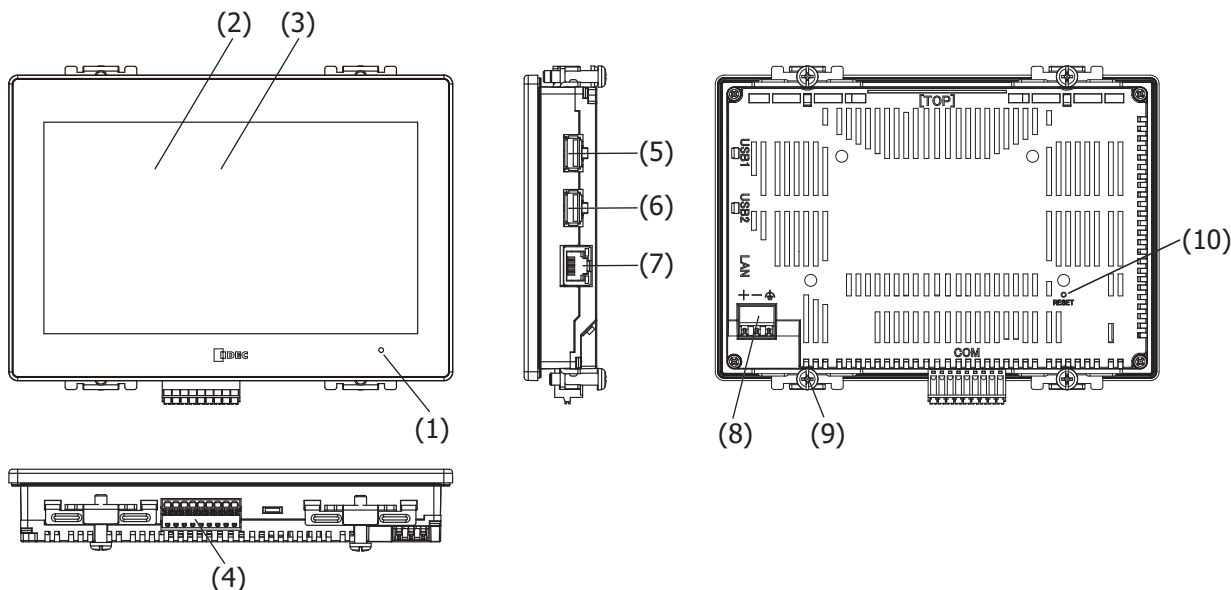

No.	Name	Description
(1)	POWER LED	Green (lit): Normal Operation Green (flash): Operating system is booting. (Normal Operation) Orange (lit): Operating system is booting. (Boot mode) Orange (flash): Preparing to boot the operating system, running in boot mode. Red (lit): Main unit is damaged. Not lit : Power is off.
(2)	Display	
(3)	Touch Panel	
(4)	Serial Interface (COM)	RS232C, RS422/485 Connector : Terminal Block 9-pin (Push-in type) Maximum cable length: 15m (RS232C), 1,200m (RS422/RS485)
(5)	USB Interface (USB1)	USB2.0 (Host) Connector : Type A Output current : 5V 500mA
(6)	USB Interface (USB2)	USB2.0 (Host) Connector : Type A Output current : 5V 500mA
(7)	Ethernet Interface (LAN)	IEEE802.3u 10BASE-T/100BASE-TX Connector : RJ-45 (With Auto MDI/MDI-X function) Maximum cable length: 100m
(8)	Power Supply Terminal	Connector : Terminal Block 3-pin (Push-in type)
(9)	Mounting Clip Position	4 places
(10)	RESET Switch	

1.4 External Interfaces

CAUTION

- Make sure to turn off the power to the HG2J-7U before wiring each interface.
- The serial interface (COM) can be used as the RS232C and RS422/485 interfaces at same time.
- Use the SELV (Safety Extra-Low Voltage) circuit to connect the Serial, USB and Ethernet interfaces.

● Serial Interface

Use applicable cables for wiring and recommended ferrules (made by IDEC, Weidmüller or Phoenix Contact) as follows.

Interface Specification	RS232C, RS422/485		
Connector	Detachable Terminal Block 9-pin		
Applicable cable	AWG16 to AWG28		
Conductor Type	Solid wire or Stranded wire		
Wire Strip Length*1	8 to 9 mm		
Recommended ferrule	ST3L-H025-12WJ S3TL-H034-12WT S3TL-H05-14WA S3TL-H075-14WW (IDEC)	H0,25/12 HBL H0,34/12 TK H0,5/14 OR H0,75/14 W (Weidmüller)	AI 0,25-8YE AI 0,34-8TQ AI 0,5-8WH AI 0,75-8GY (Phoenix Contact)

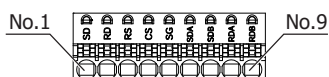

No.	Name	I/O	Function	Communication type	
1	SD	OUT	Send Data	RS232C	/
2	RD	IN	Receive Data		
3	RS	OUT	Request to Send		
4	CS	IN	Clear to Send		
5	SG	—	Signal Ground	RS422/485	/
6	SDA	OUT	Send Data (+)		
7	SDB	OUT	Send Data (-)		
8	RDA	IN	Receive Data (+)		
9	RDB	IN	Receive Data (-)		

Using RS422/485 interface

HG2J-7U is not equipped with terminating resistor. Insert a terminating resistor of an appropriate value (about 100 to 120 Ohm, 1/2 W minimum) between terminal number 8 (RDA) and terminal number 9 (RDB), if necessary.

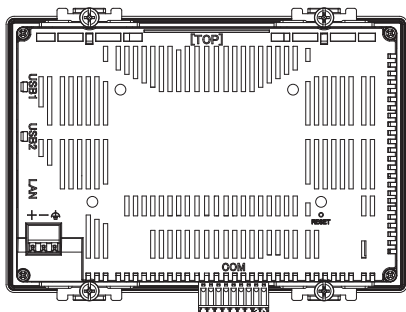

Terminal Number 8 (RDA) Terminal Number 9 (RDB)

*1 Strip the sheath of the wire 8 to 9 mm from the end.

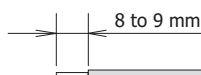

1.5 Specifications

■ Applicable Standards

Safety Standards	UL61010-1, UL61010-2-201, UL121201 CSA C22.2 No.61010-1-12 (c-UL) CSA C22.2 No.61010-2-201 (c-UL) CSA C22.2 No.213 (c-UL)
EMC Standards	IEC/EN 61131-2

■ Environmental Specifications

Operating Temperature	-20 to +60°C*1
Operating Humidity	10 to 90% RH (no condensation)
Storage Temperature	-20 to +70°C
Storage Humidity	10 to 90% RH (no condensation)
Altitude	0 to 2000m
Pollution Degree	2
Corrosion Immunity	Free from corrosive gases

■ Electrical Specifications

Rated Voltage	12V DC / 24V DC
Power Consumption	13W maximum
When not using USB Interface (USB1, USB2)	5W maximum
When backlight is turned off	3W maximum
Power Voltage Range	10.2 to 28.8V DC
Allowable Momentary Power Interruption	10 ms maximum (Power supply: 20.4V DC to 28.8V DC) 1 ms maximum (Power supply: 10.2V DC to 20.4V DC)
Inrush Current	40A maximum
Dielectric Withstand Voltage	AC500V, 10mA, 1 minute (between power and earth terminals)

■ Construction Specifications

Vibration	5 to 8.4Hz amplitude 3.5mm, 8.4 to 150Hz acceleration 9.8m/s ² 10 times on each of three mutually perpendicular axes (IEC61131-2)
Shock	147m/s ² , 11ms (3 shocks on each of three mutually perpendicular axes) (IEC61131-2)

*1 For details about the output current limitation of the USB interface due to the operating ambient temperature, refer to "HG2J-7U Orientation" on page 35-9.

■ Performance Specifications

Display	LCD Type* ²	TFT color LCD (TN Type)
	Display Colors	65536 Colors
	Effective Display Area	154.08 (W) × 85.92 (H) mm
	Display Resolution	800 (W) × 480 (H) dots
	Dot pitch	0.1926 (W) × 0.179 (H) mm
	View angle	Left/Right/Top: 80°, Bottom: 60°
	Brightness of LCD only	Typ. 500 cd/m ²
	Brightness Adjustment	48 levels
	Backlight	LED
	Backlight Life* ³	Approx. 50,000 hours (The time until brightness becomes 50% of the initial value)
Touch Panel	Switch Type	Projected Capacitive
	Multiple Operations	Possible (2-point touch)
User Memory		Approx. 24 MB
Backup of the real-time clock at 25 °C		Typ. 20 days* ⁵
Backup Data		Calendar, Log Data, HMI Keep Relays, HMI Keep Registers
Buzzer output		Single tone (tone length is adjustable)
Degree of Protection* ⁴		When panel thickness is 1 to 5 mm: IP65F (IEC60529) When panel thickness is 1.6 to 5 mm: IP66F, IP67F (IEC60529), TYPE 4X (indoor use only), TYPE 13
Weight (approx.)		500g

■ EMC Specifications

Radiated Emission	Class A : 10m 40dB μ V/m quasi-peak (30M to 230MHz) 47dB μ V/m quasi-peak (230M to 1GHz) Class A : 3m 76dB μ V/m (Peak), 56dB μ V/m (AVG) (1G to 3GHz) 80dB μ V/m (Peak), 60dB μ V/m (AVG) (3G to 6GHz)
Electrostatic Discharge	Contact : \pm 6kV Air : \pm 8kV
Electromagnetic Field	10V/m (80M to 1.0GHz) 3V/m (1.4G to 2.0GHz) 3V/m (2.0G to 2.7GHz) 3V/m (2.7G to 6.0GHz) 80% AM (1kHz)
Fast Transient Burst	Power : \pm 2kV Communication cable : \pm 1kV
Surge Immunity	\pm 500V (between +24V and 0V) \pm 500V (between +24V and FE, 0 and FE)
Conducted Radio Frequency Immunity	3V (Power, Communication cable) (150k to 80MHz) 80% AM (1kHz)

*2 Please be aware that small black and bright dots might show up on LCD Screen: it is not a failure or malfunction.

*3 The life of the LCD itself at an ambient temperature of 25°C. This is not a guaranteed value. The actual life depends on the environment and conditions of use.

*4 It is a protection structure for the operating surface of HMI, which is attached to a panel. Although protection structure suffices every test conditions, it does not guarantee to operate under all of the environmental condition.
As for IP65F/IP66F/IP67F oilproof structure, it suffices oilproof test conditions. Conditions are listed in the document that comes with Japanese Industrial Standard JIS C 0920.
Protection structure do not guarantee usage under long exposure to oil or usage of oil that is not prescribed in the document. Please test/check beforehand to avoid trouble.
IP ratings are not applicable to UL certification.

*5 If the power is interrupted for more than 20 days, the error message "Backup data lost" will be displayed at the next startup, and the clock data will be initialized to 00:00:00 on January 1, 2000.

1.6 Dimensions

Unit: mm

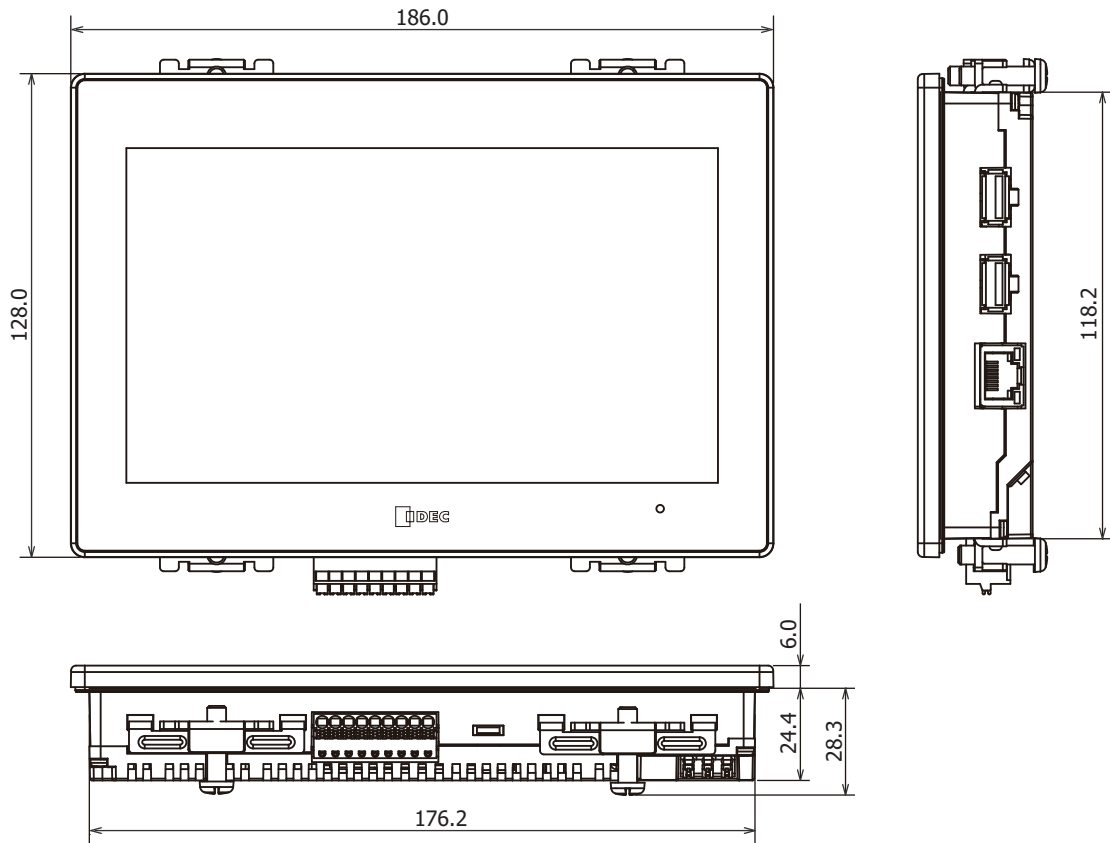

<Cable Attached Dimensions>

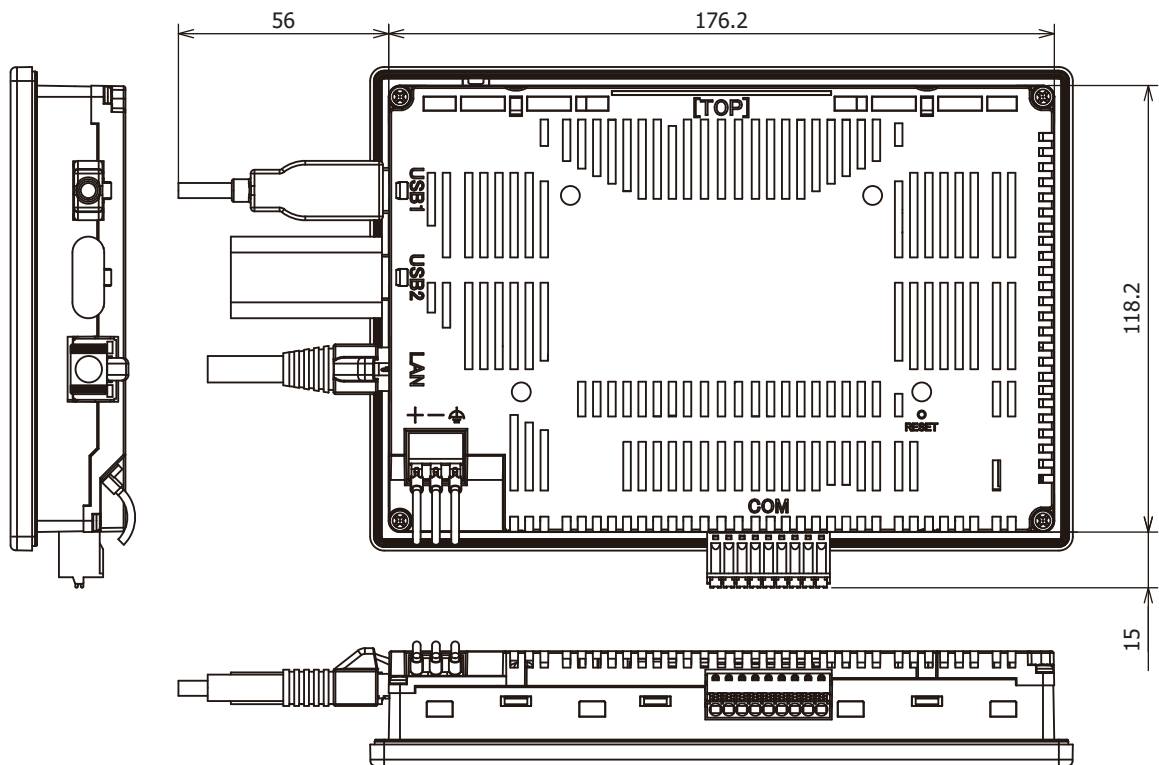

Depending on the type of connection cable used the dimensions shown above will change. The dimensions given here are representative values and are intended for reference only.

● About the printed contents of the main unit

"Mark A" indicates that you can refer to the instruction sheet using the QR code. For details, refer to "1.8 Wiring" on page 35-10.

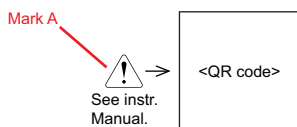

1.7 Installation

● Operating Environment

For designed performance and safety of the HG2J-7U, do not install the HG2J-7U in the following environments:

- Where dust, briny air, or iron powder exist.
- Where oil or chemical splashes for a long time.
- Where space is filled with oil mist.
- Where direct sunlight falls on the HG2J-7U.
- Where strong ultraviolet rays fall on the HG2J-7U.
- Where corrosive or combustible gasses exist.
- Where shocks or vibrations are transmitted.
- Where condensation occurs due to rapid temperature change.
- Where high-voltage or arc-generating equipment (electromagnetic contactors or circuit protectors) exists in close proximity.

● Ambient Temperature

- Allow sufficient space for ventilation, and install the equipment away from heat sources.
- Allow at least 100mm between the HG2J-7U and walls or other equipment.
- Do not install the HG2J-7U where the ambient temperature exceeds the rated operating ambient temperature range. When mounting the HG2J-7U in such locations, provide a forced air-cooling fan or air-conditioner to keep the ambient temperature within the rated temperature range.

● About Derating

HG2J-7U suppresses the temperature rise inside the product by reducing the backlight brightness when the ambient operating temperature becomes high.

The relationship between operating ambient temperature and brightness when the USB interfaces (USB1 and USB2) are not used is as follows.

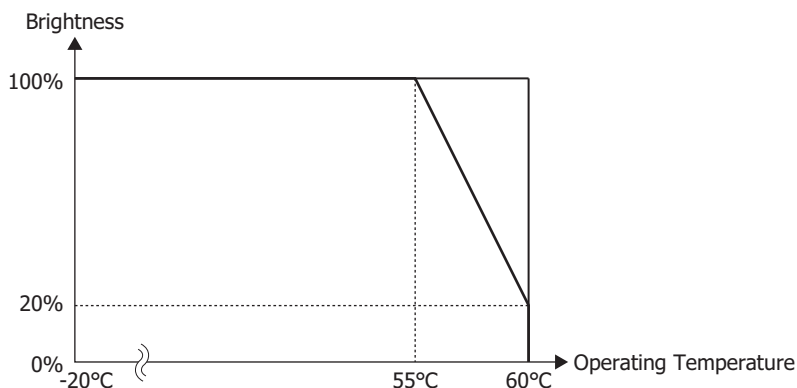

Brightness reduction occurs depending on the output current value of the USB interface.

Depending on each product the values shown above will change. The values given here are representative values are intended for reference only.

● Installation

- Make a panel cut-out on the panel with the dimensions shown below.

Unit: mm

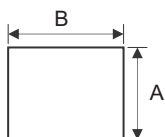

Type No.	A	B	Panel Thickness
HG2J-7U	118.6 $\begin{smallmatrix} +1.0 \\ 0 \end{smallmatrix}$	176.6 $\begin{smallmatrix} +1.0 \\ 0 \end{smallmatrix}$	1.0 to 5.0

- Use the attached mounting clips to tighten the screws evenly to mount panel: screws must be applied on total of four places with the specified torque.

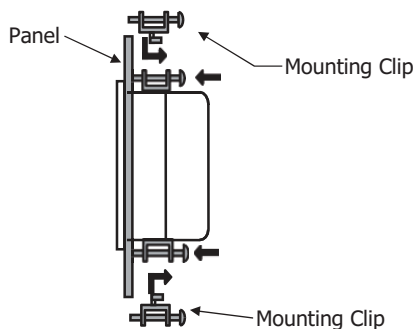

Unit : N·m





Type	Specified Torque
HG2J-7U	0.5 to 0.6

 CAUTION

- Mount the HG2J-7U on a rigid panel.
- Do not tighten with excessive force, otherwise the HG2J-7U may warp the display, or impair the waterproof characteristics.
- If the mounting clips are tightened obliquely to the panel, the HG2J-7U may fall off the panel.
- When installing the HG2J-7U into a panel cut-out, make sure that the gasket is not twisted. Especially when re-installing, take special care because any twists in the gasket will impair the waterproof characteristics.

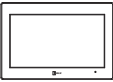
● HG2J-7U Orientation

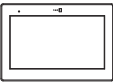
The HG2J-7U is designed to install on a vertical landscape. The operating ambient temperature and the output current of the USB interface (total of USB1 and USB2) are limited as shown in the table below.

Orientation		Operating Temperature: Output current
Vertical	 Landscape	-20 to +45 °C : 1000mA +45 to +55 °C : 500mA +55 to +60 °C : 150mA
	 Portrait (Clockwise)	-20 to +40 °C : 1000mA +40 to +55 °C : 500mA +55 to +60 °C : 150mA
	 Portrait (Counter Clockwise)	-20 to +40 °C : 1000mA +40 to +55 °C : 500mA +55 to +60 °C : 150mA
	 Landscape (Rotate 180°)	-20 to +55 °C : 500mA +55 to +60 °C : 150mA
 Horizontal		-20 to +40 °C : 1000mA +40 to +55 °C : 500mA +55 to +60 °C : 150mA



- When installing the HG2J-7U in a diagonal, the limitations are same as a horizontal.
- Confirm the visibility of the display in a final installation.

1.8 Wiring

⚠ CAUTION

- Turn off the power supply before wiring.
- Make the wiring as short as possible and run all wires as far away as possible from high-voltage and large-current cables. Follow all the procedures and precautions when wiring the HG2J-7U.
- Separate the HG2J-7U power supply wiring from the power lines of I/O devices and motor equipment.
- Ground the functional earth terminal to make sure of correct operation.
- Use the SELV (Safety Extra-Low Voltage) circuit and LIM (Limited Energy) circuit for power supply.
- Use wire copper conductor only.

● Power Supply Terminal

- Pin assignment is shown in the following table.

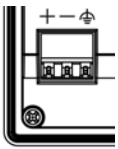

+	Power supply 12V / 24V DC
-	Power supply 0V (0V)
⊕	Functional Earth (FE)

- Use applicable cables for wiring and recommended ferrules (made by IDEC, Weidmüller or Phoenix Contact) as follows.

Applicable cable	AWG14 to AWG28		
Conductor Type	Solid wire or Stranded wire		
Wire Strip Length *1	7 to 9 mm		
Recommended ferrule	ST3L-H025-12WJ S3TL-H034-12WT S3TL-H05-14WA S3TL-H075-14WW (IDEC)	H0,25/12 HBL H0,34/12 TK H0,5/14 OR H0,75/14 W (Weidmüller)	AI 0,25-8YE AI 0,34-8TQ AI 0,5-8WH AI 0,75-8GY (Phoenix Contact)

● Caution when inserting and removing wires

- When connecting a wire that has not been treated with a tip, such as a stranded wire, you can connect it by inserting the wire all the way in while pressing the pusher, and then releasing the pusher.
- When connecting wires with ferrules, connect the ferrules to the terminal block so that the long side is horizontal. (See the figure below.)

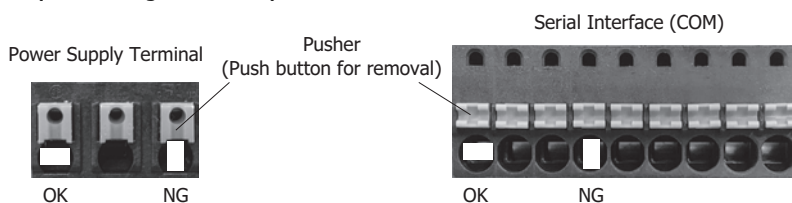

- When pulling out the wire, use a flat blade screwdriver, etc., and pull the wire straight out while pressing the pusher with about 20 N of force.
- Be careful not to damage the push-in terminals.
- When pressing the pusher, do not apply more than 40N of force. Also, do not pull out the wire without pressing the pusher.

*1 Strip the sheath of the wire 7 to 9 mm from the end.

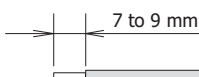

● Cautions for using the HG2J-7U connected to a personal computer

When connecting the HG2J-7U to a personal computer via the USB Interfaces, the HG2J-7U or the personal computer may break down depending on the conditions of the personal computer. Make sure of the following cautions, in order to prevent an accident.

- If the personal computer has a 3-pin power plug or power plug with a ground lead type, make sure to use a plug socket including a ground input electrode or ground the earth lead, respectively.
- If the personal computer has a 2-pin power plug without ground lead, follow the procedure below when connect the HG2J-7U to the personal computer.
 - (1) Pull out the power plug of the personal computer from the AC outlet.
 - (2) Connect the HG2J-7U to the personal computer.
 - (3) Insert the power plug of the personal computer into the AC outlet.

● Recommended Tools

Tool Name		Model Number (Order Number)	Manufacturer
Flat blade screwdriver	Normal type	SDS 0.4×2.5×75 (9009030000)	Weidmüller
	With insulated cover	S3TL-D04-25-75	IDEC
		SDIS 0.4×2.5×75 (9008370000)	Weidmüller
Crimping tool		S3TL-CR06D	IDEC
		PZ6/5 (90011460000)	Weidmüller
Stripping tool		S3TL-ST06	IDEC
		STRIPAX(9005000000)	Weidmüller

1.9 Maintenance and Inspection

Maintain and inspect the HG2J-7U periodically to ensure the best performance. Do not disassemble, repair, or modify the HG2J-7U during inspection.

Maintenance and Inspection Parts	Description
Display	Wipe any stain of the display using a soft cloth slightly dampened with neutral detergent or alcoholic solvent. Do not use solvents such as thinner, ammonia, strong acid, and strong alkaline.
Terminals, Connectors	Check the terminals and connectors to make sure of no loose screws, incomplete insertion, or disconnected lines.
Mounting Clips	Make sure that all mounting clips and screws are tightened sufficiently. If the mounting clips are loose, tighten the screw to the recommended tightening torque.
Backlight	The HG2J-7U's backlight cannot be replaced by the customer. When the backlight needs to be replaced. Contact your vendor or IDEC Corporation.

● Maintenance Screen

Turn on the power to the HG2J-7U, then press and hold the touch panel on the upper-left corner of the screen for three seconds or longer. The Maintenance Screen appears on the screen.

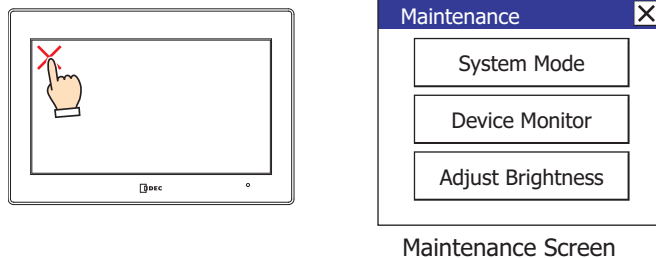

Maintenance Screen

- Permission to show the Maintenance Screen can be set using the configuration software. Refer to Chapter 4 "3.1 System Tab" on page 4-25 for details.
- The Maintenance Screen is not displayed in the System Mode.

● System Mode

Press the [System Mode] at the top of the Maintenance Screen. The Top Page Screen appears.

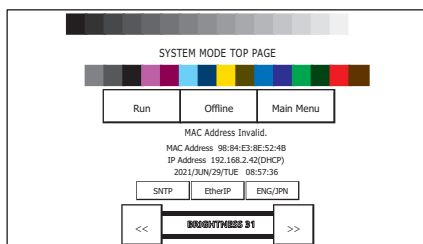

Initial Setting, Self Diagnosis and Initialization of the data, etc can be executed in the System Mode.

● Adjusting the Brightness

The brightness of the HG2J-7U display can be adjusted on the Adjust Brightness Screen.

- 1 Press the [Adjust Brightness] at the bottom of the Maintenance Screen. The Adjust Brightness Screen appears.

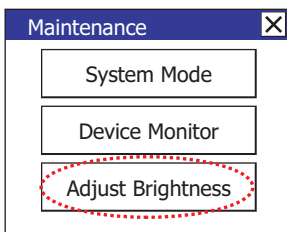

- 2 Press the [<<] and [>>] at the bottom the Adjust Brightness Screen to adjust the contrast to the optimal setting.



- 3 Press the [X] to close the Adjust Brightness Screen.



To adjust the brightness in the System Mode, use the [<<] and [>>] buttons located at the bottom of the Top Page.

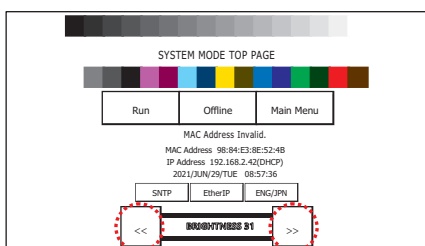













1.10 Software License Information

This product contains various open source software in addition to the software owned by IDEC Corporation. Information about open source software can be obtained from the QR code printed on the back of the HG2J-7U.

2 HG5G/4G/3G/2G-V

2.1 Packing content

Before installing the HG5G/4G/3G/2G-V, make sure that the model you have received is what you actually ordered, and no parts are damaged to accidents during shipping.

Name	HG5G-V	HG4G/3G-V	HG2G-V
HG5G/4G/3G/2G-V Unit	 x 1		 x 1
Instruction Sheet	x 1		x 1
Mounting clips	 x 6	 x 4	 x 4
Communication plug for external devices (Attached to the HG5G/4G/3G/2G-V)	 x 1		 x 1
USB Cable Lock Pin	 x 1		 x 1
USB Clamp Band	 x 1		 x 1
Screw lock bracket Metric Screw Thread M2.6 x 0.45	 x 2		 x 2

2.2 Type No.

LCD size	AUDIO IN/VIDEO IN	Bezel color	Type No.
15.0 inch	With	Black	HG5G-VFXT22MF-B
12.1 inch	With	Black	HG4G-VCXT22MF-B
10.4 inch	With	Light gray	HG3G-VAXT22MF-W
		Black	HG3G-VAXT22MF-B
8.4 inch	With	Light gray	HG3G-V8XT22MF-W
		Black	HG3G-V8XT22MF-B
5.7 inch	Without	Light gray	HG2G-V5FT22TF-W
		Black	HG2G-V5FT22TF-B

2.3 Part Names

■ HG5G-V (15.0inch)

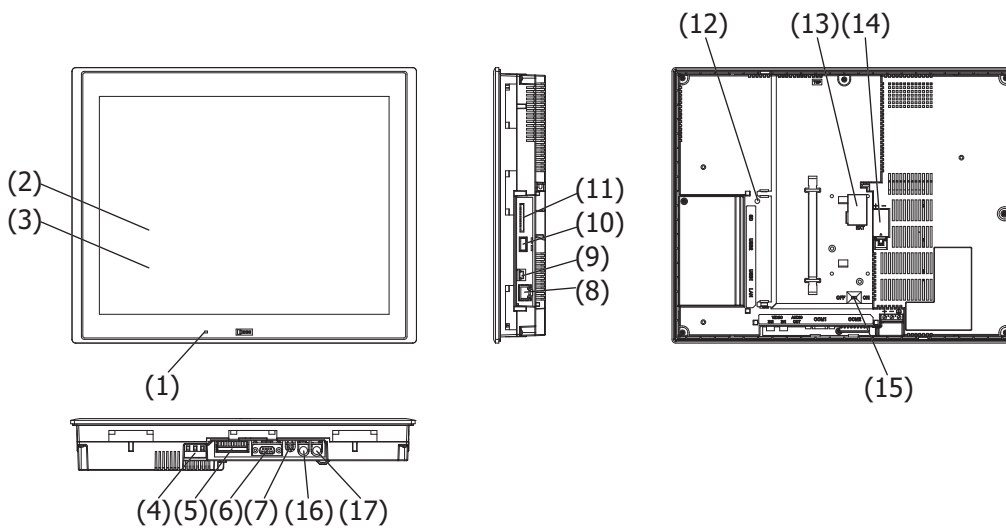

■ HG4G-V (12.1inch)

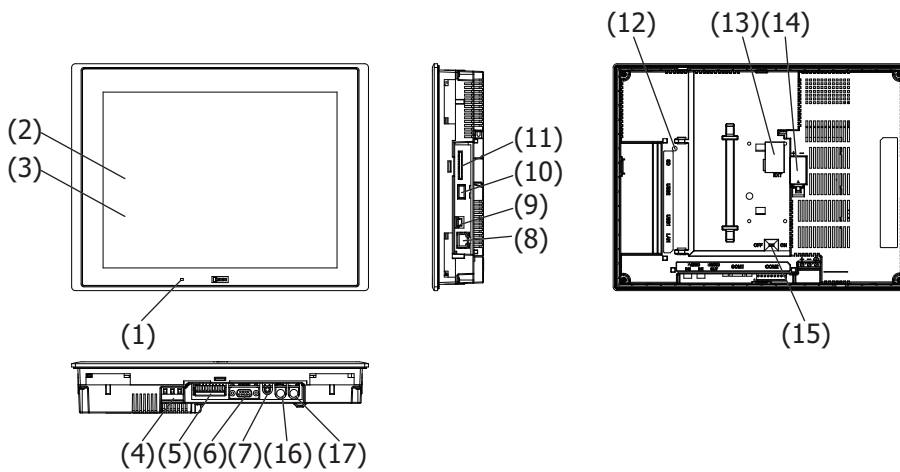

■ HG3G-VA (10.4inch)

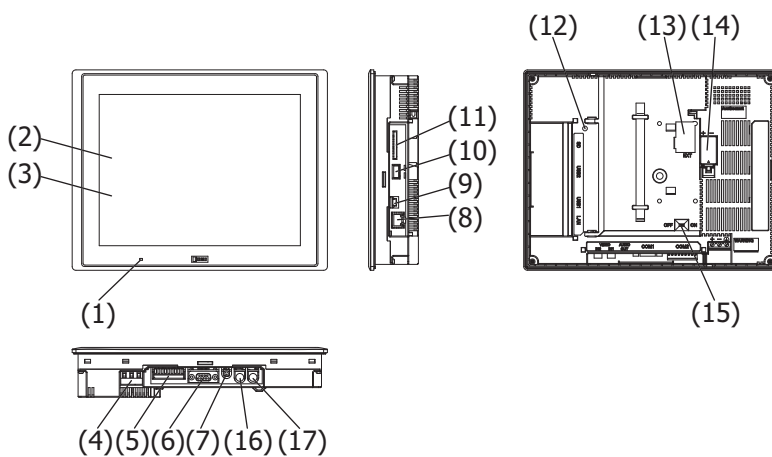

■ HG3G-V8 (8.4inch)

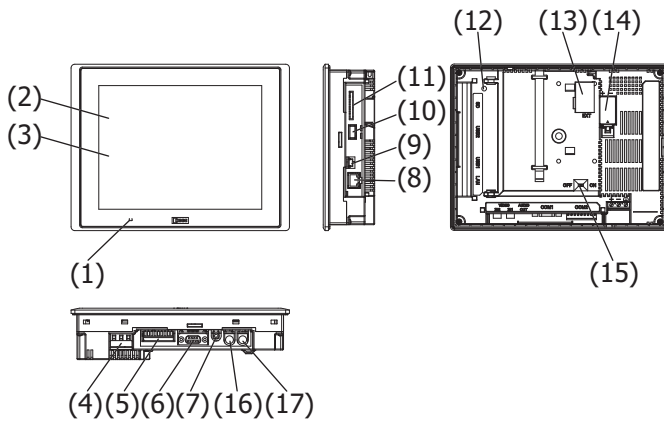

■ HG2G-V (5.7inch)

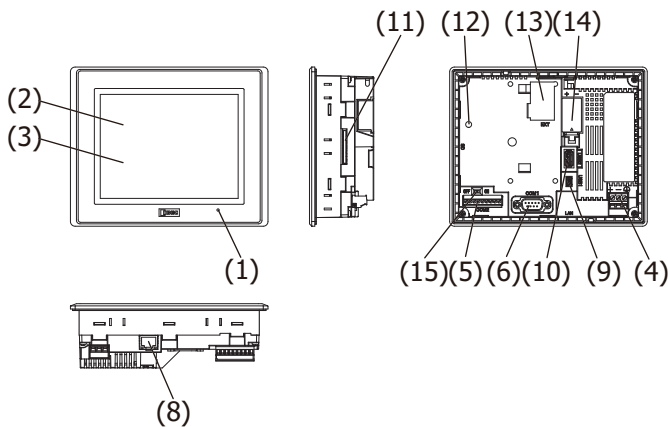

No.	Name	Description
(1)	POWER LED	Green (lit) : Normal Operation (Power is ON.) Not lit : Power is off.
(2)	Display	
(3)	Touch Panel	
(4)	Power Supply Terminal	Connector : Terminal Block 3-pin (Screw fastened type)
(5)	Serial Interface (COM2)	RS232C, RS422/485 Connector : Terminal Block 9-pin (Screw fastened type) Maximum cable length: 15m (RS232C), 1,200m (RS422/RS485)
(6)	Serial Interface (COM1)	RS232C, RS422/485 Connector : D-sub 9-pin Maximum cable length: 15m (RS232C), 1,200m (RS422/RS485)
(7)	Audio Interface (AUDIO OUT)	LINE OUT (Stereo) Recommended minimum load: 10kΩ Connector : Mini Jack (φ3.5mm) (Except for HG2G-V)
(8)	Ethernet Interface (LAN)	IEEE802.3u 10BASE-T/100BASE-TX Connector : RJ-45 (With Auto MDI/MDI-X function) Maximum cable length: 100m
(9)	USB Interface (USB1)	USB2.0 (Device) Connector : Mini-B
(10)	USB Interface (USB2)	USB2.0 (Host) Connector : Type A Output current : 5V 500mA
(11)	Memory Card Interface (SD)	For SD memory card
(12)	SD Memory Card Access Lamp	
(13)	Expansion Module Interface (EXT)	For IDEC MICROSmart Expansion Modules
(14)	Battery Cover	
(15)	Terminating Resistor Selector Switch	For COM2 RS422/485 interface
(16)	Video Interface (VIDEO IN1)	NTSC/PAL Connector : Pin Jack (Except for HG2G-V)
(17)	Video Interface (VIDEO IN2)	NTSC/PAL Connector : Pin Jack (Except for HG2G-V)

2.4 External Interfaces

CAUTION

- Make sure to turn off the power to the HG5G/4G/3G/2G-V before wiring each interface or switching the terminating resistor selector switch.
- The serial interface (COM 1) is used only for the interface of RS232C or RS422 / 485. Wiring both interfaces will result in failure of the HG5G/4G/3G/2G-V. Wire only the interface used.
- Note that the serial interface (COM2) can be used as the RS232C and RS422/485 interfaces at same time.

● Serial Interface (COM1)

Interface Specification	RS232C, RS422/485
Connector	D-sub 9-pin (Plug)
Screw lock bracket	Inch Screw Thread #4-40 UNC

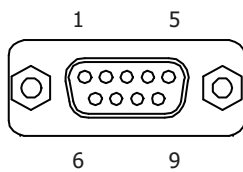

No.	Name	I/O	Function	Communication type
1	RDA	IN	Receive Data (+)	RS422/485
2	RD	IN	Receive Data	RS232C
3	SD	OUT	Send Data	RS232C
4	SDA	OUT	Send Data (+)	RS422/485
5	SG	-	Signal Ground	-
6	RDB	IN	Receive Data (-)	RS422/485
7	RS	OUT	Request to Send	RS232C
8	CS	IN	Clear to Send	RS232C
9	SDB	OUT	Send Data (-)	RS422/485

● Serial Interface (COM2)

Use applicable cables for wiring and recommended ferrules (made by Phoenix Contact or Weidmüller) as follows.

Interface Specification	RS232C, RS422/485	
Connector	Detachable Terminal Block 9-pin	
Applicable cable	AWG20 to AWG22	
Recommended ferrule	AI 0,34-8 TQ AI 0,5-8 WH AI-TWIN 2 x 0,5-8 WH (Phoenix Contact)	H0,34/12 TK H0,5/14 OR H0,5/14 ZH OR (Weidmüller)
Tightening Torque	0.22 to 0.25 N•m	



No.	Name	I/O	Function	Communication type	
1	SD	OUT	Send Data	RS232C	/
2	RD	IN	Receive Data		
3	RS	OUT	Request to Send		
4	CS	IN	Clear to Send		
5	SG	—	Signal Ground	/	RS422/485
6	SDA	OUT	Send Data (+)		
7	SDB	OUT	Send Data (-)		
8	RDA	IN	Receive Data (+)		
9	RDB	IN	Receive Data (-)		



Only one ferrule can be inserted into a terminal hole.

Please set another terminal block in the vicinity of MICRO/I and connect SG when using "RS232C" and "RS422/485" requiring crossover wiring at the same time.

Separate the communication cables so that they do not affect each communication waveform when using RS232C and RS422/485 at the same time.

- Terminating Resistor Selector Switch (for RS422/485 interface)

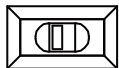

OFF ← → ON

When using RS422/485 interface, set the Terminating Resistor Selector Switch to the ON side. This will connect the internal terminating resistor (120Ω) between RDA and RDB.

● Expansion Module Interface (EXT)

IDEC MICROSmart expansion modules can be connected to the HG5G/4G/3G/2G-V.

Refer to Chapter 30 "1.2 Applicable Expansion Modules" on page 30-2 for the number, the types and the combination of the expansion modules that can be installed.

2.5 Specifications

■ Applicable Standards

Safety Standards	UL61010-1, UL61010-2-201, UL121201 CSA C22.2 No.61010-1-12 (c-UL) CSA C22.2 No.61010-2-201 (c-UL) CSA C22.2 No.213 (c-UL)
EMC Standards	IEC/EN 61131-2
Marine Standards	LR, DNV·GL, ABS, ClassNK

■ Environmental Specifications

Operating Temperature	-20 to +60°C
Operating Humidity	10 to 90% RH (no condensation)
Storage Temperature	-20 to +70°C
Storage Humidity	10 to 90% RH (no condensation)
Altitude	0 to 2000m
Pollution Degree	2
Corrosion Immunity	Free from corrosive gases

■ Electrical Specifications

Type No.	HG5G-V	HG4G-V	HG3G-VA	HG3G-V8	HG2G-V
Rated Voltage	24V DC				
Power Consumption	27W maximum	25W maximum		22W maximum	18W maximum
When not using USB Interface (USB2) and Expansion Module Interface (EXT)	20W maximum	15W maximum		12W maximum	8W maximum
When backlight is turned off	7W maximum				4W maximum
Power Voltage Range	20.4 to 28.8V DC				
Allowable Momentary Power Interruption	10 ms maximum				
Inrush Current	30A maximum				
Dielectric Withstand Voltage	AC1000V, 10mA, 1 minute (between power and earth terminals)				

■ Construction Specifications

Vibration	5 to 8.4Hz amplitude 3.5mm, 8.4 to 150Hz acceleration 9.8m/s^2 10 times on each of three mutually perpendicular axes (IEC61131-2)
Shock	147m/s^2 , 11ms (3 shocks on each of three mutually perpendicular axes) (IEC61131-2)

■ Performance Specifications

Type No.	HG5G-V	HG4G-V	HG3G-VA	HG3G-V8	HG2G-V	
Display	LCD Type*1	TFT color LCD (TN Type)	TFT color LCD (IPS Type)			TFT color LCD (TN Type)
	Display Colors	65536 Colors				
	Effective Display Area	304.1 (W) × 228.1 (H) mm	245.76 (W) × 184.32 (H) mm	210.4 (W) × 157.8 (H) mm	170.496 (W) × 127.872 (H) mm	115.2 (W) × 86.4 (H) mm
	Display Resolution	1024 (W) × 768 (H) dots				640 (W) × 480 (H) dots
	View angle	Left/Right/Bottom: 80°, Top: 60°	Left/Right/Top/Bottom: 85°			Left/Right/Top/Bottom: 80°
	Brightness of LCD only	650 cd/m ²	600 cd/m ²	700 cd/m ²	800 cd/m ²	800 cd/m ²
	Brightness Adjustment	48 levels				
	Backlight	LED				
	Backlight Life*2	Approx. 100,000 hours (The time until brightness becomes 50% of the initial value)				
Touch Panel	Switch Type	Analog Resistive Film				
	Operating Force	3N maximum				
	Multiple Operations	Impossible				
	Life	1,000,000 operations				
User Memory	Approx. 58 MB					
Backup Battery	Coin type lithium manganese dioxide battery CR2032W Guarantee Period: 1 Year (Operating Temperature at 25°C) Recommended Replacement Span: Every 5 Years (Operating Temperature at 25°C)					
Backup Data	Calendar, Log Data, HMI Keep Relays, HMI Keep Registers					
Buzzer output	Single tone (tone length is adjustable)					
Degree of Protection*3	IP66F, IP67F (IEC60529) TYPE 4X TYPE 13					
Weight (approx.)	3.2kg	2.1kg	1.65 kg	1.25 kg	0.65 kg	

■ EMC Specifications

Radiated Emission	Class A : 10m 40dB μ V/m quasi-peak (30M to 230MHz) 47dB μ V/m quasi-peak (230M to 1GHz)
Electrostatic Discharge	Contact : \pm 6kV Air : \pm 8kV
Electromagnetic Field	10V/m (80M to 1.0GHz) 3V/m (1.4G to 2.0GHz) 1V/m (2.0G to 2.7GHz) 80% AM (1kHz)
Fast Transient Burst	Power : \pm 2kV Communication cable : \pm 1kV
Surge Immunity	\pm 500V (between +24V and 0V) \pm 1kV (between +24V and FE, 0 and FE)
Conducted Radio Frequency Immunity	3V (Power, Communication cable) (150k to 80MHz) 80% AM (1kHz)

*1 Please be aware that small black and bright dots might show up on LCD Screen: it is not a failure or malfunction.

*2 The life of the LCD itself at an ambient temperature of 25°C. This is not a guaranteed value. The actual life depends on the environment and conditions of use.

*3 It is a protection structure for the operating surface of HMI, which is attached to a panel. Although protection structure suffices every test conditions, it does not guarantee to operate under all of the environmental condition. As for IP66F/IP67F oilproof structure, it suffices oilproof test conditions. Conditions are listed in the document that comes with Japanese Industrial Standard JIS C 0920. Protection structure do not guarantee usage under long exposure to oil or usage of oil that is not prescribed in the document. Please test/check beforehand to avoid trouble.

2.6 Dimensions

■ HG5G-V (15.0inch)

Unit: mm

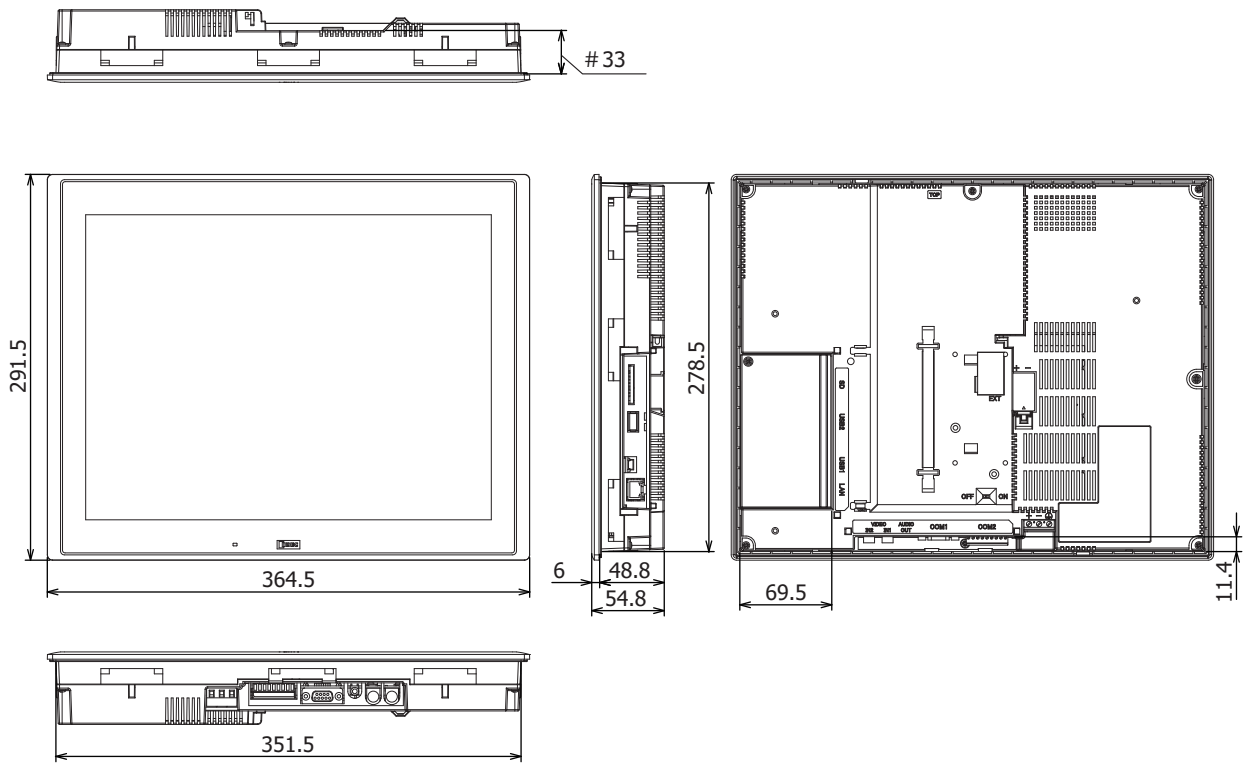

The size to the expansion module installation side

<Cable Attached Dimensions>

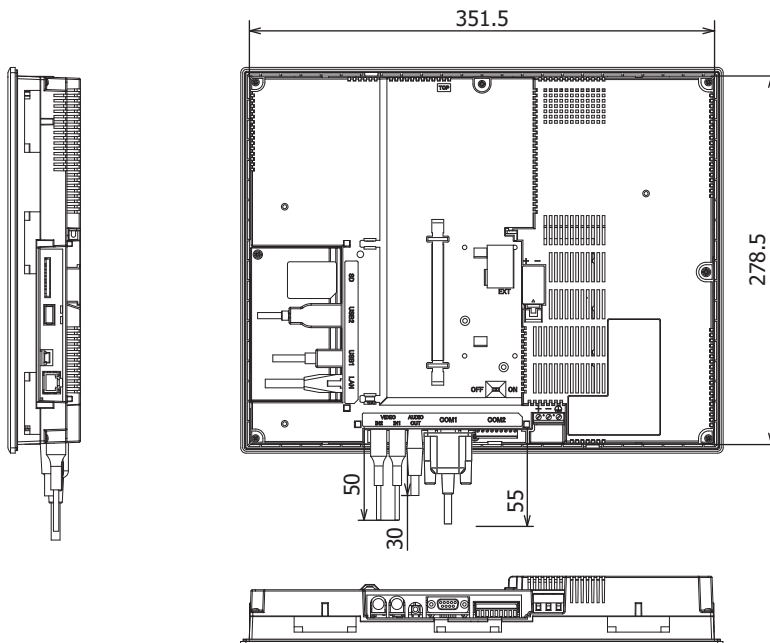

Depending on the type of connection cable used the dimensions shown above will change. The dimensions given here are representative values and are intended for reference only.

■ HG4G-V (12.1inch)

Unit: mm

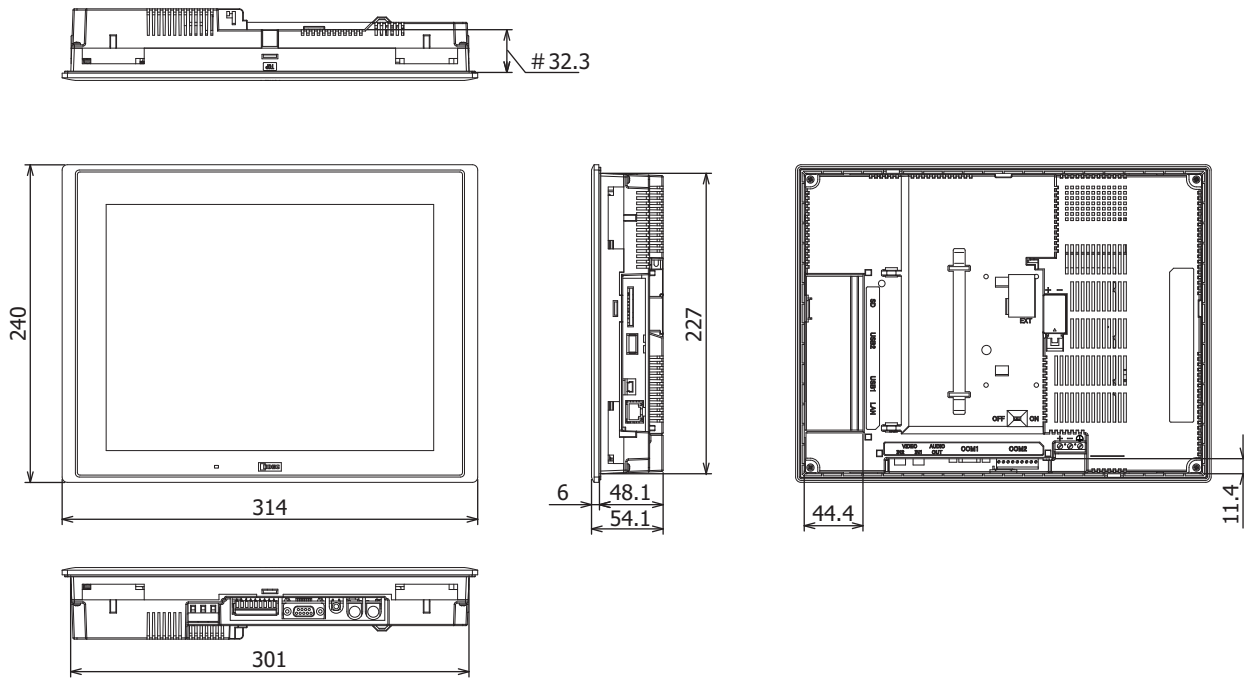

The size to the expansion module installation side

<Cable Attached Dimensions>

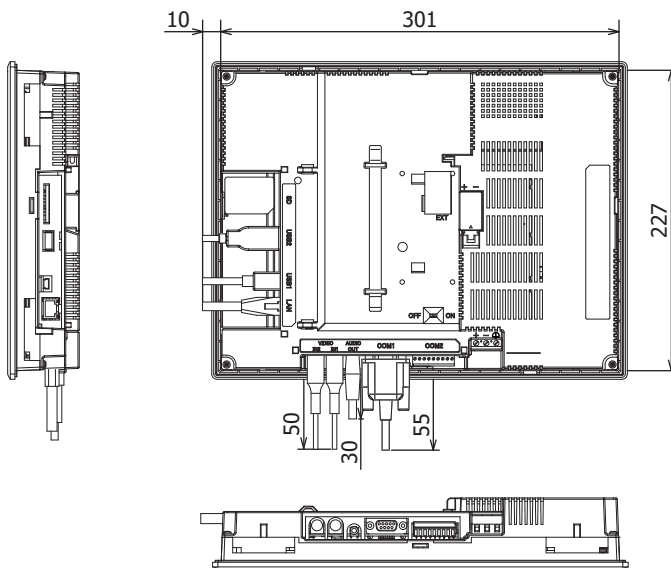

Depending on the type of connection cable used the dimensions shown above will change. The dimensions given here are representative values and are intended for reference only.

■ HG3G-VA (10.4inch)

Unit: mm

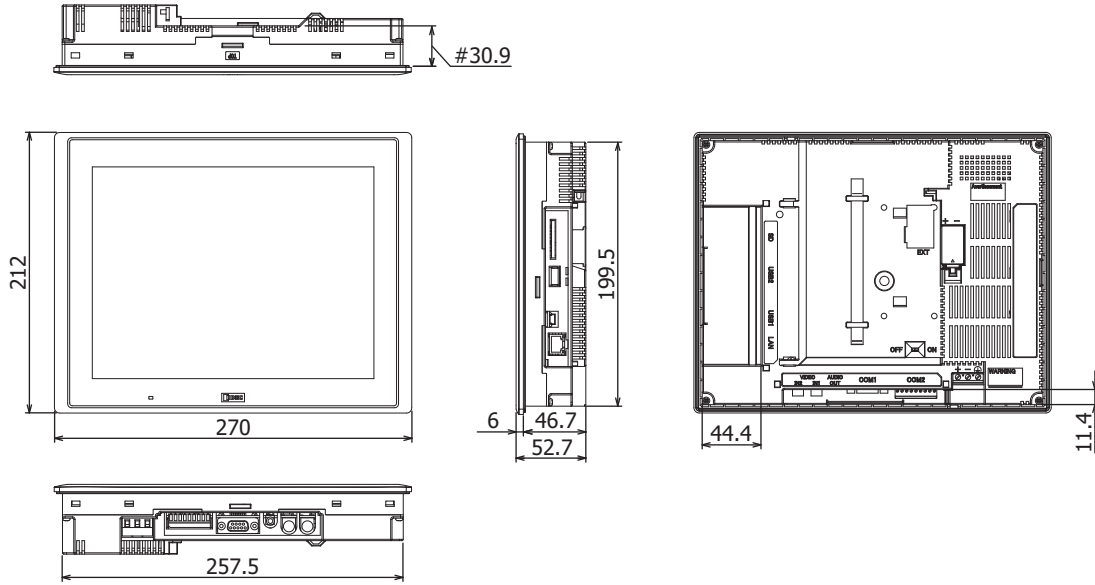

The size to the expansion module installation side

<Cable Attached Dimensions>

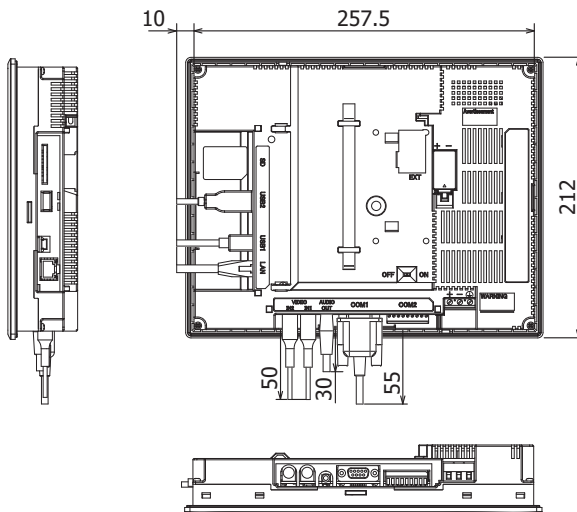

Depending on the type of connection cable used the dimensions shown above will change. The dimensions given here are representative values and are intended for reference only.

■ HG3G-V8 (8.4inch)

Unit: mm

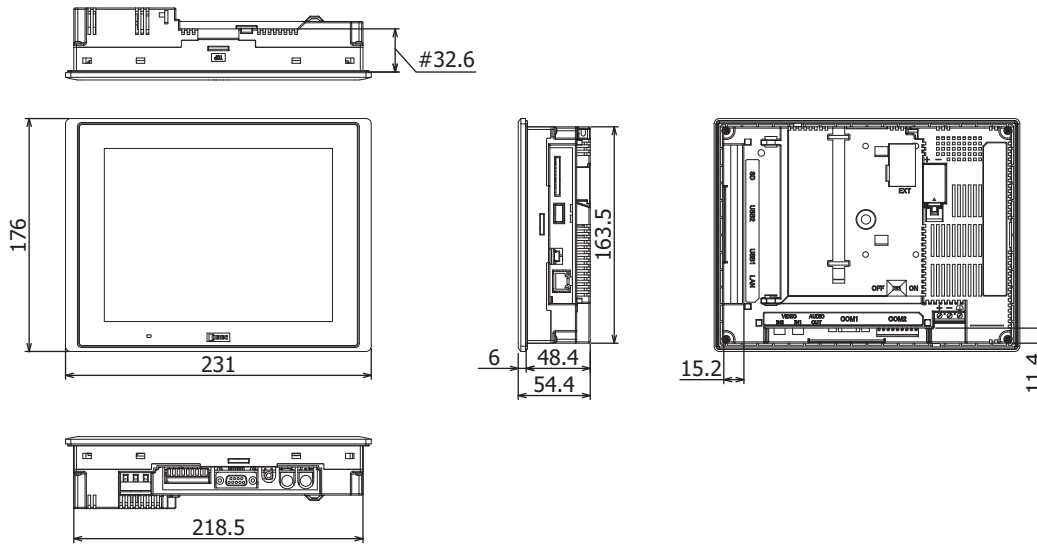

The size to the expansion module installation side

<Cable Attached Dimensions>

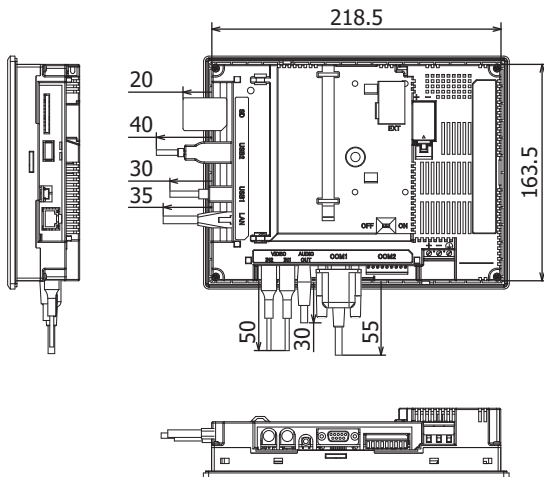

Depending on the type of connection cable used the dimensions shown above will change. The dimensions given here are representative values and are intended for reference only.

■ HG2G-V (5.7inch)

Unit: mm

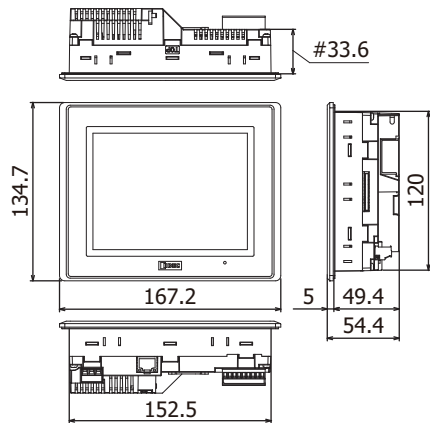

The size to the expansion module installation side

<Cable Attached Dimensions>

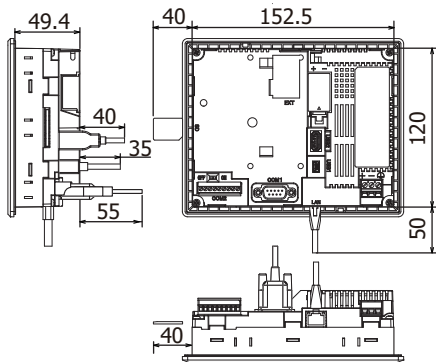

Depending on the type of connection cable used the dimensions shown above will change.
The dimensions given here are representative values and are intended for reference only.

2.7 Installation

● Operating Environment

For designed performance and safety of the HG5G/4G/3G/2G-V, do not install the HG5G/4G/3G/2G-V in the following environments:

- Where dust, briny air, or iron particles exist.
- Where oil or chemical splashes for a long time.
- Where space is filled with oil mist.
- Where direct sunlight falls on the HG5G/4G/3G/2G-V
- Where strong ultraviolet rays fall on the HG5G/4G/3G/2G-V
- Where corrosive or combustible gasses exist.
- Where the HG5G/4G/3G/2G-V is subjected to shocks or vibrations.
- Where condensation occurs due to rapid temperature change.
- Where high-voltage or arc-generating equipment (electromagnetic contactors or circuit protectors) exists in the vicinity.

● Ambient Temperature

- Allow sufficient space for ventilation, and install the equipment away from heat sources.
- Allow at least 100mm between the HG5G/4G/3G/2G-V and walls or other equipment.
- Do not install the HG5G/4G/3G/2G-V where the ambient temperature exceeds the rated operating ambient temperature range. When mounting the HG5G/4G/3G/2G-V in such locations, provide a forced air-cooling fan or air-conditioner to keep the ambient temperature within the rated temperature range.
- The HG5G/4G/3G/2G-V is designed to install on a vertical plane so that natural air-cooling is provided. If you install it using any other orientation, use forced-air cooling, or lower the ambient operating temperature.

● About Derating

HG5G/4G/3G/2G-V suppresses the temperature rise inside the product by reducing the backlight brightness when the ambient operating temperature becomes high.

Relationship between the ambient operating temperature and brightness is as follows.

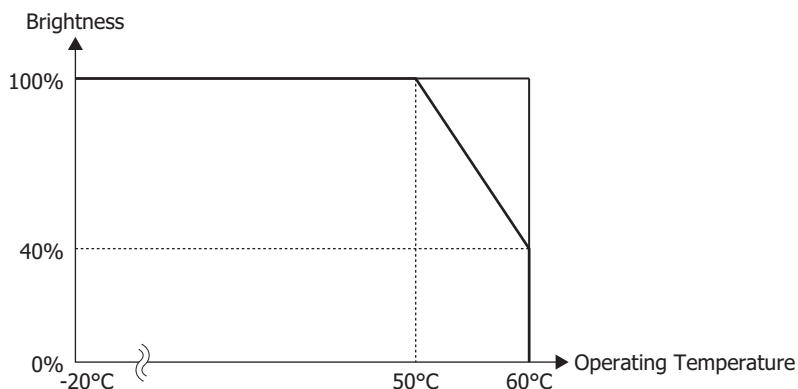

Depending on each product the values shown above will change. The values given here are representative values are intended for reference only.

● HG5G/4G/3G/2G-V Installation

- Make a panel cut-out on the panel with the dimensions shown below.

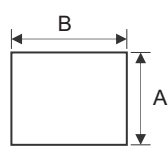

Unit: mm

Type No.	A	B	Panel Thickness
HG5G-V	279.0 $\begin{smallmatrix} +2.0 \\ 0 \end{smallmatrix}$	352.0 $\begin{smallmatrix} +2.0 \\ 0 \end{smallmatrix}$	2.0 to 5.0
HG4G-V	227.5 $\begin{smallmatrix} +2.0 \\ 0 \end{smallmatrix}$	301.5 $\begin{smallmatrix} +2.0 \\ 0 \end{smallmatrix}$	2.0 to 5.0
HG3G-VA	200.0 $\begin{smallmatrix} +2.0 \\ 0 \end{smallmatrix}$	258.0 $\begin{smallmatrix} +2.0 \\ 0 \end{smallmatrix}$	2.0 to 5.0
HG3G-V8	164.0 $\begin{smallmatrix} +2.0 \\ 0 \end{smallmatrix}$	219.0 $\begin{smallmatrix} +2.0 \\ 0 \end{smallmatrix}$	2.0 to 5.0
HG2G-V	121.0 $\begin{smallmatrix} +2.0 \\ 0 \end{smallmatrix}$	153.0 $\begin{smallmatrix} +2.0 \\ 0 \end{smallmatrix}$	1.6 to 5.0

- Install the HG5G/4G/3G/2G-V in a panel cut per the chart above. As it is the following figure, fasten the mounting clips on the top, bottom, and sides of the unit to secure to the panel.

When mounting the HG5G/4G/3G/2G-V was installed in the part besides the following figure, it may not satisfy product specifications such as waterproof performance, shock resistance and vibration resistance performance.

Mounting Clip Position

HG5G-V

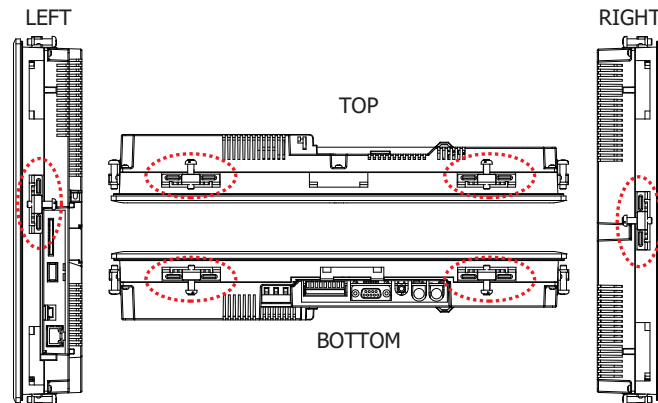

Unit : N·m

Type	Specified Torque
HG5G-V	0.5 to 0.6
HG4G-V	0.5 to 0.6
HG3G-VA	0.5 to 0.6
HG3G-V8	0.5 to 0.6
HG2G-V	0.2 to 0.3

HG4G/3G-V

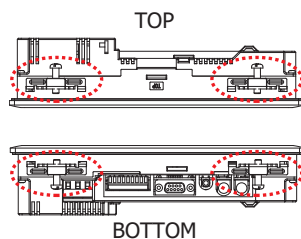

HG2G-V

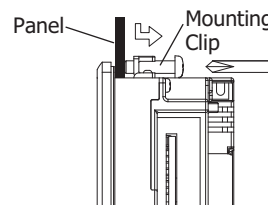
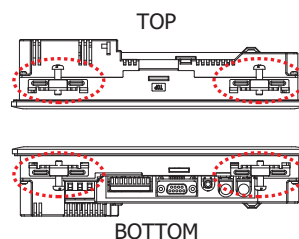





⚠ CAUTION

- Do not tighten with excessive force, otherwise the HG5G/4G/3G/2G-V may warp and cause wrinkle on the display, or impair the waterproof characteristics.
- If the mounting clips are tightened obliquely to the panel, the HG5G/4G/3G/2G-V may fall off the panel.
- When installing the HG5G/4G/3G/2G-V into a panel cut-out, make sure that the gasket is not twisted. Especially when re-installing, take special care because any twists in the gasket will impair the waterproof characteristics.

● HG5G/4G/3G/2G-V Orientation

The HG5G/4G/3G/2G-V is designed to install on a vertical landscape. If you install it using any other orientation, confirm the limitations about operating temperature and the use of MICROSmart expansion modules.

Orientation			Operating Temperature	
			w/o expansion modules	w/ expansion modules
Vertical	 Landscape	HG5G-V	-20 to 60°C	-10 to 50°C
		HG4G-V		
		HG3G-V		
		HG2G-V		
	 Portrait (Clockwise)	HG5G-V	-20 to 60°C	unavailable
		HG4G-V		
		HG3G-V		
		HG2G-V		
	 Portrait (Counter Clockwise)	HG5G-V	-20 to 60°C	unavailable
		HG4G-V		
		HG3G-V		
		HG2G-V		
 Horizontal	HG5G-V	-20 to 60°C	unavailable	
	HG4G-V			
	HG3G-V			
	HG2G-V			



- When installing the HG5G/4G/3G/2G-V in a diagonal, the limitations are same as a horizontal.
- Confirm the visibility of the display in a final installation.

2.8 Wiring

CAUTION

- Turn off the power supply before wiring.
- Make the wiring as short as possible and run all wires as far away as possible from high-voltage and large-current cables. Follow all the procedures and precautions when wiring the HG5G/4G/3G/2G-V.
- Separate the HG5G/4G/3G/2G-V power supply wiring from the power lines of I/O devices and motor equipment.
- Ground the functional earth terminal to make sure of correct operation.

● Power Supply Terminal

- Pin assignment is shown in the following table.

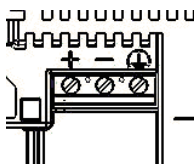

+	Power supply 24V DC (+24V)
-	Power supply 0V (0V)
	Functional Earth (FE)

- Use applicable cables for wiring and recommended ferrules (made by Phoenix Contact or Weidmüller) as follows.

Type No.	HG5G/4G/3G-V		HG2G-V	
Applicable cable	AWG18 to AWG22		AWG14 to AWG22	
Recommended ferrule	AI 0,34-8 TQ AI 0,5-8 WH AI 0,75-8 GY AI 1-8 RD AI-TWIN 2 x 0,5-8 WH AI-TWIN 2 x 0,75-8 GY AI-TWIN 2 x 1-8 RD (Phoenix Contact)	H0,34/12 TK H0,5/14 OR H0,75/14 W H1,0/14 GE H0,5/14 ZH OR H0,75/14 ZH W H1,0/15 ZH GE (Weidmüller)	AI 0,34-12 TQ AI 0,5-12 WH AI 0,75-12 GY AI 1-12 RD AI 1,5-12 BK AI 2,5-12 BU AI-TWIN 2 x 1,5-12 BK (Phoenix Contact)	H0.5/18 OR H0,75/18 W H1,0/18 GE H1,5/18D SW H2,5/19D BL H1,5/20 ZH R (Weidmüller)
Tightening Torque	0.5 to 0.6 N·m		0.5 to 0.6 N·m	

● Grounding Cautions

If you decide to use a single power supply for the HG5G/4G/3G/2G-V with more than one external device, take extra precautions. Some external devices may produce electrical noise and short circuit the entire system setup, therefore, damaging the communication circuit of the HG5G/4G/3G/2G-V and non-isolated Communication Device (i.e. PLC).

To prevent such damage, choose a proper solution depending on your system setup.

- Use a separate earth ground from the external noise source device.
- The wire for grounding should be thick and short in order to direct the noise from the noise source device to the earth ground.
- Use a separate power supply from the external noise source device.
- Insert an isolator on the communication line of the HG5G/4G/3G/2G-V and the non-isolated communication device (i.e. PLC) to prevent damage.

2.9 USB Cable Lock Pin Attachment

When using the USB device, attach the USB Cable Lock Pin to prevent disconnecting the USB cable from the HG5G/4G/3G/2G-V.

- 1 Insert the USB cable into the USB2 port.
- 2 Strain the [Edge part] of the USB Cable Lock Pin, and insert the [Edge part] to the 2 holes upper the USB2 port.

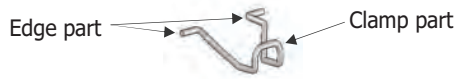

HG5G/4G/3G-V

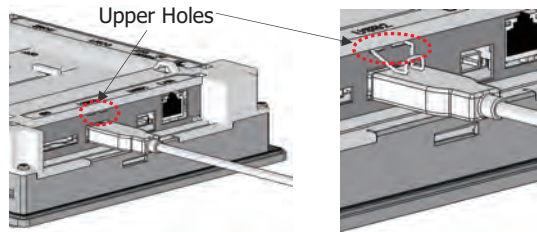

HG2G-V

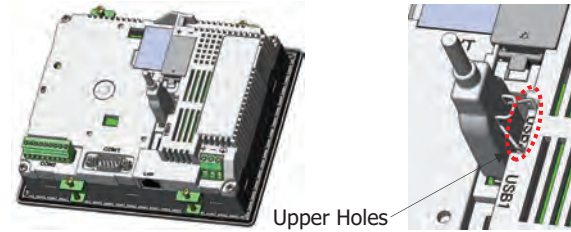

- 3 Fasten the USB Clamp Band around the USB cable and the [Clamp part], secure them tightly.

HG5G/4G/3G-V

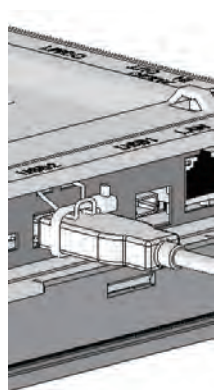

HG2G-V

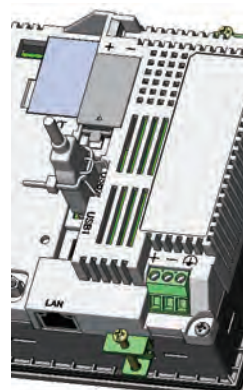

Fasten the USB Clamp Band without the space between the [Clamp part] and it, and the inclination.

OK

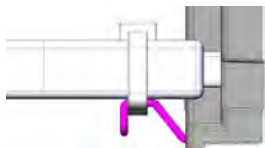

NG

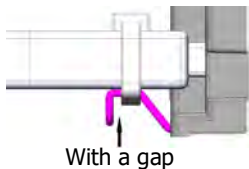

NG

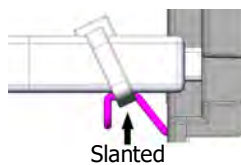

NG

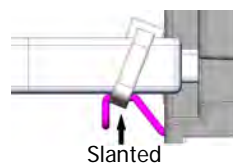

2.10 Maintenance and Inspection

Maintain and inspect the HG5G/4G/3G/2G-V periodically to ensure the best performance. Do not disassemble, repair, or modify the HG5G/4G/3G/2G-V during inspection.

Display	Wipe any stain of the display using a soft cloth slightly dampened with neutral detergent or alcoholic solvent. Do not use solvents such as thinner, ammonia, strong acid, and strong alkaline.
Terminals, Connectors	Check the terminals and connectors to make sure of no loose screws, incomplete insertion, or disconnected lines.
Mounting Clips	Make sure that all mounting clips and screws are tightened sufficiently. If the mounting clips are loose, tighten the screw to the recommended tightening torque.
Backlight	The HG5G/4G/3G/2G-V's backlight cannot be replaced by the customer. When the backlight needs to be replaced. Contact your vendor or IDEC Corporation.
Backup Battery	The operating life of the internal battery is approximately five years. It is recommended to replace the battery every five years even before the reminder message for battery replacement is displayed.
Touch Panel	A gap may be caused in the operation accuracy of the touch panel by the secular distortion, etc. Readjust the touch panel in the System Mode according to the following procedure when there is a gap in the operation of the touch panel. Refer to "Adjusting the Touch Panel" on page 35-34 for details.

● Replacing the Backup Battery

A backup battery is built into the HG5G/4G/3G/2G-V to retain the internal backup data (log data, keep resister, and keep relay) and clock data.

When the "Replace the battery" message is displayed, replace the backup battery by following the procedure below.

When the "Battery level LOW" message is displayed, replace the battery immediately; otherwise, the backup data and clock data may be lost.

Whether or not to display the reminder message for battery replacement can be specified with the configuration software. Refer to Chapter 4 "3.1 System Tab" on page 4-25 for details.

1 Remove the battery holder cover.

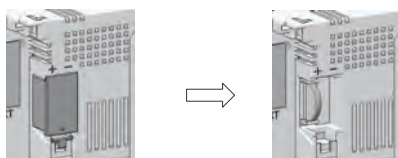

2 Turn on the power to the HG5G/4G/3G/2G-V, wait for approximately one minute, and then turn off the power again.



After turning off the power to the HG5G/4G/3G/2G-V in step 2, complete the steps through 4 within 30 seconds to replace the battery without losing the backup data and clock data. However, it is recommended that the backup data be transferred to flash memory as a precautionary measure. For the procedure to transfer the data to flash memory, refer to Chapter 33 "Internal Devices" on page 33-1. If it is not necessary to save the data, step 2 can be skipped.

3 Remove the battery from the battery holder.

4 Install a replacement battery into the battery holder. Ensure that the orientation of the battery is correct.

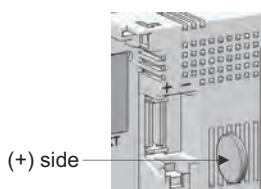

5 With the new batter installed correctly, reverse the instruction the procedure described in item #1 above to secure the cover.

- The operating life of the internal battery is approximately five years. It is recommended to replace the battery every five years even before the reminder message for battery replacement is displayed.
- IDEC provides replacement service for the battery (at customer's expense). Contact your vendor or IDEC Corporation.

 **WARNING**

The battery may be regulated by national or local regulation. Observe the instructions of proper regulation. As electric capacity is left in a discarded battery and it comes into contact with other metals, it could lead to distortion, leakage, overheating, or explosion, so make sure to cover the (+) and (-) terminals with insulating tape before disposal.

 **CAUTION**

When replacing the battery, use the specified battery only. Note that any problems and failures arising from or in connection with the use of a battery other than the specified battery is not guaranteed.

Handling of Batteries and Devices with Built-in Batteries in EU Member States

Note) The following symbol mark is for EU countries only and is according to the directive 2006/66/EC Article 20 information for end-users and Annex II.



This symbol mark means that batteries and accumulators, at their end-of life, should be disposed of separately from your household waste.

If a chemical symbol is printed beneath the symbol shown above, this chemical symbol means that the battery or accumulator contains a heavy metal at a certain concentration. This will be indicated as follows :

Hg : mercury (0.0005%), Cd : cadmium (0.002%), Pb : lead (0.004%)

In the European Union there are separate collection systems for used batteries and accumulators.

Please dispose of batteries and accumulators correctly in accordance with each country or local regulation.

● Maintenance Screen

Turn on the power to the HG5G/4G/3G/2G-V, then press and hold the touch panel on the upper-left corner of the screen for three seconds or longer. The Maintenance Screen appears on the screen.

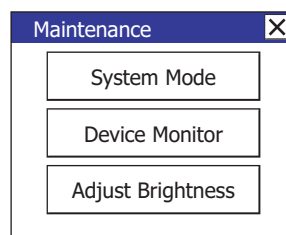
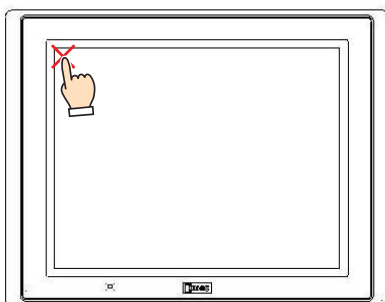

Maintenance Screen

- Permission to show the Maintenance Screen can be set using the configuration software. Refer to Chapter 4 "3.1 System Tab" on page 4-25 for details.
- The Maintenance Screen is not displayed in the System Mode.

● System Mode

Press the [System Mode] at the top of the Maintenance Screen. The Top Page Screen appears.

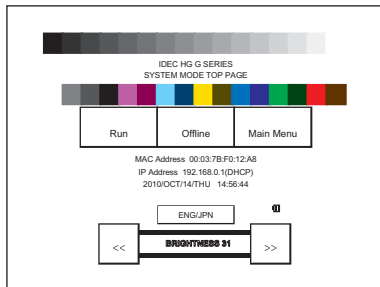

Initial Setting, Self Diagnosis and Initialization of the data, etc can be executed in the System Mode.

● Adjusting the Brightness

The brightness of the HG5G/4G/3G/2G-V display can be adjusted on the Adjust Brightness Screen.

- 1 Press the [Adjust Brightness] at the bottom of the Maintenance Screen. The Adjust Brightness Screen appears.

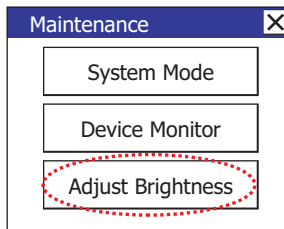

- 2 Press the [<<] and [>>] at the bottom the Adjust Brightness Screen to adjust the contrast to the optimal setting.



- 3 Press the [X] to close the Adjust Brightness Screen.



To adjust the brightness in the System Mode, use the [<<] and [>>] buttons located at the bottom of the Top Page.

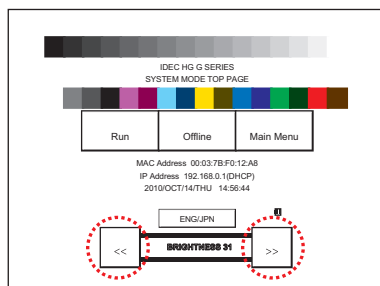

● Adjusting the Touch Panel

A gap may be caused in the operation accuracy of the touch panel by the secular distortion, etc. Adjust the touch panel according to the following procedure when there is a gap in the operation of the touch panel.

- 1 Press the **Main Menu** on the Top Page in System Mode. The Main Menu Screen appears.

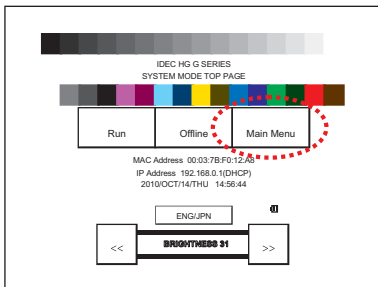

- 2 Press in order of **Initial Setting, Initialize, Touch Panel Adjust**. The confirmation screen appears and asks "Adjust Touch Panel setting?". Press **Yes**, then the Touch Panel Adjust screen appears.
- 3 Press the center of the X mark, then the position of the mark changes one after another. Press five marks sequentially.



Press the center of the X mark.

This will ensure the accuracy of the touch panel operation.









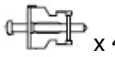

- 4 When normally recognized, the confirmation screen of 2 is restored.

At procedure 3, when pressing a point away from the center of the X mark, a recognition error will result. Then the X mark returns to the initial position, then repeat the procedure of 3 again.

3 HG4G/3G, HG2G-5F

3.1 Packing content

Before installing the HG4G/3G, HG2G-5F, make sure that the specifications of the product conform to your requirements, and that no parts are missing or damaged due to accidents during transportation.

Name	HG4G/3G	HG2G-5F
HG4G/3G, HG2G-5F Unit	 x 1	 x 1
Instruction Sheet	x 1	x 1
Mounting clips	 x 4	 x 4
Communication plug for external devices (Attached to the HG4G/3G, HG2G-5F)	 x 1	 x 1
USB Cable Lock Pin	 x 1	 x 1
USB Clamp Band	 x 1	 x 1
Screw lock bracket Metric Screw Thread M2.6 x 0.45	 x 2	 x 2

3.2 Type No.

LCD size	AUDIO IN/VIDEO IN	Bezel color	Type No.
12.1 inch	Without	Dark gray	HG4G-CJT22TF-B
	With	Dark gray	HG4G-CJT22MF-B
10.4 inch	Without	Light gray	HG3G-AJT22TF-W
		Dark gray	HG3G-AJT22TF-B
	With	Light gray	HG3G-AJT22MF-W
		Dark gray	HG3G-AJT22MF-B
8.4 inch	Without	Light gray	HG3G-8JT22TF-W
		Dark gray	HG3G-8JT22TF-B
	With	Light gray	HG3G-8JT22MF-W
		Dark gray	HG3G-8JT22MF-B
5.7 inch	Without	Light gray	HG2G-5FT22TF-W
		Dark gray	HG2G-5FT22TF-B
		Silver	HG2G-5FT22TF-S

3.3 Part Names

■ HG4G (12.1inch)

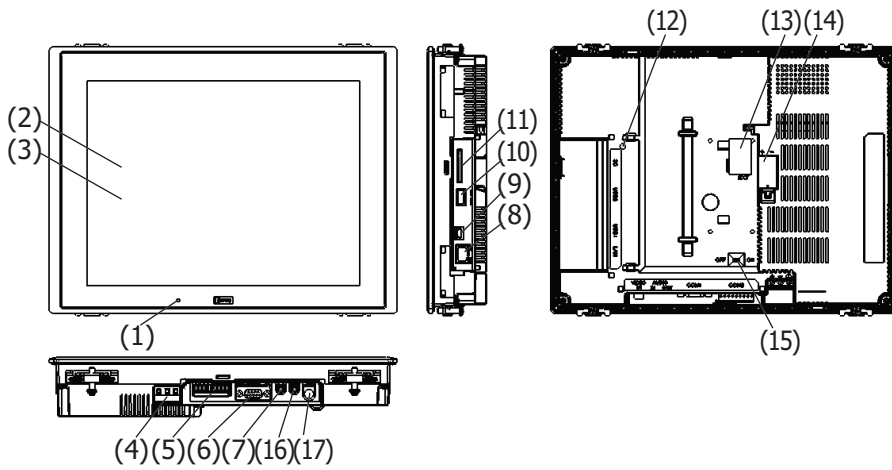

■ HG3G-A (10.4inch)

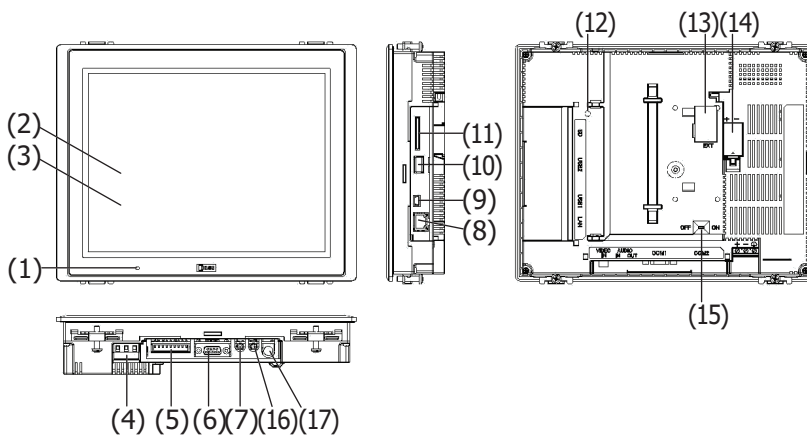

■ HG3G-8 (8.4inch)

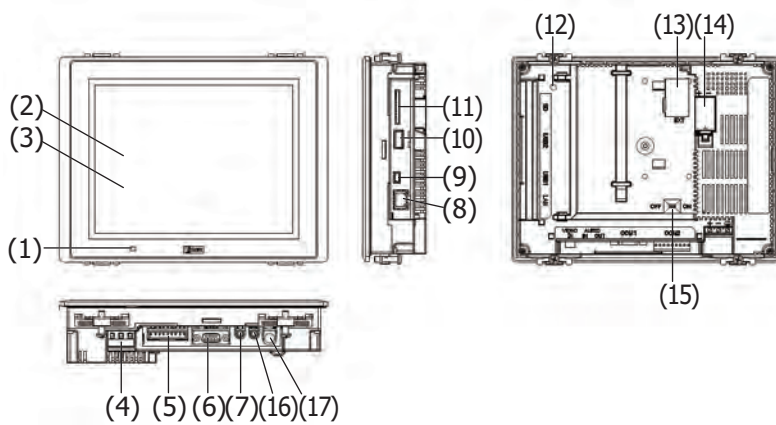

■ HG2G-5F (5.7inch)

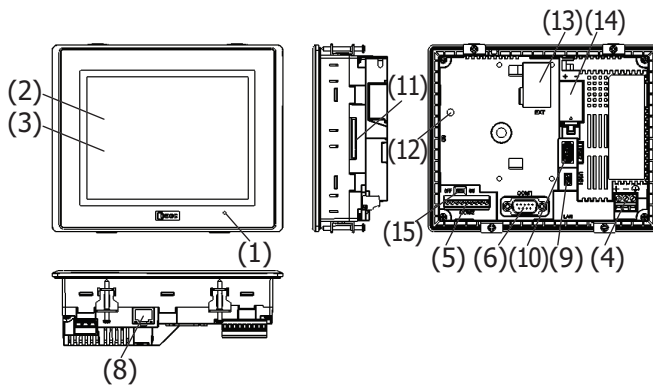

No.	Name	Description
(1)	POWER LED	Green (lit) : Normal Operation (Power is ON.) Not lit : Power is off.
(2)	Display	
(3)	Touch Panel	
(4)	Power Supply Terminal	Connector : Terminal Block 3-pin (Screw fastened type)
(5)	Serial Interface (COM2)	RS232C, RS422/485 Connector : Terminal Block 9-pin (Screw fastened type) Maximum cable length: 15m (RS232C), 1,200m (RS422/RS485)
(6)	Serial Interface (COM1)	RS232C, RS422/485 Connector : D-sub 9-pin Maximum cable length: 15m (RS232C), 1,200m (RS422/RS485)
(7)	Audio Interface (AUDIO OUT)*1	LINE OUT (Stereo) Recommended minimum load: 10kΩ Connector : Mini Jack (φ3.5mm)
(8)	Ethernet Interface (LAN)	IEEE802.3u 10BASE-T/100BASE-TX Connector : RJ-45 (With Auto MDI/MDI-X function) Maximum cable length: 100m
(9)	USB Interface (USB1)	USB2.0 (Device) Connector : Mini-B
(10)	USB Interface (USB2)	USB2.0 (Host) Connector : Type A Output current : 5V 500mA
(11)	Memory Card Interface (SD)	For SD memory card
(12)	SD Memory Card Access Lamp	
(13)	Expansion Module Interface (EXT)	For IDEC MICROSmart Expansion Modules
(14)	Battery Cover	
(15)	Terminating Resistor Selector Switch	For COM2 RS422/485 interface
(16)	Audio Interface (AUDIO IN)*1	LINE IN (Stereo) Connector : Mini Jack (φ3.5mm)
(17)	Video Interface (VIDEO IN)*1	NTSC/PAL Connector : Pin Jack

*1 This is applicable for HG4G/3G with a video interface only.

3.4 External Interfaces

! CAUTION

- **Make sure to turn off the power to the HG4G/3G, HG2G-5F before wiring each interface or switching the terminating resistor selector switch.**
- **Note that only one of the RS232C or RS422/485 interfaces can be used at same time. Wiring both interfaces will result in failure of the HG4G/3G, HG2G-5F. Wire only the interface used.**

● Serial Interface (COM1)

Interface Specification	RS232C, RS422/485
Connector	D-sub 9-pin (Plug)
Screw lock bracket	Inch Screw Thread #4-40 UNC

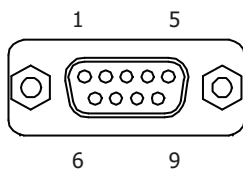

No.	Name	I/O	Function	Communication type
1	4W-RDA/2W-A	IN/INOUT	Receive Data (+) [4W]/ Send and Receive Data (+) [2W]	RS422/485
2	RD	IN	Receive Data	RS232C
3	SD	OUT	Send Data	RS232C
4	4W-SDA	OUT	Send Data (+) [4W]	RS422/485
5	SG	-	Signal Ground	-
6	4W-RDB/2W-B	IN/INOUT	Receive Data (-) [4W]/ Send and Receive Data (-) [2W]	RS422/485
7	RS	OUT	Request to Send	RS232C
8	CS	IN	Clear to Send	RS232C
9	4W-SDB	OUT	Send Data (-) [4W]	RS422/485

● Serial Interface (COM2)

Use applicable cables for wiring and recommended ferrules (made by Phoenix Contact or Weidmüller) as follows.

Interface Specification	RS232C, RS422/485	
Connector	Detachable Terminal Block 9-pin	
Applicable cable	AWG20 to AWG22	
Recommended ferrule	AI 0,34-8 TQ AI 0,5-8 WH AI-TWIN 2 x 0,5-8 WH (Phoenix Contact)	H0,34/12 TK H0,5/14 OR H0,5/14 ZH OR (Weidmüller)
Tightening Torque	0.22 to 0.25 N•m	



No.	Name	I/O	Function	Communication type	
1	SD	OUT	Send Data	RS232C	/
2	RD	IN	Receive Data		
3	RS	OUT	Request to Send		
4	CS	IN	Clear to Send		
5	SG	—	Signal Ground	/	RS422/485
6	4W-SDA	OUT	Send Data (+) [4W]		
7	4W-SDB	OUT	Send Data (-) [4W]		
8	4W-RDA/2W-A	IN/INOUT	Receive Data (+) [4W]/ Send and Receive Data (+) [2W]		
9	4W-RDB/2W-B	IN/INOUT	Receive Data (-) [4W]/ Send and Receive Data (-) [2W]		

- Terminating Resistor Selector Switch (for RS422/485 interface)

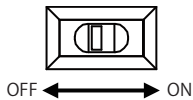

When using RS422/485 interface, set the Terminating Resistor Selector Switch to the ON side. This will connect the internal terminating resistor (120Ω) between RDA and RDB.

● Expansion Module Interface (EXT)

IDEC MICROsmart expansion modules can be connected to the HG4G/3G, HG2G-5F.

Refer to Chapter 30 "1.2 Applicable Expansion Modules" on page 30-2 for the number, the types and the combination of the expansion modules that can be installed.

3.5 Specifications

■ Applicable Standards

Safety Standard	UL508, ANSI/ISA-12.12.01 CSA C22.2 No.142 (c-UL) CSA C22.2 No.213 (c-UL)
EMC Standard*1	IEC/EN 61131-2
Ship Classification Standard *1	ABS, DNV, LR, NK

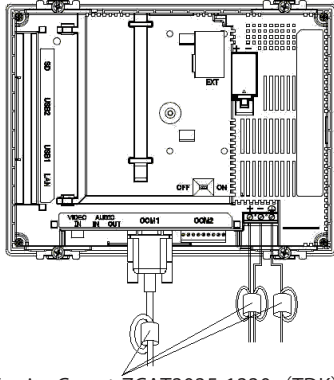

Ferrite Core : ZCAT3035-1330 (TDK)

■ Environmental Specifications

Operating Temperature	0 to +50°C
Operating Humidity	10 to 90% RH (no condensation)
Storage Temperature	-20 to +60°C
Storage Humidity	10 to 90% RH (no condensation)
Altitude	0 to 2000m
Pollution Degree	2
Corrosion Immunity	Free from corrosive gases

■ Electrical Specifications

Type No.	HG4G	HG3G-A	HG3G-8	HG2G-5F
Rated Voltage	24V DC			
Power Consumption	27W maximum	25W maximum	19W maximum	
When not using USB Interface (USB2) and Expansion Module Interface (EXT)	18W maximum	15W maximum	10W maximum	
Power Voltage Range	20.4 to 28.8V DC			
Allowable Momentary Power Interruption	10 ms maximum			
Inrush Current	30A maximum			
Dielectric Withstand Voltage	AC1000V, 10mA, 1 minute (between power and earth terminals)			

■ Construction Specifications

Vibration	5 to 8.4Hz amplitude 3.5mm, 8.4 to 150Hz acceleration 9.8m/s ² 10 times on each of three mutually perpendicular axes (IEC61131-2)
Shock	147m/s ² , 11ms (3 shocks on each of three mutually perpendicular axes) (IEC61131-2)

*1 When using the HG4G/3G, HG2G-5F as the EMC Standard Approved Products, or when using the HG4G/3G, HG2G-5F as the Ship Classification Standard Approved Products, attach a ferrite core (ZCAT3035-1330 manufactured by TDK Corporation) to the power cables and the communication cables.

■ Performance Specifications

Type No.	HG4G	HG3G-A	HG3G-8	HG2G-5F	
Display	LCD Type*2	TFT color LCD (TN Type)			
	Display Colors	65536 Colors			
	Effective Display Area	246.0 (W) × 184.5 (H) mm	211.2 (W) × 158.4 (H) mm	170.4 (W) × 127.8 (H) mm	115.2 (W) × 86.4 (H) mm
	Display Resolution	800 (W) × 600 (H) dots			640 (W) × 480 (H) dots
	View angle	Left/Right: 80°, Top: 80°, Bottom: 60°			Left/Right/Top/Bottom: 80°
	Brightness of LCD only	550 cd/m ²	700 cd/m ²	600 cd/m ²	800 cd/m ²
	Brightness Adjustment	48 levels			
	Backlight	LED			
	Backlight Life*3	Approx. 100,000 hours (The time until brightness becomes 50% of the initial value)			Approx. 50,000 hours (The time until brightness becomes 50% of the initial value)
Touch Panel	Switch Type	Analog Resistive Film			
	Operating Force	3N maximum	0.55 to 2.3 N		3N maximum
	Multiple Operations	Impossible			
	Life	1,000,000 operations			
User Memory	Approx. 12 MB				
Backup Battery	Coin type lithium manganese dioxide battery CR2032 Guarantee Period: 1 Year (Operating Temperature at 25°C) Recommended Replacement Span: Every 5 Years (Operating Temperature at 25°C)				
Backup Data	Calendar, Log Data, HMI Keep Relays, HMI Keep Registers				
Buzzer output	Single tone (tone length is adjustable)				
Degree of Protection*4	IP66 (IEC60529) TYPE 4X TYPE 13				
Weight (approx.)	2.1kg	1.65 kg	1.25 kg	0.65 kg	

■ EMC Specifications

Radiated Emission	Class A : 10m 40dB μ V/m quasi-peak (30M to 230MHz) 47dB μ V/m quasi-peak (230M to 1GHz)
Electrostatic Discharge	Contact : \pm 6kV Air : \pm 8kV
Electromagnetic Field	10V/m (80M to 1.0GHz) 3V/m (1.4G to 2.0GHz) 1V/m (2.0G to 2.7GHz) 80% AM (1kHz)
Fast Transient Burst	Power : \pm 2kV Communication cable : \pm 1kV
Surge Immunity	\pm 500V (between +24V and 0V) \pm 1kV (between +24V and FE, 0 and FE)
Conducted Radio Frequency Immunity	3V (Power, Communication cable) (150k to 80MHz) 80% AM (1kHz)

*2 Please be aware that small black and bright dots might show up on LCD Screen: it is not a failure or malfunction.

*3 The life of the LCD itself at an ambient temperature of 25°C. This is not a guaranteed value. The actual life depends on the environment and conditions of use.

*4 The degree of protection for the operating section after the panel is attached. The compliance test has been passed, but this is not a guarantee of operation in all environments. Not a guarantee in all usage environments with oil materials.

3.6 Dimensions

■ HG4G (12.1inch)

Unit: mm

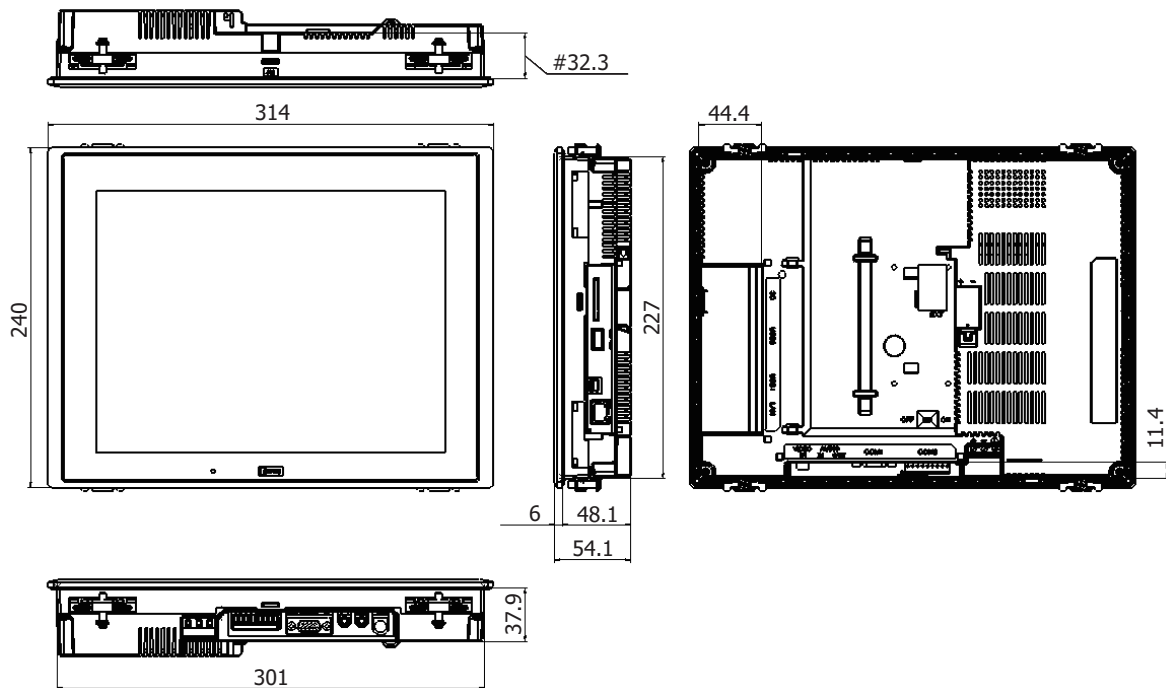

The size to the expansion module installation side

<Cable Attached Dimensions>

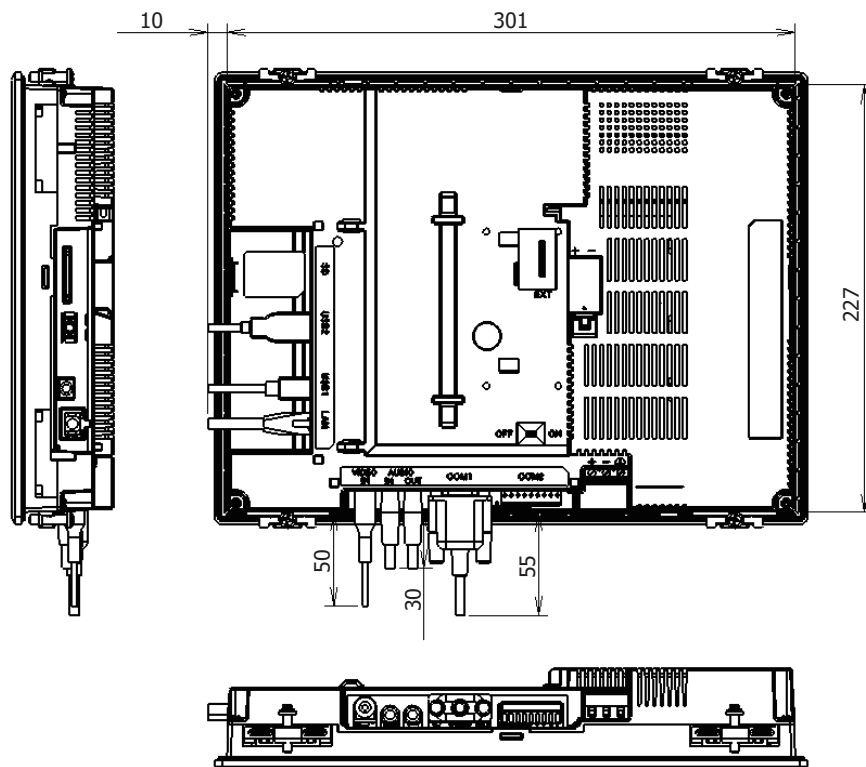

Depending on the type of connection cable used the dimensions shown above will change. The dimensions given here are representative values and are intended for reference only.

■ HG3G-A (10.4inch)

Unit: mm

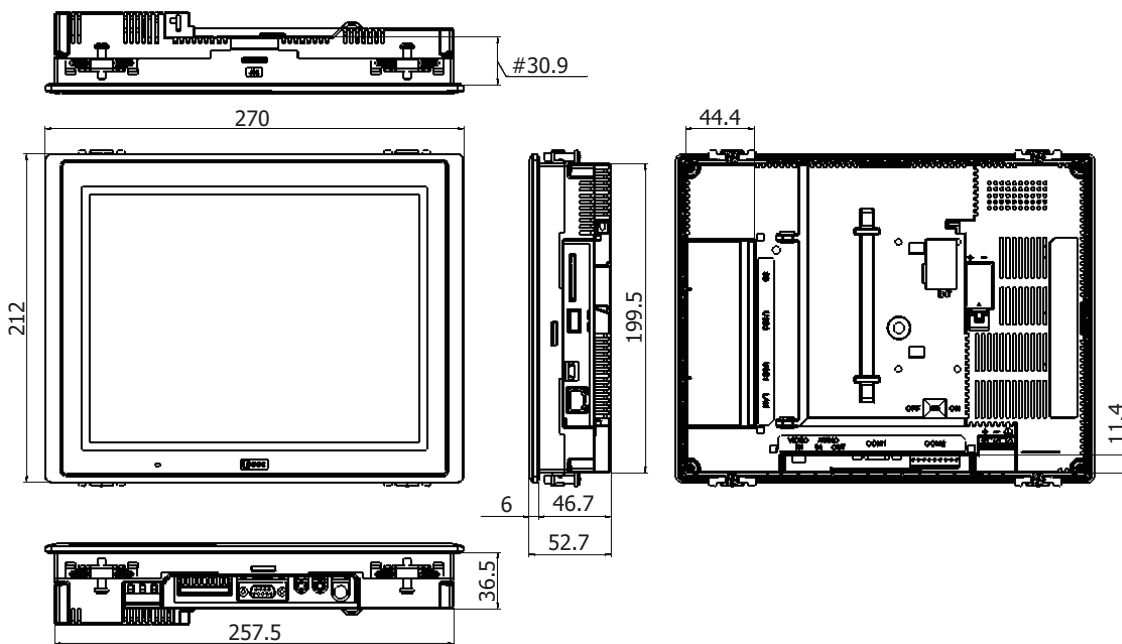

The size to the expansion module installation side

<Cable Attached Dimensions>

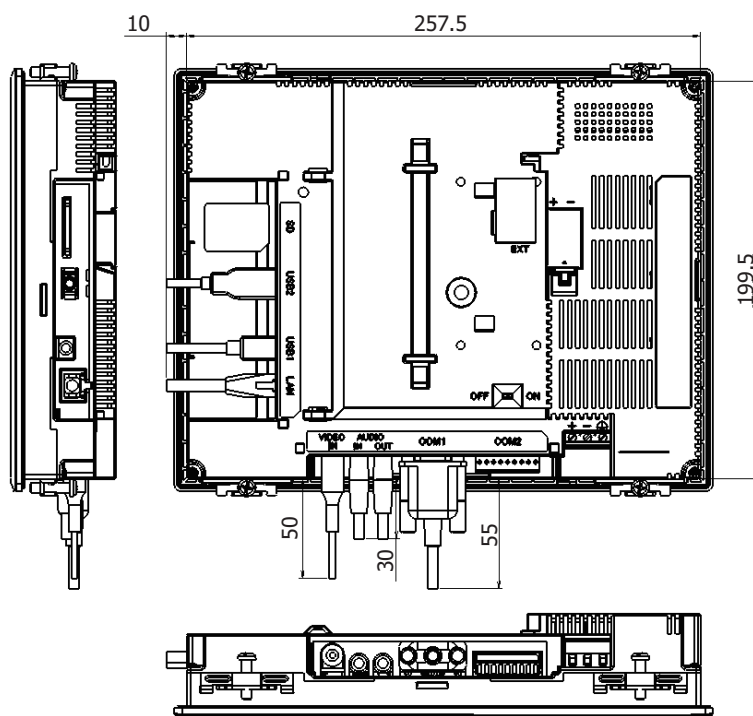

Depending on the type of connection cable used the dimensions shown above will change. The dimensions given here are representative values and are intended for reference only.

■ HG3G-8 (8.4inch)

Unit: mm

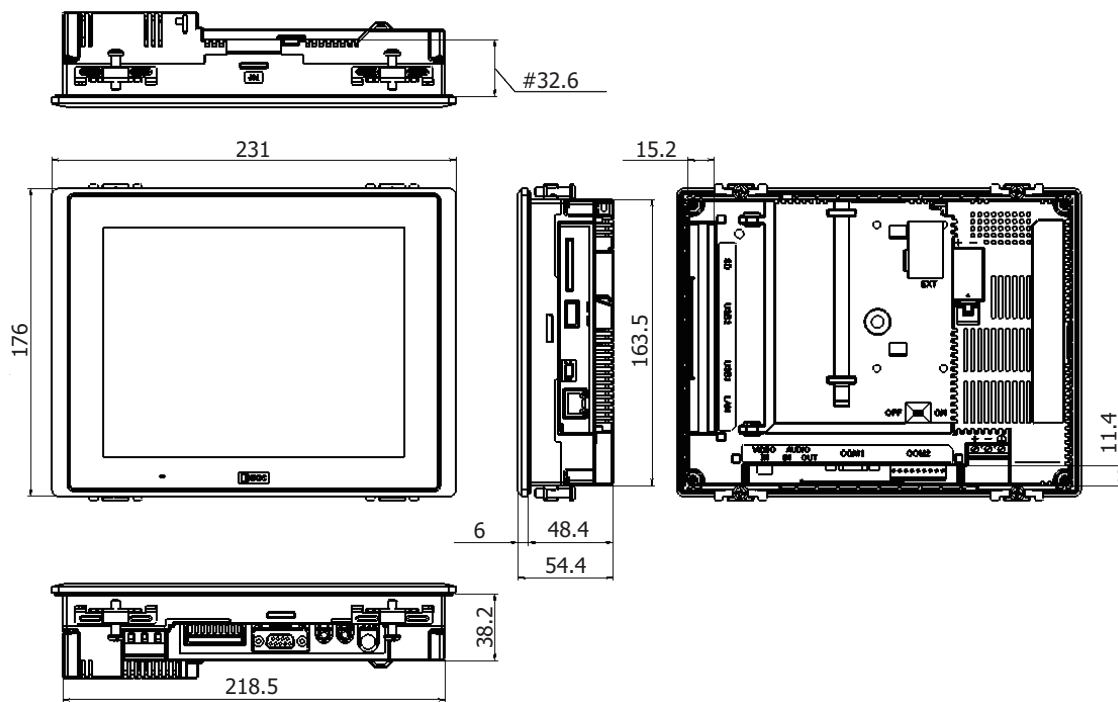

The size to the expansion module installation side

<Cable Attached Dimensions>

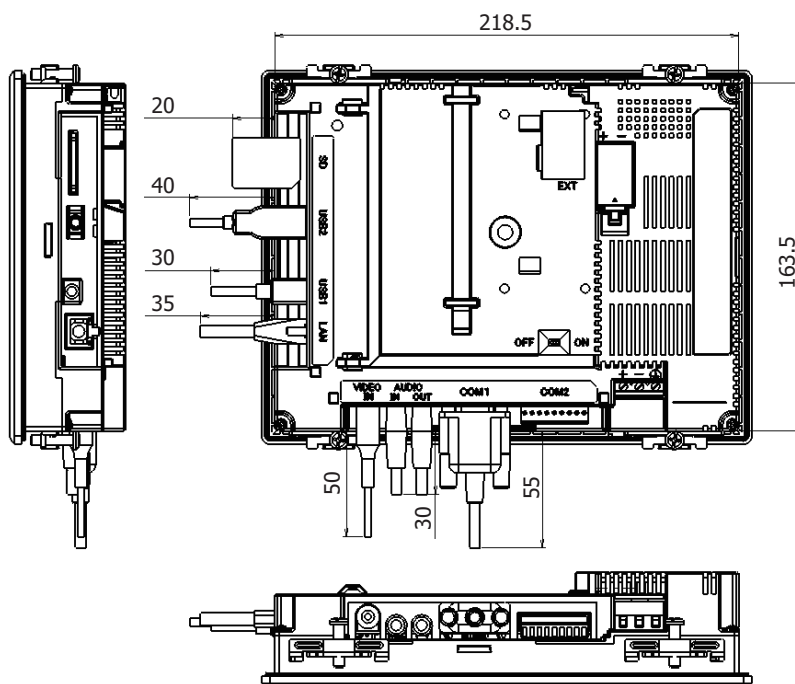

Depending on the type of connection cable used the dimensions shown above will change. The dimensions given here are representative values and are intended for reference only.

■ HG2G-5F (5.7inch)

Unit: mm

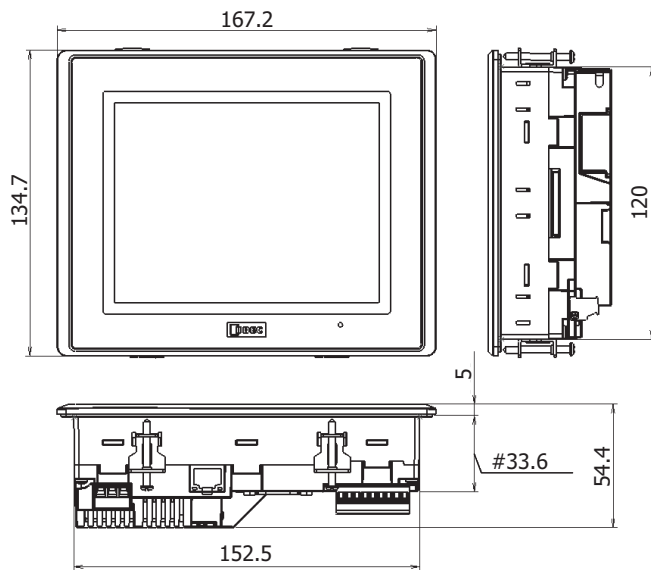

The size to the expansion module installation side

<Cable Attached Dimensions>

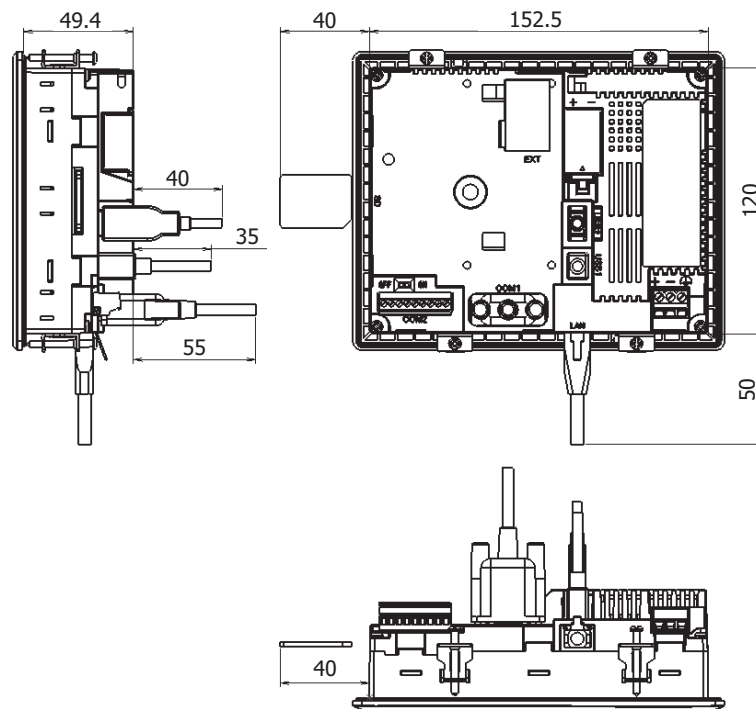

Depending on the type of connection cable used the dimensions shown above will change. The dimensions given here are representative values and are intended for reference only.

3.7 Installation

● Operating Environment

For designed performance and safety of the HG4G/3G, HG2G-5F, do not install the HG4G/3G, HG2G-5F in the following environments:

- Where dust, briny air, or iron particles exist.
- Where oil or chemical splashes for a long time.
- Where space is filled with oil mist.
- Where direct sunlight falls on the HG4G/3G, HG2G-5F.
- Where strong ultraviolet rays fall on the HG4G/3G, HG2G-5F.
- Where corrosive or combustible gasses exist.
- Where the HG4G/3G, HG2G-5F is subjected to shocks or vibrations.
- Where condensation occurs due to rapid temperature change.
- Where high-voltage or arc-generating equipment (electromagnetic contactors or circuit protectors) exists in the vicinity.

● Ambient Temperature

- Allow sufficient space for ventilation, and install the equipment away from heat sources.
- Allow at least 100mm between the HG4G/3G, HG2G-5F and walls or other equipment.
- Do not install the HG4G/3G, HG2G-5F where the ambient temperature exceeds the rated operating ambient temperature range. When mounting the HG4G/3G, HG2G-5F in such locations, provide a forced air-cooling fan or air-conditioner to keep the ambient temperature within the rated temperature range.
- The HG4G/3G, HG2G-5F is designed to install on a vertical plane so that natural air-cooling is provided. If you install it using any other orientation, use forced-air cooling, or lower the ambient operating temperature.

● HG4G/3G, HG2G-5F Installation

- Make a panel cut-out on the panel with the dimensions shown below.

Unit: mm

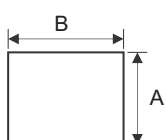

Type No.	A	B	Panel Thickness
HG4G	227.5 ^{+2.0} ₀	301.5 ^{+2.0} ₀	2.0 to 5.0
HG3G-A	200.0 ^{+2.0} ₀	258.0 ^{+2.0} ₀	2.0 to 5.0
HG3G-8	164.0 ^{+2.0} ₀	219.0 ^{+2.0} ₀	2.0 to 5.0
HG2G-5F	121.0 ^{+2.0} ₀	153.0 ^{+2.0} ₀	1.6 to 5.0

- Use the attached mounting clips to tighten the screws evenly to mount panel: screws must be applied on total of four places on top and bottom with the specified torque. Mounting clips can be attached to the left and right sides of HG4G and HG2G-5F. However, if they are attached in such way, there is a risk of not satisfying product specifications such as waterproof performance, shock resistance, and vibration resistance performance.

Mounting Clip Position ex) HG3G-8 (8.4 inch)

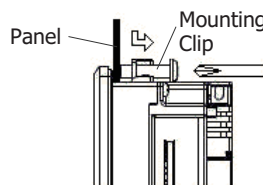
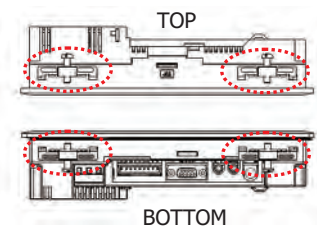

Unit : N·m





Type	Specified Torque
HG4G	0.5 to 0.6
HG3G-A	0.5 to 0.6
HG3G-8	0.5 to 0.6
HG2G-5F	0.2 to 0.3

CAUTION

- Do not tighten with excessive force, otherwise the HG4G/3G, HG2G-5F may warp and cause wrinkle on the display, or impair the waterproof characteristics.
- If the mounting clips are tightened obliquely to the panel, the HG4G/3G, HG2G-5F may fall off the panel.
- When installing the HG4G/3G, HG2G-5F into a panel cut-out, make sure that the gasket is not twisted. Especially when re-installing, take special care because any twists in the gasket will impair the waterproof characteristics.

● HG4G/3G, HG2G-5F Orientation

The HG4G/3G, HG2G-5F is designed to install on a vertical landscape. If you install it using any other orientation, confirm the limitations about operating temperature and the use of MICROSmart expansion modules.

Orientation			Operating Temperature	
			w/o expansion modules	w/ expansion modules
Vertical	 Landscape	HG4G	0 to 50°C	0 to 50°C
		HG3G		0 to 45°C
		HG2G-5F		0 to 40°C* ¹
	 Portrait (Clockwise)	HG4G	0 to 50°C	unavailable
		HG3G		
		HG2G-5F		
	 Portrait (Counter Clockwise)	HG4G	0 to 50°C	0 to 45°C
		HG3G	0 to 45°C	0 to 40°C* ¹
		HG2G-5F		0 to 35°C
 Horizontal	HG4G	0 to 50°C	unavailable	
	HG3G	0 to 45°C		
	HG2G-5F			



- When installing the HG4G/3G, HG2G-5F in a diagonal, the limitations are same as a horizontal.
- Confirm the visibility of the display in a final installation.

*1 When I/O Simultaneous ON Ratio is 50% or less, the Ambient Temperature is 0 to 45°C.

3.8 Wiring

⚠ CAUTION

- Turn off the power supply before wiring.
- Make the wiring as short as possible and run all wires as far away as possible from high-voltage and large-current cables. Follow all the procedures and precautions when wiring the HG4G/3G, HG2G-5F.
- Separate the HG4G/3G, HG2G-5F power supply wiring from the power lines of I/O devices and motor equipment.
- Ground the functional earth terminal to make sure of correct operation.

● Power Supply Terminal

- Pin assignment is shown in the following table.

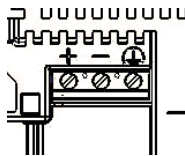

+	Power supply 24V DC (+24V)
-	Power supply 0V (0V)
⏏	Functional Earth (FE)

- Use applicable cables for wiring and recommended ferrules (made by Phoenix Contact or Weidmüller) as follows.

Type No.	HG4G/3G		HG2G-5F	
Applicable cable	AWG18 to AWG22		AWG14 to AWG22	
Recommended ferrule	AI 0,34-8 TQ AI 0,5-8 WH AI 0,75-8 GY AI 1-8 RD AI-TWIN 2 x 0,5-8 WH AI-TWIN 2 x 0,75-8 GY AI-TWIN 2 x 1-8 RD (Phoenix Contact)	H0,34/12 TK H0,5/14 OR H0,75/14 W H1,0/14 GE H0,5/14 ZH OR H0,75/14 ZH W H1,0/15 ZH GE (Weidmüller)	AI 0,34-12 TQ AI 0,5-12 WH AI 0,75-12 GY AI 1-12 RD AI 1,5-12 BK AI 2,5-12 BU AI-TWIN 2 x 1,5-12 BK (Phoenix Contact)	H0,5/18 OR H0,75/18 W H1,0/18 GE H1,5/18D SW H2,5/19D BL H1,5/20 ZH R (Weidmüller)
Tightening Torque	0.5 to 0.6 N·m		0.5 to 0.6 N·m	

● Grounding Cautions

If you decide to use a single power supply for the HG4G/3G, HG2G-5F with more than one external device, take extra precautions. Some external devices may produce electrical noise and short circuit the entire system setup, therefore, damaging the communication circuit of the HG4G/3G, HG2G-5F and non-isolated Communication Device (i.e. PLC). To prevent such damage, choose a proper solution depending on your system setup.

- Use a separate earth ground from the external noise source device.
- The wire for grounding should be thick and short in order to direct the noise from the noise source device to the earth ground.
- Use a separate power supply from the external noise source device.
- Insert an isolator on the communication line of the HG4G/3G, HG2G-5F and the non-isolated communication device (i.e. PLC) to prevent damage.

● Cautions for using the HG4G/3G, HG2G-5F connected to a personal computer

When connecting the HG4G/3G, HG2G-5F to a personal computer via the Serial Interface(COM1) or USB Interface, the HG4G/3G, HG2G-5F or the personal computer may break down depending on the conditions of the personal computer. Make sure of the following cautions, in order to prevent an accident.

- If the personal computer has a 3-pin power plug or power plug with a ground lead type. make sure to use a plug socket including a ground input electrode or ground the earth lead, respectively.
- If the personal computer has a 2-pin power plug without ground lead, follow the procedure below when connect the HG4G/3G, HG2G-5F to the personal computer.
 - (1) Pull out the power plug of the personal computer from the AC outlet.
 - (2) Connect the HG4G/3G, HG2G-5F to the personal computer.
 - (3) Insert the power plug of the personal computer into the AC outlet.

3.9 USB Cable Lock Pin Attachment

When using the USB device, attach the USB Cable Lock Pin to prevent disconnecting the USB cable from the HG4G/3G, HG2G-5F.

- 1 Insert the USB cable into the USB2 port.
- 2 Strain the [Edge part] of the USB Cable Lock Pin, and insert the [Edge part] to the 2 holes upper the USB2 port.

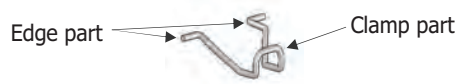

HG4G/3G

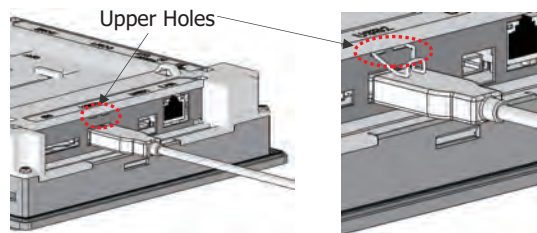

HG2G-5F

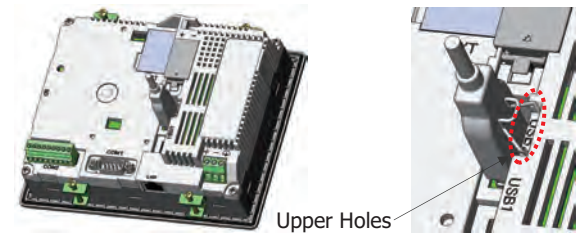

- 3 Fasten the USB Clamp Band around the USB cable and the [Clamp part], secure them tightly.

HG4G/3G

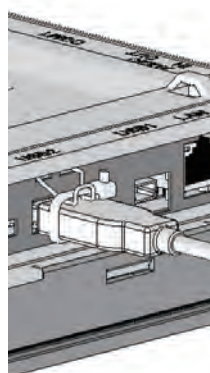

HG2G-5F

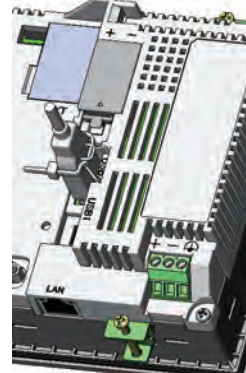

Fasten the USB Clamp Band without the space between the [Clamp part] and it, and the inclination.

OK

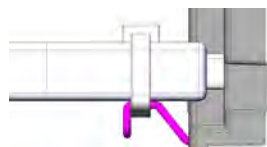

NG

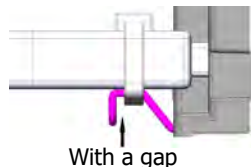

NG

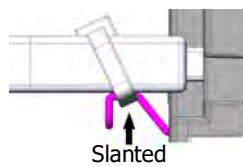

NG

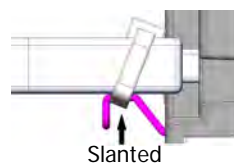

3.10 Maintenance and Inspection

Maintain and inspect the HG4G/3G, HG2G-5F periodically to ensure the best performance. Do not disassemble, repair, or modify the HG4G/3G, HG2G-5F during inspection.

Display	Wipe any stain of the display using a soft cloth slightly dampened with neutral detergent or alcoholic solvent. Do not use solvents such as thinner, ammonia, strong acid, and strong alkaline.
Terminals, Connectors	Check the terminals and connectors to make sure of no loose screws, incomplete insertion, or disconnected lines.
Mounting Clips	Make sure that all mounting clips and screws are tightened sufficiently. If the mounting clips are loose, tighten the screw to the recommended tightening torque.
Backlight	The HG4G/3G, HG2G-5F's backlight cannot be replaced by the customer. When the backlight needs to be replaced. Contact your vendor or IDEC Corporation.
Backup Battery	The operating life of the internal battery is approximately five years. It is recommended to replace the battery every five years even before the reminder message for battery replacement is displayed.
Touch Panel	A gap may be caused in the operation accuracy of the touch panel by the secular distortion, etc. Readjust the touch panel in the System Mode according to the following procedure when there is a gap in the operation of the touch panel. Refer to "Adjusting the Touch Panel" on page 35-53 for details.

● Replacing the Backup Battery

A backup battery is built into the HG4G/3G, HG2G-5F to retain the internal backup data (log data, keep resistor, and keep relay) and clock data.

When the "Replace the battery" message is displayed, replace the backup battery by following the procedure below.

When the "Battery level LOW" message is displayed, replace the battery immediately; otherwise, the backup data and clock data may be lost.

Whether or not to display the reminder message for battery replacement can be specified with the configuration software. Refer to Chapter 4 "3.1 System Tab" on page 4-25 for details.

1 Remove the battery holder cover.



2 Turn on the power to the HG4G/3G, HG2G-5F, wait for approximately one minute, and then turn off the power again.



After turning off the power to the HG4G/3G, HG2G-5F in step 2, complete the steps through 4 within 30 seconds to replace the battery without losing the backup data and clock data. However, it is recommended that the backup data be transferred to flash memory as a precautionary measure. For the procedure to transfer the data to flash memory, refer to Chapter 33 "Internal Devices" on page 33-1. If it is not necessary to save the data, step 2 can be skipped.

3 Remove the battery from the battery holder.

4 Install a replacement battery into the battery holder. Ensure that the orientation of the battery is correct.

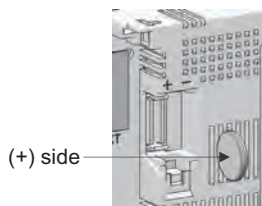

- 5 With the new batter installed correctly, reverse the instruction the procedure described in item #1 above to secure the cover.
- The operating life of the internal battery is approximately five years. It is recommended to replace the battery every five years even before the reminder message for battery replacement is displayed.
 - IDEC provides replacement service for the battery (at customer's expense). Contact your vendor or IDEC Corporation.

! WARNING

The battery may be regulated by national or local regulation. Observe the instructions of proper regulation. As electric capacity is left in a discarded battery and it comes into contact with other metals, it could lead to distortion, leakage, overheating, or explosion, so make sure to cover the (+) and (-) terminals with insulating tape before disposal.

! CAUTION

When replacing the battery, use the specified battery only. Note that any problems and failures arising from or in connection with the use of a battery other than the specified battery is not guaranteed.

Handling of Batteries and Devices with Built-in Batteries in EU Member States

Note) The following symbol mark is for EU countries only and is according to the directive 2006/66/EC Article 20 information for end-users and Annex II.



This symbol mark means that batteries and accumulators, at their end-of life, should be disposed of separately from your household waste.

If a chemical symbol is printed beneath the symbol shown above, this chemical symbol means that the battery or accumulator contains a heavy metal at a certain concentration. This will be indicated as follows :

Hg : mercury (0.0005%), Cd : cadmium (0.002%), Pd : lead (0.004%)

In the European Union there are separate collection systems for used batteries and accumulators.

Please dispose of batteries and accumulators correctly in accordance with each country or local regulation.

● **Maintenance Screen**

Turn on the power to the HG4G/3G, HG2G-5F, then press and hold the touch panel on the upper-left corner of the screen for three seconds or longer. The Maintenance Screen appears on the screen.

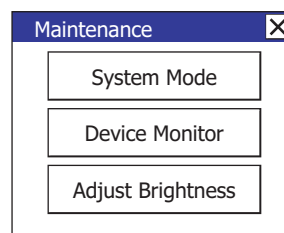
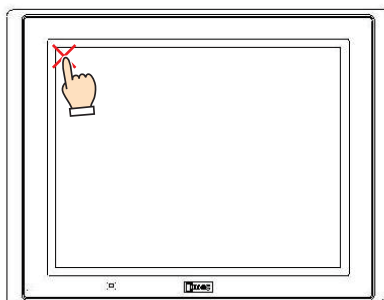

Maintenance Screen

- Permission to show the Maintenance Screen can be set using the configuration software. Refer to Chapter 4 "3.1 System Tab" on page 4-25 for details.
- The Maintenance Screen is not displayed in the System Mode.

● System Mode

Press the [System Mode] at the top of the Maintenance Screen. The Top Page Screen appears.

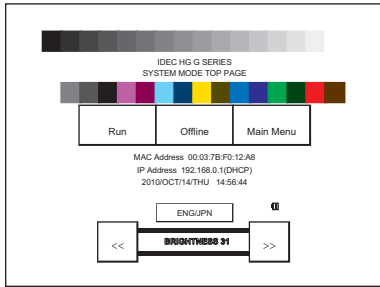

Initial Setting, Self Diagnosis and Initialization of the data, etc can be executed in the System Mode.

● Adjusting the Brightness

The brightness of the HG4G/3G, HG2G-5F display can be adjusted on the Adjust Brightness Screen.

- 1 Press the [Adjust Brightness] at the bottom of the Maintenance Screen. The Adjust Brightness Screen appears.

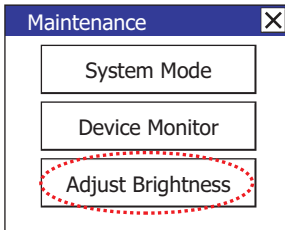

- 2 Press the [<<] and [>>] at the bottom the Adjust Brightness Screen to adjust the contrast to the optimal setting.



- 3 Press the [X] to close the Adjust Brightness Screen.



To adjust the brightness in the System Mode, use the [<<] and [>>] buttons located at the bottom of the Top Page.

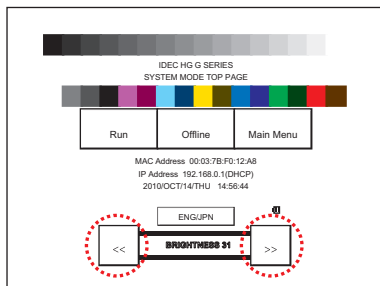

● Adjusting the Touch Panel

A gap may be caused in the operation accuracy of the touch panel by the secular distortion, etc. Adjust the touch panel according to the following procedure when there is a gap in the operation of the touch panel.

- 1 Press the **Main Menu** on the Top Page in System Mode. The Main Menu Screen appears.

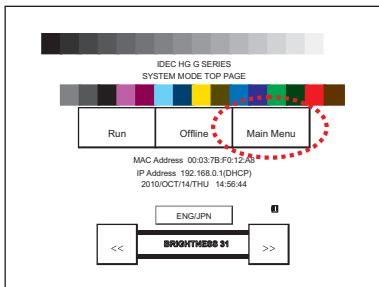

- 2 Press in order of **Initial Setting, Initialize, Touch Panel Adjust**. The confirmation screen appears and asks "Adjust Touch Panel setting?". Press **Yes**, then the Touch Panel Adjust screen appears.
- 3 Press the center of the X mark, then the position of the mark changes one after another. Press five marks sequentially.



Press the center of the X mark.

This will ensure the accuracy of the touch panel operation.









- 4 When normally recognized, the confirmation screen of 2 is restored.

At procedure 3, when pressing a point away from the center of the X mark, a recognition error will result. Then the X mark returns to the initial position, then repeat the procedure of 3 again.

4 HG2G-5T, HG1G

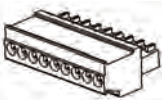
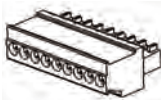
4.1 Packing content

Before installing the HG2G-5T, HG1G, make sure that the specifications of the product conform to your requirements, and that no parts are missing or damaged due to accidents during transportation.

Name	HG2G-5T	HG1G
HG2G-5T, HG1G Unit	 x 1	 x 1
Instruction Sheet (Japanese/English/Simplified Chinese)	x 1	x 1
Mounting clips	 x 4	 x 2
Communication plug for external devices (Attached to the HG2G-5T, HG1G)	 x 1	 x 1
USB Cable Lock Pin	 x 1	 x 2
USB Clamp Band	 x 1	 x 2

4.2 Type No.

LCD size	Bezel color	Type No.
5.7 inch TFT Monochrome LCD	Light gray	HG2G-5TN22TF-W
	Dark gray	HG2G-5TN22TF-B
	Silver	HG2G-5TN22TF-S
5.7 inch TFT Color LCD	Light gray	HG2G-5TT22TF-W
	Dark gray	HG2G-5TT22TF-B
	Silver	HG2G-5TT22TF-S
4.3 inch TFT Color LCD	Black	HG1G-4VT22TF-B
	Silver	HG1G-4VT22TF-S

4.3 Part Names

■ HG2G-5T

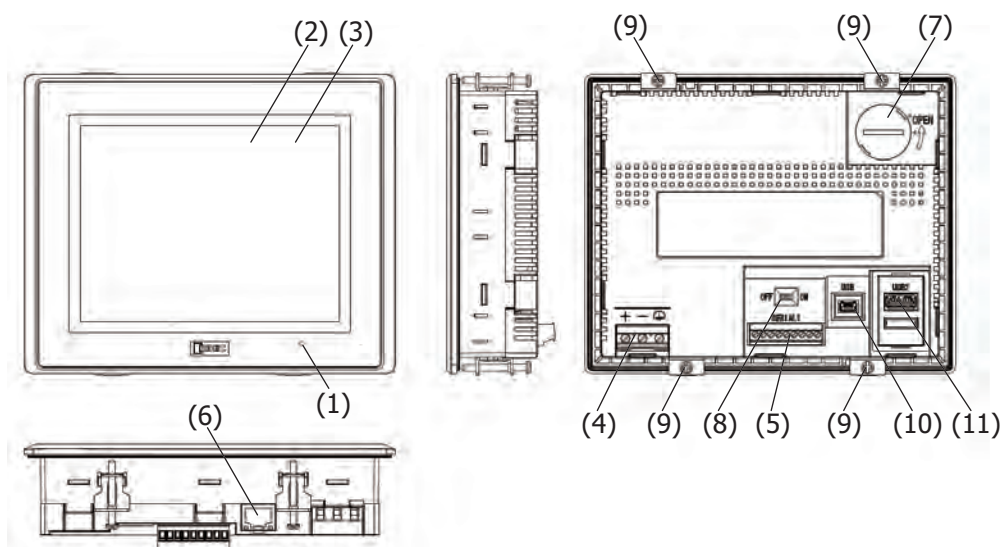

No.	Name	Description
(1)	POWER LED	Green (lit) : Normal Operation (Power is ON.) Not lit : Power is off.
(2)	Display	
(3)	Touch Panel	
(4)	Power Supply Terminal	Connector : Terminal Block 3-pin (Screw fastened type)
(5)	Serial Interface (SERIAL1)	RS232C, RS422/485 Connector : Terminal Block 9-pin (Screw fastened type) Maximum cable length: 15m (RS232C), 1,200m (RS422/RS485)
(6)	Ethernet Interface (LAN)	IEEE802.3u 10BASE-T/100BASE-TX Connector : RJ-45 (With Auto MDI/MDI-X function) Maximum cable length: 100m
(7)	Battery Cover	
(8)	Terminating Resistor Selector Switch	For RS422/485 interface
(9)	Mounting Clip Position	4 places
(10)	USB Interface (USB)	USB2.0 (Device) Connector : Mini-B
(11)	USB Interface (USB2)	USB2.0 (Host) Connector: Type A Output current : 5V 500mA

■ HG1G

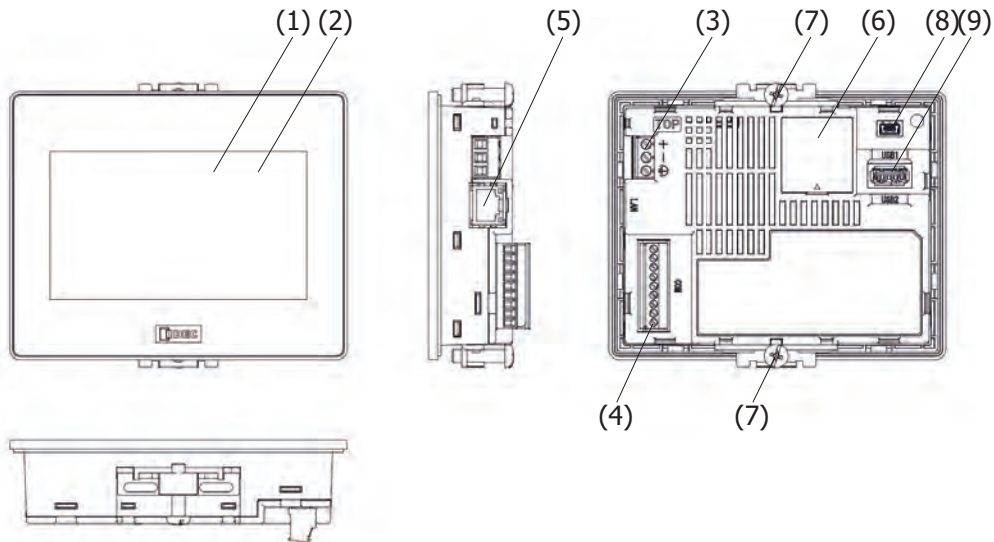

No.	Name	Description
(1)	Display	
(2)	Touch Panel	
(3)	Power Supply Terminal	Connector : Terminal Block 3-pin (Screw fastened type)
(4)	Serial Interface (COM)	RS232C, RS422/485 Connector : Terminal Block 9-pin (Screw fastened type) Maximum cable length: 15m (RS232C), 1,200m (RS422/RS485)
(5)	Ethernet Interface (LAN)	IEEE802.3u 10BASE-T/100BASE-TX Connector : RJ-45 (With Auto MDI/MDI-X function) Maximum cable length: 100m
(6)	Battery Cover	
(7)	Mounting Clip Position	2 places
(8)	USB Interface (USB1)	USB2.0 (Device) Connector : Mini-B
(9)	USB Interface (USB2)	USB2.0 (Host) Connector: Type A Output current : 5V 500mA ^{*1}

*1 Operating temperature range will be -20 to +50 ° C if USB interface is used with 151 mA or more.

4.4 External Interfaces

⚠ CAUTION

Make sure to turn off the power to the HG2G-5T, HG1G before wiring each interface or switching the terminating resistor selector switch.

● Serial Interface

Use applicable cables for wiring and recommended ferrules (made by Phoenix Contact or Weidmüller) as follows.

Interface Specification	RS232C, RS422/485	
Connector	Detachable Terminal Block 9-pin	
Applicable cable	AWG20 to AWG22	
Recommended ferrule	AI 0,34-8 TQ AI 0,5-8 WH AI-TWIN 2 x 0,5-8 WH (Phoenix Contact)	H0,34/12 TK H0,5/14 OR H0,5/14 ZH OR (Weidmüller)
Tightening Torque	0.22 to 0.25 N·m	



No.	Name	I/O	Function	Communication type	
1	SD	OUT	Send Data	RS232C	/
2	RD	IN	Receive Data		
3	RS	OUT	Request to Send		
4	CS	IN	Clear to Send		
5	SG	-	Signal Ground	/	RS422/485
6	SDA	OUT	Send Data (+)		
7	SDB	OUT	Send Data (-)		
8	RDA	IN	Receive Data (+)		
9	RDB	IN	Receive Data (-)		

Using RS422/485 interface

- For HG2G-5T, if you set the Terminating Resistor Selector Switch to the ON side, this will connect the internal terminating resistor (100Ω) between RDA and RDB.

Terminating Resistor Selector Switch

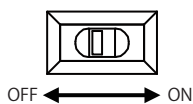

- HG1G is not equipped with terminating resistor. Insert a terminating resistor of an appropriate value (about 100 to 120 Ohm, 1/2 W minimum) between terminal number 8 (RDA) and terminal number 9 (RDB), if necessary.

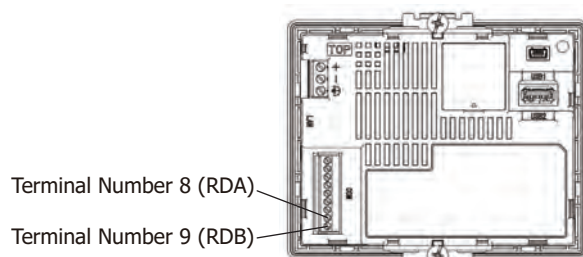

4.5 Specifications

■ Applicable Standards

Safety Standard	UL508, ANSI/ISA 12.12.01, CSA C22.2 No.142 (c-UL), CSA C22.2 No.213 (c-UL)
EMC Standard*1	IEC/EN 61131-2

■ Environmental Specifications

Type No.	HG2G-5T	HG1G
Operating Temperature	-20 to +60°C	-20 to +55°C*2
Operating Humidity	10 to 90% RH (no condensation)	
Storage Temperature	-20 to +70°C	
Storage Humidity	10 to 90% RH (no condensation)	
Altitude	0 to 2000m	
Pollution Degree	2	
Corrosion Immunity	Free from corrosive gases	

■ Electrical Specifications

Rated Voltage	12V DC / 24V DC
Power Consumption	8W maximum When not using USB Interface (USB2): 4W maximum
Power Voltage Range	10.2V DC to 28.8V DC
Allowable Momentary Power Interruption	10 ms maximum (Power supply: 20.4V DC to 28.8V DC) 1 ms maximum (Power supply: 10.2V DC to 20.4V DC)
Inrush Current	40A maximum
Dielectric Withstand Voltage	1000V AC, 10mA, 1 minute (between power and earth terminals)

■ Construction Specifications

Vibration	5 to 8.4Hz amplitude 3.5mm, 8.4 to 150Hz acceleration 9.8m/s ² 10 times on each of three mutually perpendicular axes (IEC61131-2)
Shock	147m/s ² , 11ms (3 shocks on each of three mutually perpendicular axes) (IEC61131-2)

*1 When using the HG2G-5T, HG1G as the EMC Standard Approved Products, refer to the precautions on the emission.

*2 When using a USB interface(USB2) by 151mA or more, operating temperature will be -20 to +50°C.

■ Performance Specifications

Type No.	HG2G-5TN	HG2G-5TT	HG1G	
Display	LCD Type *3	TFT Monochrome LCD (TN Type)	TFT Color LCD (TN Type)	
	Display Colors	2 Colors (16 tones)	65536 Colors	
	Effective Display Area	115.2 (W) × 86.4 (H) mm		95.04 (W) × 53.856 (H) mm
	Display Resolution	320 (W) × 240 (H) dots		480 (W) × 272 (H) dots
	View angle	Left/Right: 65°, Top: 80°, Bottom: 60°	Left/Right: 80°, Top: 80°, Bottom: 80°	Left/Right: 70°, Top: 60°, Bottom: 65°
	Brightness of LCD only	1100 cd/m ²	500 cd/m ²	800 cd/m ²
	Brightness Adjustment	32 levels		
	Backlight	LED		
Touch Panel	Backlight Life *4	Approx. 100,000 hours (The time until brightness becomes 50% of the initial value)		Approx. 70,000 hours (The time until brightness becomes 50% of the initial value)
	Switch Type	Analog Resistive Film		
	Operating Force	3N maximum		
	Multiple Operations	Impossible		
Life	1,000,000 operations			
User Memory	Approx. 5 MB		Approx. 12 MB	
Backup Battery	Coin type lithium manganese dioxide battery CR2032 Guarantee Period: 1 Year (operating temperature at 25°C) Recommended Replacement Span: Every 5 Years (operating temperature at 25°C)			
Backup Data	Calendar, Log Data, HMI Keep Relays, HMI Keep Registers			
Buzzer output	Single tone (tone length is adjustable)			
Degree of Protection *5	When panel thickness is 1 to 5 mm: IP65F (IEC60529) When panel thickness is 1.5 to 5 mm: IP66F (IEC60529), TYPE 4X, TYPE 13		When panel thickness is 1 to 5 mm: IP65F, IP67F (IEC60529) When panel thickness is 1.5 to 5 mm: IP66F, IP67F (IEC60529), TYPE 4X, TYPE 13	
Weight (approx.)	500g		300g	

■ EMC Specifications

Radiated Emission	Class A : 10m 40dB μ V/m quasi-peak (30M to 230MHz) 47dB μ V/m quasi-peak (230M to 1GHz)
Electrostatic Discharge	Contact : \pm 6kV Air : \pm 8kV
Electromagnetic Field	10V/m (80M to 1.0GHz) 3V/m (1.4G to 2.0GHz) 1V/m (2.0G to 2.7GHz) 80% AM (1kHz)
Fast Transient Burst	Power : \pm 2kV Communication cable : \pm 1kV
Surge Immunity	\pm 500V (between +24V and 0V) \pm 1kV (between +24V and FE, 0V and FE)
Conducted Radio Frequency Immunity	3V (Power, Communication cable) (150k to 80MHz) 80% AM (1kHz)

*3 Please be aware that small black and bright dots might show up on LCD Screen: it is not a failure or malfunction.

*4 The life of the LCD itself at an ambient temperature of 25°C. This is not a guaranteed value. The actual life depends on the environment and conditions of use.

*5 It is a protection structure for the operating surface of HMI, which is attached to a panel. Although protection structure suffices every test conditions, it does not guarantee to operate under all of the environmental condition. As for IP65F/IP66F/IP67F oilproof structure, it suffices oilproof test conditions. Conditions are listed in the document that comes with Japanese Industrial Standard JIS C 0920. Protection structure do not guarantee usage under long exposure to oil or usage of oil that is not prescribed in the document. Please test/check beforehand to avoid trouble.

Notes related to emissions

In order to meet the emission specifications for the HG2G-5T, HG1G, attach a ferrite core to the power cables and communication cables.

Recommended ferrite core: ZCAT3035-1330 manufactured by TDK Corporation

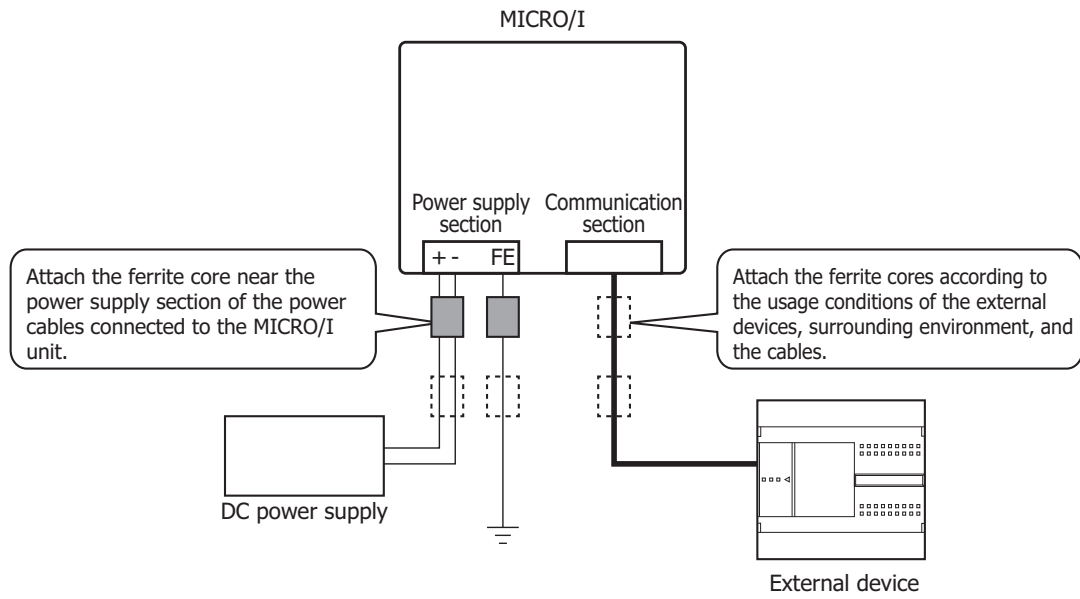

4.6 Dimensions

■ HG2G-5T

Unit: mm

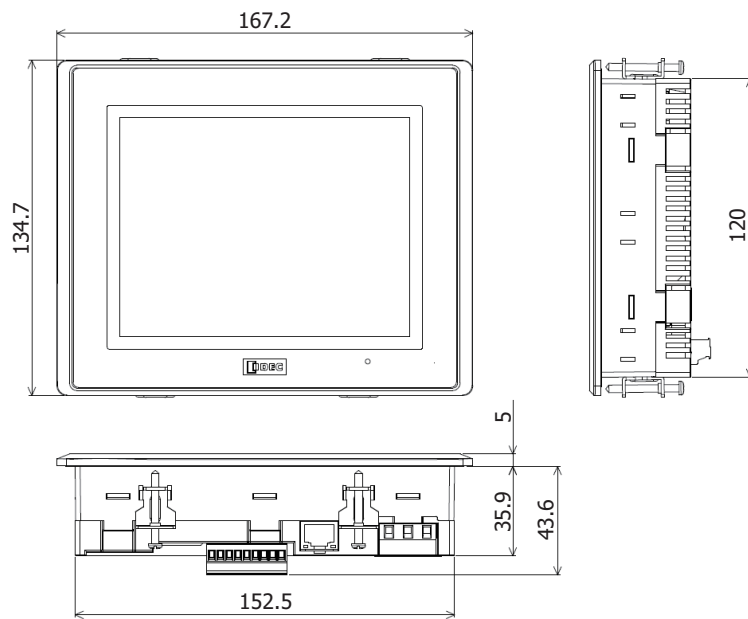

<Cable Attached Dimensions>

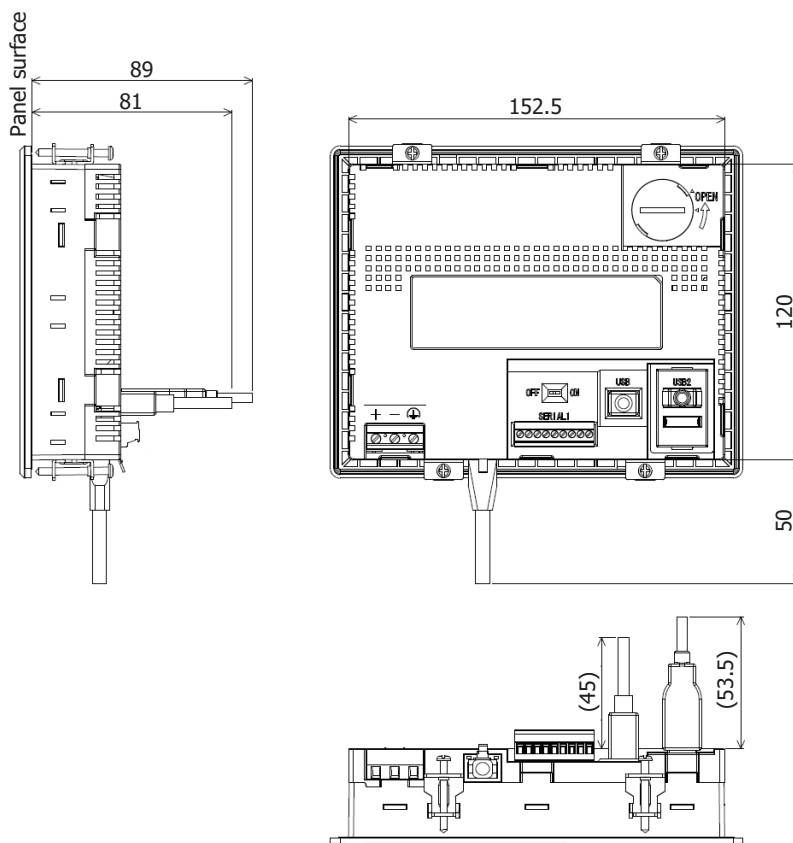

Depending on the type of connection cable used the dimensions shown above will change. The dimensions given here are representative values and are intended for reference only.

■ HG1G

Unit: mm

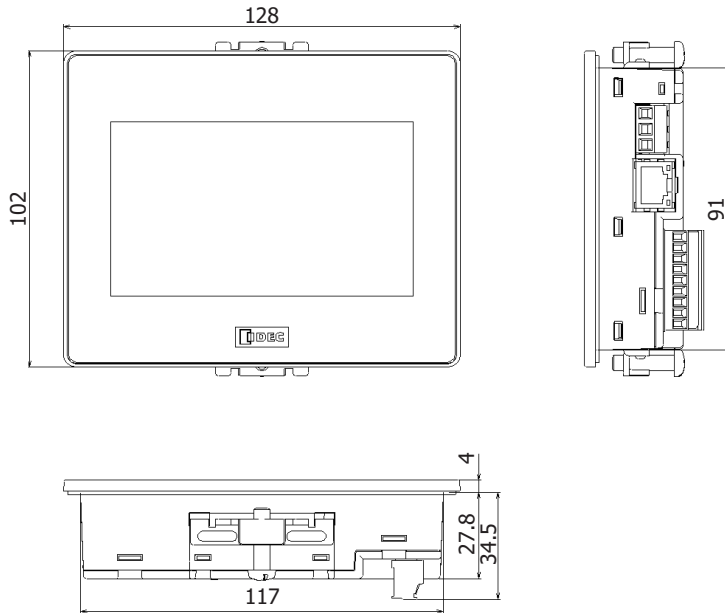

<Cable Attached Dimensions>

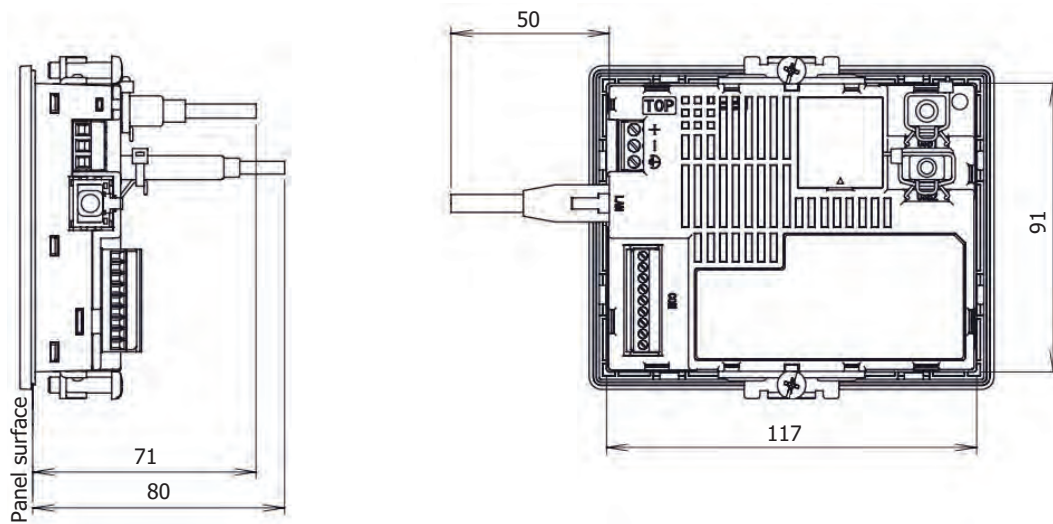

Depending on the type of connection cable used the dimensions shown above will change. The dimensions given here are representative values and are intended for reference only.

4.7 Installation

● Operating Environment

For designed performance and safety of the HG2G-5T, HG1G, do not install the HG2G-5T, HG1G in the following environments:

- Where dust, briny air, or iron particles exist.
- Where oil or chemical splashes for long time.
- Where space is filled with oil mist.
- Where direct sunlight falls on the HG2G-5T, HG1G.
- Where strong ultraviolet rays fall on the HG2G-5T, HG1G.
- Where corrosive or combustible gasses exist.
- Where the HG2G-5T, HG1G is subjected to shocks or vibrations.
- Where condensation occurs due to rapid temperature change.
- Where high-voltage or arc-generating equipment (electromagnetic contactors or circuit protectors) exists in the vicinity.

● Ambient Temperature

- Allow sufficient space for ventilation, and install the equipment away from heat sources.
- Allow at least 100mm between the HG2G-5T, HG1G and walls or other equipment.
- Do not install the HG2G-5T, HG1G where the ambient temperature exceeds the rated operating ambient temperature range. When mounting the HG2G-5T, HG1G in such locations, provide a forced air-cooling fan or air-conditioner to keep the ambient temperature within the rated temperature range.

● HG2G-5T, HG1G Installation

- Make a panel cut-out on the panel with the dimensions shown below.

Unit: mm

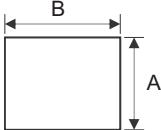

Type No.	A	B	Panel Thickness
HG2G-5T	121.0 ^{+2.0} ₀	153.0 ^{+2.0} ₀	1.0 to 5.0
HG1G	92.0 ^{+1.0} ₀	118.0 ^{+1.0} ₀	

- Use the attached mounting clips to tighten the screws evenly to mount panel: screws must be applied on total of four places for HG2G-5T and on total two places for HG1G with the specified torque. Mounting clips can be attached to the left and right sides of HG2G-5T. However, if they are attached in such way, there is a risk of not satisfying product specifications such as waterproof performance, shock resistance, and vibration resistance performance.

Unit: mm

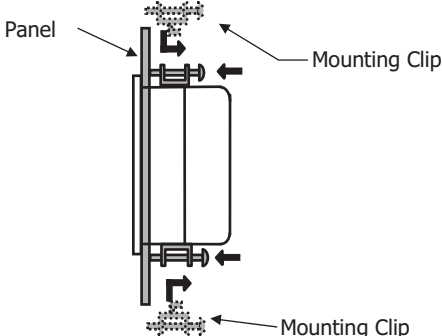

Type No.	Specified Torque
HG2G-5T	0.2 to 0.3
HG1G	0.3 to 0.35

CAUTION

- Do not tighten with excessive force, otherwise the HG2G-5T, HG1G may warp and cause wrinkle on the display, or impair the waterproof characteristics.
- If the mounting clips are tightened obliquely to the panel, the HG2G-5T, HG1G may fall off the panel.
- When installing the HG2G-5T, HG1G into a panel cut-out, make sure that the gasket is not twisted. Especially when re-installing, take special care because any twists in the gasket will impair the waterproof characteristics.

4.8 Wiring

! CAUTION

- Turn off the power supply before wiring.
- Make the wiring as short as possible and run all wires as far away as possible from high-voltage and large-current cables. Follow all the procedures and precautions when wiring the HG2G-5T, HG1G.
- Separate the HG2G-5T, HG1G power supply wiring from the power lines of I/O devices and motor equipment.
- Ground the functional earth terminal to make sure of correct operation.

● Power Supply Terminal

- Pin assignment is shown in the following table.

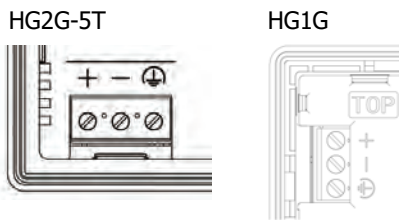

+	Power supply 12V DC / 24V DC
-	Power supply 0V
⏚	Functional Earth (FE)

- Use applicable cables for wiring and recommended ferrules (made by Phoenix Contact or Weidmüller) as follows.

Applicable cable	AWG18 to AWG22	
Recommended ferrule	AI 0,34-8 TQ AI 0,5-8 WH AI 0,75-8 GY AI 1-8 RD AI-TWIN 2 x 0,5-8 WH AI-TWIN 2 x 0,75-8 GY AI-TWIN 2 x 1-8 RD* ¹ (Phoenix Contact)	H0,34/12 TK H0,5/14 OR H0,75/14 W H1,0/14 GE H0,5/14 ZH OR H0,75/14 ZH W H1,0/15 ZH GE* ¹ (Weidmüller)
Tightening Torque	0.5 to 0.6 N·m	

● Cautions for using the HG2G-5T, HG1G connected to a personal computer

When connecting the HG2G-5T, HG1G to a personal computer via the USB Interfaces, the HG2G-5T, HG1G or the personal computer may break down depending on the conditions of the personal computer. Make sure of the following cautions, in order to prevent an accident.

- If the personal computer has a 3-pin power plug or power plug with a ground lead type, make sure to use a plug socket including a ground input electrode or ground the earth lead, respectively.
- If the personal computer has a 2-pin power plug without ground lead, follow the procedure below when connect the HG2G-5T, HG1G to the personal computer.
 - (1) Pull out the power plug of the personal computer from the AC outlet.
 - (2) Connect the HG2G-5T, HG1G to the personal computer.
 - (3) Insert the power plug of the personal computer into the AC outlet.

*1 HG2G-5T only

4.9 USB Cable Lock Pin Attachment

When using the USB device, attach the USB Cable Lock Pin to prevent disconnecting the USB cable from the HG2G-5T*1, HG1G.

- 1 Insert the USB cable into the USB2 port.
- 2 Strain the [Edge part] of the USB Cable Lock Pin, and insert the [Edge part] to the 2 holes lower the USB2 port.

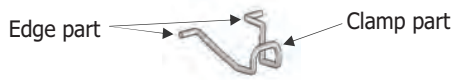

HG2G-5T

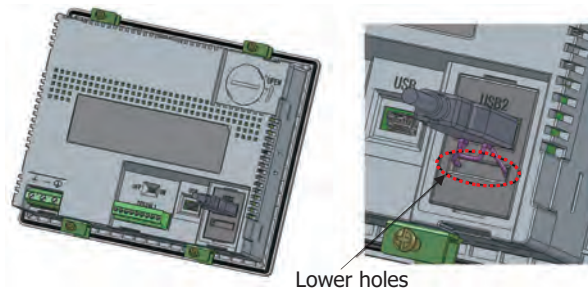

HG1G

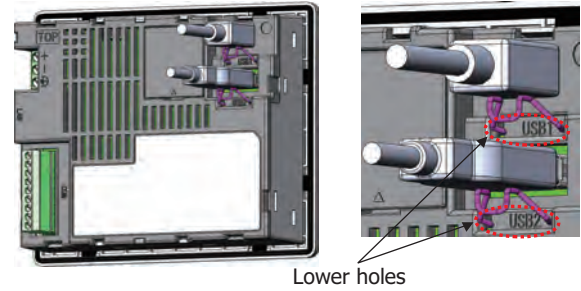

- 3 Fasten the USB Clamp Band around the USB cable and the [Clamp part], secure them tightly.

HG2G-5T

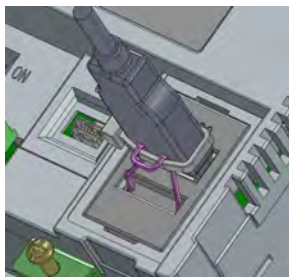

HG1G

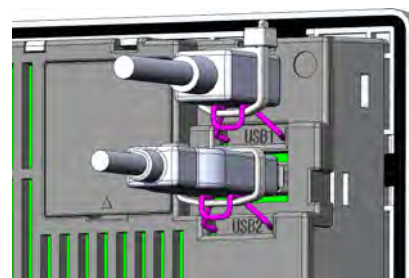

Fasten the USB Clamp Band without the space between the [Clamp part] and it, and the inclination.

OK

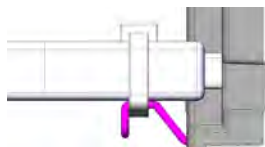

NG

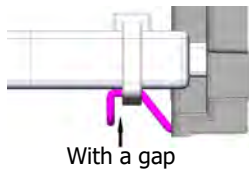

With a gap

NG

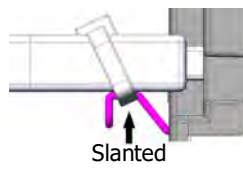

Slanted

NG

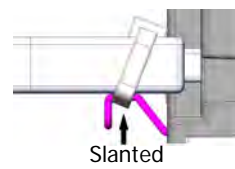

Slanted

*1 Only USB2 for HG2G-5T

4.10 Maintenance and Inspection

Maintain and inspect the HG2G-5T, HG1G periodically to ensure the best performance. Do not disassemble, repair, or modify the HG2G-5T, HG1G during inspection.

Display	Wipe any stain of the display using a soft cloth slightly dampened with neutral detergent or alcoholic solvent. Do not use solvents such as thinner, ammonia, strong acid, and strong alkaline.
Terminals, Connectors	Check the terminals and connectors to make sure of no loose screws, incomplete insertion, or disconnected lines.
Mounting Clips	Make sure that all mounting clips and screws are tightened sufficiently. If the mounting clips are loose, tighten the screw to the recommended tightening torque.
Backlight	The HG2G-5T, HG1G's backlight cannot be replaced by the customer. When the backlight needs to be replaced. Contact your vendor or IDEC Corporation.
Backup Battery	The operating life of the internal battery is approximately five years. It is recommended to replace the battery every five years even before the reminder message for battery replacement is displayed.
Touch Panel	A gap may be caused in the operation accuracy of the touch panel by the secular distortion, etc. Readjust the touch panel in the System Mode according to the following procedure when there is a gap in the operation of the touch panel. Refer to "Adjusting the Touch Panel" on page 35-69 for details.

● Replacing the Backup Battery

A backup battery is built into the HG2G-5T, HG1G to retain the internal backup data (log data, keep register, and keep relay) and clock data.

When the "Replace the battery" message is displayed, replace the backup battery by following the procedure below.

When the "Battery level LOW" message is displayed, replace the battery immediately; otherwise, the backup data and clock data may be lost.

Whether or not to display the reminder message for battery replacement can be specified with the configuration software. Refer to Chapter 4 "3.1 System Tab" on page 4-25 for details.

- 1 Follow the procedure below to remove the battery holder cover.

HG2G-5T

Turn the cover counterclockwise using a coin.



HG1G

Use a flat head screwdriver.

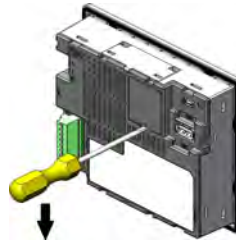

- 2 Turn on the power to the HG2G-5T, HG1G, wait for approximately one minute, and then turn off the power again.



After turning off the power to the HG2G-5T, HG1G in step 2, complete the steps through 4 within 30 seconds to replace the battery without losing the backup data and clock data. However, it is recommended that the backup data be transferred to flash memory as a precautionary measure. For the procedure to transfer the data to flash memory, refer to Chapter 33 "Internal Devices" on page 33-1. If it is not necessary to save the data, step 2 can be skipped.

- 3 Insert a flat head screwdriver into the battery holder, as shown in the figure below, and remove the battery. The battery may pop out from the battery holder.

HG2G-5T

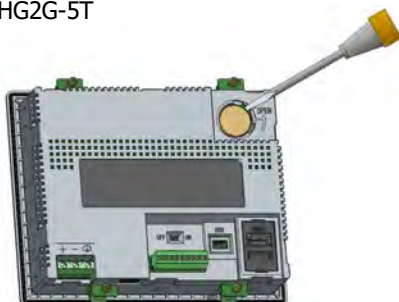

HG1G

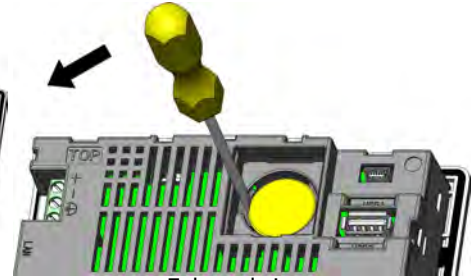
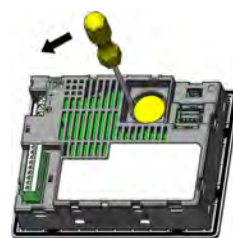

Enlarged view

- 4 Install a replacement battery into the battery holder. Ensure that the orientation of the battery is correct.

HG2G-5T

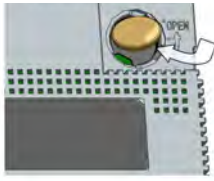

HG1G

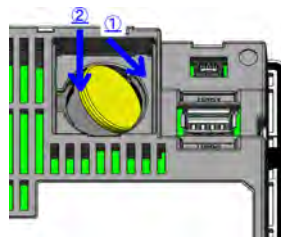

- 5 With the new battery installed correctly, reverse the instruction the procedure described in item #1 above to secure the cover.

HG2G-5T

Set the battery holder cover to the original position, and turn it clockwise using a coin.



HG1G

Set the battery holder cover, as shown in the figure below.

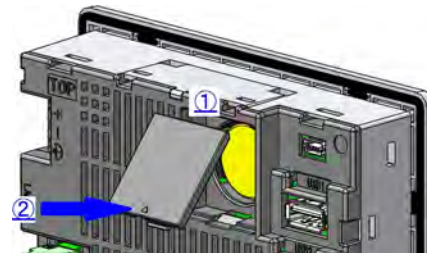

- The operating life of the internal battery is approximately five years. It is recommended to replace the battery every five years even before the reminder message for battery replacement is displayed.
- IDEC provides replacement service for the battery (at customer's expense). Contact your vendor or IDEC Corporation.

WARNING

The battery may be regulated by national or local regulation. Observe the instructions of proper regulation. As electric capacity is left in a discarded battery and it comes into contact with other metals, it could lead to distortion, leakage, overheating, or explosion, so make sure to cover the (+) and (-) terminals with insulating tape before disposal.

CAUTION

When replacing the battery, use the specified battery only. Note that any problems and failures arising from or in connection with the use of a battery other than the specified battery is not guaranteed.

Handling of Batteries and Devices with Built-in Batteries in EU Member States

Note) The following symbol mark is for EU countries only and is according to the directive 2006/66/EC Article 20 information for end-users and Annex II.



This symbol mark means that batteries and accumulators, at their end-of life, should be disposed of separately from your household waste.

If a chemical symbol is printed beneath the symbol shown above, this chemical symbol means that the battery or accumulator contains a heavy metal at a certain concentration. This will be indicated as follows :

Hg : mercury (0.0005%), Cd : cadmium (0.002%), Pd : lead (0.004%)

In the European Union there are separate collection systems for used batteries and accumulators.

Please dispose of batteries and accumulators correctly in accordance with each country or local regulation.

● Maintenance Screen

Turn on the power to the HG2G-5T, HG1G, then press and hold the touch panel on the upper-left corner of the screen for three seconds or longer. The Maintenance Screen appears on the screen.

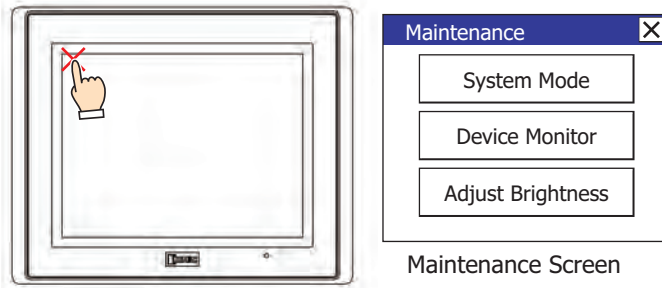

- Permission to show the Maintenance Screen can be set using the WindO/I-NV4. Refer to Chapter 4 "3.1 System Tab" on page 4-25 for details.
- The Maintenance Screen is not displayed in the System Mode.

● System Mode

Press the [System Mode] at the top of the Maintenance Screen. The Top Page Screen appears.

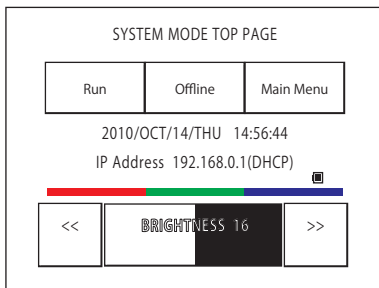

Initial Setting, Self Diagnosis and Initialization of the data, etc can be executed in the System Mode.

● Adjusting the Brightness

The brightness of the HG2G-5T, HG1G display can be adjusted on the Adjust Brightness Screen.

- 1 Press the [Adjust Brightness] at the bottom of the Maintenance Screen. The Adjust Brightness Screen appears.

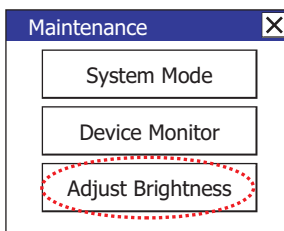

- 2 Press the [<<] and [>>] at the bottom of the Adjust Brightness Screen to adjust the brightness to the optimal setting.



- 3 Press the [X] to close the Adjust Brightness Screen.



To adjust the brightness in the System Mode, use the [<<] and [>>] buttons located at the bottom of the Top Page.

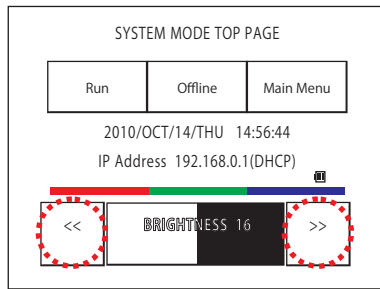

● Adjusting the Touch Panel

A gap may be caused in the operation accuracy of the touch panel by the secular distortion, etc. Adjust the touch panel according to the following procedure when there is a gap in the operation of the touch panel.

- 1 Press the **Main Menu** on the Top Page in System Mode. The Main Menu Screen appears.

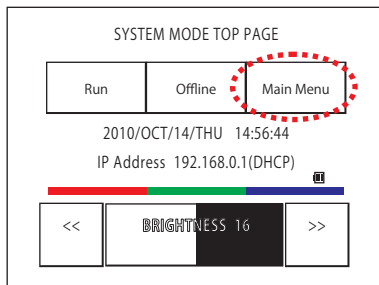

- 2 Press in order of **Initial Setting, Initialize, TP Adjust**. The confirmation screen appears and asks "Adjust Touch Panel setting?". Press **Yes**, then the Touch Panel Adjust screen appears.
- 3 Press the center of the **X** mark, then the position of the mark changes one after another. Press five marks sequentially.

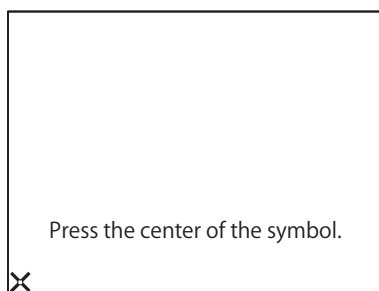

Press the center of the X mark.

This will ensure the accuracy of the touch panel operation.

- 4 When normally recognized, the confirmation screen of 2 is restored.

At procedure 3, when pressing a point away from the center of the **X** mark, a recognition error will result. Then the **X** mark returns to the initial position, then repeat the procedure of 3 again.

5 HG1P

5.1 Packing content

Before installing the HG1P, make sure that the model you have received is what you actually ordered, and no parts are damaged to accidents during shipping.

Name	HG1P
HG1P Unit	 x1
Instruction Sheet (Japanese/English)	x1
Instruction Sheet (Chinese)	x1

5.2 Part Numbers

Communication Interface	Part No.
Serial Interface (RS422/485)	HG1P-ST32YBFH-B0
Ethernet Interface	HG1P-ST32ZBFH-B0

5.3 Part Names

■ HG1P

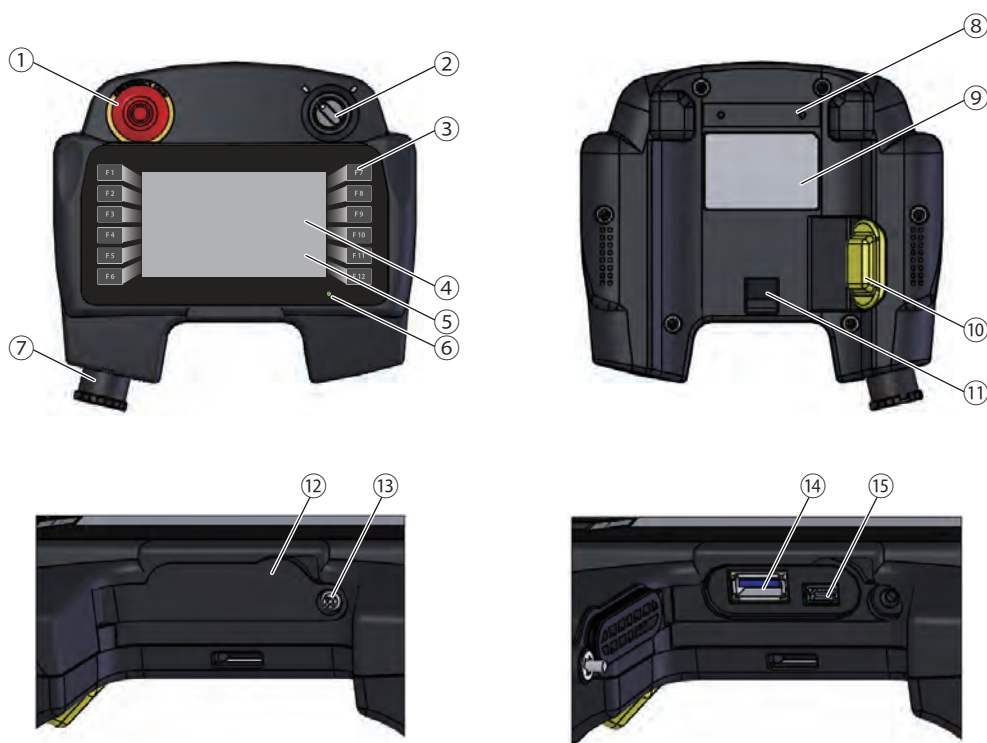

No.	Name	Description
(1)	Emergency Stop Switch	1 (external wiring)
(2)	Selector Switch	1 (external wiring)
(3)	Function Key	12 (internal wiring)
(4)	Display	TFT color LCD
(5)	Touch Panel	Analog Resistive Film
(6)	POWER LED	Green (lit) : Normal Operation (Power is on.) Not lit : Power is off.
(7)	Connector	Removable 19-pin Female Connector
(8)	Mounting Hole For Wall-Mounted Hook	Wall-mounted hook screw mounting part (2)
(9)	Nameplate	Label printed with Part number, Serial Number and Consumption Current
(10)	Enabling Switch	1 (external wiring)
(11)	Hand Strap Mounting Part	-
(12)	USB Port Cover	-
(13)	USB Port Cover Mounting Part	USB port cover screw mounting part (1)
(14)	USB Interface (USB2) ^{*1}	USB2.0 (Host) Connector : Type A
(15)	USB Interface (USB1)	USB2.0 (Device) Connector : Mini-B

*1 USB flash drive only

5.4 External Interfaces

! CAUTION

- **Make sure to turn off the power to the HG1P before inserting or pulling the cable into or out of the connector.**
- **Communication interface specifications vary based on the model number.**

Communication Interface Specifications	HG1P-ST32YBFH-B0 : Serial Interface (RS422/485) HG1P-ST32ZBFH-B0 : Ethernet Interface
Connector	Removable 19-pin Female Connector
Part Number (Manufacturer)	CA-19P1N126Y00 (PHOENIX CONTACT)

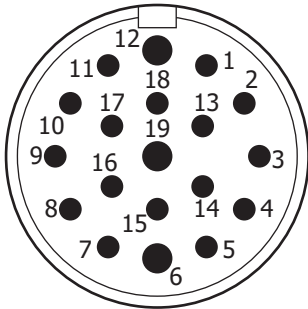

View of mating surface of the removable connector

No.	Name	Function
1	C_NC1	Selector Switch Contact 1 (NC)
2	C_NO1	Selector Switch Contact 1 (NO)
3	B_C1	Enabling Switch Contact 1 (COM)
4	B_C2	Enabling Switch Contact 2 (COM)
5	B_NO2	Enabling Switch Contact 2 (NO)
6	FG	Frame Ground
7	RDA+/TP1+	Receive Data (+)
8	RDB-/TP1-	Receive Data (-)
9	SDB-/TP0-	Send Data (-)
10	A_NC21	Emergency Stop Switch Contact 2 (NC)
11	A_NC22	Emergency Stop Switch Contact 2 (NC)
12	DC24V-	HG1P 24V DC Power Supply (-)
13	C_C1	Selector Switch Contact 1 (COM)
14	B_NO1	Enabling Switch Contact 1 (NO)
15	SG	Communication Signal Ground
16	SDA+/TP0+	Send Data (+)
17	A_NC11	Emergency Stop Switch Contact 1 (NC)
18	A_NC12	Emergency Stop Switch Contact 1 (NC)
19	DC24V+	HG1P 24V DC Power Supply (+)

5.5 Specifications

CAUTION

The following specifications are when the HG1P optional cable, specified by IDEC, is attached.

■ Applicable Standards

Safety Standards	UL61010-1 UL61010-2-201 CSA C22.2 No.61010-1 (c-UL) CSA C22.2 No.61010-2-201 (c-UL)
EMC Standards*1	IEC/EN 61131-2 FCC

■ Environmental Specifications

Operating Temperature	0 to +45°C
Operating Humidity	10 to 90% RH (no condensation)
Storage Temperature	-10 to +60°C
Storage Humidity	10 to 90% RH (no condensation)
Altitude and Atmospheric Pressure	Up to 2000m (RUN) 750 to 1060hPa
Pollution Degree	2
Corrosion Immunity	Free from corrosive gases

■ Electrical Specifications

Rated Voltage	24V DC
Power Consumption	3W maximum When not using USB Interface (USB2): 2W maximum
Power Voltage Range	20.4 to 28.8V DC
Allowable Momentary Power Interruption	10 ms maximum
Inrush Current	20A maximum
Dielectric Withstand Voltage	AC500V, 10mA, 1 minute (between power and ground terminals)

■ Construction Specifications

Vibration	5 to 8.4Hz amplitude 3.5mm, 8.4 to 150Hz acceleration 9.8m/s ² 1 octave 10 minutes 10 times on each of three mutually perpendicular axes (100 minutes) (IEC61131-2)
Shock	147m/s ² , 11ms (5 shocks on each of three mutually perpendicular axes) (IEC61131-2)
Dropping	1.5 m, 6 directions, 1 time
Connector Insertion Life	HG1P Optional Cable: 100 times USB1: 5000 times USB2: 1500 times

*1 When using the HG1P-ST32ZBFH-B0 with **Connect Speed of 10/100 Mbps** as the EMC Standard Approved Products, attach the recommended ferrite cores (2 pieces) near the connector for HG1P of the HG1P optional cable, and fasten them to the cable with the clamp bands.

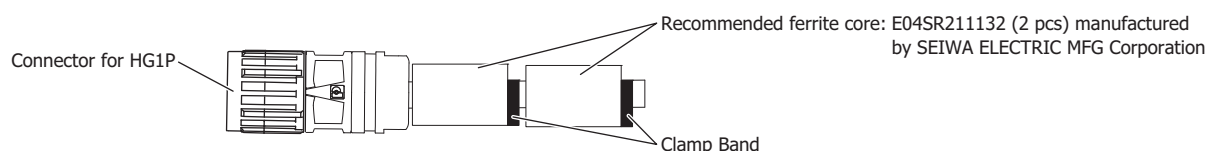

■ Performance Specifications

Display	LCD Type	TFT color LCD
	Display Colors	65536 Colors
	Effective Display Area	95.04 (W) × 53.856 (H) mm
	Display Resolution	480 (W) × 272 (H) dots
	View angle	Left/Right: 80°, Top: 65°, Bottom: 55°
	Brightness of LCD only	400 cd/m ²
	Brightness Adjustment	32 levels
	Backlight	White LED (It cannot be replaced)
	Backlight Life* ²	Approx. 30,000 hours (The time until brightness becomes 50% of the initial value)
Touch Panel	Switch Type	Analog Resistive Film
	Operating Force	3N maximum
	Multiple Operations	Impossible
	Life	1,000,000 operations
User Memory	12MB	
Clock Function* ³	Year, Month, Day, Hour, Minute, Second, Day-of-week ±90 seconds per month	
Buzzer output	Single tone (tone length is adjustable)	
Degree of Protection	IP54 (When HG1P optional cable is attached* ⁴)	
Weight	Approx. 500g (without HG1P optional cable)	
Housing color	Dark gray	

■ Communication Specifications

Serial Interface (RS422/485)	Communication Speed	187500, 115200, 57600, 38400, 19200, 9600, 4800, 2400, 1200 bps
	Communication Distance	20m maximum
	Synchronization	Asynchronous
Ethernet Interface	Interface Specification	IEEE802.3i, IEEE802.3u
	Connect Speed	10Mbps, 10/100Mbps

*2 The life of the LCD is specified an ambient temperature of 25°C. This is not a guaranteed value. The actual life depends on the environment and conditions of use.

*3 The HG1P has no backup battery, therefore, time data is deleted when the HG1P is turned off.

*4 The connector for the external device is not guaranteed.

■ EMC Specifications

Radiated Emission	<p>Class A : 10m</p> <ul style="list-style-type: none"> •IEC 61000-6-4 Class A 40dBμV/m quasi-peak (30M to 230MHz) 47dBμV/m quasi-peak (230M to 1GHz) •FCC Class A 39dBμV/m quasi-peak (30M to 88MHz) 43.5dBμV/m quasi-peak (88M to 216MHz) 46.4dBμV/m quasi-peak (216M to 960MHz) 49.5dBμV/m quasi-peak (960M to 1GHz)
Electrostatic Discharge	<p>Contact : \pm4kV</p> <p>Air : \pm8kV</p>
Electromagnetic Field	<p>10V/m (80M to 1.0GHz)</p> <p>3V/m (1.4G to 2.0GHz)</p> <p>1V/m (2.0G to 2.7GHz)</p> <p>80% AM (1kHz)</p>
Fast Transient Burst	<p>Power : \pm2kV</p> <p>Communication cable : \pm1kV</p>
Surge Immunity	<p>\pm500V (+24V and 0V)</p> <p>\pm1kV (+24V and FE, 0V and FE)</p>
Conducted Radio Frequency Immunity	<p>3V (Power, Communication cable)</p> <p>(150k to 80MHz)</p> <p>80% AM (1kHz)</p>

■ Switch Specifications

Function Keys

Model		Tactile Switch
Number Equipped		12
Contact		Normally open contact
Internal Devices	Device Name	HMI Expansion Input (Bit)
	Symbol	LI
	R/W	R



R/W is an abbreviation of Read/Write. R/W indicate that both reading and writing are possible, while R indicates that only reading is possible.



No.	Name	HMI Expansion Input (Bit) Assignment
1	F1	LI0
2	F2	LI1
3	F3	LI2
4	F4	LI3
5	F5	LI4
6	F6	LI5
7	F7	LI6
8	F8	LI7
9	F9	LI8
10	F10	LI9
11	F11	LIA
12	F12	LIB

The function keys are written to HMI Expansion Inputs (LI) as momentary switches with normally open contacts.

- Momentary

Pressing the button writes a 1 to the HMI Expansion Input (LI).

Pressing the button writes a 0 to the HMI Expansion Input (LI).

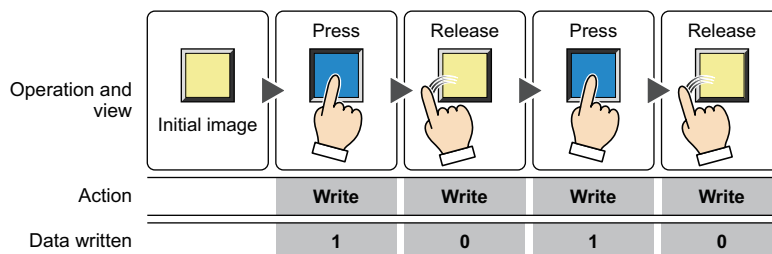

• Reading the State of Function Keys

The HG1P reads the state of the function keys once approximately every 20 ms, and those states are applied to the HMI Expansion Inputs (LI).

When the state of a function key is ON two consecutive times, the HG1P recognizes that the key has been pressed, and it processes the read result and makes an ON judgment. When the state of a function key is OFF even once, the HG1P recognizes that the key has been released, and it processes the read result and makes an OFF judgment.

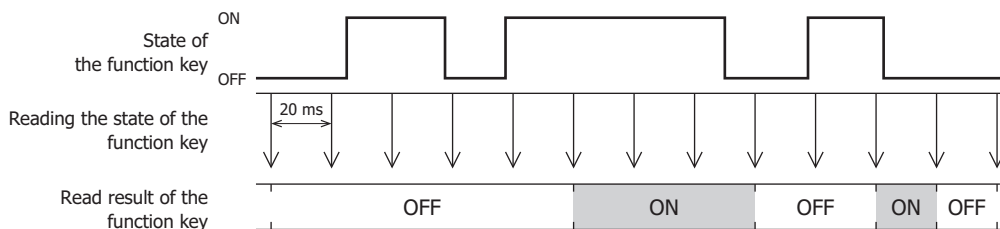

Time to judge the state of the function key

The time from reading the state of the function key to when the result is judged is as follows.

	OFF→ON	ON→OFF
Maximum	41 ms	20 ms



While executing transmitting and receiving processing for user communications, the time required for the HG1P to process the read result and make an ON judgment will increase because the read processing for function keys is executed after communication processing has completed.

Time to apply the read results to HMI Expansion Inputs (LI)

For function key inputs, the latest read results when the scan for the screen ends are applied to HMI Expansion Inputs (LI) at that time.

When there is a change in the state of a function key, the time until the read result is applied to the HMI Expansion Input (LI) is as follows.

Minimum: 21 ms

Maximum: 39 ms + Scan time (HMI Special Data Register LSD4)



The longer it takes for display processing and part processing, the longer it will take to apply the read results to the HMI Expansion Inputs (LI).

Emergency Stop Switch



- Use the emergency stop switch through the HG1P optional cable as a control signal for external devices.
- Consider counter-measures for switch bouncing because bouncing will occur during reset operation.
- Be careful with the switch. If the switch is subjected to excessive shocks or vibrations, it may deform or become damaged, chattering may occur, operation may fail, or performance may become degraded.

Part Number (Manufacturer)	AB6E-3BV02PRM (IDEC)
Number Mounted	1
Contact	2NC (external wiring)
Contact Rating	1A/DC30V
Damage Limits	Mechanical: 100,000 operations minimum Electrical: 100,000 operations minimum
Reset Operation	Pull or Turn reset

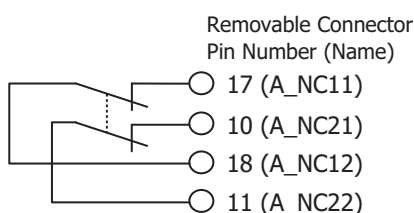

Enabling Switch

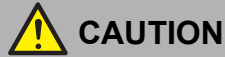

CAUTION

- Use the enabling switch through the HG1P optional cable as a control signal for external devices.
- Build the system so that the machine operates only in position 2.
- Use the two contacts of the enabling switch as inputs for a mismatch detection circuit (safety relay module, etc.).
- The two contacts have been constructed to work independently of each other. For this reason, a time lag may occur in the operation of the two contacts when the button is pressed to the edge. When wiring the contacts to two inputs so that they are monitored mutually, design the sequence control to take into consideration this time difference.

Part Number (Manufacturer)	HE6B-M200Y (IDEC)
Number Mounted	1
Contact	2 contacts (external wiring)
Contact Rating	0.7A/DC30V
Monitoring Contact	None
Damage Limits	Mechanical: Position 1→2→1: 1,000,000 operations minimum Position 1→2→3→1: 100,000 operations minimum Electrical: 100,000 operations minimum

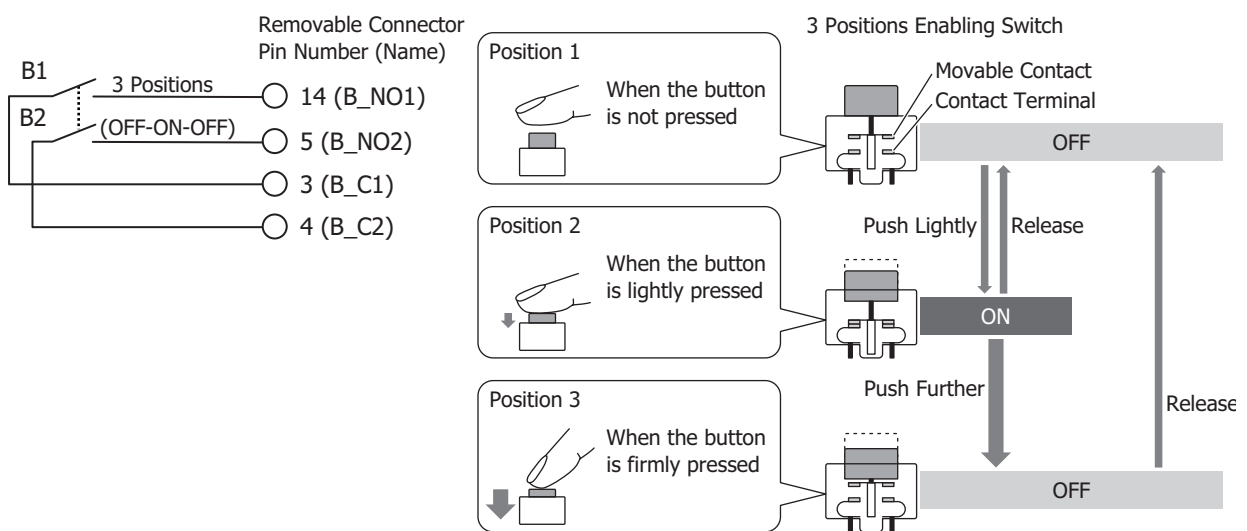

Selector Switch (φ16 or Non-Illuminated model)

Use the selector switch through the HG1P optional cable as a control signal for external devices.

Part Number (Manufacturer)	LB6S-2T1 (IDEC)
Number Mounted	1
Contact	SPDT (external wiring)
Contact Rating	0.1A/DC30V (resistance load)
LED	Non-Illuminated
Damage Limits	Mechanical: 250,000 operations minimum Electrical: 100,000 operations minimum
Switching detent	90° - 2-positions
Specification	Stops at all positions (manual)

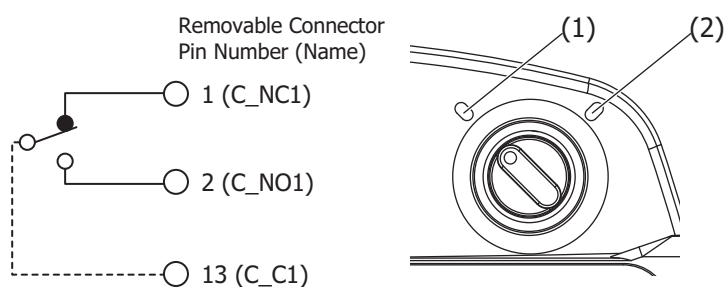

When at position (1), pin 1 (C_NC1) and pin 13 (C_C1) are connected.

When at position (2), pin 2 (C_NO1) and pin 13 (C_C1) are connected.

5.6 Dimensions

Unit: mm

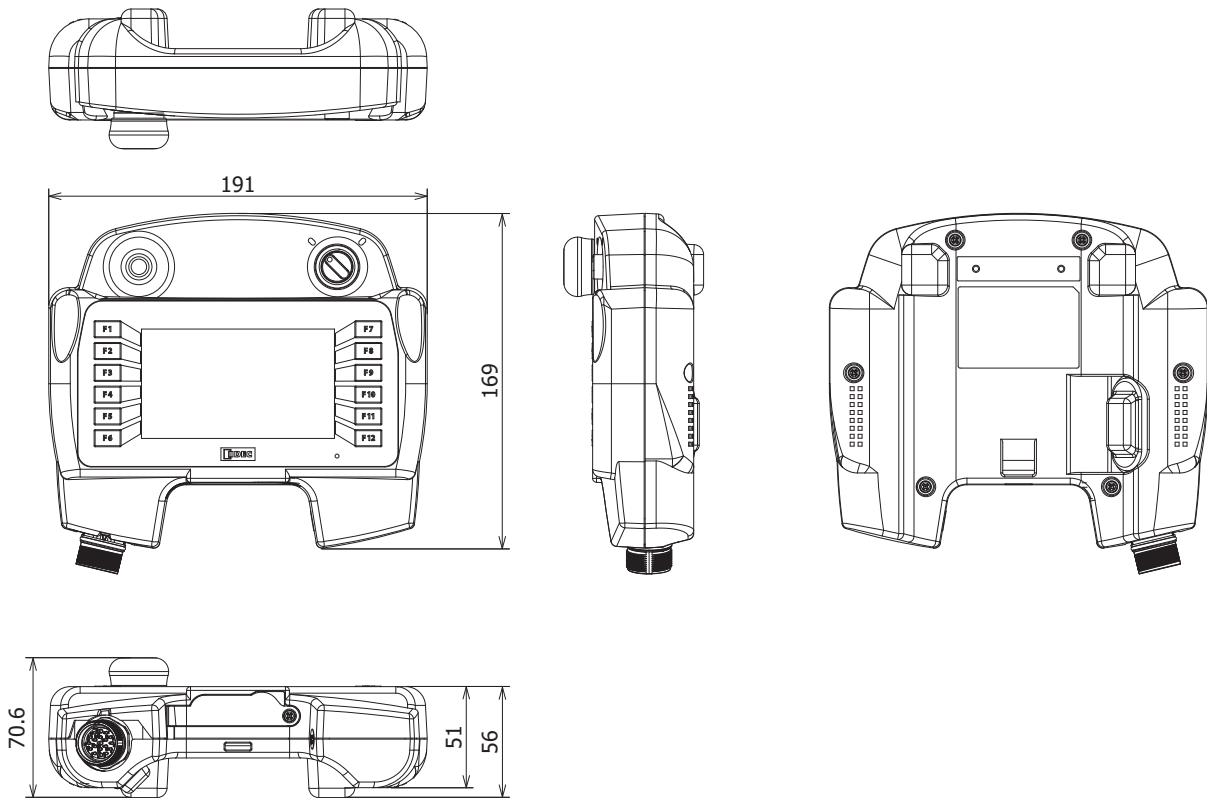

<Cable Dimensions>

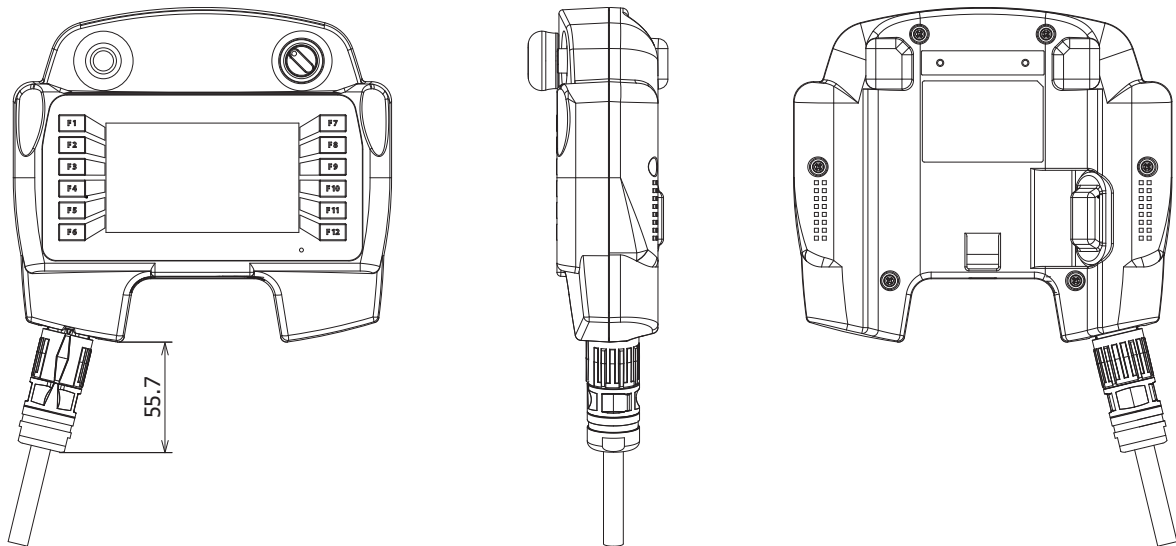

5.7 Installation

● Operating Environment

- For designed performance and safety of the HG1P, do not install the HG1P in the following environments:
 - Where dust, briny air, or iron powder exist.
 - Where oil or chemical splashes for a long time.
 - Where space is filled with oil mist.
 - Where direct sunlight falls on the HG1P.
 - Where strong ultraviolet rays fall on the HG1P.
 - Where corrosive or combustible gasses exist.
 - Where shocks or vibrations are transmitted.
 - Where condensation occurs due to rapid temperature change.
 - Where high-voltage or arc-generating equipment (electromagnetic contactors or circuit protectors) exists in close proximity.
 - Near devices that generate a lot of heat. Such as a boiler.
- Use the wall-mounted hook (optional item) for wall mounting.

● HG1P Installation

Attaching the Optional Cable (HG9Z-XCP13/-XCP15/-XCP17) to the HG1P



CAUTION

- **Make sure to turn off the HG1P's power before inserting or pulling the cable into or out of the connector.**
- **After locking the connector, gently tug on the cable to make sure that the connector does not come off.**
- **Do not apply an excessive tensile load to the cable, otherwise damage of the connector will result.**

- 1 Turn the connector cap.
- 2 Pull off the connector cap.

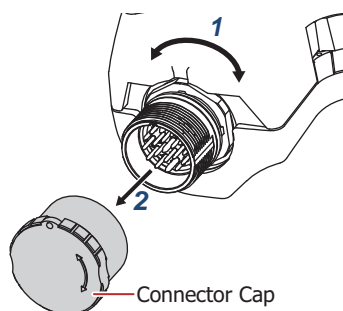

- 3 Turn the connector at the end of the HG1P optional cable to align the "open" text with the logo.
- 4 Align the connector at the end of the HG1P optional cable with the mating positioning mark, and then push it straight on until the rubber (black) is completely covered.

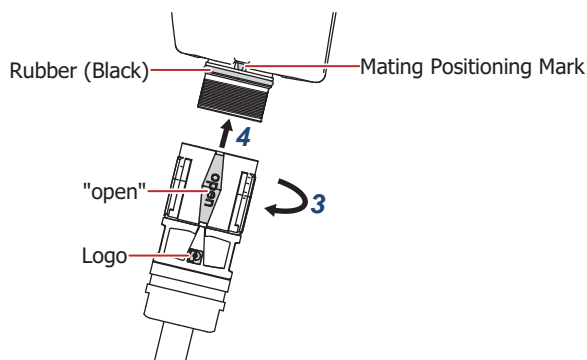

- 5 Turn the shaded portion of the connector clockwise 90°.

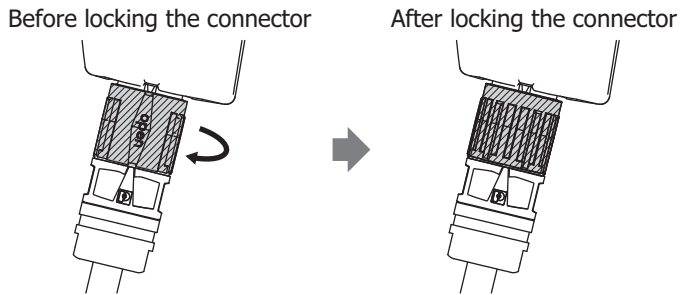

The connector will stop turning at 90°. Do not try to turn it past 90°.

Removing and Installing the USB Port Cover



CAUTION

- When attaching the cover, tighten the screw to the recommended tightening torque (0.6 N·m).
- When installing the HG1P, make sure that the gasket is not twisted. Because any twisting in the gasket will impair the waterproof characteristics.

■ Removing the USB Port Cover

Unscrew the USB port cover screw with a Phillips screwdriver, and then pull the USB port cover outward to open it.

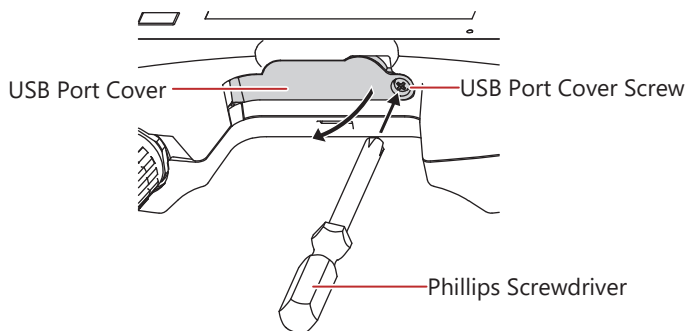

Only one side of the USB port cover opens.

Be careful when opening the USB port cover because the part that opens may be damaged if excessive force is used.

Do not remove the USB port cover screw from the USB port cover.

■ Installing the USB Port Cover

Recommend tightening torque while keeping it from lifting up from the case.

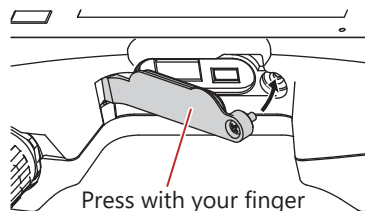

Installing the Hand Strap (HG9Z-PS4)

- 1 Pass the hand strap through the hand strap mounting part.

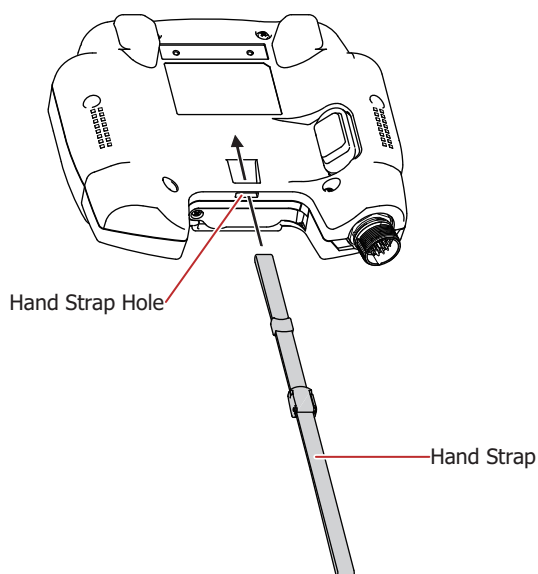

- 2 Pass the end of the strap through the loop, keep holding the end, and pull it tight.

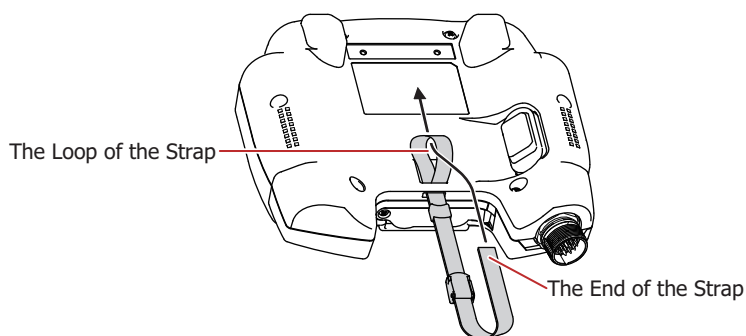

Be careful when pulling the strap tight because the strap may be damaged if excessive force is used.

Installing the Wall-Mounting Hook (HG9Z-PK3)

- 1 Fit the indented surface of the wall-mounted hook into the HG1P.
- 2 Use the wall-mounted hook screws (M3×10), and tighten in two locations to the recommended tightening torque (0.6 N·m).

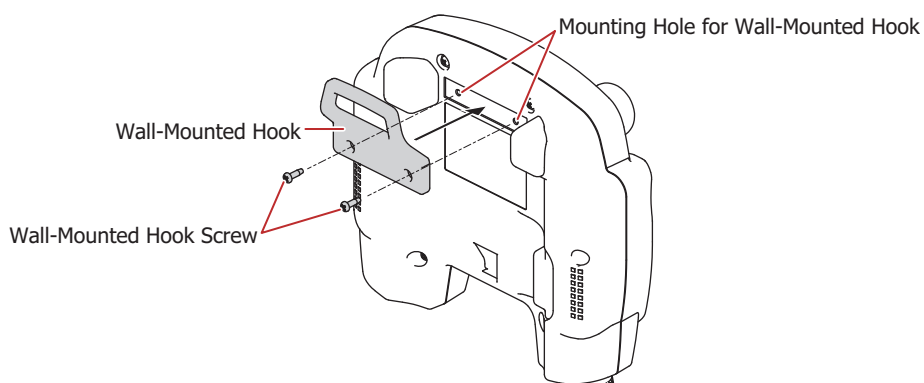

5.8 Wiring

! CAUTION

- Turn off the power supply before wiring.
- Make the wiring as short as possible and run all wires as far away as possible from high-voltage and large-current cables. Follow all the procedures and precautions when wiring the HG1P.
- Separate the HG1P power supply wiring from the power lines of I/O devices and motor equipment.
- Connect the functional ground terminal to make sure of correct operation.

● HG1P Optional Cable (HG9Z-XCP13/-XCP15/-XCP17)

This cable connects the HG1P and external devices.

■ Specifications

Communication Interface	Serial Interface (RS422/485) or Ethernet Interface
Connector for the External Devices	D-sub 25-pin Male Connector (Jackscrew M2.6)
Length	3m, 5m, 7m

■ Outline Drawing

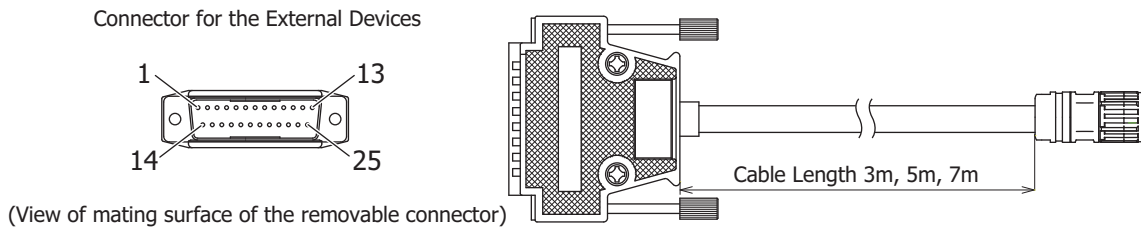

■ Connector Wiring Table

No.	Name	Function
1	FG	Frame Ground
2	RDB-/TP1-	Receive Data (-)
3	RDA+/TP1+	Receive Data (+)
4	SDB-/TP0-	Send Data (-)
5	SDA+/TP0+	Send Data (+)
6	SG	Communication Signal Ground
7	NC	-
8	NC	-
9	B_NO1	Enabling Switch Contact 1 (NO)
10	B_C1	Enabling Switch Contact 1 (COM)
11	A_NC11	Emergency Stop Switch Contact 1 (NC)
12	A_NC12	Emergency Stop Switch Contact 1 (NC)
13	DC24V-	HG1P 24V DC Power Supply (-)

No.	Name	Function
14	NC	-
15	NC	-
16	NC	-
17	NC	-
18	C_NC1	Selector Switch Contact 1 (NC)
19	C_NO1	Selector Switch Contact 1 (NO)
20	C_C1	Selector Switch Contact 1 (COM)
21	B_NO2	Enabling Switch Contact 2 (NO)
22	B_C2	Enabling Switch Contact 2 (COM)
23	A_NC21	Emergency Stop Switch Contact 2 (NC)
24	A_NC22	Emergency Stop Switch Contact 2 (NC)
25	DC24V+	HG1P 24V DC Power Supply (+)

- **HG1P Debug Cable (HG9Z-PX12)**
This cable is the debug cable. Use this cable only for debugging.

■ **Cable Specification**

Structure		Double shield cable
Configuration		AWG25 x 2 Pair AWG23 x 5 Cores
Conductor	Configuration	40N/0.08mm(Pair), 60N/0.08mm(Cores)
Insulator	Material	PVC
	Thickness	0.16mm(Pair), 0.145mm(Cores)
	Outer Diameter	0.9mm(Pair), 1.0mm(Cores)
Sheath	Outer Diameter	7.0 mm

■ **Outline Drawing**

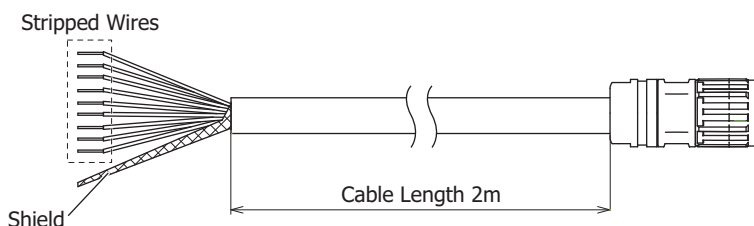

■ **Sectional View**

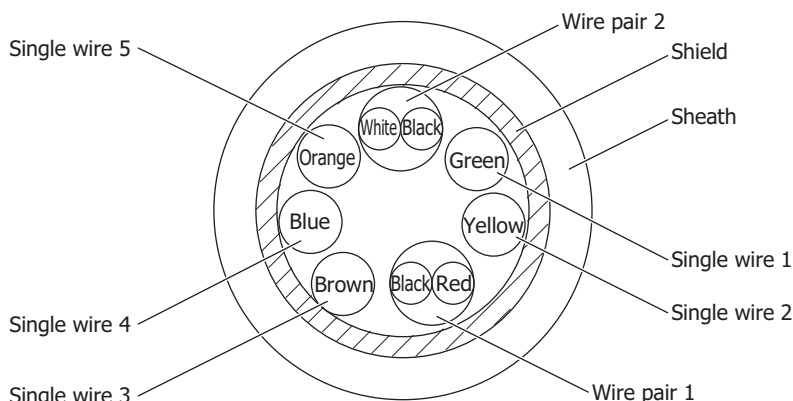

■ **Wiring Table**

No.	Name	Function	Cable Color
1	RDA+/TP1+	Receive Data (+)	Wire pair 1 : Black
2	RDB-/TP1-	Receive Data (-)	Wire pair 1 : Red
3	SDA+/TP0+	Send Data (+)	Wire pair 2 : Black
4	SDB-/TP0-	Send Data (-)	Wire pair 2 : White
5	FG	Frame Ground	Single wire 1 : Green
6	SG	Communication Signal Ground	Single wire 2 : Yellow
7	DC24V+	HG1P 24V DC Power Supply (+)	Single wire 3 : Brown
8	NC	-	Single wire 4 : Blue
9	DC24V-	HG1P 24V DC Power Supply (-)	Single wire 5 : Orange

5.9 Maintenance and Inspection

Maintain and inspect the HG1P periodically to ensure it is in peak condition. Do not disassemble, repair, or modify the HG1P during inspection.

Maintenance and Inspection Parts	Description
Display	Wipe any stain of the display using a soft cloth slightly dampened with neutral detergent or alcoholic solvent. Do not use solvents such as thinner, ammonia, strong acid, and strong alkaline.
Removable Connector	Check the terminals and connectors to make sure of incomplete insertion or disconnected lines.
USB Port Cover	Make sure of no loose screws, or no twisted gasket.
Wall-Mounted Hook	Make sure of no loose screws.
Backlight	The HG1P's backlight cannot be replaced.
Touch Panel	A gap may be caused in the operation accuracy of the touch panel by the secular distortion, etc. Readjust the touch panel in the System Mode according to the following procedure when there is a gap in the operation of the touch panel. Refer to "Adjusting the Touch Panel" on page 35-88 for details.

● Maintenance Screen

Turn on the power to the HG1P, then press and hold the touch panel on the upper-left corner of the screen for three seconds or longer. The Maintenance Screen appears on the screen.

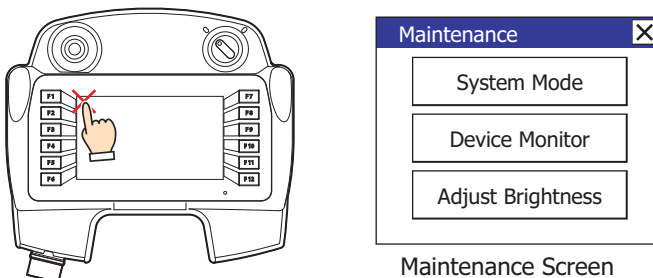

- Permission to show the Maintenance Screen can be set using the WindO/I-NV4. Refer to Chapter 4 "3.1 System Tab" on page 4-25 for details.
- The Maintenance Screen is not displayed in the System Mode.

● System Mode

Press the [System Mode] at the top of the Maintenance Screen. The Top page Screen appears.

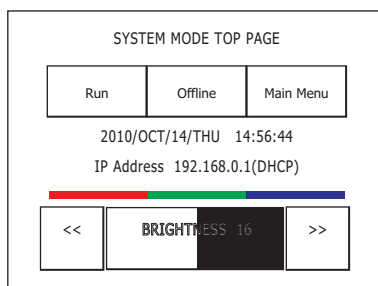

Initial Setting, Self Diagnosis and Initialization of the data, etc can be executed in the System mode.

● Adjusting the Brightness

The brightness of the HG1P display can be adjusted on the Adjust Brightness Screen.

- 1 Press the [Adjust Brightness] at the bottom of the Maintenance Screen. The Adjust Brightness Screen appears.

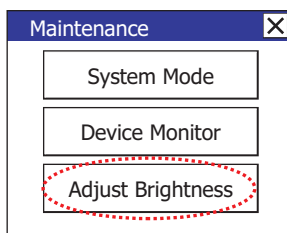

- 2 Press the [<<] and [>>] at the bottom the Adjust Brightness Screen to adjust the brightness to the optimal setting.

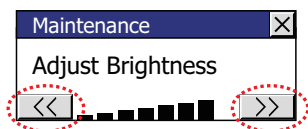

- 3 Press the [X] to close the Adjust Brightness Screen.



To adjust the brightness in the System Mode, use the [<<] and [>>] buttons located at the bottom of the Top Page.

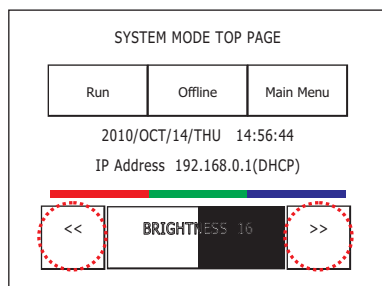

● Adjusting the Touch Panel

A gap may be caused in the operation accuracy of the touch panel by the secular distortion, etc. Adjust the touch panel according to the following procedure when there is a gap in the operation of the touch panel.

- 1 Press the [Main Menu] on the Top Page in System Mode. The Main Menu Screen appears.

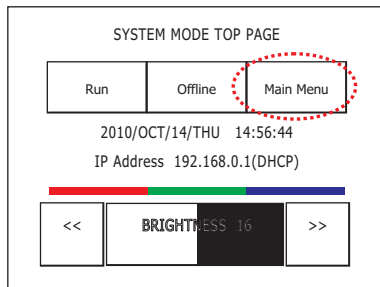

- 2 Press in order of **Initial Setting, Initialize, TP Adjust**. The confirmation screen appears and asks "Adjust Touch Panel setting?". Press **Yes**, then the Touch Panel Adjust screen appears.
- 3 Press the center of the **X** mark, then the position of the mark changes one after another. Press five marks sequentially.

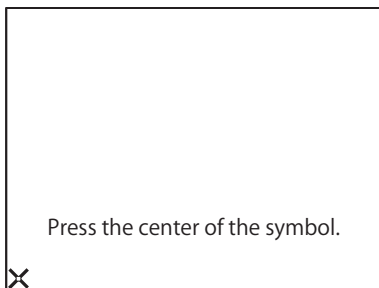

Press the center of the X mark.

This will ensure the accuracy of the touch panel operation.

- 4 When recognized, confirmation screen 2 is restored.

At procedure 3, when pressing a point away from the center the **X** mark, a recognition error will result. Then the **X** mark returns to the initial position, then repeat the procedure of 3 again.

6 Options

6.1 Optional items

- HG2J-7U

Name	Type No.	Description
USB Panel-Mount Extension Cable	HG9Z-XCE11	Extension cable for attaching to USB2 (Type-A) port on front panel Length: 1m
PLC Connection Cable	FC2A-KP1C	For IDEC FC4A/5A MICROSmart Length: 2.4m <Connector> MICRO/I: Parted Wire Host: Mini DIN 8-pin
	HG9Z-XC275	For IDEC FC4A/5A MICROSmart Length: 5m <Connector> MICRO/I: Parted Wire Host: Mini DIN 8-pin
	FC6A-KC1C	For IDEC FC6A MICROSmart (FC6A-C*****E only) Length: 5m <Connector> MICRO/I: Parted Wire Host: RJ45
Protective Film*1	HG9Z-2D7PN05	For HG2J-7U 5 pcs/pack

*1 No UV resistant.

● HG5G/4G/3G/2G-V

Name	Type No.	Description	HG5G-V	HG4G-V	HG3G-V	HG2G-V
Maintenance Cable	HG9Z-XCM42	USB cable to connect to a computer Length: 2m <Connector> MICRO/I: USB Mini-B Computer: USB Type-A	YES	YES	YES	YES
USB Panel-Mount Extension Cable	HG9Z-XCE11	Extension cable for attaching to USB2 (Type-A) port on front panel Length: 1m	YES	YES	YES	YES
	HG9Z-XCE21	Extension cable for attaching to USB1 (Mini-B) port on front panel Length: 1m	YES	YES	YES	YES
PLC Connection Cable	FC2A-KP1C	For IDEC FC4A/5A MICROSmart Length: 2.4m <Connector> MICRO/I: Parted Wire Host: Mini DIN 8-pin	YES	YES	YES	YES
	HG9Z-XC275	For IDEC FC4A/5A MICROSmart Length: 5m <Connector> MICRO/I: Parted Wire Host: Mini DIN 8-pin	YES	YES	YES	YES
	HG9Z-XC295	For IDEC FC4A/5A MICROSmart Communication Mode: RS232C Length: 5m <Connector> MICRO/I: D-sub 9-pin Host: Mini DIN 8-pin	YES	YES	YES	YES
	FC6A-KC1C	For IDEC FC6A MICROSmart (FC6A-C*****E only) Length: 5m <Connector> MICRO/I: Parted Wire Host: RJ45	YES	YES	YES	YES
	FC6A-KC2C	For IDEC FC6A MICROSmart (FC6A-C*****E only) Communication Mode: RS232C Length: 5m <Connector> MICRO/I: D-sub 9-pin Host: RJ45	YES	YES	YES	YES
	HG9Z-XC305	For Mitsubishi FX series direct connection Communication Mode: RS422 Length: 5m <Connector> MICRO/I: D-sub 9-pin Host: Mini DIN 8-pin	YES	YES	YES	YES
	HG9Z-XC315	For Mitsubishi Q series direct connection Communication Mode: RS232C Length: 5m <Connector> MICRO/I: D-sub 9-pin Host: Mini DIN 6-pin	YES	YES	YES	YES

Name	Type No.	Description	HG5G-V	HG4G-V	HG3G-V	HG2G-V
Protective Sheet *1	HG9Z-5DFPN01	For HG5G-V 2 pcs/pack	YES	NO	NO	NO
	HG9Z-4DCPN02	For HG4G-V 2 pcs/pack	NO	YES	NO	NO
	HG9Z-3DA2PN02	For HG3G-VA 2 pcs/pack	NO	NO	YES	NO
	HG9Z-3D8PN02	For HG3G-V8 2 pcs/pack	NO	NO	YES	NO
	HG9Z-2D5PN05	For HG2G-V 5 pcs/pack	NO	NO	NO	YES
Protective Cover	HG9Z-2E2PN03	For HG2G-V To Cover the front of MICRO/I 3 pcs/pack	NO	NO	NO	YES
Expansion Module Clamp	HG9Z-XJ3PN05	For installing the expansion modules on the back of the MICRO/I (Short). 5 pcs/pack For total width 17.6 to 41.1 mm.	YES	YES	YES	YES
	HG9Z-XJ4PN05	For installing the expansion modules on the back of the MICRO/I (Long). 5 pcs/pack For total width 47.0 to 69.4 mm.	YES	YES	YES	YES
	HG9Z-XJ5PN05	For installing the expansion modules on the back of the MICRO/I (Extra-Long). 5 pcs/pack For total width 70.5 to 93.0 mm.	YES	YES	YES	NO

● HG4G/3G, HG2G-5F/-5T, HG1G

Name	Type No.	Description	HG4G	HG3G	HG2G-5F	HG2G-5T	HG1G
Maintenance Cable	HG9Z-XCM42	USB cable to connect to a computer Length: 2m <Connector> MICRO/I: USB Mini-B Computer: USB Type-A	YES	YES	YES	YES	YES
USB Panel-Mount Extension Cable	HG9Z-XCE11	Extension cable for attaching to USB2 (Type-A) port on front panel Length: 1m	YES	YES	YES	YES	YES
	HG9Z-XCE21	Extension cable for attaching to USB1 (Mini-B) port on front panel Length: 1m	YES	YES	YES	YES	YES
PLC Connection Cable	FC2A-KP1C	For IDEC FC4A/5A MICROSmart Length: 2.4m <Connector> MICRO/I: Parted Wire Host: Mini DIN 8-pin	YES	YES	YES	YES	YES
	HG9Z-XC275	For IDEC FC4A/5A MICROSmart Length: 5m <Connector> MICRO/I: Parted Wire Host: Mini DIN 8-pin	YES	YES	YES	YES	YES

*1 The protective sheet is UV resistant, however, resistance against direct sunlight in outdoor usage is not guaranteed.

Name	Type No.	Description	HG4G	HG3G	HG2G-5F	HG2G-5T	HG1G
PLC Connection Cable	HG9Z-XC295	For IDEC FC4A/5A MICROSmart Communication Mode: RS232C Length: 5m <Connector> MICRO/I: D-sub 9-pin Host: Mini DIN 8-pin	YES	YES	YES	NO	NO
	FC6A-KC1C	For IDEC FC6A MICROSmart (FC6A-C*****E only) Length: 5m <Connector> MICRO/I: Parted Wire Host: RJ45	YES	YES	YES	YES	YES
	FC6A-KC2C	For IDEC FC6A MICROSmart (FC6A-C*****E only) Communication Mode: RS232C Length: 5m <Connector> MICRO/I: D-sub 9-pin Host: RJ45	YES	YES	YES	NO	NO
	HG9Z-XC305	For Mitsubishi FX series direct connection Communication Mode: RS422 Length: 5m <Connector> MICRO/I: D-sub 9-pin Host: Mini DIN 8-pin	YES	YES	YES	NO	NO
	HG9Z-XC315	For Mitsubishi Q series direct connection Communication Mode: RS232C Length: 5m <Connector> MICRO/I: D-sub 9-pin Host: Mini DIN 6-pin	YES	YES	YES	NO	NO
Connector Conversion Cable	HG9Z-XCT11	To convert from D-sub 25-pin to 9-pin (used when replacing from HG4F/3F/2F to HG4G/3G, HG2G-5F) Length: 16cm	YES	YES	YES	NO	NO
Protective Sheet *1	HG9Z-4DCPN02	For HG4G 2 pcs/pack	YES	NO	NO	NO	NO
	HG9Z-3DA2PN02	For HG3G-A 2 pcs/pack	NO	YES	NO	NO	NO
	HG9Z-3D8PN02	For HG3G-8 2 pcs/pack	NO	YES	NO	NO	NO
	HG9Z-2D5PN05	For HG2G-5F/-5T 5 pcs/pack	NO	NO	YES	YES	NO
	HG9Z-1D4PN05	For HG1G 5 pcs/pack	NO	NO	NO	NO	YES
Protective Cover	HG9Z-2E2PN03	For HG2G-5F/-5T To Cover the front of MICRO/I 3 pcs/pack	NO	NO	YES	YES	NO
Memory Card	HG9Z-XMS2	SD memory card (2GB, Class6)	YES	YES	YES	NO	NO

*1 The protective sheet is UV resistant, however, resistance against direct sunlight in outdoor usage is not guaranteed.

Name	Type No.	Description	HG4G	HG3G	HG2G -5F	HG2G -5T	HG1G
Expansion Module Clamp	HG9Z-XJ3PN05	For installing the expansion modules on the back of the MICRO/I (Short). 5 pcs/pack For total width 17.6 to 41.1 mm.	YES	YES	YES	NO	NO
	HG9Z-XJ4PN05	For installing the expansion modules on the back of the MICRO/I (Long). 5 pcs/pack For total width 47.0 to 69.4 mm.	YES	YES	YES	NO	NO
	HG9Z-XJ5PN05	For installing the expansion modules on the back of the MICRO/I (Extra-Long). 5 pcs/pack For total width 70.5 to 93.0 mm.	YES	YES	NO	NO	NO
L-shaped Terminal Block Connector for I/O Module	HG9Z-PMT10LPN02	For MicroSmart I/O Module (10-pole) 2 pcs/pack	YES	YES	YES	NO	NO
	HG9Z-PMT11LPN02	For MicroSmart I/O Module (11-pole) 2 pcs/pack	YES	YES	YES	NO	NO

● HG1P

Name	Type No.	Description
Maintenance Cable	HG9Z-XCM42	USB cable to connect to a computer Length: 2m <Connector> HG1P: USB Mini-B Computer: USB Type-A
HG1P Optional Cable	HG9Z-XCP13	Communication Mode: RS422/485 or Ethernet Length: 3m <Connector> HG1P: CA-19S1N128007S Host: D-sub 25-pin Male Connector
	HG9Z-XCP15	Communication Mode: RS422/485 or Ethernet Length: 5m <Connector> HG1P: CA-19S1N128007S Host: D-sub 25-pin Male Connector
	HG9Z-XCP17	Communication Mode: RS422/485 or Ethernet Length: 7m <Connector> HG1P: CA-19S1N128007S Host: D-sub 25-pin Male Connector
HG1P Debug Cable	HG9Z-PX12	Length: 2m <Connector> HG1P: CA-19S1N128007S Host: Twisted Wire
Hand Strap	HG9Z-PS4	Wrist strap 1 pc/pack
Wall-Mounted Hook	HG9Z-PK3	Hook attached to the rear of the case 1 pc/pack Includes two installation screws

External Dimensions

■ **Hand Strap (HG9Z-PS4)**

Unit: mm

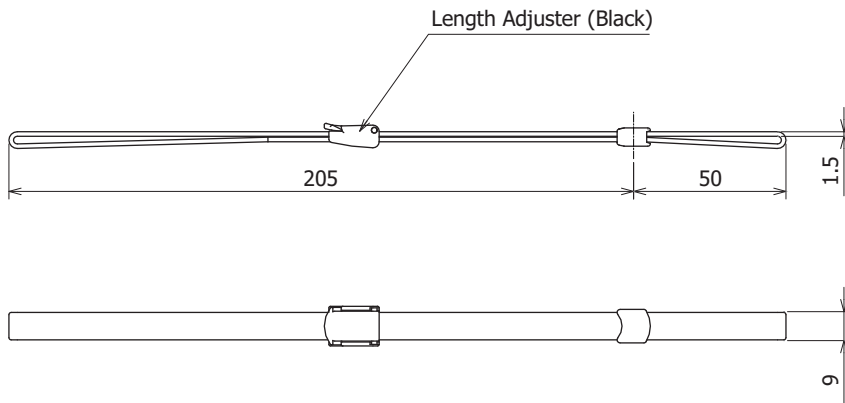

■ **Wall-Mounted Hook (HG9Z-PK3)**

Unit: mm

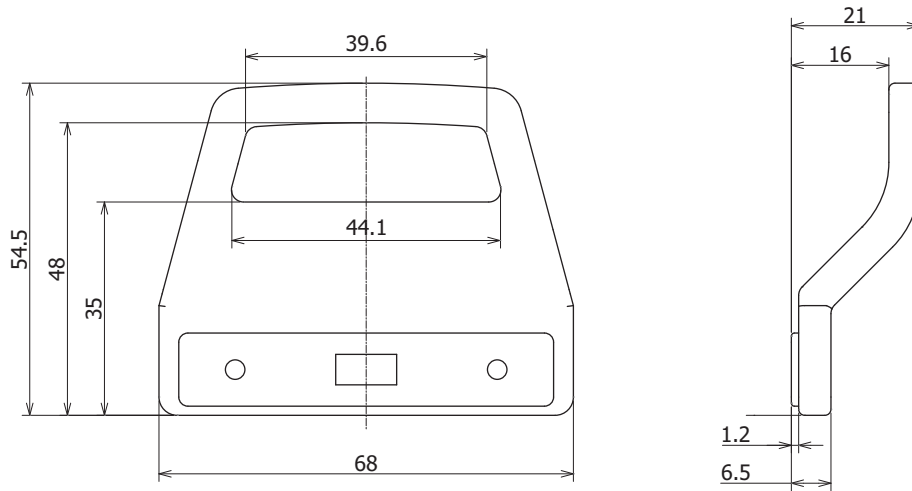

6.2 Replacement Parts

● HG2J-7U

Name	Type No.	Description
Mounting Clip	HG9Z-4K2PN04	For HG2J-7U, HG4G/3G, HG1G 4 pcs/pack
Communication Plug for external devices	HG9Z-XT09P	Vertical type

● HG5G/4G/3G/2G-V

Name	Type No.	Description	HG5G-V	HG4G-V	HG3G-V	HG2G-V
Mounting Clip	HG9Z-4K2PN06	For HG5G-V 6 pcs/pack	YES	NO	NO	NO
	HG9Z-4K2PN04	For HG4G/3G-V 4 pcs/pack	NO	YES	YES	NO
	SLD-K02PN10	For HG2G-V 10 pcs/pack	NO	NO	NO	YES
Replacement Battery	HG9Z-XR1	Coin type lithium manganese dioxide battery CR2032W	YES	YES	YES	YES
Communication Plug for external devices	HG9Z-XT09	Right angle type	YES	YES	YES	NO
	HG9Z-XT09V	Vertical type	NO	NO	NO	YES
USB Cable Lock Pin	HG9Z-XU1PN05	For USB2 (Type A) port 5 pcs/pack	YES	YES	YES	YES

● HG4G/3G, HG2G-5F/-5T, HG1G

Name	Type No.	Description	HG4G	HG3G	HG2G-5F	HG2G-5T	HG1G
Mounting Clip	HG9Z-4KPN04	For HG4G/3G, HG1G 4 pcs/pack	YES	YES	NO	NO	YES
	SLD-K02PN10	For HG2G-5F/-5T 10 pcs/pack	NO	NO	YES	YES	NO
Replacement Battery	HG9Z-XR1	Coin type lithium manganese dioxide battery CR2032	YES	YES	YES	YES	YES
Communication Plug for external devices	HG9Z-XT09	Right angle type	YES	YES	NO	NO	NO
	HG9Z-XT09V	Vertical type	NO	NO	YES	YES	YES
USB Cable Lock Pin	HG9Z-XU1PN05	For USB2 (Type A) ^{*1} port 5 pcs/pack	YES	YES	YES	YES	YES

● HG1P

There are no replacement parts.

*1 USB1(Mini-B) can be used for HG1G only.

7 About the Warranty of the products

7.1 Warranty Period

The Products are warranted for 3 years from the date of purchase, or from the date of delivery completion.

* Consumable/maintenance parts such as batteries and relays if the operation exceeds 100,000 times are excluded from the 3 year warranty.

7.2 Extent of warranty

IDEC CORPORATION is responsible for failures or defects of the Products during the above warranty period, either a replacement part will be provided or the defective parts of the Products will be repaired free of charge. If such failure or defects should occur, please offer them to the distributor, dealer or IDEC CORPORATION with the materials in which the date of purchase is specified.

* The expenses for installation and construction at the time of repair will not be borne.

7.3 Start

May 1, 2017. The Products which were produced after June 1, 2014 and purchased in last three years will also be warranted.

7.4 Indemnification

IDEC Corporation will not be liable under this Warranty and be indemnified and held harmless from any and all demands, suits, expenses, claims, damages and liabilities in the following event that:

- 1) The Products are used or operated beyond the conditions or environment range as described in catalog, specifications or instruction; or
 - 2) The failure or defects of the Products arise from the cause other than the Products; or
 - 3) The Products are improved, modified or altered by the party other than IDEC; or
 - 4) The failure or defects and damages of the Products arise from the usage of the Product in the way that is not intended; or
 - 5) The failure or defects and damages of the Products arise from the cause beyond IDEC's control including, but not limited to, fire, earthquake, flood, lightning, other natural disasters, and acts of God; or
 - 6) The failure or defects and damages of the Products arise from the relocation, transportation or drop after you purchase the Products; or
 - 7) The failure or defects and damages of the Products arise from improper installation; or
 - 8) Maintenance and inspection are not carried out in accordance with instruction.
- * Customers assume their own risk in programming products, Company will not be held liable for damages as a result of improper programming.

IDEC CORPORATION DISCLAIMS ALL IMPLIED WARRANTIES OF MERCHANTABILITY AND/OR FITNESS FOR A PARTICULAR USE OR PURPOSE, AS WELL AS LIABILITY FOR INCIDENTAL, SPECIAL, INDIRECT, CONSEQUENTIAL OR OTHER DAMAGES RELATING TO THE PRODUCTS

7.5 Extent of service

The price of the Products will not include the fee for any service such as sending technicians and engineers, IDEC CORPORATION will charge you the fee for the following:

- 1) Instruction for installment and visiting for test operation, including, but not limited to creating application software and operation tests; and
- 2) Maintenance and inspection, arrangement and repair; and
- 3) Technical assistance and technical education; and
- 4) Product test and inspection based on you request.

Chapter 36 Troubleshooting

This chapter describes the errors that may occur with the MICRO/I and the measures necessary to correct these errors.

1 Error Messages

The MICRO/I displays a variety of error messages in order to assist you in quickly analyze and resolve problems with the hardware, communications system, and user screen data.

1.1 Errors Displayed on the Screen

HG2J-7U HG5G-V HG4G-V HG4G HG3G-V HG3G HG2G-V HG2G-5F HG2G-5T HG1G HG1P

The following error messages are displayed in the event of communication system problems and problems with user screen data. When an error occurs, take the appropriate indicated action. If an error persists despite your attempts to correct it, contact your vendor or IDEC Corporation.

Error Message	Cause	Solution
Waiting for default screen No.	The default screen number is set at 0.	Either write the screen number to the System Area display screen number region, or set the initial screen number to a number other than 0.
No screen data	The specified Base Screen does not exist.	Set the Base Screen and download it to the MICRO/I.
No SD memory card exists* ¹	No SD memory card inserted when the unit attempted to access the SD memory card.	Insert an SD memory card.
No USB flash drive exists* ²	No USB flash drive inserted when the unit attempted to access the USB flash drive.	Insert a USB flash drive.
No USB flash drive exists (USB1)* ³		Insert a USB flash drive into the USB1.
No USB flash drive exists (USB2)* ³		Insert a USB flash drive into the USB2.
This SD memory card not available* ¹	<ul style="list-style-type: none"> The type of inserted SD memory card is not recognized. The SD memory card is broken. 	Please use a new recommended SD memory card.
This USB flash is not available* ²	<ul style="list-style-type: none"> The type of USB flash drive is not recognized. The USB flash drive is broken. 	Please use a new recommended USB flash drive.
This USB flash drive isn't available (USB1)* ³		
This USB flash drive isn't available (USB2)* ³		
SD memory card Access Error* ¹	When the unit attempted to access the SD memory card: <ul style="list-style-type: none"> The SD memory card did not have enough free space. The SD memory card was removed partway through. The SD memory card was broken. 	Create some free space on the SD memory card or get a new one.
USB flash Drive Access Error* ²	When the unit attempted to access the USB flash drive: <ul style="list-style-type: none"> The USB flash drive did not have enough free space. The USB flash drive was removed partway through. The USB flash drive was broken. 	Create some free space on the USB flash drive or get a new one.
USB flash drive Access Error (USB1)* ³		
USB flash drive Access Error (USB2)* ³		
ZNV file is not found	The ZNV Project File was not in the specified location on the external memory device when a download was made using the Project Data Transfer function.	Check whether or not the file is in the specified location on the external memory device.
ZLD file is not found	The ZLD Project File was not in the specified location on the external memory device when a download was made using the PLC Program Transfer function.	Check whether or not the file is in the specified location on the external memory device.
ZNV file format Error	When a download was made using the Project Data Transfer function: <ul style="list-style-type: none"> The ZNV Project File format is invalid. The file is corrupt. 	Remake the ZNV Project File.

*1 HG5G/4G/3G/2G-V, HG4G/3G, HG2G-5F only

*2 HG5G/4G/3G/2G-V, HG4G/3G, HG2G-5F/-5T, HG1G/1P only

*3 HG2J-7U only

Error Message	Cause	Solution
ZLD file format Error	When a download was made using the PLC Program Transfer function: <ul style="list-style-type: none"> • The ZLD Project File format is invalid. • The file is corrupt. 	Remake the ZLD Project File.
Product Series is not correct	When a download was made using the Project Data Transfer function, the model of the downloaded project and the model of the destination MICRO/I were different	Check that the model name that is set in the file you want to download is the same as the model name of the destination MICRO/I.
PLC Type is not correct	When a download or upload was made using the PLC Program Transfer function: <ul style="list-style-type: none"> • The model of the downloaded PLC Program and the model of the destination PLC were different. • The runtime program version using the downloaded PLC Program and the one of the destination PLC were different. 	Check PLC models and runtime program versions.
PLC Password is not valid	When a download or upload was made using the PLC Program Transfer function, the password you entered was incorrect.	Enter the correct password.
PLC communication Error	When a download or upload was made using the PLC Program Transfer function, a communication problem with the PLC occurred.	It is possible that there is a problem with the connection with the PLC. Check the connection between MICRO/I and the PLC.
The specified files are not found	The specified files were not in the specified location on the external memory device when the File Copy function was executed.	Check whether or not the file is in the specified location on the external memory device.
File Size Error	The size of the source file exceeded the limit when the File Copy function was executed.	Check the source file size. For the maximum file size that can be copied, refer to Chapter 29 "3.5 Precautions" on page 29-38.
Insufficient memory error	The resource memory of the HG is insufficient because of the use of a large number of the following parts. <ul style="list-style-type: none"> • Pilot Lamps, Multi-State Lamps, and Picture Displays. • Message Display, Message Switching Display, and Alarm List Display with the Scroll checkbox is selected. • Line Chart with the Display cursor checkbox is selected. • Parts over the number limit of parts that can be set per screen by overlapping Base Screen. 	Clear the Scroll or Display cursor checkbox, or delete parts to reduce memory resource utilization.
Device write error	The script generated a lot of write data, and the write operation failed.	Reduce the number of write operations to be performed at the same time.
Communication error: READ Illegal reply from Ext.device. Confirm PLC, Device Address.	The external device returned an error for a read request of a device address from the MICRO/I.	Check the following. <ul style="list-style-type: none"> • The ID and name of the external device for which the communications error occurred will be displayed. Check if an error has occurred on the corresponding external device. • An error may have occurred internally on the external device. Check the manual of the external device. • Check the address range of the external device to see if a non-existent address is being accessed.
Communication error: WRITE Illegal reply from Ext.device. Confirm PLC, Device Address.	The external device returned an error for a write request of a device address from the MICRO/I.	
Communication error: INIT Illegal reply from Ext.device. Confirm PLC, Device Address.	The external device returned an error for an initialization request to start communications from the MICRO/I.	

Error Message	Cause	Solution
Communication error: READ No reply from Ext.device.Confirm PLC,Cable,Com.settings.	There was no response from the external device for a read request of a device address from the MICRO/I.	Check the following. <ul style="list-style-type: none"> • The ID and name of the external device for which the communications error occurred will be displayed. Check if an error has occurred on the corresponding external device. • Check for problems with the cables, such as incorrect wiring and loose connection. • The power supply to the external device may be turned off or the external device may have been reset. Check the manual of the external device. • Check the communications settings to determine if the communications settings of the HMI and external device are the same.
Communication error: WRITE No reply from Ext.device.Confirm PLC,Cable,Com.settings.	There was no response from the external device for a write request of a device address from the MICRO/I.	
Communication error: INIT No reply from Ext.device.Confirm PLC,Cable,Com.settings.	There was no response from the external device for an initialization request to start communications from the MICRO/I.	
Processing error	<ul style="list-style-type: none"> • A value is divided by 0. • There is data which cannot be handled with the specified data type; BCD4(B), BCD8(EB), or Float32(E). • The setting of Origin, Minimum, or Maximum for the Bar Chart or Line Chart are invalid, or the Minimum and Maximum are the same values. • The setting of Minimum, Maximum, or ranges for the Meter are invalid, or the Minimum and Maximum are the same values. • There is invalid clock data which is used in Calendar parts. 	Check the calculation or settings.
Device range error	<ul style="list-style-type: none"> • The data is written to the device with the address out of the range. • The number of device addresses exceeds the limitation. 	Check the device address settings.
Script error	An error occurred for a process in execution of the script.	Check the value of HMI Special Data Registers LSD52 and LSD53, and correct the script. For details, refer to Chapter 20 "Script" on page 20-1.
Network off-line	This error message is only displayed when O/I Link is being used.	For details, refer to the WindO/I-NV4 External Device Setup Manual.

1.2 Low Battery Voltage

HG2J-7U HG5G-V HG4G-V HG4G HG3G-V HG3G HG2G-V HG2G-5F HG2G-5T HG1G HG1P

An internal battery maintains clock settings and log data in the MICRO/I. When the battery runs out, keep register data, log data and other backup data will be cleared, and the contrast is reset to the default value. If this happens, the following message is displayed when the MICRO/I is powered up, so take the indicated action.



To display the warning message, in the Project Settings dialog box, on the **System Settings** tab, select the **Battery warning message** check box.

In this case, Bit 14 (backup data error) of address number + 2 in System Area 2 is set, and it is reset when MICRO/I is powered on.

Message	Description
Backup data lost	Replace the battery. The Log Data and Calendar Data are lost. Set the clock again.



In case of storing Keep Memory and Keep Relay to the flash memory using HMI Special Internal Relay LSM10, stored data is transferred to the memory automatically when Backup data is lost.

The following warning messages will be displayed before the battery is dead.

In this case, the Bit 12 (Replace battery error) or Bit 13 (Replace battery error) of address number + 2 in the System Area 2 is set, and it is set whenever the MICRO/I is powered on.

Message	Description
Replace battery	The remaining battery level is low. Replace the battery in a short time.
Replace battery (Battery level LOW)	The remaining battery level is lowest. Replace the battery immediately, otherwise backup data will be lost.

2 Handling Problems

2.1 When You Cannot Download Project Data

HG2J-7U HG5G-V HG4G-V HG4G HG3G-V HG3G HG2G-V HG2G-5F HG2G-5T HG1G HG1P

■ HG2J-7U

Turn on the power while pressing the RESET switch on the back with a fine-tipped object, and keep pressing it for at least three seconds. However, do not use anything with a fragile or sharp tip.

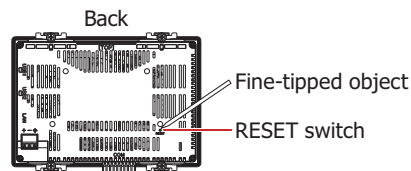

When the POWER LED turns orange and changes from blinking to lit, a message is displayed and MICRO/I becomes downloadable status. The IP address of the HG2J-7U type is 192.168.1.150. Please check the communication settings, and then download.

■ HG5G/4G/3G/2G-V, HG4G/3G, HG2G-5F/-5T, HG1G/1P

Press the top left corner of the panel for three seconds or longer while at the same time turning the power off and back on again.

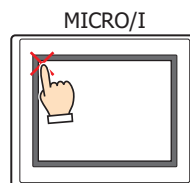

The screen in the System Mode is displayed, and then MICRO/I becomes downloadable status. If you download via Ethernet, check again the setting of TCP/IP before executing the download.

When MICRO/I does not show the System Mode screen and continues a blackout having a bleep each second, be sure to download a project using a port for USB.

2.2 If the backlight is OFF and the buzzer sounds

HG2J-7U HG5G-V HG4G-V HG4G HG3G-V HG3G HG2G-V HG2G-5F HG2G-5T HG1G HG1P

If you fail to download the runtime program to MICRO/I, the backlight may turn to OFF and a beep may sound continuously every second, even after the power has been turned off and on again. Rectify the situation by downloading the project using WindO/I-NV4 via USB cable.



When the backlight is OFF and the buzzer sounds, you cannot download the project to MICRO/I via Ethernet or using an external memory.

2.3 Touch Panel Does Not Respond Correctly

HG2J-7U HG5G-V HG4G-V HG4G HG3G-V HG3G HG2G-V HG2G-5F HG2G-5T HG1G HG1P

■ HG2J-7U

Press the RESET switch on the back with a fine-tipped object or turn the power off and then on again.

■ HG5G/4G/3G/2G-V, HG4G/3G, HG2G-5F/-5T, HG1G/1P

If the touch panel needs to be readjusted, then go to the System Mode to readjust the touch panel. For details about adjusting method, refer to Chapter 34 "Touch Panel Adjust (TP Adjust)" on page 34-9.

2.4 Power LED light is OFF

HG2J-7U HG5G-V HG4G-V HG4G HG3G-V HG3G HG2G-V HG2G-5F HG2G-5T HG1G HG1P

If the LED on the front of MICRO/I does not light up when power is turned ON, it may indicate a problem exists in the main unit. Contact your vendor or IDEC Corporation.

2.5 POWER LED is lit or flashing

HG2J-7U HG5G-V HG4G-V HG4G HG3G-V HG3G HG2G-V HG2G-5F HG2G-5T HG1G HG1P

The HG2J-7U indicates its status by the color of the POWER LED and by lighting or flashing.

POWER LED	Symptom	Solution
Lighting Red Flashing Orange	The POWER LED on MICRO/I keeps lighting red or flashing orange when power is turned ON.	It may indicate a problem exists in the main unit. Contact your vendor or IDEC Corporation.
Flashing Green	The POWER LED on MICRO/I keeps flashing green when power is turned ON.	<ul style="list-style-type: none"> The operating system may be corrupted, please download the project and update the operating system. For details, refer to Chapter 24 "2.2 Download Dialog Box" on page 24-14. If updating the operating system does not improve the symptoms, it may indicate a problem exists in the main unit. Contact your vendor or IDEC Corporation.
Lighting Orange	The POWER LED on MICRO/I keeps lighting orange when power is turned ON.	<ul style="list-style-type: none"> Make sure that the RESET switch is not held down, and then turn the power off and then on again. If the symptoms do not improve after turning the power off and then on again, the operating system may be corrupted, please download the project and update the operating system. For details, refer to Chapter 24 "2.2 Download Dialog Box" on page 24-14. If updating the operating system does not improve the symptoms, it may indicate a problem exists in the main unit. Contact your vendor or IDEC Corporation.

Appendix

This chapter contains the color number, and describes details about the Color Palette and other settings used in WindO/I-NV4.

1 Color Number

HG2J-7U HG5G-V HG4G-V HG4G HG3G-V HG3G HG2G-V HG2G-5F HG2G-5T HG1G HG1P

● Color Data Correspondence Table

This table is used when using Message Display and Script. Select a value from the Data column of the table and you can change the display color of an object by values of device addresses.

Color No.	Data	Color No.	Data	Color No.	Data	Color No.	Data	Color No.	Data	Color No.	Data
000	0x00	045	0x2D	086	0x56	127	0x7F	167	0xA7	207	0xCF
001	0x01	046	0x2E	087	0x57	128	0x80	168	0xA8	208	0xD0
002	0x02	047	0x2F	088	0x58	129	0x81	169	0xA9	209	0xD1
003	0x03	048	0x30	089	0x59	130	0x82	170	0xAA	210	0xD2
004	0x04	049	0x31	090	0x5A	131	0x83	171	0xAB	211	0xD3
005	0x05	050	0x32	091	0x5B	132	0x84	172	0xAC	212	0xD4
006	0x06	051	0x33	092	0x5C	133	0x85	173	0xAD	213	0xD5
007	0x07	052	0x34	093	0x5D	134	0x86	174	0xAE	214	0xD6
008	0x08	053	0x35	094	0x5E	135	0x87	175	0xAF	215	0xD7
009	0x09	054	0x36	095	0x5F	136	0x88	176	0xB0	216	0xD8
010	0x0A	055	0x37	096	0x60	137	0x89	177	0xB1	218	0xDA
011	0x0B	056	0x38	097	0x61	138	0x8A	178	0xB2	219	0xDB
012	0x0C	057	0x39	098	0x62	139	0x8B	179	0xB3	220	0xDC
013	0x0D	058	0x3A	099	0x63	140	0x8C	180	0xB4	221	0xDD
014	0x0E	059	0x3B	100	0x64	141	0x8D	181	0xB5	223	0xDF
019	0x13	060	0x3C	102	0x66	142	0x8E	182	0xB6	224	0xE0
020	0x14	062	0x3E	103	0x67	143	0x8F	183	0xB7	225	0xE1
021	0x15	063	0x3F	104	0x68	144	0x90	184	0xB8	226	0xE2
022	0x16	064	0x40	105	0x69	145	0x91	185	0xB9	227	0xE3
023	0x17	065	0x41	106	0x6A	146	0x92	186	0xBA	228	0xE4
024	0x18	067	0x43	107	0x6B	147	0x93	187	0xBB	229	0xE5
025	0x19	068	0x44	108	0x6C	148	0x94	188	0xBC	230	0xE6
026	0x1A	069	0x45	109	0x6D	149	0x95	189	0xBD	231	0xE7
027	0x1B	070	0x46	110	0x6E	150	0x96	190	0xBE	232	0xE8
028	0x1C	071	0x47	111	0x6F	151	0x97	191	0xBF	233	0xE9
029	0x1D	072	0x48	112	0x70	152	0x98	192	0xC0	234	0xEA
030	0x1E	073	0x49	113	0x71	153	0x99	193	0xC1	236	0xEC
032	0x20	074	0x4A	114	0x72	154	0x9A	194	0xC2	237	0xED
033	0x21	075	0x4B	115	0x73	155	0x9B	195	0xC3	238	0xEE
034	0x22	076	0x4C	116	0x74	156	0x9C	196	0xC4	239	0xEF
035	0x23	077	0x4D	118	0x76	157	0x9D	197	0xC5	241	0xF1
037	0x25	078	0x4E	119	0x77	158	0x9E	198	0xC6	242	0xF2
038	0x26	079	0x4F	120	0x78	160	0xA0	199	0xC7	243	0xF3
039	0x27	080	0x50	121	0x79	161	0xA1	200	0xC8	244	0xF4
040	0x28	081	0x51	122	0x7A	162	0xA2	201	0xC9	245	0xF5
041	0x29	082	0x52	123	0x7B	163	0xA3	202	0xCA	246	0xF6
042	0x2A	083	0x53	124	0x7C	164	0xA4	204	0xCC	255	0xF7
043	0x2B	084	0x54	125	0x7D	165	0xA5	205	0xCD		
044	0x2C	085	0x55	126	0x7E	166	0xA6	206	0xCE		

● Windows RGB Value Correspondence Table

The color numbers correspond to the following Windows RGB values.

Color No.	Windows RGB value	Color No.	Windows RGB value	Color No.	Windows RGB value	Color No.	Windows RGB value	Color No.	Windows RGB value	Color No.	Windows RGB value
000	000000	045	006666	086	3399CC	127	66CC00	167	9900CC	207	CCFF99
001	111111	046	006699	087	339999	128	66CC33	168	9900FF	208	CCFF66
002	222222	047	0066CC	088	339966	129	66CC66	169	9933FF	209	CCFF33
003	333333	048	0066FF	089	339933	130	66CC99	170	9933CC	210	CCFF00
004	444444	049	0099FF	090	339900	131	66CCCC	171	993399	211	FFCC00
005	555555	050	0099CC	091	330000	132	66CCFF	172	993366	212	FFCC33
006	666666	051	009999	092	330033	133	66FFFF	173	993333	213	FFCC66
007	777777	052	009966	093	330066	134	66FFCC	174	993300	214	FFCC99
008	888888	053	009933	094	330099	135	66FF99	175	CC0000	215	FFCCCC
009	999999	054	009900	095	3300CC	136	66FF66	176	CC0033	216	FFCCFF
010	AAAAAA	055	00CC00	096	3300FF	137	66FF33	177	CC0066	218	FFFFCC
011	BBBBBB	056	00CC33	097	3333FF	138	66FF00	178	CC0099	219	FFFF99
012	CCCCCC	057	00CC66	098	3333CC	139	99CC00	179	CC00CC	220	FFFF66
013	DDDDDD	058	00CC99	099	333399	140	99CC33	180	CC00FF	221	FFFF33
014	EEEEEE	059	00CCCC	100	333366	141	99CC66	181	CC33FF	223	FF6600
019	880000	060	00CCFF	102	333300	142	99CC99	182	CC33CC	224	FF6633
020	FF0000	062	00FFCC	103	660000	143	99CCCC	183	CC3399	225	FF6666
021	888800	063	00FF99	104	660033	144	99CCFF	184	CC3366	226	FF6699
022	FFFF00	064	00FF66	105	660066	145	99FFFF	185	CC3333	227	FF66CC
023	008800	065	00FF33	106	660099	146	99FFCC	186	CC3300	228	FF66FF
024	00FF00	067	33CC00	107	6600CC	147	99FF99	187	CC6600	229	FF99FF
025	008888	068	33CC33	108	6600FF	148	99FF66	188	CC6633	230	FF99CC
026	00FFFF	069	33CC66	109	6633FF	149	99FF33	189	CC6666	231	FF9999
027	000088	070	33CC99	110	6633CC	150	99FF00	190	CC6699	232	FF9966
028	0000FF	071	33CCCC	111	663399	151	996600	191	CC66CC	233	FF9933
029	880088	072	33CCFF	112	663366	152	996633	192	CC66FF	234	FF9900
030	FF00FF	073	33FFFF	113	663333	153	996666	193	CC99FF	236	FF0033
032	000033	074	33FFCC	114	663300	154	996699	194	CC99CC	237	FF0066
033	000066	075	33FF99	115	666600	155	9966CC	195	CC9999	238	FF0099
034	000099	076	33FF66	116	666633	156	9966FF	196	CC9966	239	FF00CC
035	0000CC	077	33FF33	118	666699	157	9999FF	197	CC9933	241	FF33FF
037	0033FF	078	33FF00	119	6666CC	158	9999CC	198	CC9900	242	FF33CC
038	0033CC	079	336600	120	6666FF	160	999966	199	CCCC00	243	FF3399
039	003399	080	336633	121	6699FF	161	999933	200	CCCC33	244	FF3366
040	003366	081	336666	122	6699CC	162	999900	201	CCCC66	245	FF3333
041	003333	082	336699	123	669999	163	990000	202	CCCC99	246	FF3300
042	003300	083	3366CC	124	669966	164	990033	204	CCCCFF	255	FFFFFF
043	006600	084	3366FF	125	669933	165	990066	205	CCFFFF		
044	006633	085	3399FF	126	669900	166	990099	206	CCFFCC		

2 View Browser

HG2J-7U HG5G-V HG4G-V HG4G HG3G-V HG3G HG2G-V HG2G-5F HG2G-5T HG1G HG1P

The View Browser displays the list of graphics that have been prepared in advance in WindO/I-NV4. The settings displayed on View Browser vary based on the parts.

These graphics can be used as the outline of parts.

Example: Bit Button

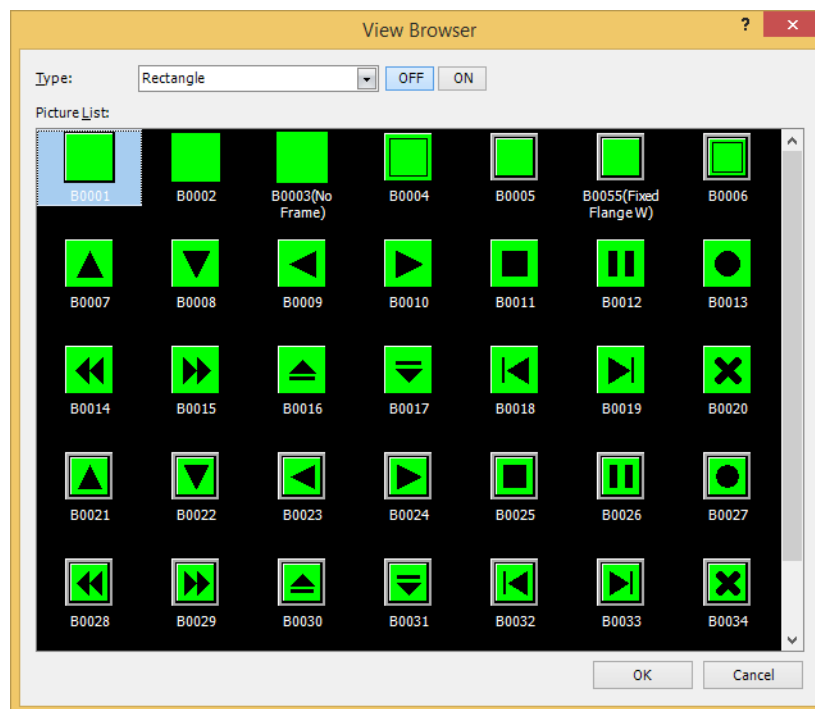

- **Type**
Selects the category of graphics.
- **OFF, ON**
Displays the graphic when OFF or ON. Click **ON** or **OFF** to switch the graphics displayed on the list.
- **Picture List**
Displays the list of registered graphics. Select the graphic to use as the outline of the part.

3 Color Palette

HG2J-7U HG5G-V HG4G-V HG4G HG3G-V HG3G HG2G-V HG2G-5F HG2G-5T HG1G HG1P

The Color Palette is used to select colors for drawing objects, text on parts, outlines, flanges, plates and other objects. Display the Color Palette by clicking a color in the Properties dialog box and then select the color. The type of color palette shown depends on the models being used.

■ 256 Color Palette*1

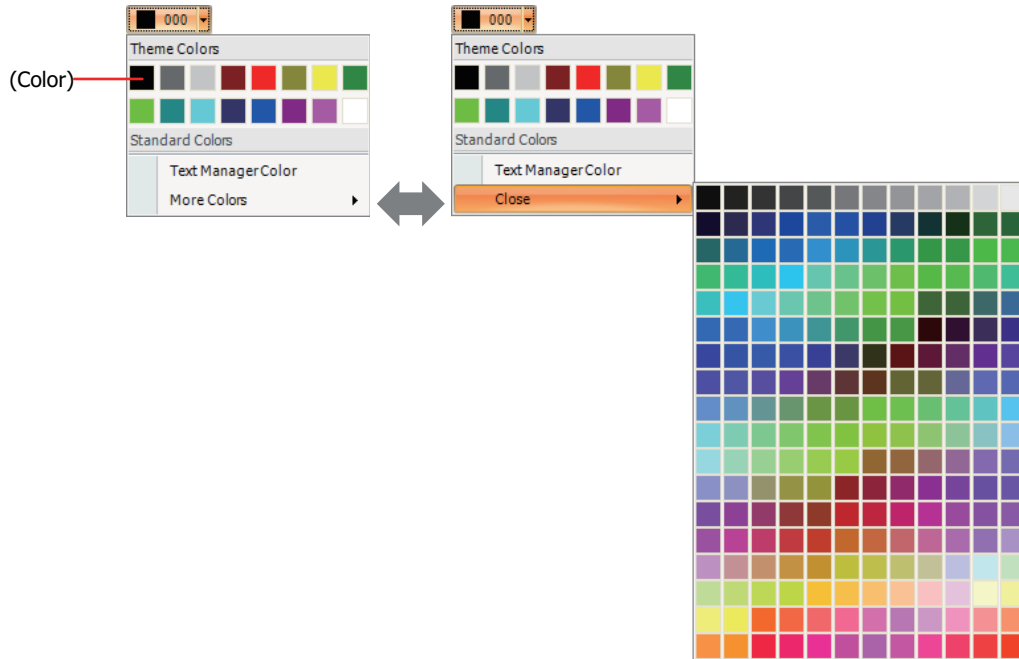

■ 16-level Monochrome Palette*2

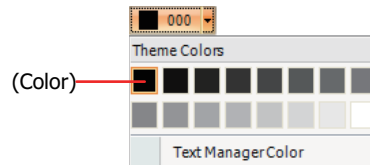

■ More Colors, Close

Switches the palette display. Clicking **More Colors** shows all the colors assignable to the **Color** button. **Close** shows only the basic colors assignable to the **Color** button.

■ Text Manager Color

This feature allows use of the text color specified in the Text Manager. Click here to use the text color specified in the Text Manager. This option can only be set when the **Use Text Manager** check box is selected.

■ Transparent Color

Converts the color in the imported picture to be transparent. This option can only be selected when Picture Manager was used.

■ None

This option is no fill color. This can only be set for **Background Color** in drawing object text.

1 HG2J-7U, HG5G/4G/3G/2G-V, HG4G/3G, HG2G-5F/5T only (*Color LCD models), HG1G/1P

2 HG2G-5T only (*Monochrome LCD models)

4 Pattern Palette

HG2J-7U HG5G-V HG4G-V HG4G HG3G-V HG3G HG2G-V HG2G-5F HG2G-5T HG1G HG1P

The Pattern Palette is used to select patterns or tonal gradations for drawing and part objects.

The Pattern Palette appears when you click **Pattern** in the object's Properties dialog box.

Click **Pattern** and select a pattern or tonal gradations.

Drawings

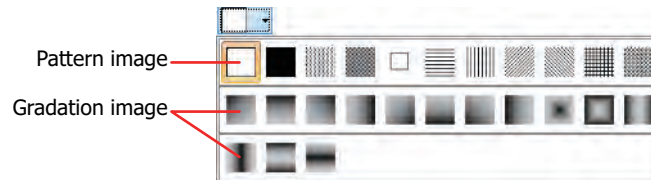

Parts

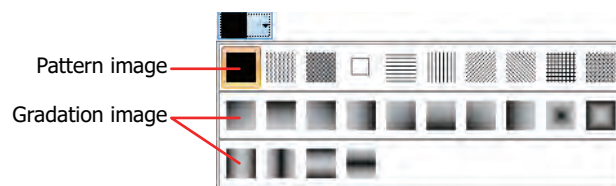

● Foreground and Background Colors

Drawing and part objects are formed by foreground and background colors.

■ Pattern

The selected pattern is applied to the foreground color.

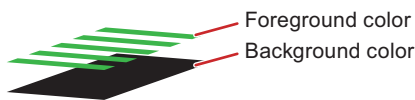

The background color is visible through the unpainted parts of the foreground color.



■ Gradation

The selected gradation is applied to the foreground color.

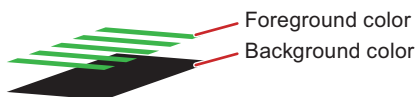





The background color is visible through the unpainted parts of the foreground color.







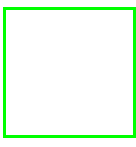
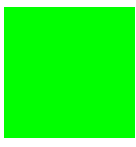
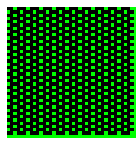
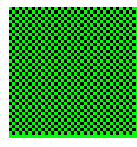
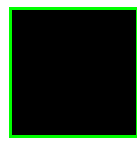

● Patterns and gradations





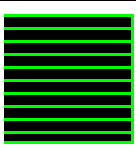
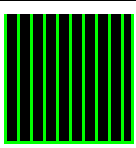
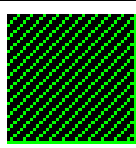
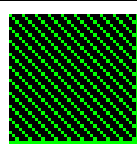
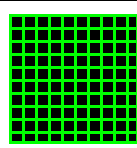
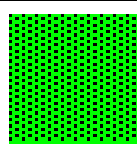

These patterns and gradations are available on WindO/I-NV4. When **024** on the **Foreground Color** and **000** on the **Background Color** are selected for the **Rectangle**, the display images are as follows:







■ Patterns

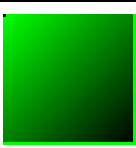
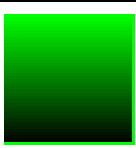
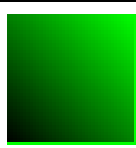
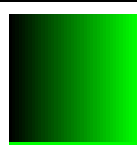
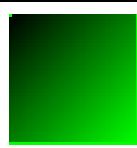
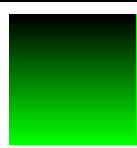

Pattern name	None *1	Foreground 100%	Foreground 25%	Foreground 50%	Background 100%
Pattern buttons					
Display sample					

Pattern name	Horizontal lines	Vertical lines	Slant Upwards	Slant Downwards	Crosshatch	Tint
Pattern buttons						
Display sample						

■ Gradation

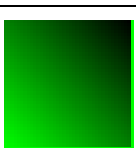
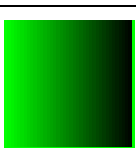
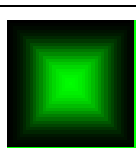
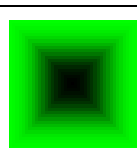
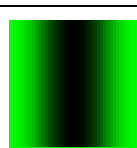
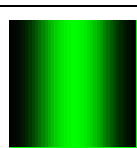
Gradation name	Diagonal up 1	Horizontal 1	Diagonal down 1	Vertical 1	Diagonal up 2	Horizontal 2
Gradation buttons						
Display sample						

Gradation name	Diagonal down 2	Vertical 2	Central 1	Central 2	Vertical 3	Vertical 4
Gradation buttons						
Display sample						

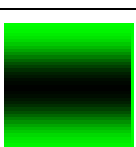
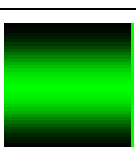
Gradation name	Horizontal 3	Horizontal 4
Gradation buttons		
Display sample		

*1 **None** can only be applied to drawing objects. Selecting **None** is the same as not applying any color at all.

5 Text Alignment

HG2J-7U HG5G-V HG4G-V HG4G HG3G-V HG3G HG2G-V HG2G-5F HG2G-5T HG1G HG1P

Text Alignment is used to adjust the way text appears on Drawing Objects and Parts.

● Horizontal Writing

These examples show how text appears using different combinations of the **Align Text Horizontal** and **Align Text Vertical** properties.

		Align Text Horizontal			
		Left	Center	Right	Center-Left
Align Text Vertical	Top				---
	Center (Center-Top)				
	Bottom				---

■ Align Text Horizontal

Left: Aligns the text along the left edge.

← Aligns along left edge

ABCDE
0123456789
fgh

Center: Centers the text horizontally in the center.

Centers text in the middle

ABCDE
0123456789
fgh

Right: Aligns the text along the right edge.

Aligns along right edge →

ABCDE
0123456789
fgh

Center-Left: Centers the line containing the most number of characters, and then aligns the other lines to the left end of that line.

← Aligns to left end of line with most characters

ABCDE
0123456789
fgh

Centers line with most characters



If **Align Text Horizontal** is set to **Center-Left**, **Align Text Vertical** will automatically be set to **Center-Top**. **Center-Top** results in the same display as **Center**.

■ **Align Text Vertical**

Top: Aligns the text along the top edge.

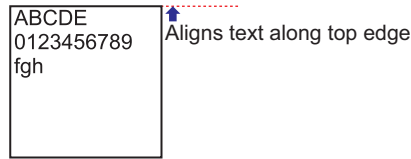

Center (Center-Top): Centers the text vertically in the center.

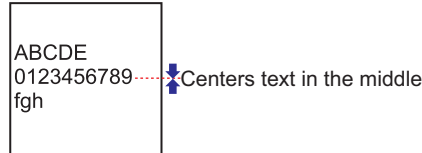

Bottom: Aligns the text along the bottom edge.

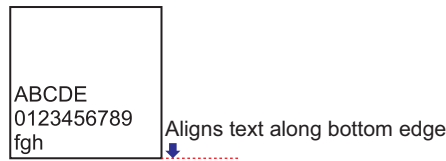

● **Vertical Writing**

These examples show how text appears for **Align Text Horizontal**.

Align Text Vertical defaults to **Top**.

		Align Text Horizontal		
		Left	Center	Right
Align Text Vertical	Top	<pre>f 0 A g 1 B h 2 C 3 D 4 E 5 6 7 8 9</pre>	<pre>f 0 A g 1 B h 2 C 3 D 4 E 5 6 7 8 9</pre>	<pre>f 0 A g 1 B h 2 C 3 D 4 E 5 6 7 8 9</pre>

■ Align Text Horizontal

Left: Aligns the text along the left edge.

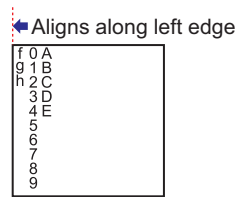

Center: Centers the text horizontally in the center.

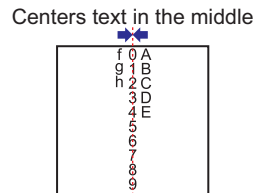

Right: Aligns the text along the right edge.

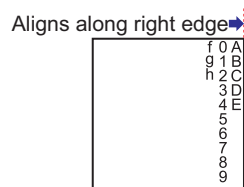

- Vertical text cannot be set if **Font** is set to **Stroke**^{*1}.
- Take note of these points when the **Vertical Writing** check box is selected:
 - When there is a mixture of double-byte and single-byte characters, the half-width characters are leftaligned.

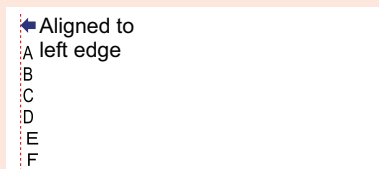

- Dashes are displayed horizontally. Symbols representing voiced and semi-voiced sounds of single-byte characters are shown as follows.

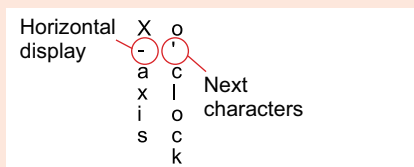

*1 HG5G/4G/3G/2G-V, HG4G/3G, HG2G-5F/-5T, HG1G/1P only

Numerics

1:1 Communication	3-2
1:N Communication	3-2
16-level Monochrome Palette	A-4
256 Color Palette	A-4
2-Notch	8-148
3-Notch	8-148

A

About BACnet	3-96
Active User	2-58
Add	8-21, 8-24, 8-117, 12-10, 12-13, 12-43
Add Data Dialog Box	14-28
Adding a Security Group	23-19
Adding a user accounts	23-55
Address Number Increment	2-62
Adjust Brightness screen	34-2
Adjusting Screen Brightness	34-2
Administrator	23-6
Alarm List Display	8-97, 10-136
Alarm Log Display	8-97, 10-153
Alarm Log Function	13-1
Alarm Log Settings Dialog Box	13-13
Alarm States	13-3
Alarm Tab	10-209
Alternate	8-2, 8-5, 8-20, 8-24, 8-111, 8-113
Analog I/O Modules	30-13
Analog Input Object Present_Value	3-112, 3-136
Properties List	3-125
Analog Output Object Present_Value	3-114, 3-137
Properties List	3-126
Analog Value Object Present_Value	3-116, 3-138
Properties List	3-127
AND	8-21, 8-24, 8-117, 12-10, 12-13, 12-43
Applicable Expansion Modules Analog I/O Module	30-3
Digital I/O Module	30-2
Application Menu	2-42
Application_Software_Version	3-147
Arc	7-14
Arithmetic Formulas	10-20, 10-200
Arithmetic operation	20-24
Arithmetic Operators	20-23, 20-41
Arrange	2-54
Attach Files Dialog Box	28-60
Automation Organizer Updater Dialog Box	2-39
Autoplay	10-85
Autorun Tab	4-64

AutoSave	2-66
Auto-Setup Dialog Box Alarm Log Settings	13-18
Available Fonts for Drawings and Parts	2-9
Available Updates	2-39

B

Background Colors	A-5
Backlight	4-26
Backlight OFF	5-16
BACnet Communication	3-94
BACnet Device Foreign device function	3-103
Object and Device Binding Function	3-98
Read Property Function	3-99
Subscribed COV (COV) function	3-100
Unsubscribed COV (COVU) function	3-102
Write Property Function	3-99
BACnet Settings Dialog Box BACnet/IP Settings	3-108
Object List	3-110
Present_Value Settings	3-112
BACnet Specifications	3-95
BACnet/IP Operation	3-104
BACnet/IP Settings Procedure	3-105
BACnet/IP Settings Tab	4-80
Bar Chart	11-1
Base Screen	5-14
Batch Alarm Log Function	13-6, 13-27
Alarm Log Settings	13-21
Data Log Settings	14-19
Data Structure and Output Example (Alarm Log Settings)	13-38
Data Structure and Output Example (Data Log Settings)	14-45
Data Structure and Output Example (Operation Log Settings)	15-21
Operation Log Settings	15-15
Batch Monitor Monitor	25-15
Simulator	26-13
BIBB	3-97
Binary Input Object Present_Value	3-119, 3-141
Properties List	3-128
Binary Output Object Present_Value	3-142
Present_Value Settings	3-121
Properties List	3-129
Binary Value Object Present_Value	3-122, 3-143
Properties List	3-130
Bit Button	8-1
Bit Functions	20-24, 20-44
Bit Number Symbol	2-62
Bit operator	20-23
Bit Write Command	12-1

Bitwise Operators	20-42
Block Settings	13-18
Block Tab	18-10
Boot Mode	1-4

C

Calendar	10-205
Change User Account Dialog Box	23-39
Change Volume Level	21-8
Changing the Name of a Security Group	23-22
Changing the Operation Privileges of a Security Group	23-23
Channel Settings	13-19
Channel Tab	
Alarm Log Settings	13-16
Recipe Settings	18-12
Character Code Table	2-16
Character Input	10-27
Character Input Keypad	8-94, 8-96
Character string operation	20-26
Charts	11-1
Checking the Hardware Version Number	30-4
Checking User Account Information	23-51
Circle	7-11
Clear	24-26
Clear Data from the MICRO/I	24-26
Clipboard	2-46
Closing Screens	5-5
Color Data Correspondence Table	A-1
Color Palette	A-4
COM(RS232C)	4-40
COM(RS422/485)	4-40
COM1	4-39
COM2	4-39
COM2(RS232C)	4-39
COM2(RS422/485)	4-39
Command Settings Dialog Box	3-36
Commands	12-1
Comment	20-31
Comment Tab	
Alarm List Display	10-152
Alarm Log Display	10-170
Bar Chart	11-20
Bit Button	8-18
Bit Write Command	12-8
Calendar	10-220
Character Input	10-46
Data Log Display	10-184
Goto Screen Button	8-55
Goto Screen Command	12-24
Key Button	8-93
Line Chart	11-52
Message Display	10-115
Message Switching Display	10-135
Meter	11-75
Multi-Button	8-141
Multi-Command	12-59
Multi-State Lamp	9-33
Numerical Display	10-204

Numerical Input	10-24
Picture Display	10-75
Pie Chart	11-63
Pilot Lamp	9-15
Potentiometer	8-174
Print Button	8-71
Print Command	12-31
Script Command	12-37
Selector Switch	8-162
Timer	12-65
Video Display	10-91
Word Button	8-38
Word Write Command	12-17
Communicate with	24-5
Communication	2-51
Communication Driver	2-58
Communication Driver Extension Settings Dialog Box	4-51
Communication Driver Information Dialog Box	24-34
Communication Driver Network Tab	4-52
Communication Driver Tab	4-47
Communication Interface Tab	4-35
Communication Settings	24-5, 31-4, 31-7
Compatibility	2-63
Compatible Tab	4-77
Compatible with HG1B	4-79
Compatible with previous version	4-77
Completed Device Address	3-41
Condition of Writing to Data Storage Area	14-16
Conditional branching	20-21
Configuration	2-49
Configuring registered user communication protocol to another user communication	3-28
Configuring the Event Recording Function	22-6
Configuring the Video Input	22-11
Confirmed	13-3
Connect MICRO/I to a Computer	24-4
Connecting a Printer to MICRO/I	32-1
Connection Diagram for User Communication	3-86
Constant	20-31
Control Statements	20-21, 20-32
Converting Project for Transfer	29-3
Counting the Operation Count	17-2
Counting the Operation Time	17-2
COV_Increment	3-145
Create a new user communication protocol, and then configure it to a communication interface	
Using Inching Function	3-21
Using Transmission Command and Receive Command	3-9
Creating a screen	5-2
Creating a USB Autorun Definition File (Text editor)	31-26
Creating a User Account	23-11
Creating New Project Data	4-1
Creating Recipe Files	18-17
Cross Reference Dialog Box	2-72
Custom Monitor	
Monitor	25-7
Simulator	26-11
Custom Web Page	28-12

Cyclic Script 4-65, 30-10, 30-29

D

Data 2-74
Data comparison and copy 20-26
Data Configuration
 Alarm Log Function 13-5
 Data Log Function 14-5
 Operation Log Function 15-4
 Recipe Function 18-3
Data Displays 10-1
Data for Recipes 18-2
Data Labels Dialog Box 15-12
Data Log Display 8-98, 10-171
Data Log Function 14-1
Data Log Settings Dialog Box 14-13
Data Over Tab
 Bar Chart 11-9
 Numerical Display 10-196
 Numerical Input 10-15
Data Settings Dialog Box 3-48
Data Size 2-58
Data Storage Amount
 Alarm Log Function 13-8
 Data Log Function 14-6
 Operation Log Function 15-6
Data Storage Area 16-1
Data Storage Area Management Dialog Box 16-4
Data Tab
 Bar Chart 11-5
 Data Log Settings 14-26
 Recipe Settings 18-13
Data Transfer Function 29-1
Data Transfer Mode 1-4
Data type conversion 20-25
Data Type Designations 20-30, 20-60
Date and Time (Cursor) Tab 11-43
Debugging in Simulator 26-4
Debugging in WindO/I-NV4 25-4
Default Preferences Tab 2-63
Deleting a Security Group 23-24
Deleting a User Account 23-18, 23-58
Deleting Data
 Alarm Log Function 13-8
 Data Log Function 14-6
 Operation Log Function 15-6
Deleting Data from an External Memory Device Inserted
 in the MICRO/I 24-27
Deleting Files on the External Memory Device 31-13
Deleting Recipe Files 18-22
Deleting Screens 5-9
Device Address
 Maximum Number of External Device
 Addresses 4-83, 5-31
Device Address Display 11-24
Device Address Settings 2-70
Device Link Communication 3-1
Device Monitor 25-21

Device Object
 Properties List 3-131
Digital I/O Modules 30-12
Disable Switch 4-28
Display a Picture at Startup 4-25
Display Block Number 10-167, 10-181
Display images from the video input 10-84
Display the Order of Overlapping Screens 5-16
Display the Value of Device Address in Popup 25-18
Display with Arithmetic Operation 10-20, 10-200
Div 8-21, 8-24, 8-117, 12-10, 12-13, 12-43
DM Link 1:1 Communication 3-4
DM Link 1:N Communication 3-5
DM Link Communication 3-4
DM Link Ethernet (UDP) Communication 3-5
Docking 2-55
Download Data 24-15
Download Dialog Box 24-14
Downloading
 Custom Web Page Files 24-16
 Font 24-15
 Kanji Dictionary Data 24-15
 Movie File List 24-18
 Movie Files 24-18
 Picture Files 24-16, 24-18
 Project Data 24-12, 31-8
 Recipe Files 24-16, 24-18
 Restrictions 4-83
 Sound Files 24-16, 24-18
 System Software 24-15
 System Software of Expansion Modules 24-15, 24-20
 ZLD Project File 29-19, 29-21
 ZNV Project File 29-6, 29-7
Downloading files
 External Memory Device 31-5
Downloading Project Data
 To External Memory Device 31-8
 To MICRO/I 24-12
Draw 20-27
Drawings 2-46, 6-1, 7-1
Duplicating Screens 5-7

E

Edit Data Dialog Box 14-28
Editing 2-48
Editing a User Account 23-16, 23-51
Editing Recipe Data 18-14
Editing Recipe Files 18-21
Editor 2-49
Ellipse 7-11
E-mail Address Book Dialog Box 28-56
E-mail Address Dialog Box 28-58
E-mail Function 28-38, 28-42
E-mail Group Dialog Box 28-59
E-mail Settings Dialog Box 28-52
E-mail Tab 4-70
Enable Low Battery Warning 4-28
Enable Maintenance 4-27

Enable Touch Sound	4-26
Enable Two-point Push	4-27
ENT button	10-8, 10-33
Enter Kanji characters	10-49
Enter Password Dialog Box	23-49
Equilateral Polygons	7-19
Error Information	3-92
Error Messages	36-1
Errors Displayed on the Screen	36-1
Ethernet	4-41, 4-43, 24-6
Event Name	15-13
Example of User Communication Settings	3-80
Executing commands using the USB Autorun function	31-23
Expansion Module	30-1
Expansion Module Information Dialog Box	24-33
Expansion Module Slot Information	30-5
Expansion Module Tab	4-65
Expansion Settings	4-53
Exporting library parts	6-14
Exporting sound files	21-9
External Device Monitor	25-17
External Memory Device Folder	4-63
External Memory Device Information Dialog Box	24-33
External Memory Device Tab	
Alarm Log Settings	13-20
Data Log Settings	14-18
Operation Log Settings	15-14
Project Settings	4-63
External Memory Devices	31-1

F

Fade In	5-22, 5-27
File Copy Function	29-30
File Copy Operating Procedures	29-31
File Screen	10-92
File Structure	31-3
File Transfer Settings Dialog Box	28-31
Fill	7-22
Firmware_Revision	3-147
Flash	5-16
Flashing Cycle	4-28
Floating windows	2-55
Focus Order	5-16, 5-22
Font/Kanji Dictionary Data Information Dialog Box	24-32
Font/Kanji Dictionary Data Tab	4-76
Foreground Colors	A-5
Format	2-53, 24-28
Arrange	2-54
Shape Style	2-53
Size	2-54
Text Style	2-53
Format Tab	
Alarm List Display	10-144
Alarm Log Display	10-161
Calendar	10-213
Character Input	10-36

Data Log Display	10-178
Message Display	10-103
Message Switching Display	10-125
Numerical Display	10-192
Numerical Input	10-11
Selector Switch	8-155
Formatting	
External Memory Device	31-14
External Memory Device Inserted	
in the MICRO/I	24-28
FTP Client Function	28-20, 28-21
FTP Server Function	28-16, 28-19
FTP Server Manager	28-27
FTP Server Tab	4-68
Full Screen	10-85
Function	20-24
Function list	20-14
Functions that Support Text Groups	19-2

G

General Tab	
Alarm List Display	10-138
Alarm Log Display	10-155
Alarm Log Settings	13-13
Bar Chart	11-3
Base Screen	5-14
Bit Button	8-4
Bit Write Command	12-4
Calendar	10-207
Character Input	10-29
Data Log Display	10-173
Data Log Settings	14-15
File Transfer Settings	28-32
Goto Screen Button	8-41
Goto Screen Command	12-20
Global Script	20-19
Key Button	8-75
Line Chart	11-23
Message Display	10-99
Message Switching Display	10-119
Meter	11-66
Multi-Button	8-113
Multi-Command	12-40
Multi-State Lamp	9-19
New or Change User Account	23-39
Numerical Display	10-187
Numerical Input	10-3
Operation Log Settings	15-10
Password Input Screen	5-26
Picture Display	10-60
Pie Chart	11-55
Pilot Lamp	9-3
Popup Screen	5-20
Potentiometer	8-165
Print Button	8-58
Print Command	12-27
Script Command	12-34
Security	23-37
Selector Switch	8-148
Timer	12-62
Video Display	10-84
WindO/I-NV4 Options	2-62
Word Button	8-23
Word Write Command	12-12
Global Script	20-16

Global Script Dialog Box	20-19
Global Script Settings Dialog Box	20-18
Goto Screen Button	8-39
Goto Screen Command	12-18
Gradation	A-6
Grid Settings	2-59
Group Membership Tab	
New or Change User Account	23-40
Group Tab	23-41

H

Halt and exit	20-22
Handling Problems	36-5
Hierarchy of the FTP Server	28-17
Highlighting Objects While Satisfying Conditions	25-18
High-quality Fonts	2-10
HMI Link Register (LLR) Assignment	3-88
HMI Special Data Register	33-8
HMI Special Relay	33-2
Home	2-46
Horizontal Writing	A-7
How to Enter Text	10-47
How to register an object in the parts library	6-13
How to use a registered library part on another computer	
.....	6-14
How to use the Library Part in a project	6-12

I

If the backlight is OFF and the buzzer sounds	36-5
Image Files	2-20
Importing library parts	6-15
Importing script	20-10
Importing Text from a Text List	19-7
Importing user communication protocol	3-31
Inching	3-38
Indirect read	2-5
Indirect write	2-5
Individual Settings Dialog Box	
Alarm List Display	10-141
Alarm Log Settings	13-18
Data Log Settings	14-15
File Transfer Settings	28-32
FTP Server Manager	28-28
Preventive Maintenance Settings	17-8
Recipe Settings	18-10
Sound Settings	21-8
Input Method Editor (IME)	2-62
Input Signal	22-15
Input with Arithmetic Operation	10-20
Insert Value of Device Address Dialog Box	
E-mail Function	28-62
Social Media Function	28-75
Installed Fonts in the MICRO/I	2-7
Interface Configuration	4-35
Interface Settings	4-39
Internal Clock Tab	4-81

Internal Devices	33-1
IP Address	
Default	24-6
IP Address Manager	24-11

K

Key Browser	8-99
Alarm Display	8-100
Data Log Display	8-101
Data Transfer	8-100
Keypad(Half-Width Character)	8-99
Keypad(Hiragana)	8-99
Multimedia Function	8-101
Password Input	8-102
Key Button	8-72, 29-6, 29-19, 29-32
For Alarm Displays	8-97
For Data Transfer Keys	8-97
For Keypad(Half-Width Character)	8-94
For Keypad(Hiragana)	8-96
For Password Inputs	8-98
For the Data Log Display	8-98
For the Multimedia Function	8-98
Keypad	8-142

L

Label of Recorded Data	15-12
Label Tab	
Bar Chart	11-13
Line	7-1
Line Chart	11-21
List Tab	10-140
Log Tab	10-157
Data Log Display	10-174
Log Trend	11-23, 11-24
Logical Operators	20-23, 20-40
Low Battery Voltage	36-4

M

Main Menu screen	34-3, 34-4
Maintenance	28-1
Maintenance Screen	34-1
Manager	2-49
Maximum Number of Parts	5-30
Message Display	10-96
Message Switching Display	10-117
Message Tab	10-121
Meter	11-64
MICRO/I	2-50
MICRO/I Setup	34-1
Minimize the Ribbon	2-45
Mod	8-21, 8-24, 8-117, 12-10, 12-13, 12-43
Mode	2-58
Momentary	8-2, 8-5, 8-20, 8-24, 8-111, 8-113,
	12-1, 12-4, 12-10, 12-12
Monitor Function	25-1
Monitor Mode	1-4

Monitoring on the MICRO/I	25-20
Monitoring the Printer	32-2
Monitoring with WindO/I-NV4	25-1
Monitors	2-51
Move	8-2, 8-5, 8-20, 8-23, 8-116, 8-117, 12-2, 12-5, 12-10, 12-12, 12-42, 12-43
Movie File List	22-12
Movie Files	22-2
Movie Tab	22-12
Multi	8-21, 8-24, 8-117, 12-10, 12-13, 12-43
Multi-Button	8-110, 29-6, 29-19, 29-32
Multi-Command	12-38, 29-6, 29-19, 29-32
Multimedia Function	22-1
Multimedia Settings Dialog Box	22-12
Multi-State Lamp	9-16
Mute	21-8

N

New Security Group Dialog Box	23-43
New User Account Dialog Box	23-39
No Audio	10-85
No External Devices	3-7
Not Clear Completed Device Address automatically	3-41
Notch Settings Dialog Box	8-152
Number	5-14, 5-20, 5-26
Number of Blocks	
Alarm Log Settings	13-16
Recipe Settings	18-8
Number of external device limitations	4-54
Numerical Display	10-185
Numerical Input	4-29, 10-1
Numerical Input Keypad	8-94

O

O/I Link Communication	3-3
O/I Link Tab	4-55
Object	3-124
Object List	2-69
Object_List	3-147
Occurred	13-3
Offline Mode	1-4
Offset	20-29
Online	2-50
Online Function	24-1
Formatting the External Memory Device	31-14
Open Current Screens	25-19
Opening Project Data	4-4
Opening Screens	5-3
Opening the User Account Setting Screen	23-50
Operating Modes	1-4
Operation Count Tab	17-9
Operation Log Function	15-1
Operation Log Settings Dialog Box	15-10

Operation Time Tab	17-8
Operation with priority on control processing	30-9
Operation with priority on display processing	30-7
Operator	2-74, 20-23, 23-6
Optional Fonts	2-8, 4-76
Optional items	35-89
HG1P	35-93
HG2J-7U	35-89
HG4G/3G, HG2G-5F/-5T, HG1G	35-91
HG5G/4G/3G/2G-V	35-90
Options Dialog Box	20-15
Options Tab	
Alarm List Display	10-148
Alarm Log Display	10-166
Alarm Log Settings	13-29
Bar Chart	11-17
Base Screen	5-15
Bit Button	8-15
Calendar	10-217
Character Input	10-43
Data Log Display	10-181
Data Log Settings	14-30
Goto Screen Button	8-52
Key Button	8-90
Line Chart	11-49
Message Display	10-112
Message Switching Display	10-132
Meter	11-72
Multi-Button	8-138
Multi-State Lamp	9-30
Numerical Display	10-200
Numerical Input	10-20
Password Input Screen	5-27
Picture Display	10-72
Pie Chart	11-60
Pilot Lamp	9-12
Popup Screen	5-21
Potentiometer	8-171
Print Button	8-68
Security	23-44
Selector Switch	8-159
Video Display	10-88
Word Button	8-35
OR	8-21, 8-24, 8-117, 12-10, 12-13, 12-43
Out_Of_Service	3-146
Overlay	5-15

P

Part Library	6-16
Part Library Function	6-11
Parts	2-47
Pass-Through Function	27-1
Password Input	23-47
Password Input Screen	5-26
Password Input Screens	23-48
Pattern Palette	A-5
Patterns	A-6
Peak chart	11-3
Pen Recorder	11-24
Picture	6-2, 7-24
Picture Display	10-56

Picture Manager	2-28
Picture Name Setting Dialog Box	2-36
Pie	7-16, 11-56
Pie Chart	11-53
Pilot Lamps	9-1
Play a movie or recorded file from the File Screen	10-84
Play the Movie File List	10-84
Play the specified movie	10-85
Playing Recorded Images and Sound	8-106
PLC Program Transfer Function	29-16
PLC Program Transfer Procedures	29-17
Polarity	3-145
Polygon	7-5
Polyline	7-3
Popup Screen	5-20
Port	24-6
Position	2-58
Potentiometer	8-163
POWER LED is lit or flashing	36-6
Power LED light is OFF	36-6
Preference	2-39
Preventive Maintenance Function	17-1
Preventive Maintenance Settings Dialog Box	17-6
Preview	2-60
Print	4-7
Print Button	8-56
Print Command	12-25
Print Preview Dialog Box	4-16
Print Settings Dialog Box	4-8
Printer	32-1
Printer Tab	4-62
Printing Tab	
Alarm Log Settings	13-27
Priority of the Operator	20-62
Priority on control processing	30-6
Priority to display processing	30-6
Priority_Array	3-145
Project	2-48
Restrictions	4-83
Project Data	4-1
Project Details Tab	4-75
Project Recovery Dialog Box	2-40
Project Settings	4-24
Project Settings Dialog Box	4-25
Project Transfer Function	29-1
Project Transfer Procedures	29-2
Properties Dialog Box	
Alarm List Display	10-138
Alarm Log Display	10-155
Arc	7-15
Bar Chart	11-3
Bit Button	8-4
Bit Write Command	12-4
Bit Write for Multi-Functions	8-116, 12-42
Calendar	10-207
Character Input	10-29
Circle/Ellipse	7-12
Data Log Display	10-173
Equilateral Polygons	7-20
Fill	7-23
Goto Screen Button	8-41
Goto Screen Command	12-20
Goto Screen for Multi-Functions	8-119, 12-45
Key Button	8-75
Key for Multi-Functions	8-123, 12-49
Keypad	8-144
Line	7-2
Line Chart	11-23
Message Display	10-99
Message Switching Display	10-119
Meter	11-66
Multi-Button	8-113
Multi-Command	12-40
Multi-State Lamp	9-19
Numerical Display	10-187
Numerical Input	10-3
Picture	7-25
Picture Display	10-60
Pie	7-17
Pie Chart	11-55
Pilot Lamp	9-3
Polygon	7-6
Polyline	7-4
Potentiometer	8-165
Print Button	8-58
Print Command	12-27
Print for Multi-Functions	8-121, 12-47
Rectangle	7-9
Script Command	12-34
Script for Multi-Functions	8-130, 12-56
Selector Switch	8-148
Text	7-27
Timer	12-62
Video Display	10-84
Word Button	8-23
Word Write Command	12-12
Word Write for Multi-Functions	8-117, 12-43
Protect	2-49
Protecting Data	23-3
Protecting Displays and Operations	23-8
Protecting the Display of Parts	23-29
Protecting the Display of Screens	23-25
Protecting the Operation of Parts	23-33
Protocol Manager	3-32
Protocol_Object_Types_Supported	3-147
Protocol_Services_Supported	3-147
Q	
Quick Access Toolbar	2-43
Quick Access Toolbar Tab	2-67
R	
Range Tab	11-70
Reader	23-6
Real Time	
Alarm Log Function	13-6
Alarm Log Settings	13-23
Data Log Settings	14-21
Data Structure and Output Example (Alarm Log Settings)	13-39

Data Structure and Output Example (Data Log Settings)	14-45	Save Project	2-66
Data Structure and Output Example (Operation Log Settings)	15-21	Save Tab	2-66
Operation Log Settings	15-17	Saving Data	
Receive (RXD) Command		Alarm Log Function	13-7
BCC (Block Check Code)	3-74	Data Log Function	14-6
Constant (Character)	3-62	Operation Log Function	15-6
Constant (Hexadecimal)	3-63	Saving drawing objects drawn on the editing screen	2-25
Device Address	3-64	Saving image files	2-21
Registering Constant (Character)	3-69	Saving pictures as image files	2-27
Registering Constant (Hexadecimal)	3-71	Saving pictures in Picture Manager	2-21
Skip	3-77	Saving Project Data	4-5
Receiving Character Time Out	3-32, 4-56	Saving registered script as a file	20-8
Receiving Time Out	3-44	Saving Registered Text in Unicode Text Format	19-6
Recipe Function	18-1	Saving registered user communication protocol as a file	3-30
Recipe Settings Dialog Box	18-8	Saving the Data as a CSV File	
Record Tab	22-14	Alarm Log Function	13-38
Recorded Events	15-3	Data Log Function	14-45
Recording Images and Sound	8-103	Operation Log Function	15-21
Recovered	13-3	Saving the Displayed Screen as an Image	26-6
Rectangle	7-8	SB1(USB-A)	4-45
Reference Screen	10-148, 10-166, 10-181	Scale Tab	
Registering Movie Files	22-3	Bar Chart	11-11
Registration Text Tab		Meter	11-71
Bit Button	8-10	Screen Effects	5-21, 5-27
Goto Screen Button	8-47	Screen List	2-69
Key Button	8-85	Screen Monitor	
Multi-Button	8-133	Monitor	25-6
Multi-State Lamp	9-23	Simulator	26-10
Pilot Lamp	9-7	Screen Number	5-30
Print Button	8-63	Screen Number Format	4-26
Word Button	8-30	Screen Size	5-1
Relational Operators	20-23, 20-38	Screen Type	5-14, 5-20, 5-26
Reliability	3-146	Screens	2-46, 2-53, 5-1
Relinquish_Default	3-145	Script	20-1
Remote control page	28-10	Script Coding Examples	20-32
Remote monitoring page	28-9	Script Command	12-32
Repeat	10-85, 20-22, 21-7	Script Debugger	26-15
Replacement Parts		Script Definition Method	20-21
HG1P	35-95	Script Editor	20-12
HG2J-7U	35-95	Script Error	20-4
HG4G/3G, HG2G-5F/-5T, HG1G	35-95	Script Function	20-1
HG5G/4G/3G/2G-V	35-95	Script ID	4-65
Reset	8-1, 8-4, 8-116, 12-1, 12-4, 12-42	Script Manager	20-7
Resources Tab	2-68	SD memory card	31-3
Restrictions when connecting the expansion modules	30-4	Search MICRO/I dialog box	24-9
Reusing Screens	5-11	Security Dialog Box	23-37
Ribbon	2-46	Security Function	23-1
Run Mode	1-4	Security Group	23-6, 23-9, 31-34
Runtime System	24-15	Security Settings Dialog Box	23-41
Runtime System of Expansion Modules Dialog Box	24-17	Security Tab	
RXD	3-37	Alarm List Display	10-150
S		Alarm Log Display	10-168
SAFETY PRECAUTIONS	P-1	Bar Chart	11-18
Sampling Method	14-14	Bar Meter	11-73
Save	4-5	Base Screen	5-17
Save As	4-6	Bit Button	8-16
		Calendar	10-218
		Character Input	10-44

- Data Log Display 10-182
 - Goto Screen Button 8-53
 - Key Button 8-91
 - Line Chart 11-50
 - Message Display 10-113
 - Message Switching Display 10-133
 - Multi-Button 8-139
 - Multi-State Lamp 9-31
 - Numerical Display 10-202
 - Numerical Input 10-22
 - Picture Display 10-73
 - Pie Chart 11-61
 - Pilot Lamp 9-13
 - Popup Screen 5-23
 - Potentiometer 8-172
 - Print Button 8-69
 - Selector Switch 8-160
 - Video Display 10-89
 - Word Button 8-36
 - Selecting pictures from Symbol Factory 2-23
 - Selector Switch 8-146
 - SERIAL1(RS232C) 4-40
 - SERIAL1(RS422/485) 4-40
 - Services 3-96
 - Set 8-1, 8-4, 8-20, 8-23, 8-116, 8-117,
12-1, 12-4, 12-10, 12-12, 12-42, 12-43
 - Set & Reset 8-116, 12-42
 - Set ON & OFF Data 8-117, 12-43
 - Set Preview Size Dialog Box 2-35
 - Setting Conditional Expressions 2-73
 - Setting Sub Host Communication for a communication
interface 3-89
 - Setting the External Memory Device Folder 31-12
 - Setting the Printer 32-2
 - Shape Style 2-53
 - Shapes 6-2, 7-1
 - Show below the Ribbon 2-44
 - Show script error 4-28
 - Show/Hide 2-52
 - Simulator 2-51, 26-7
 - Simulator Function 26-1
 - Size 2-54
 - Snap to Grid 2-59
 - Social Media Account Manager 28-73
 - Social Media Function 28-64, 28-67
 - Social Media Settings Dialog Box 28-70
 - Sound Files 2-37, 21-1
 - Sound Function 21-1
 - Sound Settings Dialog Box 21-6
 - Specifications
 - HG1P 35-70
 - HG2G-5T, HG1G 35-54
 - HG2J-7U 35-1
 - HG4G/3G, HG2G-5F 35-35
 - HG5G/4G/3G/2G-V 35-14
 - Specify from Picture dialog box 10-67
 - Stacked bar chart 11-55
 - Standard Keypad Popup Screen 5-25
 - Standard Password Input Screen 5-29
 - Start Code 3-78
 - Start Part with synchronous 4-29
 - Start Time 4-25
 - Starting the Simulator 26-3
 - Starting the Simulator by Loading or Clearing Device Addresses
..... 26-3
 - State Settings Dialog Box 9-27
 - State Tab 9-25
 - Status Bar 2-58, 2-60
 - Status Device Address 3-42
 - Status_Flags 3-145
 - Storage Method of 32-bit Numerical Data
 - External Device Addresses 4-48
 - Internal Devices 4-29
 - Storage Method of String Data 4-29
 - String Data Storage Method 10-55, 10-116
 - Sub 8-21, 8-24, 8-117, 12-10, 12-13, 12-43
 - Sub Host Communication 3-87
 - Sub Host Communication Tab 4-60
 - Subnet Mask
 - Default 24-6
 - Superimpose 5-21, 5-22, 5-27
 - Supported Languages 2-6
 - Supported Movie Files 22-2
 - Switching the Displayed Language by Value
 - of Device Address 19-9
 - Switching the Screen of the MICRO/I 25-19
 - Symbol Factory 2-32
 - Symbol Options 2-33
 - System Area 4-30
 - System Composition 1-1
 - System Detailed Information Page 28-7
 - System Information 24-29
 - System Language 4-28
 - System Mode 1-4, 34-3
 - File Copy Function 29-33
 - Formatting external memory device 31-15
 - PLC Program Transfer Function 29-21
 - Project Transfer Function 29-7
 - System Setup 2-49
 - System Tab 4-25
 - System Web Page 28-5
 - System_Status 3-147
- ## T
- Tag Editor 2-70
 - Tag File 4-53
 - Target Information Dialog Box 24-31
 - Target IP Address 24-8, 24-10
 - Target IP Address Settings dialog box 24-8
 - Target List 24-7
 - Temporary Variable 20-31
 - Terminal Code 3-78
 - Text 6-2, 7-26
 - Auto Resizing 2-62
 - Text Alignment A-7

Text Group	2-58, 19-1
Text Group Settings Dialog Box	19-14
Text Manager	19-11
Text Manager Color	A-4
Text Style	2-53
The Expansion Module Operation	30-6
Thresholds	17-3
Time Out (min)	24-6
Timer	12-60
Toggle	8-2, 8-5, 8-116, 12-2, 12-5, 12-42
Top Page	34-3, 34-4
Touch Panel Does Not Respond Correctly	36-5
Touch sound	21-3
Transfer	2-50
Transmission (TXD) Command	
BCC (Block Check Code)	3-59
Constant (Character)	3-49
Constant (Hexadecimal)	3-50
Device Address	3-51
Registering Constant (Character)	3-55
Registering Constant (Hexadecimal)	3-57
Transmission Wait	3-44
Trigger Condition	2-73
Trigger Condition Settings Dialog Box	2-73
Trigger Condition Tab	
Bar Chart	11-14
Bit Button	8-12
Bit Write Command	12-6
Calendar	10-215
Character Input	10-40
File Transfer Settings	28-37
Global Script	20-20
Goto Screen Button	8-49
Goto Screen Command	12-22
Key Button	8-87
Line Chart	11-47
Message Display	10-110
Message Switching Display	10-130
Multi-Button	8-135
Multi-Command	12-57
Multi-State Lamp	9-28
Numerical Display	10-198
Numerical Input	10-17
Picture Display	10-70
Pilot Lamp	9-9
Potentiometer	8-168
Print Button	8-65
Print Command	12-29
Script Command	12-35
Selector Switch	8-156
Timer	12-63
Word Button	8-32
Word Write Command	12-15
Troubleshooting	36-1
Twitter Account Dialog Box	
Edit	28-74
New	28-74
TXD	3-37
Type Number	2-58

U

Upload Dialog Box	24-23
Uploading	
Alarm Log Files	24-24, 31-6
Custom Web Page Files	24-23
Data Log Files	24-24, 31-6
Movie File List	24-24, 31-6
Movie Files	24-24, 31-6
Operation Log Files	24-24, 31-6
Picture Files	24-23, 24-24, 31-6
Project Data	24-21, 31-9
Recipe Files	24-23, 24-24, 31-6
Screenshots	24-24, 31-6
Sound Files	24-23, 24-24, 31-6
ZLD Project File	29-20, 29-25
ZNV Project File	29-6, 29-11
Uploading data	
External Memory Device	31-6
Uploading Project Data	
From External Memory Device	31-9
From MICRO/I	24-21
USB	24-6
USB Autorun Definition File	31-26
USB Autorun Function	4-64, 31-19
USB Autorun Function Security	31-34
USB flash drive	31-3
USB Interface	4-38
USB Popup Screen Function	31-35
USB(USB-B)	4-46
USB1(USB-B)	4-46
USB2(USB-A)	4-45
Use Compatible functions from previous version	2-63
Use Device Cache	4-29
Use HG1B Compatible functions	2-63
Use Large Font	4-27
Use System Area	4-28
User Account Setting Screen Configuration	23-60
User Accounts	23-1
User Communication	3-8
User Communication Tab	4-56
Using the online function for Ethernet communication ..	24-7
Using the Simulator	26-3

V

Verified FTP Client	28-17
Verified FTP Server	28-21
Verified SMTP Servers	28-39
Vertical Installation	5-31
Vertical Writing	A-8
Video Display	10-81
Video Input Tab	22-15
View	2-52
Screens	2-53
Show/Hide	2-52
Window	2-53
Workspace	2-52
Zoom	2-53

View Browser	A-3
View Tab	
Alarm List Display	10-142
Alarm Log Display	10-159
Bar Chart	11-7
Bit Button	8-8
Calendar	10-211
Character Input	10-34
Data Log Display	10-176
Goto Screen Button	8-45
Key Button	8-83
Line Chart	11-26
Message Display	10-101
Message Switching Display	10-123
Meter	11-68
Multi-Button	8-131
Multi-State Lamp	9-22
Numerical Display	10-190
Numerical Input	10-9
Picture Display	10-68
Pie Chart	11-58
Pilot Lamp	9-5
Potentiometer	8-166
Print Button	8-61
Selector Switch	8-153
Video Display	10-86
Word Button	8-28

W

Watch Dog	4-28
Web Page Configuration	28-5
Web Page Editor	28-12
Web Page Tab	23-42
Web Server Function	28-1
Web Server Function Configuration Procedure	28-4
Web Server Tab	4-66
When You Cannot Download Project Data	36-5
WindO/I-NV4	2-1
WindO/I-NV4 Options Dialog Box	2-61
Window	2-53, 2-55
Windows Font	2-13
Windows RGB Value Correspondence Table	A-2
Word Button	8-19
Word Functions	20-24, 20-45
Word Write Command	12-9
Work Environment	2-61
Workspace	2-52, 2-55, 2-62, 2-69

X

X-Axis Tab	11-28
XOR	8-21, 8-24, 12-10, 12-13, 12-43

Y

Y-Axis Tab	11-35
------------------	-------

Z

ZLD Project File	
Creating ZLD Project File	29-18
Download	29-19, 29-21
Upload	29-20, 29-25
ZNV Project File	
Creating ZNV Project File	29-3
Download	29-6, 29-7
Upload	29-6, 29-11
Zoom	2-53, 2-60, 2-69

IDEC CORPORATION

 www.idec.com

Head Office 6-64, Nishi-Miyahara-2-Chome, Yodogawa-ku, Osaka 532-0004, Japan

USA	IDEC Corporation	Singapore	IDEC Izumi Asia Pte. Ltd.	China	IDEC (Shanghai) Corporation	Japan	IDEC Corporation
EMEA	APEM SAS	Thailand	IDEC Asia (Thailand) Co., Ltd.		IDEC Izumi (H.K.) Co., Ltd.		
		India	IDEC Controls India Private Ltd.	Taiwan	IDEC Taiwan Corporation		

Specifications and other descriptions in this brochure are subject to change without notice.
Information in this brochure is current as of January, 2022.
2015 IDEC Corporation, All Rights Reserved.

B-1701(16)

